

# TECHNICAL DATA

LIST OF PROPERTY SYMBOLS COMPLYING WITH ISO13399 .....	R002
TROUBLE SHOOTING FOR TURNING .....	R006
CHIP CONTROL FOR TURNING .....	R008
EFFECTS OF CUTTING CONDITIONS FOR TURNING .....	R009
FUNCTION OF TOOL FEATURES FOR TURNING .....	R011
FORMULAE FOR CUTTING POWER .....	R015
TROUBLE SHOOTING FOR THREADING .....	R016
DRILL DIAMETERS FOR PREPARED HOLES .....	R017
THREADING METHODS .....	R018
TROUBLE SHOOTING FOR FACE MILLING .....	R021
FUNCTION OF TOOL FEATURES FOR FACE MILLING .....	R022
FORMULAE FOR FACE MILLING .....	R025
TROUBLE SHOOTING FOR END MILLING .....	R027
END MILL TERMINOLOGY .....	R028
TYPES AND SHAPES OF END MILL .....	R029
PITCH SELECTION OF PICK FEED .....	R030
TROUBLE SHOOTING FOR DRILLING .....	R031
DRILL TERMINOLOGY AND CUTTING CHARACTERISTICS .....	R032
DRILL WEAR AND CUTTING EDGE DAMAGE .....	R035
FORMULAE FOR DRILLING .....	R036
HEXAGON SOCKET HEAD BOLT HOLE SIZE .....	R037
INTERNATIONAL SYSTEM OF UNITS .....	R037
METALLIC MATERIALS CROSS REFERENCE LIST .....	R038
DIE STEELS .....	R042
SURFACE ROUGHNESS .....	R044
HARDNESS COMPARISON TABLE .....	R045
JIS FIT TOLERANCE HOLE .....	R046
JIS FIT TOLERANCE SHAFT .....	R048
TAPER STANDARD .....	R050
TOOL WEAR AND DAMAGE .....	R051
CUTTING TOOL MATERIALS .....	R052
GRADE CHAIN .....	R053
GRADES COMPARISON TABLE .....	R054
INSERT CHIP BREAKER COMPARISON TABLE .....	R060



# LIST OF PROPERTY SYMBOLS COMPLYING WITH ISO13399

Alphabetical

Source: ISO13399 standard

URL : <https://www.iso.org/search/x/query/13399>

ISO13399 Property Symbols	Content
<b>ADJLX</b>	Adjustment limit maximum
<b>ADJRG</b>	Adjustment range
<b>ALF</b>	Clearance angle radial
<b>ALP</b>	Clearance angle axial
<b>AN</b>	Clearance angle major
<b>ANN</b>	Clearance angle minor
<b>APMX</b>	Depth of cut maximum
<b>AS</b>	Clearance angle wiper edge
<b>ASP</b>	Adjusting screw protrusion
<b>AZ</b>	Plunge depth maximum
<b>B</b>	Shank width
<b>BBD</b>	Balanced by design
<b>BCH</b>	Corner chamfer length
<b>BD</b>	Body diameter
<b>BDX</b>	Body diameter maximum
<b>BHCC</b>	Bolt hole circle count
<b>BHTA</b>	Body half taper angle
<b>BMC</b>	Body material code
<b>BS</b>	Wiper edge length
<b>BSR</b>	Wiper edge radius
<b>CASC</b>	Cartridge size code
<b>CB</b>	Chip breaker face count
<b>CBDP</b>	Connection bore depth
<b>CBMD</b>	Chip breaker manufacturers designation
<b>CBP</b>	Chip breaker property
<b>CCMS</b>	Connection code machine side
<b>CCWS</b>	Connection code workpiece side
<b>CCP</b>	Chamfer corner property
<b>CDI</b>	Insert cutting diameter
<b>CDX</b>	Cutting depth maximum
<b>CEATC</b>	Tool cutting edge angle type code
<b>CECC</b>	Cutting edge condition code
<b>CEDC</b>	Cutting edge count
<b>CF</b>	Spot chamfer
<b>CHW</b>	Corner chamfer width
<b>CICT</b>	Cutting item count
<b>CNC</b>	Corner count
<b>CND</b>	Coolant entry diameter
<b>CNSC</b>	Coolant entry style code
<b>CNT</b>	Coolant entry thread size
<b>CP</b>	Coolant pressure
<b>CRE</b>	Spot radius
<b>CRKS</b>	Connection retention knob thread size
<b>CSP</b>	Coolant supply property
<b>CTP</b>	Coating property
<b>CTX</b>	Cutting point translation X-direction
<b>CTY</b>	Cutting point translation Y-direction
<b>CUTDIA</b>	Work piece parting diameter maximum
<b>CUB</b>	Connection unit basis
<b>CW</b>	Cutting width
<b>CWX</b>	Cutting width maximum
<b>CXD</b>	Coolant exit diameter

ISO13399 Property Symbols	Content
<b>CXSC</b>	Coolant exit style code
<b>CZC</b>	Connection size code
<b>D1</b>	Fixing hole diameter
<b>DAH</b>	Diameter access hole
<b>DAXN</b>	Axial groove outside diameter minimum
<b>DAXX</b>	Axial groove outside diameter maximum
<b>DBC</b>	Diameter bolt circle
<b>DC</b>	Cutting diameter
<b>DCB</b>	Connection bore diameter
<b>DCBN</b>	Connection bore diameter minimum
<b>DCBX</b>	Connection bore diameter maximum
<b>DCC</b>	Design configuration style code
<b>DCCB</b>	Counterbore diameter connection bore
<b>DCIN</b>	Cutting diameter internal
<b>DCINN</b>	Cutting diameter internal minimum
<b>DCINX</b>	Cutting diameter internal maximum
<b>DCN</b>	Cutting diameter minimum
<b>DCON</b>	Connection diameter
<b>DCONMS</b>	Connection diameter machine side
<b>DCONWS</b>	Connection diameter workpiece side
<b>DCSC</b>	Cutting diameter size code
<b>DCSFMS</b>	Contact surface diameter machine side
<b>DCX</b>	Cutting diameter maximum
<b>DF</b>	Flange diameter
<b>DHUB</b>	Hub diameter
<b>DMIN</b>	Minimum bore diameter
<b>DMM</b>	Shank diameter
<b>DN</b>	Neck diameter
<b>DRVA</b>	Drive angle
<b>EPSR</b>	Insert included angle
<b>FHA</b>	Flute helix angle
<b>FHCSA</b>	Fixing hole countersunk angle
<b>FHCSD</b>	Fixing hole countersunk diameter
<b>FLGT</b>	Flange thickness
<b>FMT</b>	Form type
<b>FXHLP</b>	Fixing hole property
<b>GAMF</b>	Rake angle radial
<b>GAMN</b>	Rake angle normal
<b>GAMO</b>	Rake angle orthogonal
<b>GAMP</b>	Rake angle axial
<b>GAN</b>	Insert rake angle
<b>H</b>	Shank height
<b>HA</b>	Thread height theoretical
<b>HAND</b>	Hand
<b>HBH</b>	Head bottom offset height
<b>HBKL</b>	Head back offset length
<b>HBKW</b>	Head back offset width
<b>HBL</b>	Head bottom offset length
<b>HC</b>	Thread height actual
<b>HF</b>	Functional height
<b>HHUB</b>	Hub height
<b>HTB</b>	Body height
<b>IC</b>	Inscribed circle diameter
<b>IFS</b>	Insert mounting style code
<b>IIC</b>	Insert interface code
<b>INSL</b>	Insert length
<b>KAPR</b>	Tool cutting edge angle
<b>KCH</b>	Corner chamfer angle

# LIST OF PROPERTY SYMBOLS COMPLYING WITH ISO13399

ISO13399 Property Symbols	Content
<b>KRINS</b>	Cutting edge angle major
<b>KWL</b>	Keyway length
<b>KWW</b>	Keyway width
<b>KYP</b>	Keyway property
<b>L</b>	Cutting edge length
<b>LAMS</b>	Inclination angle
<b>LB</b>	Body length
<b>LBB</b>	Chip breaker width
<b>LBX</b>	Body length maximum
<b>LCCB</b>	Counterbore depth connection bore
<b>LCF</b>	Length chip flute
<b>LDRED</b>	Reduced body diameter length
<b>LE</b>	Cutting edge effective length
<b>LF</b>	Functional length
<b>LFA</b>	A dimension on lf
<b>LH</b>	Head length
<b>LPR</b>	Protruding length
<b>LS</b>	Shank length
<b>LSC</b>	Clamping length
<b>LSCN</b>	Clamping length minimum
<b>LSCX</b>	Clamping length maximum
<b>LTA</b>	LTA length (length from MCS to CRP)
<b>LU</b>	Usable length
<b>LUX</b>	Usable length maximum
<b>M</b>	M-dimension
<b>M2</b>	Distance between the nominal inscribed circle and the corner of an insert that has the secondary included angle
<b>MHA</b>	Mounting hole angle
<b>MHD</b>	Mounting hole distance
<b>MHH</b>	Mounting hole height
<b>MIID</b>	Master insert identification
<b>MTP</b>	Clamping type code
<b>NCE</b>	Cutting end count
<b>NOF</b>	Flute count
<b>NOI</b>	Insert index count
<b>NT</b>	Tooth count
<b>OAH</b>	Overall height
<b>OAL</b>	Overall length
<b>OAW</b>	Overall width
<b>PDPT</b>	Profile depth insert
<b>PDX</b>	Profile distance ex
<b>PDY</b>	Profile distance ey
<b>PFS</b>	Profile style code
<b>PL</b>	Point length
<b>PNA</b>	Profile included angle
<b>PSIR</b>	Tool lead angle
<b>PSIRL</b>	Cutting edge angle major left hand
<b>PSIRR</b>	Cutting edge angle major right hand
<b>RAL</b>	Relief angle left hand
<b>RAR</b>	Relief angle right hand
<b>RCP</b>	Rounded corner property
<b>RE</b>	Corner radius
<b>REL</b>	Corner radius left hand
<b>RER</b>	Corner radius right hand
<b>RMPX</b>	Ramping angle maximum
<b>RPMX</b>	Rotational speed maximum
<b>S</b>	Insert thickness
<b>S1</b>	Insert thickness total

ISO13399 Property Symbols	Content
<b>SC</b>	Insert shape code
<b>SDL</b>	Step diameter length
<b>SIG</b>	Point angle
<b>SSC</b>	Insert seat size code
<b>SX</b>	Shank cross section shape code
<b>TC</b>	Tolerance class insert
<b>TCE</b>	Tipped cutting edge code
<b>TCTR</b>	Thread tolerance class
<b>TD</b>	Thread diameter
<b>THFT</b>	Thread form type
<b>THL</b>	Threading length
<b>THLGTH</b>	Thread length
<b>THSC</b>	Tool holder shape code
<b>THUB</b>	Hub thickness
<b>TP</b>	Thread pitch
<b>TPI</b>	Threads per inch
<b>TPIN</b>	Threads per inch minimum
<b>TPIX</b>	Threads per inch maximum
<b>TPN</b>	Thread pitch minimum
<b>TPT</b>	Thread profile type
<b>TPX</b>	Thread pitch maximum
<b>TQ</b>	Torque
<b>TSYC</b>	Tool style code
<b>TTP</b>	Thread type
<b>ULDR</b>	Usable length diameter ratio
<b>UST</b>	Unit system
<b>W1</b>	Insert width
<b>WEP</b>	Wiper edge property
<b>WF</b>	Functional width
<b>WF2</b>	Distance between the cutting reference point and the front seating surface of a turning tool
<b>WFS</b>	Functional width secondary
<b>WT</b>	Weight of item
<b>ZEFF</b>	Face effective cutting edge count
<b>ZEFP</b>	Peripheral effective cutting edge count
<b>ZNC</b>	Cutting edge center count
<b>ZNF</b>	Face mounted insert count
<b>ZNP</b>	Peripheral mounted insert count

## LIST OF REFERENCE SYMBOLS COMPLYING WITH ISO13399

ISO13399 Reference Symbols	Content
<b>CIP</b>	Coordinate system in process
<b>CRP</b>	Cutting reference point
<b>CSW</b>	Coordinate system workpiece side
<b>MCS</b>	Mounting coordinate system
<b>PCS</b>	Primary coordinate system

# TROUBLE SHOOTING FOR TURNING

Trouble		Solution	Insert Grade Selection				Cutting Conditions				Style and Design of the Tool					Machine, Installation of Tool				
			Select a harder grade	Select a tougher grade	Select a grade with better thermal shock resistance	Select a grade with better adhesion resistance	Cutting speed	Feed	Depth of cut	Coolant		Rake	Corner radius	Lead angle	Honing strengthens the cutting edge	Class of insert	Improve tool holder rigidity	Increase clamping rigidity of the tool and workpiece	Decrease holder overhang	Decrease power and machine backlash
										Do not use water-soluble cutting fluid	Determine dry or wet cutting									
Factors						Up ↗	Down ↘			Up ↗		Down ↘								
Deterioration of Tool Life	Insert wear quickly generated	Improper tool grade	●																	
		Improper cutting edge geometry									●	● ↗	● ↗	● ↗	● ↘					
		Improper cutting speed					● ↘	● ↗			● Wet									
	Chipping or fracturing of cutting edge	Improper tool grade		●																
		Improper cutting conditions						● ↘	● ↘											
		Lack of cutting edge strength.									●		● ↗		● ↗					
Thermal crack occurs				●		● ↘	● ↘	● ↘	●	● Dry										
Build-up edge occurs				●	● ↗	● ↗		●	● Wet											
Lack of rigidity														●	●	●	●			
Out of Tolerance	Dimensions are not constant	Poor insert accuracy													●					
		Large cutting resistance and cutting edge flank									●	●	● ↘	● ↘	● ↘	●	●	●	●	
	Necessary to adjust often because of over-size	Improper tool grade	●																	
		Improper cutting conditions					● ↘	● ↗												
Deterioration of Surface Finish	Poor finished surface	Welding occurs				● ↗			●	● Wet										
		Improper cutting edge geometry									●		● ↗							
		Chattering					● ↘	● ↘	● ↘						●	●	●	●		
Generation of Heat	Workpiece over heating can cause poor accuracy and short life of insert	Improper cutting conditions				● ↘	● ↘	● ↘												
		Improper cutting edge geometry									●	● ↗		● ↘						

Trouble		Solution	Insert Grade Selection				Cutting Conditions				Style and Design of the Tool					Machine, Installation of Tool							
			Factors	Select a harder grade	Select a tougher grade	Select a grade with better thermal shock resistance	Select a grade with better adhesion resistance	Cutting speed	Feed	Depth of cut	Coolant		Select chip breaker	Rake	Corner radius	Lead angle	Honing strengthens the cutting edge	Class of insert	Improve tool holder rigidity	Increase clamping rigidity of the tool and workpiece	Decrease holder overhang	Decrease power and machine backlash	
					Up ↗	Down ↘		Do not use water-soluble cutting fluid	Determine dry or wet cutting	Down ↘	Up ↗												
Burrs, Chipping etc.	Burrs (Steel, Aluminium)	Notch wear	●																				
		Improper cutting conditions					●	●			●												
		Improper cutting edge geometry										●	●	●	●	●							
	Workpiece chipping (Cast iron)	Improper cutting conditions						●	●														
		Improper cutting edge geometry										●	●	●	●	●							
		Vibration occurs																●	●	●	●		
	Burrs (Mild steel)	Improper tool grade			●																		
		Improper cutting conditions					●			●	●												
		Improper cutting edge geometry										●	●			●							
Vibration occurs																	●	●	●	●			
Poor Chip Dispersal	Long chips	Improper cutting conditions					●	●	●		●												
		Large chip control range										●											
		Improper cutting edge geometry											●	●									
	Chips are short and scattered	Improper cutting conditions						●	●		●												
		Small chip control range										●											
		Improper cutting edge geometry											●	●									

# CHIP CONTROL FOR TURNING

## CHIP BREAKING CONDITIONS IN STEEL TURNING

Type	A Type	B Type	C Type	D Type	E Type
Small Depth of Cut $d < 7\text{mm}$					
Small Depth of Cut $d = 7 - 15\text{mm}$					
Curl Length $l$	Curless	$l \geq 50\text{mm}$	$l \leq 50\text{mm}$ 1-5 Curl	$\cong 1$ Curl	Less Than 1 Curl Half a Curl
Note	<ul style="list-style-type: none"> <li>● Irregular continuous shape</li> <li>● Tangle around tool and workpiece</li> </ul>	<ul style="list-style-type: none"> <li>● Regular continuous shape</li> <li>● Long chips</li> </ul>	Good	Good	<ul style="list-style-type: none"> <li>● Chip scattering</li> <li>● Chattering</li> <li>● Poor finished surface</li> <li>● Maximum</li> </ul>

### ● Cutting speed and chip control range of chip breaker

In general, when cutting speed increases, the chip control range tends to become narrower.

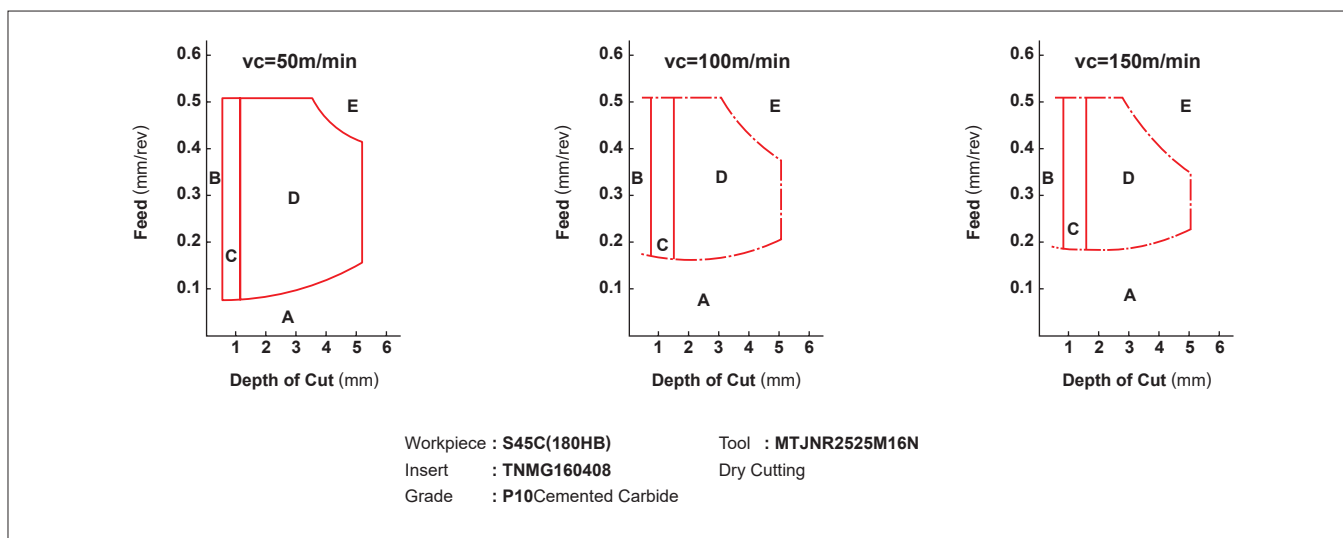

### ● Effects of coolant on the chip control range of a chip breaker

If the cutting speed is the same, the range of chip control differs according to whether coolant is used or not.

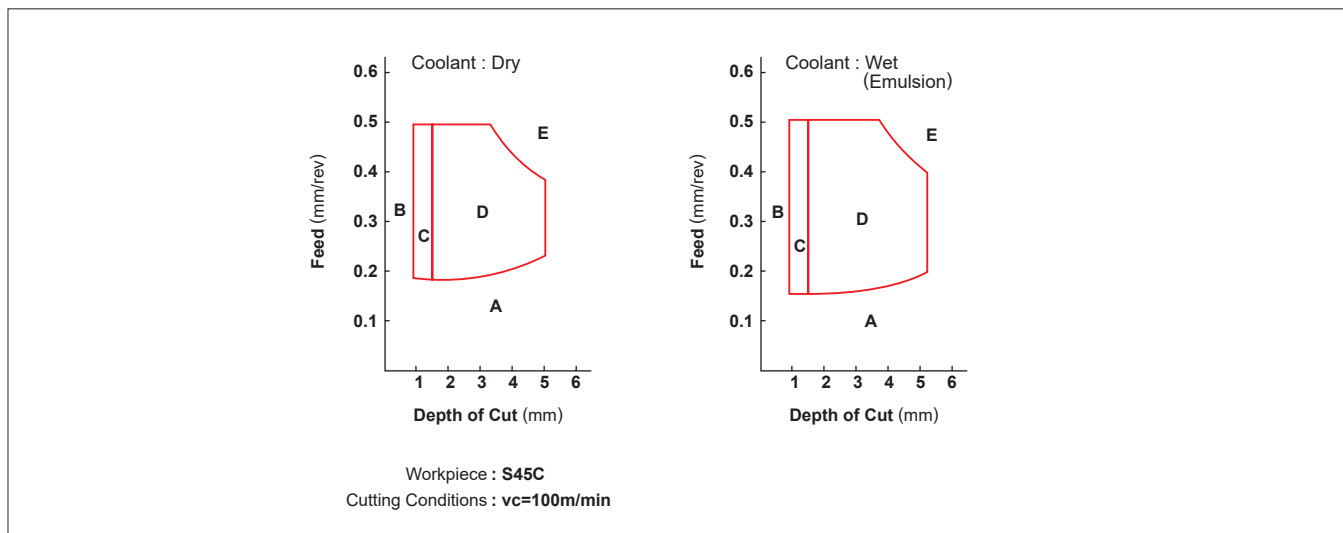



# EFFECTS OF CUTTING CONDITIONS FOR TURNING

## ■ EFFECTS OF CUTTING CONDITIONS

Ideal conditions for cutting are short cutting time, long tool life, and high cutting accuracy. In order to obtain these conditions, selection of efficient cutting conditions and tools, based on work material, hardness, shape and machine capability is necessary.

## ■ CUTTING SPEED

Cutting speed effects tool life greatly. Increasing cutting speed increases cutting temperature and results in shortening tool life. Cutting speed varies depending on the type and hardness of the work material. Selecting a tool grade suitable for the cutting speed is necessary.

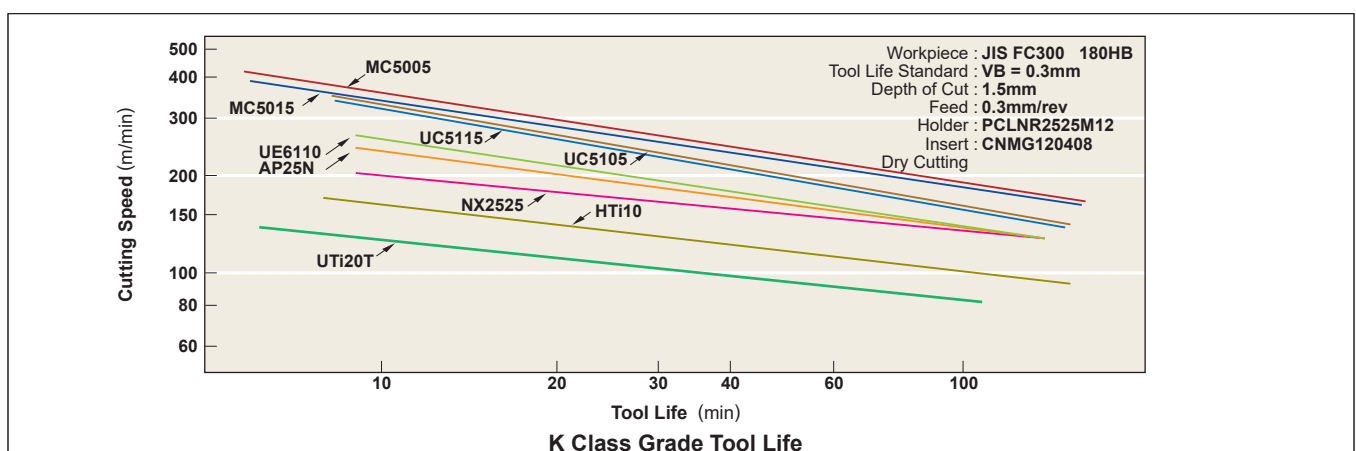
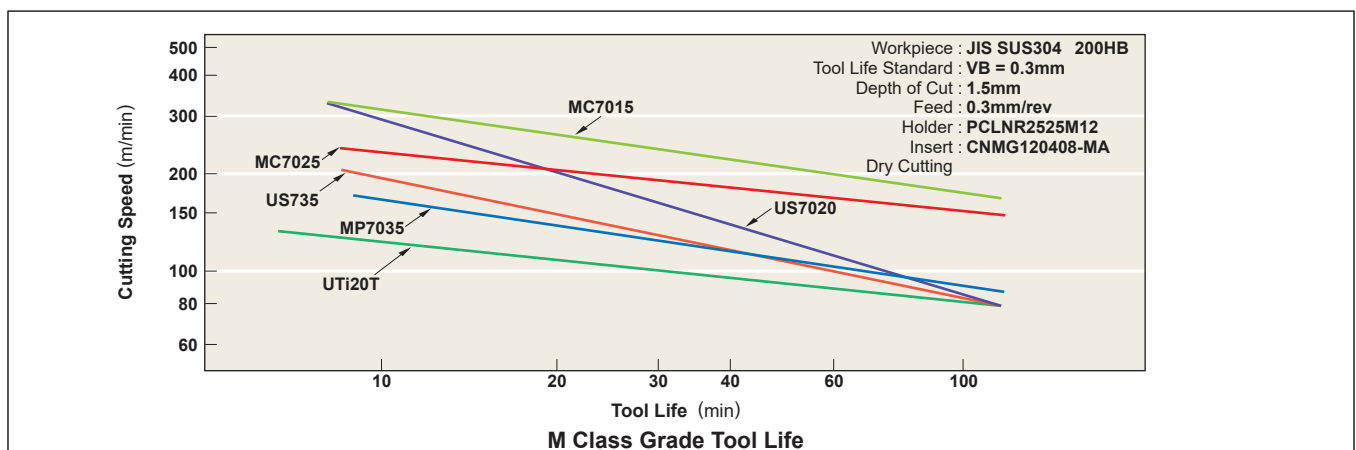
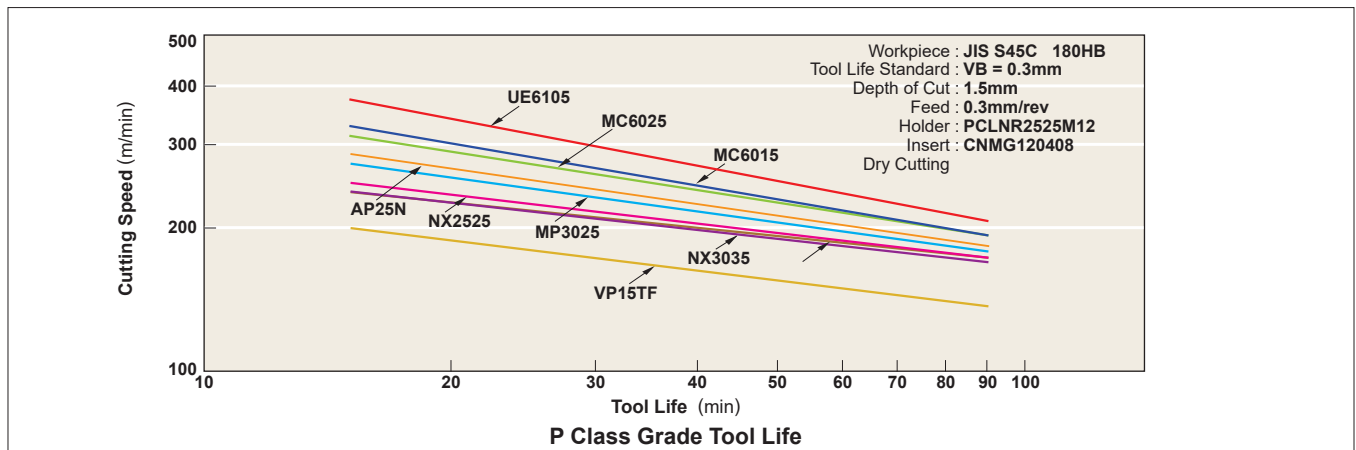

## ● Effects of Cutting Speed

1. Increasing cutting speed by 20% decreases tool life by 50%. Increasing cutting speed by 50% decreases tool life by 80%.
2. Cutting at low cutting speed (20–40m/min) tends to cause chattering. Thus, tool life is shortened.

# EFFECTS OF CUTTING CONDITIONS FOR TURNING

## ■ FEED

When cutting with a general type holder, feed is the distance a holder moves per workpiece revolution. When milling, feed is the distance a machine table moves per cutter revolution divided by the number of inserts. Thus, it is indicated as feed per tooth. Feed rate relates to finished surface roughness.

### ● Effects of Feed

1. Decreasing feed rate results in flank wear and shortens tool life.
2. Increasing feed rate increases cutting temperature and flank wear. However, effects on the tool life is minimal compared to cutting speed.
3. Increasing feed rate improves machining efficiency.

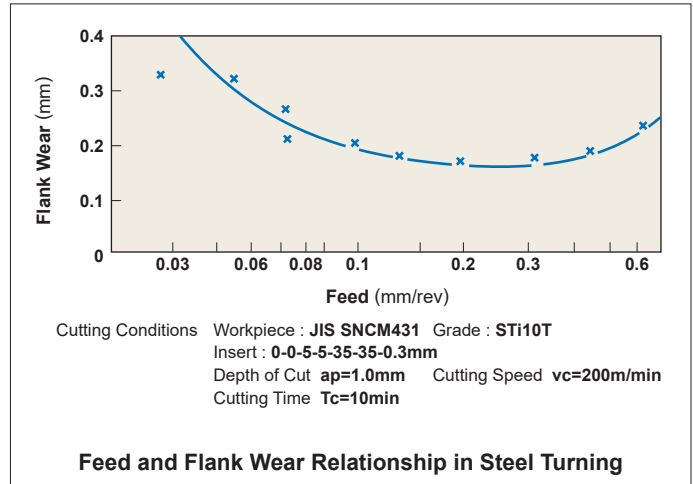

## ■ DEPTH OF CUT

Depth of cut is determined according to the required stock removal, shape of workpiece, power and rigidity of the machine and tool rigidity.

### ● Effects of Depth of Cut

1. Changing depth of cut doesn't effect tool life greatly.
2. Small depths of cut result in friction when cutting the hardened layer of a workpiece. Thus tool life is shortened.
3. When cutting uncut surfaces or cast iron surfaces, the depth of cut needs to be increased as much as the machine power allows in order to avoid cutting impure hard layers with the tip of cutting edge to prevent chipping and abnormal wear.

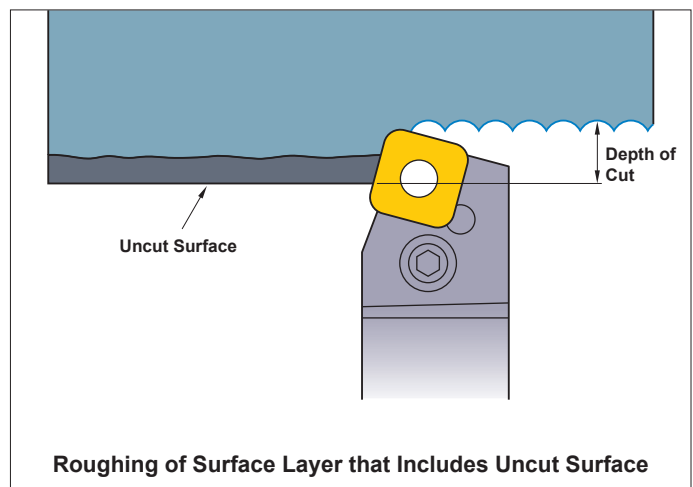
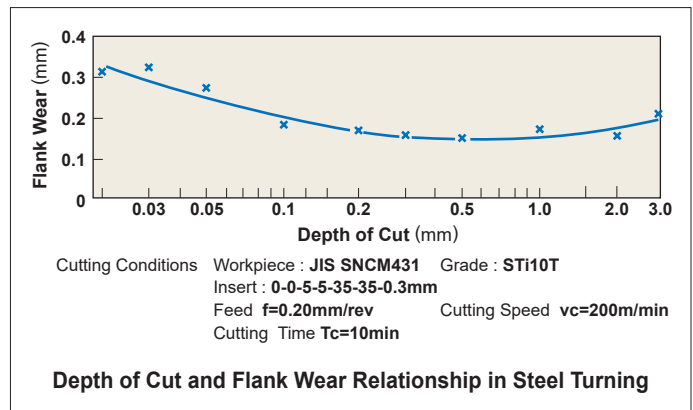

# FUNCTION OF TOOL FEATURES FOR TURNING

## RAKE ANGLE

Rake angle is cutting edge angle that has a large effect on cutting resistance, chip disposal, cutting temperature and tool life.

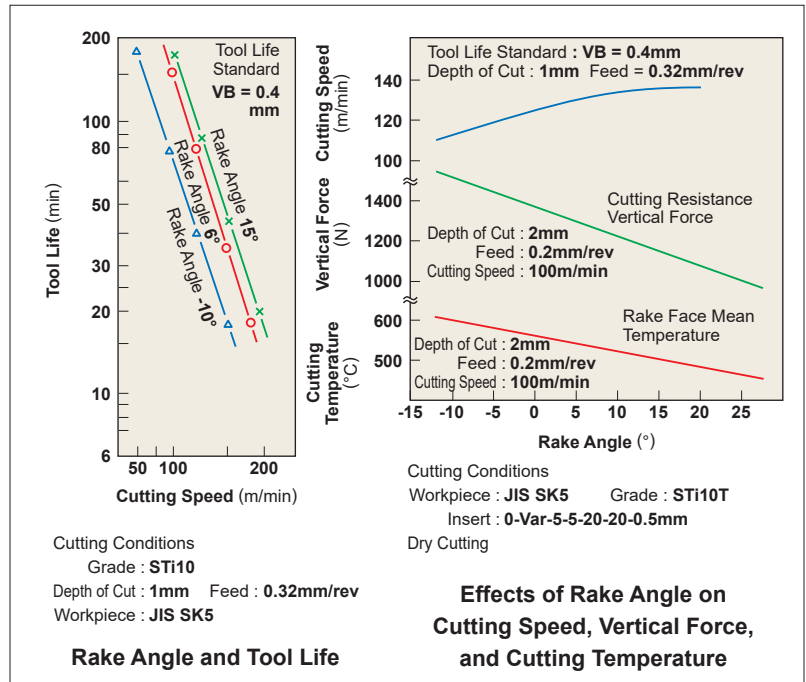
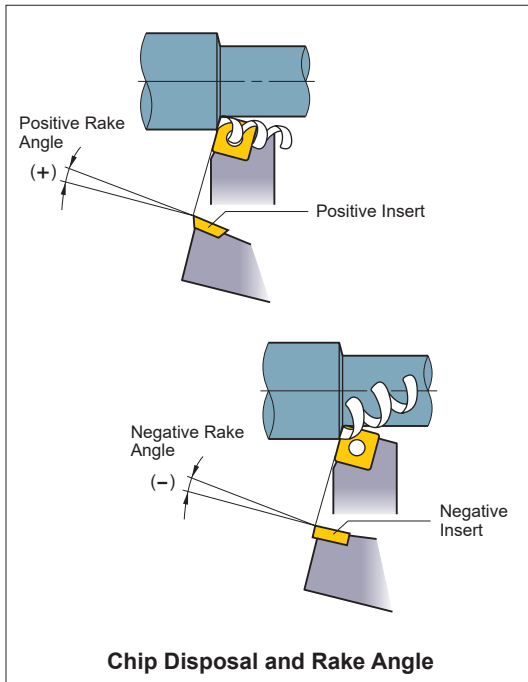

### Effects of Rake Angle

1. Increasing rake angle in the positive (+) direction improves sharpness.
2. Increasing rake angle by 1° in the positive (+) direction decreases cutting power by about 1%.
3. Increasing rake angle in the positive (+) direction lowers cutting edge strength and in the negative (-) direction increases cutting resistance.

### When to Increase Rake Angle in the Negative (-) Direction

- Hard workpieces.
- When the cutting edge strength is required such as for uncut surfaces and interrupted cutting.

### When to Increase Rake Angle in the Positive (+) Direction

- Soft workpieces.
- Workpiece is easily machined.
- When the workpiece or the machine have poor rigidity.

## FLANK ANGLE

Flank angle prevents friction between flank face and workpiece resulting in smooth feed.

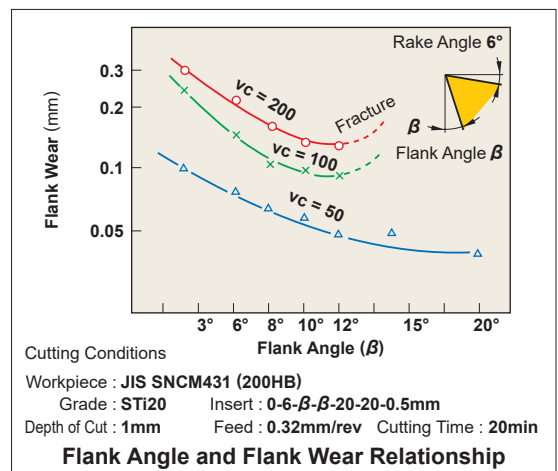
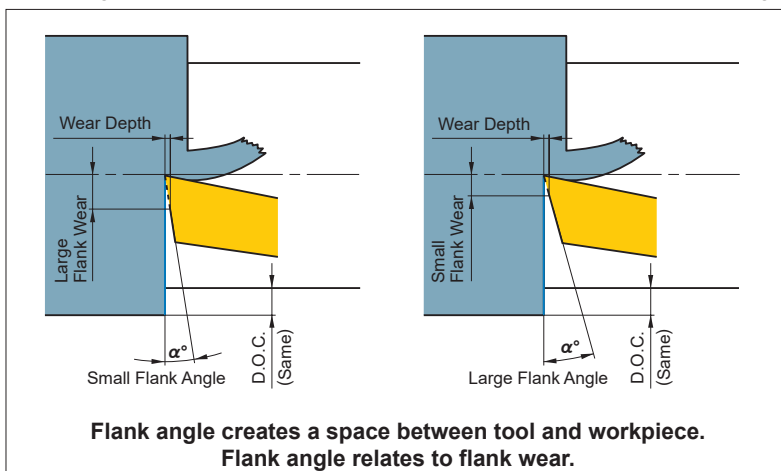

### Effects of Rake Angle

1. Increasing flank angle decreases flank wear occurrence.
2. Increasing flank angle lowers cutting edge strength.

### When to Decrease Flank Angle

- Hard workpieces.
- When cutting edge strength is required.

### When to Increase Flank Angle

- Soft workpieces.
- Workpieces suffer from work hardening easily.

# FUNCTION OF TOOL FEATURES FOR TURNING

## ■ SIDE CUTTING EDGE ANGLE (LEAD ANGLE)

The side cutting edge angle reduces impact load and effects the amount of feed force, back force and chip thickness.

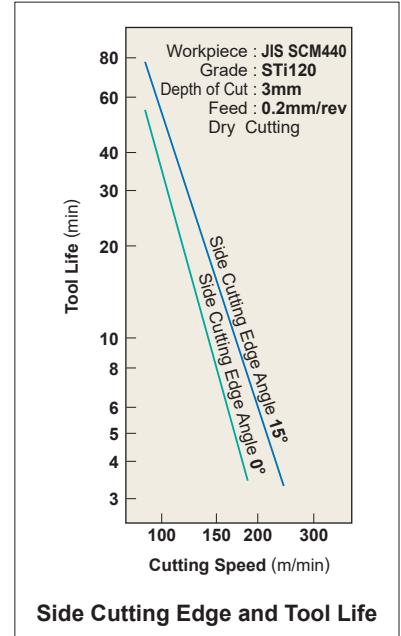
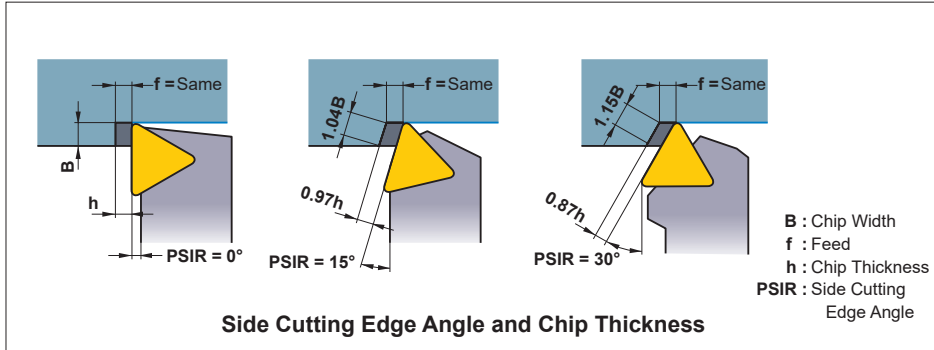

### ● Effects of Side Cutting Edge Angle (Lead Angle)

1. At the same feed rate, increasing the side cutting edge angle increases the chip contact length and decreases chip thickness. As a result, the cutting force is dispersed on a longer cutting edge and tool life is prolonged. (Refer to the chart.)
2. Increasing the side cutting edge angle increases force  $a'$ . Thus, thin, long workpieces suffer from bending in some cases.
3. Increasing the side cutting edge angle decreases chip control.
4. Increasing the side cutting edge angle decreases the chip thickness and increases chip width. Thus, breaking chips is difficult.

**When to Decrease Lead Angle**

- Finishing with small depth of cut.
- Thin, long workpieces.
- When the machine has poor rigidity.

**When to Increase Lead Angle**

- Hard workpieces which produce high cutting temperature.
- When roughing a workpiece with large diameter.
- When the machine has high rigidity.

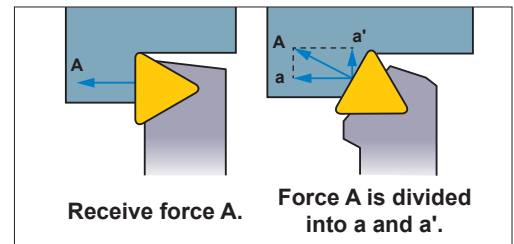

## ■ END CUTTING EDGE ANGLE

The end cutting edge angle avoids interference between the machined surface and the tool (end cutting edge). Usually  $5^{\circ}$ – $15^{\circ}$ .

### ● Effects of End Cutting Edge Angle

1. Decreasing the end cutting edge angle increases cutting edge strength, but it also increases cutting edge temperature.
2. Decreasing the end cutting edge angle increases the back force and can result in chattering and vibration while machining.
3. Small end cutting edge angle for roughing and large angle for finishing are recommended.

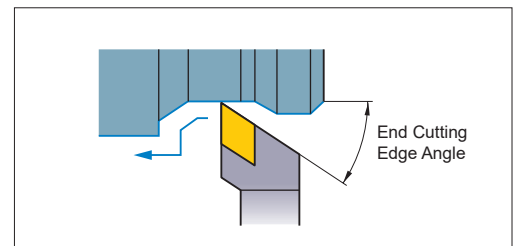

## ■ CUTTING EDGE INCLINATION

Cutting edge inclination indicates inclination of the rake face. During heavy cutting, the cutting edge receives an extremely large shock at the beginning of each cut. Cutting edge inclination keeps the cutting edge from receiving this shock and prevents fracturing.  $3^{\circ}$ – $5^{\circ}$  in turning and  $10^{\circ}$ – $15^{\circ}$  in milling are recommended.

### ● Effects of Cutting Edge Inclination

1. Negative (–) cutting edge inclination disposes chips in the workpiece direction, and positive (+) disposes chips in the opposite direction.
2. Negative (–) cutting edge inclination increases cutting edge strength, but it also increases the back force of cutting resistance. Thus, chattering can easily occur.

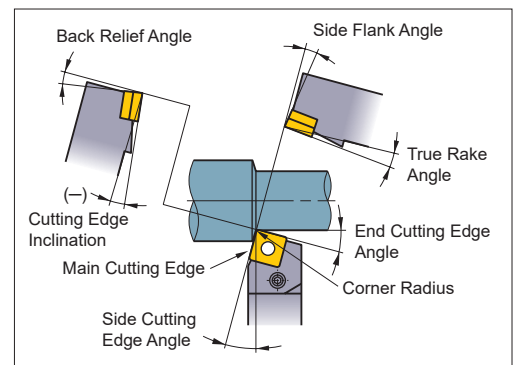

## ■ HONING AND LAND

Honing and land are cutting edge shapes that maintain cutting edge strength. Honing can be round or chamfer type. The optimal honing width is approximately 1/2 of the feed. Land is the narrow flat area on the rake or flank face.

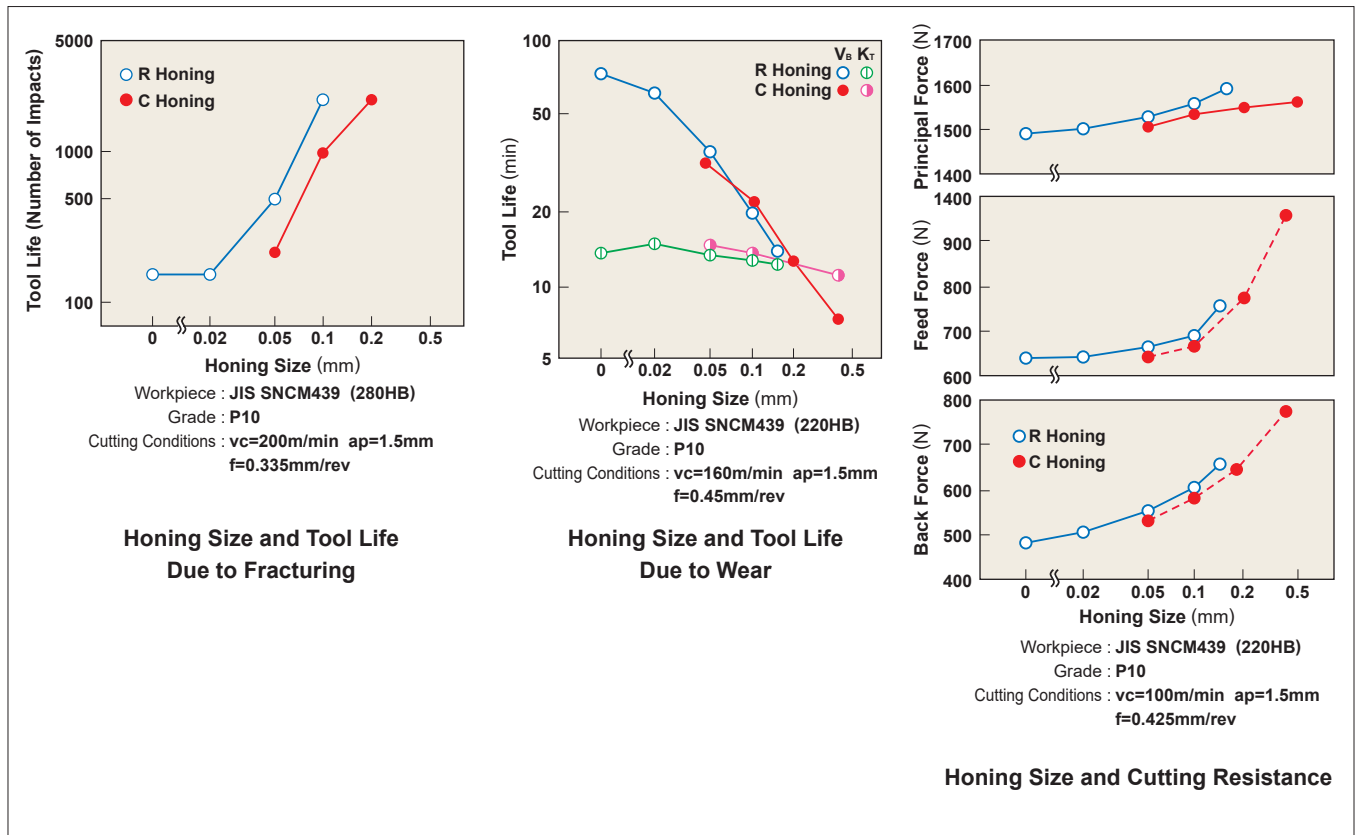
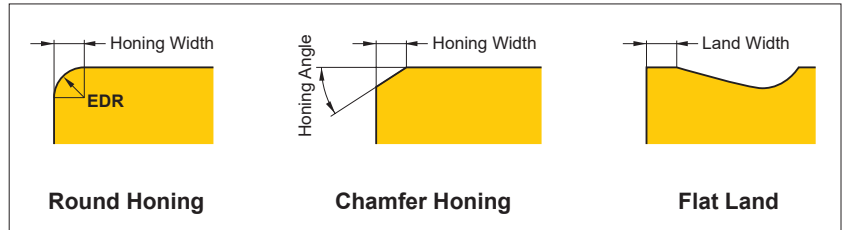

## ● Effects of Honing

1. Enlarging the honing increases cutting edge strength, tool life and reduces fracturing.
2. Enlarging the honing increases flank wear occurrence and shortens tool life. Honing size doesn't affect rake wear.
3. Enlarging the honing increases cutting resistance and chattering.

### When to Decrease Honing Size

- When finishing with small depth of cut and small feed.
- Soft workpieces.
- When the workpiece or the machine have poor rigidity.

### When to Increase Honing Size

- Hard workpieces.
- When the cutting edge strength is required such as for uncut surfaces and interrupted cutting.
- When the machine has high rigidity.

Note 1) Cemented carbide, coated diamond, and indexable cermet inserts have round honing as standard.

# FUNCTION OF TOOL FEATURES FOR TURNING

## ■ RADIUS

Radius effects the cutting edge strength and finished surface. In general, a corner radius 2–3 times the feed is recommended.

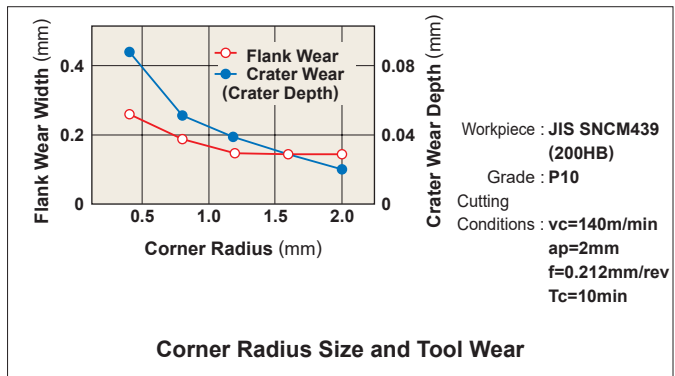
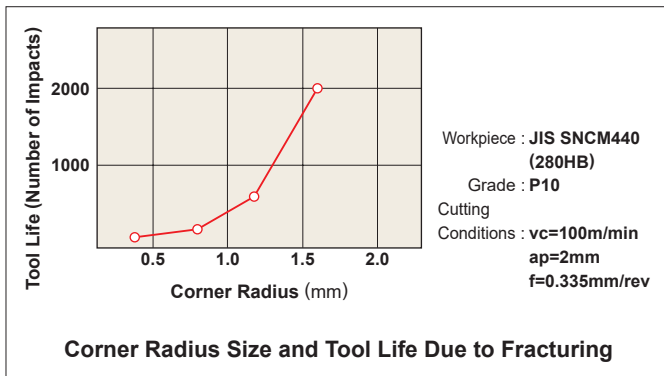
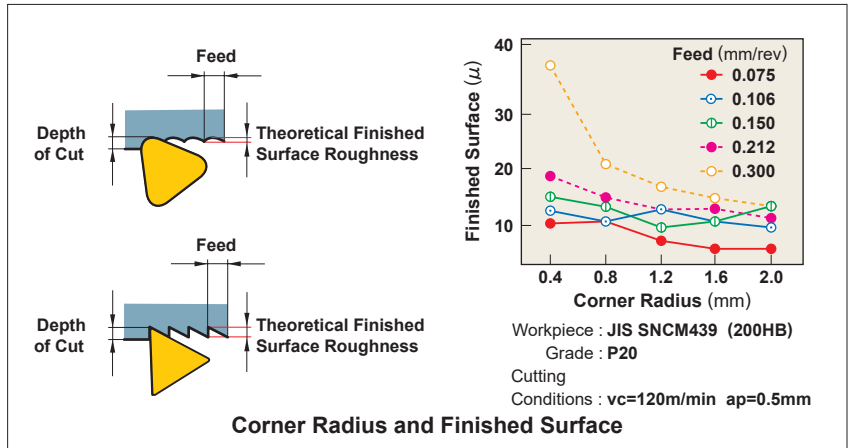

## ● Effects of Corner Radius

1. Increasing the corner radius improves the surface finish.
2. Increasing the corner radius improves cutting edge strength.
3. Increasing the corner radius too much increases the cutting resistance and causes chattering.
4. Increasing the corner radius decreases flank and rake wear.
5. Increasing the corner radius too much results in poor chip control.

### When to Decrease Corner Radius

- Finishing with small depth of cut.
- Thin, long workpieces.
- When the machine has poor rigidity.

### When to Increase Corner Radius

- When the cutting edge strength is required such as in interrupted cutting and uncut surface cutting.
- When roughing a workpiece with large diameter.
- When the machine has high rigidity.

## ● Corner Radius and Chip Control Range

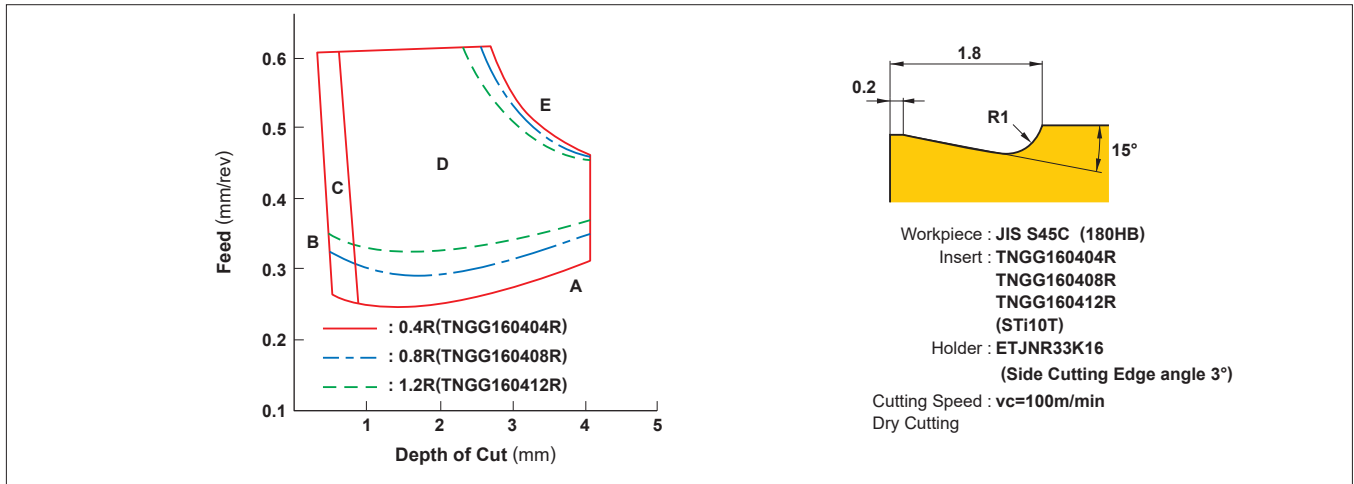

# FORMULAE FOR CUTTING POWER

## ■ CUTTING POWER ( $P_c$ )

$$P_c = \frac{ap \cdot f \cdot vc \cdot Kc}{60 \times 10^3 \times \eta} \text{ (kW)}$$

$P_c$  (kW) : Actual Cutting Power  
 $f$  (mm/rev) : Feed per Revolution  
 $Kc$  (MPa) : Specific Cutting Force

$ap$  (mm) : Depth of Cut  
 $vc$  (m/min) : Cutting Speed  
 $\eta$  : (Machine Coefficient)

(Problem) What is the cutting power required for machining mild steel at cutting speed 120m/min with depth of cut 3mm and feed 0.2mm/rev (Machine coefficient 80%) ?

(Answer) Substitute the specific cutting force  $Kc=3100\text{MPa}$  into the formula.

$$P_c = \frac{3 \times 0.2 \times 120 \times 3100}{60 \times 10^3 \times 0.8} = 4.65 \text{ (kW)}$$

### ● $Kc$

Work Material	Tensile Strength(MPa) and Hardness	Specific Cutting Force $Kc$ (MPa)				
		0.1 (mm/rev)	0.2 (mm/rev)	0.3 (mm/rev)	0.4 (mm/rev)	0.6 (mm/rev)
Mild Steel	520	3610	3100	2720	2500	2280
Medium Steel	620	3080	2700	2570	2450	2300
Hard Steel	720	4050	3600	3250	2950	2640
Tool Steel	670	3040	2800	2630	2500	2400
Tool Steel	770	3150	2850	2620	2450	2340
Chrome Manganese Steel	770	3830	3250	2900	2650	2400
Chrome Manganese Steel	630	4510	3900	3240	2900	2630
Chrome Molybdenum Steel	730	4500	3900	3400	3150	2850
Chrome Molybdenum Steel	600	3610	3200	2880	2700	2500
Nickel Chrome Molybdenum Steel	900	3070	2650	2350	2200	1980
Nickel Chrome Molybdenum Steel	352HB	3310	2900	2580	2400	2200
Hard Cast Iron	46HRC	3190	2800	2600	2450	2270
Meehanite Cast Iron	360	2300	1930	1730	1600	1450
Grey Cast Iron	200HB	2110	1800	1600	1400	1330

## ■ CUTTING SPEED ( $vc$ )

$$vc = \frac{\pi \cdot Dm \cdot n}{1000} \text{ (m/min)}$$

$vc$  (m/min) : Cutting Speed  
 $Dm$  (mm) : Workpiece Diameter  
 $\pi$  (3.14) : Pi  
 $n$  ( $\text{min}^{-1}$ ) : Main Axis Spindle Speed

\*Divide by 1000 to change to m from mm.

(Problem) What is the cutting speed when main axis spindle speed is  $700\text{min}^{-1}$  and external diameter is  $\phi 50$  ?

(Answer) Substitute  $\pi=3.14$ ,  $Dm=50$ ,  $n=700$  into the formula.

$$vc = \frac{\pi \cdot Dm \cdot n}{1000} = \frac{3.14 \times 50 \times 700}{1000} = 110 \text{ m/min}$$

Cutting speed is 110m/min.

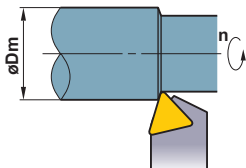

## ■ FEED ( $f$ )

$$f = \frac{l}{n} \text{ (mm/rev)}$$

$f$  (mm/rev) : Feed per Revolution  
 $l$  (mm/min) : Cutting Length per Min.  
 $n$  ( $\text{min}^{-1}$ ) : Main Axis Spindle Speed

(Problem) What is the feed per revolution when main axis spindle speed is  $500\text{min}^{-1}$  and cutting length per minute is  $120\text{mm/min}$  ?

(Answer) Substitute  $n=500$ ,  $l=120$  into the formula.

$$f = \frac{l}{n} = \frac{120}{500} = 0.24 \text{ mm/rev}$$

The answer is 0.24mm/rev.

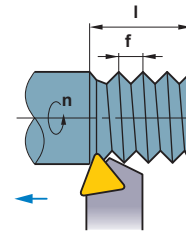

## ■ CUTTING TIME ( $T_c$ )

$$T_c = \frac{l_m}{l} \text{ (min)}$$

$T_c$  (min) : Cutting Time  
 $l_m$  (mm) : Workpiece Length  
 $l$  (mm/min) : Cutting Length per Min.

(Problem) What is the cutting time when 100mm workpiece is machined at  $1000\text{min}^{-1}$  with feed = 0.2mm/rev ?

(Answer) First, calculate the cutting length per min. from the feed and spindle speed.

$$l = f \times n = 0.2 \times 1000 = 200 \text{ mm/min}$$

Substitute the answer above into the formula.

$$T_c = \frac{l_m}{l} = \frac{100}{200} = 0.5 \text{ min}$$

$0.5 \times 60 = 30$  (sec.) The answer is 30 sec.

## ■ THEORETICAL FINISHED SURFACE ROUGHNESS ( $h$ )

$$h = \frac{f^2}{8RE} \times 1000 \text{ (}\mu\text{m)}$$

$h$  ( $\mu\text{m}$ ) : Finished Surface Roughness  
 $f$  (mm/rev) : Feed per Revolution  
 $RE$  (mm) : Insert Corner Radius

(Problem) What is the theoretical finished surface roughness when the insert corner radius is 0.8mm and feed is 0.2mm/rev ?

(Answer) Substitute  $f=0.2\text{mm/rev}$ ,  $RE=0.8$  into the formula.

$$h = \frac{0.2^2}{8 \times 0.8} \times 1000 = 6.25 \mu\text{m}$$

The theoretical finished surface roughness is  $6\mu\text{m}$ .

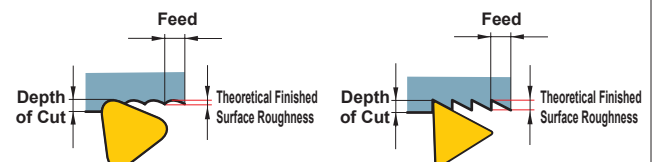



# TROUBLE SHOOTING FOR THREADING

Problems	Observation	Causes	Solutions	
Low thread precision.	Threads do not mesh with each other.	Incorrect tool installation.	Set the insert center height at 0mm. Check holder inclination (Lateral).	
		Shallow thread.	Modify the depth of cut. Refer to "Quickly generated flank wear." and "Large plastic deformation." below.	
	Poor surface finish.	Surface damage.	Chips wrap around or clog the work pieces.	Change to flank infeed and control the chip discharge direction. Change to an M-class insert with a 3-D chip breaker.
The side of the insert cutting edge interferes with the workpiece.			Check the lead angle and select an appropriate shim.	
Surface tears.			Built-up edge (Welding).	Increase cutting speed. Increase coolant pressure and volume.
		Cutting resistance too high.	Decrease depth of cut per pass.	
Surface vibrations.		Cutting speed too high.	Decrease the cutting speed.	
		Insufficient work piece or tool clamping.	Re-check work piece and tool clamping. (Chuck pressure, clamping allowance)	
		Incorrect tool installation.	Set the insert center height at 0mm.	
Short tool life.		Flank wear quickly generated.	Cutting speed too high.	Decrease the cutting speed.
			Too many passes causes abrasive wear.	Reduce the number of passes.
			Small depth of cut for the finishing pass.	Do not re-cut at 0mm depth of cut, larger than 0.05mm depth of cut is recommended.
	Non-uniform wear of the right and left sides of the cutting edge.	The work piece lead angle and the tool lead angle do not match.	Check the work piece lead angle and select an appropriate shim.	
	Chipping and fracture.	Cutting speed too low.	Cutting resistance too high.	Increase cutting speed. Increase the number of passes and decrease the cutting resistance per pass.
			Unstable clamping.	Check work piece deflection. Shorten tool overhang. Recheck work piece and tool clamping. (Chuck pressure, clamping allowance)
		Chip packing.	Chip packing.	Increase coolant pressure to blow away chips. Change the tool pass to control chips. (Lengthen each pass to allow the coolant to clear the chips.) Change from standard internal cutting to back turning to prevent chip jamming.
			Non-chamfered work pieces causes high resistance at the start of each pass.	Chamfer the workpiece entry and exit faces.
			Large plastic deformation.	High cutting speed and large heat generation.
		Lack of coolant supply.		Check coolant is supply is sufficient. Increase coolant pressure and volume.
	Cutting resistance too high.	Increase the number of passes and decrease the cutting resistance per pass.		



# DRILL DIAMETERS FOR PREPARED HOLES

## ● Metric Coarse Screw Thread

Nominal	Drill Diameter	
	HSS	Carbide
M1 ×0.25	0.75	0.75
M1.1×0.25	0.85	0.85
M1.2×0.25	0.95	0.95
M1.4×0.3	1.10	1.10
M1.6×0.35	1.25	1.30
M1.7×0.35	1.35	1.40
M1.8×0.35	1.45	1.50
M2 ×0.4	1.60	1.65
M2.2×0.45	1.75	1.80
M2.3×0.4	1.90	1.95
M2.5×0.45	2.10	2.15
M2.6×0.45	2.15	2.20
M3 ×0.5	2.50	2.55
M3.5×0.6	2.90	2.95
M4 ×0.7	3.3	3.4
M4.5×0.75	3.8	3.9
M5 ×0.8	4.2	4.3
M6 ×1.0	5.0	5.1
M7 ×1.0	6.0	6.1
M8 ×1.25	6.8	6.9
M9 ×1.25	7.8	7.9
M10 ×1.5	8.5	8.6
M11 ×1.5	9.5	9.7
M12 ×1.75	10.3	10.5
M14 ×2.0	12.0	12.2
M16 ×2.0	14.0	14.2
M18 ×2.5	15.5	15.7
M20 ×2.5	17.5	17.7
M22 ×2.5	19.5	19.7
M24 ×3.0	21.0	—
M27 ×3.0	24.0	—
M30 ×3.5	26.5	—
M33 ×3.5	29.5	—
M36 ×4.0	32.0	—
M39 ×4.0	35.0	—
M42 ×4.5	37.5	—
M45 ×4.5	40.5	—
M48 ×5.0	43.0	—

## ● Metric Fine Screw Thread

Nominal	Drill Diameter		Nominal	Drill Diameter		Nominal	Drill Diameter		Nominal	Drill Diameter	
	HSS	Carbide		HSS	Carbide		HSS	Carbide		HSS	Carbide
M1 ×0.2	0.80	0.80	M20 ×2.0	18.0	18.3	M42 ×3.0	39.0	—			
M1.1×0.2	0.90	0.90	M20 ×1.5	18.5	18.7	M42 ×2.0	40.0	—			
M1.2×0.2	1.00	1.00	M20 ×1.0	19.0	19.1	M42 ×1.5	40.5	—			
M1.4×0.2	1.20	1.20	M22 ×2.0	20.0	—	M45 ×4.0	41.0	—			
M1.6×0.2	1.40	1.40	M22 ×1.5	20.5	—	M45 ×3.0	42.0	—			
M1.8×0.2	1.60	1.60	M22 ×1.0	21.0	—	M45 ×2.0	43.0	—			
M2 ×0.25	1.75	1.75	M24 ×2.0	22.0	—	M45 ×1.5	43.5	—			
M2.2×0.25	1.95	2.00	M24 ×1.5	22.5	—	M48 ×4.0	44.0	—			
M2.5×0.35	2.20	2.20	M24 ×1.0	23.0	—	M48 ×3.0	45.0	—			
M3 ×0.35	2.70	2.70	M25 ×2.0	23.0	—	M48 ×2.0	46.0	—			
M3.5×0.35	3.20	3.20	M25 ×1.5	23.5	—	M48 ×1.5	46.5	—			
M4 ×0.5	3.50	3.55	M25 ×1.0	24.0	—	M50 ×3.0	47.0	—			
M4.5×0.5	4.00	4.05	M26 ×1.5	24.5	—	M50 ×2.0	48.0	—			
M5 ×0.5	4.50	4.55	M27 ×2.0	25.0	—	M50 ×1.5	48.5	—			
M5.5×0.5	5.00	5.05	M27 ×1.5	25.5	—						
M6 ×0.75	5.30	5.35	M27 ×1.0	26.0	—						
M7 ×0.75	6.30	6.35	M28 ×2.0	26.0	—						
M8 ×1.0	7.00	7.10	M28 ×1.5	26.5	—						
M8 ×0.75	7.30	7.35	M28 ×1.0	27.0	—						
M9 ×1.0	8.00	8.10	M30 ×3.0	27.0	—						
M9 ×0.75	8.30	8.35	M30 ×2.0	28.0	—						
M10 ×1.25	8.80	8.90	M30 ×1.5	28.5	—						
M10 ×1.0	9.00	9.10	M30 ×1.0	29.0	—						
M10 ×0.75	9.30	9.35	M32 ×2.0	30.0	—						
M11 ×1.0	10.0	10.1	M32 ×1.5	30.5	—						
M11 ×0.75	10.3	10.3	M33 ×3.0	30.0	—						
M12 ×1.5	10.5	10.7	M33 ×2.0	31.0	—						
M12 ×1.25	10.8	10.9	M33 ×1.5	31.5	—						
M12 ×1.0	11.0	11.1	M35 ×1.5	33.5	—						
M14 ×1.5	12.5	12.7	M36 ×3.0	33.0	—						
M14 ×1.0	13.0	13.1	M36 ×2.0	34.0	—						
M15 ×1.5	13.5	13.7	M36 ×1.5	34.5	—						
M15 ×1.0	14.0	14.1	M38 ×1.5	36.5	—						
M16 ×1.5	14.5	14.7	M39 ×3.0	36.0	—						
M16 ×1.0	15.0	15.1	M39 ×2.0	37.0	—						
M17 ×1.5	15.5	15.7	M39 ×1.5	37.5	—						
M17 ×1.0	16.0	16.1	M40 ×3.0	37.0	—						
M18 ×2.0	16.0	16.3	M40 ×2.0	38.0	—						
M18 ×1.5	16.5	16.7	M40 ×1.5	38.5	—						
M18 ×1.0	17.0	17.1	M42 ×4.0	38.0	—						

Note 1) When using the drill diameters shown in this table, that the processed hole should be measured since the size accuracy of a drill hole may change due to the drilling condition, and that if found to be inappropriate for a prepared hole, the drill diameter must be corrected accordingly.

# THREADING METHODS

## THREADING METHODS

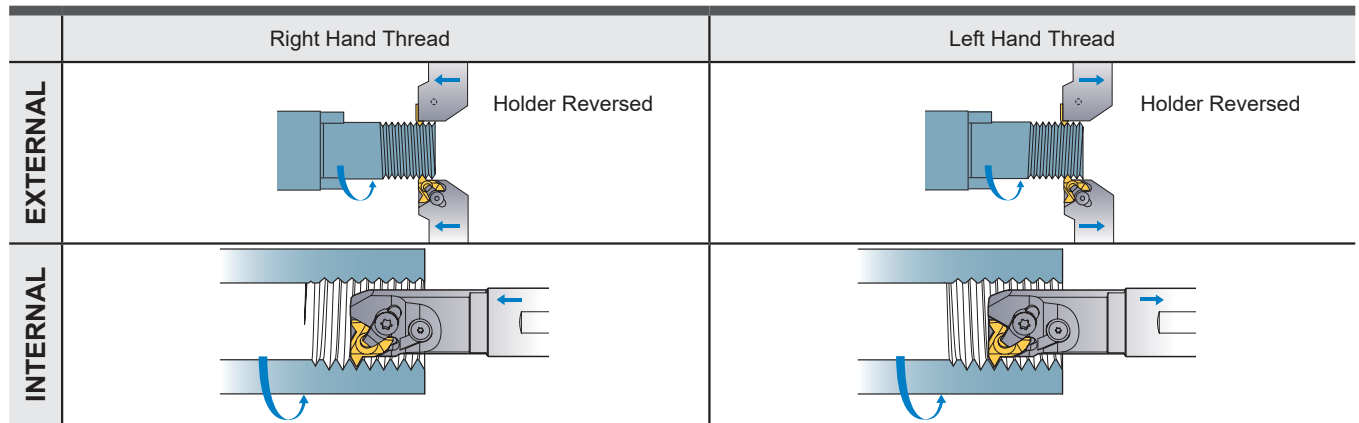

- Usually, threads are cut with the feed towards the chuck.
- When machining left hand threads, note that clamping rigidity is lowered due the application of back turning.
- When machining left hand threads, the lead angle is negative. Ensure an appropriate lead angle by changing the shim.

## INSERT TYPES

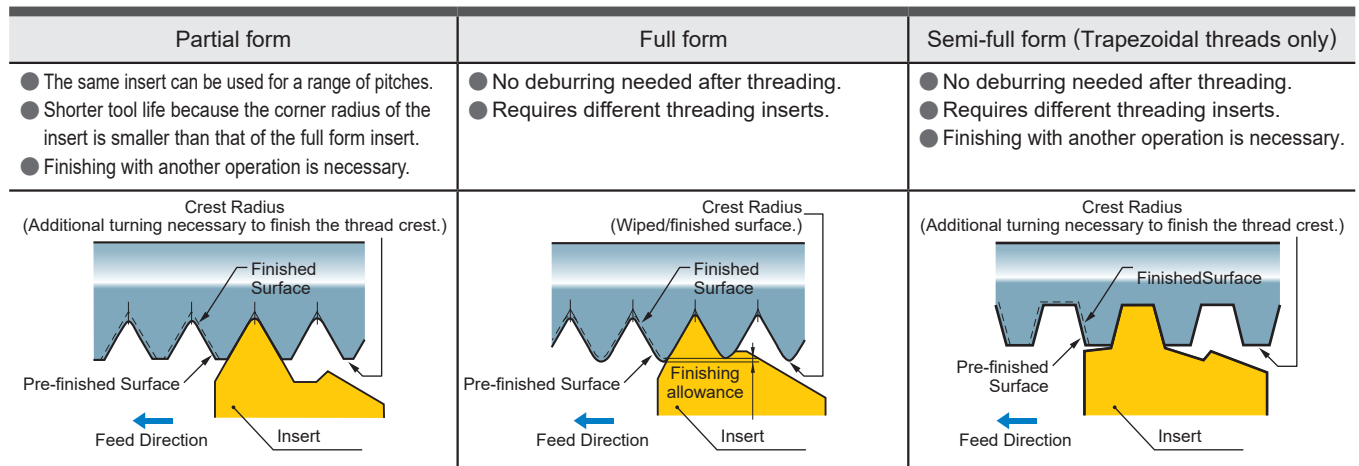

## INFEEED METHODS

	Radial Infeed	Flank Infeed	Modified Flank Infeed	Incremental Infeed
Features				
Advantages	<ul style="list-style-type: none"> <li>• Easiest to use. (Standard programme for threading)</li> <li>• Wide application. (Cutting conditions easy to change.)</li> <li>• Uniform wear of the right and left sides of the cutting edge.</li> </ul>	<ul style="list-style-type: none"> <li>• Relatively easy to use. (Semi-standard program for threading.)</li> <li>• Reduced cutting force.</li> <li>• Suitable for large pitch threads or materials that peel easily.</li> <li>• Good chip discharge.</li> </ul>	<ul style="list-style-type: none"> <li>• Preventing flank wear on the right side of the cutting edge.</li> <li>• Reduced cutting force.</li> <li>• Suitable for large pitch threads or materials that peel easily.</li> <li>• Good chip discharge.</li> </ul>	<ul style="list-style-type: none"> <li>• Uniform flank wear of the right and left sides of the cutting edge.</li> <li>• Reduced cutting force.</li> <li>• Suitable for large pitch threads or materials that peel easily.</li> </ul>
Disadvantages	<ul style="list-style-type: none"> <li>• Difficult chip control.</li> <li>• Subject to vibration in the later in stages of cutting.</li> <li>• Ineffective for large pitch threading.</li> <li>• Heavy load on the corner radius.</li> </ul>	<ul style="list-style-type: none"> <li>• Large flank wear on the right side of the cutting edge.</li> <li>• Relatively difficult to change cutting depth. (Re-programming necessary)</li> </ul>	<ul style="list-style-type: none"> <li>• Complex machining programming.</li> <li>• Difficult to change cutting depth. (Re-programming necessary)</li> </ul>	<ul style="list-style-type: none"> <li>• Complex machining programming.</li> <li>• Difficult to change cutting depth. (Re-programming necessary)</li> <li>• Difficult chip control.</li> </ul>

# THREADING DEPTH

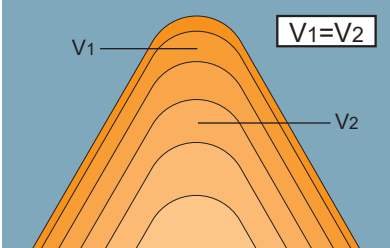
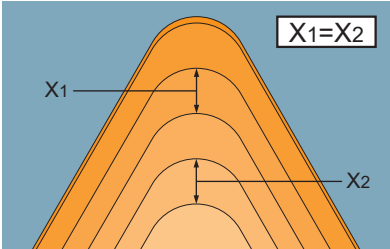
		Features	
		Advantages	Disadvantages
 <p>Fixed cut area</p>	<ul style="list-style-type: none"> <li>● Easy to use. (Standard programme for threading.)</li> <li>● Superior resistance to vibration. (Constant cutting force.)</li> </ul>	<ul style="list-style-type: none"> <li>● Long chips generated during the final pass.</li> <li>● Complex calculation of cutting depth when changing the number of passes.</li> </ul>	
 <p>Fixed cutting depth</p>	<ul style="list-style-type: none"> <li>● Reduced load on corner radius during the first half of the passes.</li> <li>● Easy chip control. (Optional setting of chip thickness)</li> <li>● Easy to calculate cutting depth when changing the number of passes.</li> <li>● Good chip control.</li> </ul>	<ul style="list-style-type: none"> <li>● Subject to vibration in the later stages of cutting. (Increased cutting force)</li> <li>● In some cases, changing the NC programme is necessary.</li> </ul>	

\* It is recommended to set the depth of cut of the final pass to 0.05mm–0.025mm. Large cutting depths can cause vibration, leading to a poor surface finish.

## FORMULAE

### ● Formulae to calculate infeed for each pass in a reduced series.

$\Delta ap_n = \frac{ap}{\sqrt{n_{ap}-1}} \times \sqrt{b}$	<p>(Example) External threading (ISO Metric) Pitch : 1.0mm ap : 0.6mm n<sub>ap</sub> : 5 passes</p> <p>1st Pass <math>\Delta ap_1 = \frac{0.60}{\sqrt{5-1}} \times \sqrt{0.3} = 0.16 \rightarrow \mathbf{0.16} (\Delta ap_1)</math></p> <p>2nd Pass <math>\Delta ap_2 = \frac{0.60}{\sqrt{5-1}} \times \sqrt{2-1} = 0.3 \rightarrow \mathbf{0.14} (\Delta ap_2 - \Delta ap_1)</math></p> <p>3rd Pass <math>\Delta ap_3 = \frac{0.60}{\sqrt{5-1}} \times \sqrt{3-1} = 0.42 \rightarrow \mathbf{0.12} (\Delta ap_3 - \Delta ap_2)</math></p> <p>4th Pass <math>\Delta ap_4 = \frac{0.60}{\sqrt{5-1}} \times \sqrt{4-1} = 0.52 \rightarrow \mathbf{0.1} (\Delta ap_4 - \Delta ap_3)</math></p> <p>5th Pass <math>\Delta ap_5 = \frac{0.60}{\sqrt{5-1}} \times \sqrt{5-1} = 0.6 \rightarrow \mathbf{0.08} (\Delta ap_5 - \Delta ap_4)</math></p>
--	--

## NC PROGRAMME FOR MODIFIED FLANK INFEEED

### ● Example) M12×1.0 5 passes modified 5°

External Threading	Internal Threading
G00 Z = 5.0 X = 14.0	G00 Z = 5.0 X = 10.0
G92 U-4.34 Z-13.0 F1.0	G92 U4.34 Z-13.0 F1.0
G00 W-0.07	G00 W-0.07
G92 U-4.64 Z-13.0 F1.0	G92 U4.64 Z-13.0 F1.0
G00 W-0.06	G00 W-0.05
G92 U-4.88 Z-13.0 F1.0	G92 U4.84 Z-13.0 F1.0
G00 W-0.05	G00 W-0.04
G92 U-5.08 Z-13.0 F1.0	G92 U5.02 Z-13.0 F1.0
G00 W-0.03	G00 W-0.03
G92 U-5.20 Z-13.0 F1.0	G92 U5.14 Z-13.0 F1.0
G00	G00

# THREADING METHODS

## SELECTING CUTTING CONDITIONS

		Priority					
		Tool Life	Cutting Force	Surface Finish	Precision of Thread	Chip Discharge	Efficiency (Reduced Passes)
Threading Methods	Radial	○		○	○		○
	Flank	(△ : Modified)	○	(△ : Modified)		○	
Cutting Depth	Fixed Cutting Depth					○	
	Fixed Cut Area	○	○	○	○		○

Note 1) Tool life and surface finish accuracy can be increased by changing the threading method from flank infeed to modified flank infeed. Chip control can be improved by increasing the cutting depth in the later half of passes.

### CUTTING DEPTH AND THE NUMBER OF PASSES

- **Selection of the appropriate cutting depth and the right number of passes is vital for threading.**
  - For most threading, use a "threading cycle program," which has originally been installed on machines, and specify "total cutting depth" and "cutting depth in the first or final pass."
  - Cutting depth and the number of passes are easy to change for the radial infeed method, thus making it easy to determine the appropriate cutting conditions.

### FEATURES AND BENEFITS OF MITSUBISHI PRODUCTS

- Insert grades with high wear and plastic deformation resistance, specially produced for threading tools, ensure highly efficient cutting by enabling high-speed machining and a reduced number of passes.



**Machining Cost Reduction**

### ADVICE ON IMPROVED THREADING

- **Increasing tool life**
  - To prevent damage to the corner radius - Recommended method - Modified flank infeed
  - To have uniform flank wear on both sides of a cutting edge - Recommended method - Radial infeed
  - To prevent crater wear - Recommended method - Flank infeed
- **Preventing chip problems**
  - Change to flank or modified infeed.
  - During radial infeed cutting, use an inverted holder and change the coolant supply to a downward direction.
  - When using the radial infeed method, set the minimum cutting depth at around 0.2mm to make the chips thicker.
- **To achieve highly efficient machining**
  - Increase cutting speed. (Dependant on the maximum revolution and rigidity of the machine.)
  - Reduce the number of passes. (Reduce by 30-40%.)
  - A reduced number of passes can improve chip discharge because of the thicker chips generated.
- **Preventing vibration**
  - Change to flank or modified infeed.
  - When using radial infeed, reduce cutting depth in the later half of passes and lower the cutting speed.
- **Increased surface finish accuracy**
  - A final wiping pass should be performed at the same depth of cut as the last regular pass.
  - When using the flank infeed method, change to radial infeed only during the final pass.

# TROUBLE SHOOTING FOR FACE MILLING

Solution		Insert Grade Selection	Cutting Conditions					Style and Design of the Tool						Machine, Installation of Tool												
			Select a harder grade	Select a tougher grade	Select a grade with better thermal shock resistance	Select a grade with better adhesion resistance	Cutting speed	Feed	Depth of cut	Engage angle	Coolant		Rake	Corner angle	Honing strengthens the cutting edge	Cutter diameter	Number of teeth	Wider chip pocket	Use of a wiper insert	Improve run-out accuracy	Cutter rigidity	Increase clamping rigidity of the tool and workpiece	Decrease overhang	Decrease power and machine backlash		
Up ↗	Down ↘	Up ↗									Down ↘	Up ↗													Down ↘	Smaller ↘
Trouble	Factors																									
		Deterioration of Tool Life	Insert wear quickly generated	Improper tool grade	●																					
Improper cutting edge geometry																										
Deterioration of Tool Life	Chipping or fracturing of cutting edge	Improper cutting speed				↘																				
		Improper tool grade		●																						
Deterioration of Tool Life	Chipping or fracturing of cutting edge	Improper cutting conditions					↘	↘																		
		Lack of cutting edge strength																								
Deterioration of Tool Life	Chipping or fracturing of cutting edge	Thermal crack occurs			●																					
		Build-up edge occurs				●																				
Deterioration of Tool Life	Chipping or fracturing of cutting edge	Lack of rigidity																								
Deterioration of Surface Finish	Poor finished surface	Improper cutting conditions	●																							
		Welding occurs				●																				
Deterioration of Surface Finish	Poor finished surface	Poor run-out accuracy																								
		Chattering																								
Deterioration of Surface Finish	Not parallel or irregular surface	Workpiece bending																								
		Tool clearance																								
Deterioration of Surface Finish	Not parallel or irregular surface	Large back force																								
Burr, Workpiece Chipping	Burs, chipping	Chip thickness is too large																								
		Cutter diameter is too large																								
Burr, Workpiece Chipping	Burs, chipping	Low sharpness																								
		A large corner angle																								
Burr, Workpiece Chipping	Workpiece edge chipping	Improper cutting conditions																								
		Low sharpness																								
Burr, Workpiece Chipping	Workpiece edge chipping	A small corner angle																								
		Chattering																								
Chip Control	Poor chip dispersal, chip jamming and chip packing	Welding occurs																								
		Chip thickness is too thin																								
Chip Control	Poor chip dispersal, chip jamming and chip packing	Cutter diameter is too small																								
		Poor chip disposal																								
Chip Control	Poor chip dispersal, chip jamming and chip packing																									



# FUNCTION OF TOOL FEATURES FOR FACE MILLING

## FUNCTION OF EACH CUTTING EDGE ANGLE IN FACE MILLING

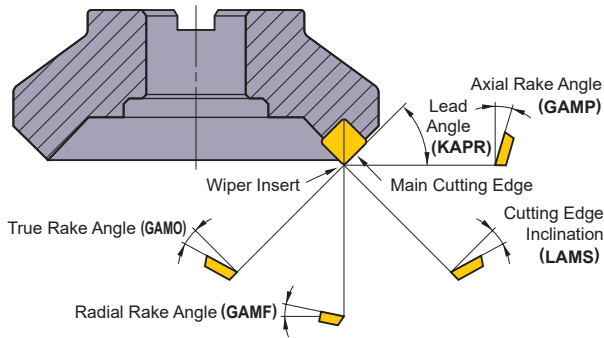

Each Cutting Edge Angle in Face Milling

Type of Angle	Symbol	Function	Effect
Axial Rake Angle	GAMP	Determines chip disposal direction.	<b>Positive</b> : Excellent machinability.
Radial Rake Angle	GAMF	Determines sharpness.	<b>Negative</b> : Excellent chip disposal.
Lead Angle	KAPR	Determines chip thickness.	<b>Small</b> : Thin chips and small cutting impact. Large back force.
True Rake Angle	GAMO	Determines actual sharpness.	<b>Positive (large)</b> : Excellent machinability. Minimal welding. <b>Negative (large)</b> : Poor machinability. Strong cutting edge.
Cutting Edge Inclination	LAMS	Determines chip disposal direction.	<b>Positive (large)</b> : Excellent chip disposal. Low cutting edge strength.

## STANDARD INSERTS

### Positive and Negative Rake Angle

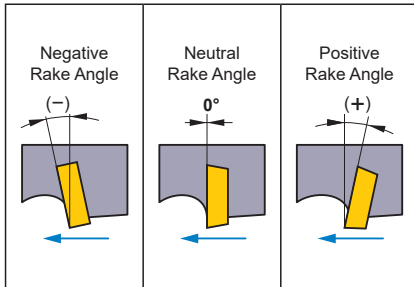

- Insert shape whose cutting edge precedes is a positive rake angle.
- Insert shape whose cutting edge follows is a negative rake angle.

### Standard Cutting Edge Shape

Standard Cutting Edge Combinations	(+) Axial Rake Angle	(-) Axial Rake Angle	(+) Axial Rake Angle
	Radial Rake Angle (+)	Radial Rake Angle (-)	Radial Rake Angle (-)
	Double Positive (DP Edge Type)	Double Negative (DN Edge Type)	Negative/Positive (NP Edge Type)
Axial Rake Angle (GAMP)	Positive (+)	Negative (-)	Positive (+)
Radial Rake Angle (GAMF)	Positive (+)	Negative (-)	Negative (-)
Insert Used	Positive Insert (One Sided Use)	Negative Insert (Double Sided Use)	Positive Insert (One Sided Use)
Work Material	Steel	●	●
	Cast Iron	-	●
	Aluminium Alloy	●	-
	Difficult-to-Cut Material	●	-

## LEAD ANGLE (KAPR) AND CUTTING CHARACTERISTICS

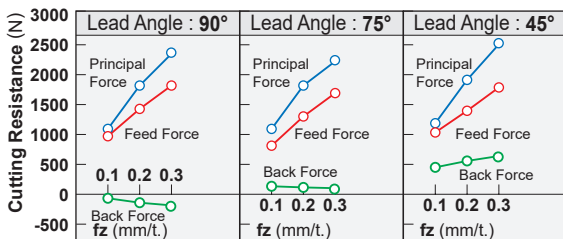

Workpiece : JIS SCM440 (281HB)  
Tool :  $\phi 125$ mm Single Insert  
Cutting Conditions :  $vc=125.6$ m/min  $ap=4$ mm  $ae=110$ mm

### Cutting Resistance Comparison between Different Insert Shapes

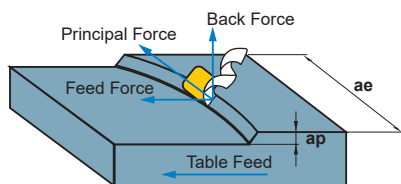

Three Cutting Resistance Forces in Milling

**Lead Angle 0°**

Back force is in the minus direction. Lifts the workpiece when workpiece clamp rigidity is low.

Lead Angle 90°

**Lead Angle 15°**

Lead angle 75° is recommended for face milling of workpieces with low rigidity such as thin workpieces.

Lead Angle 75°

**Lead Angle 45°**

The largest back force. Bends thin workpieces and lowers cutting accuracy.  
\*Prevents workpiece edge chipping when cast iron cutting.

Lead Angle 45°

- \* Principal force : Force is in the opposite direction of face milling rotation.
- \* Back force : Force that pushes in the axial direction.
- \* Feed force : Force is in the feed direction and is caused by table feed.



## ■ APPROACH ANGLE AND THE TOOL LIFE

### ● Approach Angle and Chip Thickness

When the depth of cut and feed per tooth,  $f_z$ , are fixed, the smaller the lead angle (KAPR) is, then the thinner the chip thickness ( $h$ ) becomes (for a 45° KAPR, it is approx. 75% that of a 90° KAPR). This can be seen in below. Therefore as the KAPR increases, the cutting resistance decreases resulting in longer tool life. Note however, if the chip thickness is too large then the cutting resistance can increase leading to vibrations and shortened tool life.

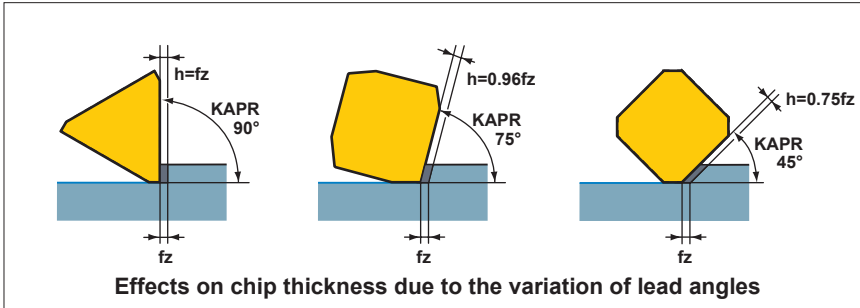

### ● Approach Angle and Face Wear

Below shows wear patterns for different lead angles. When comparing crater wear for 90° and 45° lead angles, it can be clearly seen that the crater wear for 90° lead angle is larger.

	Lead Angle 90°	Lead Angle 75°	Lead Angle 45°
<b>vc=100m/min Tc=69min</b>			
<b>vc=125m/min Tc=55min</b>			
<b>vc=160m/min Tc=31min</b>			

Workpiece : **SNCM439 287HB**  
 Tools : **DC=125mm**  
 Insert : **M20Cemented Carbide**  
 Cutting Conditions : **ap=3.0mm**  
                               **ae=110mm**  
                               **fz=0.2mm/t.**  
 Dry Cutting

## ■ UP AND DOWN CUT (CLIMB) MILLING

When choosing a method to machine, up cutting or down cut milling (climb milling) is decided by the conditions of the machine tool, the milling cutter and the application. However, it is said that in terms of tool life, down cut (climb) milling is more advantageous.

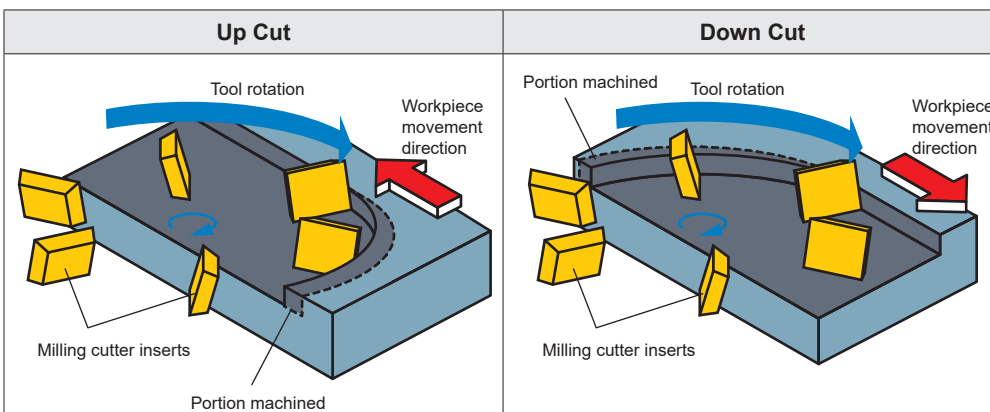

# FUNCTION OF TOOL FEATURES FOR FACE MILLING

## ■ FINISHED SURFACE

### ● Cutting Edge Run-out Accuracy

Cutting edge run-out accuracy of indexable inserts on the cutter body greatly affects the surface finish and tool life.

**Cutting Edge Run-out and Accuracy in Face Milling**

### ● Improve Finished Surface Roughness

Since Mitsubishi Materials' normal sub cutting edge width is 1.4mm, and the sub cutting edges are set parallel to the face of a milling cutter, theoretically the finished surface accuracy should be maintained even if run-out accuracy is low.

**Sub Cutting Edge Run-out and Finished Surface**

**Actual Problems**

- Cutting edge run-out.
- Sub cutting edge inclination.
- Milling cutter body accuracy.
- Spare parts accuracy.
- Welding, vibration, chattering.

**Countermeasure**

**Wiper Insert**

- \* Machine a surface that has already been per-machined in order to produce smooth finished surface.
- Replace one or two normal inserts with wiper inserts.
- Wiper inserts be set to protrude by 0.03—0.1mm from the standard inserts.
- \*1. Value depends on the cutting edge and insert combination.

### ● How to Set a Wiper Insert

· Sub cutting edge length has to be longer than the feed per revolution.

\* Too long sub cutting edge causes chattering.

- When the cutter diameter is large and feed per revolution is longer than the sub cutting edge of the wiper insert, use two or three wiper inserts.
- When using more than 1 wiper inserts, eliminate run-out of wiper inserts.
- Use a high hardness grade (high wear resistance) for wiper inserts.

(a) One Corner Type Replace normal insert.	(b) Two Corner Type Replace normal insert.	(c) Two Corner Type Use locator for wiper insert.
---	---	--



# FORMULAE FOR FACE MILLING

## ■ CUTTING SPEED (vc)

$$vc = \frac{\pi \cdot DC \cdot n}{1000} \text{ (m/min)}$$

vc (m/min) : Cutting Speed  
 $\pi$  (3.14) : Pi

DC (mm) : Cutter Diameter  
 n (min<sup>-1</sup>) : Main Axis Spindle Speed

\*Divide by 1000 to change to m from mm.

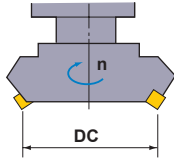

(Problem) What is the cutting speed when main axis spindle speed is 350min<sup>-1</sup> and the cutter diameter is  $\phi$ 125 ?

(Answer) Substitute  $\pi=3.14$ , DC=125, n=350 into the formula.

$$vc = \frac{\pi \cdot DC \cdot n}{1000} = \frac{3.14 \times 125 \times 350}{1000} = 137.4 \text{ m/min}$$

The cutting speed is 137.4m/min.

## ■ FEED PER TOOTH (fz)

$$fz = \frac{vf}{z \cdot n} \text{ (mm/t.)}$$

fz (mm/t.) : Feed per Tooth

z : Insert Number

vf (mm/min) : Table Feed per Min.

n (min<sup>-1</sup>) : Main Axis Spindle Speed (Feed per Revolution  $fr = z \times fz$ )

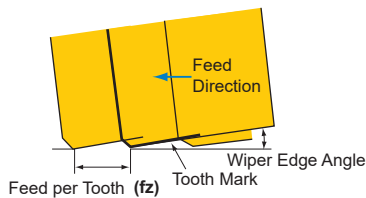

(Problem) What is the feed per tooth when the main axis spindle speed is 500min<sup>-1</sup>, number of insert is 10, and table feed is 500mm/min ?

(Answer) Substitute the above figures into the formula.

$$fz = \frac{vf}{z \cdot n} = \frac{500}{10 \times 500} = 0.1 \text{ mm/t.}$$

The answer is 0.1mm/t.

## ■ TABLE FEED (vf)

$$vf = fz \cdot z \cdot n \text{ (mm/min)}$$

vf (mm/min) : Table Feed per Min.

z : Insert Number

fz (mm/t.) : Feed per Tooth

n (min<sup>-1</sup>) : Main Axis Spindle Speed

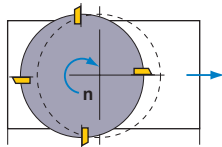

(Problem) What is the table feed when feed per tooth is 0.1mm/t., number of insert is 10, and main axis spindle speed is 500min<sup>-1</sup>?

(Answer) Substitute the above figures into the formula.

$$vf = fz \cdot z \cdot n = 0.1 \times 10 \times 500 = 500 \text{ mm/min}$$

The table feed is 500mm/min.

## ■ CUTTING TIME (Tc)

$$Tc = \frac{L}{vf} \text{ (min)}$$

Tc (min) : Cutting Time

vf (mm/min) : Table Feed per Min.

L (mm) : Total Table Feed Length (Workpiece Length: (l))+Cutter Diameter : (DC))

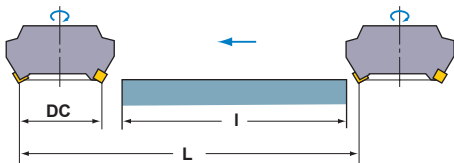

(Problem) What is the cutting time required for finishing 100mm width and 300mm length surface of a cast iron (JIS FC200) block when the cutter diameter is  $\phi$ 200mm, the number of inserts is 16, the cutting speed is 125m/min, and feed per tooth is 0.25mm. (spindle speed is 200min<sup>-1</sup>)

(Answer) Calculate table feed per min  $vf=0.25 \times 16 \times 200=800$ mm/min

Calculate total table feed length.  $L=300+200=500$ mm

Substitute the above answers into the formula.

$$Tc = \frac{500}{800} = 0.625 \text{ (min)}$$

$0.625 \times 60=37.5$  (sec). The answer is 37.5 sec.

# FORMULAE FOR FACE MILLING

## ■ CUTTING POWER (P<sub>c</sub>)

$$P_c = \frac{ap \cdot ae \cdot vf \cdot K_c}{60 \times 10^6 \times \eta}$$

**P<sub>c</sub> (kW)** : Actual Cutting Power  
**ae (mm)** : Cutting Width  
**K<sub>c</sub> (MPa)** : Specific Cutting Force  
**ap (mm)** : Depth of Cut  
**vf (mm/min)** : Table Feed per Min.  
**η** : (Machine Coefficient)

(Problem) What is the cutting power required for milling tool steel at a cutting speed of 80m/min. With depth of cut 2mm, cutting width 80mm, and table feed 280mm/min by  $\phi 250$  cutter with 12 inserts. Machine coefficient 80%.

(Answer) First, calculate the spindle speed in order to obtain feed per tooth.

$$n = \frac{1000vc}{\pi DC} = \frac{1000 \times 80}{3.14 \times 250} = 101.91 \text{ min}^{-1}$$

$$\text{Feed per Tooth } fz = \frac{vf}{z \times n} = \frac{280}{12 \times 101.9} = 0.228 \text{ mm/t.}$$

Substitute the specific cutting force into the formula.

$$P_c = \frac{2 \times 80 \times 280 \times 1800}{60 \times 10^6 \times 0.8} = 1.68 \text{ kW}$$

## ● K<sub>c</sub>

Work Material	Tensile Strength (MPa) and Hardness	Specific Cutting Force K <sub>c</sub> (MPa)				
		0.1mm/t.	0.2mm/t.	0.3mm/t.	0.4mm/t.	0.6mm/t.
Mild Steel	520	2200	1950	1820	1700	1580
Medium Steel	620	1980	1800	1730	1600	1570
Hard Steel	720	2520	2200	2040	1850	1740
Tool Steel	670	1980	1800	1730	1700	1600
Tool Steel	770	2030	1800	1750	1700	1580
Chrome Manganese Steel	770	2300	2000	1880	1750	1660
Chrome Manganese Steel	630	2750	2300	2060	1800	1780
Chrome Molybdenum Steel	730	2540	2250	2140	2000	1800
Chrome Molybdenum Steel	600	2180	2000	1860	1800	1670
Nickel Chrome Molybdenum Steel	940	2000	1800	1680	1600	1500
Nickel Chrome Molybdenum Steel	352HB	2100	1900	1760	1700	1530
Austenitic Stainless Steel	155HB	2030	1970	1900	1770	1710
Cast Iron	520	2800	2500	2320	2200	2040
Hard Cast Iron	46HRC	3000	2700	2500	2400	2200
Meehanite Cast Iron	360	2180	2000	1750	1600	1470
Grey Cast Iron	200HB	1750	1400	1240	1050	970
Brass	500	1150	950	800	700	630
Light Alloy (Al-Mg)	160	580	480	400	350	320
Light Alloy (Al-Si)	200	700	600	490	450	390
Light Alloy (Al-Zn-Mg-Cu)	570	880	840	840	810	720

# TROUBLE SHOOTING FOR END MILLING

Solution		Insert Grade Selection	Cutting Conditions								Style and Design of the Tool				Machine, Installation of Tool												
			Coated tool	Cutting speed		Depth of cut	Pick feed	Down cut	Use air blow	Coolant			Helix angle	Insert number	Concavity angle of end cutting edge	Tool diameter	Cutter rigidity	Wider chip pocket	Shorten tool overhang	Increase tool installation accuracy	Increase spindle collet run-out accuracy	Collet inspection and exchange	Increase chuck clamping power	Increase work clamping rigidity			
				Feed	Up ↗ Down ↘					Increase coolant quantity	Do not use water-soluble cutting fluid	Determine dry or wet cutting													Up ↗ Down ↘	Larger Smaller	
Trouble	Factors																										
		Deterioration of Tool Life	Large peripheral cutting edge wear	Non-coated end mill is used	●																						
				A small number of cutting edges																							
Improper cutting conditions				↘							●																
Severe chipping	Up cut milling is used								Down Cut																		
	Improper cutting conditions																										
	Fragile cutting edge																										
Breakage during cutting	Insufficient clamping force																						●	●			
	Low clamping rigidity																					●	●	●			
	Improper cutting conditions																										
	Low end mill rigidity																										
Deterioration of Surface Finish	Vibration during cutting	Overhang longer than necessary																									
		Chip jamming																									
		Improper cutting conditions																									
	Poor surface finish on walls	Low end mill rigidity																									
		Low clamping rigidity																									
		Large cutting edge wear	●																								
	Poor surface finish on faces	Improper cutting conditions																									
		Chip packing																									
		The end cutting edge does not have a concave angle																									
	Out of vertical	Large pick feed																									
Large cutting edge wear		●																									
Improper cutting conditions																											
Lack of end mill rigidity																											
Burr, Chipping, etc.	Burr or chipping occurs	Improper cutting conditions																									
		Large helix angle																									
Poor Chip Dispersal	Chip packing	Notch wear	●																								
		Improper cutting conditions																									
		Metal removal too large																									
		Lack of chip pocket																									

TECHNICAL DATA



# END MILL TERMINOLOGY

## END MILL TERMINOLOGY

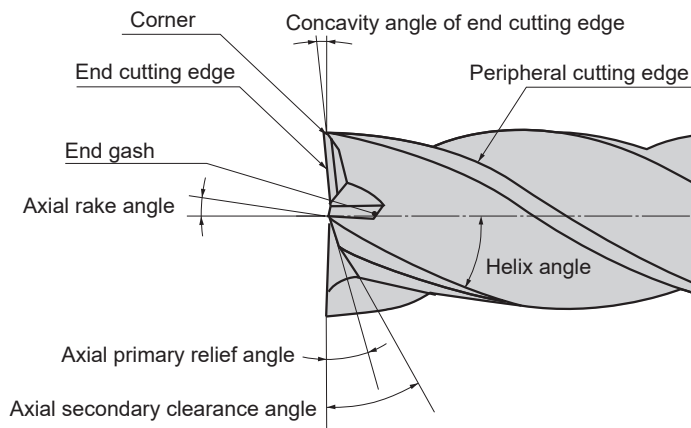
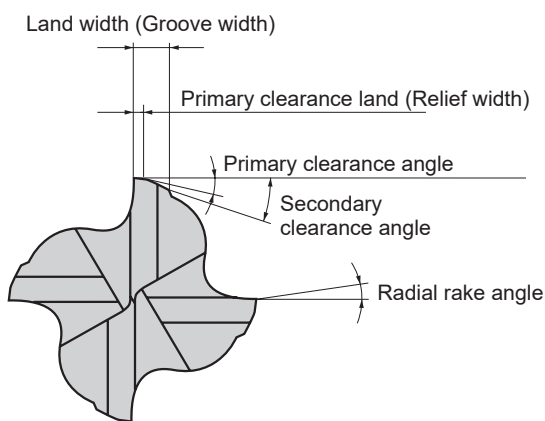
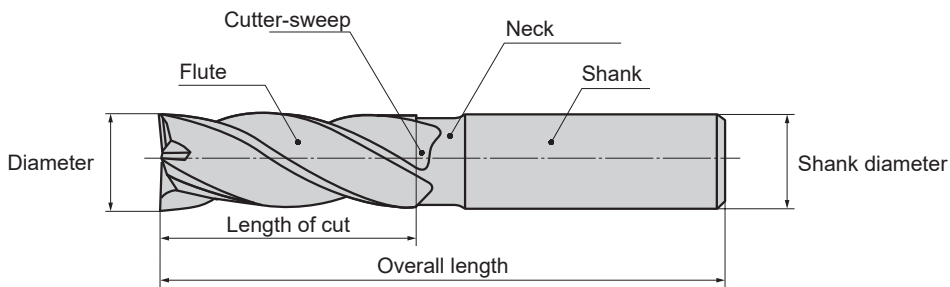

## COMPARISON OF SECTIONAL SHAPE AREA OF CHIP POCKET

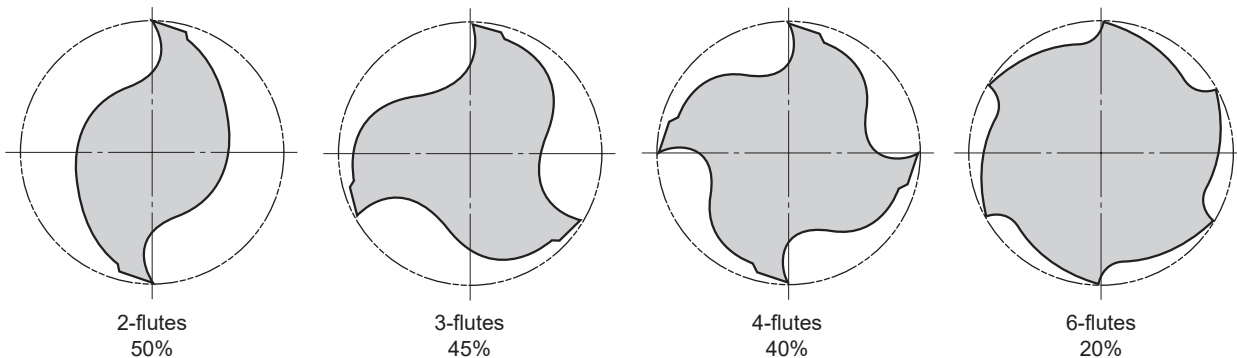

## CHARACTERISTICS AND APPLICATIONS OF DIFFERENT-NUMBER-OF-FLUTE END MILLS



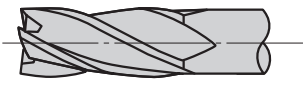
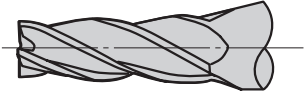
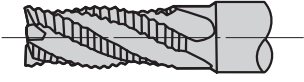
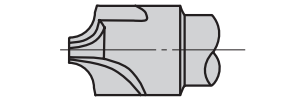

	2-flutes	3-flutes	4-flutes	6-flutes
Feature	Advantage	Chip disposability is excellent. Suitable for sinking.	High rigidity	High rigidity. Superior cutting edge durability.
	Fault	Low rigidity	Diameter is not easily measured.	Chip disposability is poor.
Usage	Slotting, side milling, sinking etc. Wide range of use.	Slotting, side milling Heavy cutting, finishing	Shallow slotting, side milling Finishing	High Hardness Material Shallow slotting, side milling

# TYPES AND SHAPES OF END MILL



## ■ Peripheral Cutting Edge

Kind	Shape	Feature
Ordinary Flute		Ordinary flute type is most generally used for the slotting, side milling, and the shoulder milling, etc. Can be used for roughing, semi-finishing, and the finishing.
Tapered Flute		A tapered flute is used for milling mould drafts and angled faces.
Roughing Flute		Because a roughing tooth has a wave-like form and produces small chips. Cutting resistance is low, and is suitable for roughing. Not suitable for finishing. The tooth face is re-grindable.
Formed Flute		A corner radius cutter is shown. An infinite range of form cutters can be produced.

## ■ End Cutting Edge

Kind	Shape	Feature
Square End (Centre With Hole)		This is generally used for slotting, side milling, and shoulder milling. Sinking is not possible. Grinding is center supported, making re-grinding accurate.
Square End (Centre Cut)		It is generally used for slotting, side milling, and shoulder milling. Vertical cutting can be performed. Re-grinding is possible.
Ball End		Suitable for profile machining and pick feed milling.
End Radius		For corner radius milling and contouring. Efficient small corner radius milling due to large diameter and small corner radius.

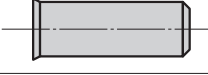
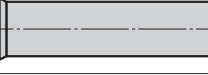
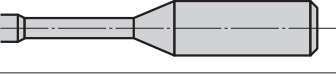
## ■ Shank and Neck Parts

Kind	Shape	Feature
Standard (Straight Shank)		For general use.
Long Shank		For deep slotting and has a long shank, so that adjustment of the overhang is possible.
Long Neck		For deep slotting and small diameter end mills, also suitable for boring.
Taper Neck		For best performance in deep slotting and on mould drafts.

# PITCH SELECTION OF PICK FEED

■ PICK FEED MILLING (CONTOURING) WITH BALL NOSE END MILLS AND END MILLS WITH CORNER RADIUS

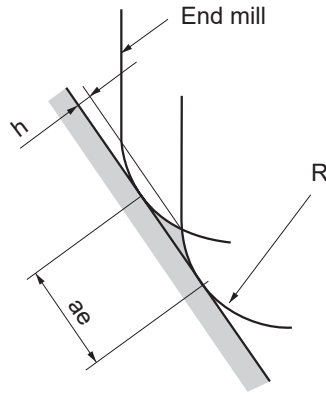

$$h = R \cdot \left[ 1 - \cos \left\{ \sin^{-1} \left( \frac{ae}{2R} \right) \right\} \right]$$

R : Radius of Ball Nose(RE), Corner Radius(RE)  
 ae : Pick Feed  
 h : Cusp Height

■ CORNER R OF END MILLS AND CUSP HEIGHT BY PICK FEED

Unit : mm

R \ ae	Pick Feed									
	0.1	0.2	0.3	0.4	0.5	0.6	0.7	0.8	0.9	1.0
0.5	0.003	0.010	0.023	0.042	0.067	0.100	—	—	—	—
1	0.001	0.005	0.011	0.020	0.032	0.046	0.063	0.083	0.107	—
1.5	0.001	0.003	0.008	0.013	0.021	0.030	0.041	0.054	0.069	0.086
2	0.001	0.003	0.006	0.010	0.016	0.023	0.031	0.040	0.051	0.064
2.5	0.001	0.002	0.005	0.008	0.013	0.018	0.025	0.032	0.041	0.051
3		0.002	0.004	0.007	0.010	0.015	0.020	0.027	0.034	0.042
4		0.001	0.003	0.005	0.008	0.011	0.015	0.020	0.025	0.031
5		0.001	0.002	0.004	0.006	0.009	0.012	0.016	0.020	0.025
6		0.001	0.002	0.003	0.005	0.008	0.010	0.013	0.017	0.021
8			0.001	0.003	0.004	0.006	0.008	0.010	0.013	0.016
10			0.001	0.002	0.003	0.005	0.006	0.008	0.010	0.013
12.5			0.001	0.002	0.003	0.004	0.005	0.006	0.008	0.010

R \ ae	Pick Feed									
	1.1	1.2	1.3	1.4	1.5	1.6	1.7	1.8	1.9	2.0
0.5	—	—	—	—	—	—	—	—	—	—
1	—	—	—	—	—	—	—	—	—	—
1.5	0.104	—	—	—	—	—	—	—	—	—
2	0.077	0.092	0.109	—	—	—	—	—	—	—
2.5	0.061	0.073	0.086	0.100	—	—	—	—	—	—
3	0.051	0.061	0.071	0.083	0.095	0.109	—	—	—	—
4	0.038	0.045	0.053	0.062	0.071	0.081	0.091	0.103	—	—
5	0.030	0.036	0.042	0.049	0.057	0.064	0.073	0.082	0.091	0.101
6	0.025	0.030	0.035	0.041	0.047	0.054	0.061	0.068	0.076	0.084
8	0.019	0.023	0.026	0.031	0.035	0.040	0.045	0.051	0.057	0.063
10	0.015	0.018	0.021	0.025	0.028	0.032	0.036	0.041	0.045	0.050
12.5	0.012	0.014	0.017	0.020	0.023	0.026	0.029	0.032	0.036	0.040

# TROUBLE SHOOTING FOR DRILLING

Solution		Cutting Conditions							Style and Design of the Tool					Machine, Installation of Tool								
		Cutting speed	Feed	Lower feed at initial cutting	Lower feed when breaking through	Step feed	Increase accuracy of prep-hole and depth	Coolant			Chisel width	Honing width	Core thickness	Shorten flute length	Decrease lip height	Use internal coolant type drill	Change to a drill with X type thinning	Increase tool installation accuracy	Shorten tool overhang	Flat workpiece face	Increase work clamping rigidity	Reduce machine backlash and increase rigidity
								Increase oil ratio	Increase volume	Increase coolant pressure												
Trouble	Factors	Up ↗	Down ↘																			
		Deterioration of Tool Life	Drill breakage	Lack of drill rigidity																		
Improper cutting conditions				●																		
Large deflection of the tool holder																		●				●
Workpiece face is inclined																				●		
Large wear at the peripheral cutting edge and along the land	Improper cutting conditions		●																			
	An increase in temperature at the cutting point						●	●							●							
	Poor run-out accuracy																●					
Chipping of the peripheral cutting edge	Improper cutting conditions		●																			
		Large deflection of the tool holder					●															
Chisel edge chipping	The chisel edge width is too wide																					
		Poor entry																				
		Chattering, vibration																				
Deterioration of Hole Accuracy	Hole diameter increases	Lack of drill rigidity																				
		Improper drill geometry																				
	Hole diameter becomes smaller	An increase in temperature at the cutting point																				
		Improper cutting conditions	●																			
	Poor straightness	Lack of drill rigidity																				
Large deflection of the tool holder																						
Poor hole positioning accuracy, roundness and surface finish	Poor entry	Poor guiding properties																				
		Lack of drill rigidity																				
		Improper cutting conditions																				
Burr	Burr at the hole exit	Large deflection of the tool holder																				
		Improper cutting conditions																				
Poor Chip Dispersal	Long chips	Improper drill geometry																				
		Improper cutting conditions																				
Chip jamming	Chip jamming	Poor chip disposal																				
		Poor chip disposal																				



# DRILL TERMINOLOGY AND CUTTING CHARACTERISTICS

## ■ NAMES OF EACH PART OF A DRILL

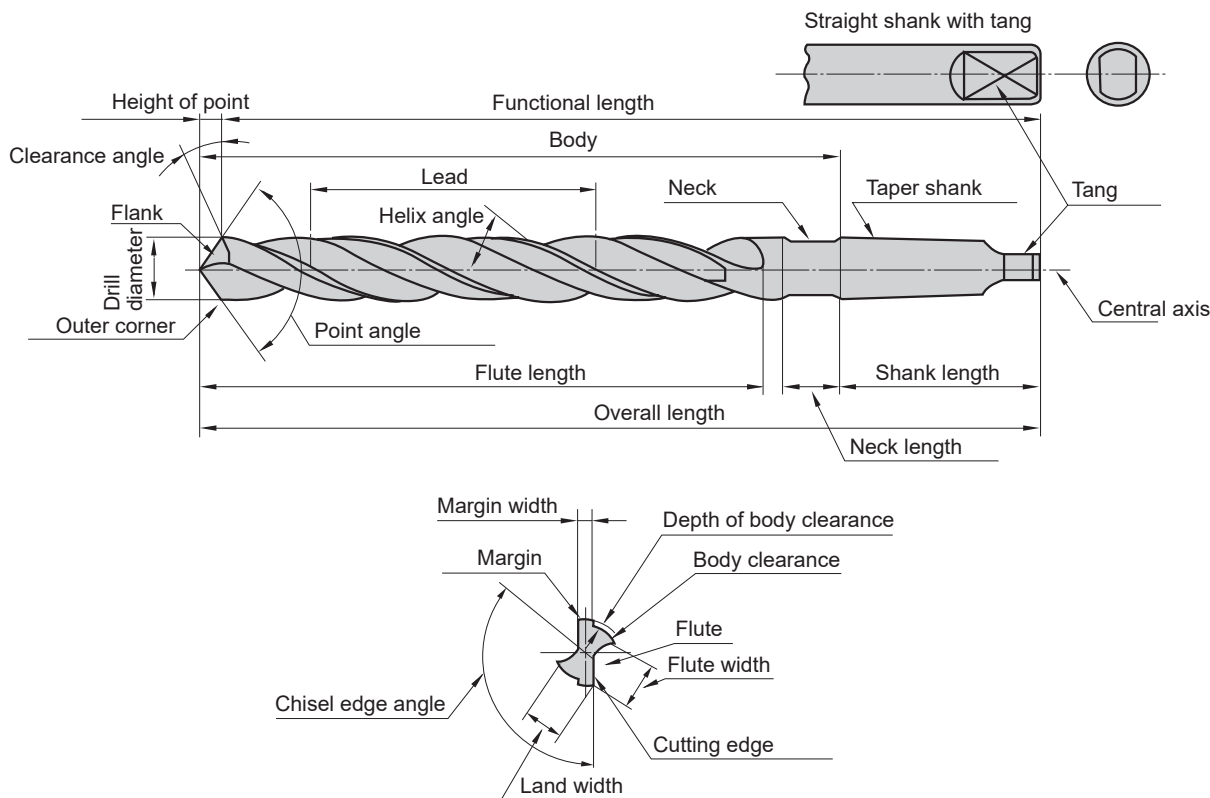

## ■ SHAPE SPECIFICATION AND CUTTING CHARACTERISTICS

Helix Angle	<p>Is the inclination of the flute with respect to the axial direction of a drill, which corresponds to the rake angle of a bit. The rake angle of a drill differs according to the position of the cutting edge, and it decreases greatly as the circumference approaches the centre. The chisel edge has a negative rake angle, crushing the work.</p> <p><b>High-hardness material Small</b> ◀•• <b>Rake angle</b> ••▶ <b>Large Soft material</b> (Aluminium, etc.)</p>
Flute Length	<p>It is determined by depth of hole, bush length, and regrinding allowance. Since the influence on the tool life is great, it is necessary to minimize it as much as possible.</p>
Point Angle	<p>In general, the angle is 118° which is set differently to various applications.</p> <p><b>Soft material with good machinability Small</b> ◀•• <b>Point angle</b> ••▶ <b>Large For hard material and high-efficiency machining</b></p>
Web Thickness	<p>It is an important element that determines the rigidity and chip raking performance of a drill. The web thickness is set according to applications.</p> <p>Small cutting resistance Low rigidity Good chip raking performance Machinable material</p> <p><b>Thin</b> ◀•• <b>Web thickness</b> ••▶ <b>Thick</b></p> <p>Large cutting resistance High rigidity Poor chip raking performance High-hardness material, cross hole drilling, etc.</p>
Margin	<p>The tip determines the drill diameter and functions as a drill guide during drilling. The margin width is determined in consideration of friction during hole drilled.</p> <p><b>Poor guiding performance Small</b> ◀•• <b>Margin width</b> ••▶ <b>Large Good guiding performance</b></p>
Diameter Back Taper	<p>To reduce friction with the inside of the drilled hole, the portion from the tip to the shank is tapered slightly. The degree is usually represented by the quantity of reduction in the diameter with respect to the flute length, which is approx. 0.04—0.1mm. It is set at a larger value for high-efficiency drills and the work material that allows drilled holes.</p>



## ■ CUTTING EDGE GEOMETRY AND ITS INFLUENCE

As shown in the table below, it is possible to select the most suitable cutting edge geometry for different applications. If the most suitable cutting edge geometry is selected then higher machining efficiency and higher hole accuracy can be obtained.

### ● Cutting Edge Shapes

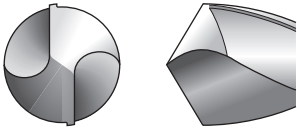
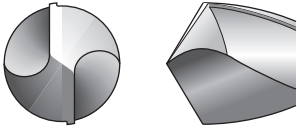
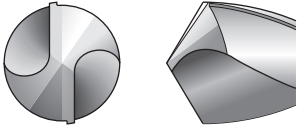
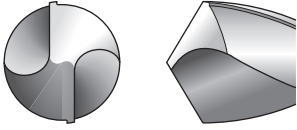
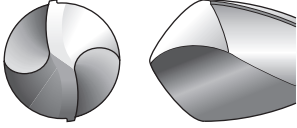
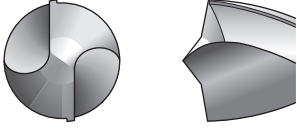
Grinding Name	Shape	Features and Effect	Application
Conical		<ul style="list-style-type: none"> <li>The flank is conical and the clearance angle increases toward the centre of the drill.</li> </ul>	<ul style="list-style-type: none"> <li>General Use</li> </ul>
Flat		<ul style="list-style-type: none"> <li>The flank is flat.</li> <li>Easy grinding.</li> </ul>	<ul style="list-style-type: none"> <li>Mainly for small diameter drills.</li> </ul>
Three Flank Angles		<ul style="list-style-type: none"> <li>As there is no chisel edge, the results are high centripetal force and small hole oversize.</li> <li>Requires a special grinding machine.</li> <li>Surface grinding of three sides.</li> </ul>	<ul style="list-style-type: none"> <li>For drilling operations that require high hole accuracy and positioning accuracy.</li> </ul>
Spiral Point		<ul style="list-style-type: none"> <li>To increase the clearance angle near the centre of the drill, conical grinding combined with irregular helix.</li> <li>S type chisel edge with high centripetal force and machining accuracy.</li> </ul>	<ul style="list-style-type: none"> <li>For drilling that requires high accuracy.</li> </ul>
Radial Lip		<ul style="list-style-type: none"> <li>The cutting edge is ground radial with the aim of dispersing load.</li> <li>High machining accuracy and finished surface roughness.</li> <li>For through holes, small burrs on the base.</li> <li>Requires a special grinding machine.</li> </ul>	<ul style="list-style-type: none"> <li>Cast Iron, Aluminium Alloy</li> <li>For cast iron plates.</li> <li>Steel</li> </ul>
Centre Point Drill		<ul style="list-style-type: none"> <li>This geometry has two-stage point angle for better concentricity and a reduction in shock when exiting the workpiece.</li> </ul>	<ul style="list-style-type: none"> <li>For thin sheet drilling.</li> </ul>



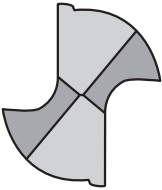
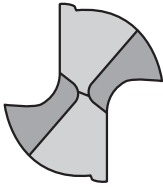
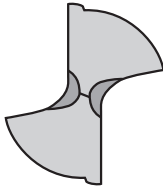
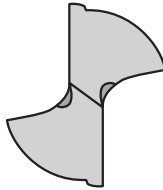

## ■ WEB THINNING

The rake angle of the cutting edge of a drill reduces toward the centre, and it changes into a negative angle at the chisel edge. During drilling, the centre of a drill crushes the work, generating 50–70% of the cutting resistance. Web thinning is very effective for reduction in the cutting resistance of a drill, early removal of cut chips at the chisel edge, and better initial bite.

Shape				
	<b>X type</b>	<b>XR type</b>	<b>S type</b>	<b>N type</b>
Features	The thrust load substantially reduces, and the bite performance improves. This is effective when the web is thick.	The initial performance is slightly inferior to that of the X type, but the cutting edge is hard and the applicable range of work is wide.	Popular design, easy cutting type.	Effective when the web is comparatively thick.
Major Applications	General drilling and deep hole drilling.	Long life. General drilling and stainless steel drilling.	General drilling for steel, cast iron, and non-ferrous metal.	Deep hole drilling.

# DRILL TERMINOLOGY AND CUTTING CHARACTERISTICS

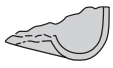
## ■ DRILLING CHIPS

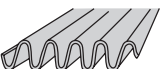
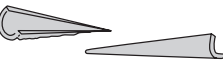
Types of Chips	Shape	Features and Ease of Raking
Conical Spiral		Fan-shaped chips cut by the cutting edge are curved by the flute. Chips of this type are produced when the feeding rate of ductile material is small. If the chip breaks after several turns, the chip raking performance is satisfactory.
Long Pitch		The generated chip comes out without coiling. It will easily coil around the drill.
Fan		This is a chip broken by the restraint caused by the drill flute and the wall of a drilled hole. It is generated when the feed rate is high.
Segment		A conical spiral chip that is broken before the chip grows into the long-pitch shape by the restraint caused by the wall of the drilled hole due to the insufficiency of ductility. Excellent chip disposal and chip discharge.
Zigzag		A chip that is buckled and folded because of the shape of flute and the characteristics of the material. It easily causes chip packing at the flute.
Needle		Chips broken by vibration or broken when brittle material is curled with a small radius. The raking performance is satisfactory, but these chips can pack closely creating.

# DRILL WEAR AND CUTTING EDGE DAMAGE

## ■ DRILL WEAR CONDITION

The table below shows a simple drawing depicting the wear of a drill's cutting edge. The generation and the amount of wear differ according to the workpiece materials and cutting conditions used. But generally, the peripheral wear is largest and determines a drill tool life. When regrinding, the flank wear at the point needs to be ground away completely. Therefore, if there is large wear more material needs to be ground away to renew the cutting edge.

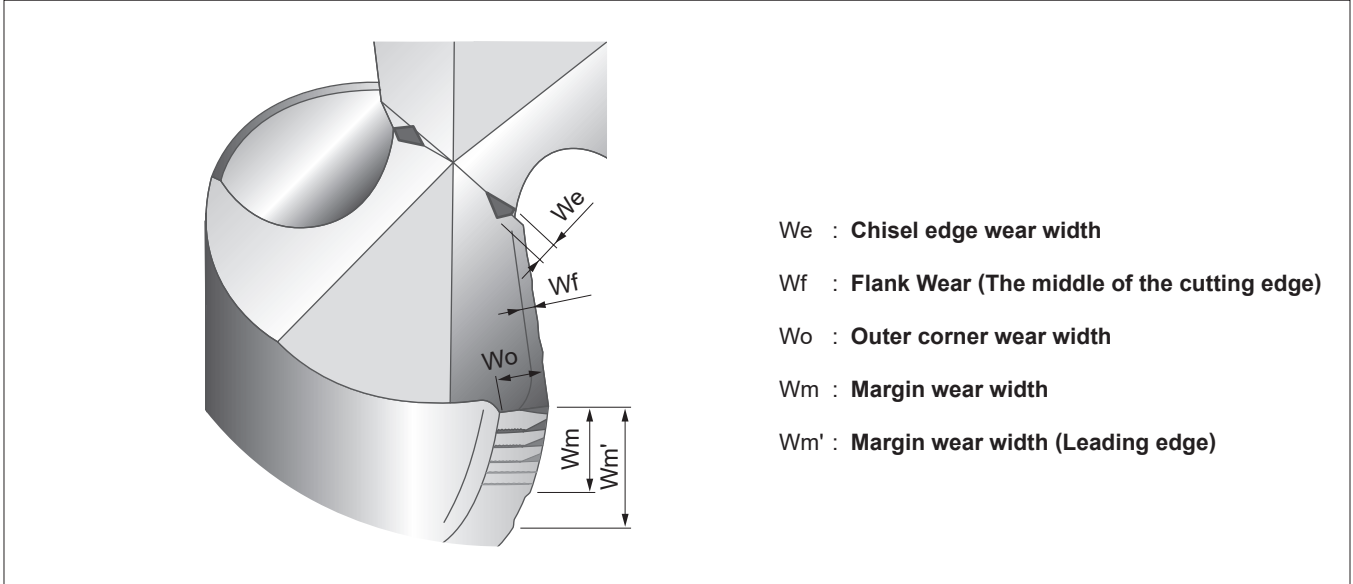

## ■ CUTTING EDGE DAMAGE

When drilling, the cutting edge of the drill can suffer from chipping, fracture and abnormal damage. In such cases, it is important to take a closer look at the damage, investigate the cause and take countermeasures.

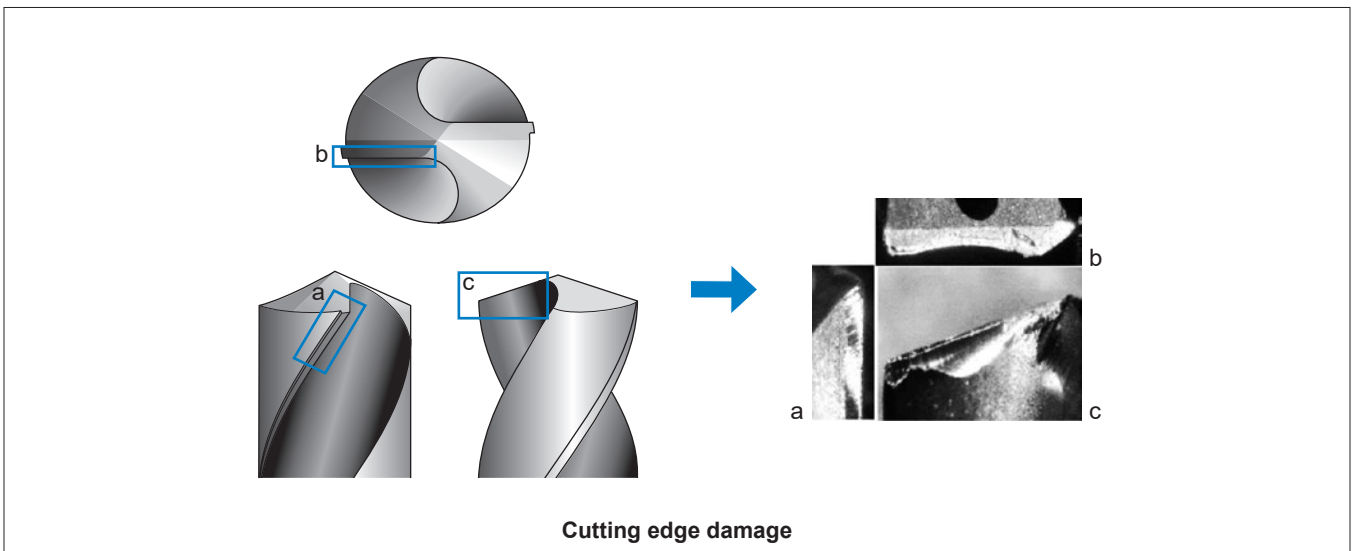

# FORMULAE FOR DRILLING

## ■ CUTTING SPEED (vc)

$$vc = \frac{\pi \cdot DC \cdot n}{1000} \text{ (m/min)}$$

vc (m/min) : Cutting Speed  
 $\pi$  (3.14) : Pi

DC (mm) : Drill Diameter  
 n (min<sup>-1</sup>) : Main Axis Spindle Speed

\*Divide by 1,000 to change to m from mm.

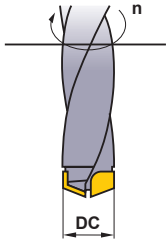

(Problem) What is the cutting speed when main axis spindle speed is 1350min<sup>-1</sup> and drill diameter is 12mm ?

(Answer) Substitute  $\pi=3.14$ , DC=12, n=1350 into the formula

$$vc = \frac{\pi \cdot DC \cdot n}{1000} = \frac{3.14 \times 12 \times 1350}{1000} = 50.9 \text{ m/min}$$

The cutting speed is 50.9m/min.

## ■ FEED OF THE MAIN SPINDLE (vf)

$$vf = fr \cdot n \text{ (mm/min)}$$

vf (mm/min) : Feed Speed of the Main Spindle (Z axis)  
 fr (mm/rev) : Feed per Revolution  
 n (min<sup>-1</sup>) : Main Axis Spindle Speed

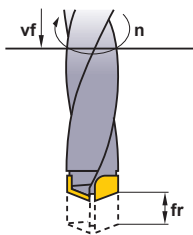

(Problem) What is the spindle feed (vf) when the feed per revolution is 0.2mm/rev and main axis spindle speed is 1350min<sup>-1</sup> ?

(Answer) Substitute fr=0.2, n=1350 into the formula

$$vf = fr \times n = 0.2 \times 1350 = 270 \text{ mm/min}$$

The spindle feed is 270mm/min.

## ■ DRILLING TIME (Tc)

$$Tc = \frac{ld \cdot i}{n \cdot fr}$$

Tc (min) : Drilling Time  
 n (min<sup>-1</sup>) : Spindle Speed  
 ld (mm) : Hole Depth  
 fr (mm/rev) : Feed per Revolution  
 i : Number of Holes

(Problem) What is the drilling time required for drilling a 30mm length hole in alloy steel (JIS SCM440) at a cutting speed of 50m/min and a feed 0.15mm/rev ?

(Answer) Spindle Speed  $n = \frac{50 \times 1000}{15 \times 3.14} = 1061.57 \text{ min}^{-1}$

$$Tc = \frac{30 \times 1}{1061.57 \times 0.15} = 0.188$$

$$= 0.188 \times 60 \approx 11.3 \text{ sec}$$

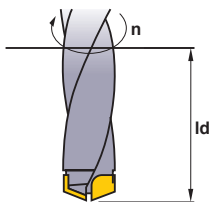

# HEXAGON SOCKET HEAD BOLT HOLE SIZE

## ■ DIMENSIONS OF COUNTERBORING FOR HEXAGON SOCKET HEAD CAP SCREW AND BOLT HOLE

Unit : mm

Nominal dimensions of thread d	M3	M4	M5	M6	M8	M10	M12	M14	M16	M18	M20	M22	M24	M27	M30
<b>d<sub>1</sub></b>	3	4	5	6	8	10	12	14	16	18	20	22	24	27	30
<b>d'</b>	3.4	4.5	5.5	6.6	9	11	14	16	18	20	22	24	26	30	33
<b>D</b>	5.5	7	8.5	10	13	16	18	21	24	27	30	33	36	40	45
<b>D'</b>	6.5	8	9.5	11	14	17.5	20	23	26	29	32	35	39	43	48
<b>H</b>	3	4	5	6	8	10	12	14	16	18	20	22	24	27	30
<b>H'</b>	2.7	3.6	4.6	5.5	7.4	9.2	11	12.8	14.5	16.5	18.5	20.5	22.5	25	28
<b>H''</b>	3.3	4.4	5.4	6.5	8.6	10.8	13	15.2	17.5	19.5	21.5	23.5	25.5	29	32

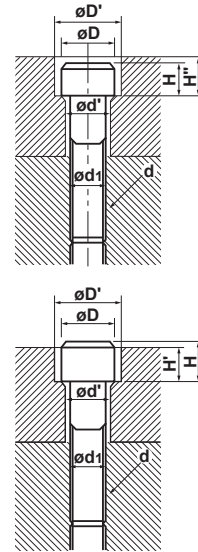

# INTERNATIONAL SYSTEM OF UNITS

## ■ UNIT CONVERSION TABLE for EASIER CHANGE into SI UNITS (Bold type Indicates SI unit)

### ● Pressure

Pa	kPa	MPa	bar	kgf/cm <sup>2</sup>	atm	mmH <sub>2</sub> O	mmHg or Torr
1	1×10 <sup>-3</sup>	1×10 <sup>-6</sup>	1×10 <sup>-5</sup>	1.01972×10 <sup>-5</sup>	9.86923×10 <sup>-6</sup>	1.01972×10 <sup>-1</sup>	7.50062×10 <sup>-3</sup>
1×10 <sup>3</sup>	<b>1</b>	1×10 <sup>-3</sup>	1×10 <sup>-2</sup>	1.01972×10 <sup>-2</sup>	9.86923×10 <sup>-3</sup>	1.01972×10 <sup>2</sup>	7.50062
1×10 <sup>6</sup>	1×10 <sup>3</sup>	<b>1</b>	1×10	1.01972×10	9.86923	1.01972×10 <sup>5</sup>	7.50062×10 <sup>3</sup>
1×10 <sup>5</sup>	1×10 <sup>2</sup>	1×10 <sup>-1</sup>	1	1.01972	9.86923×10 <sup>-1</sup>	1.01972×10 <sup>4</sup>	7.50062×10 <sup>2</sup>
9.80665×10 <sup>4</sup>	9.80665×10	9.80665×10 <sup>-2</sup>	9.80665×10 <sup>-1</sup>	<b>1</b>	9.67841×10 <sup>-1</sup>	1×10 <sup>4</sup>	7.35559×10 <sup>2</sup>
1.01325×10 <sup>5</sup>	1.01325×10 <sup>2</sup>	1.01325×10 <sup>-1</sup>	1.01325	1.03323	<b>1</b>	1.03323×10 <sup>4</sup>	7.60000×10 <sup>2</sup>
9.80665	9.80665×10 <sup>-3</sup>	9.80665×10 <sup>-6</sup>	9.80665×10 <sup>-5</sup>	1×10 <sup>-4</sup>	9.67841×10 <sup>-5</sup>	<b>1</b>	7.35559×10 <sup>-2</sup>
1.33322×10 <sup>2</sup>	1.33322×10 <sup>-1</sup>	1.33322×10 <sup>-4</sup>	1.33322×10 <sup>-3</sup>	1.35951×10 <sup>-3</sup>	1.31579×10 <sup>-3</sup>	1.35951×10	<b>1</b>

Note 1) 1Pa=1N/m<sup>2</sup>

### ● Force

N	dyn	kgf
1	1×10 <sup>5</sup>	1.01972×10 <sup>-1</sup>
1×10 <sup>-5</sup>	<b>1</b>	1.01972×10 <sup>-6</sup>
9.80665	9.80665×10 <sup>5</sup>	<b>1</b>

### ● Stress

Pa	MPa or N/mm <sup>2</sup>	kgf/mm <sup>2</sup>	kgf/cm <sup>2</sup>
1	1×10 <sup>-6</sup>	1.01972×10 <sup>-7</sup>	1.01972×10 <sup>-5</sup>
1×10 <sup>6</sup>	<b>1</b>	1.01972×10 <sup>-1</sup>	1.01972×10
9.80665×10 <sup>6</sup>	9.80665	<b>1</b>	1×10 <sup>2</sup>
9.80665×10 <sup>4</sup>	9.80665×10 <sup>-2</sup>	1×10 <sup>-2</sup>	<b>1</b>

Note 1) 1Pa=1N/m<sup>2</sup>

### ● Work / Energy / Quantity of Heat

J	kW·h	kgf·m	kcal
1	2.77778×10 <sup>-7</sup>	1.01972×10 <sup>-1</sup>	2.38889×10 <sup>-4</sup>
3.600 ×10 <sup>6</sup>	<b>1</b>	3.67098×10 <sup>5</sup>	8.6000 ×10 <sup>2</sup>
9.80665	2.72407×10 <sup>-6</sup>	<b>1</b>	2.34270×10 <sup>-3</sup>
4.18605×10 <sup>3</sup>	1.16279×10 <sup>-3</sup>	4.26858×10 <sup>2</sup>	<b>1</b>

Note 1) 1J=1W·s, 1J=1N·m

1cal=4.18605J

(By the law of weights and measures)

### ● Power (Rate of Production / Motive Power) / Heat Flow Rate

W	kgf·m/s	PS	kcal/h
1	1.01972×10 <sup>-1</sup>	1.35962×10 <sup>-3</sup>	8.6000 ×10 <sup>-1</sup>
9.80665	<b>1</b>	1.33333×10 <sup>-2</sup>	8.43371
7.355 ×10 <sup>2</sup>	7.5 ×10	<b>1</b>	6.32529×10 <sup>2</sup>
1.16279	1.18572×10 <sup>-1</sup>	1.58095×10 <sup>-3</sup>	<b>1</b>

Note 1) 1W=1J/s, PS:French horse power

1PS=0.7355kW

(By the enforcement act for the law of weights and measures)

1cal=4.18605J

# TECHNICAL DATA

## METALLIC MATERIALS CROSS REFERENCE LIST

### ■ CARBON STEEL

Japan	Germany		U.K.		France	Italy	Spain	Sweden	USA	China
JIS	W-nr.	DIN	BS	EN	AFNOR	UNI	UNE	SS	AISI/SAE	GB
STKM 12A STKM 12C	1.0038	RSt.37-2	4360 40 C	–	E 24-2 Ne	–	–	1311	A570.36	15
–	1.0401	C15	080M15	–	CC12	C15, C16	F.111	1350	1015	15
–	1.0402	C22	050A20	2C	CC20	C20, C21	F.112	1450	1020	20
SUM22	1.0715	9SMn28	230M07	1A	S250	CF9SMn28	F.2111 11SMn28	1912	1213	Y15
SUM22L	1.0718	9SMnPb28	–	–	S250Pb	CF9SMnPb28	11SMnPb28	1914	12L13	–
–	1.0722	10SPb20	–	–	10PbF2	CF10Pb20	10SPb20	–	–	–
–	1.0736	9SMn36	240M07	1B	S300	CF9SMn36	12SMn35	–	1215	Y13
–	1.0737	9SMnPb36	–	–	S300Pb	CF9SMnPb36	12SMnP35	1926	12L14	–
S15C	1.1141	Ck15	080M15	32C	XC12	C16	C15K	1370	1015	15
S25C	1.1158	Ck25	–	–	–	–	–	–	1025	25
–	1.8900	StE380	4360 55 E	–	–	FeE390KG	–	2145	A572-60	–
–	1.0501	C35	060A35	–	CC35	C35	F.113	1550	1035	35
–	1.0503	C45	080M46	–	CC45	C45	F.114	1650	1045	45
–	1.0726	35S20	212M36	8M	35MF4	–	F210G	1957	1140	–
–	1.1157	40Mn4	150M36	15	35M5	–	–	–	1039	40Mn
SMn438(H)	1.1167	36Mn5	–	–	40M5	–	36Mn5	2120	1335	35Mn2
SCMn1	1.1170	28Mn6	150M28	14A	20M5	C28Mn	–	–	1330	30Mn
S35C	1.1183	Cf35	060A35	–	XC38TS	C36	–	1572	1035	35Mn
S45C	1.1191	Ck45	080M46	–	XC42	C45	C45K	1672	1045	Ck45
S50C	1.1213	Cf53	060A52	–	XC48TS	C53	–	1674	1050	50
–	1.0535	C55	070M55	9	–	C55	–	1655	1055	55
–	1.0601	C60	080A62	43D	CC55	C60	–	–	1060	60
S55C	1.1203	Ck55	070M55	–	XC55	C50	C55K	–	1055	55
S58C	1.1221	Ck60	080A62	43D	XC60	C60	–	1678	1060	60Mn
–	1.1274	Ck101	060A96	–	XC100	–	F.5117	1870	1095	–
SK3	1.1545	C105W1	BW1A	–	Y105	C36KU	F.5118	1880	W1	–
SUP4	1.1545	C105W1	BW2	–	Y120	C120KU	F.515	2900	W210	–

### ■ ALLOY STEEL

Japan	Germany		U.K.		France	Italy	Spain	Sweden	USA	China
JIS	W-nr.	DIN	BS	EN	AFNOR	UNI	UNE	SS	AISI/SAE	GB
SM400A, SM400B SM400C	1.0144	St.44.2	4360 43 C	–	E28-3	–	–	1412	A573-81	–
SM490A, SM490B SM490C	1.0570	St52-3	4360 50 B	–	E36-3	Fe52BFN Fe52CFN	–	2132	–	–
–	1.0841	St52-3	150M19	–	20MC5	Fe52	F.431	2172	5120	–
–	1.0904	55Si7	250A53	45	55S7	55Si8	56Si7	2085	9255	55Si2Mn
–	1.0961	60SiCr7	–	–	60SC7	60SiCr8	60SiCr8	–	9262	–
SUJ2	1.3505	100Cr6	534A99	31	100C6	100Cr6	F.131	2258	ASTM 52100	GCr15
–	1.5415	15Mo3	1501-240	–	15D3	16Mo3KW	16Mo3	2912	ASTM A204Gr.A	–
–	1.5423	16Mo5	1503-245-420	–	–	16Mo5	16Mo5	–	4520	–
–	1.5622	14Ni6	–	–	16N6	14Ni6	15Ni6	–	ASTM A350LF5	–
–	1.5662	X8Ni9	1501-509-510	–	–	X10Ni9	XBNI09	–	ASTM A353	–
SNC236	1.5710	36NiCr6	640A35	111A	35NC6	–	–	–	3135	–
SNC415(H)	1.5732	14NiCr10	–	–	14NC11	16NiCr11	15NiCr11	–	3415	–
SNC815(H)	1.5752	14NiCr14	655M13	36A	12NC15	–	–	–	3415, 3310	–
SNCM220(H)	1.6523	21NiCrMo2	805M20	362	20NCD2	20NiCrMo2	20NiCrMo2	2506	8620	–
SNCM240	1.6546	40NiCrMo22	311-Type 7	–	–	40NiCrMo2(KB)	40NiCrMo2	–	8740	–
–	1.6587	17CrNiMo6	820A16	–	18NCD6	–	14NiCrMo13	–	–	–
SCr415(H)	1.7015	15Cr3	523M15	–	12C3	–	–	–	5015	15Cr

Japan	Germany		U.K.		France	Italy	Spain	Sweden	USA	China
JIS	W-nr.	DIN	BS	EN	AFNOR	UNI	UNE	SS	AISI/SAE	GB
SCr440	1.7045	42Cr4	–	–	–	–	42Cr4	2245	5140	40Cr
SUP9(A)	1.7176	55Cr3	527A60	48	55C3	–	–	–	5155	20CrMn
SCM415(H)	1.7262	15CrMo5	–	–	12CD4	–	12CrMo4	2216	–	–
–	1.7335	13CrMo4 4	1501-620Gr27	–	15CD3.5 15CD4.5	14CrMo45	14CrMo45	–	ASTM A182 F11, F12	–
–	1.7380	10CrMo910	1501-622 Gr31, 45	–	12CD9 12CD10	12CrMo9 12CrMo10	TU.H	2218	ASTM A182 F.22	–
–	1.7715	14MoV63	1503-660-440	–	–	–	13MoCrV6	–	–	–
–	1.8523	39CrMoV13 9	897M39	40C	–	36CrMoV12	–	–	–	–
–	1.6511	36CrNiMo4	816M40	110	40NCD3	38NiCrMo4(KB)	35NiCrMo4	–	9840	–
–	1.6582	34CrNiMo6	817M40	24	35NCD6	35NiCrMo6(KB)	–	2541	4340	40CrNiMoA
SCr430(H)	1.7033	34Cr4	530A32	18B	32C4	34Cr4(KB)	35Cr4	–	5132	35Cr
SCr440(H)	1.7035	41Cr4	530M40	18	42C4	41Cr4	42Cr4	–	5140	40Cr
–	1.7131	16MnCr5	(527M20)	–	16MC5	16MnCr5	16MnCr5	2511	5115	18CrMn
SCM420 SCM430	1.7218	25CrMo4	1717CDS110 708M20	–	25CD4	25CrMo4(KB)	55Cr3	2225	4130	30CrMn
SCM432 SCCRM3	1.7220	34CrMo4	708A37	19B	35CD4	35CrMo4	34CrMo4	2234	4137 4135	35CrMo
SCM 440	1.7223	41CrMo4	708M40	19A	42CD4TS	41CrMo4	42CrMo4	2244	4140 4142	40CrMoA
SCM440(H)	1.7225	42CrMo4	708M40	19A	42CD4	42CrMo4	42CrMo4	2244	4140	42CrMo 42CrMnMo
–	1.7361	32CrMo12	722M24	40B	30CD12	32CrMo12	F.124.A	2240	–	–
SUP10	1.8159	50CrV4	735A50	47	50CV4	50CrV4	51CrV4	2230	6150	50CrVA
–	1.8509	41CrAlMo7	905M39	41B	40CAD6 40CAD2	41CrAlMo7	41CrAlMo7	2940	–	–
–	1.2067	100Cr6	BL3	–	Y100C6	–	100Cr6	–	L3	CrV, 9SiCr
SKS31 SKS2, SKS3	1.2419	105WCr6	–	–	105WC13	100WCr6 107WCr5KU	105WCr5	2140	–	CrWMo
SKT4	1.2713	55NiCrMoV6	BH224/5	–	55NCDV7	–	F.520.S	–	L6	5CrNiMo
–	1.5662	X8Ni9	1501-509	–	–	X10Ni9	XBNi09	–	ASTM A353	–
–	1.5680	12Ni19	–	–	Z18N5	–	–	–	2515	–
–	1.6657	14NiCrMo134	832M13	36C	–	15NiCrMo13	14NiCrMo131	–	–	–
SKD1	1.2080	X210Cr12	BD3	–	Z200C12	X210Cr13KU X250Cr12KU	X210Cr12	–	D3 ASTM D3	Cr12
SKD11	1.2601	X153CrMoV12	BD2	–	–	X160CrMoV12	–	–	D2	Cr12MoV
SKD12	1.2363	X100CrMoV5	BA2	–	Z100CDV5	X100CrMoV5	F.5227	2260	A2	Cr5Mo1V
SKD61	1.2344	X40CrMoV51 X40CrMoV51	BH13	–	Z40CDV5	X35CrMoV05KU X40CrMoV51KU	X40CrMoV5	2242	H13 ASTM H13	40CrMoV5
SKD2	1.2436	X210CrW12	–	–	–	X215CrW121KU	X210CrW12	2312	–	–
–	1.2542	45WCrV7	BS1	–	–	45WCrV8KU	45WCrSi8	2710	S1	–
SKD5	1.2581	X30WCrV93	BH21	–	Z30WCV9	X28W09KU	X30WCrV9	–	H21	30WCrV9
–	1.2601	X165CrMoV12	–	–	–	X165CrMoW12KU	X160CrMoV12	2310	–	–
SKS43	1.2833	100V1	BW2	–	Y1105V	–	–	–	W210	V
SKH3	1.3255	S 18-1-2-5	BT4	–	Z80WKCV	X78WCo1805KU	HS18-1-1-5	–	T4	W18Cr4VCo5
SKH2	1.3355	S 18-0-1	BT1	–	Z80WCV	X75W18KU	HS18-0-1	–	T1	–
SCMnH/1	1.3401	G-X120Mn12	Z120M12	–	Z120M12	XG120Mn12	X120MN12	–	–	–
SUH1	1.4718	X45CrSi93	401S45	52	Z45CS9	X45CrSi8	F.322	–	HW3	X45CrSi93
SUH3	1.3343	S6-5-2	4959BA2	–	Z40CSD10	15NiCrMo13	–	2715	D3	–
SKH9, SKH51	1.3343	S6/5/2	BM2	–	Z85WDCV	HS6-5-2-2	F.5603	2722	M2	–
–	1.3348	S 2-9-2	–	–	–	HS2-9-2	HS2-9-2	2782	M7	–
SKH55	1.3243	S6/5/2/5	BM35	–	6-5-2-5	HS6-5-2-5	F.5613	2723	M35	–



# TECHNICAL DATA

## METALLIC MATERIALS CROSS REFERENCE LIST

### ■ STAINLESS STEEL (FERRITIC, MARTENSITIC)

Japan	Germany		U.K.		France	Italy	Spain	Sweden	USA	China
JIS	W-nr.	DIN	BS	EN	AFNOR	UNI	UNE	SS	AISI/SAE	GB
SUS403	1.4000	X7Cr13	403S17	–	Z6C13	X6Cr13	F.3110	2301	403	0Cr13 1Cr12
–	1.4001	X7Cr14	–	–	–	–	F.8401	–	–	–
SUS416	1.4005	X12CrS13	416S21	–	Z11CF13	X12CrS13	F.3411	2380	416	–
SUS410	1.4006	X10Cr13	410S21	56A	Z10C14	X12Cr13	F.3401	2302	410	1Cr13
SUS430	1.4016	X8Cr17	430S15	60	Z8C17	X8Cr17	F.3113	2320	430	1Cr17
SCS2	1.4027	G-X20Cr14	420C29	56B	Z20C13M	–	–	–	–	–
SUS420J2	1.4034	X46Cr13	420S45	56D	Z40CM Z38C13M	X40Cr14	F.3405	2304	–	4Cr13
–	1.4003	–	405S17	–	Z8CA12	X6CrAl13	–	–	405	–
–	1.4021	–	420S37	–	Z8CA12	X20Cr13	–	2303	420	–
SUS431	1.4057	X22CrNi17	431S29	57	Z15CNi6.02	X16CrNi16	F.3427	2321	431	1Cr17Ni2
SUS430F	1.4104	X12CrMoS17	–	–	Z10CF17	X10CrS17	F.3117	2383	430F	Y1Cr17
SUS434	1.4113	X6CrMo17	434S17	–	Z8CD17.01	X8CrMo17	–	2325	434	1Cr17Mo
SCS5	1.4313	X5CrNi134	425C11	–	Z4CND13.4M	(G)X6CrNi304	–	2385	CA6-NM	–
SUS405	1.4724	X10CrA113	403S17	–	Z10C13	X10CrA112	F.311	–	405	0Cr13Al
SUS430	1.4742	X10CrA118	430S15	60	Z10CAS18	X8Cr17	F.3113	–	430	Cr17
SUH4	1.4747	X80CrNiSi20	443S65	59	Z80CSN20.02	X80CrSiNi20	F.320B	–	HNV6	–
SUH446	1.4762	X10CrA124	–	–	Z10CAS24	X16Cr26	–	2322	446	2Cr25N
SUH35	1.4871	X53CrMnNiN219	349S54	–	Z52CMN21.09	X53CrMnNiN219	–	–	EV8	5Cr2Mn9Ni4N
–	1.4521	X1CrMoTi182	–	–	–	–	–	2326	S44400	–
–	1.4922	X20CrMoV12-1	–	–	–	X20CrMoNi1201	–	2317	–	–
–	1.4542	–	–	–	Z7CNU17-04	–	–	–	630	–

### ■ STAINLESS STEEL (AUSTENITIC)

Japan	Germany		U.K.		France	Italy	Spain	Sweden	USA	China
JIS	W-nr.	DIN	BS	EN	AFNOR	UNI	UNE	SS	AISI/SAE	GB
SUS304L	1.4306	X2CrNi1911	304S11	–	Z2CN18.10	X2CrNi18.11	–	2352	304L	0Cr19Ni10
SUS304	1.4350	X5CrNi189	304S11	58E	Z6CN18.09	X5CrNi1810	F.3551 F.3541 F.3504	2332	304	0Cr18Ni9
SUS303	1.4305	X12CrNiS188	303S21	58M	Z10CNF18.09	X10CrNiS18.09	F.3508	2346	303	1Cr18Ni9MoZr
SUS304L	–	–	304C12	–	Z3CN19.10	–	–	2333	–	–
SCS19	1.4306	X2CrNi189	304S12	–	Z2CrNi1810	X2CrNi18.11	F.3503	2352	304L	–
SUS301	1.4310	X12CrNi177	–	–	Z12CN17.07	X12CrNi1707	F.3517	2331	301	Cr17Ni7
SUS304LN	1.4311	X2CrNiN1810	304S62	–	Z2CN18.10	–	–	2371	304LN	–
SUS316	1.4401	X5CrNiMo1810	316S16	58J	Z6CND17.11	X5CrNiMo1712	F.3543	2347	316	0Cr17Ni11Mo2
SCS13	1.4308	G-X6CrNi189	304C15	–	Z6CN18.10M	–	–	–	–	–
SCS14	1.4408	G-X6CrNiMo1810	316C16	–	–	–	F.8414	–	–	–
SCS22	1.4581	G-X5CrNiMoNb1810	318C17	–	Z4CNDNb1812M	XG8CrNiMo1811	–	–	–	–
SUS316LN	1.4429	X2CrNiMoN1813	–	–	Z2CND17.13	–	–	2375	316LN	0Cr17Ni13Mo
–	1.4404	–	316S13	–	Z2CND17.12	X2CrNiMo1712	–	2348	316L	–
SCS16	1.4435	X2CrNiMo1812	316S13	–	Z2CND17.12	X2CrNiMo1712	–	2353	316L	0Cr27Ni12Mo3
SUS316L	–	–	316S13	–	Z6CND18-12-03	X8CrNiMo1713	–	2343, 2347	316	–
SUS317L	1.4438	X2CrNiMo1816	317S12	–	Z2CND19.15	X2CrNiMo1816	–	2367	317L	00Cr19Ni13Mo
–	1.4539	X1NiCrMo	–	–	Z6CNT18.10	–	–	2562	UNS V 0890A	–
SUS321	1.4541	X10CrNiTi189	321S12	58B	Z6CNT18.10	X6CrNiTi1811	F.3553 F.3523	2337	321	1Cr18Ni9Ti
SUS347	1.4550	X10CrNiNb189	347S17	58F	Z6CNNb18.10	X6CrNiNb1811	F.3552 F.3524	2338	347	1Cr18Ni11Nb
–	1.4571	X10CrNiMoTi1810	320S17	58J	Z6CNDT17.12	X6CrNiMoTi1712	F.3535	2350	316Ti	Cr18Ni12Mo2T
–	1.4583	X10CrNiMoNb1812	–	–	Z6CNDNb1713B	X6CrNiMoNb1713	–	–	318	Cr17Ni12Mo3Mb



Japan	Germany		U.K.		France	Italy	Spain	Sweden	USA	China
JIS	W-nr.	DIN	BS	EN	AFNOR	UNI	UNE	SS	AISI/SAE	GB
SUH309	1.4828	X15CrNiSi2012	309S24	–	Z15CNS20.12	X6CrNi2520	–	–	309	1Cr23Ni13
SUH310	1.4845	X12CrNi2521	310S24	–	Z12CN2520	X6CrNi2520	F.331	2361	310S	OCr25Ni20
SCS17	1.4406	X10CrNi18.08	–	58C	Z1NCDU25.20	–	F.8414	2370	308	–
–	1.4418	X4CrNiMo165	–	–	Z6CND16-04-01	–	–	–	–	–
–	1.4568 1.4504	–	316S111	–	Z8CNA17-07	X2CrNiMo1712	–	–	17-7PH	–
–	1.4563	–	–	–	Z1NCDU31-27-03 Z1CNDU20-18-06AZ	–	–	2584 2378	NO8028 S31254	–
SUS321	1.4878	X12CrNiTi189	321S32	58B, 58C	Z6CNT18.12B	X6CrNiTi18 11	F.3523	–	321	1Cr18Ni9Ti

## HEAT RESISTANT STEELS

Japan	Germany		U.K.		France	Italy	Spain	Sweden	USA	China
JIS	W-nr.	DIN	BS	EN	AFNOR	UNI	UNE	SS	AISI/SAE	GB
SUH330	1.4864	X12NiCrSi3616	–	–	Z12NCS35.16	–	–	–	330	–
SCH15	1.4865	G-X40NiCrSi3818	330C11	–	–	XG50NiCr3919	–	–	HT, HT 50	–

## GRAY CAST IRON

Japan	Germany		U.K.		France	Italy	Spain	Sweden	USA	China
JIS	W-nr.	DIN	BS	EN	AFNOR	UNI	UNE	SS	AISI/SAE	GB
–	–	–	–	–	–	–	–	0100	–	–
FC100	–	GG 10	–	–	Ft 10 D	–	–	0110	No 20 B	–
FC150	0.6015	GG 15	Grade 150	–	Ft 15 D	G15	FG15	0115	No 25 B	HT150
FC200	0.6020	GG 20	Grade 220	–	Ft 20 D	G20	–	0120	No 30 B	HT200
FC250	0.6025	GG 25	Grade 260	–	Ft 25 D	G25	FG25	0125	No 35 B	HT250
–	–	–	–	–	–	–	–	–	No 40 B	–
FC300	0.6030	GG 30	Grade 300	–	Ft 30 D	G30	FG30	0130	No 45 B	HT300
FC350	0.6035	GG 35	Grade 350	–	Ft 35 D	G35	FG35	0135	No 50 B	HT350
–	0.6040	GG 40	Grade 400	–	Ft 40 D	–	–	0140	No 55 B	HT400
–	0.6660	GGL NiCr202	L-NiCuCr202	–	L-NC 202	–	–	0523	A436 Type 2	–

## DUCTILE CAST IRON

Japan	Germany		U.K.		France	Italy	Spain	Sweden	USA	China
JIS	W-nr.	DIN	BS	EN	AFNOR	UNI	UNE	SS	AISI/SAE	GB
FCD400	0.7040	GGG 40	SNG 420/12	–	FCS 400-12	GS 370-17	FGE 38-17	07 17-02	60-40-18	QT400-18
–	–	GGG 40.3	SNG 370/17	–	FGS 370-17	–	–	07 17-12	–	–
–	0.7033	GGG 35.3	–	–	–	–	–	07 17-15	–	–
FCD500	0.7050	GGG 50	SNG 500/7	–	FGS 500-7	GS 500	FGE 50-7	07 27-02	80-55-06	QT500-7
–	0.7660	GGG NiCr202	Grade S6	–	S-NC202	–	–	07 76	A43D2	–
–	–	GGG NiMn137	L-NiMn 137	–	L-MN 137	–	–	07 72	–	–
FCD600	–	GGG 60	SNG 600/3	–	FGS 600-3	–	–	07 32-03	–	QT600-3
FCD700	0.7070	GGG 70	SNG 700/2	–	FGS 700-2	GS 700-2	FGS 70-2	07 37-01	100-70-03	QT700-18

## MALLEABLE CAST IRON

Japan	Germany		U.K.		France	Italy	Spain	Sweden	USA	China
JIS	W-nr.	DIN	BS	EN	AFNOR	UNI	UNE	SS	AISI/SAE	GB
FCMB310	–	–	8 290/6	–	MN 32-8	–	–	08 14	–	–
FCMW330	–	GTS-35	B 340/12	–	MN 35-10	–	–	08 15	32510	–
FCMW370	0.8145	GTS-45	P 440/7	–	Mn 450	GMN45	–	08 52	40010	–
FCMP490	0.8155	GTS-55	P 510/4	–	MP 50-5	GMN55	–	08 54	50005	–
FCMP540	–	GTS-65	P 570/3	–	MP 60-3	–	–	08 58	70003	–
FCMP590	0.8165	GTS-65-02	P 570/3	–	Mn 650-3	GMN 65	–	08 56	A220-70003	–
FCMP690	–	GTS-70-02	P 690/2	–	Mn 700-2	GMN 70	–	08 62	A220-80002	–

# DIE STEELS

Classification	JIS (Others)	Aichi Steel Works	Uddeholm	Kobe Steel, Ltd.	Sumitomo Metal Industries, Ltd.	Daido Steel Co., Ltd.	Nippon Koshuha	Hitachi Metals, Ltd.	Mitsubishi Steel Manufacturing Co., Ltd.
Carbon Steel for Machine Structure	S50C	AUK1		KTSM2A	SD10	PDS1	KPM1		MT50C
	I			KTSM21	SD17	PXZ			
	S55C			KTSM22	SD21				
Alloy Steel for Machine Structure	SCM440	AUK11		KTSM3A	SD61	PDS3			
	I SCM445		HOLDAX	KTSM31					
Carbon Tool Steel	SK3	SK3				YK3	K3	YC3	
Alloy Tool Steel (For Cold Working)	SKS3	SKS3				GOA	KS3	SGT	
	SKS31					GO31	K31		
	SKS93	SK301				YK30	K3M	YCS3	
	SKD1						KD1	CRD	
	SKD11	SKD11		KAD181		DC11	KD11	SLD	
	SKD11	AUD11				DC3	KD11V	SLD2	
	SKD11						KDQ		
	SKD12		RIGOR			DC12	KD12	SCD	
		SX4							
		SX44						FH5	
		SX105V							
		TCD							
							DC53	KD21	SLD8
							PD613		
	Alloy Tool Steel (For Cold Working and Others)	(P20)		IMPAX	KTSM3M		PX5	KPM30	HPM2
(P20)				KTSM40EF		NAK55	KAP	HPM7	
(P21)				KTSM40E		NAK80	KAP2	HPM1	
						GLD2		HPM50	
Alloy Tool Steel (For Hot Working)	SKD4					DH4	KD4	YDC	
	SKD5					DH5	KD5	HDC	
	SKD6					DH6	KD6		
	SKD61	SKD61	Over M Suprem			DHA1	KDA	DAC	
	SKD61						MFA		
	SKD62	SKD62				DH62	KDB	DBC	
	SKT4					GFA	KTV	DM	
	SKD7					DH72	KDH1	YEM	
	(H10)					DH73			
	SKD8					DH41	KDF	MDC	
				QRO80M					
									YHD40
						DH71			
						DH42			
						DH21			
							KDW		
							KDHM		
							AE31		
								YEM4	
								YHD50	
SKT4	SKT4A							YHD26	
6F4	MPH								
SKT4									
						DH31	KDA1	DAC3	
							KDA5	DAC10	
								DAC40	
								DAC45	
						GF78		DAC55	
						DH76			
						DH2F	TD3	FDAC	
							KDAS	YHD3	
								MDC-K	
								YEM-K	

Classification	JIS (Others)	Aichi Steel Works	Uddeholm	Kobe Steel, Ltd.	Sumitomo Metal Industries, Ltd.	Daido Steel Co., Ltd.	Nippon Koshuha	Hitachi Metals, Ltd.	Mitsubishi Steel Manufacturing Co., Ltd.
High-speed Tool Steel	SKH51					MH51	H51	YXM1	
	SKH55					MH55	HM35	YXM4	
	SKH57					MH57	MV10	XVC5	
						MH8	NK4	YXM60	
						MH24			
						MH7V1			
						MH64			
						VH54	HV2	XVC11	
							HM3	YXM7	
						MH85	KDMV	YXR3	
						MH88	HM9TL	YXR4	
							YXR7		
							YXR35		
Powder High-speed Tool Steel			ASP23	KHA32		DEX20		HAP10	
			ASP30	KHA30		DEX40		HAP40	
				KHA3VN		DEX60		HAP50	
				KHA30N		DEX70		HAP63	
				KHA33N		DEX80		HAP72	
				KHA50					
				KHA77					
			ASP60	KHA60					
Stainless Steel	SUS403					GLD1			
	SUS420		STAVAX			S-STAR	KSP1	HPM38	
	SUS440C		ELMAX (Powder)	KAS440 (Powder)		SUS440C	KSP3		
	SUS420							SUS420	
	SUS630					NAK101	U630	PSL	
	(414)								
Maraging Steel						MAS1C	KMS18-20	YAG	DMG300
Heat Resistant Alloy								HRNC	

# SURFACE ROUGHNESS

## SURFACE ROUGHNESS

(From JIS B 0601-1994)

Type	Code	Determination	Determination Example (Figure)
Arithmetical Mean Roughness	Ra	<p>Ra means the value obtained by the following formula and expressed in micrometer (<math>\mu\text{m}</math>) when sampling only the reference length from the roughness curve in the direction of the mean line, taking X-axis in the direction of mean line and Y-axis in the direction of longitudinal magnification of this sampled part and the roughness curve is expressed by <math>y=f(x)</math>:</p> $Ra = \frac{1}{l} \int_0^l  f(x)  dx$	
Maximum Height	Rz	<p>Rz shall be that only when the reference length is sampled from the roughness curve in the direction of the mean line, the distance between the top profile peak line and the bottom profile valley line on this sampled portion is measured in the longitudinal magnification direction of roughness curve and the obtained value is expressed in micrometer (<math>\mu\text{m}</math>).</p> <p>Note) When finding Rz, a portion without an exceptionally high peak or low valley, which may be regarded as a flaw, is selected as the sampling length.</p> $Rz = Rp + Rv$	
Ten-Point Mean Roughness	RzJIS	<p>RzJIS shall be that only when the reference length is sampled from the roughness curve in the direction of its mean line, the sum of the average value of absolute values of the heights of five highest profile peaks (Yp) and the depths of five deepest profile valleys (Yv) measured in the vertical magnification direction from the mean line of this sampled portion and this sum is expressed in micrometer (<math>\mu\text{m}</math>).</p> $Rz_{JIS} = \frac{(Yp1+Yp2+Yp3+Yp4+Yp5) + (Yv1+Yv2+Yv3+Yv4+Yv5)}{5}$	<p><math>Yp1, Yp2, Yp3, Yp4, Yp5</math> : altitudes of the five highest profile peaks of the sampled portion corresponding to the reference length l.</p> <p><math>Yv1, Yv2, Yv3, Yv4, Yv5</math> : altitudes of the five deepest profile valleys of the sampled portion corresponding to the reference length l.</p>

### RELATIONSHIP BETWEEN ARITHMETICAL MEAN (Ra) AND CONVENTIONAL DESIGNATION (REFERENCE DATA)

Arithmetical Mean Roughness Ra		Max. Height Rz	Ten-Point Mean Roughness RzJIS	Sampling Length for Rz • RzJIS l (mm)	Conventional Finish Mark
Standard Series	Cutoff Value $\lambda_c$ (mm)	Standard Series			
0.012 a	0.08	0.05s	0.05z	0.08	▽▽▽▽
0.025 a		0.1 s	0.1 z		
0.05 a	0.25	0.2 s	0.2 z	0.25	
0.1 a		0.4 s	0.4 z		
0.2 a		0.8 s	0.8 z		
0.4 a	0.8	1.6 s	1.6 z	0.8	▽▽▽
0.8 a		3.2 s	3.2 z		
1.6 a	2.5	6.3 s	6.3 z	2.5	▽▽
3.2 a		12.5 s	12.5 z		
6.3 a		25 s	25 z		
12.5 a	8	50 s	50 z	8	▽
25 a		100 s	100 z		
50 a	—	200 s	200 z	—	—
100 a		400 s	400 z		

\*The correlation among the three is shown for convenience and is not exact.

\*Ra: The evaluation length of Rz and RzJIS is the cutoff value and sampling length multiplied by 5, respectively.

# HARDNESS COMPARISON TABLE

## HARDNESS CONVERSION NUMBERS OF STEEL

Brinell Hardness (HB) 10mm Ball, Load: 3,000 kgf		Vickers Hardness	Rockwell Hardness				Shore Hardness	Tensile Strength (Approx.) Mpa	Brinell Hardness (HB) 10mm Ball, Load: 3,000 kgf		Vickers Hardness	Rockwell Hardness				Shore Hardness	Tensile Strength (Approx.) Mpa
Standard Ball	Tungsten Carbide Ball		A Scale, Load:60kgf, Diamond Point	B Scale, Load:100kgf, 1/16" Ball	C Scale, Load:150kgf, Diamond Point	D Scale, Load:100kgf, Diamond Point			Standard Ball	Tungsten Carbide Ball		A Scale, Load:60kgf, Diamond Point	B Scale, Load:100kgf, 1/16" Ball	C Scale, Load:150kgf, Diamond Point	D Scale, Load:100kgf, Diamond Point		
		(HV)	(HRA)	(HRB)	(HRC)	(HRD)	(HS)			(HV)	(HRA)	(HRB)	(HRC)	(HRD)	(HS)		
—	—	940	85.6	—	68.0	76.9	97	—	429	429	455	73.4	—	45.7	59.7	61	1510
—	—	920	85.3	—	67.5	76.5	96	—	415	415	440	72.8	—	44.5	58.8	59	1460
—	—	900	85.0	—	67.0	76.1	95	—	401	401	425	72.0	—	43.1	57.8	58	1390
—	(767)	880	84.7	—	66.4	75.7	93	—	388	388	410	71.4	—	41.8	56.8	56	1330
—	(757)	860	84.4	—	65.9	75.3	92	—	375	375	396	70.6	—	40.4	55.7	54	1270
—	(745)	840	84.1	—	65.3	74.8	91	—	363	363	383	70.0	—	39.1	54.6	52	1220
—	(733)	820	83.8	—	64.7	74.3	90	—	352	352	372	69.3	(110.0)	37.9	53.8	51	1180
—	(722)	800	83.4	—	64.0	73.8	88	—	341	341	360	68.7	(109.0)	36.6	52.8	50	1130
—	(712)	—	—	—	—	—	—	—	331	331	350	68.1	(108.5)	35.5	51.9	48	1095
—	(710)	780	83.0	—	63.3	73.3	87	—	321	321	339	67.5	(108.0)	34.3	51.0	47	1060
—	(698)	760	82.6	—	62.5	72.6	86	—	—	—	—	—	—	—	—	—	—
—	(684)	740	82.2	—	61.8	72.1	—	—	311	311	328	66.9	(107.5)	33.1	50.0	46	1025
—	(682)	737	82.2	—	61.7	72.0	84	—	302	302	319	66.3	(107.0)	32.1	49.3	45	1005
—	(670)	720	81.8	—	61.0	71.5	83	—	293	293	309	65.7	(106.0)	30.9	48.3	43	970
—	(656)	700	81.3	—	60.1	70.8	—	—	285	285	301	65.3	(105.5)	29.9	47.6	—	950
—	(653)	697	81.2	—	60.0	70.7	81	—	277	277	292	64.6	(104.5)	28.8	46.7	41	925
—	(647)	690	81.1	—	59.7	70.5	—	—	269	269	284	64.1	(104.0)	27.6	45.9	40	895
—	(638)	680	80.8	—	59.2	70.1	80	—	262	262	276	63.6	(103.0)	26.6	45.0	39	875
—	630	670	80.6	—	58.8	69.8	—	—	255	255	269	63.0	(102.0)	25.4	44.2	38	850
—	627	667	80.5	—	58.7	69.7	79	—	248	248	261	62.5	(101.0)	24.2	43.2	37	825
—	—	677	80.7	—	59.1	70.0	—	—	241	241	253	61.8	100	22.8	42.0	36	800
—	601	640	79.8	—	57.3	68.7	77	—	235	235	247	61.4	99.0	21.7	41.4	35	785
—	—	640	79.8	—	57.3	68.7	—	—	229	229	241	60.8	98.2	20.5	40.5	34	765
—	578	615	79.1	—	56.0	67.7	75	—	223	223	234	—	97.3	(18.8)	—	—	—
—	—	607	78.8	—	55.6	67.4	—	—	217	217	228	—	96.4	(17.5)	—	33	725
—	555	591	78.4	—	54.7	66.7	73	2055	212	212	222	—	95.5	(16.0)	—	—	705
—	—	607	78.8	—	55.6	67.4	—	—	207	207	218	—	94.6	(15.2)	—	32	690
—	534	569	77.8	—	53.5	65.8	71	1985	201	201	212	—	93.8	(13.8)	—	31	675
—	—	579	78.0	—	54.0	66.1	—	2015	197	197	207	—	92.8	(12.7)	—	30	655
—	534	569	77.8	—	53.5	65.8	71	1985	192	192	202	—	91.9	(11.5)	—	29	640
—	—	533	77.1	—	52.5	65.0	—	1915	187	187	196	—	90.7	(10.0)	—	—	620
—	514	547	76.9	—	52.1	64.7	70	1890	183	183	192	—	90.0	(9.0)	—	28	615
(495)	—	539	76.7	—	51.6	64.3	—	1855	179	179	188	—	89.0	(8.0)	—	27	600
—	—	530	76.4	—	51.1	63.9	—	1825	174	174	182	—	87.8	(6.4)	—	—	585
—	495	528	76.3	—	51.0	63.8	68	1820	170	170	178	—	86.8	(5.4)	—	26	570
(477)	—	516	75.9	—	50.3	63.2	—	1780	167	167	175	—	86.0	(4.4)	—	—	560
—	—	508	75.6	—	49.6	62.7	—	1740	163	163	171	—	85.0	(3.3)	—	25	545
—	477	508	75.6	—	49.6	62.7	66	1740	156	156	163	—	82.9	(0.9)	—	—	525
(461)	—	495	75.1	—	48.8	61.9	—	1680	149	149	156	—	80.8	—	—	23	505
—	—	491	74.9	—	48.5	61.7	—	1670	143	143	150	—	78.7	—	—	22	490
—	461	491	74.9	—	48.5	61.7	65	1670	137	137	143	—	76.4	—	—	21	460
444	—	474	74.3	—	47.2	61.0	—	1595	126	126	132	—	74.0	—	—	—	450
—	—	472	74.2	—	47.1	60.8	—	1585	121	121	127	—	72.0	—	—	20	435
—	444	472	74.2	—	47.1	60.8	63	1585	116	116	122	—	69.8	—	—	19	415
—	—	472	74.2	—	47.1	60.8	—	1585	111	111	117	—	67.6	—	—	18	400
—	—	472	74.2	—	47.1	60.8	—	1585	111	111	117	—	65.7	—	—	15	385

Note 1) Above list is the same as that at AMS Metals Hand book with tensile strength in approximate metric value and Brinell hardness over a recommended range.

Note 2) 1MPa=1N/mm<sup>2</sup>

Note 3) Figures in ( ) are rarely used and are included for reference. This list has been taken from JIS Handbook Steel I.

# JIS FIT TOLERANCE TABLE (HOLE)

Classification of Standard Dimensions (mm)		Class of Geometrical Tolerance Zone of Holes															
>	≤	B10	C9	C10	D8	D9	D10	E7	E8	E9	F6	F7	F8	G6	G7	H6	H7
—	3	+180	+85	+100	+34	+45	+60	+24	+28	+39	+12	+16	+20	+8	+12	+6	+10
		+140	+60	+60	+20	+20	+20	+14	+14	+14	+6	+6	+6	+2	+2	0	0
3	6	+188	+100	+118	+48	+60	+78	+32	+38	+50	+18	+22	+28	+12	+16	+8	+12
		+140	+70	+70	+30	+30	+30	+20	+20	+20	+10	+10	+10	+4	+4	0	0
6	10	+208	+116	+138	+62	+76	+98	+40	+47	+61	+22	+28	+35	+14	+20	+9	+15
		+150	+80	+80	+40	+40	+40	+25	+25	+25	+13	+13	+13	+5	+5	0	0
10	14	+220	+138	+165	+77	+93	+120	+50	+59	+75	+27	+34	+43	+17	+24	+11	+18
		+150	+95	+95	+50	+50	+50	+32	+32	+32	+16	+16	+16	+6	+6	0	0
14	18	+244	+162	+194	+98	+117	+149	+61	+73	+92	+33	+41	+53	+20	+28	+13	+21
		+160	+110	+110	+65	+65	+65	+40	+40	+40	+20	+20	+20	+7	+7	0	0
18	24	+270	+182	+220	+119	+142	+180	+75	+89	+112	+41	+50	+64	+25	+34	+16	+25
		+170	+120	+120	+80	+80	+80	+50	+50	+50	+25	+25	+25	+9	+9	0	0
30	40	+280	+192	+230	+146	+174	+220	+90	+106	+134	+49	+60	+76	+29	+40	+19	+30
		+180	+130	+130	+100	+100	+100	+60	+60	+60	+30	+30	+30	+10	+10	0	0
40	50	+310	+214	+260	+174	+207	+260	+107	+126	+159	+58	+71	+90	+34	+47	+22	+35
		+190	+140	+140	+120	+120	+120	+72	+72	+72	+36	+36	+36	+12	+12	0	0
50	65	+380	+267	+320	+208	+245	+305	+125	+148	+185	+68	+83	+106	+39	+54	+25	+40
		+240	+180	+180	+145	+145	+145	+85	+85	+85	+43	+43	+43	+14	+14	0	0
65	80	+420	+300	+360	+271	+320	+400	+162	+191	+240	+88	+108	+137	+49	+69	+32	+52
		+260	+200	+200	+190	+190	+190	+110	+110	+110	+56	+56	+56	+17	+17	0	0
80	100	+440	+310	+370	+299	+350	+440	+182	+214	+265	+98	+119	+151	+54	+75	+36	+57
		+280	+210	+210	+271	+320	+400	+162	+191	+240	+88	+108	+137	+49	+69	+32	+52
100	120	+470	+330	+390	+210	+210	+210	+125	+125	+125	+62	+62	+62	+18	+18	0	0
		+310	+230	+230	+190	+190	+190	+110	+110	+110	+56	+56	+56	+17	+17	0	0
120	140	+525	+355	+425	+271	+320	+400	+162	+191	+240	+88	+108	+137	+49	+69	+32	+52
		+340	+240	+240	+190	+190	+190	+110	+110	+110	+56	+56	+56	+17	+17	0	0
140	160	+565	+375	+445	+299	+350	+440	+182	+214	+265	+98	+119	+151	+54	+75	+36	+57
		+380	+260	+260	+271	+320	+400	+162	+191	+240	+88	+108	+137	+49	+69	+32	+52
160	180	+605	+395	+465	+210	+210	+210	+125	+125	+125	+62	+62	+62	+18	+18	0	0
		+420	+280	+280	+190	+190	+190	+110	+110	+110	+56	+56	+56	+17	+17	0	0
180	200	+690	+430	+510	+299	+350	+440	+182	+214	+265	+98	+119	+151	+54	+75	+36	+57
		+480	+300	+300	+210	+210	+210	+125	+125	+125	+62	+62	+62	+18	+18	0	0
200	225	+750	+460	+540	+210	+210	+210	+125	+125	+125	+62	+62	+62	+18	+18	0	0
		+540	+330	+330	+190	+190	+190	+110	+110	+110	+56	+56	+56	+17	+17	0	0
225	250	+830	+500	+590	+299	+350	+440	+182	+214	+265	+98	+119	+151	+54	+75	+36	+57
		+600	+360	+360	+210	+210	+210	+125	+125	+125	+62	+62	+62	+18	+18	0	0
250	280	+910	+540	+630	+210	+210	+210	+125	+125	+125	+62	+62	+62	+18	+18	0	0
		+680	+400	+400	+190	+190	+190	+110	+110	+110	+56	+56	+56	+17	+17	0	0
280	315	+1010	+595	+690	+299	+350	+440	+182	+214	+265	+98	+119	+151	+54	+75	+36	+57
		+760	+440	+440	+210	+210	+210	+125	+125	+125	+62	+62	+62	+18	+18	0	0
315	355	+1090	+635	+730	+299	+350	+440	+182	+214	+265	+98	+119	+151	+54	+75	+36	+57
		+840	+480	+480	+210	+210	+210	+125	+125	+125	+62	+62	+62	+18	+18	0	0
355	400	+1100	+640	+740	+299	+350	+440	+182	+214	+265	+98	+119	+151	+54	+75	+36	+57
		+760	+440	+440	+210	+210	+210	+125	+125	+125	+62	+62	+62	+18	+18	0	0
400	450	+1010	+595	+690	+299	+350	+440	+182	+214	+265	+98	+119	+151	+54	+75	+36	+57
		+760	+440	+440	+210	+210	+210	+125	+125	+125	+62	+62	+62	+18	+18	0	0
450	500	+1090	+635	+730	+299	+350	+440	+182	+214	+265	+98	+119	+151	+54	+75	+36	+57
		+840	+480	+480	+210	+210	+210	+125	+125	+125	+62	+62	+62	+18	+18	0	0

Note) Values shown in the upper portion of respective lines are upper dimensional tolerance, while values shown in the lower portion of respective lines are lower dimensional tolerance.

## Class of Geometrical Tolerance Zone of Holes

H8	H9	H10	JS6	JS7	K6	K7	M6	M7	N6	N7	P6	P7	R7	S7	T7	U7	X7
+14 0	+25 0	+40 0	$\pm 3$	$\pm 5$	0 -6	0 -10	-2 -8	-2 -12	-4 -10	-4 -14	-6 -12	-6 -16	-10 -20	-14 -24	-	-18 -28	-20 -30
+18 0	+30 0	+48 0	$\pm 4$	$\pm 6$	+2 -6	+3 -9	-1 -9	0 -12	-5 -13	-4 -16	-9 -17	-8 -20	-11 -23	-15 -27	-	-19 -31	-24 -36
+22 0	+36 0	+58 0	$\pm 4.5$	$\pm 7$	+2 -7	+5 -10	-3 -12	0 -15	-7 -16	-4 -19	-12 -21	-9 -24	-13 -28	-17 -32	-	-22 -37	-28 -43
+27 0	+43 0	+70 0	$\pm 5.5$	$\pm 9$	+2 -9	+6 -12	-4 -15	0 -18	-9 -20	-5 -23	-15 -26	-11 -29	-16 -34	-21 -39	-	-26 -44	-33 -51 -38 -56
+33 0	+52 0	+84 0	$\pm 6.5$	$\pm 10$	+2 -11	+6 -15	-4 -17	0 -21	-11 -24	-7 -28	-18 -31	-14 -35	-20 -41	-27 -48	-	-33 -54 -40 -61	-46 -67 -56 -77
+39 0	+62 0	+100 0	$\pm 8$	$\pm 12$	+3 -13	+7 -18	-4 -20	0 -25	-12 -28	-8 -33	-21 -37	-17 -42	-25 -50	-34 -59	-39 -64 -45 -70	-51 -76 -61 -86	-
+46 0	+74 0	+120 0	$\pm 9.5$	$\pm 15$	+4 -15	+9 -21	-5 -24	0 -30	-14 -33	-9 -39	-26 -45	-21 -51	-30 -60 -32 -62	-42 -72 -48 -78	-55 -85 -64 -94	-76 -106 -91 -121	-
+54 0	+87 0	+140 0	$\pm 11$	$\pm 17$	+4 -18	+10 -25	-6 -28	0 -35	-16 -38	-10 -45	-30 -52	-24 -59	-38 -73 -41 -76	-58 -93 -66 -101	-78 -113 -91 -126	-111 -146 -131 -166	-
+63 0	+100 0	+160 0	$\pm 12.5$	$\pm 20$	+4 -21	+12 -28	-8 -33	0 -40	-20 -45	-12 -52	-36 -61	-28 -68	-48 -88 -50 -90 -53 -93	-77 -117 -85 -125 -93 -133	-107 -147 -119 -159 -131 -171	-	-
+72 0	+115 0	+185 0	$\pm 14.5$	$\pm 23$	+5 -24	+13 -33	-8 -37	0 -46	-22 -51	-14 -60	-41 -70	-33 -79	-60 -106 -63 -109 -67 -113	-105 -151 -113 -159 -123 -169	-	-	-
+81 0	+130 0	+210 0	$\pm 16$	$\pm 26$	+5 -27	+16 -36	-9 -41	0 -52	-25 -57	-14 -66	-47 -79	-36 -88	-74 -126 -78 -130	-	-	-	-
+89 0	+140 0	+230 0	$\pm 18$	$\pm 28$	+7 -29	+17 -40	-10 -46	0 -57	-26 -62	-16 -73	-51 -87	-41 -98	-87 -144 -93 -150	-	-	-	-
+97 0	+155 0	+250 0	$\pm 20$	$\pm 31$	+8 -32	+18 -45	-10 -50	0 -63	-27 -67	-17 -80	-55 -95	-45 -108	-103 -166 -109 -172	-	-	-	-

# JIS FIT TOLERANCE TABLE (SHAFTS)

Classification of Standard Dimensions (mm)		Class of Geometrical Tolerance Zone of Shafts														
>	≤	b9	c9	d8	d9	e7	e8	e9	f6	f7	f8	g5	g6	h5	h6	h7
—	3	-140 -165	-60 -85	-20 -34	-20 -45	-14 -24	-14 -28	-14 -39	-6 -12	-6 -16	-6 -20	-2 -6	-2 -8	0 -4	0 -6	0 -10
3	6	-140 -170	-70 -100	-30 -48	-30 -60	-20 -32	-20 -38	-20 -50	-10 -18	-10 -22	-10 -28	-4 -9	-4 -12	0 -5	0 -8	0 -12
6	10	-150 -186	-80 -116	-40 -62	-40 -76	-25 -40	-25 -47	-25 -61	-13 -22	-13 -28	-13 -35	-5 -11	-5 -14	0 -6	0 -9	0 -15
10	14	-150 -193	-95 -138	-50 -77	-50 -93	-32 -50	-32 -59	-32 -75	-16 -27	-16 -34	-16 -43	-6 -14	-6 -17	0 -8	0 -11	0 -18
14	18	-160 -212	-110 -162	-65 -98	-65 -117	-40 -61	-40 -73	-40 -92	-20 -33	-20 -41	-20 -53	-7 -16	-7 -20	0 -9	0 -13	0 -21
18	24	-170 -232	-120 -182	-80 -119	-80 -142	-50 -75	-50 -89	-50 -112	-25 -41	-25 -50	-25 -64	-9 -20	-9 -25	0 -11	0 -16	0 -25
24	30	-180 -242	-130 -192	-119 -142	-142 -174	-75 -90	-89 -106	-112 -134	-41 -49	-50 -60	-64 -76	-20 -23	-25 -29	-11 -13	-16 -19	-25 -30
30	40	-190 -264	-140 -214	-100 -146	-100 -174	-60 -90	-60 -106	-60 -134	-30 -49	-30 -60	-30 -76	-10 -23	-10 -29	0 -13	0 -19	0 -30
40	50	-200 -274	-150 -224	-146 -174	-174 -207	-90 -107	-106 -126	-134 -159	-49 -58	-60 -71	-76 -90	-23 -27	-29 -34	-13 -15	-19 -22	-30 -35
50	65	-220 -307	-170 -257	-120 -174	-120 -207	-72 -107	-72 -126	-72 -159	-36 -58	-36 -71	-36 -90	-12 -27	-12 -34	0 -15	0 -22	0 -35
65	80	-240 -327	-180 -267	-174 -207	-207 -245	-107 -125	-126 -148	-159 -185	-58 -68	-71 -83	-90 -106	-27 -32	-34 -39	-15 -18	-22 -25	-35 -40
80	100	-260 -360	-200 -300	-145 -208	-145 -245	-85 -125	-85 -148	-85 -185	-43 -68	-43 -83	-43 -106	-14 -32	-14 -39	0 -18	0 -25	0 -40
100	120	-280 -380	-210 -310	-208 -245	-245 -285	-125 -146	-148 -172	-185 -215	-68 -79	-83 -96	-106 -122	-32 -35	-39 -44	-18 -20	-25 -29	-40 -46
120	140	-310 -410	-230 -330	-245 -285	-285 -320	-146 -162	-172 -191	-215 -240	-79 -88	-96 -108	-122 -137	-35 -40	-44 -49	-20 -23	-29 -32	-46 -52
140	160	-340 -455	-240 -355	-285 -320	-320 -355	-162 -191	-191 -214	-240 -265	-88 -98	-108 -119	-137 -151	-40 -43	-49 -54	-23 -25	-32 -36	-52 -57
160	180	-380 -495	-260 -375	-320 -355	-355 -395	-191 -214	-214 -240	-265 -290	-98 -108	-119 -131	-151 -165	-43 -47	-54 -60	-25 -27	-36 -40	-57 -63
180	200	-420 -535	-280 -395	-355 -395	-395 -430	-214 -240	-240 -265	-290 -315	-108 -119	-131 -143	-165 -180	-47 -51	-60 -66	-27 -30	-40 -44	-63 -69
200	225	-480 -610	-300 -430	-395 -430	-430 -460	-240 -265	-265 -290	-315 -340	-119 -131	-143 -155	-180 -195	-51 -55	-66 -72	-30 -33	-44 -48	-69 -75
225	250	-540 -670	-330 -460	-430 -460	-460 -490	-265 -290	-290 -315	-340 -365	-131 -143	-155 -167	-195 -210	-55 -59	-72 -78	-33 -36	-48 -52	-75 -81
250	280	-600 -740	-360 -500	-460 -490	-490 -520	-290 -315	-315 -340	-365 -390	-143 -155	-167 -179	-210 -225	-59 -63	-78 -84	-36 -39	-52 -56	-81 -87
280	315	-680 -820	-400 -540	-490 -520	-520 -550	-315 -340	-340 -365	-390 -415	-155 -167	-179 -191	-225 -240	-63 -67	-84 -90	-39 -42	-56 -60	-87 -93
315	355	-760 -915	-440 -595	-520 -550	-550 -580	-340 -365	-365 -390	-415 -440	-167 -179	-191 -203	-240 -255	-67 -71	-90 -96	-42 -45	-60 -64	-93 -99
355	400	-840 -995	-480 -635	-550 -580	-580 -610	-365 -390	-390 -415	-440 -465	-179 -191	-203 -215	-255 -270	-71 -75	-96 -102	-45 -48	-64 -68	-99 -105
400	450	-915 -995	-595 -635	-580 -610	-610 -640	-390 -415	-415 -440	-465 -490	-191 -203	-215 -227	-270 -285	-75 -79	-102 -108	-48 -51	-68 -72	-105 -111
450	500	-995 -1035	-635 -675	-610 -640	-640 -670	-415 -440	-440 -465	-490 -515	-203 -215	-227 -239	-285 -300	-79 -83	-108 -114	-51 -54	-72 -76	-111 -117

Note) Values shown in the upper portion of respective lines are upper dimensional tolerance, while values shown in the lower portion of respective lines are lower dimensional tolerance.



## Class of Geometrical Tolerance Zone of Shafts

h8	h9	js5	js6	js7	k5	k6	m5	m6	n6	p6	r6	s6	t6	u6	x6
0 -14	0 -25	$\pm 2$	$\pm 3$	$\pm 5$	+4 0	+6 0	+6 +2	+8 +2	+10 +4	+12 +6	+16 +10	+20 +14	—	+24 +18	+26 +20
0 -18	0 -30	$\pm 2.5$	$\pm 4$	$\pm 6$	+6 +1	+9 +1	+9 +4	+12 +4	+16 +8	+20 +12	+23 +15	+27 +19	—	+31 +23	+36 +28
0 -22	0 -36	$\pm 3$	$\pm 4.5$	$\pm 7$	+7 +1	+10 +1	+12 +6	+15 +6	+19 +10	+24 +15	+28 +19	+32 +23	—	+37 +28	+43 +34
0 -27	0 -43	$\pm 4$	$\pm 5.5$	$\pm 9$	+9 +1	+12 +1	+15 +7	+18 +7	+23 +12	+29 +18	+34 +23	+39 +28	—	+44 +33	+51 +40 +56 +45
0 -33	0 -52	$\pm 4.5$	$\pm 6.5$	$\pm 10$	+11 +2	+15 +2	+17 +8	+21 +8	+28 +15	+35 +22	+41 +28	+48 +35	— +54 +41	+54 +41 +61 +48	+67 +54 +77 +64
0 -39	0 -62	$\pm 5.5$	$\pm 8$	$\pm 12$	+13 +2	+18 +2	+20 +9	+25 +9	+33 +17	+42 +26	+50 +34	+59 +43	+64 +48 +70 +54	+76 +60 +86 +70	—
0 -46	0 -74	$\pm 6.5$	$\pm 9.5$	$\pm 15$	+15 +2	+21 +2	+24 +11	+30 +11	+39 +20	+51 +32	+60 +41 +62 +43	+72 +53 +78 +59	+85 +66 +94 +75	+106 +87 +121 +102	—
0 -54	0 -87	$\pm 7.5$	$\pm 11$	$\pm 17$	+18 +3	+25 +3	+28 +13	+35 +13	+45 +23	+59 +37	+73 +51 +76 +54	+93 +71 +101 +79	+113 +91 +126 +104	+146 +124 +166 +144	—
0 -63	0 -100	$\pm 9$	$\pm 12.5$	$\pm 20$	+21 +3	+28 +3	+33 +15	+40 +15	+52 +27	+68 +43	+88 +63 +90 +65 +93 +68	+117 +92 +125 +100 +133 +108	+147 +122 +159 +134 +171 +146	—	—
0 -72	0 -115	$\pm 10$	$\pm 14.5$	$\pm 23$	+24 +4	+33 +4	+37 +17	+46 +17	+60 +31	+79 +50	+106 +77 +109 +80 +113 +84	+151 +122 +159 +130 +169 +140	—	—	—
0 -81	0 -130	$\pm 11.5$	$\pm 16$	$\pm 26$	+27 +4	+36 +4	+43 +20	+52 +20	+66 +34	+88 +56	+126 +94 +130 +98	—	—	—	—
0 -89	0 -140	$\pm 12.5$	$\pm 18$	$\pm 28$	+29 +4	+40 +4	+46 +21	+57 +21	+73 +37	+98 +62	+144 +108 +150 +114	—	—	—	—
0 -97	0 -155	$\pm 13.5$	$\pm 20$	$\pm 31$	+32 +5	+45 +5	+50 +23	+63 +23	+80 +40	+108 +68	+166 +126 +172 +132	—	—	—	—

# TAPER STANDARD

**Fig.1**  
Bolt Grip Taper

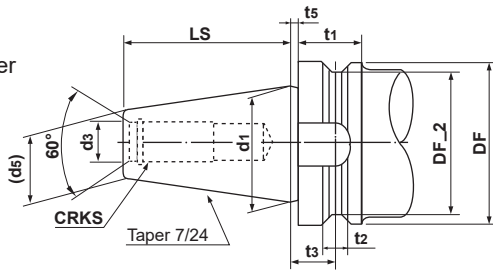

**Fig.2**  
National Taper

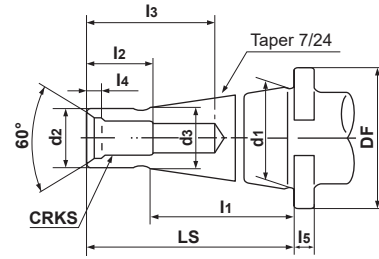

● **Table 1 Bolt Grip Taper (Fig.1)**

Bearing Number	DF	DF_2	t1	t2	t3	t5	d1	d3	LS	CRKS	d5
BT35	53	43	20	10	13.0	2	38.1	13	56.5	M12×1.75	21.62
BT40	63	53	25	10	16.6	2	44.45	17	65.4	M16×2	25.3
BT45	85	73	30	12	21.2	3	57.15	21	82.8	M20×25	33.1
BT50	100	85	35	15	23.2	3	69.85	25	101.8	M24×3	40.1
BT60	155	135	45	20	28.2	3	107.95	31	161.8	M30×3.5	60.7

● **Table 2 National Taper (Fig.2)**

Bearing Number	d1	d2	LS	l1	CRKS		l2	l3	d3	l4	DF	l5
					Metric Screw	Wit Screw						
NT30	31.75	17.4	70	50	M12	W 1/2	24	50	16.5	6	50	8
NT40	44.45	25.3	95	67	M16	W 5/8	30	70	24	7	63	10
NT50	69.85	39.6	130	105	M24	W 1	45	90	38	11	100	13
NT60	107.95	60.2	210	165	M30	W 1 1/4	56	110	58	12	170	15

**Fig.3**  
Morse Taper  
(Shank with Tongue)

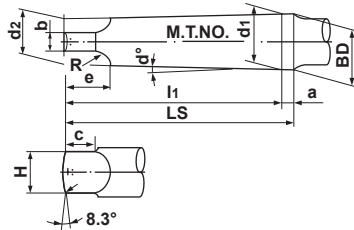

**Fig.4**  
Morse Taper  
(Shank with Screw)

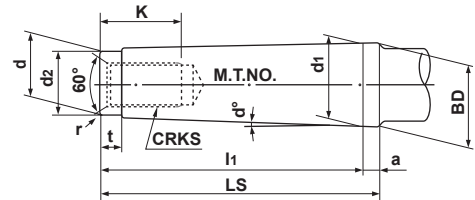

● **Table 3 Shank with Tongue (Fig.3)**







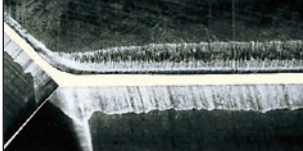
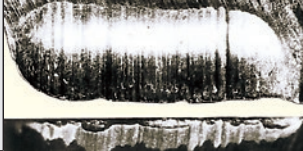

Morse Taper Number	d1	a	BD	d2	H	l1	LS	d	c	e	R	r
0	9.045	3	9.201	6.104	6	56.5	59.5	3.9	6.5	10.5	4	1
1	12.065	3.5	12.240	8.972	8.7	62.0	65.5	5.2	8.5	13.5	5	1.2
2	17.780	5	18.030	14.034	13.5	75.0	80.0	6.3	10	16	6	1.6
3	23.825	5	24.076	19.107	18.5	94.0	99	7.9	13	20	7	2
4	31.267	6.5	31.605	25.164	24.5	117.5	124	11.9	16	24	8	2.5
5	44.399	6.5	44.741	36.531	35.7	149.5	156	15.9	19	29	10	3
6	63.348	8	63.765	52.399	51.0	210.0	218	19	27	40	13	4
7	83.058	10	83.578	68.185	66.8	286.0	296	28.6	35	54	19	5

● **Table 4 Shank with Screw (Fig.4)**

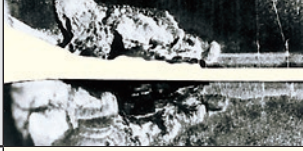
Morse Taper Number	d1	a	BD	d	d2	l1	LS	t	r	CRKS	K
0	9.045	3	9.201	6.442	6	50	53	4	0.2	—	—
1	12.065	3.5	12.240	9.396	9	53.5	57	5	0.2	M6	16
2	17.780	5	18.030	14.583	14	64	69	5	0.2	M10	24
3	23.825	5	24.076	19.759	19	81	86	7	0.6	M12	28
4	31.267	6.5	31.605	25.943	25	102.5	109	9	1.0	M16	32
5	44.399	6.5	44.741	37.584	35.7	129.5	136	9	2.5	M20	40
6	63.348	8	63.765	53.859	51	182	190	12	4.0	M24	50
7	83.058	10	83.578	70.052	65	250	260	18.5	5.0	M33	80

# TOOL WEAR AND DAMAGE

## CAUSES AND COUNTERMEASURES

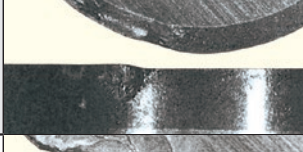
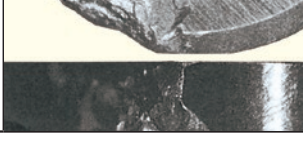
Tool Damage Form	Cause	Countermeasure
<b>Flank Wear</b> 	<ul style="list-style-type: none"> <li>• Tool grade is too soft.</li> <li>• Cutting speed is too high.</li> <li>• Flank angle is too small.</li> <li>• Feed rate is extremely low.</li> </ul>	<ul style="list-style-type: none"> <li>• Tool grade with high wear resistance.</li> <li>• Lower cutting speed.</li> <li>• Increase flank angle.</li> <li>• Increase feed rate.</li> </ul>
<b>Crater Wear</b> 	<ul style="list-style-type: none"> <li>• Tool grade is too soft.</li> <li>• Cutting speed is too high.</li> <li>• Feed rate is too high.</li> </ul>	<ul style="list-style-type: none"> <li>• Tool grade with high wear resistance.</li> <li>• Lower cutting speed.</li> <li>• Lower feed rate.</li> </ul>
<b>Chipping</b> 	<ul style="list-style-type: none"> <li>• Tool grade is too hard.</li> <li>• Feed rate is too high.</li> <li>• Lack of cutting edge strength.</li> <li>• Lack of shank or holder rigidity.</li> </ul>	<ul style="list-style-type: none"> <li>• Tool grade with high toughness.</li> <li>• Lower feed rate.</li> <li>• Increase honing. (Round honing is to be changed to chamfer honing.)</li> <li>• Use large shank size.</li> </ul>
<b>Fracture</b> 	<ul style="list-style-type: none"> <li>• Tool grade is too hard.</li> <li>• Feed rate is too high.</li> <li>• Lack of cutting edge strength.</li> <li>• Lack of shank or holder rigidity.</li> </ul>	<ul style="list-style-type: none"> <li>• Tool grade with high toughness.</li> <li>• Lower feed rate.</li> <li>• Increase honing. (Round honing is to be changed to chamfer honing.)</li> <li>• Use large shank size.</li> </ul>
<b>Plastic Deformation</b> 	<ul style="list-style-type: none"> <li>• Tool grade is too soft.</li> <li>• Cutting speed is too high.</li> <li>• Depth of cut and feed rate are too large.</li> <li>• Cutting temperature is high.</li> </ul>	<ul style="list-style-type: none"> <li>• Tool grade with high wear resistance.</li> <li>• Lower cutting speed.</li> <li>• Decrease depth of cut and feed rate.</li> <li>• Tool grade with high thermal conductivity.</li> </ul>
<b>Welding</b> 	<ul style="list-style-type: none"> <li>• Cutting speed is low.</li> <li>• Poor sharpness.</li> <li>• Unsuitable grade.</li> </ul>	<ul style="list-style-type: none"> <li>• Increase cutting speed. (For JIS S45C, cutting speed 80m/min.)</li> <li>• Increase rake angle.</li> <li>• Tool grade with low affinity. (Coated grade, cermet grade)</li> </ul>
<b>Thermal Cracks</b> 	<ul style="list-style-type: none"> <li>• Expansion or shrinkage due to cutting heat.</li> <li>• Tool grade is too hard. *Especially in milling.</li> </ul>	<ul style="list-style-type: none"> <li>• Dry cutting. (For wet cutting, flood workpiece with cutting fluid)</li> <li>• Tool grade with high toughness.</li> </ul>
<b>Notching</b> 	<ul style="list-style-type: none"> <li>• Hard surfaces such as uncut surfaces, chilled parts and machining hardened layer.</li> <li>• Friction caused by jagged shape chips. (Caused by small vibration)</li> </ul>	<ul style="list-style-type: none"> <li>• Tool grade with high wear resistance.</li> <li>• Increase rake angle to improve sharpness.</li> </ul>
<b>Flaking</b> 	<ul style="list-style-type: none"> <li>• Cutting edge welding and adhesion.</li> <li>• Poor chip disposal.</li> </ul>	<ul style="list-style-type: none"> <li>• Increase rake angle to improve sharpness.</li> <li>• Enlarge chip pocket.</li> </ul>
<b>Flank Wear Fracture</b> *Damage for polycrystallines 	<ul style="list-style-type: none"> <li>• Damage due to the lack of strength of a curved cutting edge.</li> </ul>	<ul style="list-style-type: none"> <li>• Increase honing.</li> <li>• Tool grade with high toughness.</li> </ul>
<b>Crater Wear Fracture</b> *Damage for polycrystallines 	<ul style="list-style-type: none"> <li>• Tool grade is too soft.</li> <li>• Cutting resistance is too high and causes high cutting heat.</li> </ul>	<ul style="list-style-type: none"> <li>• Decrease honing.</li> <li>• Tool grade with high wear resistance.</li> </ul>

# CUTTING TOOL MATERIALS

The table below shows the relationship between various tool materials, in relation with hardness on a vertical axis and toughness on a horizontal axis. Today, cemented carbide, coated carbide and TiC-TiN-based cermet are key tool materials in the market. This is because they have the best balance of hardness and toughness.

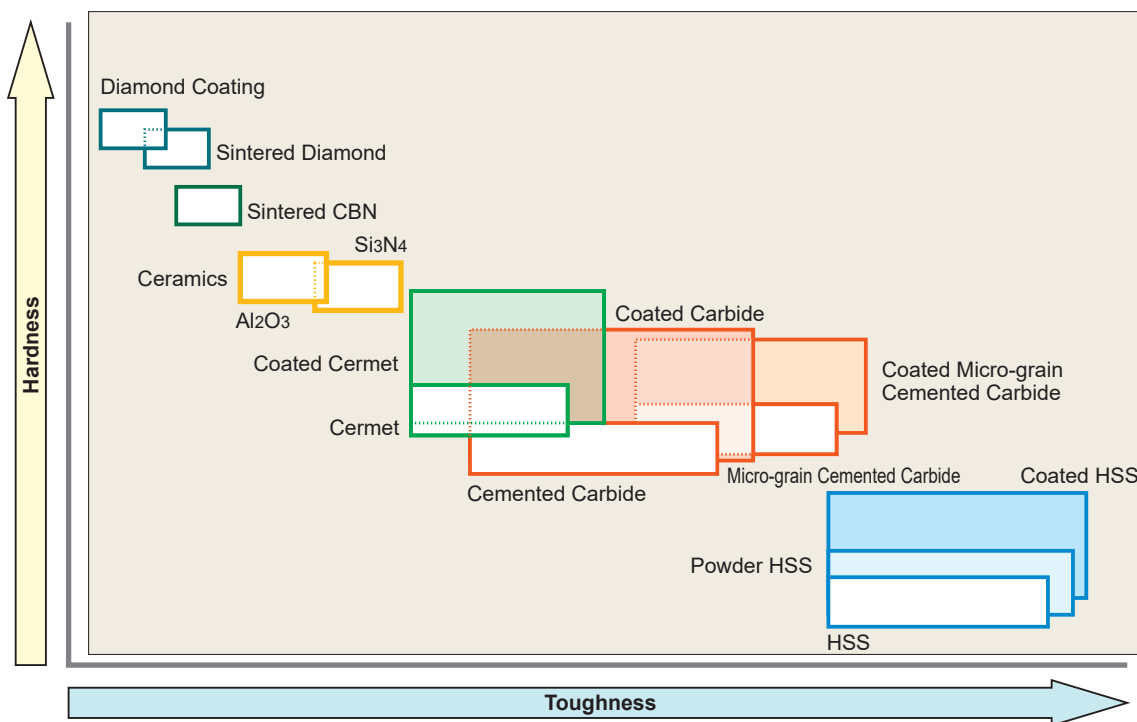

## GRADE CHARACTERISTICS

Hard Materials	Hardness (HV)	Energy Formation (kcal/g·atom)	Solubility in Iron (%.1250°C)	Thermal Conductivity (W/m·k)	Thermal Expansion (x 10 <sup>-6</sup> /k)*	Tool Material
Diamond	>9000	–	Highly Soluble	2100	3.1	Sintered Diamond
CBN	>4500	–	–	1300	4.7	Sintered CBN
Si <sub>3</sub> N <sub>4</sub>	1600	–	–	100	3.4	Ceramics
Al <sub>2</sub> O <sub>3</sub>	2100	-100	≠0	29	7.8	Ceramics Cemented Carbide
TiC	3200	-35	< 0.5	21	7.4	Cermet Coated Carbide
TiN	2500	-50	–	29	9.4	Cermet Coated Carbide
TaC	1800	-40	0.5	21	6.3	Cemented Carbide
WC	2100	-10	7	121	5.2	Cemented Carbide

\*1W/m·K=2.39×10<sup>-3</sup>cal/cm·sec·°C

# GRADE CHAIN

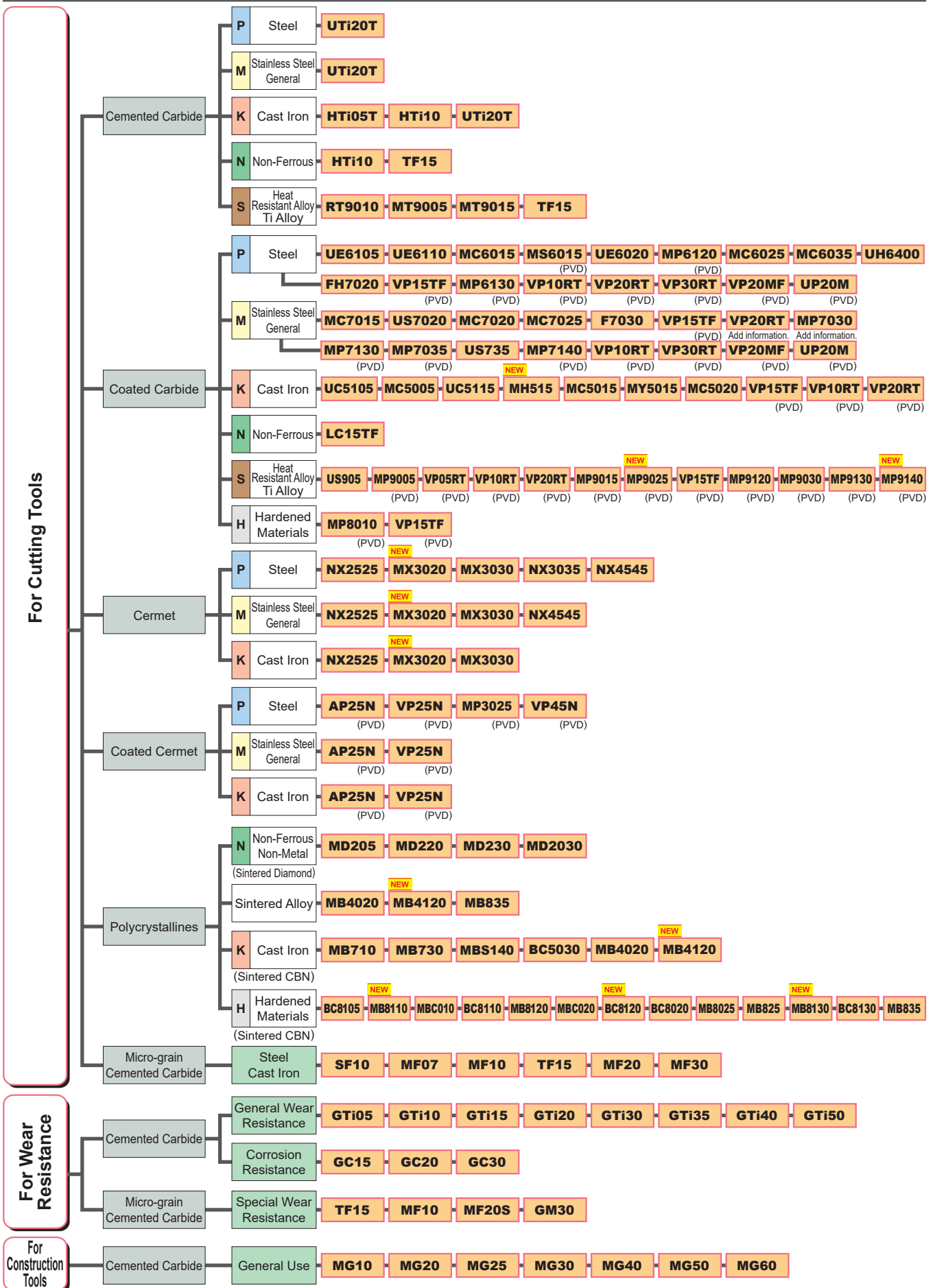

TECHNICAL DATA



# GRADES COMPARISON TABLE

## CEMENTED CARBIDE

Classification	ISO	Mitsubishi Materials	Sumitomo Electric	Tungaloy	Kyocera	Dijet	Mitsubishi Hitachi Tool	Sandvik	Kennametal	Seco Tools	Iscar	
	Symbol											
Turning	P	P01										
		P10		ST10P	TX10S		SRT	WS10			IC70	
		P20	UTi20T	ST20E	UX30		SRT DX30	EX35	SMA		IC70 IC50M	
		P30	UTi20T	A30 A30N	UX30	PW30	SR30 DX30	EX35 EX40	SM30		IC50M IC54	
		P40		ST40E			SR30	EX45			IC54	
	M	M10		EH510 U10E			UMN	WA10B	H10A	KU10 K313 K68	890	IC07
		M20	UTi20T	EH520 U2	UX30		DX25 UMS	EX35	H13A	KU10 K313 K68	HX	IC07 IC08 IC20
		M30	UTi20T	A30 A30N	UX30		DX25 UMS	EX45	H10F SM30		883	IC08 IC20 IC28
		M40					UM40	EX45				IC28
	K	K01	HTi05T	H1 H2	TH03 KS05F		KG03	WH05		KU10 K313 K68		
		K10	HTi10	EH10 EH510	TH10	KW10 GW15	KG10 KT9	WH10	H10 HM	KU10 K313 K68	890	IC20
		K20	UTi20T	G10E EH20 EH520	KS15F KS20	GW25	CR1 KG20	WH20	H13A	KU10 K313 K68	HX	IC20
		K30	UTi20T	G10E			KG30				883	
	N	N01		H1 H2	KS05F	KW10			H10 H13A			
		N10	HTi10	EH10 EH510	TH10	KW10 GW15	KT9	WH10		KU10 K313 K68	H15	IC08 IC20
		N20		G10E EH20 EH520	KS15F		CR1	WH20		KU10 K313 K68	HX KX	IC08 IC20
		N30									H25	
	S	S01	MT9005			SW05	KG03					
		S10	MT9005 RT9010 MT9015	EH10 EH510	KS05F TH10	SW10	FZ05 KG10	WH13S	H10 H10A H10F H13A	K10 K313 K68	HX	IC07 IC08
		S20	RT9010 TF15	EH20 EH520	KS15F KS20	SW25	FZ15 KG20			K10 K313 K68	H25	IC07 IC08
S30		TF15				KG30						
Milling	P	P10				SRT						
		P20	UTi20T	A30N	UX30		SRT DX30	EX35		K125M	IC50M IC28	
		P30	UTi20T	A30N	UX30	PW30	SR30 DX30	EX35		GX	IC50M IC28	
		P40				PW30	SR30	EX45			IC28	
	M	M10					UMN					
		M20	UTi20T	A30N	UX30		DX25 UMS	EX35				IC08 IC20
		M30	UTi20T	A30N	UX30		DX25 UMS	EX45	SM30			IC08 IC28
		M40						EX45				IC28
	K	K01	HTi05T				KG03			K115M, K313		
		K10	HTi10	G10E	TH10	KW10 GW25	KG10	WH10		K115M K313		IC20
		K20	UTi20T	G10E	KS20	GW25	KT9 CR1 KG20	WH20	H13A		HX	IC20
		K30	UTi20T				KG30					

Note 1) The above table is selected from a publication. We have not obtained approval from each company.



## MICRO GRAIN

Classification	ISO	Mitsubishi Materials	Sumitomo Electric	Tungaloy	Kyocera	Dijet	Mitsubishi Hitachi Tool	Sandvik	Kennametal	Seco Tools
	Symbol									
Cutting Tools	Z	Z01	SF10 MF07 MF10	F0	F MD05F MD1508		FZ05 FB05 FB10	NM08	PN90 6UF,H3F 8UF,H6F	
		Z10	HTi10 MF20	XF1 F1 AFU	MD10 MD0508 MD07F	FW30	FZ10 FZ15 FB15	NM10 NM12 NM15	H10F	890
		Z20	TF15 MF30	AF0 SF2 AF1	EM10 MD20 G1F		FZ15 FB15 FB20	BRM20 EF20N	H15F	890 883
		Z30		A1 CC			FZ20 FB20	NM25 NM40		883

## CERMET

Classification	ISO	Mitsubishi Materials	Sumitomo Electric	Tungaloy	Kyocera	Dijet	Mitsubishi Hitachi Tool	Sandvik	Kennametal	Seco Tools	Iscar		
	Symbol												
Turning	P	P01	AP25N* VP25N*	T110A T1000A	NS520 AT520* GT520* GT720*	TN30 TN610 PV710* PV30* TN6010 PV7010*	LN10 CX50				IC20N IC520N*		
		P10	NX2525 AP25N* VP25N*	T1200A T2000Z* T1500A T1500Z*	NS520 NS730 GT730* NS9530 GT9530* AT9530*	TN60 TN610 PV710* PV60* TN6010 PV7010*	CX50 CX75 PX75*	CZ25*	CT5015 GC1525*	KT315 KT125	TP1020 TP1030* CM CMP*	IC20N IC520N* IC530N*	
		P20	NX2525 AP25N* VP25N* NX3035 MP3025*	T1200A T2500A T2000Z* T3000Z* T1500A T1500Z*	NS530 NS730 GT730* NS9530 GT9530* AT9530*	TN60 PV60* TN620 PV720* TN6020 PV7020* PV7025*	CX75 PX75* PX90*	CH550	GC1525*	KT325 KT1120 KT5020*	TP1020 TP1030*	IC20N IC520N* IC30N IC530N* IC75T	
		P30	MP3025* VP45N*	T3000Z*		PV7025* PV90*	PX90*					IC75T	
	M	M10	NX2525 AP25N* VP25N*	T110A T1000A T2000Z* T1500Z*	NS520 AT530* GT530* GT720*	TN60 PV60* TN620 PV720* TN6020 PV7020*	LN10 CX50		GC1525*	KT125	TP1020 TP1030* CM CMP*		
		M20	NX2525 AP25N* VP25N*	T1200A T2000Z* T1500A T1500Z*	NS530 GT730* NS730	TN90 TN6020 TN620 PV720* PV90* PV7020* PV7025*	CX50 CX75	CH550					
		M30											
	K	K01	NX2525 AP25N*	T110A T1000A T2000Z* T1500Z*	NS710 NS520 AT520* GT520* GT720*	TN30 PV30* PV7005* TN610 PV710* TN6010 PV7010*	LN10						
		K10	NX2525 AP25N*	T1200A T2000Z* T1500A T1500Z*	NS520 GT730* NS730	TN60 PV60* TN6020 TN620 PV720* PV90* PV7020* PV7025*	LN10		CT5015	KT325 KT125			
		K20	NX2525 AP25N*	T3000Z*			CX75						
	Milling	P	P10	NX2525			TN620M TN60	CX75	MZ1000*			C15M	IC30N
			P20	MX3020 NX2525	T250A	NS530	TN100M TN620M TN60	CX75 CX90	CH550 CH7030 MZ1000* MZ2000*	CT530	KT530M HT7 KT605M	C15M MP1020	IC30N
P30			MX3030 NX4545	T250A T4500A	NS530 NS540 NS740		CX90 CX99	MZ3000* CH7035				IC30N	
M		M10	NX2525				TN60 TN620M						IC30N
		M20	MX3020 NX2525		NS530	TN100M TN620M	CX75	CH550 CH7030 MZ1000* MZ2000*	CT530	KT530M HT7 KT605M	C15M	IC30N	
		M30	MX3030 NX4545	T250A	NS540 NS740		CX90 CX99	MZ3000* CH7035					
K		K01											
		K10	NX2525		NS530	TN60							
		K20	NX2525				CX75			KT530M HT7			

\*Coated Cermet

Note 1) The above table is selected from a publication. We have not obtained approval from each company.

TECHNICAL DATA

R

# GRADES COMPARISON TABLE

## CVD COATED GRADE

Classification	ISO	Mitsubishi	Sumitomo	Tungaloy	Kyocera	Dijet	Mitsubishi	Sandvik	Kennametal	Seco	Iscar		
	Symbol	Materials	Electric				Hitachi Tool			Tools			
Turning	P	P01	UE6105	AC810P AC700G	T9105 T9005	CA510 CA5505	JC110V	HG8010	GC4305 GC4205	KCP05B KCP05 KC9105	TP0501 TP0500 TP1501 TP1500	IC9150 IC8150 IC428	
		P10	UE6105 MC6015 UE6110 MY5015	AC810P AC700G AC820P AC2000 AC8015P	T9105 T9005 T9115 T9215	CA510 CA5505 CA515 CA5515	JC110V JC215V	HG8010 HG8025 GM8020	GC4315 GC4215 GC4325	KCP10B KCP10 KCP25 KC9110	TP1501 TP1500 TP2501 TP2500	IC9150 IC8150 IC8250	
		P20	MC6015 UE6110 MC6025 UE6020 MY5015	AC820P AC2000 AC8025P AC830P	T9115 T9125 T9215	CA025P CA515 CA5515 CA525 CA5525 CR9025	JC110V JC215V	HG8025 GM8020 GM25	GC4315 GC4215 GC4325 GC4225	KCP25B KCP30B KCP25 KC9125	TP2501 TP2500	IC8250 IC9250 IC8350	
		P30	MC6025 UE6020 MC6035 UE6035 UH6400	AC8035P AC830P AC630M	T9125 T9135 T9035 T9225	CA025P CA525 CA5525 CA530 CA5535 CR9025	JC215V JC325V	GM25 GM8035	GC4325 GC4335 GC4225 GC4025 GC4235	KCP30B KCP30	TP3501 TP3500 TP3000	IC8350 IC9250 IC9350	
		P40	MC6035 UE6035 UH6400	AC8035P AC630M	T9135 T9035	CA530 CA5535	JC325V	GM8035 GX30	GC4235 GC4335	KCP40 KCP40B KC9140 KC9240	TP3501 TP3500 TP3000	IC9350	
	M	M10	MC7015 US7020	AC610M AC6020M	T6120 T9215	CA6515	JX605X JC110V		GC2015 GC2220	KCM15B KCM15	TM2000	IC6015 IC8250	
		M20	MC7015 US7020 MC7025	AC6020M AC610M AC6030M AC630M	T6120 T9215	CA6515 CA6525	JC110V	HG8025 GM25	GC2015 GC2220	KCM15 KCM25B KCP40B	TM2000	IC6015	
		M30	MC7025 US735	AC6030M AC630M	T6130	CA6525	JX525X	GM8035 GX30	GC2025	KCM25 KCM35B KCP40	TM4000	IC6025	
		M40	US735	AC6030M AC630M			JX525X	GX30	GC2025	KCM35B KCM35	TM4000	IC6025	
	K	K01	MC5005 UC5105	AC405K AC410K AC4010K	T515 T5105	CA4505 CA4010 CA310	JC050W JC105V	HX3505	GC3205 GC3210	KCK05B KCK05	TK0501 TH1500	IC5005	
		K10	MC5015 MH515 UC5115 MY5015	AC405K AC4010K AC410K AC4015K AC415K	T515 T5115	CA315 CA4515 CA4010 CA4115	JC108W JC050W JC105V JC110V	HX3515 HG8010	GC3205 GC3210	KCK15B KCK15 KCK20 KC9315 KCK20B	TK0501 TK1501	IC5005 IC5010 IC428	
		K20	MC5015 MH515 UC5115 UE6110 MY5015	AC4015K AC415K AC420K AC8025P	T5115 T5125	CA320 CA4515 CA4115 CA4120	JC108W JC110V JC215V	HG8025 GM8020	GC3225	KCK20B KCK20 KCPK05	TK1501	IC5010 IC8150	
		K30	UE6110	AC8025P	T5125		JC215	HG8025 GM8020	GC3225	KCPK05			
	S	S01	US905			CA6515 CA6525 CA6535		HS9105 HS9115	S05F				
	Milling	P	P10				JC730U				MP1500	IC9080 IC4100 IC9015	
			P20	F7030 MC7020	ACP100	T3130 T3225		JC730U	GX2140	GC4220		MP1500 MP2500	IC5500 IC5100 IC520M
			P30	F7030 MC7020	ACP100	T3130 T3225			GX2140 GX2160	GC4330 GC4230	KCPK30 KC930M	MP2500	IC5500 IC4050
			P40						GX2030 GX30 GX2160	GC4340 GC4240	KC935M KC530M		
		M	M10										IC9250
			M20	F7030 MC7020	ACP100 ACM200	T3130 T3225	CA6535	JC730U	AX2040 GX2140			KC925M	MP2500 MM4500
M30			F7030 FC7020 MC7020	ACP100	T3130 T3225	CA6535		AX2040 GX2140 GX2160 GX30	GC2040		KC930M	MP2500 MM4500	IC9350 IC4050
M40								GX2030 GX2160 GX30			KC930M KC935M		IC635
K		K01					JC600						
		K10	MC5020	ACK100	T1215 T1115 T1015	CA420M	JC600						
		K20	MC5020	ACK200	T1115 T1015		JC610		GC3220 GC3330 K20W		KC915M	MK1500 MK2000	IC5100 IC9150
		K30					JC610	GX30	GC3330 GC3040		KC920M KC925M KCPK30 KC930M KC935M	MK2000 MK3000	IC4100 IC4050 IC520M

Note 1) The above table is selected from a publication. We have not obtained approval from each company.



## PVD COATED GRADE

Classification	ISO	Mitsubishi Materials	Sumitomo Electric	Tungaloy	Kyocera	Dijet	Mitsubishi Hitachi Tool	Sandvik	Kennametal	Seco Tools	Iscar	
	Symbol											
Turning	P	P01				PR1005						
		P10	VP10MF MS6015		AH710 SH725	PR1005 PR930 PR1025 PR1115 PR1225 PR1425		GC1125	KCU10 KC5010 KC5510 KU10T	CP200 TS2000	IC250 IC507 IC570 IC807 IC907 IC908	
		P20	VP10RT VP20RT VP15TF VP20MF MS6015	AC520U	AH710 AH725 AH120 SH730 GH730 GH130 SH725	PR930 PR1025 PR1115 PR1225 PR1425 PR1535		IP2000	GC1125 GC15	KCU10 KC5025 KC5525 KU25T	TS2500	IC1007 IC250 IC308 IC507 IC807 IC808 IC907 IC908 IC1008 IC1028 IC3028
		P30	VP10RT VP20RT VP15TF VP20MF	AC1030U AC530U	AH725 AH120 SH730 GH730 GH130 AH740 J740 SH725	PR1025 PR1225 PR1425 PR1535 PR1625		IP3000	GC1125	KCU25 KC5525 KU25T	CP500	IC228 IC250 IC328 IC330 IC354 IC528 IC1008 IC1028 IC3028
		P40			AH740 J740	PR1535					CP500 CP600	IC228 IC328 IC528 IC928 IC1008 IC1028 IC3028
		M	M01									
	M10	VP10MF MS6015		AH710 SH725	PR1025 PR1225 PR1425	JC5003 JC8015	IP050S	GC1115 GC15 GC1105	KCU10 KC5010 KC5510	CP200 TS2000	IC354 IC507 IC520 IC807 IC907 IC1007 IC5080T	
	M20	VP10RT VP20RT VP15TF VP20MF	AC520U AC5015S	AH710 AH725 AH120 SH730 GH730 GH130 GH330 AH630 SH725	PR1025 PR1125 PR1225 PR1425 PR915 PR930 PR1535	JC5003 JC5015 JC8015 JC5118	IP100S	GC1115 GC15 GC1125	KCU10 KC5010 KC5510	TS2500 CP500	IC354 IC808 IC908 IC1008 IC1028 IC3028 IC5080T	
	M30	VP10RT VP20RT VP15TF VP20MF MP7035	AC520U AC530U AC1030U AC6040M AC5025S	GH330 AH725 AH120 SH730 GH730 GH130 J740 AH645 SH725	PR1125 PR1425 PR1535	JC5015 JC8015 JC5118		GC1125 GC2035	KCU25 KC5525	CP500 CP600 TTP2050	IC228 IC250 IC328 IC330 IC1008 IC1028 IC9080T	
	M40	MP7035	AC530U AC6040M	J740	PR1535	JC5118		GC2035				IC328 IC928 IC1008 IC1028 IC3028 IC9080T
	K	K01										
	K10		AC510U	GH110 AH110 AH710				GC15	KCU10 KC5010 KC5510	CP200 TS2000	IC350 IC910 IC1008	
	K20	VP10RT VP20RT VP15TF		GH110 AH110 AH710 AH725 AH120 GH730 GH130					KCU15 KCU25	CP200 TS2000 TS2500	IC228 IC350 IC808 IC830 IC908 IC1007 IC1008	
	K30	VP10RT VP20RT VP15TF		AH725 AH120 GH730 GH130					KCU25 KC5525	CP500	IC228 IC350 IC808 IC830 IC908 IC928 IC1007 IC1008	
	S	S01	MP9005 VP05RT		AH905 AH8005	PR005S PR1305	JC5003 JC8015	JP9105			TH1000	IC507 IC804 IC807 IC907 IC5080T
	S10	MP9005 MP9015 VP10RT	AC510U AC5015S	AH905 SH730 AH110 AH8005 AH120	PR005S PR015S PR1310	JC5003 JC5015 JC8015	JP9115	GC1105 GC15	KCU10 KC5010 KC5410 KC5510	CP200 CP250 TS2000 TS2050 TS2500 TH1000	IC507 IC806 IC807 IC903 IC5080T	
	S20	MP9015 MT9015	AC510U AC520U AC5025S	AH120 AH725 AH8015	PR015S PR1125 PR1325	JC5015 JC8015 JC5118		GC1125	KCU10 KCU25 KC5025 KC5525	TS2500 CP500	IC228 IC300 IC328 IC808 IC908 IC928 IC3028 IC806 IC9080T	
	S30	MP9025 VP15TF VP20RT	AC1030U	AH725	PR1125 PR1535	JC5118		GC1125	KC5525	CP600	IC928 IC830	
	Milling	P	P01				JC8003	ATH80D ATH08M TH308 PN208 JP4105 PN15M				IC903
			P10	ACP200			PR830 PR1225	JC8003 JC8015 JC5015 JC5118	PN15M PN215 PCA12M JP4115	GC1010 GC1130	KC505M KC715M KC510M KC515M	IC250 IC350 IC808 IC810 IC900 IC903 IC908 IC910 IC950
P20			MP6120 VP15TF	ACP200	AH725 AH120 GH330 AH330	PR830 PR1225 PR1230 PR1525	JC5015 JC5040 JC6235 JC8015 JC5118 JC6235 JC7560P JC8118P	CY9020 JP4120 CY150	GC1010 GC1030 GC1130 GC2030	KC522M KC525M KC527M KC610M KC620M KC635M KC715M KC720M KC730M KTPK20	F25M MP3000	IC250 IC300 IC328 IC330 IC350 IC808 IC810 IC830 IC900 IC908 IC910 IC928 IC950 IC1008

Note 1) The above table is selected from a publication. We have not obtained approval from each company.

TECHNICAL DATA

R

# GRADES COMPARISON TABLE

## PVD COATED GRADE

Classification	ISO	Mitsubishi Materials	Sumitomo Electric	Tungalay	Kyocera	Dijet	Mitsubishi Hitachi Tool	Sandvik	Kennametal	Seco Tools	Iscar		
	Symbol												
Milling	P	P30	MP6120 VP15TF MP6130 VP30RT	ACP200 ACP300	AH725 AH120 AH130 AH140 GH130 AH730 AH3035	PR1230 PR1525	JC6235 JC7560 JC8050 JC7560P JC5015 JC8118 JC5040 JC8118P JC8015 JC5118	JS4045 CY250 CY250V CY25 HC844	GC1010 GC1030 GC2030 GC1130	KC735M KC725M KC530M KC537M KCPM40	F25M MP3000 F30M MP2050	IC250 IC300 IC328 IC330 IC350 IC830 IC845 IC900 IC928 IC950 IC1008	
			P40	VP30RT	ACP300	AH140 AH3035	PR1525	JC6235 JC7560 JC8050 JC7560P JC5040 JC8118 JC5118 JC8118P JC5118	JS4060 PTH30E PTH40H JX1060 JS4060	GC2030 GC1030 GC1130	KC735M KC537M KCPM40	F40M T60M	IC300 IC328 IC330 IC830 IC928 IC1008
	M	M01						PN08M PN208					IC907
		M10		ACM100		PR1225		PN15M PN215	GC1025 GC1030 GC1010 GC1130	KC715M KC515M			IC903
		M20	VP15TF MP7130 MP7030 VP20RT	ACP200	AH725 AH120 GH330 AH330 GH110	PR1025 PR1225	JC5015 JC5118 JC8015	JP4120	GC1025 GC1030 GC1040 GC2030 S30T	KC610M KC635M KC730M KC720M KC522M KC525M KCPM40 KTPK20	F25M MP3000	IC250 IC300 IC808 IC830 IC900 IC908 IC928 IC1008	
		M30	VP15TF MP7130 MP7030 VP20RT MP7140 VP30RT	ACP200 ACP300 ACM300	AH120 AH725 AH130 AH140 GH130 AH730 GH340 AH3135 AH4035	PR830 PR1225 PR1525 PR1535	JC5015 JC7560 JC8015 JC7560P JC8050 JC8118 JC5118 JC8118P	JS4045 CY250 HC844	S30T GC1040 GC2030	KC537M KC725M KC735M KCPM40 KC530M	F30M F40M MP3000 MP2050	IC250 IC300 IC328 IC330 IC380 IC830 IC882 IC928 IC1008	
		M40	MP7140 VP30RT	ACP300 ACM300	AH140 AH3135 AH4035	PR1525 PR1535	JC5015 JC7560 JC5118 JC7560P JC8050 JC8118 JC8118P	PTH30E PTH40H JM4160			F40M MP2050	IC250 IC300 IC328 IC330 IC882 IC1008	
	K	K01	MP8010		AH110 GH110 AH330		JC8003	ATH80D ATH08M TH308					
		K10	MP8010		AH110 GH110 AH725 AH120 GH130 AH330	PR1210 PR1510	JC8015	ATH10E TH315 CY100H	GC1010	KC514M KC515M KC527M KC635M	MK2050	IC350 IC810 IC830 IC900 IC910 IC928 IC950 IC380 IC1008	
		K20	VP15TF VP20RT	ACK300	GH130	PR1210 PR1510	JC5015 JC8015 JC6235	CY150 JP4120 CY9020 PTH13S	GC1010 GC1020	KTPK20 KC514M KC610M KC520M KC620M KC524M	MK2000 MK2050	IC350 IC808 IC810 IC830 IC900 IC908 IC910 IC928 IC950 IC1008	
		K30	VP15TF VP20RT	ACK300			JC6235 JC5015 JC8015 JC8118 JC8118P	CY250 JS4045	GC1020	KC522M KC725M KC524M KC735M KC537M	MK2050	IC350 IC808 IC830 IC908 IC928 IC950 IC1008	
	S	S01				PR1210	JC8003 JC8015 JC5118	PN08M PN208					IC907 IC908 IC808 IC903
		S10	MP9120 VP15TF	EH520Z EH20Z ACM100		PR1210	JC8003 JC5015 JC8015 JC5118	JS1025 JP4120	GC1130 GC1010 GC1030 GC2030	KC510M	MS2050	IC903 IC907 IC908 IC840 IC910 IC808	
		S20	MP9120 VP15TF MP9130 MP9030	EH520Z EH20Z ACK300 ACP300		PR1535	JC8015 JC5015 JC8050 JC5118	PTH30H	S30T GC2030 GC1030 GC1130	KC522M KC725M KCSM30 KCPM40	MS2050 MP2050	IC300 IC908 IC808 IC900 IC830 IC928 IC328 IC330 IC840 IC882 IC380	
		S30		ACP300 ACM300	AH3135	PR1535	JC8050 JC7560 JC5118	JM4160	GC2030 GC1040	KC725M KCPM40	MS2050 F40M KCSM40	IC830 IC882 IC928	
	H	H01	MP8010 VP05HT				JC8003 DH103 JC8008 DH102						IC903
		H10	VP15TF VP10H				JC8003 JC8008 JC8015 JC5118 JC8118P	JP4105 TH303 TH308 PTH08M ATH08M ATH80D	GC1130 GC1010 GC1030	KC505M KC510M	MH1000 F15M	IC900 IC808 IC907 IC905	
		H20	VP15TF		AH3135		JC8015 JC5118 JC8118P	JP4115 TH315	GC1030 GC1130		F15M	IC900 IC808 IC908 IC380 IC1008	
		H30			AH3135			JP4120			MP3000 F30M	IC380 IC900 IC1008	

Note 1) The above table is selected from a publication. We have not obtained approval from each company.

## CBN

Classification	ISO	Mitsubishi Materials	Sumitomo Electric	Tungaloy	Kyocera	Dijet	Sandvik	Seco Tools	
	Symbol								
Turning	H	H01	BC8105 BC8110 MBC010 MB8110	BNC100 BNX10 BN1000	BXM10 BX310	KBN050M KBN10M KBN510		CBN060K	
		H10	BC8110 MBC020 BC8120 MB8025 MB8110 MB8120	BNC160 BNX20 BN2000	BXM20 BX330	KBN25M KBN525	JBN300	CB7015	CBN010
		H20	MBC020 BC8120 MB8025 MB8120	BNC200 BNX25 BN250	BXM20 BX360	KBN30M	JBN245	CB7025 CB20	CBN150 CBN160C
		H30	BC8130 MB8130	BNC300 BN350	BXC50 BX380	KBN35M		CB7525	CBN150 CBN160C
	S	S01	MB730	BN700 BN7000	BX950				CBN170
		S10							
		S20							
		S30							
	K	K01	MB710 MB5015	BN500 BNC500	BX930 BX910				
		K10	MB730 MB4020 MB4120	BN700 BN7500 BN7000	BX850	KBN60M	JBN795	CB7525	
		K20	MB730 MB4020 MB4120	BN700 BN7000	BX950	KBN60M	JBN500		CBN200
		K30	BC5030 MBS140	BNS800	BX90S BXC90	KBN900		CB7925	CBN300 CBN400C CBN500
		Sintered Alloy	MB4020 MB835 MB4120	BN7500 BN7000	BX450 BX470 BX480	KBN65B KBN570 KBN65M KBN70M			CBN200

## PCD

Classification	ISO	Mitsubishi Materials	Sumitomo Electric	Tungaloy	Kyocera	Dijet	Sandvik	Seco Tools
	Symbol							
Turning	N	N01	MD205	DA90	DX180 DX160	KPD230 JDA735	CD05	PCD05
		N10	MD220	DA150	DX140	KPD010	CD10	PCD10
		N20	MD220	DA2200	DX120		JDA715	PCD20
		N30	MD230 MD2030	DA1000	DX110	KPD001	JDA10	PCD30 PCD30M

Note 1) The above table is selected from a publication. We have not obtained approval from each company.

# TECHNICAL DATA

## INSERT CHIP BREAKER COMPARISON TABLE

### NEGATIVE INSERT TYPE

ISO Classification	Cutting Mode	Mitsubishi Materials	Sumitomo Electric	Tungaloy	Kyocera	Dijet	Mitsubishi Hitachi Tool	Sandvik	Kennametal	Seco Tools	Walter	TaeguTec
<b>P</b>	<b>Finish</b>	PK* FH, FP FY, FS	FA, FB FL	O1* TF, 11 ZF	DP* GP, PP, VF XP, XP-T, XF		FE	QF LC	FF	FF1, FF2	FP5	FA FX
	<b>Light</b>	LP C SA, SH	SU LU, FE SX, SE	NS, 27 TSF, AS, TQ	PQ HQ, CQ	PF UR, UA, UT	BE B, BH, CE	XF PF	LF, FN		MP3, FV5 NF3, NF4	FM FG
	<b>Light (Mild Steel)</b>	SY		17	XQ, XS							FC
	<b>Light (With Wiper)</b>	SW	LUW, SEW	FW, SW AFW, ASW	WF WP, WQ			WL, WF	FW	W-MF2	NF	WS
	<b>Medium</b>	MP MA MH	GU UG GE, UX	NM, ZM TM, AM DM, 33, 37, 38	PG, CJ, GS PS, HS PT	PG UB	CT, AB AH AY, AE	PM QM, XM	P MN	MF3 MF5, M3 M5	MP5, MV5	PC, MP, FT MT SM
	<b>Medium (With Wiper)</b>	MW	GUW		WE			WMX, WM	MW, RW	W-M6, W-M3 W-MF5	NM	WT
	<b>Rough</b>	RP GH Std.	MU, MX, ME UZ	TH, THS Std.	PH GT Std.	UD GG	RE Y	PR, HM XMR Std.	RN, RP	MR6, MR7 M5	RP5, RP7 PV5 NM6, NM9	RT Std.
	<b>Heavy</b>	HZ HL, HM, HX HV	MP HG, HP HU, HW, HF	TRS TU TUS	PX	UC	TE, UE, HX HE, H	QR, PR HR, MR	MR RM RH	R4, R5, R6 R57, RR6, R7 R8, RR9	NR6, NRF NRR	RX, RH HD, HY, HT HZ, EH
<b>M</b>	<b>Finish Light</b>	SH, LM	SU, EF	SS	MQ, GU		MP, AB, BH	MF	FP LF*	MF1	NF4, FM5	SF
	<b>Medium</b>	MS, GM MM, MA ES	EX, EG, UP GU HM	SA, SF SM S	MS, MU SU, HU, TK ST	SF, SZ SG	PV, DE, SE AH	MM QM, XM K	MP	MF4	MM5, RM5 NM4	ML EM, MM VF
	<b>Heavy</b>	GH, RM HL, HZ	EM, MU MP	TH, SH			AE	MR MR	UP, RP	M5, MR7 RR6	NR4, NR5	
<b>K</b>	<b>Finish Light</b>	LK, MA		CF	KQ		VA, AH	KF	FN	MF2, MF5 M3, M4	MK5	
	<b>Medium</b>	MK, GK Std.	UZ, GZ, UX	CM Std.	KG, Std., C	PG	V, AE	KM	RP, UN	M5	RK5, NM5	MC
	<b>Rough</b>	RK			KH, GC	GG	RE	KR, KRR			RK7	KT
	<b>Heavy</b>	Flat Top	Flat Top	CH, Flat Top	ZS, Flat Top	Flat Top	Flat Top		Flat Top	MR3, MR4, MR7 Flat Top	Flat Top	
<b>S</b>	<b>Finish</b>	FJ*	EF		MQ			SF	FS, LF*	MF1		
	<b>Light</b>	LS, MJ, MJ*	SU*	HRF				SGF*	MS	MF4, MF5	NF4, NFT MS3	EA
	<b>Medium</b>	MS	EG, EX, UP	HRM SA, HMM	SQ MS, MU, TK		VI	NGP*, SM	UP, P, NGP*	M1	NMS, NMT	
	<b>Heavy</b>	RS, GJ	MU		SG, SX			SR, SMR	RP	MR3 MR4	NRS, NRT	ET

\*Peripheral ground type insert.

Note 1) Above charts are based on published data and not authorized by each manufacturer.

## 7° POSITIVE INSERT TYPE

ISO Classification	Cutting Mode	Mitsubishi Materials	Sumitomo Electric	Tungaloy	Kyocera	Dijet	Mitsubishi Hitachi Tool	Sandvik	Kennametal	Seco Tools	Walter	TaeguTec
P	Finish	SMG*	FC*, SC*	JS*, 01*	CF*, CK* GQ*, GF* SK*			UM*	LF*			SA*
	Finish Light	FP, FV LP, SV	FP, LU SU	PF, PSF PS, PSS	GP, PP, VF XP		JQ	PF, UF, XF	UF, 11 LF, FP	FF1 F1	PF4, FP4	FA, FX FG
	Light (With Wiper)	SW	LUW, SDW		WP			WF	FW	W-F1	PF2*, PF PF5*	
	Medium	MV MP, Std.	MU	23 PM, 24	HQ, MF* XQ, GK	FT	JE	XM, PM UM PR, XR	MF, MP	F2, MF2, M5	FP6, PS5 PM5	PC MT
	Medium (With Wiper)	MW						WM	MW	W-F2 W-M3	PM	WT
M	Finish   Light	FM LM	FC*, SI* LU SU	PF, PSF PS, PSS	CF*, CK* GQ*, GF* MQ, SK		MP	MF	LF, UF FP	F1, F2	FM4	
	Medium	MM Std.	MU	PM	HQ, GK			MM	MP		MM4, RM4	
K	Medium	MK, Std. Flat Top	MU, Flat Top*	Flat Top, CM	Flat Top*			KF, KM, KR	Flat Top	F1, M3, M5	FK6	
N	Medium	AZ*	AG*	AL*	AP* AH*	ASF*, ALU* ACB*		AL*	HP*	AL*	FM2*, PM2* MN2*	FL*
S	Finish Light	FS*, LS* FS-P*, LS-P* FJ* LS, MS	SI*	Std.	MQ				LF* HP*			

\*Peripheral ground type insert.

Note 1) Above charts are based on published data and not authorized by each manufacturer.

## 11° POSITIVE INSERT TYPE

ISO Classification	Cutting Mode	Mitsubishi Materials	Sumitomo Electric	Tungaloy	Kyocera	Dijet	Mitsubishi Hitachi Tool	Sandvik	Kennametal	Seco Tools	Walter	TaeguTec
P	Finish Light	FV, SMG* SV	SI, FK, FB LU, LUW, LB SU, SF	01* PF, PSF PS, PSS	PP, GP* CF XP		JQ	PF	UF, FP FW, LF			FG PC
	Medium	MV	MU	PM 23 24	HQ XQ	BM	JE	PM, UM	MF MP, MW		MP4	
M	Finish   Light	SV	SU	SS* PF, PS	GP, CF*		MP	MF	HP* LF		MM4	
	Medium	MV	MU	PM	HQ			MM				

\*Peripheral ground type insert.

Note 1) Above charts are based on published data and not authorized by each manufacturer.