

Indexable Drill

MX

Item
Expansion

Highly rigid body produced by utilizing the latest technology

Lengths L/D=2-6 Now Available



Indexable Drill

MX

4 Cutting Edges

Economical 4-corner insert.

Unique Chip Breaker Design

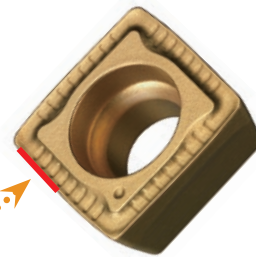

Universal
UM Breaker

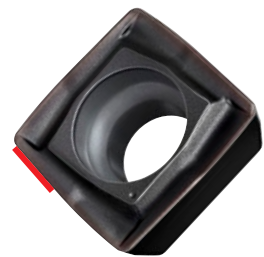

US Breaker
for Stainless Steel

For a wide range of work materials and applications.

Wiper Edge

A wiper type geometry for the peripheral cutting edge achieves excellent wall accuracy.

Ideal Combination of Outer CVD Insert and Inner PVD Insert

A highly wear resistant CVD coated insert is used for the peripheral edge and a PVD coated insert is used for the inner position for extra stability.

High Rigid Body

Increased surface hardness prevents abrasive damage caused by chip flow. Optimum insert position controls deformation and vibration of the holder. This enabled a maximum drilling depth of $L/D=6$.

Key Technology that Enabled L/D=6 Machining

Optimum Positioning of the Outer and Inner Inserts

By optimizing the cutting ratio A & B for the outer and inner inserts, deformation of the tool body can be controlled. Additionally, the uniformity of the cutting ratio A and B; across all diameters, reduces variations and improves performance.

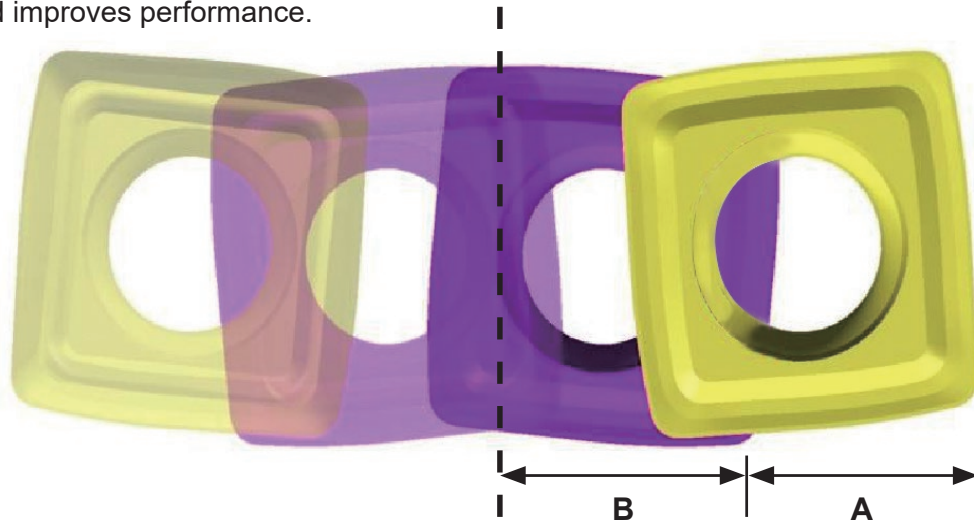

Optimum Flute Positioning

Extra body thickness positioned behind the inner edge helps to resist the principal force and prevents twisting and deformation during the initial cutting.

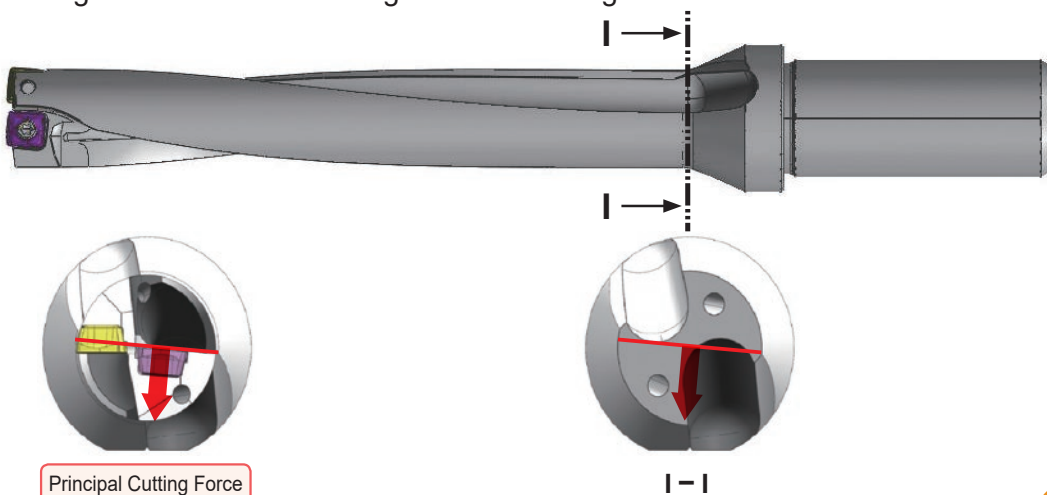

Inclined Coolant Through Holes

Chip evacuation when drilling deep holes is improved with specially designed coolant through holes that maintain coolant pressure.



Chip evacuation capacity is 20% greater than conventional products.

Insert Chip Breaker

Inner Insert, for Stainless Steel

US Breaker

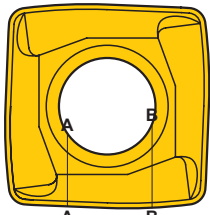

Strong Cutting Edge Part Sharp Cutting Edge Part

The cutting edge has both sharp and strong type geometry along its length for improved fracture resistance. The radius design also achieves excellent fracture and welding resistance.



For General Use, Medium and High Feed Rates

UM Breaker

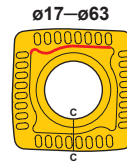

The unique design allows smooth chip discharge. An universal breaker for steel, stainless steel, cast iron and hardened steel.

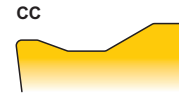
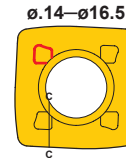

Insert with Reinforced Edge

UH Breaker

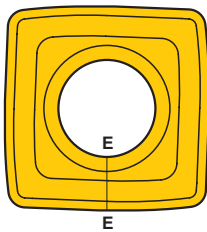

The strengthened cutting edge and Ti-Al-Si coating provide astounding stability even when cutting hardened steel (up to 45HRC) or general steel.

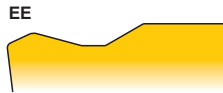

Insert for Aluminum Alloy

UN Breaker

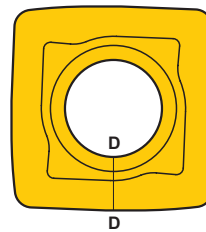

Outstanding chip discharge is achieved by the breaker which was designed to focus on sharpness, and the sharp edges achieved by grinding. Aluminum welding is also prevented by smoothing that has been performed on rake surfaces.

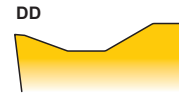

Insert Selection Criteria

The peripheral cutting speed is naturally slower towards the center of the drill and chip welding easily occurs. Below are some important points that will help to select the correct insert.

For Steel and Cast Iron

Please use the UM breaker.

For the outer edge, use the CVD coated grade MC1020 for steel applications and the MC5020 grade for cast iron. For the inner edge the PVD coated grade VP15TF should be used. If fracturing occurs, VP15TF should be used for both positions to give extra stability.

For Stainless Steel



















For the best performance use the UM breaker for the peripheral edge and the US breaker for the inner edge. The selection of grade should be the same as used for steels.

For Hardened Steel and Preventing Fracture

For the inner edge, UH is the ideal breaker. The high-strength, highly negative wide land edges, together with the durable PVD coated carbide grade DP8020, are suitable for machining hardened steel (45HRC or lower) and preventing fracture in steel and cast iron.

For Aluminum Alloy Processing

For both the inner and outer edges, UN breakers are ideal. The polished finish and peripheral polishing prevent welding, and the combination of the positive lands and high rake angle further enhances the sharpness.

		1st Recommendation		When outer insert fractures	
		Outer Insert	Inner Insert	Outer Insert	Inner Insert
P	Mild Steel, Alloy Steel	MC1020 	VP15TF 	VP15TF 	VP15TF 
		UM Breaker	UM Breaker	UM Breaker	UM Breaker
M	Stainless Steel	MC1020 	VP15TF 	VP15TF 	VP15TF 
		UM Breaker	US Breaker	UM Breaker	US Breaker
K	Cast Iron	MC5020 	VP15TF 	VP15TF 	VP15TF 
		UM Breaker	UM Breaker	UM Breaker	UM Breaker
H	Hardened Steel	MC1020 	DP8020 	VP15TF 	DP8020 
		UM Breaker	UH Breaker	UM Breaker	UH Breaker
N	Aluminum Alloy	TF15 	TF15 		
		UN Breaker	UN Breaker		

Features of Grade

MC1020

MC1020 is a CVD coated grade for higher cutting speeds. The main properties are high wear and high plastic deformation resistance for reliability.

MC5020

MC5020 is a CVD coated grade suitable for drilling cast iron. It has excellent abrasion resistance and gives long tool life by controlling chipping and thermal cracking that can occur when drilling nodular cast iron.

VP15TF

VP15TF is a PVD coated grade suitable for a wide range of applications. The micro-grain substrate and Miracle coating provide excellent welding resistance.

DP8020

With the combination of a durable, special carbide substrate and high-hardness Ti-Al-Si coating, DP8020 is a PVD coated carbide grade suitable for hardened steel (45HRC or lower) and preventing fracture in steel and cast iron.

Special Application Examples

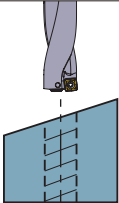
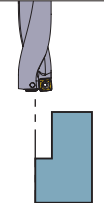
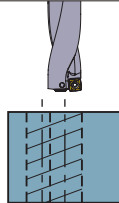
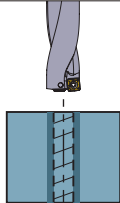
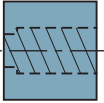
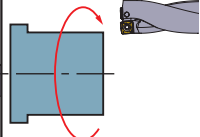
	Drilling on a Slope	Half Hole	Overlapped Holes	Boring	Internal Turning	External Turning
Cutting Mode						
vc (m/min)	80-160	80-160	80	80-160	80-160	80-160
fr (mm/rev)	0.05-0.11	0.05-0.08	0.08	0.05-0.08	0.05-0.11	0.05-0.11

For special applications use only up to a DCx4 length tool body.

Indexable Drill

MVX



L/D	Machining Tolerance(Guide)(mm)		
	ø17-ø33	ø33.5-ø47	ø48-ø63
2, 3	+0.25 0	+0.3 0	+0.3 0
4, 5	+0.35 0	+0.4 0	+0.45 0
6	+0.45 0	+0.6 0	-

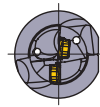

Maximum Offset for Turning

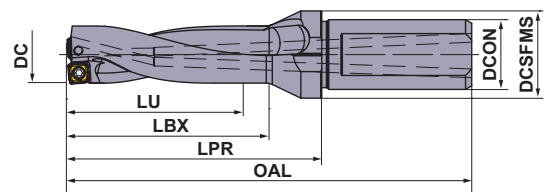
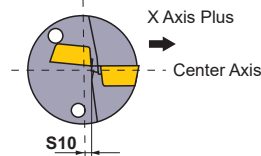



DC	Hole Depth (L/D)	Order Number	Stock	*2 No.T	LU	LBX	LPR	OAL	DCON	DCSFMS	S10	Insert Type	*1	
													Clamp Screw	Wrench
NEW 14.0	2	MVX1400X2F20	●	2	28	35	50	93	20	25	0.6	SOX05	TPS20-1	TIP06F
	3	MVX1400X3F20	●	2	42	49	64	107	20	25	0.6	SOX05	TPS20-1	TIP06F
	4	MVX1400X4F20	●	2	56	63	78	121	20	25	0.6	SOX05	TPS20-1	TIP06F
	5	MVX1400X5F20	●	2	70	77	92	135	20	25	0.6	SOX05	TPS20-1	TIP06F
NEW 14.5	2	MVX1450X2F20	●	2	29	36	51	94	20	25	0.5	SOX05	TPS20-1	TIP06F
	3	MVX1450X3F20	●	2	43.5	50.5	65.5	108.5	20	25	0.5	SOX05	TPS20-1	TIP06F
	4	MVX1450X4F20	●	2	58	65	80	123	20	25	0.5	SOX05	TPS20-1	TIP06F
	5	MVX1450X5F20	●	2	72.5	79.5	94.5	137.5	20	25	0.5	SOX05	TPS20-1	TIP06F
NEW 15.0	2	MVX1500X2F20	●	2	30	37	52	95	20	25	0.35	SOX05	TPS20-1	TIP06F
	3	MVX1500X3F20	●	2	45	52	67	110	20	25	0.35	SOX05	TPS20-1	TIP06F
	4	MVX1500X4F20	●	2	60	67	82	125	20	25	0.35	SOX05	TPS20-1	TIP06F
	5	MVX1500X5F20	●	2	75	82	97	140	20	25	0.35	SOX05	TPS20-1	TIP06F
NEW 15.5	2	MVX1550X2F20	●	2	31	38	53	96	20	25	0.3	SOX05	TPS20-1	TIP06F
	3	MVX1550X3F20	●	2	46.5	53.5	68.5	111.5	20	25	0.3	SOX05	TPS20-1	TIP06F
	4	MVX1550X4F20	●	2	62	69	84	127	20	25	0.3	SOX05	TPS20-1	TIP06F
	5	MVX1550X5F20	●	2	77.5	84.5	99.5	142.5	20	25	0.3	SOX05	TPS20-1	TIP06F
NEW 16.0	2	MVX1600X2F20	●	2	32	39	54	97	20	25	0.25	SOX05	TPS20-1	TIP06F
	3	MVX1600X3F20	●	2	48	55	70	113	20	25	0.25	SOX05	TPS20-1	TIP06F
	4	MVX1600X4F20	●	2	64	71	86	129	20	25	0.25	SOX05	TPS20-1	TIP06F
	5	MVX1600X5F20	●	2	80	87	102	145	20	25	0.25	SOX05	TPS20-1	TIP06F
NEW 16.5	2	MVX1650X2F20	●	2	33	40	55	98	20	25	0.25	SOX05	TPS20-1	TIP06F
	3	MVX1650X3F20	●	2	49.5	56.5	71.5	114.5	20	25	0.25	SOX05	TPS20-1	TIP06F
	4	MVX1650X4F20	●	2	66	73	88	131	20	25	0.25	SOX05	TPS20-1	TIP06F
	5	MVX1650X5F20	●	2	82.5	89.5	104.5	147.5	20	25	0.25	SOX05	TPS20-1	TIP06F
NEW 17.0	2	MVX1700X2F20	●	2	34	41	56	99	20	25	0.5	SOX06	TPS25	TIP07F
	3	MVX1700X3F20	●	2	51	58	73	116	20	25	0.5	SOX06	TPS25	TIP07F
	4	MVX1700X4F20	●	2	68	75	90	133	20	25	0.5	SOX06	TPS25	TIP07F
	5	MVX1700X5F20	●	2	85	92	107	150	20	25	0.5	SOX06	TPS25	TIP07F
	6	MVX1700X6F20	●	2	102	109	124	167	20	25	0.5	SOX06	TPS25	TIP07F
NEW 17.5	2	MVX1750X2F25	●	2	35	42	62	112	25	32	0.45	SOX06	TPS25	TIP07F
	3	MVX1750X3F25	●	2	52.5	59.5	79.5	129.5	25	32	0.45	SOX06	TPS25	TIP07F
	4	MVX1750X4F25	●	2	70	77	97	147	25	32	0.45	SOX06	TPS25	TIP07F
	5	MVX1750X5F25	●	2	87.5	94.5	114.5	164.5	25	32	0.45	SOX06	TPS25	TIP07F
	6	MVX1750X6F25	●	2	105	112	132	182	25	32	0.45	SOX06	TPS25	TIP07F

*1 Clamp Torque (N · m) : TPS20-1=0.6, TPS25=1.0

*2 Number of Teeth

(mm)

DC	Hole Depth (L/D)	Order Number	Stock	*2 No.T	LU	LBX	LPR	OAL	DCON	DCSFMS	S10	Insert Type	*1	
													 Clamp Screw	 Wrench
18.0	2	MVX1800X2F25	●	2	36	43	63	113	25	32	0.4	SOX06	TPS25	TIP07F
	3	MVX1800X3F25	●	2	54	61	81	131	25	32	0.4	SOX06	TPS25	TIP07F
	4	MVX1800X4F25	●	2	72	79	99	149	25	32	0.4	SOX06	TPS25	TIP07F
	5	MVX1800X5F25	●	2	90	97	117	167	25	32	0.4	SOX06	TPS25	TIP07F
	6	MVX1800X6F25	●	2	108	115	135	185	25	32	0.4	SOX06	TPS25	TIP07F
18.5	2	MVX1850X2F25	●	2	37	44	64	114	25	32	0.35	SOX06	TPS25	TIP07F
	3	MVX1850X3F25	●	2	55.5	62.5	82.5	132.5	25	32	0.35	SOX06	TPS25	TIP07F
	4	MVX1850X4F25	●	2	74	81	101	151	25	32	0.35	SOX06	TPS25	TIP07F
	5	MVX1850X5F25	●	2	92.5	99.5	119.5	169.5	25	32	0.35	SOX06	TPS25	TIP07F
	6	MVX1850X6F25	●	2	111	118	138	188	25	32	0.35	SOX06	TPS25	TIP07F
19.0	2	MVX1900X2F25	●	2	38	45	65	115	25	32	0.3	SOX06	TPS25	TIP07F
	3	MVX1900X3F25	●	2	57	64	84	134	25	32	0.3	SOX06	TPS25	TIP07F
	4	MVX1900X4F25	●	2	76	83	103	153	25	32	0.3	SOX06	TPS25	TIP07F
	5	MVX1900X5F25	●	2	95	102	122	172	25	32	0.3	SOX06	TPS25	TIP07F
	6	MVX1900X6F25	●	2	114	121	141	191	25	32	0.3	SOX06	TPS25	TIP07F
19.5	2	MVX1950X2F25	●	2	39	46	66	116	25	32	0.25	SOX06	TPS25	TIP07F
	3	MVX1950X3F25	●	2	58.5	65.5	85.5	135.5	25	32	0.25	SOX06	TPS25	TIP07F
	4	MVX1950X4F25	●	2	78	85	105	155	25	32	0.25	SOX06	TPS25	TIP07F
	5	MVX1950X5F25	●	2	97.5	104.5	124.5	174.5	25	32	0.25	SOX06	TPS25	TIP07F
	6	MVX1950X6F25	●	2	117	124	144	194	25	32	0.25	SOX06	TPS25	TIP07F
20.0	2	MVX2000X2F25	●	2	40	47	67	117	25	32	0.6	SOX07	TPS3	TIP10W
	3	MVX2000X3F25	●	2	60	67	87	137	25	32	0.6	SOX07	TPS3	TIP10W
	4	MVX2000X4F25	●	2	80	87	107	157	25	32	0.6	SOX07	TPS3	TIP10W
	5	MVX2000X5F25	●	2	100	107	127	177	25	32	0.6	SOX07	TPS3	TIP10W
	6	MVX2000X6F25	●	2	120	127	147	197	25	32	0.6	SOX07	TPS3	TIP10W
20.5	2	MVX2050X2F25	●	2	41	48	68	118	25	32	0.55	SOX07	TPS3	TIP10W
	3	MVX2050X3F25	●	2	61.5	68.5	88.5	138.5	25	32	0.55	SOX07	TPS3	TIP10W
21.0	2	MVX2100X2F25	●	2	42	49	69	119	25	32	0.5	SOX07	TPS3	TIP10W
	3	MVX2100X3F25	●	2	63	70	90	140	25	32	0.5	SOX07	TPS3	TIP10W
	4	MVX2100X4F25	●	2	84	91	111	161	25	32	0.5	SOX07	TPS3	TIP10W
	5	MVX2100X5F25	●	2	105	112	132	182	25	32	0.5	SOX07	TPS3	TIP10W
	6	MVX2100X6F25	●	2	126	133	153	203	25	32	0.5	SOX07	TPS3	TIP10W
21.5	2	MVX2150X2F25	●	2	43	50	70	120	25	32	0.45	SOX07	TPS3	TIP10W
	3	MVX2150X3F25	●	2	64.5	71.5	91.5	141.5	25	32	0.45	SOX07	TPS3	TIP10W
22.0	2	MVX2200X2F25	●	2	44	51	71	121	25	32	0.4	SOX07	TPS3	TIP10W
	3	MVX2200X3F25	●	2	66	73	93	143	25	32	0.4	SOX07	TPS3	TIP10W
	4	MVX2200X4F25	●	2	88	95	115	165	25	32	0.4	SOX07	TPS3	TIP10W
	5	MVX2200X5F25	●	2	110	117	137	187	25	32	0.4	SOX07	TPS3	TIP10W
	6	MVX2200X6F25	●	2	132	139	159	209	25	32	0.4	SOX07	TPS3	TIP10W
22.5	2	MVX2250X2F25	●	2	45	52	72	122	25	32	0.35	SOX07	TPS3	TIP10W
	3	MVX2250X3F25	●	2	67.5	74.5	94.5	144.5	25	32	0.35	SOX07	TPS3	TIP10W
23.0	2	MVX2300X2F25	●	2	46	53	73	123	25	32	0.8	SOX08	TPS351	TIP10W
	3	MVX2300X3F25	●	2	69	76	96	146	25	32	0.8	SOX08	TPS351	TIP10W
	4	MVX2300X4F25	●	2	92	99	119	169	25	32	0.8	SOX08	TPS351	TIP10W
	5	MVX2300X5F25	●	2	115	122	142	192	25	32	0.8	SOX08	TPS351	TIP10W
	6	MVX2300X6F25	●	2	138	145	165	215	25	32	0.8	SOX08	TPS351	TIP10W
23.5	2	MVX2350X2F25	●	2	47	54	74	124	25	32	0.75	SOX08	TPS351	TIP10W
	3	MVX2350X3F25	●	2	70.5	77.5	97.5	147.5	25	32	0.75	SOX08	TPS351	TIP10W

*1 Clamp Torque (N · m) : TPS25=1.0, TPS3=2.0, TPS351=2.5

*2 Number of Teeth



DC = Cutting Diameter
LU = Usable Length
LBX = Usable Length
LPR = Protruding Length

OAL = Overall Length
DCON = Fixing Part Depth
DCSFMS = Flange Diameter

Indexable Drill



(mm)

DC	Hole Depth (L/D)	Order Number	Stock	*2 No.T	LU	LBX	LPR	OAL	DCON	DCSFMS	S10	Insert Type	*1	
													 Clamp Screw	 Wrench
24.0	2	MVX2400X2F25	●	2	48	55	75	125	25	32	0.7	SOX08	TPS351	TIP10W
	3	MVX2400X3F25	●	2	72	79	99	149	25	32	0.7	SOX08	TPS351	TIP10W
	4	MVX2400X4F25	●	2	96	103	123	173	25	32	0.7	SOX08	TPS351	TIP10W
	5	MVX2400X5F25	●	2	120	127	147	197	25	32	0.7	SOX08	TPS351	TIP10W
	6	MVX2400X6F25	●	2	144	151	171	221	25	32	0.7	SOX08	TPS351	TIP10W
24.5	2	MVX2450X2F25	●	2	49	56	76	126	25	32	0.65	SOX08	TPS351	TIP10W
	3	MVX2450X3F25	●	2	73.5	80.5	100.5	150.5	25	32	0.65	SOX08	TPS351	TIP10W
25.0	2	MVX2500X2F25	●	2	50	57	77	127	25	32	0.6	SOX08	TPS351	TIP10W
	3	MVX2500X3F25	●	2	75	82	102	152	25	32	0.6	SOX08	TPS351	TIP10W
	4	MVX2500X4F25	●	2	100	107	127	177	25	32	0.6	SOX08	TPS351	TIP10W
	5	MVX2500X5F25	●	2	125	132	152	202	25	32	0.6	SOX08	TPS351	TIP10W
	6	MVX2500X6F25	●	2	150	157	177	227	25	32	0.6	SOX08	TPS351	TIP10W
25.5	2	MVX2550X2F25	●	2	51	58	78	128	25	32	0.6	SOX08	TPS351	TIP10W
	3	MVX2550X3F25	●	2	76.5	83.5	103.5	153.5	25	32	0.6	SOX08	TPS351	TIP10W
26.0	2	MVX2600X2F32	●	2	52	59	79	134	32	42	0.5	SOX08	TPS351	TIP10W
	3	MVX2600X3F32	●	2	78	85	105	160	32	42	0.5	SOX08	TPS351	TIP10W
	4	MVX2600X4F32	●	2	104	111	131	186	32	42	0.5	SOX08	TPS351	TIP10W
	5	MVX2600X5F32	●	2	130	137	157	212	32	42	0.5	SOX08	TPS351	TIP10W
	6	MVX2600X6F32	●	2	156	163	183	238	32	42	0.5	SOX08	TPS351	TIP10W
26.5	2	MVX2650X2F32	●	2	53	60	80	135	32	42	0.5	SOX08	TPS351	TIP10W
	3	MVX2650X3F32	●	2	79.5	86.5	106.5	161.5	32	42	0.5	SOX08	TPS351	TIP10W
27.0	2	MVX2700X2F32	●	2	54	61	81	136	32	42	0.45	SOX08	TPS351	TIP10W
	3	MVX2700X3F32	●	2	81	88	108	163	32	42	0.45	SOX08	TPS351	TIP10W
	4	MVX2700X4F32	●	2	108	115	135	190	32	42	0.45	SOX08	TPS351	TIP10W
	5	MVX2700X5F32	●	2	135	142	162	217	32	42	0.45	SOX08	TPS351	TIP10W
	6	MVX2700X6F32	●	2	162	169	189	244	32	42	0.45	SOX08	TPS351	TIP10W
27.5	2	MVX2750X2F32	●	2	55	62	82	137	32	42	0.4	SOX08	TPS351	TIP10W
	3	MVX2750X3F32	●	2	82.5	89.5	109.5	164.5	32	42	0.4	SOX08	TPS351	TIP10W
28.0	2	MVX2800X2F32	●	2	56	63	83	138	32	42	0.85	SOX09	TPS4	TIP15W
	3	MVX2800X3F32	●	2	84	91	111	166	32	42	0.85	SOX09	TPS4	TIP15W
	4	MVX2800X4F32	●	2	112	119	139	194	32	42	0.85	SOX09	TPS4	TIP15W
	5	MVX2800X5F32	●	2	140	147	167	222	32	42	0.85	SOX09	TPS4	TIP15W
	6	MVX2800X6F32	●	2	168	175	195	250	32	42	0.85	SOX09	TPS4	TIP15W
28.5	2	MVX2850X2F32	●	2	57	64	84	139	32	42	0.8	SOX09	TPS4	TIP15W
	3	MVX2850X3F32	●	2	85.5	92.5	112.5	167.5	32	42	0.8	SOX09	TPS4	TIP15W
29.0	2	MVX2900X2F32	●	2	58	65	85	140	32	42	0.75	SOX09	TPS4	TIP15W
	3	MVX2900X3F32	●	2	87	94	114	169	32	42	0.75	SOX09	TPS4	TIP15W
	4	MVX2900X4F32	●	2	116	123	143	198	32	42	0.75	SOX09	TPS4	TIP15W
	5	MVX2900X5F32	●	2	145	152	172	227	32	42	0.75	SOX09	TPS4	TIP15W
	6	MVX2900X6F32	●	2	174	181	201	256	32	42	0.75	SOX09	TPS4	TIP15W
29.5	2	MVX2950X2F32	●	2	59	66	86	141	32	42	0.7	SOX09	TPS4	TIP15W
	3	MVX2950X3F32	●	2	88.5	95.5	115.5	170.5	32	42	0.7	SOX09	TPS4	TIP15W
30.0	2	MVX3000X2F32	●	2	60	67	87	142	32	42	0.65	SOX09	TPS4	TIP15W
	3	MVX3000X3F32	●	2	90	97	117	172	32	42	0.65	SOX09	TPS4	TIP15W
	4	MVX3000X4F32	●	2	120	127	147	202	32	42	0.65	SOX09	TPS4	TIP15W
	5	MVX3000X5F32	●	2	150	157	177	232	32	42	0.65	SOX09	TPS4	TIP15W
	6	MVX3000X6F32	●	2	180	187	207	262	32	42	0.65	SOX09	TPS4	TIP15W
30.5	3	MVX3050X3F32	●	2	91.5	98.5	118.5	173.5	32	42	0.6	SOX09	TPS4	TIP15W

*1 Clamp Torque (N · m) : TPS351=2.5, TPS4=3.5

*2 Number of Teeth

● : Inventory maintained in Japan.

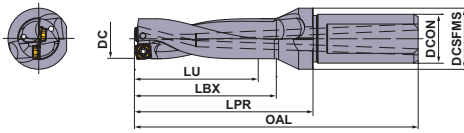

DC	Hole Depth (L/D)	Order Number	Stock	*2 No.T	LU	LBX	LPR	OAL	DCON	DCSFMS	S10	Insert Type	(mm)	
													*1 Clamp Screw	Wrench
31.0	2	MVX3100X2F40	●	2	62	69	89	154	40	50	0.55	SOX09	TPS4	TIP15W
	3	MVX3100X3F40	●	2	93	100	120	185	40	50	0.55	SOX09	TPS4	TIP15W
	4	MVX3100X4F40	●	2	124	131	151	216	40	50	0.55	SOX09	TPS4	TIP15W
	5	MVX3100X5F40	●	2	155	162	182	247	40	50	0.55	SOX09	TPS4	TIP15W
	6	MVX3100X6F40	●	2	186	193	213	278	40	50	0.55	SOX09	TPS4	TIP15W
31.5	3	MVX3150X3F40	●	2	94.5	101.5	121.5	186.5	40	50	0.55	SOX09	TPS4	TIP15W
32.0	2	MVX3200X2F40	●	2	64	71	91	156	40	50	0.45	SOX09	TPS4	TIP15W
	3	MVX3200X3F40	●	2	96	103	123	188	40	50	0.45	SOX09	TPS4	TIP15W
	4	MVX3200X4F40	●	2	128	135	155	220	40	50	0.45	SOX09	TPS4	TIP15W
	5	MVX3200X5F40	●	2	160	167	187	252	40	50	0.45	SOX09	TPS4	TIP15W
	6	MVX3200X6F40	●	2	192	199	219	284	40	50	0.45	SOX09	TPS4	TIP15W
32.5	3	MVX3250X3F40	●	2	97.5	104.5	124.5	189.5	40	50	0.45	SOX09	TPS4	TIP15W
33.0	2	MVX3300X2F40	●	2	66	73	93	158	40	50	0.4	SOX09	TPS4	TIP15W
	3	MVX3300X3F40	●	2	99	106	126	191	40	50	0.4	SOX09	TPS4	TIP15W
	4	MVX3300X4F40	●	2	132	139	159	224	40	50	0.4	SOX09	TPS4	TIP15W
	5	MVX3300X5F40	●	2	165	172	192	257	40	50	0.4	SOX09	TPS4	TIP15W
	6	MVX3300X6F40	●	2	198	205	225	290	40	50	0.4	SOX09	TPS4	TIP15W
33.5	3	MVX3350X3F40	●	2	100.5	107.5	127.5	192.5	40	50	1.15	SOX11	TPS43	TIP15W
34.0	2	MVX3400X2F40	●	2	68	75	105	170	40	50	1.11	SOX11	TPS43	TIP15W
	3	MVX3400X3F40	●	2	102	109	139	204	40	50	1.11	SOX11	TPS43	TIP15W
	4	MVX3400X4F40	●	2	136	143	173	238	40	50	1.11	SOX11	TPS43	TIP15W
	5	MVX3400X5F40	●	2	170	177	207	272	40	50	1.11	SOX11	TPS43	TIP15W
	6	MVX3400X6F40	●	2	204	211	241	306	40	50	1.1	SOX11	TPS43	TIP15W
34.5	3	MVX3450X3F40	●	2	103.5	110.5	140.5	205.5	40	50	1.08	SOX11	TPS43	TIP15W
35.0	2	MVX3500X2F40	●	2	70	77	107	172	40	50	1.03	SOX11	TPS43	TIP15W
	3	MVX3500X3F40	●	2	105	112	142	207	40	50	1.03	SOX11	TPS43	TIP15W
	4	MVX3500X4F40	●	2	140	147	177	242	40	50	1.03	SOX11	TPS43	TIP15W
	5	MVX3500X5F40	●	2	175	182	212	277	40	50	1.03	SOX11	TPS43	TIP15W
	6	MVX3500X6F40	●	2	210	217	247	312	40	50	1.02	SOX11	TPS43	TIP15W
35.5	3	MVX3550X3F40	●	2	106.5	113.5	143.5	208.5	40	50	0.99	SOX11	TPS43	TIP15W
36.0	2	MVX3600X2F40	●	2	72	79	109	174	40	50	0.95	SOX11	TPS43	TIP15W
	3	MVX3600X3F40	●	2	108	115	145	210	40	50	0.95	SOX11	TPS43	TIP15W
	4	MVX3600X4F40	●	2	144	151	181	246	40	50	0.95	SOX11	TPS43	TIP15W
	5	MVX3600X5F40	●	2	180	187	217	282	40	50	0.95	SOX11	TPS43	TIP15W
	6	MVX3600X6F40	●	2	216	223	253	318	40	50	0.94	SOX11	TPS43	TIP15W
37.0	2	MVX3700X2F40	●	2	74	81	111	176	40	50	0.87	SOX11	TPS43	TIP15W
	3	MVX3700X3F40	●	2	111	118	148	213	40	50	0.87	SOX11	TPS43	TIP15W
	4	MVX3700X4F40	●	2	148	155	185	250	40	50	0.87	SOX11	TPS43	TIP15W
	5	MVX3700X5F40	●	2	185	192	222	287	40	50	0.87	SOX11	TPS43	TIP15W
	6	MVX3700X6F40	●	2	222	229	259	324	40	50	0.86	SOX11	TPS43	TIP15W
38.0	2	MVX3800X2F40	●	2	76	83	113	178	40	50	0.79	SOX11	TPS43	TIP15W
	3	MVX3800X3F40	●	2	114	121	151	216	40	50	0.79	SOX11	TPS43	TIP15W
	4	MVX3800X4F40	●	2	152	159	189	254	40	50	0.79	SOX11	TPS43	TIP15W
	5	MVX3800X5F40	●	2	190	197	227	292	40	50	0.79	SOX11	TPS43	TIP15W
	6	MVX3800X6F40	●	2	228	235	265	330	40	50	0.78	SOX11	TPS43	TIP15W
39.0	2	MVX3900X2F40	●	2	78	85	115	180	40	50	0.71	SOX11	TPS43	TIP15W
	3	MVX3900X3F40	●	2	117	124	154	219	40	50	0.71	SOX11	TPS43	TIP15W
	4	MVX3900X4F40	●	2	156	163	193	258	40	50	0.71	SOX11	TPS43	TIP15W
	5	MVX3900X5F40	●	2	195	202	232	297	40	50	0.71	SOX11	TPS43	TIP15W
	6	MVX3900X6F40	●	2	234	241	271	336	40	50	0.7	SOX11	TPS43	TIP15W

*1 Clamp Torque (N · m) : TPS4=3.5, TPS43=3.5

*2 Number of Teeth

DC = Cutting Diameter

LU = Usable Length

LBX = Usable Length

LPR = Protruding Length

OAL = Overall Length



DCON = Fixing Part Depth

DCSFMS = Flange Diameter

Indexable Drill



(mm)

DC	Hole Depth (L/D)	Order Number	Stock	*2 No.T	LU	LBX	LPR	OAL	DCON	DCSFMS	S10	Insert Type	*1	
													 Clamp Screw	 Wrench
40.0	2	MVX4000X2F40	●	2	80	87	117	182	40	50	1.46	SOX13	TPS43	TIP15W
	3	MVX4000X3F40	●	2	120	127	157	222	40	50	1.46	SOX13	TPS43	TIP15W
	4	MVX4000X4F40	●	2	160	167	197	262	40	50	1.46	SOX13	TPS43	TIP15W
	5	MVX4000X5F40	●	2	200	207	237	302	40	50	1.46	SOX13	TPS43	TIP15W
	6	MVX4000X6F40	●	2	240	247	277	342	40	50	1.45	SOX13	TPS43	TIP15W
41.0	2	MVX4100X2F40	●	2	82	89	119	184	40	50	1.36	SOX13	TPS43	TIP15W
	3	MVX4100X3F40	●	2	123	130	160	225	40	50	1.36	SOX13	TPS43	TIP15W
	4	MVX4100X4F40	●	2	164	171	201	266	40	50	1.36	SOX13	TPS43	TIP15W
	5	MVX4100X5F40	●	2	205	212	242	307	40	50	1.36	SOX13	TPS43	TIP15W
	6	MVX4100X6F40	●	2	246	253	283	348	40	50	1.35	SOX13	TPS43	TIP15W
42.0	2	MVX4200X2F40	●	2	84	91	121	186	40	50	1.27	SOX13	TPS43	TIP15W
	3	MVX4200X3F40	●	2	126	133	163	228	40	50	1.27	SOX13	TPS43	TIP15W
	4	MVX4200X4F40	●	2	168	175	205	270	40	63	1.27	SOX13	TPS43	TIP15W
	4	MVX4200X4F50	●	2	168	175	205	280	50	63	1.27	SOX13	TPS43	TIP15W
	5	MVX4200X5F40	●	2	210	217	247	312	40	63	1.27	SOX13	TPS43	TIP15W
	5	MVX4200X5F50	●	2	210	217	247	322	50	63	1.27	SOX13	TPS43	TIP15W
	6	MVX4200X6F40	●	2	252	259	289	354	40	63	1.27	SOX13	TPS43	TIP15W
6	MVX4200X6F50	●	2	252	259	289	364	50	63	1.26	SOX13	TPS43	TIP15W	
43.0	2	MVX4300X2F40	●	2	86	93	123	188	40	50	1.18	SOX13	TPS43	TIP15W
	3	MVX4300X3F40	●	2	129	136	166	231	40	50	1.18	SOX13	TPS43	TIP15W
	4	MVX4300X4F40	●	2	172	179	209	274	40	63	1.18	SOX13	TPS43	TIP15W
	4	MVX4300X4F50	●	2	172	179	209	284	50	63	1.18	SOX13	TPS43	TIP15W
	5	MVX4300X5F40	●	2	215	222	252	317	40	63	1.18	SOX13	TPS43	TIP15W
	5	MVX4300X5F50	●	2	215	222	252	327	50	63	1.18	SOX13	TPS43	TIP15W
	6	MVX4300X6F40	●	2	258	265	295	360	40	63	1.17	SOX13	TPS43	TIP15W
6	MVX4300X6F50	●	2	258	265	295	370	50	63	1.17	SOX13	TPS43	TIP15W	
44.0	2	MVX4400X2F40	●	2	88	95	125	190	40	50	1.08	SOX13	TPS43	TIP15W
	3	MVX4400X3F40	●	2	132	139	169	234	40	50	1.08	SOX13	TPS43	TIP15W
	4	MVX4400X4F40	●	2	176	183	213	278	40	63	1.08	SOX13	TPS43	TIP15W
	4	MVX4400X4F50	●	2	176	183	213	288	50	63	1.08	SOX13	TPS43	TIP15W
	5	MVX4400X5F40	●	2	220	227	257	322	40	63	1.08	SOX13	TPS43	TIP15W
	5	MVX4400X5F50	●	2	220	227	257	332	50	63	1.08	SOX13	TPS43	TIP15W
45.0	2	MVX4500X2F40	●	2	90	97	127	192	40	50	0.99	SOX13	TPS43	TIP15W
	3	MVX4500X3F40	●	2	135	142	172	237	40	50	0.99	SOX13	TPS43	TIP15W
	4	MVX4500X4F40	●	2	180	187	217	282	40	63	0.99	SOX13	TPS43	TIP15W
	4	MVX4500X4F50	●	2	180	187	217	292	50	63	0.99	SOX13	TPS43	TIP15W
	5	MVX4500X5F40	●	2	225	232	262	327	40	63	0.99	SOX13	TPS43	TIP15W
	5	MVX4500X5F50	●	2	225	232	262	337	50	63	0.99	SOX13	TPS43	TIP15W
46.0	2	MVX4600X2F40	●	2	92	99	129	194	40	50	0.89	SOX13	TPS43	TIP15W
	3	MVX4600X3F40	●	2	138	145	175	240	40	50	0.89	SOX13	TPS43	TIP15W
	4	MVX4600X4F40	●	2	184	191	221	286	40	63	0.89	SOX13	TPS43	TIP15W
	4	MVX4600X4F50	●	2	184	191	221	296	50	63	0.89	SOX13	TPS43	TIP15W
	5	MVX4600X5F40	●	2	230	237	267	332	40	63	0.89	SOX13	TPS43	TIP15W
	5	MVX4600X5F50	●	2	230	237	267	342	50	63	0.89	SOX13	TPS43	TIP15W
47.0	2	MVX4700X2F40	●	2	94	101	141	206	40	63	1.9	SOX16	TPS54	TIP25D
	3	MVX4700X3F40	●	2	141	148	188	253	40	63	1.9	SOX16	TPS54	TIP25D
	4	MVX4700X4F40	●	2	188	195	235	300	40	63	1.9	SOX16	TPS54	TIP25D
	4	MVX4700X4F50	●	2	188	195	235	310	50	63	1.9	SOX16	TPS54	TIP25D
	5	MVX4700X5F40	●	2	235	242	282	347	40	63	1.9	SOX16	TPS54	TIP25D
	5	MVX4700X5F50	●	2	235	242	282	357	50	63	1.9	SOX16	TPS54	TIP25D

*1 Clamp Torque (N · m) : TPS43=3.5, TPS54=7.5

*2 Number of Teeth

● : Inventory maintained in Japan.

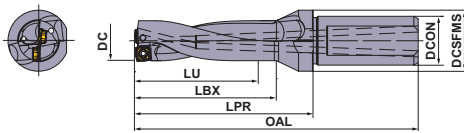

(mm)

DC	Hole Depth (L/D)	Order Number	Stock	*2 No.T	LU	LBX	LPR	OAL	DCON	DCSFMS	S10	Insert Type	*1	
													Clamp Screw	Wrench
48.0	2	MVX4800X2F40	●	2	96	103	143	208	40	63	1.8	SOX16	TPS54	TIP25D
	3	MVX4800X3F40	●	2	144	151	191	256	40	63	1.8	SOX16	TPS54	TIP25D
	4	MVX4800X4F40	●	2	192	199	239	304	40	63	1.8	SOX16	TPS54	TIP25D
	4	MVX4800X4F50	●	2	192	199	239	314	50	63	1.8	SOX16	TPS54	TIP25D
	5	MVX4800X5F40	●	2	240	247	287	352	40	63	1.8	SOX16	TPS54	TIP25D
	5	MVX4800X5F50	●	2	240	247	287	362	50	63	1.8	SOX16	TPS54	TIP25D
49.0	2	MVX4900X2F40	●	2	98	105	145	210	40	63	1.7	SOX16	TPS54	TIP25D
	3	MVX4900X3F40	●	2	147	154	194	259	40	63	1.7	SOX16	TPS54	TIP25D
	4	MVX4900X4F40	●	2	196	203	243	308	40	63	1.7	SOX16	TPS54	TIP25D
	4	MVX4900X4F50	●	2	196	203	243	318	50	63	1.7	SOX16	TPS54	TIP25D
	5	MVX4900X5F40	●	2	245	252	292	357	40	63	1.7	SOX16	TPS54	TIP25D
	5	MVX4900X5F50	●	2	245	252	292	367	50	63	1.7	SOX16	TPS54	TIP25D
50.0	2	MVX5000X2F40	●	2	100	107	147	212	40	63	1.6	SOX16	TPS54	TIP25D
	3	MVX5000X3F40	●	2	150	157	197	262	40	63	1.6	SOX16	TPS54	TIP25D
	4	MVX5000X4F40	●	2	200	207	247	312	40	63	1.6	SOX16	TPS54	TIP25D
	4	MVX5000X4F50	●	2	200	207	247	322	50	63	1.6	SOX16	TPS54	TIP25D
	5	MVX5000X5F40	●	2	250	257	297	362	40	63	1.6	SOX16	TPS54	TIP25D
	5	MVX5000X5F50	●	2	250	257	297	372	50	63	1.6	SOX16	TPS54	TIP25D
51.0	2	MVX5100X2F40	●	2	102	109	149	214	40	63	1.5	SOX16	TPS54	TIP25D
	3	MVX5100X3F40	●	2	153	160	200	265	40	63	1.5	SOX16	TPS54	TIP25D
	4	MVX5100X4F40	●	2	204	211	251	316	40	63	1.5	SOX16	TPS54	TIP25D
	4	MVX5100X4F50	●	2	204	211	251	326	50	63	1.5	SOX16	TPS54	TIP25D
	5	MVX5100X5F40	●	2	255	262	302	367	40	63	1.5	SOX16	TPS54	TIP25D
	5	MVX5100X5F50	●	2	255	262	302	377	50	63	1.5	SOX16	TPS54	TIP25D
52.0	2	MVX5200X2F40	●	2	104	111	151	216	40	63	1.39	SOX16	TPS54	TIP25D
	3	MVX5200X3F40	●	2	156	163	203	268	40	63	1.39	SOX16	TPS54	TIP25D
	4	MVX5200X4F40	●	2	208	215	255	320	40	63	1.39	SOX16	TPS54	TIP25D
	4	MVX5200X4F50	●	2	208	215	255	330	50	63	1.39	SOX16	TPS54	TIP25D
	5	MVX5200X5F40	●	2	260	267	307	372	40	63	1.39	SOX16	TPS54	TIP25D
	5	MVX5200X5F50	●	2	260	267	307	382	50	63	1.39	SOX16	TPS54	TIP25D
53.0	2	MVX5300X2F40	●	2	106	113	153	218	40	63	1.29	SOX16	TPS54	TIP25D
	3	MVX5300X3F40	●	2	159	166	206	271	40	63	1.29	SOX16	TPS54	TIP25D
	4	MVX5300X4F40	●	2	212	219	259	324	40	63	1.29	SOX16	TPS54	TIP25D
	4	MVX5300X4F50	●	2	212	219	259	334	50	63	1.29	SOX16	TPS54	TIP25D
	5	MVX5300X5F40	●	2	265	272	312	377	40	63	1.29	SOX16	TPS54	TIP25D
	5	MVX5300X5F50	●	2	265	272	312	387	50	63	1.29	SOX16	TPS54	TIP25D
54.0	2	MVX5400X2F40	●	2	108	115	155	220	40	63	1.19	SOX16	TPS54	TIP25D
	3	MVX5400X3F40	●	2	162	169	209	274	40	63	1.19	SOX16	TPS54	TIP25D
	4	MVX5400X4F40	●	2	216	223	263	328	40	63	1.19	SOX16	TPS54	TIP25D
	4	MVX5400X4F50	●	2	216	223	263	338	50	63	1.19	SOX16	TPS54	TIP25D
	5	MVX5400X5F40	●	2	270	277	317	382	40	63	1.19	SOX16	TPS54	TIP25D
	5	MVX5400X5F50	●	2	270	277	317	392	50	63	1.19	SOX16	TPS54	TIP25D
55.0	2	MVX5500X2F40	●	2	110	117	157	222	40	63	1.08	SOX16	TPS54	TIP25D
	3	MVX5500X3F40	●	2	165	172	212	277	40	63	1.08	SOX16	TPS54	TIP25D
	4	MVX5500X4F40	●	2	220	227	267	332	40	63	1.08	SOX16	TPS54	TIP25D
	4	MVX5500X4F50	●	2	220	227	267	342	50	63	1.08	SOX16	TPS54	TIP25D
	5	MVX5500X5F40	●	2	275	282	322	387	40	63	1.08	SOX16	TPS54	TIP25D
	5	MVX5500X5F50	●	2	275	282	322	397	50	63	1.08	SOX16	TPS54	TIP25D

*1 Clamp Torque (N • m) : TPS54=7.5

*2 Number of Teeth

DC = Cutting Diameter
 LU = Usable Length
 LBX = Usable Length
 LPR = Protruding Length

OAL = Overall Length
 DCON = Fixing Part Depth
 DCSFMS = Flange Diameter

Indexable Drill



(mm)

DC	Hole Depth (L/D)	Order Number	Stock	*2 No.T	LU	LBX	LPR	OAL	DCON	DCSFMS	S10	Insert Type	*1	
													Clamp Screw	Wrench
56.0	2	MVX5600X2F40	●	2	112	119	159	224	40	63	0.98	SOX16	TPS54	TIP25D
	3	MVX5600X3F40	●	2	168	175	215	280	40	63	0.98	SOX16	TPS54	TIP25D
	4	MVX5600X4F40	●	2	224	231	271	336	40	63	0.98	SOX16	TPS54	TIP25D
	4	MVX5600X4F50	●	2	224	231	271	346	50	63	0.98	SOX16	TPS54	TIP25D
	5	MVX5600X5F40	●	2	280	287	327	392	40	63	0.98	SOX16	TPS54	TIP25D
	5	MVX5600X5F50	●	2	280	287	327	402	50	63	0.98	SOX16	TPS54	TIP25D
57.0	2	MVX5700X2F40	●	2	114	121	161	226	40	68	1.47	SOX18	TPS54	TIP25D
	3	MVX5700X3F40	●	2	171	178	218	283	40	68	1.47	SOX18	TPS54	TIP25D
	4	MVX5700X4F40	●	2	228	235	275	340	40	68	1.47	SOX18	TPS54	TIP25D
	4	MVX5700X4F50	●	2	228	235	275	350	50	68	1.47	SOX18	TPS54	TIP25D
	5	MVX5700X5F40	●	2	285	292	332	397	40	68	1.47	SOX18	TPS54	TIP25D
	5	MVX5700X5F50	●	2	285	292	332	407	50	68	1.47	SOX18	TPS54	TIP25D
58.0	2	MVX5800X2F40	●	2	116	123	163	228	40	68	1.37	SOX18	TPS54	TIP25D
	3	MVX5800X3F40	●	2	174	181	221	286	40	68	1.37	SOX18	TPS54	TIP25D
	4	MVX5800X4F40	●	2	232	239	279	344	40	68	1.37	SOX18	TPS54	TIP25D
	4	MVX5800X4F50	●	2	232	239	279	354	50	68	1.37	SOX18	TPS54	TIP25D
	5	MVX5800X5F40	●	2	290	297	337	402	40	68	1.37	SOX18	TPS54	TIP25D
	5	MVX5800X5F50	●	2	290	297	337	412	50	68	1.37	SOX18	TPS54	TIP25D
59.0	2	MVX5900X2F40	●	2	118	125	165	230	40	68	1.26	SOX18	TPS54	TIP25D
	3	MVX5900X3F40	●	2	177	184	224	289	40	68	1.26	SOX18	TPS54	TIP25D
	4	MVX5900X4F40	●	2	236	243	283	348	40	68	1.26	SOX18	TPS54	TIP25D
	4	MVX5900X4F50	●	2	236	243	283	358	50	68	1.26	SOX18	TPS54	TIP25D
	5	MVX5900X5F40	●	2	295	302	342	407	40	68	1.26	SOX18	TPS54	TIP25D
	5	MVX5900X5F50	●	2	295	302	342	417	50	68	1.26	SOX18	TPS54	TIP25D
60.0	2	MVX6000X2F40	●	2	120	127	167	232	40	68	1.16	SOX18	TPS54	TIP25D
	3	MVX6000X3F40	●	2	180	187	227	292	40	68	1.16	SOX18	TPS54	TIP25D
	4	MVX6000X4F40	●	2	240	247	287	352	40	68	1.16	SOX18	TPS54	TIP25D
	4	MVX6000X4F50	●	2	240	247	287	362	50	68	1.16	SOX18	TPS54	TIP25D
	5	MVX6000X5F40	●	2	300	307	347	412	40	68	1.16	SOX18	TPS54	TIP25D
	5	MVX6000X5F50	●	2	300	307	347	422	50	68	1.16	SOX18	TPS54	TIP25D
61.0	2	MVX6100X2F40	●	2	122	129	169	234	40	68	1.05	SOX18	TPS54	TIP25D
	3	MVX6100X3F40	●	2	183	190	230	295	40	68	1.05	SOX18	TPS54	TIP25D
	4	MVX6100X4F40	●	2	244	251	291	356	40	68	1.05	SOX18	TPS54	TIP25D
	4	MVX6100X4F50	●	2	244	251	291	366	50	68	1.05	SOX18	TPS54	TIP25D
	5	MVX6100X5F40	●	2	305	312	352	417	40	68	1.05	SOX18	TPS54	TIP25D
	5	MVX6100X5F50	●	2	305	312	352	427	50	68	1.05	SOX18	TPS54	TIP25D
62.0	2	MVX6200X2F40	●	2	124	131	171	236	40	68	0.95	SOX18	TPS54	TIP25D
	3	MVX6200X3F40	●	2	186	193	233	298	40	68	0.95	SOX18	TPS54	TIP25D
	4	MVX6200X4F40	●	2	248	255	295	360	40	68	0.95	SOX18	TPS54	TIP25D
	4	MVX6200X4F50	●	2	248	255	295	370	50	68	0.95	SOX18	TPS54	TIP25D
	5	MVX6200X5F40	●	2	310	317	357	422	40	68	0.95	SOX18	TPS54	TIP25D
	5	MVX6200X5F50	●	2	310	317	357	432	50	68	0.95	SOX18	TPS54	TIP25D
63.0	2	MVX6300X2F40	●	2	126	133	173	238	40	68	0.85	SOX18	TPS54	TIP25D
	3	MVX6300X3F40	●	2	189	196	236	301	40	68	0.85	SOX18	TPS54	TIP25D
	4	MVX6300X4F40	●	2	252	259	299	364	40	68	0.85	SOX18	TPS54	TIP25D
	4	MVX6300X4F50	●	2	252	259	299	374	50	68	0.85	SOX18	TPS54	TIP25D
	5	MVX6300X5F40	●	2	315	322	362	427	40	68	0.85	SOX18	TPS54	TIP25D
	5	MVX6300X5F50	●	2	315	322	362	437	50	68	0.85	SOX18	TPS54	TIP25D

*1 Clamp Torque (N · m) : TPS54=7.5

*2 Number of Teeth

● : Inventory maintained in Japan.

DC = Cutting Diameter

LU = Usable Length

LBX = Usable Length

LPR = Protruding Length







OAL = Overall Length

DCON = Fixing Part Depth

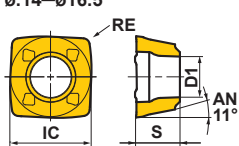
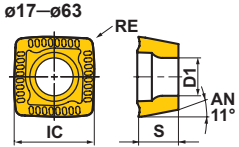
DCSFMS = Flange Diameter

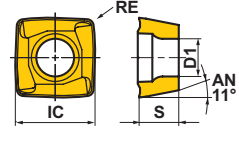
Inserts

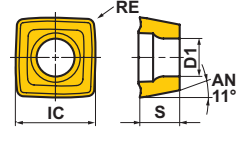
(mm)

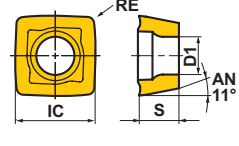
Shape	Drill Dia.	Insert Number	IC	S	RE	D1	Stock					Geometry
							MC5020	MC1020	VP15TF	DP8020	TF15	
UM  General Purpose	ø14-ø16.5	NEW SOMX052704-UM	5.0	2.7	0.4	2.5	●	●	●			ø.14-ø16.5  ø17-ø63 
	ø17-ø19.5	SOMX063005-UM	6.0	3.0	0.5	2.9	●	●	●			
	ø20-ø22.5	SOMX073505-UM	7.0	3.5	0.5	3.5	●	●	●			
	ø23-ø27.5	SOMX084005-UM	8.3	4.0	0.5	4.0	●	●	●			
	ø28-ø33	SOMX094506-UM	9.7	4.5	0.6	4.6	●	●	●			
	ø33.5-ø39	SOMX115506-UM	11.6	5.5	0.6	4.7	●	●	●			
	ø40-ø46	SOMX136008-UM	13.8	6.0	0.8	4.7	●	●	●			
	ø47-ø56	SOMX166508-UM	16.5	6.5	0.8	5.6	●	●	●			
ø57-ø63	SOMX187008-UM	18.2	7.0	0.8	5.6	●	●	●				
US  For Stainless Steel and Inner Edge	ø17-ø19.5	SOMX063005-US	6.0	3.0	0.5	2.9			●			
	ø20-ø22.5	SOMX073505-US	7.0	3.5	0.5	3.5			●			
	ø23-ø27.5	SOMX084005-US	8.3	4.0	0.5	4.0			●			
	ø28-ø33	SOMX094506-US	9.7	4.5	0.6	4.6			●			
	ø33.5-ø39	SOMX115506-US	11.6	5.5	0.6	4.7			●			
	ø40-ø46	SOMX136008-US	13.8	6.0	0.8	4.7			●			
	ø47-ø56	SOMX166508-US	16.5	6.5	0.8	5.6			●			
	ø57-ø63	SOMX187008-US	18.2	7.0	0.8	5.6			●			
UH  Strong Cutting Edge Type and Inner Edge	ø17-ø19.5	SOMX062905-UH	6.0	2.9	0.5	2.9				●		
	ø20-ø22.5	SOMX073405-UH	7.0	3.4	0.5	3.5				●		
	ø23-ø27.5	SOMX083905-UH	8.3	3.9	0.5	4.0				●		
	ø28-ø33	SOMX094406-UH	9.7	4.4	0.6	4.6				●		
	ø33.5-ø39	SOMX115406-UH	11.6	5.4	0.6	4.7				●		
	ø40-ø46	SOMX135908-UH	13.8	5.9	0.8	4.7				●		
	ø47-ø56	SOMX166408-UH	16.5	6.4	0.8	5.6				●		
	ø57-ø63	SOMX186908-UH	18.2	6.9	0.8	5.6				●		
UN  For Aluminum Alloy	ø17-ø19.5	SOGX063005-UN	6.0	3.0	0.5	2.9					●	
	ø20-ø22.5	SOGX073505-UN	7.0	3.5	0.5	3.5					●	
	ø23-ø27.5	SOGX084005-UN	8.3	4.0	0.5	4.0					●	
	ø28-ø33	SOGX094506-UN	9.7	4.5	0.6	4.6					●	
	ø33.5-ø39	SOGX115506-UN	11.6	5.5	0.6	4.7					●	
	ø40-ø46	SOGX136008-UN	13.8	6.0	0.8	4.7					●	
	ø47-ø56	SOGX166508-UN	16.5	6.5	0.8	5.6					●	
	ø57-ø63	SOGX187008-UN	18.2	7.0	0.8	5.6					●	

(Note 1) MC1020 and MC5020 are made exclusively for use as an outer insert.

(Note 2) DP8020 are made exclusively for use as an inner insert.

Recommended Cutting Conditions

	Work Material	Hardness	vc (m/min)	Inner Breaker	φ14—φ16.5			
					fr (mm/rev)			
					L/D=2, 3	4	5	
P	Mild Steel	≤180HB	200 (180—235)	UM	0.05 (0.04—0.06)	0.05 (0.04—0.06)	0.05 (0.04—0.06)	
				UH	—	—	—	
	Carbon Steel, Alloy Steel	180—280HB	140 (115—180)	UM	0.08 (0.06—0.14)	0.08 (0.06—0.09)	0.08 (0.06—0.09)	
				UH	—	—	—	
	Carbon Steel, Alloy Steel	280—350HB	100 (75—140)	UM	0.08 (0.06—0.14)	0.08 (0.06—0.09)	0.08 (0.06—0.09)	
				UH	—	—	—	
	Alloy Tool Steel	≤350HB	135 (100—170)	UM	0.08 (0.06—0.14)	0.08 (0.06—0.09)	0.08 (0.06—0.09)	
				UH	—	—	—	
M	Austenitic Stainless Steel	≤200HB	130 (80—180)	US	—	—	—	
				UM	0.06 (0.04—0.08)	0.05 (0.04—0.06)	0.05 (0.04—0.06)	
	Austenitic Stainless Steel	>200HB	130 (80—180)	US	—	—	—	
				UM	0.06 (0.04—0.08)	0.05 (0.04—0.06)	0.05 (0.04—0.06)	
	Ferritic and Martensitic Stainless Steel	≤200HB	120 (80—165)	US	—	—	—	
				UM	0.06 (0.04—0.08)	0.05 (0.04—0.06)	0.05 (0.04—0.06)	
	Ferritic and Martensitic Stainless Steel	>200HB	120 (80—165)	US	—	—	—	
				UM	0.06 (0.04—0.08)	0.05 (0.04—0.06)	0.05 (0.04—0.06)	
K	Gray Cast Iron	Tensile Strength ≤350MPa	160 (130—195)	UM	0.10 (0.06—0.14)	0.08 (0.06—0.10)	0.08 (0.06—0.10)	
	Ductile Cast Iron	Tensile Strength ≤450MPa	100 (80—135)	UM	0.10 (0.06—0.14)	0.08 (0.06—0.10)	0.08 (0.06—0.10)	
	Ductile Cast Iron	Tensile Strength ≤800MPa	100 (70—125)	UM	0.08 (0.06—0.12)	0.07 (0.06—0.08)	0.07 (0.06—0.08)	
N	Aluminum Alloy	Si < 5%	200 (100—350)	UN	—	—	—	
	Aluminum Alloy	5% ≤ Si ≤ 10%	150 (100—200)	UN	—	—	—	
	Aluminum Alloy	Si > 10%	150 (100—200)	UN	—	—	—	
H	Hardened Steel	38—45HRC	50 (30—80)	UH	—	—	—	

(Note 1) Reduce the cutting speed by around 30% when using VP15TF for outer insert.

(Note 2) Recommend maximum drilling depth L/D < 3 for using outer coolant system.

(Note 3) Spindle through & high pressure coolant system is recommended to make stable holes for stainless steel.

vc = Cutting Speed (Min.—Max.)
fr = Feed Rate (Min.—Max.)

(mm)

	$\phi 17-\phi 19.5$				$\phi 20-\phi 23.5$				$\phi 24-\phi 29.5$			
	fr (mm/rev)				fr (mm/rev)				fr (mm/rev)			
	L/D=2, 3	4	5	6	L/D=2, 3	4	5	6	L/D=2, 3	4	5	6
	0.05 (0.04-0.06)	0.05 (0.04-0.06)	0.05 (0.04-0.06)	0.04 (0.04-0.05)	0.06 (0.04-0.08)	0.06 (0.04-0.07)	0.06 (0.04-0.07)	0.04 (0.04-0.05)	0.07 (0.04-0.08)	0.06 (0.04-0.07)	0.06 (0.04-0.07)	0.05 (0.04-0.06)
	0.08 (0.06-0.14)	0.08 (0.06-0.09)	0.08 (0.06-0.09)	0.05 (0.04-0.06)	0.10 (0.06-0.18)	0.09 (0.06-0.12)	0.09 (0.06-0.12)	0.07 (0.06-0.08)	0.12 (0.08-0.18)	0.10 (0.08-0.12)	0.10 (0.08-0.12)	0.09 (0.08-0.10)
	0.08 (0.06-0.14)	0.08 (0.06-0.09)	0.08 (0.06-0.09)	0.05 (0.04-0.06)	0.10 (0.06-0.18)	0.09 (0.06-0.12)	0.09 (0.06-0.12)	0.07 (0.06-0.08)	0.12 (0.08-0.18)	0.10 (0.08-0.12)	0.10 (0.08-0.12)	0.09 (0.08-0.10)
	0.08 (0.06-0.14)	0.08 (0.06-0.09)	0.08 (0.06-0.09)	0.05 (0.04-0.06)	0.10 (0.06-0.18)	0.09 (0.06-0.12)	0.09 (0.06-0.12)	0.07 (0.06-0.08)	0.12 (0.08-0.18)	0.10 (0.08-0.12)	0.10 (0.08-0.12)	0.09 (0.08-0.10)
	0.08 (0.06-0.12)	0.06 (0.04-0.08)	0.06 (0.04-0.08)	0.05 (0.04-0.06)	0.10 (0.06-0.14)	0.07 (0.06-0.08)	0.07 (0.06-0.08)	0.06 (0.06-0.07)	0.10 (0.06-0.14)	0.08 (0.06-0.10)	0.08 (0.06-0.10)	0.07 (0.06-0.08)
	0.06 (0.04-0.08)	0.05 (0.04-0.06)	0.05 (0.04-0.06)	0.04 (0.04-0.05)	0.08 (0.06-0.12)	0.07 (0.06-0.08)	0.07 (0.06-0.08)	0.06 (0.06-0.07)	0.09 (0.06-0.12)	0.07 (0.06-0.09)	0.07 (0.06-0.09)	0.06 (0.06-0.08)
	0.08 (0.06-0.12)	0.06 (0.04-0.08)	0.06 (0.04-0.08)	0.05 (0.04-0.06)	0.10 (0.06-0.14)	0.07 (0.06-0.08)	0.07 (0.06-0.08)	0.06 (0.06-0.07)	0.10 (0.06-0.14)	0.08 (0.06-0.10)	0.08 (0.06-0.10)	0.07 (0.06-0.08)
	0.06 (0.04-0.08)	0.05 (0.04-0.06)	0.05 (0.04-0.06)	0.04 (0.04-0.05)	0.08 (0.06-0.12)	0.07 (0.06-0.08)	0.07 (0.06-0.08)	0.06 (0.06-0.07)	0.09 (0.06-0.12)	0.07 (0.06-0.09)	0.07 (0.06-0.09)	0.06 (0.06-0.08)
	0.08 (0.06-0.12)	0.06 (0.04-0.08)	0.06 (0.04-0.08)	0.05 (0.04-0.06)	0.10 (0.06-0.14)	0.07 (0.06-0.08)	0.07 (0.06-0.08)	0.06 (0.06-0.07)	0.10 (0.06-0.14)	0.08 (0.06-0.10)	0.08 (0.06-0.10)	0.07 (0.06-0.08)
	0.06 (0.04-0.08)	0.05 (0.04-0.06)	0.05 (0.04-0.06)	0.04 (0.04-0.05)	0.08 (0.06-0.12)	0.07 (0.06-0.08)	0.07 (0.06-0.08)	0.06 (0.06-0.07)	0.09 (0.06-0.12)	0.07 (0.06-0.09)	0.07 (0.06-0.09)	0.06 (0.06-0.08)
	0.11 (0.08-0.14)	0.09 (0.08-0.10)	0.09 (0.08-0.10)	0.05 (0.04-0.06)	0.14 (0.10-0.18)	0.10 (0.10-0.12)	0.10 (0.10-0.12)	0.07 (0.06-0.08)	0.15 (0.10-0.20)	0.11 (0.10-0.13)	0.11 (0.10-0.13)	0.09 (0.08-0.10)
	0.11 (0.08-0.14)	0.09 (0.08-0.10)	0.09 (0.08-0.10)	0.05 (0.04-0.06)	0.13 (0.10-0.16)	0.10 (0.10-0.11)	0.10 (0.10-0.11)	0.07 (0.06-0.08)	0.14 (0.10-0.18)	0.11 (0.10-0.12)	0.11 (0.10-0.12)	0.09 (0.08-0.10)
	0.11 (0.08-0.14)	0.09 (0.08-0.10)	0.09 (0.08-0.10)	0.05 (0.04-0.06)	0.13 (0.10-0.16)	0.10 (0.10-0.11)	0.10 (0.10-0.11)	0.07 (0.06-0.08)	0.14 (0.10-0.18)	0.11 (0.10-0.12)	0.11 (0.10-0.12)	0.09 (0.08-0.10)
	0.12 (0.05-0.18)	0.12 (0.05-0.18)	0.12 (0.05-0.18)	0.08 (0.05-0.12)	0.12 (0.05-0.18)	0.12 (0.05-0.18)	0.12 (0.05-0.18)	0.08 (0.05-0.12)	0.12 (0.05-0.18)	0.12 (0.05-0.18)	0.12 (0.05-0.18)	0.08 (0.05-0.12)
	0.12 (0.05-0.18)	0.12 (0.05-0.18)	0.12 (0.05-0.18)	0.08 (0.05-0.12)	0.12 (0.05-0.18)	0.12 (0.05-0.18)	0.12 (0.05-0.18)	0.08 (0.05-0.12)	0.12 (0.05-0.18)	0.12 (0.05-0.18)	0.12 (0.05-0.18)	0.08 (0.05-0.12)
	0.12 (0.05-0.18)	0.12 (0.05-0.18)	0.12 (0.05-0.18)	0.08 (0.05-0.12)	0.12 (0.05-0.18)	0.12 (0.05-0.18)	0.12 (0.05-0.18)	0.08 (0.05-0.12)	0.12 (0.05-0.18)	0.12 (0.05-0.18)	0.12 (0.05-0.18)	0.08 (0.05-0.12)
	0.08 (0.04-0.12)	0.06 (0.04-0.09)	—	—	0.09 (0.06-0.14)	0.07 (0.06-0.09)	—	—	0.09 (0.06-0.14)	0.07 (0.06-0.09)	—	—

Indexable Drill

Recommended Cutting Conditions

(mm)

Work Material	Hardness	vc (m/min)	Inner Breaker	φ30-φ63					
				fr (mm/rev)					
				L/D=2, 3	4	5	6		
P	Mild Steel	≤180HB	200 (180-235)	UM	0.08 (0.06-0.10)	0.07 (0.06-0.08)	0.07 (0.06-0.08)	0.06 (0.06-0.07)	
				UH					
	Carbon Steel, Alloy Steel	180-280HB	140 (115-180)	UM	0.14 (0.08-0.20)	0.12 (0.08-0.16)	0.12 (0.08-0.16)	0.11 (0.10-0.12)	
				UH					
	Carbon Steel, Alloy Steel	280-350HB	100 (75-140)	UM	0.14 (0.08-0.20)	0.12 (0.08-0.16)	0.12 (0.08-0.16)	0.11 (0.10-0.12)	
				UH					
	Alloy Tool Steel	≤350HB	135 (100-170)	UM	0.14 (0.08-0.20)	0.12 (0.08-0.16)	0.12 (0.08-0.16)	0.10 (0.08-0.12)	
				UH					
M	Austenitic Stainless Steel	≤200HB	130 (80-180)	US	0.10 (0.06-0.14)	0.09 (0.06-0.12)	0.09 (0.06-0.12)	0.07 (0.06-0.10)	
				UM	0.09 (0.06-0.12)	0.08 (0.06-0.10)	0.08 (0.06-0.10)	0.07 (0.06-0.08)	
	Austenitic Stainless Steel	>200HB	130 (80-180)	US	0.10 (0.06-0.14)	0.09 (0.06-0.12)	0.09 (0.06-0.12)	0.07 (0.06-0.10)	
				UM	0.09 (0.06-0.12)	0.08 (0.06-0.10)	0.08 (0.06-0.10)	0.07 (0.06-0.08)	
	Ferritic and Martensitic Stainless Steel	≤200HB	120 (80-165)	US	0.10 (0.06-0.14)	0.09 (0.06-0.12)	0.09 (0.06-0.12)	0.07 (0.06-0.10)	
				UM	0.09 (0.06-0.12)	0.08 (0.06-0.10)	0.08 (0.06-0.10)	0.07 (0.06-0.08)	
	Ferritic and Martensitic Stainless Steel	>200HB	120 (80-165)	US	0.10 (0.06-0.14)	0.09 (0.06-0.12)	0.09 (0.06-0.12)	0.07 (0.06-0.10)	
				UM	0.09 (0.06-0.12)	0.08 (0.06-0.10)	0.08 (0.06-0.10)	0.07 (0.06-0.08)	
	K	Gray Cast Iron	Tensile Strength ≤350MPa	160 (130-195)	UM	0.15 (0.10-0.20)	0.12 (0.10-0.13)	0.12 (0.10-0.13)	0.11 (0.10-0.12)
		Ductile Cast Iron	Tensile Strength ≤450MPa	100 (80-135)	UM	0.15 (0.10-0.20)	0.12 (0.10-0.13)	0.12 (0.10-0.13)	0.11 (0.10-0.12)
Ductile Cast Iron		Tensile Strength ≤800MPa	100 (70-125)	UM	0.15 (0.10-0.20)	0.12 (0.10-0.13)	0.12 (0.10-0.13)	0.11 (0.10-0.12)	
N	Aluminum Alloy	Si < 5%	200 (100-350)	UN	0.12 (0.05-0.20)	0.12 (0.05-0.18)	0.12 (0.05-0.18)	0.08 (0.05-0.12)	
	Aluminum Alloy	5% ≤ Si ≤ 10%	150 (100-200)	UN	0.12 (0.05-0.20)	0.12 (0.05-0.18)	0.12 (0.05-0.18)	0.08 (0.05-0.12)	
	Aluminum Alloy	Si > 10%	150 (100-200)	UN	0.12 (0.05-0.20)	0.12 (0.05-0.18)	0.12 (0.05-0.18)	0.08 (0.05-0.12)	
H	Hardened Steel	38-45HRC	50 (30-80)	UH	0.11 (0.06-0.16)	0.09 (0.06-0.12)	-	-	

(Note 1) Reduce the cutting speed by around 30% when using VP15TF for outer insert.

(Note 2) Recommend maximum drilling depth L/D < 3 for using outer coolant system.

(Note 3) Spindle through & high pressure coolant system is recommended to make stable holes for stainless steel.

JUST FIT SLEEVE [JFS]

● A sleeve for the shank of the drill to allow the cutting diameter to be increased.

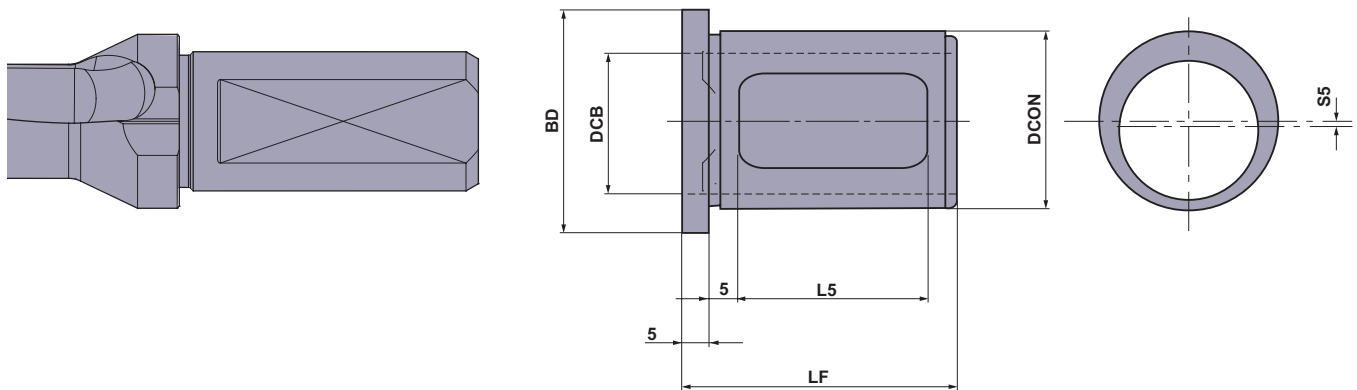

(mm)

Order Number	Stock	Set Order Number	DCB	DCON	BD	LF	L5	*Increase (S5×2)	MVX Order Number The Last Three Letters
JFS2520-10	●	JFS-1	20	25	33	43	30	0.1	F20
JFS2520-20	●	JFS-1	20	25	33	43	30	0.2	F20
JFS2520-30	●	JFS-1	20	25	33	43	30	0.3	F20
JFS2520-40	●	JFS-1	20	25	33	43	30	0.4	F20
JFS2520-50	●	JFS-1	20	25	33	43	30	0.5	F20
JFS3225-10	●	JFS-2	25	32	40	50	34	0.1	F25
JFS3225-20	●	JFS-2	25	32	40	50	34	0.2	F25
JFS3225-30	●	JFS-2	25	32	40	50	34	0.3	F25
JFS3225-40	●	JFS-2	25	32	40	50	34	0.4	F25
JFS3225-50	●	JFS-2	25	32	40	50	34	0.5	F25
JFS4032-10	●	JFS-3	32	40	48	55	40	0.1	F32
JFS4032-20	●	JFS-3	32	40	48	55	40	0.2	F32
JFS4032-30	●	JFS-3	32	40	48	55	40	0.3	F32
JFS4032-40	●	JFS-3	32	40	48	55	40	0.4	F32
JFS4032-50	●	JFS-3	32	40	48	55	40	0.5	F32
JFS5040-10	●	—	40	50	68	65	50	0.1	F40
JFS5040-20	●	—	40	50	68	65	50	0.2	F40
JFS5040-30	●	—	40	50	68	65	50	0.3	F40
JFS5040-40	●	—	40	50	68	65	50	0.4	F40
JFS5040-50	●	—	40	50	68	65	50	0.5	F40

It does not correspond to the shank diameter ø50mm.

*Increase : Size of the increase in the cutting diameter.

■ Guideline for Selecting a JUST FIT SLEEVE

Desired = (Drillø+ Increase of JFS) + 0.1mm

(Eg.) Desired diameter is ø20.3mm (oversize is taken as 0.1mm).

$$\text{ø}20.3 = (\text{MVX2000 X } \text{F25} + \text{JFS3225-20}) + 0.1$$

ø20mm Drill

Using JFS an Increase of 0.2mm.

Oversize

<Tool Selected>

MVX : MVX2000 X F25
JUST FIT SLEEVE [JFS]
: JFS3225-20

(Note 1) Oversize can vary due to the cutting conditions used, please use the above as a guideline.

■ Ordering the JUST FIT SLEEVE

● Purchasing Method 1

Oversize can vary due to the cutting conditions used. Therefore it is recommended to purchase as a set. (5 sleeves/set) When placing an order, please use the set order number.

● : Inventory maintained in Japan.

● Purchasing Method 2

It is possible to order individually. When placing an order, please use the order number.

Indexable Drill

Application of JUST FIT SLEEVE

- 1 When inserting the drill into the side lock holder, align the V groove on the outer peripheral edge of the drill flange, as well as the round holes of the outer peripheral edge of the sleeve flange and the screws of the side lock holder for fixing the drill. (If the drill does not have a V groove, align the notch of the drill shank with the round holes of the sleeve.)
- 2 Insert screws A of the side lock holder directly to the open window of the sleeve and fix the drill. Tighten screw B to a degree so as not to damage the sleeve.

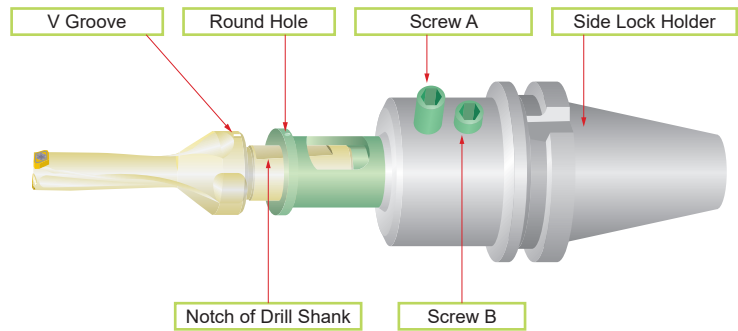

Application of MVX Type Drill

● Use on a Lathe

- (1) The outer insert and machine X axis must be set parallel. The drill is designed that the center of the inner insert is 0-0.15mm lower when matching the drill center and the machine spindle center.
 - *The inner insert may fracture if the center height of inner insert is higher than the machine X axis.
- (2) To adjust the hole diameter by off-setting the drill, please adjust to X axis plus direction (expanding direction of the hole diameter). Please refer to the holder dimension S10 for the maximum adjustment rate of each holder.
 - *It is not recommended to adjust to X axis minus direction (reducing direction of the hole diameter) as the holder may interfere with the hole.

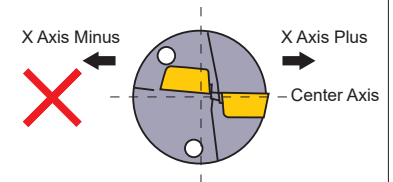
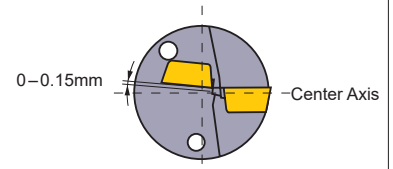

- (3) When through hole drilling on a lathe the disc produced by the drill exiting the work material may be expelled at high velocity. To reduce the danger of injury or damage a cover guard is highly recommended.

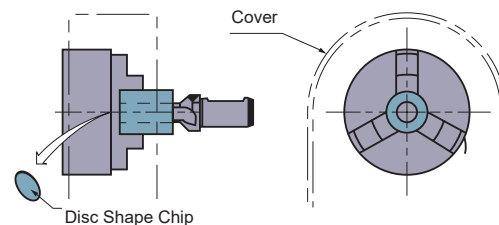

Cutting Performance

Stainless Steel (AISI 304)

MVX has double tool life compared with conventional products when using US breaker for the inner edge.

Comparison of Cutting Length

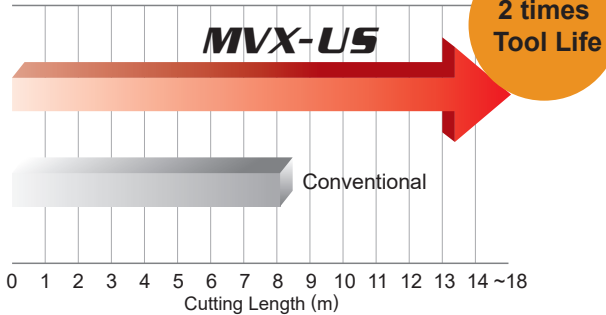

Comparison of Cutting Edge

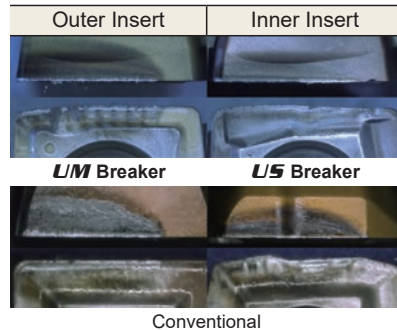

<Cutting Conditions>

Drill : MVX3000X3F32
 Insert : Outer MC1020-UM
 Inner VP15TF-US
 Work Material : AISI 304
 Cutting Speed : 120m/min
 Feed Rate : 0.12mm/rev
 Hole Depth : 50mm (Through Hole)
 Cutting Mode : Water-soluble Cutting Fluid

Carbon Steel (AISI 1049)

MVX drill achieved 3 times longer tool life compared with conventional products when drilling carbon steel.

Comparison of Cutting Length

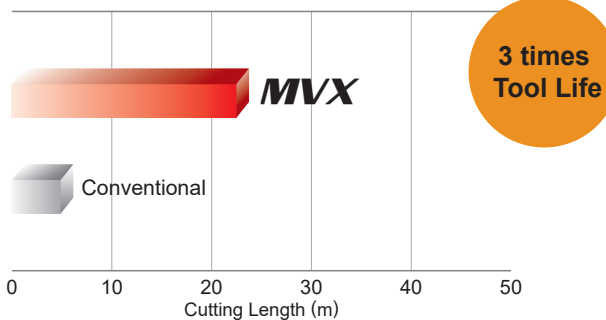

Comparison of Cutting Edge

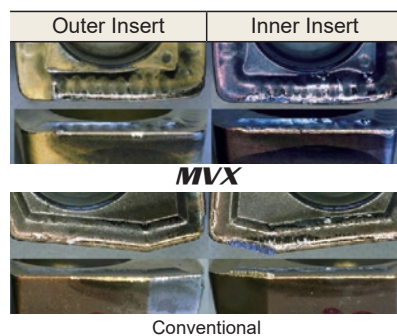

<Cutting Conditions>

Drill : MVX1900X3F25
 Insert : Outer MC1020-UM
 Inner VP15TF-UM
 Work Material : AISI 1049
 Cutting Speed : 220m/min
 Feed Rate : 0.1mm/rev
 Hole Depth : 50mm (Through Hole)
 Cutting Mode : Water-soluble Cutting Fluid

Cast Iron (AISI No.35B)

MVX has 4 times longer tool life compared to conventional products, especially when using MC5020 grade outer inserts.

Comparison of Cutting Length

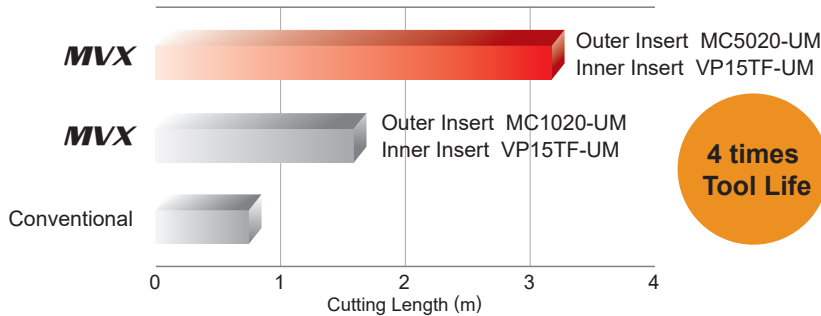

<Cutting Conditions>

Drill : MVX1900X3F25
 Insert : Outer MC5020-UM
 MC1020-UM
 Inner VP15TF-UM
 Work Material : AISI No.35B
 Cutting Speed : 160m/min
 Feed Rate : 0.15mm/rev
 Hole Depth : 50mm (Through Hole)
 Cutting Mode : Water-soluble Cutting Fluid

Indexable Drill

Ductile Cast Iron

MC5020 grade achieves long tool life when machining cast and ductile cast irons. Friction wear is much less than when using MC1020.

Comparison of Cutting Length

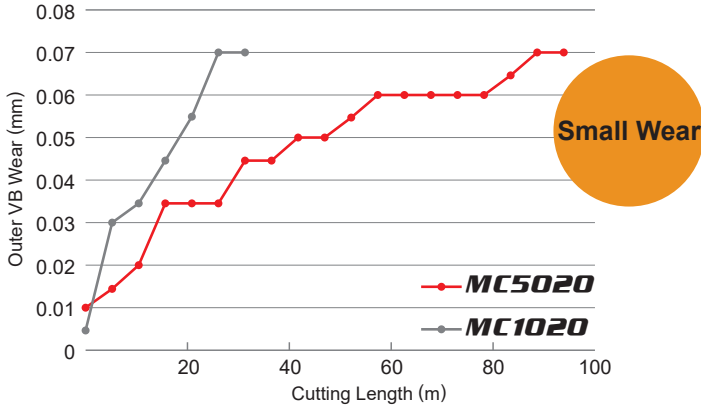

Comparison of Cutting Edge

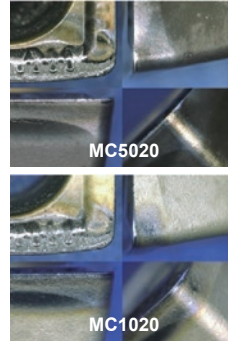

<Cutting Conditions>
 Drill : MVX1900X3F25
 Insert : Outer MC5020-UM
 MC1020-UM
 Inner VP15TF-UM
 Work Material : Ductile Cast Iron
 Cutting Speed : 135 m/min
 Feed Rate : 0.12 mm/rev
 Hole Depth : 50 mm (Through Hole)
 Cutting Mode : Water-soluble Cutting Fluid

*Pictures of cutting edge wear at VB=0.07 mm

Hardened Steel (AISI H13)

MVX has double tool life compared with conventional products.

Comparison of Number of Holes

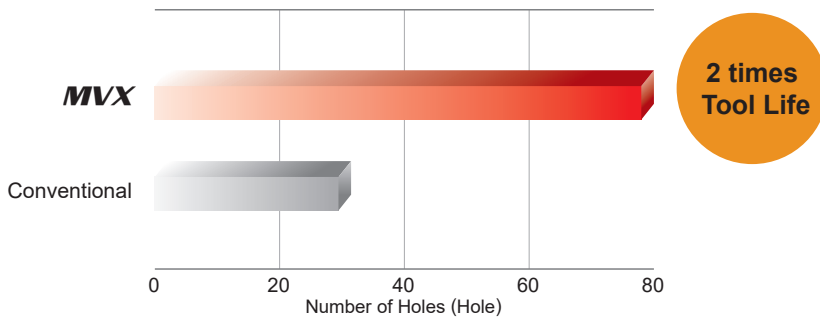

<Cutting Conditions>
 Drill : MVX1700X3F20
 Insert : Outer MC1020-UM
 Inner DP8020-UH
 Work Material : AISI H13 (45HRC)
 Cutting Speed : 50 m/min
 Feed Rate : 0.08 mm/rev
 Hole Depth : 30 mm (Through Hole)
 Cutting Mode : Water-soluble Cutting Fluid

Aluminum Alloy

MVX corresponds to changes in cutting speed and feed rate.

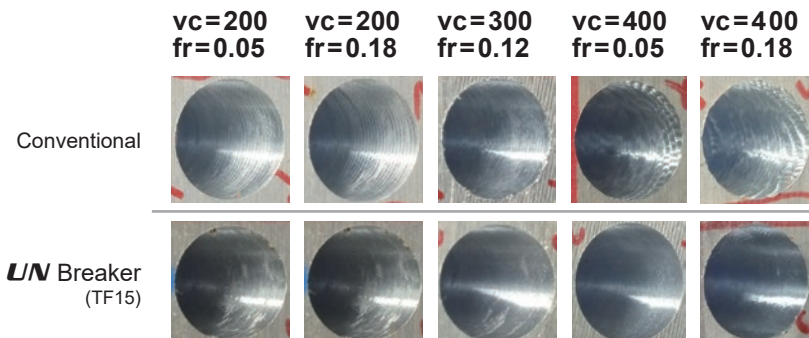

<Cutting Conditions>
 Drill : MVX1700X5F20
 Insert : Outer TF15-UN
 Inner TF15-UN
 Work Material : Aluminum Alloy
 Cutting Speed : 200-400 m/min
 Feed Rate : 0.05-0.18 mm/rev
 Hole Depth : 40 mm (Blind Hole)
 Cutting Mode : Water-soluble Cutting Fluid

Application Example

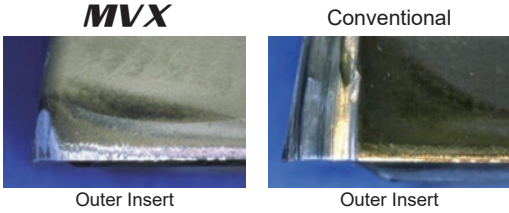
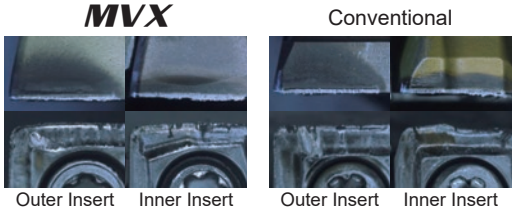
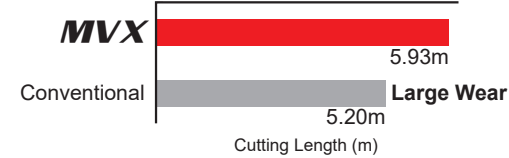
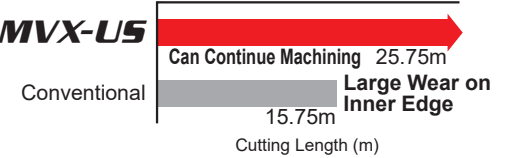
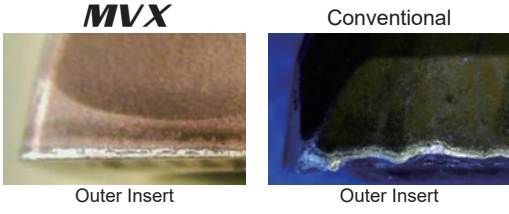
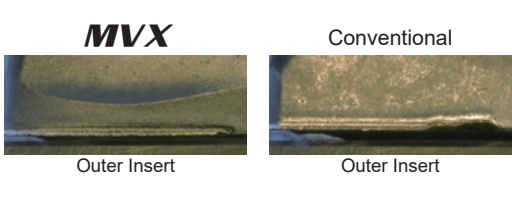
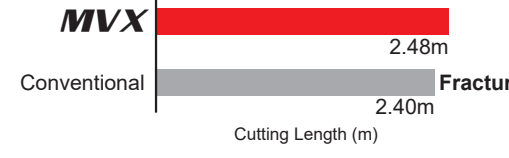
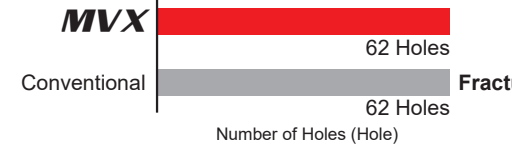
Drill		MVX3000X5F32	MVX1900X3F25	
Insert		UM (Outer:MC1020, Inner:VP15TF)	Outer:MC1020-UM, Inner:VP15TF-US	
Workpiece		Carbon Steel (AISI 1049)	Ferritic Stainless Steels (AISI 304)	
Cutting Conditions	Cutting Speed (m/min)	250	120	
	Feed Rate (mm/rev)	0.1	0.10	
	Hole Depth (mm)	104 (Through Hole)	30 (Through Hole)	
	Cutting Mode	Water-soluble Cutting Fluid	—	
Results	 <p>MVX Conventional</p> <p>Outer Insert Outer Insert</p>		 <p>MVX Conventional</p> <p>Outer Insert Inner Insert Outer Insert Inner Insert</p>	
	 <p>MVX 5.93m</p> <p>Conventional 5.20m Large Wear</p> <p>Cutting Length (m)</p> <p>MVX drill had less insert wear and made a better hole surface finish than conventional products.</p>		 <p>MVX-US 25.75m Can Continue Machining</p> <p>Conventional 15.75m Large Wear on Inner Edge</p> <p>Cutting Length (m)</p> <p>MVX drill achieved 1.6 times longer tool life of the peripheral edge compared with conventional products.</p>	
Drill		MVX1800X3F25	MVX2650X3F32	
Insert		UM (Outer:MC1020, Inner:VP15TF)	UM (Outer:MC5020, Inner:VP15TF)	
Workpiece		Pump Austenitic Stainless Steel (AISI 316)	Tappet Hole Cast Iron (AISI No.35B)	
Cutting Conditions	Cutting Speed (m/min)	113	150	
	Feed Rate (mm/rev)	0.065	0.1	
	Hole Depth (mm)	20 (Through Hole)	(Through Hole)	
	Cutting Mode	Water-soluble Cutting Fluid P=4MPa	—	
Results	 <p>MVX Conventional</p> <p>Outer Insert Outer Insert</p>		 <p>MVX Conventional</p> <p>Outer Insert Outer Insert</p>	
	 <p>MVX 2.48m</p> <p>Conventional 2.40m Fracture</p> <p>Cutting Length (m)</p> <p>MVX drill was able to continue drilling. Conventional insert fractured.</p>		 <p>MVX 62 Holes</p> <p>Conventional 62 Holes Fracture</p> <p>Number of Holes (Hole)</p> <p>Improved surface finish and less drilling noise than a conventional drill.</p>	

Memo

A series of horizontal dashed lines for writing, spanning the width of the page.

Memo

A series of horizontal dashed lines for writing.



For Your Safety

●Don't handle inserts and chips without gloves. ●Please machine within the recommended application range and exchange expired tools with new ones in advance of breakage. ●Please use safety covers and wear safety glasses. ●When using compounded cutting oils, please take fire precautions. ●When attaching inserts or spare parts, please use only the correct wrench or driver. ●When using rotating tools, please make a trial run to check run-out, vibration and abnormal sounds etc.

 **MITSUBISHI MATERIALS CORPORATION**

MITSUBISHI MATERIALS CORPORATION

Overseas Sales Dept, Asian Region

KFC bldg., 8F, 1-6-1 Yokoami, Sumida-ku, Tokyo 130-0015, Japan
TEL +81-3-5819-8771 FAX +81-3-5819-8774

Overseas Sales Dept, European & American Region

KFC bldg., 8F, 1-6-1 Yokoami, Sumida-ku, Tokyo 130-0015, Japan
TEL +81-3-5819-8772 FAX +81-3-5819-8774

<http://www.mitsubishicarbide.com/en/>
(Tools specifications subject to change without notice.)