

CUTTING TOOLS PRODUCTS CATALOGUE

切削工具 商品カタログ

2023~2024



技術はものと人のために尽くす
技術はときの積み重ねを大切にする
技術は驚きや笑顔を生み出す

開発技術の MOLDINO

私たちの理想は技術そのものの姿にありました

お客様としっかり足並みを揃え
一つひとつの課題にどこまでも応え続けること
世界を驚かせる鋭い発想で独創的な製品を生み出すこと
常にお客様の夢の一步先を走り続け
加工全体を見据えた加工イノベーションを実現すること

技術のような真摯な姿勢で
目の前のお客様のためにできること全てを

MOLDINO は

お客様と共に成長しお客様自身のプライドを貴める
独創工具メーカーとして未知の領域に挑戦し続けます

Carbide End Mills
超硬エンドミル

A

Special shape tool
異形工具

B

Indexable Tools
Milling Inserts
刃先交換式工具
フライス切削用インサート

C

Modular Mill,
AV Arbor (Damped Arbor), Parts
モジュラーミル専用シャンク
AVアーバ(防振アーバ)
刃先交換式工具用 部品

D

Boring Tools
穴あけ工具

E

Threading / Chamfering Tools
ねじ切り・面取り工具

F

Turning Inserts
旋削用インサート

G

HSS End Mills
ハイスエンドミル

H

Technical Data
技術資料

I

Item Code Index
商品コード索引

J

Technology thoroughly applies in the service of
people and goods
Technology that values the accumulation of results
Technology that brings marvels and smiles

MOLDINO Tool Engineering, innovative product
development
Our principles are to...
be embodied in our technology

Stand together with our customers
Respond to each and every challenge for as long as necessary
Use great ideas to the creation of unique, world-beating products
Be a step ahead in fulfilling customers' dreams and visions
Take a holistic view toward manufacturing innovation

As earnest in our approach as our technology itself
Committed to doing all we can do for
our customers here and now

At MOLDINO Tool Engineering...
We grow with our customers and share in their pride
Taking on the challenge of exploring
The Edge To Innovation

○ 本文の構成 Item page structure

商品名

Product Name

商品バリエーション

Product variations

該当商品にレギュラー・ショート等の多種のバリエーションがある場合、その種類を表記しています。
If there are variations available for the product, such as regular type, short type, etc., the variations available will be listed.

アイコン表示

Icons

商品の諸元・使用用途などをアイコン表記しています。
詳しい内容は次頁の「アイコンの説明」をご覧ください。
Show product statistics, applications, etc. For details of the icon meanings, refer to "Meaning of icons".

商品コード

Item Code

商品コードの○には数字が、□には英字が入ります。
Numeric figure in a circle ○ and Alphabetical character comes in a square □.

価格について

About price

掲載価格は2022年10月現在、消費税抜きの単価を表示しております。
Prices listed are as of October 2022, and unit prices excluding consumption tax.

対応被削材

Applicable work material

対応被削材種を表示しています。
Applicable work material

再研磨対応外径範囲

Re-grinding compatibility range

再研磨対応可能な外径範囲を表示しています。
Re-grinding compatibility range

特長・用途

Features and Applications

End mill for adaptive milling 高能率側面切削用エンドミル

首下 3.5DCタイプ Under neck 3.5DC type

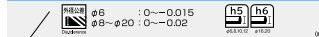

ER5HS-○-PN

商品コード Item code	在庫 Stock	寸法 Size(mm)								希望小売価格 Suggested retail price(¥)
		外径 Dia.	コーナ半径 Corner radius	刃長 Flute length	首下長 Under-neck length	首径 Neck dia.	全長 Overall length	シャンク径 Shank dia.	DCONMS	
ER5HS06-PN	●	6	0.5	18	21	5.5	60	6	13,140	
ER5HS08-PN	●	8	1.0	24	28	7.3	75	8	15,380	
ER5HS10-PN	●	10	1.0	30	35	9.2	80	10	19,870	
ER5HS12-PN	●	12	1.0	36	42	11	100	12	23,910	
ER5HS16-PN	●	16	1.0	48	56	14.7	110	16	51,600	
ER5HS20-PN	●	20	1.0	60	70	18.4	125	20	71,900	

首下 5DCタイプ Under neck 5DC type

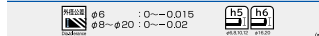

ER5HS-○-○-PN

商品コード Item code	在庫 Stock	寸法 Size(mm)								希望小売価格 Suggested retail price(¥)
		外径 Dia.	コーナ半径 Corner radius	刃長 Flute length	首下長 Under-neck length	首径 Neck dia.	全長 Overall length	シャンク径 Shank dia.	DCONMS	
ER5HS06-30-PN	●	6	0.5	18	30	5.5	70	6	14,480	
ER5HS08-40-PN	●	8	1.0	24	40	7.3	80	8	16,960	
ER5HS10-50-PN	●	10	1.0	30	50	9.2	100	10	21,880	
ER5HS12-60-PN	●	12	1.0	36	60	11	120	12	26,260	
ER5HS16-80-PN	●	16	1.0	48	80	14.7	135	16	58,100	
ER5HS20-100-PN	●	20	1.0	60	100	18.4	155	20	84,000	

○ 対応被削材 Applicable work material

炭素鋼 Carbon steel	合金鋼 Alloy steel	硬質鋼 Hardened steel	ステンレス鋼 Stainless steel	チタン合金 Titanium alloy	銅合金 Copper alloy	アルミ合金 Aluminum alloy
○	○	○	○	○	○	○

○ 再研磨対応外径範囲 Re-grinding compatibility range

商品コード Item code	外径 Outer dia. (mm)	エンド End (mm)
ER5HS-PN	6 ~ 20	6 ~ 20

●：標準在庫品です。 ●： Stocked items.

●印：標準在庫品です。

◎印：メーカー在庫品です。弊社営業へお問い合わせください。

□印：特定代理店在庫です。弊社営業へお問合せください。

△印：在庫が無くなり次第受注生産品となるものです。

無印：受注生産品です。

—印：製作致しません。

●： Stocked Items.

◎： Manufacturer stocked items. Contact with our sales department.

□： Stocked by specified distributor. Contact with our sales department.

△： When the Stock is out, will become to produce on request.

No Mark： Manufactured upon request only.

—： Not Manufactured.

本カタログに掲載の商品は予告なく、改善・改良のために仕様変更することがあります。
Specifications for the products listed in this catalog are subject to change without notice due to replacement or modification.

商品カタログの使用方法

How to use this catalogue

アイコンの説明 Meaning of icons

加工用途 Applications



高能率側面切削
High efficient side milling
負荷制御ツールパスによる高能率側面切削に対応します
Compatible with high-efficiency side cutting using load control tool paths



平面切削 Planing
平面切削に使用できます。
Can be used for planing.



側面切削 Side Cutting
側面切削に使用できます。
Can be used for side cutting.



溝切削 Slotting
溝切削に使用できます。
Can be used for slotting.



彫込み加工 Die-sinking
彫込み加工に使用できます。
Can be used for die-sinking.



曲面加工 Profiling
曲面加工に使用できます。
Can be used for profiling.



R加工 Radius
R加工に使用できます。
Can be used for radius cutting.



面取り加工 Chamfering
面取り加工に使用できます。
Can be used for chamfering.



ヘリカル加工 Helical
ヘリカル加工に使用できます。
Can be used for helical cutting.



座ぐり加工 Spot facing
座ぐり加工に使用できます。
Can be used for spot facing.



バーチカル加工 Vertical
バーチカル加工に使用できます。
Can be used for vertical cutting.



テーパ加工 Taper
テーパ切削に使用できます。
Can be used for taper cutting.



テーパボール加工 Radius Taper
テーパボール加工に使用できます。
Can be used for radius taper cutting.



取りのこし加工 Rest Material Machining
取りのこし加工に使用できます。
Can be used for side-open cavity cutting.



玉ブチ加工 Corner Recessing
玉ブチ加工に使用できます。
Can be used for corner recessing.



細部加工 Miniature
細部加工に使用できます。
Can be used for miniature cutting.



穴あけ加工 Boring
穴あけ加工に使用できます。
Can be used for boring.

仕上げ分類 Types of finishing



荒加工 Roughing
荒加工に使用できます。
Can be used for roughing.



中仕上げ加工 Semi-Finishing
中仕上げ加工に使用できます。
Can be used for semi-finishing.



仕上げ加工 Finishing
仕上げ加工に使用できます。
Can be used for finishing.



リブ・細部加工 Rib, Miniature
リブ溝加工、細部の加工に使用できます。
Can be used for rib cutting and miniature cutting.

コーティング Coating



Micro-THコーティング Micro-THCoating
超平滑THコーティングを施してあります。
Super smooth THCoating has been applied.



HDコーティング HDCoating
新ダイヤモンドコーティングを施してあります。
New Diamond Coating has been applied.



TH3コーティング TH3Coating
TH3コーティングを施してあります。
TH3Coating has been applied.



PNコーティング PNCoating
PNコーティングを施してあります。
PNCoating has been applied.



ATコーティング ATCoating
ATコーティングを施してあります。
ATCoating has been applied.



ATHコーティング ATHCoating
ATHコーティングを施してあります。
ATHCoating has been applied.



CSコーティング CSCoating
ナノ結晶系CSコーティングを施してあります。
Nano-composite CSCoating has been applied.



Cコーティング CCoating
C(センチュリー)コーティングを施してあります。
C (century) Coating has been applied.



THコーティング THCoating
ナノ結晶系THコーティングを施してあります。
Nano-composite THCoating has been applied.



SDコーティング SDCoating
S-DLCコーティングを施してあります。
S-DLC Coating has been applied.



Gコーティング GCoating
Gコーティングを施してあります。
GCoating has been applied.

工具材質 Tool Materials



超硬 Carbide
工具材質に超硬合金を使用しています。
Carbide is used in the tool material.



コバルトハイス HSS-Co
工具材質にコバルトハイスを使用しています。
Cobalt HSS is used in the tool material.



多結晶焼結ダイヤモンド
工具材質に多結晶焼結ダイヤモンドを使用しています。
Poly Crystalline Diamond is used in the tool material.



粉末ハイス Powdered HSS
工具材質に粉末ハイスを使用しています。
Powdered HSS is used in the tool material.



ハイス HSS
工具材質にハイスを使用しています。
HSS is used in the tool material.



Max1
工具材質にMax1(サーメット)を使用しています。
Max1 (cermet) is used in the tool material.



CBN
工具材質にCBNを使用しています。
CBN is used in the tool material.



セラミック Ceramic
工具材質にセラミックを使用しています。
Ceramic is used in the tool material.

シャンク仕様 Shank Specification



MTシャンク MT Shank

MTシャンク仕様です。
Follows MT shank specifications.



エンドミルシャンク End Mill Shank

エンドミルシャンク仕様です。
Follows end mill shank specifications.



ストレートシャンク Straight Shank

ストレートシャンク仕様です。
Follows straight shank specifications.



整数径シャンク Integral No. Shank

整数径シャンク仕様です。
Follows integral number shank specifications.

刃先交換式工具諸元 Statistics for indexable tools



外径公差 Tolerance on dia.

ポデー単体の外径の許容差を示します。
Shows the mill diameter tolerance for the body unit.



最大切込み量 Maximum Notch

最大切込み量を示します。
Shows maximum notch amount.



インサート精度 Tolerance class

インサートの精度を示します。
Shows tolerance class of insert



切込み角度 Notch angle

切込み角度を示します。
Shows notch angle.

エンドミル諸元 Statistics for End Mills



ねじれ角度 Helix Angle

刃部のねじれ角度を示します。
Shows the helix angle of the flute section.



ボール半径公差 Tolerance on RE

ボール半径の許容差を示します。
Shows R tolerance of flute tip.



シャンク径公差 Tolerance on shank

シャンク径の許容差を示します。
Shows shank diameter tolerance.



外径公差 Tolerance on dia.

外径の許容差を示します。
Shows mill diameter tolerance.



コーナ半径公差 Tolerance on RE

コーナ半径の許容差を示します。
Shows corner radius tolerance of flute tip.



不等分割形状 Unequal pitch geometry

不等分割形状を採用しています。
Adopt Unequal pitch geometry.

ドリル・ノンステップボーラー諸元 Statistics for Drill, Non Step Borer



ねじれ角度 Helix angle

溝のねじれ角度を示します。
Shows the helix angle of the flute.



先端角度 Tip angle

ドリルの先端角を示します。
Shows the drill tip angle.



直径公差 Tolerance on dia.

直径の許容差を示します。
Shows the drill diameter tolerance.



シャンク径公差 Tolerance on shank

シャンク径の許容差を示します。
Shows shank diameter tolerance.



加工穴深さ Drilling depth

ドリルの最大加工穴深さを示します。
Shows the maximum machining depth for the drill.

その他 Others



切削条件表 Cutting condition table

切削条件表の掲載ページを示します。
Shows the corresponding page of the cutting condition tables.



加工動画 Cutting movie

弊社YouTubeチャンネルにて加工動画を公開中です。
Our YouTube channel shows cutting movies.

○ 軸に対する寸法許容差 Tolerance for shafts

(mm)

基準寸法 Standard dia.								
を超え Over	以下 Up to							
—	3	0 -0.003	0 -0.004	0 -0.006	0 -0.010		0 -0.014	
3	6	0 -0.004	0 -0.005	0 -0.008	0 -0.012		0 -0.018	
6	10	0 -0.004	0 -0.006	0 -0.009	0 -0.015		0 -0.022	
10	18	0 -0.005	0 -0.008	0 -0.011	0 -0.018		0 -0.027	
18	30	0 -0.006	0 -0.009	0 -0.013	0 -0.021		0 -0.033	

切削工具 WEBサービスのご案内

WEB service for Products



ウェブサイト トップページ
Websight top page

1 切削工具 商品カタログ デジタルブック PDF版

デジタルカタログの閲覧や、PDF版のダウンロードができます。
You can browse the digital catalog and download the PDF version.

2 MOLDINOモバイルアプリ

商品情報検索や切削動力計算などが行えるアプリのダウンロードができます。
You can download an application that allows you to search for product information and calculate cutting power.

3 工具選定データベース TOOL SEARCH[®]

目的の加工にあった工具を検索、DXF/STPデータをダウンロードできます。
You can search for tools suitable for the desired machining and download DXF/STP data.

4 CAD/CAM サポートデータパック

超硬エンドミルに特化した検索データベースで、干渉角度計算ができます。
This search database specialized for carbide end mills enables calculation of interference angles.

5 NCプログラム作成ツール

ノンステップ穴加工、ねじ切り加工、SR加工用のNCプログラムを作成するツールです。
Tool of creating NC programs for non step drilling, threading and SR machining.

6 切削動力計算

ブラウザ上で各種工具の切削動力計算ができます。
You can calculate the cutting power of various tools on the browser.

**寸法表・切削条件のエクセルデータ・PDFデータのダウンロードが可能、
工具形状のDXFデータのダウンロードも可能です。**

※DXFデータは全ての工具を網羅していません。未掲載のものは順次作成・公開予定です。

Tool shape DXF data can be downloaded. *DXF data is not available for all tools. Tool data not yet available will be created and made available in succession.



MOLDINO モバイルアプリ

for iOS and Android

MOLDINO Mobile Application for iOS and Android



**工具の商品名や種類からはもちろん、
加工用途や被削材などから工具を検索!**

Tools can be searched for by machining application, cutting material, etc. as well as product name or type!

スマートフォン・タブレットの画面に合わせた専用表示画面

Special display screen matched to the screens of smartphones or tablets

工具検索メニューも豊富
用途に合わせた検索方法が選択できます

Rich tool search menu. Search method can be selected according to the application.

インストールは無料です。
インストールは App Store または Google Play
から「MOLDINO」で検索してください。



※ご利用にはインターネット接続環境が必要です。
Internet connection environment is necessary for use.

iOS

Android



MOLDINO OFFICIAL YOUTUBE CHANNEL

MOLDINOオフィシャルYouTubeチャンネル

www.youtube.com/c/MOLDINOToolEngineering

最新切削工具の加工映像を随時配信中！本カタログの一部のページからもリンクのQRコードを添付していますので、ご利用ください。

Movies of machining using the latest cutting tools are available for viewing any time. QR code links to movies are provided on some pages of this catalog for your convenience.



切削工具 選定データベース

TOOL SEARCH®

工具寸法から
From tool dimensions

被削材質から
From work material

加工形状から
From machining shape

目的にあった工具を絞り込み検索できます。新商品も随時更新中！DXFデータやSTPデータのダウンロードもできます。

You can narrow down the search to find the tools that suit your purpose. New products are being updated at any time! You can also download DXF data and STP data.

“TOOL SEARCH” へのアクセスは
To access the “TOOL SEARCH” click below.

TOOLSEARCH

検索



<https://data.moldino.com/toolsearch/>

CAD/CAMサポートデータパック

CAD/CAM Support Data Pack

超硬エンドミル検索に特化！深彫り時の干渉角度の計算ができる！！

ダウンロード後はオフラインで利用可能。インストールも不要です。超硬エンドミルの検索に加えて、ワーク勾配角に合わせた首下長の工具を検索できるので、特に微小な深彫り加工を強力にサポートします。

It can be used offline after downloading. No installation required. In addition to searching for carbide end mills, you can search for tools with a length under the neck that matches the draft angle of the workpiece, which strongly supports especially minute and deep milling.

必要システム構成：Windows 7,8,10 日本語版・英語版・中国語版
System requirements: Japanese, English, or Chinese version of Windows 7, 8, or Windows 10.



超硬NSB、超硬ねじ切りカッタ、SR加工用超硬ドリル NCプログラム作成ソフト

NC programs support software for Carbide NSB, Carbide Thread Mill and Carbide drill for SR machining

超硬NSBノンステップ加工、超硬ねじ切りカッタ、SR加工用超硬ドリルのNCプログラムを作成することができるサービスです。









Service that can create NC programs for Carbide NSB non step drilling, Carbide Thread Mill and Carbide Drill for SR Machining

















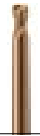

MOLDINO—押し工具 工具形状別(ソリッドエンドミル)

MOLDINO's Recommended Tools by tool shape (Solid end mill)

高硬度鋼 / 一般鋼 for Hardened steels / General steels

工具形状 Tool shape		高硬度鋼 Hardened steels			
		レギュラー Regular	ディープ Deep	ペンシルネック Pencil neck	
ボール Ball	2枚刃 2 flutes	EPBTS A100 より高硬度 Super hard milling 	CBN-EHB A147 cBNエンドミル cBN end mill 	EPDBPE-ATH A84 深い加工 Deep milling 	
		EPBT A102 高硬度用 Hard milling 	EPDBEH-TH3 A56 更に高硬度 Ultra hard milling 	—	
		—	EPDBE-ATH A72 高硬度用 Hard milling 	—	
	3枚刃 3 flutes	EMBE A110 高硬度用 Hard milling 	—	EMBPE A111 深い加工 Deep milling 	
	4・6枚刃 4,6 flutes	EHHBE A124 高硬度用 Hard milling 	—	—	
ラジラス Radius	2枚刃 2 flutes	—	CBN-EPSR A281 cBNエンドミル cBN end mill 	EPDRP-TH A210 深い加工 Deep milling 	
		—	EPDREH2-TH3 A172 更に高硬度 Ultra hard milling 	—	
	4枚刃 4 flutes	EPP-TH A247 高い安定性 High stability 	EPDREH4-TH3 A174 更に高硬度 Ultra hard milling 	—	
		ETM-TH A226 高能率加工 High efficiency milling 	ETR-TH A222 高能率加工 High efficiency milling 	ETRP-TH A223 高能率深彫り High efficiency deep milling 	
	6・8枚刃 6, 8 flutes	ER8WB A254 立壁底面仕上 Vertical Wall/Bottom Face Finishing 	CEPR-TH A265 高能率 High efficiency 	—	—

		一般鋼 General steels			
	リブ Rib	レギュラー Regular	ディープ Deep	ペンシルネック Pencil neck	リブ Rib
	—	HGOB-PN A104 高強度 High strength 	EPDBE-PN A75 加工面良好 Good surface 	EPDBPE-ATH A84 深い加工 Deep milling 	—
	—	—	—	—	—
	—	—	—	—	—
	—	EMBE A110 高硬度用 Hard milling 	—	EMBPE A111 深い加工 Deep milling 	—
EB4HR/ECRB リブ加工用 Rib slotting EB4HR A132 ECRB A137 		EPHB-PN A130 5軸加工 for 5-axis machining 	—	—	EB4HR/ECRB リブ加工用 Rib slotting EB4HR A132 ECRB A137 
	—	—	—	EPDRP-TH A210 深い加工 Deep milling 	—
	—	—	—	—	—
	—	EPSM-PN A235 高能率 安定加工 High efficiency stable milling 	EPDRF-TH A216 高精度仕上げ High accuracy milling 	—	—
	—	ETM-TH A226 高能率加工 High efficiency milling 	ETR-TH A222 高能率加工 High efficiency milling 	ETRP-TH A223 高能率深彫り High efficiency deep milling 	—
	—	ER8WB A254 立壁底面 仕上 Vertical Wall/Bottom Face Finishing 	CEPR A267 高速高能率 High speed, high efficiency 	—	—

MOLDINO—押し工具 工具形状別(ソリッドエンドミル)







MOLDINO's Recommended Tools by tool shape (Solid end mill)

高硬度鋼／一般鋼 for Hardened steels / General steels

工具形状 Tool shape		高硬度鋼 Hardened steels			
		レギュラー Regular	ディープ Deep	ペンシルネック Pencil neck	
スクエア Square	2枚刃 2 flutes	—	EPDSE-ATH A292 高硬度用 Hard milling	—	
	4枚刃 4 flutes	EPP-TH A328 高い安定性 High stability	—	—	
	6・8枚刃 6, 8 flutes	ES8WB A344 立壁底面仕上 Vertical Wall/Bottom Face Finishing	CEPR-TH A352 高能率 High efficiency	—	—
高送り High feed	4・6枚刃 4,6 flutes	EHHRE A263 高送り High feed	—	—	

非鉄 (銅・グラファイト) Non ferrous (Copper, Graphite)





工具形状 Tool shape		非鉄 (銅・グラファイト) Non ferrous (Copper, Graphite)		
		レギュラー Regular	ディープ Deep	
ボール Ball	2枚刃 2 flutes	EPAB-SD A142 銅高品位 仕上げ High accuracy finishing for copper	EPDB-SD A140 銅高品位 仕上げ High accuracy finishing for copper	
ラジウス Radius	2枚刃 2 flutes	EGR-HD A279 グラファイト 加工 for Graphite	EGDR-HD A277 グラファイト 加工 for Graphite	
スクエア Square	2枚刃 2 flutes	EPAS-SD A380 銅高品位 仕上げ High accuracy finishing for copper	EPDS-SD A378 銅高品位 仕上げ High accuracy finishing for copper	

		一般鋼 General steels			
	リブ Rib	レギュラー Regular	ディープ Deep	ペンシルネック Pencil neck	リブ Rib
	—	HGOS-PN A304  汎用加工 General purpose	EPDSE-PN A295  加工面良好 Good surface	—	—
	—	EPSM-PN A311  高能率 安定加工 High efficiency stable milling	EPPLS A338  ロング シャンク Long shank	—	—
	—	ES8WB A344  立壁底面 仕上 Vertical Wall/Bottom Face Finishing	CEPR A355  高速高能率 High speed, high efficiency	—	—
	—	EHHRE A263  高送り High feed	—	—	—

MOLDINO—押し工具 工具形状別(刃先交換式工具)

MOLDINO's Recommended Tools by tool shape (Indexable tool)

工具形状 Tool shape		荒加工 Roughing		
高送りラジラス High feed radius	6コーナ 6 corners	TD6N 強断続 Interrupted cutting C22		—
	4コーナ 4 corners	TR4F 最高能率 Maximum efficiency C10		TD4N 削り残り低減 Reduces remaining stock C28
	3コーナ 4 corners	ASRT 3コーナ 3 corners C38		—
	2コーナ 2 corners	ASR 元祖高送り High feed pioneer C32		ASR多刃 多刃 Multi flutes C54
ショルダー Shoulder	4コーナ 4 corners	SS4P 多コーナ Multi corners C154		—
	2コーナ 2 corners	AHJ 多機能 Multi functions C160		AHU 肩削り Shoulder cutting C146
ボール Ball	4枚刃 4 flutes	—	—	—
	2枚刃 2 flutes	—	—	—
ラジラス Radius	2枚刃 2 flutes	—	—	—

荒加工 Roughing		仕上げ加工 Finishing	
	—		—
ASRFmini ミニシリーズ Mini series C50		—	—
	—		—
ASM ミニシリーズ Mini series C140		RH2P 高硬度用 for Hardened steel C64	
	—		—
ASM ミニシリーズ Mini series C140		—	ASPV 底面立ち壁 Bottom Face/Vertical Wall C192
	—		ASPVmini ミニシリーズ Mini series C184
	—		ABP4F 高能率 High efficiency C136
	—	BR2P 低抵抗 Low cutting force C100	ABPF 高精度 High accuracy C126
	—		ARPF 高精度 High accuracy C92

MOLDINO—押し工具 加工形状別

MOLDINO's Recommended Tools by machining shape

加工方法 Machining method	工具種類 Kind of tools	高硬度材 Hardened steels
等高線加工 Contouring		工具形状の表を参照 Refer to list of tool shape
走査線加工 Scan line milling		
溝・側面・ヘリカル Slotting, Side milling, Helical	ソリッド Solid	EPP-TH 刃先形状 Flute shape スクエア / ラジウス Square / Radius 特長 Features 高い安定性 High stability スクエア Square A328 ラジウス Radius A247
	刃先交換式 Indexable type	ASPVmini 刃先形状 Flute shape ラジウス Radius 特長 Features 低抵抗加工 Low cutting force C184
側面 Side milling	ソリッド Solid	CEPR-TH 刃先形状 Flute shape スクエア / ラジウス RadSquare / Radius 特長 Features 高能率 High efficiency スクエア Square A352 ラジウス Radius A265
高能率側面 (トロコイド) Adaptive milling (Trochoid)	ソリッド Solid	EHHBE/EMBE 刃先形状 Flute shape ボール Ball 特長 Features 高能率 High efficiency EHHBE A124 EMBE A110
バーチカル Vertical	刃先交換式 Indexable type	ASPV 刃先形状 Flute shape ラジウス Radius 特長 Features 往復切削 Reciprocating cutting C192
穴あけ Drilling	ソリッド Solid	NSBH 刃先形状 Flute shape ドリル Drill 特長 Features ノンステップ加工 Non step drilling E49
ねじ切り Threading	ソリッド Solid	EDT 刃先形状 Flute shape スレッドミル Thread mill 特長 Features 下穴無しねじ切り Threading without pilot hole F6
面取り Chamfering	ソリッド Solid	DN2HC 刃先形状 Flute shape V字形 "V" shape 特長 Features 高品位面取り High quality chamfering F15
	刃先交換式 Indexable type	

<p>一般材 General steels</p>	<p>非鉄 (銅・グラファイト) Non ferrous (Copper, Graphite)</p>
<p>工具形状の表を参照 Refer to list of tool shape</p>	
<p>EPSM</p> <p>刃先形状 スクエア / ラジウス Flute shape Square / Radius</p> <p>特長 高能率安定加工 Features High efficiency stable milling</p>  <p>スクエア Square A311 ラジウス Radius A235</p>	<p>EPAS-SD</p> <p>刃先形状 スクエア (銅) Flute shape Square (Copper)</p> <p>特長 銅高品位仕上げ Features High quality finishing for copper</p>  <p>A380</p>
<p>—</p>	<p>EGR-HD</p> <p>刃先形状 ラジウス (グラファイト) Flute shape Radius (Graphite)</p> <p>特長 高強度長寿命 Features High strength, long life</p>  <p>A279</p>
<p>ASM</p> <p>刃先形状 ラジウス Flute shape Radius</p> <p>特長 高能率安定加工 Features High efficiency stable milling</p>  <p>C140</p>	<p>—</p>
<p>ES(R)8WB</p> <p>刃先形状 スクエア / ラジウス Flute shape Square / Radius</p> <p>特長 高精度 Features High accuracy</p>  <p>スクエア Square A344 ラジウス Radius A254</p>	<p>—</p>
<p>ER5HS</p> <p>刃先形状 ラジウス Flute shape Radius</p> <p>特長 高能率 Features High efficiency</p>  <p>A257</p>	<p>—</p>
<p>ASPV</p> <p>刃先形状 ラジウス Flute shape Radius</p> <p>特長 往復切削 Features Reciprocating cutting</p>  <p>C192</p>	<p>—</p>
<p>WHNSB</p> <p>刃先形状 ドリル Flute shape Drill</p> <p>特長 ノンステップ加工 Features Non step drilling</p>  <p>E20</p>	<p>WHNSB-SD</p> <p>刃先形状 ドリル Flute shape Drill</p> <p>特長 ノンステップ加工 Features Non step drilling</p>  <p>E45</p>
<p>ET</p> <p>刃先形状 スレッドミル Flute shape Thread mill</p> <p>特長 高品位安定ねじ切り Features High quality threading</p>  <p>F4</p>	<p>—</p>
<p>DN2HC</p> <p>刃先形状 V字形状 Flute shape "V" shape</p> <p>特長 高品位面取り Features High quality chamfering</p>  <p>F15</p>	<p>—</p>
<p>CPC</p> <p>刃先形状 面取り Flute shape Chamfering</p> <p>特長 広範囲面取り Features Wide chamfering</p>  <p>C228</p>	<p>—</p>























MOLDINO ー押し工具 プラスチック金型用

MOLDINO's Recommended Tools (for Plastic molds)

型種 Mold type	荒加工 Roughing				仕上げ加工 Finishing			
構造部 Structure	TR4F C10 荒加工(等高線) 超高送りラジラス工具 Roughing (Contouring) Ultra high feed radius tool φ63~φ50	AHU C146 荒加工~中仕上 90°タイプ Roughing ~ Semi finishing 90° type φ63~φ20	ASPV mini C184 ミニシリーズ Mini series φ32~φ10	ER8WB ES8WB A254 A344 壁面仕上げ Wall finishing φ12~φ10	AVア-バ AVArbor D12 荒、仕上げ 防振ア-バ Roughing, Finishing Damped Arbor φ63~φ40	ARPF C92 中仕上~仕上げ加工 高精度加工 Semi finishing ~ Finishing High accuracy cutting φ30~φ10		
	TR4F C10 荒加工(等高線) 超高送りラジラス工具 Roughing (Contouring) Ultra high feed radius tool φ80~φ50	TD4N C28 荒加工(等高線) 削り残り低減設計 Roughing (Contouring) Design to reduce remaining stock φ32~φ16	ABPF SC C126 中仕上~仕上げ加工 高精度加工 Semi finishing ~ Finishing High accuracy cutting φ30~φ20	BR2P C100 中仕上(走査線) ねじれ切れ刃でビビリ抑制 Semi finishing (Scan line) Helical cutting edge suppresses vibration φ30~φ20	ETM A226 中仕上(隅取) オーバル形状でビビリ抑制 Semi finishing (Corner recessing) Oval shape suppresses vibration φ16~φ6	EPDBE-PN A75 中仕上~仕上げ加工 (隅取) Semi finishing ~ Finishing (Corner recessing) φ10~φ1		
バンパー Bumper (S50C, SCM)	TR4F C10 荒加工(等高線) 超高送りラジラス工具 Roughing (Contouring) Ultra high feed radius tool φ63~φ50	TD4N C28 荒加工(等高線) 削り残り低減設計 Roughing (Contouring) Design to reduce remaining stock φ32~φ16	ABPF SC C126 中仕上~仕上げ加工 高精度加工 Semi finishing ~ Finishing High accuracy cutting φ30~φ20	EPDBE-PN A75 中仕上~仕上げ加工 (隅取) Semi finishing ~ Finishing (Corner recessing) φ10~φ1	BR2P C100 中仕上(走査線) ねじれ切れ刃でビビリ抑制 Semi finishing (Scan line) Helical cutting edge suppresses vibration φ30~φ20	ETM A226 中仕上(隅取) オーバル形状でビビリ抑制 Semi finishing (Corner recessing) Oval shape suppresses vibration φ16~φ6	ECRB A137 補強リブ 放電から直彫りへ Stiffening rib Replaces EDM to milling φ1~φ0.8	
	TR4F C10 荒加工(等高線) 超高送りラジラス工具 Roughing (Contouring) Ultra high feed radius tool φ63~φ50	TD4N C28 荒加工(等高線) 削り残り低減設計 Roughing (Contouring) Design to reduce remaining stock φ32~φ16	ABPF SC C126 中仕上~仕上げ加工 高精度加工 Semi finishing ~ Finishing High accuracy cutting φ30~φ20	EPDBE-PN A75 中仕上~仕上げ加工 (隅取) Semi finishing ~ Finishing (Corner recessing) φ10~φ1	BR2P C100 中仕上(走査線) ねじれ切れ刃でビビリ抑制 Semi finishing (Scan line) Helical cutting edge suppresses vibration φ30~φ20	ETM A226 中仕上(隅取) オーバル形状でビビリ抑制 Semi finishing (Corner recessing) Oval shape suppresses vibration φ16~φ6	ECRB A137 補強リブ 放電から直彫りへ Stiffening rib Replaces EDM to milling φ1~φ0.8	
ドアトリム Door trim (HPM7)	TR4F C10 荒加工(等高線) 超高送りラジラス工具 Roughing (Contouring) Ultra high feed radius tool φ63~φ50	TD4N C28 荒加工(等高線) 削り残り低減設計 Roughing (Contouring) Design to reduce remaining stock φ32~φ16	ABPF SC C126 中仕上~仕上げ加工 高精度加工 Semi finishing ~ Finishing High accuracy cutting φ30~φ20	EPDBE-PN A75 中仕上~仕上げ加工 (隅取) Semi finishing ~ Finishing (Corner recessing) φ10~φ1	BR2P C100 中仕上(走査線) ねじれ切れ刃でビビリ抑制 Semi finishing (Scan line) Helical cutting edge suppresses vibration φ30~φ20	ETM A226 中仕上(隅取) オーバル形状でビビリ抑制 Semi finishing (Corner recessing) Oval shape suppresses vibration φ16~φ6	ECRB A137 補強リブ 放電から直彫りへ Stiffening rib Replaces EDM to milling φ1~φ0.8	
	TR4F C10 荒加工(等高線) 超高送りラジラス工具 Roughing (Contouring) Ultra high feed radius tool φ63~φ50	TD4N C28 荒加工(等高線) 削り残り低減設計 Roughing (Contouring) Design to reduce remaining stock φ32~φ16	ABPF SC C126 中仕上~仕上げ加工 高精度加工 Semi finishing ~ Finishing High accuracy cutting φ30~φ20	EPDBE-PN A75 中仕上~仕上げ加工 (隅取) Semi finishing ~ Finishing (Corner recessing) φ10~φ1	BR2P C100 中仕上(走査線) ねじれ切れ刃でビビリ抑制 Semi finishing (Scan line) Helical cutting edge suppresses vibration φ30~φ20	ETM A226 中仕上(隅取) オーバル形状でビビリ抑制 Semi finishing (Corner recessing) Oval shape suppresses vibration φ16~φ6	ECRB A137 補強リブ 放電から直彫りへ Stiffening rib Replaces EDM to milling φ1~φ0.8	
ランプ Lamp レンズ Lens (HPM7, P20) エクステンション Extension (NAK80, CENA-V, P-21) リフレクター Reflector (STAVAX, HPM38) ハウジング Housing (SC, SCM, P20)	TD4N C28 荒加工(等高線) 削り残り低減設計 Roughing (Contouring) Design to reduce remaining stock φ32~φ16	ABPF SC C126 中仕上~仕上げ加工 高精度加工 Semi finishing ~ Finishing High accuracy cutting φ20~φ16	ETM A226 中仕上(隅取) オーバル形状でビビリ抑制 Semi finishing (Corner recessing) Oval shape suppresses vibration φ10~φ6	EMBPE A111 中仕上~仕上げ加工 Semi finishing ~ Finishing φ10~φ1	EPDBEH-TH3 A56 中仕上~仕上げ加工 Semi finishing ~ Finishing φ2~φ0.6			
	TD4N C28 荒加工(等高線) 削り残り低減設計 Roughing (Contouring) Design to reduce remaining stock φ32~φ16	ABPF SC C126 中仕上~仕上げ加工 高精度加工 Semi finishing ~ Finishing High accuracy cutting φ20~φ16	ETM A226 中仕上(隅取) オーバル形状でビビリ抑制 Semi finishing (Corner recessing) Oval shape suppresses vibration φ10~φ6	EMBPE A111 中仕上~仕上げ加工 Semi finishing ~ Finishing φ10~φ1	EPDBEH-TH3 A56 中仕上~仕上げ加工 Semi finishing ~ Finishing φ2~φ0.6			
コネクター Connector (PD613)	EHHBE-TH3 A124 荒加工(等高線) 4枚刃高硬度直彫り Roughing (Contouring) 4 flutes hard milling R1~R0.5	EPDREH-TH3 A172 荒~中仕上加工(等高線) 高硬度直彫り Roughing ~ Semi finishing (Contouring) Hard milling φ1~φ0.4	EPDBEH-TH3 A56 中仕上~仕上げ加工(等高線) 高硬度直彫り Semi finishing ~ Finishing (Contouring) Hard milling R1~R0.05	EPDREH-TH3 A172 中仕上~仕上げ加工(等高線) 高硬度直彫り Semi finishing ~ Finishing (Contouring) Hard milling φ0.6~φ0.2				
	EHHBE-TH3 A124 荒加工(等高線) 4枚刃高硬度直彫り Roughing (Contouring) 4 flutes hard milling R1~R0.5	EPDREH-TH3 A172 荒~中仕上加工(等高線) 高硬度直彫り Roughing ~ Semi finishing (Contouring) Hard milling φ1~φ0.4	EPDBEH-TH3 A56 中仕上~仕上げ加工(等高線) 高硬度直彫り Semi finishing ~ Finishing (Contouring) Hard milling R1~R0.05	EPDREH-TH3 A172 中仕上~仕上げ加工(等高線) 高硬度直彫り Semi finishing ~ Finishing (Contouring) Hard milling φ0.6~φ0.2				
レンズホルダー Lens holder (STAVAX)	EHHRE-TH3 A263 荒加工(等高線) 高硬度直彫り Roughing (Contouring) Hard milling φ3~φ1	EPDBEH-TH3 A56 中仕上~仕上げ加工(等高線) 高硬度直彫り Semi finishing ~ Finishing (Contouring) Hard milling R0.5~R0.1	EPDREH-TH3 A172 中仕上~仕上げ加工(等高線) 高硬度直彫り Semi finishing ~ Finishing (Contouring) Hard milling φ1~φ0.2					
	EHHRE-TH3 A263 荒加工(等高線) 高硬度直彫り Roughing (Contouring) Hard milling φ3~φ1	EPDBEH-TH3 A56 中仕上~仕上げ加工(等高線) 高硬度直彫り Semi finishing ~ Finishing (Contouring) Hard milling R0.5~R0.1	EPDREH-TH3 A172 中仕上~仕上げ加工(等高線) 高硬度直彫り Semi finishing ~ Finishing (Contouring) Hard milling φ1~φ0.2					
冷却穴関係 Cooling hole related (SKD61)	WHNSB E31 冷却穴(穴あけ) 深穴への穴あけ Cooling hole (Drilling) Deep hole drilling 40D~50D	NSBH E49 冷却穴(穴あけ) 高硬度穴あけ Cooling hole (Drilling) for hardness φ12~φ3	EDT-PT F10 PTネジ加工(スレッド) 高硬度直彫り(高品位ネジ) For PT threads - threading hardened steels (high quality surface) PT1~PT1/16					
	WHNSB E31 冷却穴(穴あけ) 深穴への穴あけ Cooling hole (Drilling) Deep hole drilling 40D~50D	NSBH E49 冷却穴(穴あけ) 高硬度穴あけ Cooling hole (Drilling) for hardness φ12~φ3	EDT-PT F10 PTネジ加工(スレッド) 高硬度直彫り(高品位ネジ) For PT threads - threading hardened steels (high quality surface) PT1~PT1/16					













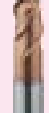



MOLDINO ー押し工具 プレス金型用

MOLDINO's Recommended Tools (for Stamping dies)

型種 Die type	荒加工 Roughing				仕上げ加工 Finishing			
構造部 Structure (FC、FCD)	TR4F 荒加工(等高線) 超高送りラジアス工具 Roughing (Contouring) Ultra high feed radius tool φ63~φ50	C10 	AHU 荒加工~中仕上 90°タイプ Roughing ~ Semi finishing 90° type φ63~φ20	C146 	ASPV 中仕上~仕上げ加工 多刃による高能率加工 Semi finishing ~ Finishing High efficiency cutting with multi-flute φ63~φ25	C192 		
	AME 荒加工 Roughing φ50~φ32	C180 	ASV 荒加工~仕上げ 多機能工具 Roughing ~ Finishing Multi function tool φ63~φ50	C174 			ARPF 中仕上~仕上げ加工 高精度加工 Semi finishing ~ Finishing High accuracy cutting φ30~φ25	C92 
OUTER PANEL Outer panel (FC/FCD)	TR4F 荒加工(等高線) 超高送りラジアス工具 Roughing (Contouring) Ultra high feed radius tool φ63~φ50	C10 			ABPF ST 中仕上~仕上げ加工 高精度加工 Semi finishing ~ Finishing High accuracy cutting φ30~φ10	C126 		
	BR2P 荒~中仕上(走査線) ねじれ切れ刃でビビリ抑制 Semi finishing (Scan line) Helical cutting edge suppresses vibration φ50~φ20	C100 			ABP4F 中仕上~仕上げ 能率追及型 Semi finishing to finishing Efficiency pursuit type φ30~φ20	C136 		
センターピラー Center pillar (SKD11)	TR4F 荒加工(等高線) 超高送りラジアス工具 Roughing (Contouring) Ultra high feed radius tool φ63~φ50	C10 	ASRF mini 荒加工(等高線) 低抵抗 高硬度材対応 Roughing (Contouring) Low cutting force, usable for hard milling φ32~φ20	C50 	ABPF SH 中仕上~仕上げ加工 高精度加工 Semi finishing ~ Finishing High accuracy cutting φ30~φ10	C126 		
	BR2P 中仕上(走査線) Semi finishing (Scan line) φ30~φ20	C100 					EMBE-ATH 隅部 3枚刃能率向上 Corner recessing Improves efficiency with 3 flutes φ12~φ4	A110 
ダイカットロール Die cut roll (HSS)	EHHRE-TH3 荒加工(等高線) 高硬度直彫り Roughing (Contouring) Hard milling φ4~φ2	A263 	EHHBE-TH3 荒加工(等高線) 高硬度直彫り Roughing (Contouring) Hard milling φ4~φ2	A124 	EPDBEH-TH3 中仕上~仕上げ加工(等高線) 高硬度直彫り Semi finishing ~ Finishing (Contouring) Hard milling R0.5~R0.1	A56 		
							EPDREH-TH3 中仕上~仕上げ加工(等高線) 高硬度直彫り Semi finishing ~ Finishing (Contouring) Hard milling φ1~φ0.2	A172 
リードフレーム Lead frame (HSS)			EHHRE-TH3 荒加工(等高線) 高硬度直彫り Roughing (Contouring) Hard milling φ3~φ1	A263 			EPDBEH-TH3 中仕上~仕上げ加工(等高線) 高硬度直彫り Semi finishing ~ Finishing (Contouring) Hard milling R0.5~R0.1	A56 
							EPDREH-TH3 中仕上~仕上げ加工(等高線) 高硬度直彫り Semi finishing ~ Finishing (Contouring) Hard milling φ1~φ0.2	A172 

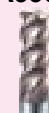

























MOLDINO一押し工具 鍛造金型用

MOLDINO's Recommended Tools (for Forging dies)

型種 Die type	荒加工 Roughing	仕上げ加工 Finishing						
クランクシャフト Crankshaft (SKD61)	TR4F 荒加工(等高線) 高能率高送り Roughing (Contouring) High efficiency high feed φ63~φ32	C10 	RH2P 中荒加工(等高線) 高硬度直彫り Medium roughing (Contouring) Hard milling φ32~φ12	C64 	ABPF SH 中仕上~仕上加工 高精度加工 Semi finishing - Finishing High accuracy cutting φ20~φ16	C126 	EMBE-ATH 仕上加工(等高線) 3枚刃能率向上 Finishing (Contouring) Improves efficiency with 3 flutes R6~R2	A110 
	ASR多刃 荒加工(等高線) 削り残り低減設計 Design to reduce remaining stock φ32~φ16	C54 	EHHRE-TH3 中荒加工(等高線) 高硬度直彫り Medium roughing (Contouring) Hard milling φ12~φ8	A263 	EHHBE-TH3 中仕上加工(等高線) 4枚刃高硬度直彫り Semi finishing (Contouring) Hard milling with 4 flutes R6~R4	A124 		
コンロッド Connecting rod (SKD61)	TR4F 荒加工(等高線) 高能率高送り Roughing (Contouring) High efficiency high feed φ63~φ32	C10 	ETM 中荒加工(等高線) 高硬度直彫り Medium roughing (Contouring) Hard milling φ12~φ8	A226 	EMBE-ATH 中仕上~仕上加工(等高線) 3枚刃能率向上 Semi finishing - Finishing (Contouring) Improves efficiency with 3 flutes φ10~φ6	A110 	EPDBEH-TH3 仕上加工(等高線) 高硬度直彫り Finishing (Contouring) Hard milling R3~R0.5	A56 
	TD4N 荒加工(等高線) 高能率高送り Roughing (Contouring) High efficiency high feed φ32~φ20	C28 	ABPF SH 中仕上~仕上加工 高精度加工 Semi finishing - Finishing High accuracy cutting φ20~φ16	C126 	EPP-TH 底面仕上加工(等高線) 高硬度直彫り Bottom face finishing (Contouring) Hard milling φ12~φ6	A336 		
ベベルギア Bevel gear (YXR33)	TD4N 荒加工(等高線) 高能率 削り残り低減 Roughing (Contouring) High efficiency, reduces remaining stock φ32~φ16	C28 	EHHRE-TH3 中荒加工(等高線) 高硬度直彫り Medium roughing (Contouring) Hard milling φ12~φ8	A263 	EHHBE-TH3 中仕上加工(等高線) 4枚刃高硬度直彫り Semi finishing (Contouring) Hard milling with 4 flutes R6~R0.5	A124 	EPDBEH-TH3 仕上加工(等高線) 高硬度直彫り Finishing (Contouring) Hard milling R5~R0.5	A56 

MOLDINO ー押し工具 ダイカスト金型用

MOLDINO's Recommended Tools (for Die-casting molds)

型種 Mold type	荒加工 Roughing	仕上げ加工 Finishing												
ウォータージャケット Water jacket (SKD61)	TD4N 荒加工(等高線) 高能率 削り残り低減 Roughing (Contouring) High efficiency, reduces remaining stock φ32~φ20	C28 	ASRV mini 荒加工(等高線) 削り残り低減設計 Roughing (Contouring) Design to reduce cutting remain φ32~φ16	C54 	ASPV mini 中仕上げ~仕上げ加工 高能率仕上げ加工 Semi finishing ~ Finishing High efficiency finishing φ20~φ16	C184 	GF2T 中仕上げ~仕上げ加工 異形工具による高能率加工 Semi finishing ~ Finishing High efficiency with special shape tools φ35~φ20	B6 						
	シリンダーヘッド Cylinder head (SKD61)	TR4F 荒加工(等高線) 高能率高送り Roughing (Contouring) High efficiency, high feed φ63~φ32	C10 	ASRF mini 荒加工(等高線) 高能率高送り Roughing (Contouring) High efficiency high feed φ32~φ20	C50 	EPDBPE-ATH 中仕上げ~仕上げ加工(等高線) 高精度直彫り Semi finishing ~ Finishing (Contouring) High accuracy hard milling R3~R0.5	A84 	ASRV mini 荒加工(等高線) 削り残り低減設計 Design to reduce remaining stock φ32~φ16	C54 	EPSM-PN 荒加工(高能率側面) 加工熱反り防止 Roughing (Adaptive milling) Prevents warping due to cutting heat φ12~φ10	A311 	ETM(P) 中荒加工(等高線) 4枚刃高能率直彫り Middle roughing (Contouring) High efficiency hard milling with 4 flutes φ10~φ4	A226 	DN2HC ガス抜きV溝加工(5軸加工) 放電から直彫りへの置き換え Replaces EDM to milling φ10~φ4
バルブボディ Valve body (SKD61)		TR4F 荒加工(等高線) 高能率高送り Roughing (Contouring) High efficiency high feed φ63~φ32	C10 	TD4N 荒加工(等高線) 高能率 削り残り低減 Roughing (Contouring) High efficiency, reduces remaining stock φ32~φ16	C28 	ABPF 中仕上げ~仕上げ加工 高精度加工 Semi finishing ~ Finishing High accuracy cutting φ20~φ16	C126 	EMBPE-ATH 中仕上げ加工(等高線) 3枚刃高能率加工 Semi finishing (Contouring) High efficiency with 3 flutes R1.5~R0.75	A111 	ETM 荒加工(等高線) 高能率直彫り Roughing (Contouring) High efficiency milling φ10~φ4	A226 	ETRP 中荒加工(等高線) 高能率直彫り Middle roughing (Contouring) High efficiency milling φ4~φ1.5	A223 	EPDRF-TH 底面・隅加工(等高線) 4枚刃高能率加工 For bottom face, corner (Contouring) High efficiency with 4 flutes φ3~φ1.5
	インバーターケース Inverter case (SKD61)	TD4N 荒加工(等高線) 高能率高送り Roughing (Contouring) High efficiency high feed φ32~φ20	C28 	ASRV mini 荒加工(等高線) 削り残り低減設計 Design to reduce remaining stock φ32~φ20	C54 	ETM 荒加工(等高線) 高能率直彫り Roughing (Contouring) High efficiency milling φ10~φ4	A226 	ARPF 仕上げ加工(等高線) 高精度加工 Finishing (Contouring) High accuracy cutting φ32~φ12	C92 					
ヒートシンク Heat sink (SKD61)		ETRP 中荒加工(等高線) 高能率直彫り Medium roughing (Contouring) High efficiency milling φ4~φ1.5	A223 	EMBPE-ATH 中仕上げ加工(等高線) 3枚刃高能率加工 Semi finishing (Contouring) High efficiency with 3 flutes R1.5~R0.75	A111 	EB4HR 仕上げ加工(等高線) 高品位仕上げ面(段差無し) Finishing (Contouring) High quality finishing surface (less steps) R0.6~R0.3	A132 							
	冷却穴関係 Cooling hole related (SKD61)	WHNSB 冷却穴(穴あけ) 深穴への穴あけ Cooling hole (Drilling) Deep hole drilling 40D~50D	E31 	NSBH 冷却穴(穴あけ) 高硬度穴あけ Cooling hole drilling Hardened steels drilling φ12~φ3	E49 	EDT-PT PTネジ加工(スレッド) 高硬度直彫り(高品位ネジ) For PT threads - threading hardened steels (high quality surface) PT1~PT1/16	F10 	WHSR 冷却SR穴(穴あけ) 割れ防止SR直彫り加工 Cooling SR hole (Drilling) SR machining to suppress cracking φ12~φ3	E56 					

超硬エンドミル Carbide End Mills

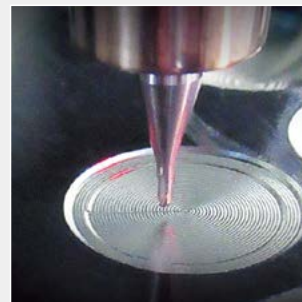

超硬エンドミル形状別 選定目安表 ……A2
Selection criteria table according to carbide end mill shape

外径別寸法早見表

Quick dimension reference table by mill diameter

ボール Ball	……………	A20
ラジラス Radius	……………	A31
スクエア Square	……………	A40

ディープシリーズラインナップ ……A54
Deep series line up

ソリッドエンドミル用コーティング材種 …A457
Coating materials for solid end mills

種類別(カタログ掲載順) By type (catalog listing order)

ボールエンドミル

Ball End Mills

EPDBEH(-F)-TH3	……	A56
EPDBE(-□□□)	……	A72
EPDBPE-ATH	……	A84
EPSBE(-□)-TH	……	A97
EPBTS-TH	……	A100
EPBT	……	A102
HGOB(□□)-PN	……	A104
ESHB-H/N-TH	……	A108
EMB(□)E-ATH	……	A110
EHHBE-TH3	……	A124
EHHB-ATH	……	A127
EPHB-PN	……	A130
EB4HR-ATH	……	A132
ECRB-PN	……	A137
EPDB-SD	……	A140
EPAB-SD	……	A142
EGDB-HD	……	A143
EGB-HD	……	A145
PCDB	……	A146
CBN-EHB	……	A147
CBN-EPSB	……	A151
EFB	……	A153
EPSB-□-TH	……	A154
HPB(□□)-C	……	A156
HYPB-C	……	A156
EPBPN	……	A158

ラジラスエンドミル

Radius End Mills

EPDREH2-TH3	……	A172
EPDREH4-TH3	……	A174
EPDRE-ATH	……	A194
EPDRP-TH	……	A210
EPDRF-TH	……	A216
ETR(P)-TH	……	A222
ETM(□□)-TH	……	A226
HGOF-TH	……	A232
EPDM(□)-R-PN	……	A235
EPP-CR-TH	……	A247
EPP(□□)-CR	……	A249
ER8WB-ATH	……	A254
ER5HS-PN	……	A257
EMX(□)-CR-TH	……	A259
EHHRE-TH3	……	A263
CEPR-CR-TH	……	A265
CEPR-CR	……	A267
EAP-CR-TH	……	A269
EMXA-CR	……	A272
多刃テーパラジラス	……	A276
EGDR-HD	……	A277

スクエアエンドミル

Square End Mills

EPDSE(-□□□)	……	A292
HGOS-PN	……	A304
EPP3-CS	……	A308
EPSF(□)-PN	……	A310
EPDM(□□)-PN	……	A311
EPP(□)-TH	……	A328
EPP(□)4(-□)-CS	……	A332
EPP(□□)	……	A336
ES8WB-ATH	……	A344
EMX(□)-(-SR)-TH	……	A346
CEP(□)-TH	……	A352
CEP(□□)	……	A355
EPDW(□)-PN	……	A361
EPQ(□)-CS	……	A369
EAP-TH	……	A371
EMXA	……	A374
EPDS-SD	……	A378
EPAS-SD	……	A380
EC(□)-SD	……	A381
EC(□)-HD	……	A382
EPCDS	……	A383

ヘッド交換式エンドミル

Exchangeable head End Mill

EMM(-TH)	……	A384
HYPB-C	……	A385
HPSLN-C	……	A385
AES	……	A386
HES(□)2-C	……	A387
HES(□)2	……	A390
HES(□)4-C	……	A394
HES(□)4	……	A396
EPJS(□□)-J	……	A427
EPR(□□)	……	A429
EPDS(-□□)	……	A430
PES(□)2-C	……	A434
PESR4-C	……	A434
PES(□)2	……	A435
PESR4	……	A435
Y(□)-CS	……	A437
SES(-□)	……	A439
KES(□)	……	A440
TES	……	A440
FE7	……	A440
GS(□)	……	A441
GXR	……	A441
HTE-C	……	A443
HTS(□)	……	A444
FE4	……	A445
GTB	……	A445
EPRB-C	……	A446
DEB-C	……	A448
RIB-CR-C	……	A449
EPRI-C	……	A450
DES-C	……	A452
RIB-C	……	A453
EPQ(□□)-CS	……	A455
BH(□□)	……	A456
EPRI-C	……	A450
EPDS-SD	……	A378
EPAS-SD	……	A380
EC(□)-SD	……	A381
EC(□)-HD	……	A382
EPCDS	……	A383
EPRI-C	……	A450
EPDS-SD	……	A378
EPAS-SD	……	A380
EC(□)-SD	……	A381
EC(□)-HD	……	A382
EPCDS	……	A383
EPRI-C	……	A450
EPDS-SD	……	A378
EPAS-SD	……	A380
EC(□)-SD	……	A381
EC(□)-HD	……	A382
EPCDS	……	A383
EPRI-C	……	A450
EPDS-SD	……	A378
EPAS-SD	……	A380
EC(□)-SD	……	A381
EC(□)-HD	……	A382
EPCDS	……	A383
EPRI-C	……	A450
EPDS-SD	……	A378
EPAS-SD	……	A380
EC(□)-SD	……	A381
EC(□)-HD	……	A382
EPCDS	……	A383
EPRI-C	……	A450
EPDS-SD	……	A378
EPAS-SD	……	A380
EC(□)-SD	……	A381
EC(□)-HD	……	A382
EPCDS	……	A383
EPRI-C	……	A450
EPDS-SD	……	A378
EPAS-SD	……	A380
EC(□)-SD	……	A381
EC(□)-HD	……	A382
EPCDS	……	A383
EPRI-C	……	A450
EPDS-SD	……	A378
EPAS-SD	……	A380
EC(□)-SD	……	A381
EC(□)-HD	……	A382
EPCDS	……	A383
EPRI-C	……	A450
EPDS-SD	……	A378
EPAS-SD	……	A380
EC(□)-SD	……	A381
EC(□)-HD	……	A382
EPCDS	……	A383
EPRI-C	……	A450
EPDS-SD	……	A378
EPAS-SD	……	A380
EC(□)-SD	……	A381
EC(□)-HD	……	A382
EPCDS	……	A383
EPRI-C	……	A450
EPDS-SD	……	A378
EPAS-SD	……	A380
EC(□)-SD	……	A381
EC(□)-HD	……	A382
EPCDS	……	A383
EPRI-C	……	A450
EPDS-SD	……	A378
EPAS-SD	……	A380
EC(□)-SD	……	A381
EC(□)-HD	……	A382
EPCDS	……	A383
EPRI-C	……	A450
EPDS-SD	……	A378
EPAS-SD	……	A380
EC(□)-SD	……	A381
EC(□)-HD	……	A382
EPCDS	……	A383
EPRI-C	……	A450
EPDS-SD	……	A378
EPAS-SD	……	A380
EC(□)-SD	……	A381
EC(□)-HD	……	A382
EPCDS	……	A383
EPRI-C	……	A450
EPDS-SD	……	A378
EPAS-SD	……	A380
EC(□)-SD	……	A381
EC(□)-HD	……	A382
EPCDS	……	A383
EPRI-C	……	A450
EPDS-SD	……	A378
EPAS-SD	……	A380
EC(□)-SD	……	A381
EC(□)-HD	……	A382
EPCDS	……	A383
EPRI-C	……	A450
EPDS-SD	……	A378
EPAS-SD	……	A380
EC(□)-SD	……	A381
EC(□)-HD	……	A382
EPCDS	……	A383
EPRI-C	……	A450
EPDS-SD	……	A378
EPAS-SD	……	A380
EC(□)-SD	……	A381
EC(□)-HD	……	A382
EPCDS	……	A383
EPRI-C	……	A450
EPDS-SD	……	A378
EPAS-SD	……	A380
EC(□)-SD	……	A381
EC(□)-HD	……	A382
EPCDS	……	A383
EPRI-C	……	A450
EPDS-SD	……	A378
EPAS-SD	……	A380
EC(□)-SD	……	A381
EC(□)-HD	……	A382
EPCDS	……	A383
EPRI-C	……	A450
EPDS-SD	……	A378
EPAS-SD	……	A380
EC(□)-SD	……	A381
EC(□)-HD	……	A382
EPCDS	……	A383
EPRI-C	……	A450
EPDS-SD	……	A378
EPAS-SD	……	A380
EC(□)-SD	……	A381
EC(□)-HD	……	A382
EPCDS	……	A383
EPRI-C	……	A450
EPDS-SD	……	A378
EPAS-SD	……	A380
EC(□)-SD	……	A381
EC(□)-HD	……	A382
EPCDS	……	A383
EPRI-C	……	A450
EPDS-SD	……	A378
EPAS-SD	……	A380
EC(□)-SD	……	A381
EC(□)-HD	……	A382
EPCDS	……	A383
EPRI-C	……	A450
EPDS-SD	……	A378
EPAS-SD	……	A380
EC(□)-SD	……	A381
EC(□)-HD	……	A382
EPCDS	……	A383
EPRI-C	……	A450
EPDS-SD	……	A378
EPAS-SD	……	A380
EC(□)-SD	……	A381
EC(□)-HD	……	A382
EPCDS	……	A383
EPRI-C	……	A450
EPDS-SD	……	A378
EPAS-SD	……	A380
EC(□)-SD	……	A381
EC(□)-HD	……	A382
EPCDS	……	A383
EPRI-C	……	A450
EPDS-SD	……	A378
EPAS-SD	……	A380
EC(□)-SD	……	A381
EC(□)-HD	……	A382
EPCDS	……	A383
EPRI-C	……	A450
EPDS-SD	……	A378
EPAS-SD	……	A380
EC(□)-SD	……	A381
EC(□)-HD	……	A382
EPCDS	……	A383
EPRI-C	……	A450
EPDS-SD	……	A378
EPAS-SD	……	A380
EC(□)-SD	……	A381
EC(□)-HD	……	A382
EPCDS	……	A383
EPRI-C	……	A450
EPDS-SD	……	A378
EPAS-SD	……	A380
EC(□)-SD	……	A381
EC(□)-HD	……	A382
EPCDS	……	A383
EPRI-C	……	A450
EPDS-SD	……	A378
EPAS-SD	……	A380
EC(□)-SD	……	A381
EC(□)-HD	……	A382
EPCDS	……	A383
EPRI-C	……	A450
EPDS-SD	……	A378
EPAS-SD	……	A380
EC(□)-SD	……	A381
EC(□)-HD	……	A382
EPCDS	……	A383
EPRI-C	……	A450
EPDS-SD	……	A378
EPAS-SD	……	A380
EC(□)-SD	……	A381
EC(□)-HD	……	A382
EPCDS	……	A383
EPRI-C	……	A450
EPDS-SD	……	A378
EPAS-SD	……	A380
EC(□)-SD	……	A381
EC(□)-HD	……	A382
EPCDS	……	A383
EPRI-C	……	A450
EPDS-SD	……	A378
EPAS-SD	……	A380
EC(□)-SD	……	A381
EC(□)-HD	……	A382
EPCDS	……	A383
EPRI-C	……	A450
EPDS-SD	……	A378
EPAS-SD	……	A380
EC(□)-SD	……	A381
EC(□)-HD	……	A382
EPCDS	……	A383
EPRI-C	……	A450
EPDS-SD	……	A378
EPAS-SD	……	A380
EC(□)-SD	……	A381
EC(□)-HD	……	A382
EPCDS	……	A383
EPRI-C	……	A450
EPDS-SD	……	A378
EPAS-SD	……	A380
EC(□)-SD	……	A381
EC(□)-HD	……	A382
EPCDS	……	A383
EPRI-C	……	A450
EPDS-SD	……	A378
EPAS-SD	……	A380
EC(□)-SD	……	A381
EC(□)-HD	……	A382
EPCDS	……	A383
EPRI-C	……	A450
EPDS-SD	……	A378
EPAS-SD	……	A380
EC(□)-SD	……	A381
EC(□)-HD	……	A382
EPCDS	……	A383
EPRI-C	……	A450
EPDS-SD	……	A378
EPAS-SD	……	A380
EC(□)-SD	……	A381
EC(□)-HD	……	A382
EPCDS	……	A383
EPRI-C	……	A450
EPDS-SD	……	A378
EPAS-SD	……	A380
EC(□)-SD	……	A381
EC(□)-HD	……	A382
EPCDS	……	A383
EPRI-C	……	A450
EPDS-SD	……	A378
EPAS-SD	……	A380
EC(□)-SD	……	A381
EC(□)-HD	……	A382
EPCDS	……	A383
EPRI-C	……	A450
EPDS-SD	……	A378
EPAS-SD	……	A380
EC(□)-SD	……	A381
EC(□)-HD	……	A382
EPCDS	……	A383
EPRI-C	……	A450
EPDS-SD	……	A378
EPAS-SD	……	A380
EC(□)-SD	……	A381
EC(□)-HD	……	A382
EPCDS	……	A383
EPRI-C	……	A450
EPDS-SD	……	A378
EPAS-SD	……	A380
EC(□)-SD	……	A381
EC(□)-HD	……	A382
EPCDS	……	A383
EPRI-C	……	A450
EPDS-SD	……	A378
EPAS-SD	……	A380
EC(□)-SD	……	A381
EC(□)-HD	……	A382
EPCDS	……	A383
EPRI-C	……	A450
EPDS-SD	……	A378
EPAS-SD	……	A380
EC(□)-SD	……	A381
EC(□)-HD	……	A382
EPCDS	……	A383
EPRI-C	……	A450
EPDS-SD	……	A378
EPAS-SD	……	A380
EC(□)-SD	……	A381
EC(□)-HD	……	A382
EPCDS	……	A383
EPRI-C	……	A450
EPDS-SD	……	A378
EPAS-SD	……	A380

超硬エンドミル形状別 選定目安表

超硬エンドミル

超硬エンドミル形状別 選定目安表

タイプ Type	商品コード Item Code	商品名称 Product	コーティング Coating	工具仕様 Specification	刃数 No. of flutes	外径 Tool Dia.
	EPDBEH-F-TH3 ※	エポックディープボールエボリューションハード-TH3 ショートシャンクタイプ Epoch Deep Ball Evolution Hard-TH3 -Short shank type	TH3	ロングネック Long neck	2	0.1~2.5
	EPDBEH-TH3 ※	エポックディープボールエボリューションハード-TH3 レギュラーシャンクタイプ Epoch Deep Ball Evolution Hard-TH3 -Regular shank type	TH3	ロングネック Long neck	2	0.1~12
	EPDBEH-TH3 ※	エポックディープボールエボリューションハード-TH3 ストロングネックタイプ Epoch Deep Ball Evolution Hard-TH3- Strong neck type	TH3	ストロングネック Strong neck	2	0.1~1
	EPDBE-ATH ※	エポックディープボールエボリューション(ATHコーティング) Epoch Deep Ball Evolution (ATH Coating)	ATH	ロングネック Long neck	2	0.1~ 6
	EPDBE-PN ※	エポックディープボールエボリューション(PNコーティング) Epoch Deep Ball Evolution (PN Coating)	PN	ロングネック Long neck	2	0.1~ 6
	EPDBPE-ATH ※	エポックペンシルディープボールエボリューション Epoch Pencil Deep Ball Evolution	ATH	ペンシルネック Pencil neck	2	0.2~12
	EPSBE-TH ※	エポックスーパーハードボールエボリューション 標準規格品 Epoch Super Hard Ball Evolution -Standard rating product	ATH	ロングネック Long neck	2	0.1~ 2
	EPSBE-H-TH ※	エポックスーパーハードボールエボリューション 高精度規格品 Epoch Super Hard Ball Evolution -High accuracy rating product	ATH	レギュラーネック Regular neck	2	0.1~ 2
	EPBTS-TH ※	エポックTHハードボールストロング Epoch TH Hard Ball Strong	ATH	レギュラー刃長 Regular	2	3 ~12
	EPBT ※	エポックTHハードボール Epoch TH Hard Ball	TH	レギュラー刃長 Regular	2	1 ~20
	HGOB-PN ※	エポックパナシアボール Epoch Panacea Ball	PN	レギュラー刃長 Regular	2	0.3~20
	HGOBLS-PN ※	エポックパナシアボール ロングシャンク Epoch Panacea Ball -Long shank	PN	ロングシャンク Long shank	2	6 ~20
	ESHB-H-TH ※	エポックシュリンクマスターボール 高精度規格品 Epoch Shrink Master Ball -High accuracy rating products	TH	レギュラー刃長 Regular	2	1 ~12
	ESHB-N-TH ※	エポックシュリンクマスターボール 標準規格品 Epoch Shrink Master Ball -Standard rating products	TH	レギュラー刃長 Regular	2	1 ~12
	EMBE-ATH ※	エポックメガフィードボール エボリューション ストレートタイプ Epoch Mega Feed Ball Evolution -Straight type	ATH	レギュラー刃長 Regular	3	1 ~20
	EMBPE-ATH ※	エポックメガフィードボール エボリューション ペンシルネック Epoch Mega Feed Ball Evolution -Pencil Neck	ATH	ペンシルネック Pencil neck	3	1 ~12
	EHHBE-TH3 ※	エポックハイハードボール-TH3 Epoch High Hard Ball-TH3	TH3	レギュラー刃長 Regular	4	1 ~12
	EHHB-ATH ※	エポックハイハードボール Epoch High Hard Ball	ATH	レギュラー刃長 Regular	4	1 ~12
	EPHB-PN	高能率仕上げ用6枚刃ボールエンドミル 6 Flutes Ball End Mill for High-efficiency Finishing	PN	レギュラー刃長 Regular	6	6 ~12
	EB4HR-ATH ※	エポックリブ溝加工用テーパボールエンドミル Taper Ball End Mill for High Accuracy Rib Slotting	ATH	レギュラー刃長 Regular	4	0.6~1.2
	ECRB-PN ※	エポックコンビネーションリブボール Epoch Combination Rib Ball	PN	レギュラー刃長 Regular	4	0.8・1
	EPDB-SD ※	エポックSD(S-DLC)ディープボール Epoch SD(S-DLC) Deep Ball	SD	ロングネック Long neck	2	0.2~ 5
	EPAB-SD ※	エポックSD(S-DLC)ボール Epoch SD(S-DLC) Ball	SD	レギュラー刃長 Regular	2	6 ~12
	EGDB-HD ※	エポックHDコーティング ディープボールエンドミル Epoch HD Coating Deep Ball End Mill	HD	ロングネック Long neck	2	0.4~ 3
	EGB-HD ※	エポックHDコーティング ボールエンドミル Epoch HD Coating Ball End Mill	HD	レギュラー刃長 Regular	2	4 ~10
	PCDB	多結晶焼結ダイヤモンドボールエンドミル Poly Crystalline Diamond Ball End Mill			—	0.4~ 1
	CBN-EHB ※	エポックCBNハイプレジションボールエンドミル Epoch CBN High Precision Ball End Mill		ロングネック Long neck	2	0.2~ 2



超硬ボールエンドミル
Carbide ball end mills

形状 Shape	対応被削材 Applicable work material					加工用途 Applications	掲載頁 Page	
	P	H	M	S	N		寸法表 Size list	切削条件 Cutting conditions
	炭素鋼・合金鋼 Carbon steels, Alloy steels	プリハードン鋼 Pre-hardened Steels	高硬度合金鋼 High-hardened over 55HRC	高硬度合金鋼 High-hardened over 55HRC	ステンレス鋼 Stainless steels			
	○	○	○	○	○	○	○	A56 A64
	○	○	○	○	○	○	○	A58 A64
	○	○	○	○	○	○	○	A63 A64
	○	○	○	○	○	○	○	A72 A78
	○	○	○	○	○	○	○	A75 A78
	○	○	○	○	○	○	○	A84 A89
	○	○	○	○	○	○	○	A97 A99
	○	○	○	○	○	○	○	A98 A99
	○	○	○	○	○	○	○	A100 A101
	○	○	○	○	○	○	○	A102 A103
	○	○	○	○	○	○	○	A104 A105
	○	○	○	○	○	○	○	A104 A107
	○	○	○	○	○	○	○	A108 A109
	○	○	○	○	○	○	○	A108 A109
	○	○	○	○	○	○	○	A110 A113
	○	○	○	○	○	○	○	A111 A116
	○	○	○	○	○	○	○	A124 A125
	○	○	○	○	○	○	○	A127 A128
	○	○	○	○	○	○	○	A130 A131
	○	○	○	○	○	○	○	A132 A134
	○	○	○	○	○	○	○	A137 A138
	○	○	○	○	○	○	○	A140 A141
	○	○	○	○	○	○	○	A142 A142
	グラファイト・FRP・高Siアルミニウム合金など for Graphite, FRP, High Si aluminum alloy, etc					○	○	A143 A144
	グラファイト・FRP・高Siアルミニウム合金など for Graphite, FRP, High Si aluminum alloy, etc					○	○	A145 A145
	○	○	○	○	○	○	○	A146
	○	○	○	○	○	○	○	A147 A148

超硬エンドミル形状別 選定目安表

超硬エンドミル

超硬エンドミル形状別 選定目安表

タイプ Type	商品コード Item Code	商品名称 Product	コーティング Coating	工具仕様 Specification	刃数 No. of flutes	外径 Tool Dia.
超硬ボールエンドミル Carbide ball end mills	CBN-EPSB ※	エポックCBNハスパーボールエンドミル Epoch CBN Super Ball End Mill		ロングネック Long neck	2	0.2~ 2
	EFB ※	エポックファインボール 一磨きレスー Epoch fine Ball -Migaki-	C	レギュラー刃長 Regular	2	1 ~12
	EPSB-H-TH ※	エポックスーパーハードボール 首下長1.5DCタイプ(高精度規格品) Epoch Super Hard Ball Under neck 1.5DC type (High-accuracy rating product)	TH	レギュラーネック Regular Neck	2	0.1~ 2
	EPSB-N-TH ※ 首下長 Under Neck Length 1.5DC	エポックスーパーハードボール 首下長1.5DCタイプ(標準規格品) Epoch Super Hard Ball Under neck 1.5DC type (Standard rating product)	TH	レギュラーネック Regular Neck	2	0.1~ 2
	EPSB-N-TH ※ 首下長 Under Neck Length 3DC	エポックスーパーハードボール 首下長3DCタイプ(標準規格品) Epoch Super Hard Ball Under neck 3DC type (Standard rating product)	TH	ロングネック Long Neck	2	0.1~ 2
	HPBS-C ※	エポック精密小径エンドミル ショートネック・ボール Epoch Precision Miniature Ball End Mill -Short Neck	C	ショートネック Short Neck	2	1 ~ 6
	HYPB-C ※	エポック精密小径エンドミル レギュラーネック・ボール Epoch Precision Miniature Ball End Mill -Regular Neck, Regular	C	レギュラーネック Regular Neck	2	0.2~ 6
	HPBLN-C ※	エポック精密小径エンドミル ロングネック・ボール Epoch Precision Miniature Ball End Mill -Long Neck	C	ロングネック Long Neck	2	0.5~ 6
	EPBPN ※	エポックペンシルネックボール Epoch Pencil Neck Ball	C	ペンシルネック Pencil neck	2	1 ~12
	EPBPX ※	エポックペンシルロングネックボール Epoch Pencil Long Neck Ball	C	ペンシルネック Pencil neck	2	1 ~12
	BEK	超硬強力形ボールエンドミル Carbide Ball End Mills		ショート刃長 Short	2	0.3~20
	EPDBP-TH ※	エポックペンシルディープボール Epoch Pencil Deep Ball	TH	ペンシルネック Pencil neck	2	0.2~10
	EMB-TH ※	エポックメガフィードボール 首下ストレート Epoch Mega Feed Ball -Straight Neck	TH	レギュラー刃長 Regular	3	2 ~20
	EMBP-TH ※	エポックメガフィードボール ペンシルネック Epoch Mega Feed Ball -Pencil Neck	TH	ペンシルネック Pencil neck	3	4 ~10
	超硬ラジラスエンドミル Carbide radius end mills	EPDREH2-TH3 ※	エポックディーブラジラスエボリューションハード-TH3 2枚刃 Epoch Deep Radius Evolution Hard-TH3 2 Flutes	TH3	ロングネック Long neck	2
EPDREH4-TH3 ※		エポックディーブラジラスエボリューションハード-TH3 4枚刃 Epoch Deep Radius Evolution Hard-TH3 4 Flutes	TH3	ロングネック Long neck	4	1 ~ 6
EPDRE-ATH ※		エポックディーブラジラスエボリューション Epoch Deep Radius Evolution	ATH	ロングネック Long neck	2	0.2~ 6
EPDRP-TH ※		エポックペンシルディープラジラス Epoch Pencil Deep Radius	TH	ペンシルネック Pencil neck	2	0.2~ 3
EPDRF-TH ※		エポックディーブラジラスF Epoch Deep Radius F	TH	ロングネック Long neck	4	1 ~ 6
ETR-TH ※		エポックターボリブ 首下ストレート Epoch Turbo Rib -Straight Neck	TH	ロングネック Long neck	4	1 ~ 3
ETRP-TH ※		エポックターボリブ ペンシルネック Epoch Turbo Rib -Pencil Neck	TH	ペンシルネック Pencil neck	4	1 ~ 3
ETM-TH ※		エポックターボミル 首下ストレート・コーナR付き Epoch Turbo Mill -Straigh Neck, Corner Radius	TH	レギュラー刃長 Regular	4	2 ~20
ETMLN-TH ※		エポックターボミル ロングネック・コーナR付き Epoch Turbo Mill -Long Neck, Corner Radius	TH	ロングネック Long Neck	4	4 ~16
ETMP-TH ※		エポックターボミル ペンシルネック・コーナR付き Epoch Turbo Mill -Pencil Neck, Corner Radius	TH	ペンシルネック Pencil Neck	4	2 ~16
HGOF2-TH ※		エポックGターボ 2枚刃 Epoch G Turbo -2 flutes	ATH	レギュラー刃長 Regular	2	2 ~12
HGOF4-TH ※		エポックGターボ 4枚刃 Epoch G Turbo -4 flutes	ATH	レギュラー刃長 Regular	4	2 ~12
EPSM-CR-PN ※		エポックSUSマルチ レギュラー刃・コーナR付き Epoch SUS Multi -Regular, Corner Radius	PN	レギュラー刃長 Regular	4	1 ~20

※:エポックエンドミルです。Epoch End Mill

形状 Shape	対応被削材 Applicable work material					加工用途 Applications	掲載頁 Page					
	P 炭素鋼・合金鋼 Carbon steels, Alloy steels	H プリハードン鋼45以下 Pre-hardened Steels under 45 HRC	H 高硬度45HRC以上55HRC以下 High-hardened over 45HRC to under 55HRC	M 高硬度55HRC超え High-hardened over 55HRC	S ステンレス鋼 Stainless steels		N チタン合金・耐熱合金 Titanium alloy, Heat-resistant alloy	銅合金 Copper alloy	アルミ合金 Aluminum alloy	寸法表 Size list	切削条件 Cutting conditions	
			○	○	○						A151	A152
	○	○	○	○	○	○	○	○			A153	A153
		○	○	○	○	○	○	○			A154	A155
		○	○	○	○	○	○	○			A154	A155
		○	○	○	○	○	○	○			A155	A155
	○	○	○	○	○	○	○	○			A156	A157
	○	○	○	○	○	○	○	○			A156	A157
	○	○	○	○	○	○	○	○			A157	A157
	○	○	○	○	○	○	○	○			A158	A159
	○	○	○	○	○	○	○	○			A160	A161
	○	○	○	○	○	○	○	○			A161	
	○	○	○	○	○	○	○	○			A162	A165
	○	○	○	○	○	○	○	○			A168	A169
	○	○	○	○	○	○	○	○			A170	A171
	○	○	○	○	○	○	○	○			A172	A180
	○	○	○	○	○	○	○	○			A174	A184
	○	○	○	○	○	○	○	○			A194	A200
	○	○	○	○	○	○	○	○			A210	A212
	○	○	○	○	○	○	○	○			A216	A219
	○	○	○	○	○	○	○	○			A222	A224
	○	○	○	○	○	○	○	○			A223	A225
	○	○	○	○	○	○	○	○			A226	A228
	○	○	○	○	○	○	○	○			A226	A228
	○	○	○	○	○	○	○	○			A227	A228
	○	○	○	○	○	○	○	○			A232	A233
	○	○	○	○	○	○	○	○			A232	A234
	○	○	○	○	○	○	○	○			A235	A240

超硬エンドミル形状別 選定目安表

超硬エンドミル

超硬エンドミル形状別 選定目安表

タイプ Type	商品コード Item Code	商品名称 Product	コーティング Coating	工具仕様 Specification	刃数 No. of flutes	外径 Tool Dia.
	EPSML-CR-PN ※	エポックSUSマルチ ロング刃・コーナR付き Epoch SUS Multi -Long, Corner Radius	PN	ロング刃長 Long	4	6 ~20
	EPSM-5DC-CR-PN ※	エポックSUSマルチ 首下5DC・コーナR付き Epoch SUS Multi -Under neck 5DC, Corner Radius	PN	ロングネック Long Neck	4	1 ~20
	EPP-CR-TH ※	エポックTHパワーミル コーナR付き Epoch TH Power Mill -Corner Radius	TH	レギュラー刃長 Regular	4	3 ~20
	EPP-CR ※	エポックパワーミル レギュラー刃・コーナR付き Epoch Power Mill -Regular, Corner Radius	C	レギュラー刃長 Regular	4	3 ~25
	EPPL-CR ※	エポックパワーミル ロング刃・コーナR付き Epoch Power Mill -Long, Corner Radius	C	ロング刃長 Long	4	6 ~25
	EPPLS-CR ※	エポックパワーミル ロングシャンク・コーナR付き Epoch Power Mill -Long Shank, Corner Radius	C	ロングシャンク Long Shank	4	3 ~17
	ER8WB-ATH	立壁/底面仕上げ用8枚刃エンドミル ラジアス 8-flutes End Mill for Vertical Wall/Bottom Face Finishing -Radius	ATH		8	6 ~12
	ER5HS-3.5DC-PN	高能率側面切削用エンドミル 首下3.5DC End mill for adaptive milling -Under neck 3.5DC	PN		5	6 ~20
	ER5HS-5DC-PN	高能率側面切削用エンドミル 首下5DC End mill for adaptive milling -Under neck 5DC	PN		5	6 ~20
	EMXR-3DC-TH ※	エポックミルス タイプR 4枚刃・ラジアス・ストレート・3DC Epoch Mirus Type R -4flutes, Radius, Straight, 3DC	ATH	ロングネック Long Neck	4	6 ~12
	EMXR-5DC-TH ※	エポックミルス タイプR 4枚刃・ラジアス・ストレート・5DC Epoch Mirus Type R -4flutes, Radius, Straight, 5DC	ATH	ロングネック Long Neck	4	6 ~12
	EMXN-3DC-TH ※	エポックミルス タイプN 4枚刃・ラジアス・ストレート・3DC Epoch Mirus Type N -4flutes, Radius, Straight, 3DC	ATH	ロングネック Long Neck	4	6 ~12
	EMXN-5DC-TH ※	エポックミルス タイプN 4枚刃・ラジアス・ストレート・5DC Epoch Mirus Type N -4flutes, Radius, Straight, 5DC	ATH	ロングネック Long Neck	4	6 ~12
	EHHRE-TH3 ※	エポックハイハードラジアス Epoch High Hard Radius	TH3	レギュラー刃長 Regular	4,6	1 ~12
	CEPR-CR-TH ※	エポックTHハード レギュラー刃長・コーナR付き Epoch TH Hard -Regular, Corner Radius	TH	レギュラー刃長 Regular	6	6 ~20
	CEPR-CR ※	エポック21 レギュラー刃・コーナR付き Epoch21 -Regular, Corner Radius	C	レギュラー刃長 Regular	6,8	6 ~30
	EAP4-CR-TH ※	エポックエアロパワーミル 4枚刃 コーナR付き Epoch Aero Power Mill -4 flutes, Corner Radius	TH	レギュラー刃長 Regular	4	6 ~20
	EAP6-CR-TH ※	エポックエアロパワーミル 6枚刃 コーナR付き Epoch Aero Power Mill -6 flutes, Corner Radius	TH	レギュラー刃長 Regular	6	6 ~20
	EMXA2 ※	エポックミルス タイプA 2枚刃 Epoch Mirus Type A -2 flutes		レギュラー刃長 Regular	2	10 ~25
	EMXA3 ※	エポックミルス タイプA 3枚刃 Epoch Mirus Type A -3 flutes		レギュラー刃長 Regular	3	3 ~16
		多刃テーパラジアスエンドミル Multi Flutes Taper Radius End Mill	PN	レギュラー刃長 Regular	9,12	11 ~19
	EGDR-HD ※	エポックHDコーティング ディープラジアスエンドミル Epoch HD Coating Deep Radius End Mill	HD	ロングネック Long neck	2	0.5~ 3
	EGR-HD ※	エポックHDコーティング ラジアスエンドミル Epoch HD Coating Radius End Mill	HD	レギュラー刃長 Regular	2	4 ~10
	SCE	セラミックエンドミル コーナRタイプ Ceramic End Mill Corner Radius Type		レギュラー刃長 Regular	6	6 ~12
	CBN-EPSR ※	エポックCBNスーパーラジアスエンドミル Epoch CBN Super Radius End Mill		ロングネック Long neck	2	0.2~ 3
	EPDR-TH ※	エポックディープラジアス Epoch Deep Radius	TH	ロングネック Long neck	2	0.2~ 3

超硬ラジアスエンドミル
Carbide radius end mills

※:エポックエンドミルです。Epoch End Mill

形状 Shape	対応被削材 Applicable work material						加工用途 Applications	掲載頁 Page											
	P 炭素鋼・合金鋼 Carbon steels, Alloy steels	H プリハードン鋼以下 High-hardened steels under 45 HRC	H 高硬度合金鋼 High-hardened over 45HRC to under 55HRC	H 高硬度合金鋼 High-hardened over 55HRC to under 65HRC	M ステンレス鋼 Stainless steels	S チタン合金・耐熱合金 Titanium alloy, Heat-resistant alloy		N 銅合金 Copper alloy	N アルミ合金 Aluminum alloy	寸法表 Size list	切削条件 Cutting conditions								
	○	○			○	○	○	○	側面 Side Cutting	曲面 Profiling	R Radius	A237	A246						
	○	○			○	○	○	○	平面 Planing	側面 Side Cutting	溝 Slotting	影込み Die-sinking	曲面 Profiling	R Radius	ヘリカル Helical	A238	A243		
	○	○	○	○	○	○	○	○	平面 Planing	側面 Side Cutting	溝 Slotting	影込み Die-sinking	曲面 Profiling	R Radius	ヘリカル Helical	A247	A248		
	○	○	○	○	○	○			平面 Planing	側面 Side Cutting	溝 Slotting	影込み Die-sinking	曲面 Profiling	R Radius	ヘリカル Helical	A249	A251		
	○	○	○	○	○	○			側面 Side Cutting	曲面 Profiling	R Radius					A249	A253		
	○	○	○	○	○	○			側面 Side Cutting	曲面 Profiling	R Radius					A250	A253		
	○	○	○						平面 Planing	側面 Side Cutting	溝 Slotting	影込み Die-sinking	曲面 Profiling			A254	A255		
	○	○			○	○			側面 Side Cutting	平面 Planing	側面 Side Cutting	曲面 Profiling	ヘリカル Helical			A257	A258		
	○	○			○	○			側面 Side Cutting	平面 Planing	側面 Side Cutting	曲面 Profiling	ヘリカル Helical			A257	A258		
	○	○	○				○	○	平面 Planing	側面 Side Cutting	溝 Slotting	影込み Die-sinking	曲面 Profiling	R Radius	ヘリカル Helical	座ぐり Spot facing	取りのし Retracting	A259	A261
	○	○	○				○	○	平面 Planing	側面 Side Cutting	溝 Slotting	影込み Die-sinking	曲面 Profiling	R Radius	ヘリカル Helical	座ぐり Spot facing	取りのし Retracting	A259	A262
	○	○	○				○	○	平面 Planing	側面 Side Cutting	溝 Slotting	影込み Die-sinking	曲面 Profiling	R Radius	ヘリカル Helical	座ぐり Spot facing	取りのし Retracting	A260	A261
	○	○	○				○	○	平面 Planing	側面 Side Cutting	溝 Slotting	影込み Die-sinking	曲面 Profiling	R Radius	ヘリカル Helical	座ぐり Spot facing	取りのし Retracting	A260	A262
			○	○	○				影込み Die-sinking	曲面 Profiling	R Radius						A263	A264	
	○	○	○	○	○	○			側面 Side Cutting	側面 Side Cutting	溝 Slotting	影込み Die-sinking	曲面 Profiling	R Radius			A265	A266	
	○	○	○	○	○	○			側面 Side Cutting	側面 Side Cutting	溝 Slotting	影込み Die-sinking	曲面 Profiling	R Radius			A267	A268	
					○	○	○	○	平面 Planing	側面 Side Cutting	溝 Slotting	影込み Die-sinking	曲面 Profiling	R Radius	ヘリカル Helical	座ぐり Spot facing		A269	A270
					○	○	○	○	側面 Side Cutting	曲面 Profiling	R Radius						A269	A271	
							○	○	平面 Planing	側面 Side Cutting	溝 Slotting	影込み Die-sinking	ヘリカル Helical	座ぐり Spot facing			A272	A274	
							○	○	平面 Planing	側面 Side Cutting	溝 Slotting	影込み Die-sinking	ヘリカル Helical	座ぐり Spot facing			A272	A274	
					○	○			平面 Planing	側面 Side Cutting	曲面 Profiling						A276	A276	
	グラファイト・FRP・高Siアルミニウム合金など for Graphite, FRP, High Si aluminium alloy, etc									溝 Slotting	影込み Die-sinking	曲面 Profiling	R Radius	細部 Miniature	取りのし Retracting	A277	A278		
	グラファイト・FRP・高Siアルミニウム合金など for Graphite, FRP, High Si aluminium alloy, etc									平面 Planing	側面 Side Cutting	溝 Slotting	影込み Die-sinking	曲面 Profiling	R Radius	ヘリカル Helical		A279	A279
					○				平面 Planing	側面 Side Cutting							A280	A280	
			○	○	○				平面 Planing	影込み Die-sinking	R Radius	取りのし Retracting	細部 Miniature				A281	A282	
	○	○	○	○	○	○	○	○	溝 Slotting	影込み Die-sinking	曲面 Profiling	R Radius	細部 Miniature	取りのし Retracting			A283	A286	

超硬エンドミル形状別 選定目安表

超硬エンドミル形状別 選定目安表

タイプ Type	商品コード Item Code	商品名称 Product	コーティング Coating	工具仕様 Specification	刃数 No. of flutes	外径 Tool Dia.
超硬スクエアエンドミル Carbide square end mills	EPDSE-ATH	※ エポックディープスクエアエボリューション(ATHコーティング) Epoch Deep Square Evolution (ATH Coating)	ATH	ロングネック Long neck	2	0.1~ 6
	EPDSE-PN	※ エポックディープスクエアエボリューション(PNコーティング) Epoch Deep Square Evolution (PN Coating)	PN	ロングネック Long neck	2	0.1~ 6
	HGOS2-PN	※ エポックパナシアスクエア 2枚刃 Epoch Panacea Square -2 flutes	PN	レギュラー刃長 Regular	2	0.2~20
	HGOS4-PN	※ エポックパナシアスクエア 4枚刃 Epoch Panacea Square -4 flutes	PN	レギュラー刃長 Regular	4	1 ~20
	EPP3-CS	※ エポックCSパワーミル 3枚刃 Epoch CS Power Mill -3Flutes	CS	レギュラー刃長 Regular	3	2 ~25
	EPSF-PN	※ エポックSUSフィニッシュ レギュラー刃 Epoch SUS Finish -Regular	PN	レギュラー刃長 Regular	4	3 ~12
	EPSFM-PN	※ エポックSUSフィニッシュ ミディアム刃 Epoch SUS Finish -Medium	PN	ミディアム刃長 Medium	4	3 ~12
	EPSFL-PN	※ エポックSUSフィニッシュ ロング刃 Epoch SUS Finish -Long	PN	ロング刃長 Long	4	3 ~12
	EPSMS-PN	※ エポックSUSマルチ ショート刃 Epoch SUS Multi -Short	PN	ショート刃長 Short	4	1 ~20
	EPSM-PN	※ エポックSUSマルチ レギュラー刃 Epoch SUS Multi -Regular	PN	レギュラー刃長 Regular	4	1 ~20
	EPSMM-PN	※ エポックSUSマルチ ミディアム刃 Epoch SUS Multi -Medium	PN	ミディアム刃長 Long	4	3 ~20
	EPSML-PN	※ エポックSUSマルチ ロング刃 Epoch SUS Multi -Long	PN	ロング刃長 Long	4	6 ~20
	EPSMLS-PN	※ エポックSUSマルチ ロングシャンク Epoch SUS Multi -Long shank	PN	ロングシャンク Long Shank	4	3 ~17
	EPSM-3DC-PN	※ エポックSUSマルチ 首下3DC Epoch SUS Multi -Under neck 3DC	PN	ロングネック Long Neck	4	1 ~20
	EPSM-5DC-PN	※ エポックSUSマルチ 首下5DC Epoch SUS Multi -Under neck 5DC	PN	ロングネック Long Neck	4	1 ~20
	EPPS-TH	※ エポックTHパワーミル ショート刃 Epoch TH Power Mill -Short	TH	ショート刃長 Short	4	3 ~20
	EPP-TH	※ エポックTHパワーミル レギュラー刃 Epoch TH Power Mill -Regular	TH	レギュラー刃長 Regular	4	3 ~20
	EPPM-TH	※ エポックTHパワーミル ミディアム刃 Epoch TH Power Mill -Medium	TH	ミディアム刃長 Medium	4	3 ~20
	EPPL-TH	※ エポックTHパワーミル ロング刃 Epoch TH Power Mill -Long	TH	ロング刃長 Long	4	6 ~20
	EPP4-CS	※ エポックCSパワーミル レギュラー刃 Epoch CS Power Mill -Regular	CS	レギュラー刃長 Regular	4	3 ~20
	EPPS-P-CS	※ エポックCSパワーミル"ピンカド" ショート刃 Epoch CS Power Mill "PINKADO" -Short	CS	ショート刃長 Short	4	1 ~12
	EPP-P-CS	※ エポックCSパワーミル"ピンカド" レギュラー刃 Epoch CS Power Mill "PINKADO" -Regular	CS	レギュラー刃長 Regular	4	1 ~20
	EPPS	※ エポックパワーミル ショート刃 Epoch Power Mill -Short	C	ショート刃長 Short	4	2 ~25
	EPP	※ エポックパワーミル レギュラー刃 Epoch Power Mill -Regular	C	レギュラー刃長 Regular	4	2 ~25
	EPPM	※ エポックパワーミル ミディアム刃 Epoch Power Mill -Medium	C	ミディアム刃長 Medium	4	3 ~20
	EPPL	※ エポックパワーミル ロング刃 Epoch Power Mill -Long	C	ロング刃長 Long	4	3 ~20
	EPPLS	※ エポックパワーミル ロングシャンク Epoch Power Mill -Long Shank	C	ロングシャンク Long Shank	4	3 ~20

※:エポックエンドミルです。Epoch End Mill

形状 Shape	対応被削材 Applicable work material						加工用途 Applications	掲載頁 Page									
	P	H			M	S		N	寸法表 Size list	切削条件 Cutting conditions							
	炭素鋼・合金鋼 Carbon steels, Alloy steels	プリハートン鋼45以下 Pre-hardened Steels under 45 HRC	高硬度45HRC超え55以下 High-hardened over 45HRC to under 55HRC	高硬度55HRC超え65以下 High-hardened over 55HRC to under 65HRC	高硬度65HRC超え High-hardened over 65HRC	ステンレス鋼 Stainless steels		チタン合金・耐熱合金 Titanium alloy, Heat-resistant alloy			銅合金 Copper alloy	アルミ合金 Aluminum alloy					
	○	○	○	○	○	○	○	○	○	側面 Side Cutting	溝 Slotting	細部 Miniature	A292	A298			
	○	○	○	○	○	○	○	○	○	側面 Side Cutting	溝 Slotting	細部 Miniature	A295	A298			
	○	○	○	○	○	○	○	○	○	平面 Planing	側面 Side Cutting	溝 Slotting	影込み Die-sinking	ヘリカル Helical	座ぐり Spot facing	A304	A306
	○	○	○	○	○	○	○	○	○	平面 Planing	側面 Side Cutting	影込み Die-sinking	ヘリカル Helical	座ぐり Spot facing	A305	A306	
	○	○	○	○	○	○	○	○	○	平面 Planing	側面 Side Cutting	溝 Slotting	影込み Die-sinking	ヘリカル Helical	座ぐり Spot facing	A308	A309
	○	○	○	○	○	○	○	○	○	平面 Planing	側面 Side Cutting	溝 Slotting	ヘリカル Helical	座ぐり Spot facing	A310	A325	
	○	○	○	○	○	○	○	○	○	側面 Side Cutting						A310	A327
	○	○	○	○	○	○	○	○	○	側面 Side Cutting						A310	A327
	○	○	○	○	○	○	○	○	○	平面 Planing	側面 Side Cutting	溝 Slotting	ヘリカル Helical	座ぐり Spot facing	A311	A319	
	○	○	○	○	○	○	○	○	○	平面 Planing	側面 Side Cutting	溝 Slotting	ヘリカル Helical	座ぐり Spot facing	A313	A319	
	○	○	○	○	○	○	○	○	○	側面 Side Cutting						A315	A324
	○	○	○	○	○	○	○	○	○	側面 Side Cutting						A315	A324
	○	○	○	○	○	○	○	○	○	側面 Side Cutting						A316	A322
	○	○	○	○	○	○	○	○	○	平面 Planing	側面 Side Cutting	溝 Slotting	ヘリカル Helical	座ぐり Spot facing	A317	A319	
	○	○	○	○	○	○	○	○	○	平面 Planing	側面 Side Cutting	溝 Slotting	ヘリカル Helical	座ぐり Spot facing	A318	A322	
	○	○	○	○	○	○	○	○	○	平面 Planing	側面 Side Cutting	溝 Slotting				A328	A329
	○	○	○	○	○	○	○	○	○	平面 Planing	側面 Side Cutting	溝 Slotting				A328	A330
	○	○	○	○	○	○	○	○	○	側面 Side Cutting						A328	A331
	○	○	○	○	○	○	○	○	○	側面 Side Cutting						A328	A331
	○	○	○	○	○	○	○	○	○	平面 Planing	側面 Side Cutting	溝 Slotting				A332	A333
	○	○	○	○	○	○	○	○	○	平面 Planing	側面 Side Cutting	溝 Slotting				A332	A335
	○	○	○	○	○	○	○	○	○	平面 Planing	側面 Side Cutting	溝 Slotting				A332	A335
	○	○	○	○	○	○	○	○	○	平面 Planing	側面 Side Cutting	溝 Slotting				A336	A339
	○	○	○	○	○	○	○	○	○	平面 Planing	側面 Side Cutting	溝 Slotting				A337	A341
	○	○	○	○	○	○	○	○	○	側面 Side Cutting						A338	A343
	○	○	○	○	○	○	○	○	○	側面 Side Cutting						A338	A343
	○	○	○	○	○	○	○	○	○	側面 Side Cutting						A338	A343

超硬エンドミル形状別 選定目安表

超硬エンドミル形状別 選定目安表

タイプ Type	商品コード Item Code	商品名称 Product	コーティング Coating	工具仕様 Specification	刃数 No. of flutes	外径 Tool Dia.
	ES8WB-ATH	立壁/底面仕上げ用8枚刃エンドミル スクエア 8-flutes End Mill for Vertical Wall/Bottom Face Finishing -Square	ATH		8	6 ~12
	EMXR-TH ※	エポックミルス タイプR 4枚刃・スクエア・ストレート Epoch Mirus Type R -4flutes, Square, Straight	ATH	レギュラー刃長 Regular	4	6 ~20
	EMXR-SR-TH ※	エポックミルス タイプR 4枚刃・スクエア・セミロングシャンク Epoch Mirus Type R -4flutes, Square, Semi long shank	ATH	セミロングシャンク Semi Long Shank	4	7 ~13
	EMXN-TH ※	エポックミルス タイプN 4枚刃・スクエア・ストレート Epoch Mirus Type N -4flutes, Square, Straight	ATH	レギュラー刃長 Regular	4	6 ~20
	EMXN-SR-TH ※	エポックミルス タイプN 4枚刃・スクエア・セミロングシャンク Epoch Mirus Type N -4flutes, Square, Semi long shank	ATH	セミロングシャンク Semi Long Shank	4	7 ~13
	CEPS-TH ※	エポックTHハード ショート刃 Epoch TH Hard -Short	TH	ショート刃長 Short	4,6	1 ~ 6
	CEPR-TH ※	エポックTHハード レギュラー刃 Epoch TH Hard -Regular	TH	レギュラー刃長 Regular	4,6,8	1 ~32
	CEPL-TH ※	エポックTHハード ロング刃 Epoch TH Hard -Long	TH	ロング刃長 Long	4,6,8	3 ~25
	CEPR ※	エポック21 レギュラー刃 Epoch21 -Regular	C	レギュラー刃長 Regular	4,6,8	1 ~32
	CEPL ※	エポック21 ロング刃 Epoch21 -Long	C	ロング刃長 Long	4,6,8	3 ~32
	CEPLS ※	エポック21 ロングシャンク Epoch21 -Long Shank	C	ロングシャンク Long Shank	6,8	6 ~32
	CEPH ※	エポックハード Epoch Hard	C	レギュラー刃長 Regular	4,6	3 ~20
	CEPU ※	エポックユニバーサル Epoch Universal	C	レギュラー刃長 Regular	4	4 ~20
	EPSW-PN ※	エポックSUSウェーブ レギュラー刃 Epoch SUS Wave -Regular	PN	レギュラー刃長 Regular	3,4	4 ~20
	EPSWL-PN ※	エポックSUSウェーブ ロング刃 Epoch SUS Wave -Long	PN	ロング刃長 Long	4	6 ~20
	EPSW-3DC-PN ※	エポックSUSウェーブ 首下3DC Epoch SUS Wave -Under neck 3DC	PN	ロングネック Long Neck	3,4	4 ~20
	EPSW-5DC-PN ※	エポックSUSウェーブ 首下5DC Epoch SUS Wave -Under neck 5DC	PN	ロングネック Long Neck	3,4	4 ~20
	EPQR-CS ※	エポックラフィング レギュラー刃 Epoch Roughing -Regular	CS	レギュラー刃長 Regular	4	6 ~20
	EPQL-CS ※	エポックラフィング ロング刃 Epoch Roughing -Long	CS	ロング刃長 Long	4	6 ~20
	EAP4-TH ※	エポックエアロパワーミル 4枚刃 Epoch Aero Power Mill -4 flutes	TH	レギュラー刃長 Regular	4	6 ~20
	EAP6-TH ※	エポックエアロパワーミル 6枚刃 Epoch Aero Power Mill -6 flutes	TH	レギュラー刃長 Regular	6	6 ~20
	EMXA3 ※	エポックミルス タイプA 3枚刃(メーカー在庫品) Epoch Mirus Type A -3 flutes (Manufacture stocked products)		レギュラー刃長 Regular	3	3 ~16
	EMXA2 ※	エポックミルス タイプA 2枚刃(セミオーダー品) Epoch Mirus Type A -2 flutes (Semi-order products)	受注生産 Order Made	レギュラー刃長 Regular	2	10~25
	EMXA3 ※	エポックミルス タイプA 3枚刃(セミオーダー品) Epoch Mirus Type A -3 flutes (Semi-order products)	受注生産 Order Made	レギュラー刃長 Regular	3	3 ~16
	EPDS-SD ※	エポックSD(S-DLC)ディープスクエア Epoch SD(S-DLC) Deep Square	SD	ロングネック Long neck	2	0.5~ 4
	EPAS-SD ※	エポックSD(S-DLC)スクエア Epoch SD(S-DLC) Square	SD	レギュラー刃長 Regular	2	3 ~12
	ECH-SD ※	エポックCFRPエンドミル タイプH Epoch CFRP End Mill Type H	SD	レギュラー刃長 Regular	4	6 ~12

超硬スクエアエンドミル
Carbide square end mills

※:エポックエンドミルです。Epoch End Mill

形状 Shape	対応被削材 Applicable work material					加工用途 Applications	掲載頁 Page					
	P 炭素鋼・合金鋼 Carbon steels, Alloy steels	H 高硬度45HRC以下 High-hardened over 45HRC to under 55HRC	H 高硬度55HRC以下 High-hardened over 55HRC to under 65HRC	M ステンレス鋼 Stainless steels	S チタン合金・耐熱合金 Titanium alloy, Heat-resistant alloy		N 銅合金 Copper alloy	N アルミ合金 Aluminum alloy	寸法表 Size list	切削条件 Cutting conditions		
	○	◎	◎							A344	A345	
	◎	◎	○				○	○		A346	A348	
	◎	◎	○				○	○		A346	A349	
	◎	◎	○				○	○		A347	A348	
	◎	◎	○				○	○		A347	A349	
	◎	◎	◎	○	○					A352	A353	
	◎	◎	◎	○	○					A352	A353	
	◎	◎	◎	○	○					A352	A354	
	◎	◎	○	○	○					A355	A357	
	◎	◎	○	○	○					A355	A358	
	◎	◎	○	○	○					A356	A358	
	◎	◎	○	○	○					A356	A359	
	◎	◎	○	○	○					A356	A360	
	◎	◎			◎	◎	◎	◎		A361	A364	
	◎	◎			◎	◎	◎	◎		A362	A368	
	◎	◎			◎	◎	◎	◎		A363	A364	
	◎	◎			◎	◎	◎	◎		A363	A366	
	◎	◎	○		◎	◎	◎	◎		A369	A370	
	◎	◎	○		◎	◎	◎	◎		A369	A370	
	○				◎	◎				A371	A372	
	○				◎	◎				A371	A373	
						◎	◎			A374	A376	
						◎	◎			A375	A376	
						◎	◎			A375	A376	
						◎	◎			A378	A379	
						◎	◎			A380	A380	
						◎	◎			A381	A381	
	CFRP,GFRP等 CFRP and GFRP, etc										A381	A381

Carbide End Mills

Selection criteria table according to carbide end mill shape















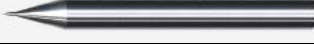

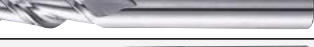

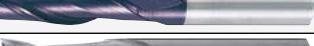

超硬エンドミル形状別 選定目安表

超硬エンドミル

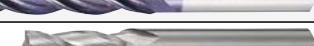
超硬エンドミル形状別 選定目安表

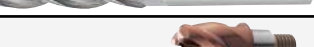
タイプ Type	商品コード Item Code	商品名称 Product	コーティング Coating	工具仕様 Specification	刃数 No. of flutes	外径 Tool Dia.
超硬スクエアエンドミル Carbide square end mills	ECX-SD ※	エポックCFRPエンドミル タイプX Epoch CFRP End Mill Type X		レギュラー刃長 Regular	3	6 ~12
	ECN-HD ※	エポックCFRPトリムカッタ タイプN Epoch CFRP Trim Cutter Type N		レギュラー刃長 Regular	—	6 ~12
	ECW-HD ※	エポックCFRPトリムカッタ タイプW Epoch CFRP Trim Cutter Type W		レギュラー刃長 Regular	—	6 ~12
	EPCDS ※	エポックシャイニングスクエア Epoch Shining Square		レギュラー刃長 Regular	4,6	0.1~ 1
	EMM ※	エポックマイクロエンドミル Epoch Micro End Mill			2	0.03~0.5
	EMM-TH ※	エポックマイクロエンドミル(THコーティング) Epoch Micro End Mill (TH Coating)			2	0.03~0.5
	HYPS-C ※	エポック精密小径エンドミル レギュラーネック Epoch Precision Miniature End Mill -Regular Neck		レギュラーネック Regular Neck	2	0.2~ 6
	HPSLN-C ※	エポック精密小径エンドミル ロングネック Epoch Precision Miniature End Mill -Long Neck		ロングネック Long Neck	2	0.5~ 6
	AES	超硬アルミ用エンドミル Carbide End Mills for Aluminium		レギュラー刃長 Regular	2	1 ~20
	HES2-C	超硬Cコートエンドミル 2枚刃 レギュラー刃 C Coating Carbide End Mills -2 Flutes, Regular		レギュラー刃長 Regular	2	0.1~30
	HESM2-C	超硬Cコートエンドミル 2枚刃 ミディアム刃 C Coating Carbide End Mills -2 Flutes, Medium		ミディアム刃長 Medium	2	3 ~25
	HESL2-C	超硬Cコートエンドミル 2枚刃 ロング刃 C Coating Carbide End Mills -2 Flutes, Long		ロング刃長 Long	2	1 ~25
	HES2	超硬エンドミル 2枚刃 レギュラー刃 Carbide End Mills -2 Flutes, Regular		レギュラー刃長 Regular	2	0.1~30
	HESM2	超硬エンドミル 2枚刃 ミディアム刃 Carbide End Mills -2 Flutes, Medium		ミディアム刃長 Medium	2	3 ~30
	HESL2	超硬エンドミル 2枚刃 ロング刃 Carbide End Mills -2 Flutes, Long		ロング刃長 Long	2	1 ~25
	HES4-C	超硬Cコートエンドミル 4枚刃 レギュラー刃 C Coating Carbide End Mills -4 Flutes, Regular		レギュラー刃長 Regular	4	2 ~30
	HESM4-C	超硬Cコートエンドミル 4枚刃 ミディアム刃 C Coating Carbide End Mills -4 Flutes, Medium		ミディアム刃長 Medium	4	3 ~30
	HESL4-C	超硬Cコートエンドミル 4枚刃 ロング刃 C Coating Carbide End Mills -4 Flutes, Long		ロング刃長 Long	4	3 ~25
	HES4	超硬エンドミル 4枚刃 レギュラー刃 Carbide End Mills -4 Flutes, Regular		レギュラー刃長 Regular	4	2 ~30
	HESM4	超硬エンドミル 4枚刃 ミディアム刃 Carbide End Mills -4 Flutes, Medium		ミディアム刃長 Medium	4	3 ~30
HESL4	超硬エンドミル 4枚刃 ロング刃 Carbide End Mills -4 Flutes, Long		ロング刃長 Long	4	3 ~25	
ヘッド交換式エンドミル Exchangeable Head End Mill	EHX-ETM-TH	EHXエンドミル(刃先形状:エポックターボミル) EHX End Mill (Head type : Epoch Turbo Mill)		レギュラー刃長 Regular	4	12~20
	EHX-H-ETM-TH	EHXエンドミル(刃先形状:エポックターボミル) オイルホール付き EHX End Mill (Head type : Epoch Turbo Mill) with oil hole		レギュラー刃長 Regular	4	12~20
	EHX-CEPR-TH	EHXエンドミル(刃先形状:エポック21) EHX End Mill (Head type : Epoch21)		レギュラー刃長 Regular	6	12~20
	EHX-EPP-TH	EHXエンドミル(刃先形状:エポックパワーミル) EHX End Mill (Head type : Epoch Power Mill)		レギュラー刃長 Regular	4	12~20
	EHX-ASC	EHXエンドミル用超硬ホルダ Carbide Holder for EHX End Mill				

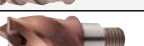
※:エポックエンドミルです。Epoch End Mill

形状 Shape	対応被削材 Applicable work material					加工用途 Applications	掲載頁 Page				
	P 炭素鋼・合金鋼 Carbon steels, Alloy steels	H プリハードン鋼45HRC High-hardened steels under 45HRC	H 高硬度鋼45HRC以上 High-hardened over 45HRC to under 55HRC	M 高硬度HRC超硬 High-hardened over 55HRC	S ステンレス鋼 Stainless steels		N 銅合金 Titanium alloy, Heat-resistant alloy	寸法表 Size list	切削条件 Cutting conditions		
	CFRP, GFRP等 CFRP and GFRP, etc					平面 側面 溝 彫込み ヘルカル 底ぐり Planing Side Cutting Slotting Die-sinking Helical Spot facing	A381	A381			
						平面 側面 溝 彫込み ヘルカル 底ぐり Planing Side Cutting Slotting Die-sinking Helical Spot facing	A382	A382			
						平面 側面 溝 彫込み ヘルカル 底ぐり Planing Side Cutting Slotting Die-sinking Helical Spot facing	A382	A382			
	超硬合金用 for Cemented carbide					平面 Planing	A383	A383			
	◎	◎	○		○	○	○	○	平面 溝 Planing Slotting	A384	A384
	◎	◎	◎	○	○	○	○	○	平面 溝 Planing Slotting	A384	A384
	◎	◎	○		○	○	○	○	溝 彫込み 細部 Slotting Die-sinking Miniature	A385	A385
	◎	◎	○	○	○	○	○	○	溝 彫込み 細部 Slotting Die-sinking Miniature	A385	A385
							○	◎	側面 溝 底ぐり Side Cutting Slotting Spot facing	A386	A386
	◎	◎	○	○	○	○	○	○	側面 溝 底ぐり Side Cutting Slotting Spot facing	A387	A389
	◎	◎	○	○	○	○	○	○	側面 Side Cutting	A388	
	◎	◎	○	○	○	○	○	○	側面 Side Cutting	A388	A389
	○	○			○	○	◎	◎	側面 溝 底ぐり Side Cutting Slotting Spot facing	A390	A392
	○	○			○	○	◎	◎	側面 Side Cutting	A391	
	○	○			○	○	◎	◎	側面 Side Cutting	A391	A393
	◎	◎	○	○	○	○	○	○	側面 Side Cutting	A394	A395
	◎	◎	○	○	○	○	○	○	側面 Side Cutting	A394	
	◎	◎	○	○	○	○	○	○	側面 Side Cutting	A394	A395
	○	○			○	○	◎	◎	側面 Side Cutting	A396	A397
	○	○			○	○	◎	◎	側面 Side Cutting	A396	
	○	○			○	○	◎	◎	側面 Side Cutting	A396	A397
	◎	◎	◎	◎	○	○	◎	○	彫込み 曲面 R Die-sinking Profiling Radius	A398	A402
	◎	◎	◎	◎	○	○	◎	○	彫込み 曲面 R Die-sinking Profiling Radius	A398	A402
	◎	◎	◎	◎	○	◎			超硬平 Adaptive milling 側面 Side Cutting	A398	A403
	◎	◎	◎	◎	○	◎	○	○	平面 側面 溝 Planing Side Cutting Slotting	A399	A404
										A400	

超硬エンドミル形状別 選定目安表

超硬エンドミル
超硬エンドミル形状別 選定目安表

タイプ Type	商品コード Item Code	商品名称 Product	コーティング Coating	工具仕様 Specification	刃数 No. of flutes	外径 Tool Dia.
	EPDB ※	エポックディープボール(CSコーティング) Epoch Deep Ball (CS Coating)	CS	ロングネック Long neck	2	0.1~ 6
	EPDB-TH ※	エポックディープボール(THコーティング) Epoch Deep Ball (TH Coating)	TH	ロングネック Long neck	2	0.1~ 6
	EPBC ※	エポックCSパワーボール Epoch CS Power Ball	CS	レギュラー刃長 Regular	2	1 ~20
	CEPB2 ※	エポックボール 2枚刃 Epoch Ball -2 Flutes	C	レギュラー刃長 Regular	2	1 ~25
	CEPBL5 ※	エポックボール ロングシャンク Epoch Ball -Long Shank	C	ロングシャンク Long Shank	2	1 ~25
	CEPB4 ※	エポックボール 4枚刃 Epoch Ball -4 Flutes	C	レギュラー刃長 Regular	4	6 ~12
	BEK-C	超硬Cコート強力形ボール C Coating Carbide Ball End Mills BEK	C	ショート刃長 Short	2	0.3~20
	BEKLS-C	超硬Cコート強力形ボール ロングシャンク C Coating Carbide Ball End Mills BEK -Long Shank	C	ロングシャンク Long Shank	2	1 ~25
	BES-C	超硬Cコートボール C Coating Carbide Ball End Mills	C	レギュラー刃長 Regular	2	1 ~25
	BESL-C	超硬Cコート深彫り用ボール 首下テーパ C Coating Carbide Ball End Mills for Contouring -Taper Neck	C	ロングネック Long Neck	2	3 ~12
	BESL-S-C	超硬Cコート深彫り用ボール 首下ストレート C Coating Carbide Ball End Mills for Contouring -Straight Neck	C	ロングネック Long Neck	2	3 ~25
	BESS	超硬ミニチュアボールエンドミル Carbide Miniature Ball End Mills		レギュラー刃長 Regular	2	0.3~ 3
	BES	超硬ボールエンドミル Carbide Ball End Mills		レギュラー刃長 Regular	2	1 ~25
	BES-M	超硬ブラ型用ボールエンドミル Carbide Ball End Mills for Plastic Mold		レギュラー刃長 Regular	2	1 ~20
	YB-CS	CSコート超硬エンドミル ボール CS Coating Carbide End Mill -Ball	CS	レギュラー刃長 Regular	2	1 ~20
	JBER	ジェットボール レギュラー Jet Ball -Regular	C	レギュラー刃長 Regular	2	6 ~20
	JBELS	ジェットボール ロングシャンク Jet Ball -Long Shank	C	ロングシャンク Long Shank	2	6 ~20
	FE6	超硬型彫用ボールエンドミル Carbide Ball End Mills for Mold		レギュラー刃長 Regular	2	4 ~20
	GBR	超硬グラファイト用ボールエンドミル レギュラー刃 Carbide Ball End Mills for Graphite -Regular		レギュラー刃長 Regular	2,4	2 ~20
	GBL	超硬グラファイト用ボールエンドミル ロング刃 Carbide Ball End Mills for Graphite -Long		ロング刃長 Long	2,4	2 ~20
	GXB	超硬グラファイト用ボールエンドミル ロングシャンク Carbide Ball End Mills for Graphite -Long Shank		ロングシャンク Long Shank	2,4	2 ~20
	GBS	超硬グラファイト用ボールエンドミル レギュラー刃 専用機用 Carbide Ball End Mills for Graphite -Regular		レギュラー刃長 Regular	2,4	2 ~25
	GBD	超硬グラファイト用ボールエンドミル ロングシャンク 専用機用 Carbide Ball End Mills for Graphite -Long Shank		ロングシャンク Long Shank	2,4	2 ~25
	EPJS-J ※	エポックじゅうおう-J レギュラー刃・コーナR付き Epoch Juoh-J -Regular, Corner Radius	C	レギュラー刃長 Regular	2	4 ~12
	EPJSLS-J ※	エポックじゅうおう-J ロングシャンク・コーナR付き Epoch Juoh-J -Long Shank, Corner Radius	C	ロングシャンク Long Shank	2	4 ~12
	EPR ※	エポックハイフィードラジウス 首下ストレート・コーナR付き Epoch High Feed Radius -Straight Neck, Corner Radius	TH	レギュラー刃長 Regular	3	2 ~20
	EPRPN ※	エポックハイフィードラジウス ペンシルネック・コーナR付き Epoch High Feed Radius -Pencil Neck, Corner Radius	TH	ペンシルネック Pencil Neck	3	2 ~16

特定代理店在庫品
Stocked by Specified distributor

※:エポックエンドミルです。Epoch End Mill

形状 Shape	対応被削材 Applicable work material	加工用途 Applications										掲載頁 Page					
		炭素鋼・合金鋼 Carbon steels, Alloy steels	プリハードン鋼 45HRC以下 Pre-hardened Steels under 45HRC	高硬度45HRC超え55HRC以下 High-hardened over 45HRC to under 55HRC	高硬度55HRC超え60HRC以下 High-hardened over 55HRC to under 60HRC	高硬度60HRC超え High-hardened over 60HRC	M ステンレス鋼 Stainless steels	S チタン合金・耐熱合金 Titanium alloy, Heat-resistant alloy	N 銅合金 Copper alloy	アルミ合金 Aluminum alloy	溝 Slotting	彫込み Die-sinking	曲面 Profiling	R Radius	細部 Miniature	側面 Side cutting	寸法表 Size list
		○	○	○	○	○	○	○	○	○	○	○	○	○	○	A405	A407
		○	○	○	○	○	○	○	○	○	○	○	○	○	○	A405	A407
		○	○	○	○	○	○	○	○	○	○	○	○	○	○	A409	A410
		○	○	○	○	○	○	○	○	○	○	○	○	○	○	A411	A412
		○	○	○	○	○	○	○	○	○	○	○	○	○	○	A411	A413
		○	○	○	○	○	○	○	○	○	○	○	○	○	○	A411	A414
		○	○	○	○	○	○	○	○	○	○	○	○	○	○	A415	A416
		○	○	○	○	○	○	○	○	○	○	○	○	○	○	A415	A417
		○	○	○	○	○	○	○	○	○	○	○	○	○	○	A415	
		○	○	○	○	○	○	○	○	○	○	○	○	○	○	A418	A419
		○	○	○	○	○	○	○	○	○	○	○	○	○	○	A418	A420
		○	○	○	○	○	○	○	○	○	○	○	○	○	○	A421	
		○	○	○	○	○	○	○	○	○	○	○	○	○	○	A421	
		○	○	○	○	○	○	○	○	○	○	○	○	○	○	A421	
		○	○	○	○	○	○	○	○	○	○	○	○	○	○	A422	A422
		○	○	○	○	○	○	○	○	○	○	○	○	○	○	A422	A423
		○	○	○	○	○	○	○	○	○	○	○	○	○	○	A422	A424
		○	○	○	○	○	○	○	○	○	○	○	○	○	○	A425	
		○	○	○	○	○	○	○	○	○	○	○	○	○	○	A425	A425
		○	○	○	○	○	○	○	○	○	○	○	○	○	○	A425	A425
		○	○	○	○	○	○	○	○	○	○	○	○	○	○	A426	A425
		○	○	○	○	○	○	○	○	○	○	○	○	○	○	A426	A426
		○	○	○	○	○	○	○	○	○	○	○	○	○	○	A426	A426
		○	○	○	○	○	○	○	○	○	○	○	○	○	○	A427	A428
		○	○	○	○	○	○	○	○	○	○	○	○	○	○	A427	A428
		○	○	○	○	○	○	○	○	○	○	○	○	○	○	A429	A429
		○	○	○	○	○	○	○	○	○	○	○	○	○	○	A429	A429

Carbide End Mills

Selection criteria table according to carbide end mill shape

超硬エンドミル形状別 選定目安表

超硬エンドミル

超硬エンドミル形状別 選定目安表

タイプ Type	商品コード Item Code	商品名称 Product	コーティング Coating	工具仕様 Specification	刃数 No. of flutes	外径 Tool Dia.
	EPDS ※	エポックディープスクエア (CSコーティング) Epoch Deep Square (CS Coating)	CS	ロングネック Long neck	2	0.1~ 4
	EPDS-TH ※	エポックディープスクエア (THコーティング) Epoch Deep Square (TH Coating)	TH	ロングネック Long neck	2	0.1~ 4
	PES-C	超硬Cコートエンドミル"ピンカド" 2枚刃 ショート刃 C Coating Carbide End Mills "PINKADO" -2 Flutes, Short	C	ショート刃長 Short	2	1 ~20
	PESR2-C	超硬Cコートエンドミル"ピンカド" 2枚刃 レギュラー刃 C Coating Carbide End Mills "PINKADO" -2 Flutes, Regular	C	レギュラー刃長 Regular	2	1 ~20
	PESR4-C	超硬Cコートエンドミル"ピンカド" 4枚刃 レギュラー刃 C Coating Carbide End Mills "PINKADO" -4 Flutes, Regular	C	レギュラー刃長 Regular	4	2 ~20
	PES	超硬エンドミル"ピンカド" 2枚刃 ショート刃 Carbide End Mills "PINKADO" -2 Flutes, Short		ショート刃長 Short	2	1 ~20
	PESR2	超硬エンドミル"ピンカド" 2枚刃 レギュラー刃 Carbide End Mills "PINKADO" -2 Flutes, Regular		レギュラー刃長 Regular	2	1 ~12
	PESR4	超硬エンドミル"ピンカド" 4枚刃 レギュラー刃 Carbide End Mills "PINKADO" -4 Flutes, Regular		レギュラー刃長 Regular	4	2 ~12
	YS-CS	CSコート超硬エンドミルスクエア ショート刃 ピンカド CS Coating Carbide End Mill Square -Short Pinkado	CS	ショート刃長 Short	2	0.2~20
	YR-CS	CSコート超硬エンドミルスクエア レギュラー刃 ピンカド CS Coating Carbide End Mill Square -Regular, Pinkado	CS	レギュラー刃長 Regular	4	1 ~20
	SES-C	超硬Cコートスーパーヘリカルエンドミル C Coating Carbide Super Helical End Mills	C	レギュラー刃長 Regular	2,3	2 ~20
	SES	超硬スーパーヘリカルエンドミル Carbide Super Helical End Mills		レギュラー刃長 Regular	2,3,4	2 ~30
	KES	超硬キー溝用エンドミル プラス公差 Carbide End Mills for Key-way -Plus Tolerance		レギュラー刃長 Regular	2	2 ~16
	KESU	超硬キー溝用エンドミル マイナス公差 Carbide End Mills for Key-way -Minus Tolerance		レギュラー刃長 Regular	2	2 ~16
	TES	超硬高硬度材用エンドミル Carbide End Mills for High Hardened Steel		レギュラー刃長 Regular	2	2 ~12
	FE7	超硬型彫り用エンドミル スクエア刃 Carbide End Mills for Mold - Square		レギュラー刃長 Regular	2	4 ~20
	GSR	超硬グラファイト用スクエアエンドミル レギュラー刃 Carbide End Mills for Graphite -Regular, Square		レギュラー刃長 Regular	2,4	2 ~20
	GSL	超硬グラファイト用スクエアエンドミル ロング刃 Carbide End Mills for Graphite -Long, Square		ロング刃長 Long	2,4	2 ~20
	GXR	超硬グラファイト用スクエアエンドミル ロングシャンク Carbide End Mills for Graphite -Long Shank		ロングシャンク Long Shank	2,4	2 ~20
	GSE	超硬グラファイト用スクエアエンドミル レギュラー刃 専用機用 Carbide End Mills for Graphite -Regular, Square		レギュラー刃長 Regular	4	2 ~30
	GSD	超硬グラファイト用スクエアエンドミル ロングシャンク 専用機用 Carbide End Mills for Graphite -Long Shank, Square		ロングシャンク Long Shank	4	2 ~30
	HTE2-C ※	エポックテーパ 2枚刃 Epoch Taper -2 Flutes	C	レギュラー刃長 Regular	2	1 ~10
	HTE4-C ※	エポックテーパ 4枚刃 Epoch Taper -4 Flutes	C	レギュラー刃長 Regular	4	3 ~10
	HTS	超硬テーパエンドミル レギュラー刃 Carbide Taper End Mills -Regular		レギュラー刃長 Regular	2,4	3 ~12
	HTSL	超硬テーパエンドミル ロング刃 Carbide Taper End Mills -Long		ロング刃長 Long	2	1 ~ 3
	HTSB	超硬テーパボールエンドミル Carbide Taper Ball End Mills		レギュラー刃長 Regular	2,4	3 ~12
	FE4	超硬型彫り用エンドミル テーパーボール刃 Carbide End Mills for Mold -Taper Ball End		レギュラー刃長 Regular	2	2 ~ 6

特定代理店在庫品
Stocked by Specified distributor

※:エポックエンドミルです。Epoch End Mill

形状 Shape	対応被削材 Applicable work material										加工用途 Applications	掲載頁 Page					
	炭素鋼・合金鋼 Carbon steels, Alloy steels		プリハードン鋼45以下 Pre-hardened Steels under 45 HRC		高硬度45HRC超え55HRC以下 High-hardened over 45HRC to under 55HRC		高硬度55HRC超え65HRC以下 High-hardened over 55HRC to under 65HRC		ステンレス鋼 Stainless steels			M	S	N	寸法表 Size list	切削条件 Cutting conditions	
	◎	○	◎	○	◎	○	◎	○	◎	○		◎	○	◎			○
	◎	◎	◎	○					◎	◎	◎	◎	側面 Side Cutting	溝 Slotting	細部 Miniature	A430	A432
	◎	◎	◎	○					◎	◎	◎	◎	側面 Side Cutting	溝 Slotting	細部 Miniature	A430	A432
	◎	◎	○	○					◎	◎	◎	◎	側面 Side Cutting	溝 Slotting	座ぐり Spot facing	A434	A436
	◎	◎	○	○					◎	◎	◎	◎	側面 Side Cutting	溝 Slotting	座ぐり Spot facing	A434	A436
	◎	◎	○	○					◎	◎	◎	◎	側面 Side Cutting			A434	A436
	○	○							◎	◎	◎	◎	側面 Side Cutting	溝 Slotting	座ぐり Spot facing	A435	A436
	○	○							◎	◎	◎	◎	側面 Side Cutting	溝 Slotting	座ぐり Spot facing	A435	A436
	○	○							◎	◎	◎	◎	側面 Side Cutting			A435	A436
	◎	○							◎	◎	◎	◎	側面 Side Cutting	溝 Slotting	座ぐり Spot facing	A437	A438
	◎	○							◎	◎	◎	◎	側面 Side Cutting	溝 Slotting	座ぐり Spot facing	A437	A438
	◎	◎	○	○					◎	◎	◎	◎	側面 Side Cutting	溝 Slotting		A439	A439
	○	○							◎	◎	◎	◎	側面 Side Cutting	溝 Slotting		A439	A439
	○	○							◎	◎	◎	◎	溝 Slotting			A440	
	○	○							◎	◎	◎	◎	溝 Slotting			A440	
	○	○							◎	◎	◎	◎	側面 Side Cutting			A440	
	○	○							◎	◎	◎	◎	側面 Side Cutting			A440	
													側面 Side Cutting	溝 Slotting	座ぐり Spot facing	A441	A441
													側面 Side Cutting	溝 Slotting	座ぐり Spot facing	A441	A441
													側面 Side Cutting	溝 Slotting		A441	A441
													側面 Side Cutting	溝 Slotting	座ぐり Spot facing	A442	A442
													側面 Side Cutting	溝 Slotting	座ぐり Spot facing	A442	A442
	◎	◎	○	○					◎	◎	◎	◎	テーパ Taper			A443	A443
	◎	◎	○	○					◎	◎	◎	◎	テーパ Taper			A443	A443
	○	○							◎	◎	◎	◎	テーパ Taper			A444	
	○	○							◎	◎	◎	◎	テーパ Taper			A444	
	○	○							◎	◎	◎	◎	テーパ Taper			A444	
	○	○							◎	◎	◎	◎	テーパ Radius Taper			A445	









Carbide End Mills

Selection criteria table according to carbide end mill shape













超硬エンドミル形状別 選定目安表

超硬エンドミル

超硬エンドミル形状別 選定目安表

タイプ Type	商品コード Item Code	商品名称 Product	コーティング Coating	工具仕様 Specification	刃数 No. of flutes	外径 Tool Dia.
特定代理店在庫品 Stocked by Specified distributor	GTB	超硬グラファイト用テーパボールエンドミル ショート刃 Carbide Taper Ball End Mills for Graphite -Short		ショート刃長 Short	2	2 ~16
	EPRB-C ※	エポックリブボール Epoch RIB Ball		レギュラー刃長 Regular	4	0.6~ 3
	DEB-C	超硬Cコート"リブカットボール" C Coating Carbide End Mills "RIB-CUT Ball"		ロングネック Long Neck	2	0.6~ 2
	RIB-CR-C	超硬Cコートエンドミル"リブスター" コーナR付き C Coating Carbide End Mills "RIB STAR" Corner Radius		レギュラー刃長 Regular	6	1 ~ 3
	EPRI-C ※	エポックリブ Epoch RIB		レギュラー刃長 Regular	4	0.5~ 3
	DES-C	超硬Cコート"リブカット" C Coating Carbide End Mills "RIB-CUT"		ロングネック Long Neck	2	0.5~ 6
	RIB-C	超硬Cコートエンドミル"リブスター" C Coating Carbide End Mills "RIB STAR"		レギュラー刃長 Regular	6	0.5~ 3
	EPQS-CS ※	エポックラフィング ショート刃 Epoch Roughing -Short		ショート刃長 Short	4	6 ~20
	EPQM-CS ※	エポックラフィング ミディアム刃 Epoch Roughing -Medium		ミディアム刃長 Medium	4	6 ~20
	EPQLS-CS ※	エポックラフィング ロングシャンク Epoch Roughing -Long Shank		ロングシャンク Long Shank	4	6 ~20
	BHS	CBN小径エンドミル スクエア刃 CBN Miniature End Mills -Square End			2	1 ~ 2
	BHSR	CBN小径エンドミル コーナR付き CBN Miniature End Mills -Radius End			2	1 ~ 2
	BHB	CBN小径エンドミル ボール刃 CBN Miniature End Mills -Ball End			2	1 ~ 2

※:エポックエンドミルです。Epoch End Mill

形状 Shape	対応被削材 Applicable work material										加工用途 Applications		掲載頁 Page				
	P	H				M	S	N		寸法表 Size list			切削条件 Cutting conditions				
	炭素鋼・合金鋼 Carbon steels, Alloy steels	プリハードン鋼45以下 Pre-harden Steels under 45 HRC	高硬度45HRC超え55以下 High-hardened over 45HRC to under 55HRC	高硬度55HRC超え60以下 High-hardened over 55HRC to under 60HRC	高硬度60HRC超え High-hardened over 60HRC	ステンレス鋼 Stainless steels	チタン合金・耐熱合金 Titanium alloy, Heat-resistant alloy	銅合金 Copper alloy	アルミ合金 Aluminum alloy								
	グラファイト用 for Graphite										溝 Slotting	形込み Die-sinking	曲面 Profiling	R Radius	ヘリカル Helical	A445	A445
	○	○	○	○		○	○	○	○	○	○	○	○	○	○	A446	A447
	○	○	○	○		○	○	○	○	○	○	○	○	○	○	A448	A448
	○	○	○	○		○	○	○	○	○	○	○	○	○	○	A449	A449
	○	○	○	○		○	○	○	○	○	○	○	○	○	○	A450	A451
	○	○	○	○		○	○	○	○	○	○	○	○	○	○	A452	A452
	○	○	○	○		○	○	○	○	○	○	○	○	○	○	A453	A454
	○	○	○			○	○	○	○	○	○	○	○	○	○	A455	A370
	○	○	○			○	○	○	○	○	○	○	○	○	○	A455	A370
	○	○	○			○	○	○	○	○	○	○	○	○	○	A455	A370
		○	○													A456	
		○	○													A456	
		○	○													A456	

外径別寸法早見表

超硬エンドミル・ボール

RE0.05 ~ RE0.3 Carbide End Mills -Ball

単位 unit : mm

商品コード Item Code	在庫 Stock	ボール 半径 RE	首下長 Under neck length	刃長 Flute length	全長 Overall length	シャンク径 Shank dia.	ページ Page
EPDBEH2001F-0.08-TH3	●	0.05	0.08	0.08	35	4	A63
EPDBEH2001-0.08-TH3	●	0.05	0.08	0.08	45	4	A63
EPSBE2001-0.15-TH	●	0.05	0.15	0.08	45	4	A97
EPSBE2001-0.15-H-TH	●	0.05	0.15	0.08	45	4	A98
EPDBEH2001F-0.2-TH3	●	0.05	0.2	0.08	35	4	A56
EPDBEH2001-0.2-TH3	●	0.05	0.2	0.08	45	4	A58
EPDBE2001-0.2-ATH	●	0.05	0.2	0.08	45	4	A72
EPDBE2001-0.2-PN	●	0.05	0.2	0.08	45	4	A75
EPDB2001-0.2	□	0.05	0.2	0.08	45	4	A405
EPDB2001-0.2-TH	□	0.05	0.2	0.08	45	4	A405
EPDBEH2001F-0.3-TH3	●	0.05	0.3	0.08	35	4	A56
EPDBEH2001-0.3-TH3	●	0.05	0.3	0.08	45	4	A58
EPDBE2001-0.3-ATH	●	0.05	0.3	0.08	45	4	A72
EPDBE2001-0.3-PN	●	0.05	0.3	0.08	45	4	A75
EPSBE2001-0.3-TH	●	0.05	0.3	0.08	45	4	A97
EPSB2001-0.3-N-TH	●	0.05	0.3	0.08	45	4	A155
EPDB2001-0.3	□	0.05	0.3	0.08	45	4	A405
EPDB2001-0.3-TH	□	0.05	0.3	0.08	45	4	A405
EPDBEH2001F-0.5-TH3	●	0.05	0.5	0.08	35	4	A56
EPDBEH2001-0.5-TH3	●	0.05	0.5	0.08	45	4	A58
EPDBE2001-0.5-ATH	●	0.05	0.5	0.08	45	4	A72
EPDBE2001-0.5-PN	●	0.05	0.5	0.08	45	4	A75
EPDB2001-0.5	□	0.05	0.5	0.08	45	4	A405
EPDB2001-0.5-TH	□	0.05	0.5	0.08	45	4	A405
EPDBEH2001-0.75-TH	●	0.05	0.75	0.08	45	4	A97
EPSB2001-H-TH	●	0.05	-	0.08	45	4	A154
EPSB2001-N-TH	●	0.05	-	0.08	45	4	A154
EPDBEH20015F-0.12-TH3	●	0.075	0.12	0.12	35	4	A63
EPDBEH20015-0.12-TH3	●	0.075	0.12	0.12	45	4	A63
EPDBEH20015F-0.3-TH3	●	0.075	0.3	0.12	35	4	A56
EPDBEH20015-0.3-TH3	●	0.075	0.3	0.12	45	4	A58
EPDBEH20015F-0.5-TH3	●	0.075	0.5	0.12	35	4	A56
EPDBEH20015-0.5-TH3	●	0.075	0.5	0.12	45	4	A58
EPDBEH20015F-0.75-TH3	●	0.075	0.75	0.12	35	4	A56
EPDBEH20015-0.75-TH3	●	0.075	0.75	0.12	45	4	A58
EPDBEH20015-1-TH3	●	0.075	1	0.12	45	4	A58
EPDBEH2002F-0.15-TH3	●	0.1	0.15	0.15	35	4	A63
EPDBEH2002-0.15-TH3	●	0.1	0.15	0.15	50	4	A63
EPDBEH2002F-0.3-TH3	●	0.1	0.3	0.15	35	4	A56
EPSBE2002-0.3-TH	●	0.1	0.3	0.15	45	4	A97
EPSBE2002-0.3-H-TH	●	0.1	0.3	0.15	45	4	A98
EPDBEH2002-0.3-TH3	●	0.1	0.3	0.15	50	4	A58
EPDB2002-0.4-SD	●	0.1	0.4	0.15	50	4	A140
CBN-EHB2002-0.5	●	0.1	0.5	0.12	50	4	A147
CBN-EPSB2002-0.5-S	●	0.1	0.5	0.12	50	4	A151
CBN-EPSB2002-0.5-F	●	0.1	0.5	0.12	50	4	A151
EPDBEH2002F-0.5-TH3	●	0.1	0.5	0.15	35	4	A56
EPDBEH2002-0.5-TH3	●	0.1	0.5	0.15	50	4	A58
EPDBE2002-0.5-ATH	●	0.1	0.5	0.15	50	4	A72
EPDBE2002-0.5-PN	●	0.1	0.5	0.15	50	4	A75
EPDB2002-0.5	□	0.1	0.5	0.15	50	4	A405
EPDB2002-0.5-TH	□	0.1	0.5	0.15	50	4	A405
EPSBE2002-0.6-TH	●	0.1	0.6	0.15	45	4	A97
EPSB2002-0.6-N-TH	●	0.1	0.6	0.15	45	4	A155
EPDB2002-0.6-SD	●	0.1	0.6	0.15	50	4	A140
CBN-EHB2002-0.75	●	0.1	0.75	0.12	50	4	A147
EPDBEH2002F-0.75-TH3	●	0.1	0.75	0.15	35	4	A56
EPDBEH2002-0.75-TH3	●	0.1	0.75	0.15	50	4	A58
EPDBE2002-0.75-ATH	●	0.1	0.75	0.15	50	4	A72
EPDBE2002-0.75-PN	●	0.1	0.75	0.15	50	4	A75
CBN-EHB2002-1	●	0.1	1	0.12	50	4	A147
CBN-EPSB2002-1-S	●	0.1	1	0.12	50	4	A151
CBN-EPSB2002-1-F	●	0.1	1	0.12	50	4	A151
EPDBEH2002F-1-TH3	●	0.1	1	0.15	38	4	A56
EPSBE2002-1-TH	●	0.1	1	0.15	45	4	A97
EPDBEH2002-1-TH3	●	0.1	1	0.15	50	4	A58
EPDBE2002-1-ATH	●	0.1	1	0.15	50	4	A72
EPDBE2002-1-PN	●	0.1	1	0.15	50	4	A75
EPDBPE2002-1-04-ATH	●	0.1	1	0.15	50	4	A84

商品コード Item Code	在庫 Stock	ボール 半径 RE	首下長 Under neck length	刃長 Flute length	全長 Overall length	シャンク径 Shank dia.	ページ Page
EPDBPE2002-1-14-ATH	●	0.1	1	0.15	50	4	A84
EPDBPE2002-1-29-ATH	●	0.1	1	0.15	50	4	A84
EPDB2002-1-SD	●	0.1	1	0.15	50	4	A140
EPDBP2002-1-04-TH	△	0.1	1	0.15	50	4	A162
EPDB2002-1	□	0.1	1	0.15	50	4	A405
EPDB2002-1-TH	□	0.1	1	0.15	50	4	A405
EPDBEH2002-1.25-TH3	●	0.1	1.25	0.15	50	4	A58
EPDBE2002-1.25-ATH	●	0.1	1.25	0.15	50	4	A72
EPDBE2002-1.25-PN	●	0.1	1.25	0.15	50	4	A75
CBN-EHB2002-1.5	●	0.1	1.5	0.12	50	4	A147
EPSBE2002-1.5-TH	●	0.1	1.5	0.15	45	4	A97
EPDBEH2002-1.5-TH3	●	0.1	1.5	0.15	50	4	A58
EPDBE2002-1.5-ATH	●	0.1	1.5	0.15	50	4	A72
EPDBE2002-1.5-PN	●	0.1	1.5	0.15	50	4	A75
EPDBPE2002-1.5-04-ATH	●	0.1	1.5	0.15	50	4	A84
EPDBP2002-1.5-04-TH	△	0.1	1.5	0.15	50	4	A162
EPDB2002-1.5	□	0.1	1.5	0.15	50	4	A405
EPDB2002-1.5-TH	□	0.1	1.5	0.15	50	4	A405
CBN-EHB2002-2	●	0.1	2	0.12	50	4	A147
EPSBE2002-2-TH	●	0.1	2	0.15	45	4	A97
EPDBEH2002-2-TH3	●	0.1	2	0.15	50	4	A58
EPDBE2002-2-ATH	●	0.1	2	0.15	50	4	A72
EPDBE2002-2-PN	●	0.1	2	0.15	50	4	A75
EPDBPE2002-2-04-ATH	●	0.1	2	0.15	50	4	A84
EPDBPE2002-2-09-ATH	●	0.1	2	0.15	50	4	A84
EPDBPE2002-2-14-ATH	●	0.1	2	0.15	50	4	A84
EPDBPE2002-2-29-ATH	●	0.1	2	0.15	50	4	A84
EPDBP2002-2-09-TH	△	0.1	2	0.15	50	4	A162
EPDB2002-2	□	0.1	2	0.15	50	4	A405
EPDB2002-2-TH	□	0.1	2	0.15	50	4	A405
EPDBEH2002-2.5-TH3	●	0.1	2.5	0.15	50	4	A58
EPDBE2002-2.5-ATH	●	0.1	2.5	0.15	50	4	A72
EPDBE2002-2.5-PN	●	0.1	2.5	0.15	50	4	A75
EPDBPE2002-2.5-09-ATH	●	0.1	2.5	0.15	50	4	A84
EPDBP2002-2.5-09-TH	△	0.1	2.5	0.15	50	4	A162
EPDB2002-2.5	□	0.1	2.5	0.15	50	4	A405
EPDB2002-2.5-TH	□	0.1	2.5	0.15	50	4	A405
EPDBEH2002-3-TH3	●	0.1	3	0.15	50	4	A58
EPDBE2002-3-ATH	●	0.1	3	0.15	50	4	A72
EPDBE2002-3-PN	●	0.1	3	0.15	50	4	A75
EPDBPE2002-3-04-ATH	●	0.1	3	0.15	50	4	A84
EPDBPE2002-3-09-ATH	●	0.1	3	0.15	50	4	A84
EPDBPE2002-3-14-ATH	●	0.1	3	0.15	50	4	A84
EPDBPE2002-3-29-ATH	●	0.1	3	0.15	50	4	A84
EPDB2002-3	□	0.1	3	0.15	50	4	A405
EPDB2002-3-TH	□	0.1	3	0.15	50	4	A405
EPSB2002-H-TH	●	0.1	-	0.15	45	4	A154
EPSB2002-N-TH	●	0.1	-	0.15	45	4	A154
HYPB2002-C	●	0.1	-	0.3	50	6	A156
EPDBEH2003F-0.25-TH3	●	0.15	0.25	0.25	35	4	A63
EPDBEH2003-0.25-TH3	●	0.15	0.25	0.25	50	4	A63
EPSBE2003-0.45-TH	●	0.15	0.45	0.25	45	4	A97
CBN-EHB2003-0.5	●	0.15	0.5	0.18	50	4	A147
EPDBEH2003F-0.5-TH3	●	0.15	0.5	0.25	35	4	A56
EPDBEH2003-0.5-TH3	●	0.15	0.5	0.25	50	4	A58
EPDBE2003-0.5-ATH	●	0.15	0.5	0.25	50	4	A72
EPDBE2003-0.5-PN	●	0.15	0.5	0.25	50	4	A75
EPDB2003-0.5-SD	●	0.15	0.5	0.25	50	4	A140
CBN-EHB2003-0.75	●	0.15	0.75	0.18	50	4	A147
CBN-EPSB2003-0.75-S	●	0.15	0.75	0.18	50	4	A151
CBN-EPSB2003-0.75-F	●	0.15	0.75	0.18	50	4	A151
EPDBEH2003F-0.75-TH3	●	0.15	0.75	0.25	35	4	A56
EPDBEH2003-0.75-TH3	●	0.15	0.75	0.25	50	4	A58
EPDBE2003-0.75-ATH	●	0.15	0.75	0.25	50	4	A72
EPDBE2003-0.75-PN	●	0.15	0.75	0.25	50	4	A75
EPSBE2003-0.9-TH	●	0.15	0.9	0.25	45	4	A97
EPSB2003-0.9-N-TH	●	0.15	0.9	0.25	45	4	A155
HGOB2003-PN	●	0.15	0.9	0.6	50	4	A104

商品コード Item Code	在庫 Stock	ボール 半径 RE	首下長 Under neck length	刃長 Flute length	全長 Overall length	シャンク径 Shank dia.	ページ Page
CBN-EHB2003-1	●	0.15	1	0.18	50	4	A147
EPDBEH2003F-1-TH3	●	0.15	1	0.25	35	4	A56
EPDBEH2003-1-TH3	●	0.15	1	0.25	50	4	A58
EPDBE2003-1-ATH	●	0.15	1	0.25	50	4	A72
EPDBE2003-1-PN	●	0.15	1	0.25	50	4	A75
EPDB2003-1-SD	●	0.15	1	0.25	50	4	A140
EPDB2003-1	□	0.15	1	0.25	50	4	A405
EPDB2003-1-TH	□	0.15	1	0.25	50	4	A405
EPDBEH2003-1.25-TH3	●	0.15	1.25	0.25	50	4	A58
EPDBE2003-1.25-ATH	●	0.15	1.25	0.25	50	4	A72
EPDBE2003-1.25-PN	●	0.15	1.25	0.25	50	4	A75
CBN-EHB2003-1.5	●	0.15	1.5	0.18	50	4	A147
CBN-EPSB2003-1.5-S	●	0.15	1.5	0.18	50	4	A151
CBN-EPSB2003-1.5-F	●	0.15	1.5	0.18	50	4	A151
EPDBEH2003F-1.5-TH3	●	0.15	1.5	0.25	38	4	A56
EPSBE2003-1.5-TH	●	0.15	1.5	0.25	45	4	A97
EPDBEH2003-1.5-TH3	●	0.15	1.5	0.25	50	4	A58
EPDBE2003-1.5-ATH	●	0.15	1.5	0.25	50	4	A72
EPDBE2003-1.5-PN	●	0.15	1.5	0.25	50	4	A75
EPDB2003-1.5-SD	●	0.15	1.5	0.25	50	4	A140

単位 unit : mm

商品コード Item Code	在庫 Stock	ボール 半径 RE	首下長 Under neck length	刃長 Flute length	全長 Overall length	シャンク径 Shank dia.	ページ Page
EPDBEH2004F-1-TH3	●	0.2	1	0.3	35	4	A56
EPDBEH2004-1-TH3	●	0.2	1	0.3	50	4	A58
EPDBE2004-1-ATH	●	0.2	1	0.3	50	4	A72
EPDBE2004-1-PN	●	0.2	1	0.3	50	4	A75
EPDB2004-1-SD	●	0.2	1	0.3	50	4	A140
EPDB2004-1	□	0.2	1	0.3	50	4	A405
EPDB2004-1-TH	□	0.2	1	0.3	50	4	A405
CBN-EHB2004-1	●	0.2	1	0.4	50	4	A147
HGOB2004-PN	●	0.2	1.1	0.8	50	4	A104
EPSBE2004-1.2-TH	●	0.2	1.2	0.3	45	4	A97
EPSB2004-1.2-N-TH	●	0.2	1.2	0.3	45	4	A155
PCDB0004	□	0.2	1.4	0.35	40	4	A146
EPDBEH2004F-1.5-TH3	●	0.2	1.5	0.3	38	4	A56
EPDBEH2004-1.5-TH3	●	0.2	1.5	0.3	50	4	A58
EPDBE2004-1.5-ATH	●	0.2	1.5	0.3	50	4	A72
EPDBE2004-1.5-PN	●	0.2	1.5	0.3	50	4	A75
EPDB2004-1.5-SD	●	0.2	1.5	0.3	50	4	A140
EPDB2004-1.5	□	0.2	1.5	0.3	50	4	A405
EPDB2004-1.5-TH	□	0.2	1.5	0.3	50	4	A405
CBN-EHB2004-1.5	●	0.2	1.5	0.4	50	4	A147
CBN-EPSB2004-2-S	●	0.2	2	0.24	50	4	A151
CBN-EPSB2004-2-F	●	0.2	2	0.24	50	4	A151
EPDBEH2004F-2-TH3	●	0.2	2	0.3	38	4	A56
EPSBE2004-2-TH	●	0.2	2	0.3	45	4	A97
EPDBEH2004-2-TH3	●	0.2	2	0.3	50	4	A58
EPDBE2004-2-ATH	●	0.2	2	0.3	50	4	A72
EPDBE2004-2-PN	●	0.2	2	0.3	50	4	A75
EPDBPE2004-2-04-ATH	●	0.2	2	0.3	50	4	A84
EPDBPE2004-2-09-ATH	●	0.2	2	0.3	50	4	A84
EPDBPE2004-2-14-ATH	●	0.2	2	0.3	50	4	A84
EPDBPE2004-2-29-ATH	●	0.2	2	0.3	50	4	A84
EPDB2004-2-SD	●	0.2	2	0.3	50	4	A140
EPDBP2004-2-04-TH	△	0.2	2	0.3	50	4	A162
EPDB2004-2	□	0.2	2	0.3	50	4	A405
EPDB2004-2-TH	□	0.2	2	0.3	50	4	A405
CBN-EHB2004-2	●	0.2	2	0.4	50	4	A147
EPDBEH2004F-2.5-TH3	●	0.2	2.5	0.3	38	4	A56
EPDBEH2004-2.5-TH3	●	0.2	2.5	0.3	50	4	A58
EPDBE2004-2.5-ATH	●	0.2	2.5	0.3	50	4	A72
EPDBE2004-2.5-PN	●	0.2	2.5	0.3	50	4	A75
EPDB2004-2.5	□	0.2	2.5	0.3	50	4	A405
EPDB2004-2.5-TH	□	0.2	2.5	0.3	50	4	A405
EPDBEH2004F-3-TH3	●	0.2	3	0.3	38	4	A56
EPSBE2004-3-TH	●	0.2	3	0.3	45	4	A97
EPDBEH2004-3-TH3	●	0.2	3	0.3	50	4	A58
EPDBE2004-3-ATH	●	0.2	3	0.3	50	4	A72
EPDBE2004-3-PN	●	0.2	3	0.3	50	4	A75
EPDBPE2004-3-04-ATH	●	0.2	3	0.3	50	4	A84
EPDBP2004-3-04-TH	△	0.2	3	0.3	50	4	A162
EPDB2004-3	□	0.2	3	0.3	50	4	A405
EPDB2004-3-TH	□	0.2	3	0.3	50	4	A405
CBN-EHB2004-3	●	0.2	3	0.4	50	4	A147
EPSBE2004-3.5-TH	●	0.2	3.5	0.3	45	4	A97
EPDBEH2004-3.5-TH3	●	0.2	3.5	0.3	50	4	A58
EPDBE2004-3.5-ATH	●	0.2	3.5	0.3	50	4	A72
EPDBE2004-3.5-PN	●	0.2	3.5	0.3	50	4	A75
EPDB2004-3.5	□	0.2	3.5	0.3	50	4	A405
EPDB2004-3.5-TH	□	0.2	3.5	0.3	50	4	A405
EPDBEH2004F-4-TH3	●	0.2	4	0.3	38	4	A56
EPSBE2004-4-TH	●	0.2	4	0.3	45	4	A97
EPDBEH2004-4-TH3	●	0.2	4	0.3	50	4	A58
EPDBE2004-4-ATH	●	0.2	4	0.3	50	4	A72
EPDBE2004-4-PN	●	0.2	4	0.3	50	4	A75
EPDBPE2004-4-04-ATH	●	0.2	4	0.3	50	4	A84
EPDBPE2004-4-09-ATH	●	0.2	4	0.3	50	4	A84
EPDBPE2004-4-14-ATH	●	0.2	4	0.3	50	4	A84
EPDBPE2004-4-29-ATH	●	0.2	4	0.3	50	4	A84
EPDBP2004-4-04-TH	△	0.2	4	0.3	50	4	A162
EPDBP2004-4-09-TH	△	0.2	4	0.3	50	4	A162

商品コード Item Code	在庫 Stock	ボール 半径 RE	首下長 Under neck length	刃長 Flute length	全長 Overall length	シャンク径 Shank dia.	ページ Page
EPDB2004-4	□	0.2	4	0.3	50	4	A405
EPDB2004-4-TH	□	0.2	4	0.3	50	4	A405
EGDB2004-4-HD	□	0.2	4	0.6	60	4	A143
EPDBEH2004-4.5-TH3	●	0.2	4.5	0.3	50	4	A58
EPDBE2004-4.5-ATH	●	0.2	4.5	0.3	50	4	A72
EPDBE2004-4.5-PN	●	0.2	4.5	0.3	50	4	A75
EPDB2004-4.5	□	0.2	4.5	0.3	50	4	A405
EPDB2004-4.5-TH	□	0.2	4.5	0.3	50	4	A405
EPDBEH2004-5-TH3	●	0.2	5	0.3	50	4	A58
EPDBPE2004-5-04-ATH	●	0.2	5	0.3	50	4	A84
EPDBPE2004-5-09-ATH	●	0.2	5	0.3	50	4	A84
EPDBP2004-5-04-TH	△	0.2	5	0.3	50	4	A162
EPDBP2004-5-09-TH	△	0.2	5	0.3	50	4	A162
EPDBPE2004-6-04-ATH	●	0.2	6	0.3	50	4	A84
EPDBPE2004-6-09-ATH	●	0.2	6	0.3	50	4	A84
EPDBPE2004-6-14-ATH	●	0.2	6	0.3	50	4	A84
EPDBPE2004-6-29-ATH	●	0.2	6	0.3	50	4	A84
EPDBPE2004-8-04-ATH	●	0.2	8	0.3	50	4	A84
EGDB2004-8-HD	●	0.2	8	0.6	60	4	A143
EGDB2004-12-HD	●	0.2	12	0.6	60	4	A143
EPSB2004-N-TH	●	0.2	-	0.3	45	4	A154
EPSB2004-H-TH	●	0.2	-	0.3	45	4	A154
HYPB2004-C	●	0.2	-	0.5	50	6	A156
BESS2004	□	0.2	-	0.6	50	3	A421
BEK2004	□	0.2	-	0.8	50	3	A415
BEK2004-C	□	0.2	-	0.8	50	3	A415
EPDBEH2005F-0.35-TH3	●	0.25	0.35	0.35	35	4	A63
EPDBEH2005-0.35-TH3	●	0.25	0.35	0.35	50	4	A63
EPDBEH2005F-0.75-TH3	●	0.25	0.75	0.35	35	4	A56
EPSBE2005-0.75-TH	●	0.25	0.75	0.35	45	4	A97
EPDBE2005-0.75-H-TH	●	0.25	0.75	0.35	45	4	A98
EPDBEH2005-0.75-TH3	●	0.25	0.75	0.35	50	4	A58
EPDBEH2005F-1-TH3	●	0.25	1	0.35	35	4	A56
EPDBEH2005-1-TH3	●	0.25	1	0.35	50	4	A59
EPDBE2005-1-ATH	●	0.25	1	0.35	50	4	A72
EPDBE2005-1-PN	●	0.25	1	0.35	50	4	A75
EPDB2005-1	□	0.25	1	0.35	50	4	A405
EPDB2005-1-TH	□	0.25	1	0.35	50	4	A405
CBN-EHB2005-1	●	0.25	1	0.5	50	4	A147
HGOB2005-PN	●	0.25	1.3	1	50	4	A104
CBN-EPSB2005-1.5-S	●	0.25	1.5	0.3	50	4	A151
CBN-EPSB2005-1.5-F	●	0.25	1.5	0.3	50	4	A151
EPDBEH2005F-1.5-TH3	●	0.25	1.5	0.35	38	4	A56
EPSBE2005-1.5-TH	●	0.25	1.5	0.35	45	4	A97
EPSB2005-1.5-N-TH	●	0.25	1.5	0.35	45	4	A155
EPDBEH2005-1.5-TH3	●	0.25	1.5	0.35	50	4	A59
EPDBE2005-1.5-ATH	●	0.25	1.5	0.35	50	4	A72
EPDBE2005-1.5-PN	●	0.25	1.5	0.35	50	4	A75
CBN-EHB2005-1.5	●	0.25	1.5	0.5	50	4	A147
HYPB2005-C	●	0.25	1.6	0.6	50	6	A156
EPDBEH2005F-2-TH3	●	0.25	2	0.35	38	4	A56
EPDBEH2005-2-TH3	●	0.25	2	0.35	50	4	A59
EPDBE2005-2-ATH	●	0.25	2	0.35	50	4	A72
EPDBE2005-2-PN	●	0.25	2	0.35	50	4	A75
EPDB2005-2-SD	●	0.25	2	0.35	50	4	A140
EPDB2005-2	□	0.25	2	0.35	50	4	A405
EPDB2005-2-TH	□	0.25	2	0.35	50	4	A405
EPDBEH2005F-2.5-TH3	●	0.25	2.5	0.35	38	4	A56
EPDBEH2005-2.5-TH3	●	0.25	2.5	0.35	50	4	A59
EPDBE2005-2.5-ATH	●	0.25	2.5	0.35	50	4	A72
EPDBE2005-2.5-PN	●	0.25	2.5	0.35	50	4	A75
CBN-EHB2005-2.5	●	0.25	2.5	0.5	50	4	A147
HPBLN2005-C	●	0.25	2.5	0.6	60	6	A157
CBN-EPSB2005-3-S	●	0.25	3	0.3	50	4	A151
CBN-EPSB2005-3-F	●	0.25	3	0.3	50	4	A151
EPDBEH2005F-3-TH3	●	0.25	3	0.35	38	4	A56
EPSBE2005-3-TH	●	0.25	3	0.35	45	4	A97
EPDBEH2005-3-TH3	●	0.25	3	0.35	50	4	A59
EPDBE2005-3-ATH	●	0.25	3	0.35	50	4	A72

商品コード Item Code	在庫 Stock	ボール 半径 RE	首下長 Under neck length	刃長 Flute length	全長 Overall length	シャンク径 Shank dia.	ページ Page
EPDBE2005-3-PN	●	0.25	3	0.35	50	4	A75
EPDB2005-3	□	0.25	3	0.35	50	4	A405
EPDB2005-3-TH	□	0.25	3	0.35	50	4	A405
CBN-EHB2005-3	●	0.25	3	0.5	50	4	A147
EPDBEH2005F-4-TH3	●	0.25	4	0.35	38	4	A56
EPDBEH2005-4-TH3	●	0.25	4	0.35	50	4	A59
EPDBE2005-4-ATH	●	0.25	4	0.35	50	4	A72
EPDBE2005-4-PN	●	0.25	4	0.35	50	4	A75
EPDBPE2005-4-04-ATH	●	0.25	4	0.35	50	4	A84
EPDB2005-4-SD	●	0.25	4	0.35	50	4	A140
EPDBP2005-4-04-TH	△	0.25	4	0.35	50	4	A162
EPDB2005-4	□	0.25	4	0.35	50	4	A405
EPDB2005-4-TH	□	0.25	4	0.35	50	4	A405
EPDBEH2005F-5-TH3	●	0.25	5	0.35	42	4	A56
EPSBE2005-5-TH	●	0.25	5	0.35	45	4	A97
EPDBEH2005-5-TH3	●	0.25	5	0.35	50	4	A59
EPDBE2005-5-ATH	●	0.25	5	0.35	50	4	A72
EPDBE2005-5-PN	●	0.25	5	0.35	50	4	A75
EPDB2005-5	□	0.25	5	0.35	50	4	A405
EPDB2005-5-TH	□	0.25	5	0.35	50	4	A405
EPDBEH2005-5.5-TH3	●	0.25	5.5	0.35	50	4	A59
EPDBE2005-5.5-ATH	●	0.25	5.5	0.35	50	4	A72
EPDBE2005-5.5-PN	●	0.25	5.5	0.35	50	4	A75
EPDB2005-5.5	□	0.25	5.5	0.35	50	4	A405
EPDB2005-5.5-TH	□	0.25	5.5	0.35	50	4	A405
EPDBEH2005-6-TH3	●	0.25	6	0.35	50	4	A59
EPDBE2005-6-ATH	●	0.25	6	0.35	50	4	A72
EPDBE2005-6-PN	●	0.25					

Quick dimension reference table by mill diameter

外径別寸法早見表

超硬エンドミル・ボール

RE0.3 ~ RE0.5 Carbide End Mills -Ball

単位 unit : mm

商品コード Item Code	在庫 Stock	ボール 半径 RE	首下長 Under neck length	刃長 Flute length	全長 Overall length	シャンク径 Shank dia.	ページ Page
EPDBE2006-1-PN	●	0.3	1	0.4	50	4	A75
EPDB2006-1	□	0.3	1	0.4	50	4	A405
EPDB2006-1-TH	□	0.3	1	0.4	50	4	A405
CBN-EHB2006-1	●	0.3	1	0.55	50	4	A147
CBN-EPDB2006-1.5-S	●	0.3	1.5	0.36	50	4	A151
CBN-EPDB2006-1.5-F	●	0.3	1.5	0.36	50	4	A151
EPDBEH2006F-1.5-TH3	●	0.3	1.5	0.4	35	4	A56
EPDBEH2006-1.5-TH3	●	0.3	1.5	0.4	50	4	A59
CBN-EHB2006-1.5	●	0.3	1.5	0.55	50	4	A147
HGOB2006-PN	●	0.3	1.5	1.2	50	4	A104
HYPB2006-C	●	0.3	1.7	0.7	50	6	A156
EPSBE2006-1.8-TH	●	0.3	1.8	0.4	45	4	A97
EPDB2006-1.8-N-TH	●	0.3	1.8	0.4	45	4	A155
EPDBEH2006F-2-TH3	●	0.3	2	0.4	38	4	A56
EPDBEH2006-2-TH3	●	0.3	2	0.4	50	4	A59
EPDBE2006-2-ATH	●	0.3	2	0.4	50	4	A72
EPDBE2006-2-PN	●	0.3	2	0.4	50	4	A75
EPDBPE2006-2-04-ATH	●	0.3	2	0.4	50	4	A84
EPDB2006-2-SD	●	0.3	2	0.4	50	4	A140
EPDBP2006-2-04-TH	△	0.3	2	0.4	50	4	A162
EPDB2006-2	□	0.3	2	0.4	50	4	A405
EPDB2006-2-TH	□	0.3	2	0.4	50	4	A405
PCDB0006	□	0.3	2.1	0.45	40	4	A146
EPDBEH2006F-2.5-TH3	●	0.3	2.5	0.4	38	4	A56
EPDBEH2006-2.5-TH3	●	0.3	2.5	0.4	50	4	A59
EPDBE2006-2.5-ATH	●	0.3	2.5	0.4	50	4	A72
EPDBE2006-2.5-PN	●	0.3	2.5	0.4	50	4	A75
CBN-EPDB2006-3-S	●	0.3	3	0.36	50	4	A151
CBN-EPDB2006-3-F	●	0.3	3	0.36	50	4	A151
EPDBEH2006F-3-TH3	●	0.3	3	0.4	38	4	A56
EPDBEH2006-3-TH	●	0.3	3	0.4	45	4	A97
EPDBEH2006-3-TH3	●	0.3	3	0.4	50	4	A59
EPDBE2006-3-ATH	●	0.3	3	0.4	50	4	A72
EPDBE2006-3-PN	●	0.3	3	0.4	50	4	A75
EPDB2006-3	□	0.3	3	0.4	50	4	A405
EPDB2006-3-TH	□	0.3	3	0.4	50	4	A405
CBN-EHB2006-3	●	0.3	3	0.55	50	4	A147
HPBLN2006-C	●	0.3	3	0.7	60	6	A157
EPDBEH2006F-3.5-TH3	●	0.3	3.5	0.4	38	4	A56
EPDBEH2006-3.5-TH3	●	0.3	3.5	0.4	50	4	A59
EPDBE2006-3.5-ATH	●	0.3	3.5	0.4	50	4	A72
EPDBE2006-3.5-PN	●	0.3	3.5	0.4	50	4	A75
EPDBEH2006F-4-TH3	●	0.3	4	0.4	38	4	A56
EPDBEH2006-4-TH3	●	0.3	4	0.4	50	4	A59
EPDBE2006-4-ATH	●	0.3	4	0.4	50	4	A72
EPDBE2006-4-PN	●	0.3	4	0.4	50	4	A75
EPDBPE2006-4-04-ATH	●	0.3	4	0.4	50	4	A84
EPDBPE2006-4-09-ATH	●	0.3	4	0.4	50	4	A85
EPDBPE2006-4-14-ATH	●	0.3	4	0.4	50	4	A85
EPDB2006-4-SD	●	0.3	4	0.4	50	4	A140
EPDBP2006-4-04-TH	△	0.3	4	0.4	50	4	A162
EPDB2006-4	□	0.3	4	0.4	50	4	A405
EPDB2006-4-TH	□	0.3	4	0.4	50	4	A405
EB4HR0060TN-4-05-ATH	●	0.3	4	3.2	50	4	A132
EB4HR0060TN-4-10-ATH	●	0.3	4	3.2	50	4	A132
EPDBEH2006-4.5-TH3	●	0.3	4.5	0.4	50	4	A59
EPDBE2006-4.5-ATH	●	0.3	4.5	0.4	50	4	A72
EPDBE2006-4.5-PN	●	0.3	4.5	0.4	50	4	A75
EPDBEH2006F-5-TH3	●	0.3	5	0.4	42	4	A56
EPSBE2006-5-TH	●	0.3	5	0.4	45	4	A97
EPDBEH2006-5-TH3	●	0.3	5	0.4	50	4	A59
EPDBE2006-5-ATH	●	0.3	5	0.4	50	4	A72
EPDBE2006-5-PN	●	0.3	5	0.4	50	4	A75
EPDBPE2006-5-14-ATH	●	0.3	5	0.4	50	4	A85
EPDB2006-5	□	0.3	5	0.4	50	4	A405
EPDB2006-5-TH	□	0.3	5	0.4	50	4	A405
EGDB2006-5-HD	●	0.3	5	0.9	60	4	A143
EB4HR0060TN-5-05-ATH	●	0.3	5	3.2	50	4	A132
EB4HR0060TN-5-10-ATH	●	0.3	5	3.2	50	4	A132

商品コード Item Code	在庫 Stock	ボール 半径 RE	首下長 Under neck length	刃長 Flute length	全長 Overall length	シャンク径 Shank dia.	ページ Page
EPDBEH2006-5.5-TH3	●	0.3	5.5	0.4	50	4	A59
EPDBE2006-5.5-ATH	●	0.3	5.5	0.4	50	4	A72
EPDBE2006-5.5-PN	●	0.3	5.5	0.4	50	4	A75
EPDBEH2006F-6-TH3	●	0.3	6	0.4	42	4	A56
EPSBE2006-6-TH	●	0.3	6	0.4	45	4	A97
EPDBEH2006-6-TH3	●	0.3	6	0.4	50	4	A59
EPDBE2006-6-ATH	●	0.3	6	0.4	50	4	A72
EPDBE2006-6-PN	●	0.3	6	0.4	50	4	A75
EPDBPE2006-6-04-ATH	●	0.3	6	0.4	50	4	A84
EPDBPE2006-6-09-ATH	●	0.3	6	0.4	50	4	A85
EPDBPE2006-6-14-ATH	●	0.3	6	0.4	50	4	A85
EPDBPE2006-6-29-ATH	●	0.3	6	0.4	50	4	A85
EPDB2006-6-SD	●	0.3	6	0.4	50	4	A140
EPDBP2006-6-04-TH	△	0.3	6	0.4	50	4	A162
EPDBP2006-6-09-TH	△	0.3	6	0.4	50	4	A162
EPDB2006-6	□	0.3	6	0.4	50	4	A405
EPDB2006-6-TH	□	0.3	6	0.4	50	4	A405
DEB2006-6-C	□	0.3	6	1.2	55	4	A448
EB4HR0060TN-6-05-ATH	●	0.3	6	3.2	50	4	A132
EB4HR0060TN-6-10-ATH	●	0.3	6	3.2	50	4	A132
EPDBEH2006-7-TH3	●	0.3	7	0.4	50	4	A59
EPDBE2006-7-ATH	●	0.3	7	0.4	50	4	A72
EPDBE2006-7-PN	●	0.3	7	0.4	50	4	A75
EPDB2006-7	□	0.3	7	0.4	50	4	A405
EPDB2006-7-TH	□	0.3	7	0.4	50	4	A405
EB4HR0060TN-7-05-ATH	●	0.3	7	3.2	50	4	A132
EB4HR0060TN-7-10-ATH	●	0.3	7	3.2	50	4	A132
EPDBEH2006-8-TH3	●	0.3	8	0.4	50	4	A59
EPDBE2006-8-ATH	●	0.3	8	0.4	50	4	A72
EPDBE2006-8-PN	●	0.3	8	0.4	50	4	A75
EPDBPE2006-8-04-ATH	●	0.3	8	0.4	50	4	A84
EPDBPE2006-8-09-ATH	●	0.3	8	0.4	50	4	A85
EPDBPE2006-8-14-ATH	●	0.3	8	0.4	50	4	A85
EPDBPE2006-8-29-ATH	●	0.3	8	0.4	50	4	A85
EPDBP2006-8-09-TH	△	0.3	8	0.4	50	4	A162
EPDB2006-8	□	0.3	8	0.4	50	4	A405
EPDB2006-8-TH	□	0.3	8	0.4	50	4	A405
EB4HR0060TN-8-05-ATH	●	0.3	8	3.2	50	4	A132
EB4HR0060TN-8-10-ATH	●	0.3	8	3.2	50	4	A132
EPDBEH2006-9-TH3	●	0.3	9	0.4	50	4	A59
EPDBE2006-9-ATH	●	0.3	9	0.4	50	4	A72
EPDBE2006-9-PN	●	0.3	9	0.4	50	4	A75
EPDB2006-9	□	0.3	9	0.4	50	4	A405
EPDB2006-9-TH	□	0.3	9	0.4	50	4	A405
EB4HR0060TN-9-05-ATH	●	0.3	9	3.2	50	4	A132
EB4HR0060TN-9-10-ATH	●	0.3	9	3.2	50	4	A132
EPDBEH2006-10-TH3	●	0.3	10	0.4	50	4	A59
EPDBE2006-10-ATH	●	0.3	10	0.4	50	4	A72
EPDBE2006-10-PN	●	0.3	10	0.4	50	4	A75
EPDBPE2006-10-04-ATH	●	0.3	10	0.4	50	4	A84
EPDBPE2006-10-09-ATH	●	0.3	10	0.4	50	4	A85
EPDBPE2006-10-14-ATH	●	0.3	10	0.4	50	4	A85
EPDBP2006-10-04-TH	△	0.3	10	0.4	50	4	A162
EPDBP2006-10-09-TH	△	0.3	10	0.4	50	4	A162
EPDB2006-10	□	0.3	10	0.4	50	4	A405
EPDB2006-10-TH	□	0.3	10	0.4	50	4	A405
EGDB2006-10-HD	●	0.3	10	0.9	60	4	A143
EB4HR0060TN-10-05-ATH	●	0.3	10	3.2	50	4	A132
EB4HR0060TN-10-10-ATH	●	0.3	10	3.2	50	4	A132
EPDBEH2006-12-TH3	●	0.3	12	0.4	50	4	A59
EPDBE2006-12-ATH	●	0.3	12	0.4	50	4	A72
EPDBE2006-12-PN	●	0.3	12	0.4	50	4	A75
EPDB2006-12	□	0.3	12	0.4	50	4	A405
EPDB2006-12-TH	□	0.3	12	0.4	50	4	A405
EPDBPE2006-12-04-ATH	●	0.3	12	0.4	55	4	A84
EPDBPE2006-12-09-ATH	●	0.3	12	0.4	55	4	A85
EPDBPE2006-12-29-ATH	●	0.3	12	0.4	55	4	A85
EPDBP2006-12-09-TH	△	0.3	12	0.4	55	4	A162
EPDBPE2006-15-04-ATH	●	0.3	15	0.4	55	4	A84

商品コード Item Code	在庫 Stock	ボール 半径 RE	首下長 Under neck length	刃長 Flute length	全長 Overall length	シャンク径 Shank dia.	ページ Page
EPDBPE2006-15-09-ATH	●	0.3	15	0.4	55	4	A85
EPDBP2006-15-04-TH	△	0.3	15	0.4	55	4	A162
EPDBP2006-15-09-TH	△	0.3	15	0.4	55	4	A162
EGDB2006-15-HD	●	0.3	15	0.9	60	4	A143
EPDBPE2006-20-14-ATH	●	0.3	20	0.4	60	4	A85
EPDBPE2006-20-29-ATH	●	0.3	20	0.4	60	4	A85
EGDB2006-20-HD	●	0.3	20	0.9	60	4	A143
EPSB2006-H-TH	●	0.3	-	0.4	45	4	A154
EPSB2006-N-TH	●	0.3	-	0.4	45	4	A154
BESS2006	□	0.3	-	0.9	50	3	A421
BEK2006	●	0.3	-	1.2	50	3	A161
BEK2006-C	□	0.3	-	1.2	50	3	A415
EPDBEH2007F-0.45-TH3	●	0.35	0.45	0.45	35	4	A63
EPDBEH2007-0.45-TH3	●	0.35	0.45	0.45	50	4	A63
EPDBEH2007F-2-TH3	●	0.35	2	0.45	38	4	A57
EPDBEH2007-2-TH3	●	0.35	2	0.45	50	4	A59
EPDBE2007-2-ATH	●	0.35	2	0.45	50	4	A73
EPDBE2007-2-PN	●	0.35	2	0.45	50	4	A76
EPDBEH2007F-4-TH3	●	0.35	4	0.45	38	4	A57
EPDBEH2007-4-TH3	●	0.35	4	0.45	50	4	A59
EPDBE2007-4-ATH	●	0.35	4	0.45	50	4	A73
EPDBE2007-4-PN	●	0.35	4	0.45	50	4	A76
EB4HR0070TN-4-05-ATH	●	0.35	4	3.2	50	4	A132
EB4HR0070TN-4-10-ATH	●	0.35	4	3.2	50	4	A132
EB4HR0070TN-5-05-ATH	●	0.35	5	3.2	50	4	A132
EB4HR0070TN-5-10-ATH	●	0.35	5				

単位 unit : mm

商品コード Item Code	在庫 Stock	ボール 半径 RE	首下長 Under neck length	刃長 Flute length	全長 Overall length	シャンク径 Shank dia.	ページ Page
EPDBEH2008-3-TH3	●	0.4	3	0.5	50	4	A59
EPDBEH2008F-4-TH3	●	0.4	4	0.5	38	4	A57
EPDBEH2008-4-TH3	●	0.4	4	0.5	50	4	A59
EPDBE2008-4-ATH	●	0.4	4	0.5	50	4	A73
EPDBE2008-4-PN	●	0.4	4	0.5	50	4	A76
EPDBPE2008-4-04-ATH	●	0.4	4	0.5	50	4	A85
EPDB2008-4-SD	●	0.4	4	0.5	50	4	A140
EPDBP2008-4-04-TH	△	0.4	4	0.5	50	4	A162
EPDB2008-4	□	0.4	4	0.5	50	4	A405
EPDB2008-4-TH	□	0.4	4	0.5	50	4	A405
CBN-EHB2008-4	●	0.4	4	0.7	50	4	A147
HPBLN2008-C	●	0.4	4	1	60	6	A157
EB4HR0080TN-4-05-ATH	●	0.4	4	3.2	50	4	A132
EB4HR0080TN-4-10-ATH	●	0.4	4	3.2	50	4	A132
CBN-EPBS2008-5-S	●	0.4	5	0.48	50	4	A151
CBN-EPBS2008-5-F	●	0.4	5	0.48	50	4	A151
EPDBEH2008F-5-TH3	●	0.4	5	0.5	42	4	A57
EPDBEH2008-5-TH3	●	0.4	5	0.5	50	4	A59
EPDBE2008-5-ATH	●	0.4	5	0.5	50	4	A73
EPDBE2008-5-PN	●	0.4	5	0.5	50	4	A76
EPDB2008-5	□	0.4	5	0.5	50	4	A405
EPDB2008-5-TH	□	0.4	5	0.5	50	4	A405
EPDBEH2008F-6-TH3	●	0.4	6	0.5	42	4	A57
EPDBEH2008-6-TH3	●	0.4	6	0.5	50	4	A59
EPDBE2008-6-ATH	●	0.4	6	0.5	50	4	A73
EPDBE2008-6-PN	●	0.4	6	0.5	50	4	A76
EPDBPE2008-6-04-ATH	●	0.4	6	0.5	50	4	A85
EPDB2008-6-SD	●	0.4	6	0.5	50	4	A140
EPDBP2008-6-04-TH	△	0.4	6	0.5	50	4	A162
EPDB2008-6	□	0.4	6	0.5	50	4	A405
EPDB2008-6-TH	□	0.4	6	0.5	50	4	A405
DEB2008-6-C	□	0.4	6	1.2	55	4	A448
EB4HR0080TN-6-05-ATH	●	0.4	6	3.2	50	4	A132
EB4HR0080TN-6-10-ATH	●	0.4	6	3.2	50	4	A132
EPDBEH2008F-8-TH3	●	0.4	8	0.5	42	4	A57
EPDBEH2008-8-TH3	●	0.4	8	0.5	50	4	A59
EPDBE2008-8-ATH	●	0.4	8	0.5	50	4	A73
EPDBE2008-8-PN	●	0.4	8	0.5	50	4	A76
EPDBPE2008-8-04-ATH	●	0.4	8	0.5	50	4	A85
EPDBPE2008-8-09-ATH	●	0.4	8	0.5	50	4	A85
EPDB2008-8-SD	●	0.4	8	0.5	50	4	A140
EPDBP2008-8-09-TH	△	0.4	8	0.5	50	4	A162
EPDB2008-8	□	0.4	8	0.5	50	4	A405
EPDB2008-8-TH	□	0.4	8	0.5	50	4	A405
DEB2008-8-C	□	0.4	8	1.2	55	4	A448
EB4HR0080TN-8-05-ATH	●	0.4	8	3.2	50	4	A132
EB4HR0080TN-8-10-ATH	●	0.4	8	3.2	50	4	A132
EPDBEH2008-10-TH3	●	0.4	10	0.5	50	4	A59
EPDBE2008-10-ATH	●	0.4	10	0.5	50	4	A73
EPDBE2008-10-PN	●	0.4	10	0.5	50	4	A76
EPDB2008-10	□	0.4	10	0.5	50	4	A405
EPDB2008-10-TH	□	0.4	10	0.5	50	4	A405
EB4HR0080TN-10-05-ATH	●	0.4	10	3.2	50	4	A132
EB4HR0080TN-10-10-ATH	●	0.4	10	3.2	50	4	A132
EPDBEH2008-12-TH3	●	0.4	12	0.5	50	4	A59
EPDBPE2008-12-04-ATH	●	0.4	12	0.5	55	4	A85
EPDBPE2008-12-09-ATH	●	0.4	12	0.5	55	4	A85
EPDBP2008-12-09-TH	△	0.4	12	0.5	55	4	A162
EB4HR0080TN-12-05-ATH	●	0.4	12	3.2	55	4	A132
EB4HR0080TN-12-10-ATH	●	0.4	12	3.2	55	4	A132
EB4HR0080TN-14-05-ATH	●	0.4	14	3.2	55	4	A132
EB4HR0080TN-14-10-ATH	●	0.4	14	3.2	55	4	A132
EPDBPE2008-16-09-ATH	●	0.4	16	0.5	55	4	A85
EPDBPE2008-16-29-ATH	●	0.4	16	0.5	55	4	A85
EPDBP2008-16-09-TH	△	0.4	16	0.5	55	4	A162
EPDBP2008-20-29-ATH	△	0.4	20	0.5	60	4	A85
EPSB2008-H-TH	●	0.4	-	0.5	45	4	A154
EPSB2008-N-TH	●	0.4	-	0.5	45	4	A154
BESS2008	□	0.4	-	1.2	50	3	A421

商品コード Item Code	在庫 Stock	ボール 半径 RE	首下長 Under neck length	刃長 Flute length	全長 Overall length	シャンク径 Shank dia.	ページ Page
BEK2008	●	0.4	-	1.6	50	3	A161
BEK2008-C	□	0.4	-	1.6	50	3	A415
ECRB0809-6-PN	●	0.4	-	6	60	4	A137
ECRB0810-6-PN	●	0.4	-	6	60	4	A137
ECRB0809-8-PN	●	0.4	-	8	60	4	A137
ECRB0810-8-PN	●	0.4	-	8	60	4	A137
ECRB0810-10-PN	●	0.4	-	10	60	4	A137
ECRB0809-10-PN	●	0.4	-	10	60	4	A137
ECRB0809-12-PN	●	0.4	-	12	60	4	A137
ECRB0810-12-PN	●	0.4	-	12	60	4	A137
EPDBEH2009F-0.6-TH3	●	0.45	0.6	0.6	35	4	A63
EPDBEH2009-0.6-TH3	●	0.45	0.6	0.6	50	4	A63
EPDBEH2009F-2-TH3	●	0.45	2	0.6	35	4	A57
EPDBEH2009-2-TH3	●	0.45	2	0.6	50	4	A59
EPDBE2009-2-ATH	●	0.45	2	0.6	50	4	A73
EPDBE2009-2-PN	●	0.45	2	0.6	50	4	A76
EPDBEH2009F-4-TH3	●	0.45	4	0.6	38	4	A57
EPDBEH2009-4-TH3	●	0.45	4	0.6	50	4	A59
EPDBE2009-4-ATH	●	0.45	4	0.6	50	4	A73
EPDBE2009-4-PN	●	0.45	4	0.6	50	4	A76
EPDBPE2009-4-04-ATH	●	0.45	4	0.6	50	4	A85
EPDBP2009-4-04-TH	△	0.45	4	0.6	50	4	A163
EB4HR0090TN-4-05-ATH	●	0.45	4	3.2	50	4	A132
EB4HR0090TN-4-10-ATH	●	0.45	4	3.2	50	4	A132
EPDBEH2009F-6-TH3	●	0.45	6	0.6	42	4	A57
EPDBEH2009-6-TH3	●	0.45	6	0.6	50	4	A59
EPDBE2009-6-ATH	●	0.45	6	0.6	50	4	A73
EPDBE2009-6-PN	●	0.45	6	0.6	50	4	A76
EB4HR0090TN-6-05-ATH	●	0.45	6	3.2	50	4	A132
EB4HR0090TN-6-10-ATH	●	0.45	6	3.2	50	4	A132
EPDBEH2009F-8-TH3	●	0.45	8	0.6	50	4	A59
EPDBE2009-8-ATH	●	0.45	8	0.6	50	4	A73
EPDBE2009-8-PN	●	0.45	8	0.6	50	4	A76
EPDBPE2009-8-04-ATH	●	0.45	8	0.6	55	4	A85
EPDBP2009-8-04-TH	△	0.45	8	0.6	55	4	A163
EB4HR0090TN-8-05-ATH	●	0.45	8	3.2	50	4	A132
EB4HR0090TN-8-10-ATH	●	0.45	8	3.2	50	4	A132
EB4HR0090TN-10-05-ATH	●	0.45	10	3.2	50	4	A132
EB4HR0090TN-10-10-ATH	●	0.45	10	3.2	50	4	A132
EPDBPE2009-12-04-ATH	●	0.45	12	0.6	55	4	A85
EPDBP2009-12-04-TH	△	0.45	12	0.6	55	4	A163
EB4HR0090TN-12-05-ATH	●	0.45	12	3.2	55	4	A132
EB4HR0090TN-12-10-ATH	●	0.45	12	3.2	55	4	A132
EB4HR0090TN-14-05-ATH	●	0.45	14	3.2	55	4	A132
EB4HR0090TN-14-10-ATH	●	0.45	14	3.2	55	4	A132
EPDBPE2009-16-04-ATH	●	0.45	16	0.6	60	4	A85
EPDBP2009-16-04-TH	△	0.45	16	0.6	60	4	A163
EPDBPE2009-18-04-ATH	●	0.45	18	0.6	65	4	A85
EPDBP2009-18-04-TH	△	0.45	18	0.6	65	4	A163
EPDBPE2009-20-04-ATH	●	0.45	20	0.6	65	4	A85
EPDBP2009-20-04-TH	△	0.45	20	0.6	65	4	A163
EPDBPE2009-22-04-ATH	●	0.45	22	0.6	65	4	A85
EPDBP2009-22-04-TH	△	0.45	22	0.6	65	4	A163
EPDBPE2009-24-04-ATH	●	0.45	24	0.6	70	4	A85
EPDBP2009-24-04-TH	△	0.45	24	0.6	70	4	A163
BESS2009	□	0.45	-	1.3	50	3	A421
EPDBEH2010F-0.8-TH3	●	0.5	0.8	0.8	35	4	A63
EPDBEH2010-0.8-TH3	●	0.5	0.8	0.8	50	4	A63
EPDBEH2010F-1.5-TH3	●	0.5	1.5	0.8	35	4	A57
EPDBEH2010-1.5-TH3	●	0.5	1.5	0.8	45	6	A97
EPSB2010-1.5-H-TH	●	0.5	1.5	0.8	45	6	A98
EPSB2010-H-TH	●	0.5	1.5	0.8	45	6	A154
EPSB2010-N-TH	●	0.5	1.5	0.8	45	6	A154
EPDBEH2010-1.5-TH3	●	0.5	1.5	0.8	50	4	A60
CBN-EHB2010-1.5	●	0.5	1.5	1	50	4	A147
EPDBEH2010F-2-TH3	●	0.5	2	0.8	35	4	A57
EPDBEH2010-2-TH3	●	0.5	2	0.8	50	4	A60
EPDBE2010-2-ATH	●	0.5	2	0.8	50	4	A73
EPDBE2010-2-PN	●	0.5	2	0.8	50	4	A76

商品コード Item Code	在庫 Stock	ボール 半径 RE	首下長 Under neck length	刃長 Flute length	全長 Overall length	シャンク径 Shank dia.	ページ Page
EPDB2010-2	□	0.5	2	0.8	50	4	A405
EPDB2010-2-TH	□	0.5	2	0.8	50	4	A405
EPDBEH2010-2-S6-TH3	●	0.5	2	0.8	50	6	A60
HPBS2010-C	●	0.5	2	1.3	50	6	A156
EFB2010	●	0.5	2.2	1	50	4	A153
BHB2010	□	0.5	2.5	0.5	60	6	A456
CBN-EPBS2010-2.5-S	●	0.5	2.5	0.6	50	4	A151
CBN-EPBS2010-2.5-F	●	0.5	2.5	0.6	50	4	A151
EPDBEH2010F-2.5-TH3	●	0.5	2.5	0.8	38	4	A57
EPDBEH2010-2.5-TH3	●	0.5	2.5	0.8	50	4	A60
ESHB2010-H-TH	●	0.5	2.5	1	40	4	A108
ESHB2010-N-TH	●	0.5	2.5	1	40	4	A108
CBN-EHB2010-2.5	●	0.5	2.5	1	50	4	A147
EPBT2010	●	0.5	2.5	1.5	50	4	A102
PCDB0010	□	0.5	3	0.65	40	4	A146
EPDBEH2010F-3-TH3	●	0.5	3	0.8	38	4	A57
EPSBE2010-3-TH	●	0.5	3	0.8	45	6	A97
EPSB2010-3-N-TH	●	0.5	3	0.8	45	6	A155
EPDBEH2010-3-TH3	●	0.5	3	0.8	50	4	A60
EPDBE2010-3-ATH	●	0.5	3	0.8	50	4	A73
EPDBE2010-3-PN	●	0.5	3	0.8	50	4	A76
EPDB2010-3	□	0.5	3	0.8	50	4	A405
EPDB2010-3-TH	□	0.5	3	0.8	50	4	A405
EPDBEH2010-3-S6-TH3	●	0.5	3	0.8	50	6	A60
EMBE3010-S4-ATH	●	0.5	3	1.5	50	4	A110
EHHBE4010-S4-TH3	●	0.5	3	1.5	50	4	A124
EHHB4010-S4-ATH	●	0.5	3	1.5	50	4	A127
EMBE3010-S6-ATH	●	0.5	3	1.5	50	6	A110
EHHBE4010-S6-							

外径別寸法早見表

超硬エンドミル・ボール

RE0.5 ~ RE0.75 Carbide End Mills -Ball

単位 unit : mm

商品コード Item Code	在庫 Stock	ボール 径 RE	首下長 Under neck length	刃長 Flute length	全長 Overall length	シャンク径 Shank dia.	ページ Page
EPDBEH2010-7-TH3	●	0.5	7	0.8	50	4	A60
EPDBE2010-7-ATH	●	0.5	7	0.8	50	4	A73
EPDBE2010-7-PN	●	0.5	7	0.8	50	4	A76
EPDB2010-7	□	0.5	7	0.8	50	4	A405
EPDB2010-7-TH	□	0.5	7	0.8	50	4	A405
EPDBEH2010F-8-TH3	●	0.5	8	0.8	42	4	A57
EPSBE2010-8-TH	●	0.5	8	0.8	45	6	A97
EPDBEH2010-8-TH3	●	0.5	8	0.8	50	4	A60
EPDBE2010-8-ATH	●	0.5	8	0.8	50	4	A73
EPDBE2010-8-PN	●	0.5	8	0.8	50	4	A76
EPDB2010-8-SD	●	0.5	8	0.8	50	4	A140
EPDB2010-8	□	0.5	8	0.8	50	4	A405
EPDB2010-8-TH	□	0.5	8	0.8	50	4	A405
EPDBEH2010-8-S6-TH3	●	0.5	8	0.8	50	6	A60
EPDBPE2010-8-04-ATH	●	0.5	8	0.8	55	6	A85
EMBPE3010-8-09-ATH	●	0.5	8	0.8	55	6	A111
EPDBP2010-8-04-TH	△	0.5	8	0.8	55	6	A163
DEB2010-8-C	□	0.5	8	1.5	55	4	A448
EB4HR0100TN-8-05-ATH	●	0.5	8	4	50	4	A133
EB4HR0100TN-8-10-ATH	●	0.5	8	4	50	4	A133
EPDBEH2010-9-TH3	●	0.5	9	0.8	50	4	A60
EPDBE2010-9-ATH	●	0.5	9	0.8	50	4	A73
EPDBE2010-9-PN	●	0.5	9	0.8	50	4	A76
EPDB2010-9	□	0.5	9	0.8	50	4	A405
EPDB2010-9-TH	□	0.5	9	0.8	50	4	A405
CBN-EPSP2010-10-S	●	0.5	10	0.6	50	4	A151
CBN-EPSP2010-10-F	●	0.5	10	0.6	50	4	A151
EPDBEH2010F-10-TH3	●	0.5	10	0.8	45	4	A57
EPDBEH2010-10-TH3	●	0.5	10	0.8	50	4	A60
EPDBE2010-10-ATH	●	0.5	10	0.8	50	4	A73
EPDBE2010-10-PN	●	0.5	10	0.8	50	4	A76
EPDB2010-10	□	0.5	10	0.8	50	4	A405
EPDB2010-10-TH	□	0.5	10	0.8	50	4	A405
EPDBEH2010-10-S6-TH3	●	0.5	10	0.8	50	6	A60
EPSBE2010-10-TH	●	0.5	10	0.8	50	6	A97
EPDBPE2010-10-04-ATH	●	0.5	10	0.8	55	6	A85
EPDBPE2010-10-09-ATH	●	0.5	10	0.8	55	6	A85
EPDBPE2010-10-29-ATH	●	0.5	10	0.8	55	6	A86
EMBPE3010-10-09-ATH	●	0.5	10	0.8	55	6	A111
EPDBP2010-10-04-TH	△	0.5	10	0.8	55	6	A163
EPDBP2010-10-09-TH	△	0.5	10	0.8	55	6	A163
EGDB2010-10-HD	●	0.5	10	1.5	60	4	A143
EB4HR0100TN-10-05-ATH	●	0.5	10	4	50	4	A133
EB4HR0100TN-10-10-ATH	●	0.5	10	4	50	4	A133
EPDBEH2010F-12-TH3	●	0.5	12	0.8	45	4	A57
EPDBEH2010-12-TH3	●	0.5	12	0.8	55	4	A60
EPDBE2010-12-ATH	●	0.5	12	0.8	55	4	A73
EPDBE2010-12-PN	●	0.5	12	0.8	55	4	A76
EPDB2010-12-SD	●	0.5	12	0.8	55	4	A140
EPDB2010-12	□	0.5	12	0.8	55	4	A405
EPDB2010-12-TH	□	0.5	12	0.8	55	4	A405
EPDBPE2010-12-14-ATH	●	0.5	12	0.8	60	6	A86
EMBPE3010-12-09-ATH	●	0.5	12	0.8	60	6	A111
DEB2010-12-C	□	0.5	12	1.5	55	4	A448
EB4HR0100TN-12-05-ATH	●	0.5	12	4	55	4	A133
EB4HR0100TN-12-10-ATH	●	0.5	12	4	55	4	A133
EPDBEH2010-13-TH3	●	0.5	13	0.8	55	4	A60
EPDBE2010-13-ATH	●	0.5	13	0.8	55	4	A73
EPDBE2010-13-PN	●	0.5	13	0.8	55	4	A76
EPDBEH2010-14-TH3	●	0.5	14	0.8	55	4	A60
EPDBE2010-14-ATH	●	0.5	14	0.8	55	4	A73
EPDBE2010-14-PN	●	0.5	14	0.8	55	4	A76
EPDB2010-14	□	0.5	14	0.8	55	4	A405
EPDBE2010-14-TH	□	0.5	14	0.8	55	4	A405
EMBPE3010-14-09-ATH	●	0.5	14	0.8	60	6	A111
EB4HR0100TN-14-05-ATH	●	0.5	14	4	55	4	A133
EB4HR0100TN-14-10-ATH	●	0.5	14	4	55	4	A133
EPDBPE2010-15-04-ATH	●	0.5	15	0.8	60	6	A85
EPDBPE2010-15-09-ATH	●	0.5	15	0.8	60	6	A85

商品コード Item Code	在庫 Stock	ボール 径 RE	首下長 Under neck length	刃長 Flute length	全長 Overall length	シャンク径 Shank dia.	ページ Page
EPDBPE2010-15-29-ATH	●	0.5	15	0.8	60	6	A86
EPDBP2010-15-09-TH	△	0.5	15	0.8	60	6	A163
EPDBEH2010-16-TH3	●	0.5	16	0.8	55	4	A60
EPDBE2010-16-ATH	●	0.5	16	0.8	55	4	A73
EPDBE2010-16-PN	●	0.5	16	0.8	55	4	A76
EPDB2010-16	□	0.5	16	0.8	55	4	A405
EPDB2010-16-TH	□	0.5	16	0.8	55	4	A405
EPDBPE2010-16-09-ATH	●	0.5	16	0.8	60	6	A85
EPDBPE2010-16-14-ATH	●	0.5	16	0.8	60	6	A86
EMBPE3010-16-09-ATH	●	0.5	16	0.8	60	6	A111
EB4HR0100TN-16-05-ATH	●	0.5	16	4	55	4	A133
EB4HR0100TN-16-10-ATH	●	0.5	16	4	55	4	A133
EPDBEH2010-18-TH3	●	0.5	18	0.8	60	4	A60
EPDBE2010-18-ATH	●	0.5	18	0.8	60	4	A73
EPDBE2010-18-PN	●	0.5	18	0.8	60	4	A76
EPDB2010-18	□	0.5	18	0.8	60	4	A405
EPDB2010-18-TH	□	0.5	18	0.8	60	4	A405
EMBPE3010-18-09-ATH	●	0.5	18	0.8	65	6	A111
EB4HR0100TN-18-05-ATH	●	0.5	18	4	60	4	A133
EB4HR0100TN-18-10-ATH	●	0.5	18	4	60	4	A133
EPDBEH2010-20-TH3	●	0.5	20	0.8	60	4	A60
EPDBE2010-20-ATH	●	0.5	20	0.8	60	4	A73
EPDBE2010-20-PN	●	0.5	20	0.8	60	4	A76
EPDB2010-20	□	0.5	20	0.8	60	4	A405
EPDB2010-20-TH	□	0.5	20	0.8	60	4	A405
EPDBPE2010-20-04-ATH	●	0.5	20	0.8	65	6	A85
EPDBPE2010-20-09-ATH	●	0.5	20	0.8	65	6	A85
EPDBPE2010-20-14-ATH	●	0.5	20	0.8	65	6	A86
EPDBPE2010-20-29-ATH	●	0.5	20	0.8	65	6	A86
EPDBPE2010-20-49-ATH	●	0.5	20	0.8	65	6	A86
EMBPE3010-20-09-ATH	●	0.5	20	0.8	65	6	A111
EPDBP2010-20-04-TH	△	0.5	20	0.8	65	6	A163
EPDBP2010-20-09-TH	△	0.5	20	0.8	65	6	A163
EGDB2010-20-HD	●	0.5	20	1.5	60	4	A143
EPBPN2010-15	●	0.5	20	2.5	60	6	A158
EPBPN2010-50	●	0.5	20	2.5	60	6	A158
EB4HR0100TN-20-05-ATH	●	0.5	20	4	60	4	A133
EB4HR0100TN-20-10-ATH	●	0.5	20	4	60	4	A133
EPDBPE2010-22-14-ATH	●	0.5	22	0.8	70	6	A86
EMBPE3010-22-09-ATH	●	0.5	22	0.8	70	6	A111
EMBPE3010-24-09-ATH	●	0.5	24	0.8	70	6	A111
EPDBPE2010-25-04-ATH	●	0.5	25	0.8	70	6	A85
EPDBPE2010-25-09-ATH	●	0.5	25	0.8	70	6	A85
EPDBPE2010-25-14-ATH	●	0.5	25	0.8	70	6	A86
EPDBP2010-25-09-TH	△	0.5	25	0.8	70	6	A163
EMBPE3010-26-09-ATH	●	0.5	26	0.8	70	6	A111
EMBPE3010-28-09-ATH	●	0.5	28	0.8	75	6	A111
EPDBPE2010-30-04-ATH	●	0.5	30	0.8	75	6	A85
EPDBPE2010-30-09-ATH	●	0.5	30	0.8	75	6	A85
EPDBPE2010-30-29-ATH	●	0.5	30	0.8	75	6	A86
EMBPE3010-30-09-ATH	●	0.5	30	0.8	75	6	A111
EPDBP2010-30-04-TH	△	0.5	30	0.8	75	6	A163
EPDBP2010-30-09-TH	△	0.5	30	0.8	75	6	A163
EGDB2010-30-HD	●	0.5	30	1.5	80	4	A143
EMBPE3010-32-09-ATH	●	0.5	32	0.8	80	6	A111
EMBPE3010-34-09-ATH	●	0.5	34	0.8	80	6	A111
EPDBPE2010-35-09-ATH	●	0.5	35	0.8	80	6	A85
EPDBP2010-35-09-TH	△	0.5	35	0.8	80	6	A163
EMBPE3010-36-09-ATH	●	0.5	36	0.8	80	6	A111
EPDBPE2010-40-09-ATH	●	0.5	40	0.8	85	6	A85
EPDBPE2010-40-29-ATH	●	0.5	40	0.8	85	6	A86
EPDBP2010-40-09-TH	△	0.5	40	0.8	85	6	A163
EGDB2010-40-HD	●	0.5	40	1.5	80	4	A143
EPBPN2010-50	●	0.5	40	2.5	80	6	A158
EPDBPE2010-50-04-ATH	●	0.5	50	0.8	95	6	A85
EPDBPE2010-50-09-ATH	●	0.5	50	0.8	95	6	A85
EPDBPE2010-50-14-ATH	●	0.5	50	0.8	95	6	A86
EPDBP2010-50-09-TH	△	0.5	50	0.8	95	6	A163
EPDBPE2010-50-29-ATH	●	0.5	50	0.8	130	6	A86

商品コード Item Code	在庫 Stock	ボール 径 RE	首下長 Under neck length	刃長 Flute length	全長 Overall length	シャンク径 Shank dia.	ページ Page
EPDBPE2010-60-09-ATH	●	0.5	60	0.8	105	6	A85
EPDBP2010-60-09-TH	△	0.5	60	0.8	105	6	A163
EPDBPE2010-70-04-ATH	●	0.5	70	0.8	115	6	A85
EPDBPE2010-70-09-ATH	●	0.5	70	0.8	115	6	A85
EPDBP2010-70-09-TH	△	0.5	70	0.8	115	6	A163
EPBPX2010-05	●	0.5	70	1.5	150	6	A160
EPBPX2010-10	●	0.5	70	1.5	150	6	A160
EPDBPE2010-90-14-ATH	●	0.5	90	0.8	135	6	A86
EPBPX2010-15	●	0.5	97.47	1.5	150	6	A160
CEPB2010	□	0.5	-	1.5	50	4	A411
BESS2010	□	0.5	-	1.5	50	4	A421
YB2010-CS	□	0.5	-	1.5	50	4	A422
CEPBLS2010	□	0.5	-	1.5	80	4	A411
BEK2010	□	0.5	-	2.5	50	4	A161
BEK2010-C	□	0.5	-	2.5	50	4	A415
BES2010-C	□	0.5	-	2.5	50	4	A415
BES2010	□	0.5	-	2.5	50	4	A421
BES2010M	□	0.5	-	2.5	50	4	A421
BEKLS2010-C	□	0.5	-	2.5	80	4	A415
ECRB1012-6-PN	●	0.5	-	6	60	4	A137
ECRB1012-8-PN	●	0.5	-	8	60	4	A137
ECRB1012-10-PN	●	0.5	-	10	60	4	A137
ECRB1012-12-PN	●	0.5	-	12	60	4	A137
ECRB1012-14-PN	●	0.5	-	14	60	4	A137
ECRB1012-16-PN	●	0.5	-	16	60		

単位 unit : mm

商品コード Item Code	在庫 Stock	ボール 半径 RE	首下長 Under neck length	刃長 Flute length	全長 Overall length	シャンク径 Shank dia.	ページ Page
EPDBEH2012-4-TH3	●	0.6	4	1.1	50	4	A60
EPDBE2012-4-ATH	●	0.6	4	1.1	50	4	A73
EPDBE2012-4-PN	●	0.6	4	1.1	50	4	A76
EPDBEH2012-4-S6-TH3	●	0.6	4	1.1	50	6	A60
EPDBEH2012-6-TH3	●	0.6	6	1.1	50	4	A60
HPBLN2012-C	●	0.6	6	1.5	60	6	A157
EB4HR0120TN-6-05-ATH	●	0.6	6	4.8	50	4	A133
EB4HR0120TN-6-10-ATH	●	0.6	6	4.8	50	4	A133
EPDBEH2012-8-TH3	●	0.6	8	1.1	50	4	A60
EPDBE2012-8-ATH	●	0.6	8	1.1	50	4	A73
EPDBE2012-6-ATH	●	0.6	8	1.1	50	4	A73
EPDBE2012-8-PN	●	0.6	8	1.1	50	4	A76
EPDBE2012-6-PN	●	0.6	8	1.1	50	4	A76
EPDB2012-8	□	0.6	8	1.1	50	4	A405
EPDB2012-8-TH	□	0.6	8	1.1	50	4	A405
DEB2012-8-C	□	0.6	8	1.6	55	4	A448
EB4HR0120TN-8-05-ATH	●	0.6	8	4.8	50	4	A133
EB4HR0120TN-8-10-ATH	●	0.6	8	4.8	50	4	A133
EPDBEH2012-10-TH3	●	0.6	10	1.1	50	4	A60
EPDBE2012-10-ATH	●	0.6	10	1.1	50	4	A73
EPDBE2012-10-PN	●	0.6	10	1.1	50	4	A76
EB4HR0120TN-10-05-ATH	●	0.6	10	4.8	50	4	A133
EB4HR0120TN-10-10-ATH	●	0.6	10	4.8	50	4	A133
EPDBEH2012-12-TH3	●	0.6	12	1.1	55	4	A60
EPDBE2012-12-ATH	●	0.6	12	1.1	55	4	A73
EPDBE2012-12-PN	●	0.6	12	1.1	55	4	A76
EPDB2012-12	□	0.6	12	1.1	55	4	A405
EPDB2012-12-TH	□	0.6	12	1.1	55	4	A405
DEB2012-12-C	□	0.6	12	1.6	55	4	A448
EB4HR0120TN-12-05-ATH	●	0.6	12	4.8	55	4	A133
EB4HR0120TN-12-10-ATH	●	0.6	12	4.8	55	4	A133
EB4HR0120TN-14-05-ATH	●	0.6	14	4.8	55	4	A133
EB4HR0120TN-14-10-ATH	●	0.6	14	4.8	55	4	A133
EB4HR0120TN-16-05-ATH	●	0.6	16	4.8	55	4	A133
EB4HR0120TN-16-10-ATH	●	0.6	16	4.8	55	4	A133
EB4HR0120TN-18-05-ATH	●	0.6	18	4.8	60	4	A133
EB4HR0120TN-18-10-ATH	●	0.6	18	4.8	60	4	A133
EPDBPE2012-20-29-ATH	●	0.6	20	1.1	65	6	A86
EB4HR0120TN-20-05-ATH	●	0.6	20	4.8	60	4	A133
EB4HR0120TN-20-10-ATH	●	0.6	20	4.8	60	4	A133
EB4HR0120TN-22-05-ATH	●	0.6	22	4.8	60	4	A133
EB4HR0120TN-22-10-ATH	●	0.6	22	4.8	60	4	A133
EB4HR0120TN-24-05-ATH	●	0.6	24	4.8	60	4	A133
EB4HR0120TN-24-10-ATH	●	0.6	24	4.8	60	4	A133
EPDBPE2012-35-29-ATH	●	0.6	35	1.1	80	6	A86
BESS2012	□	0.6	-	1.8	50	4	A421
BESS2013	□	0.65	-	2	50	4	A421
EPDBEH2014-3-TH3	●	0.7	3	1.3	50	4	A60
HYPB2014-C	●	0.7	3.8	1.8	50	6	A156
HPBLN2014-C	●	0.7	7	1.8	60	6	A157
EPDBEH2014-8-TH3	●	0.7	8	1.3	50	4	A60
EPDBE2014-8-ATH	●	0.7	8	1.3	50	4	A73
EPDBE2014-8-PN	●	0.7	8	1.3	50	4	A76
EPDB2014-8	□	0.7	8	1.3	50	4	A406
EPDB2014-8-TH	□	0.7	8	1.3	50	4	A406
EPDBEH2014-12-TH3	●	0.7	12	1.3	55	4	A60
EPDBE2014-12-ATH	●	0.7	12	1.3	55	4	A73
EPDBE2014-12-PN	●	0.7	12	1.3	55	4	A76
EPDB2014-12	□	0.7	12	1.3	55	4	A406
EPDB2014-12-TH	□	0.7	12	1.3	55	4	A406
DEB2014-12-C	□	0.7	12	1.6	55	4	A448
EPDBEH2014-16-TH3	●	0.7	16	1.3	55	4	A60
EPDBE2014-16-ATH	●	0.7	16	1.3	55	4	A73
EPDBE2014-16-PN	●	0.7	16	1.3	55	4	A76
EPDB2014-16	□	0.7	16	1.3	55	4	A406
EPDB2014-16-TH	□	0.7	16	1.3	55	4	A406
BESS2014	□	0.7	-	2.1	50	4	A421
EPDBEH2015F-2-TH3	●	0.75	2	1.35	35	4	A57
EPDBEH2015-2-TH3	●	0.75	2	1.35	50	4	A60

商品コード Item Code	在庫 Stock	ボール 半径 RE	首下長 Under neck length	刃長 Flute length	全長 Overall length	シャンク径 Shank dia.	ページ Page
EPSBE2015-2.25-TH	●	0.75	2.25	1.35	45	6	A97
EPSBE2015-2.25-H-TH	●	0.75	2.25	1.35	45	6	A98
EPSB2015-H-TH	●	0.75	2.25	1.35	45	6	A154
EPSB2015-N-TH	●	0.75	2.25	1.35	45	6	A154
BHB2015	□	0.75	2.5	0.75	60	6	A456
EPDBEH2015F-2.5-TH3	●	0.75	2.5	1.35	35	4	A57
EPDBEH2015-2.5-TH3	●	0.75	2.5	1.35	50	4	A60
CBN-EHB2015-2.5	●	0.75	2.5	1.35	50	4	A147
EPDBEH2015F-3-TH3	●	0.75	3	1.35	35	4	A57
EPDBEH2015-3-TH3	●	0.75	3	1.35	50	4	A60
EPDBEH2015-3-S6-TH3	●	0.75	3	1.35	50	6	A61
EFB2015	●	0.75	3	1.5	50	4	A153
EPBT2015	●	0.75	3.5	2.5	50	4	A102
ESHB2015-H-TH	●	0.75	3.75	1.5	40	4	A108
ESHB2015-N-TH	●	0.75	3.75	1.5	40	4	A108
EPDBEH2015F-4-TH3	●	0.75	4	1.35	38	4	A57
EPDBEH2015-4-TH3	●	0.75	4	1.35	50	4	A60
EPDBE2015-4-ATH	●	0.75	4	1.35	50	4	A73
EPDBE2015-4-PN	●	0.75	4	1.35	50	4	A76
EPDB2015-4	□	0.75	4	1.35	50	4	A406
EPDB2015-4-TH	□	0.75	4	1.35	50	4	A406
EPSBE2015-4.5-TH	●	0.75	4.5	1.35	45	6	A97
EPSB2015-4.5-N-TH	●	0.75	4.5	1.35	45	6	A155
EMBE3015-S4-ATH	●	0.75	4.5	2.5	50	4	A110
EHHB4015-S4-TH3	●	0.75	4.5	2.5	50	4	A124
EHHB4015-S4-ATH	●	0.75	4.5	2.5	50	4	A127
EMBE3015-S6-ATH	●	0.75	4.5	2.5	50	6	A110
EHHB4015-S6-TH3	●	0.75	4.5	2.5	50	6	A124
EHHB4015-S6-ATH	●	0.75	4.5	2.5	50	6	A127
HYPB2015-C	●	0.75	4.9	1.9	50	6	A156
CBN-EPSB2015-5-S	●	0.75	5	0.9	50	4	A151
CBN-EPSB2015-5-F	●	0.75	5	0.9	50	4	A151
EPDBEH2015F-5-TH3	●	0.75	5	1.35	38	4	A57
EPDBEH2015-5-TH3	●	0.75	5	1.35	50	4	A60
CBN-EHB2015-5	●	0.75	5	1.35	50	4	A147
EPDBEH2015-5-S6-TH3	●	0.75	5	1.35	50	6	A61
HGOB2015-PN	●	0.75	5	4	50	4	A104
EPBC2015	□	0.75	5	4	50	4	A409
EPDBEH2015F-6-TH3	●	0.75	6	1.35	38	4	A57
EPDBEH2015-6-TH3	●	0.75	6	1.35	50	4	A61
EPDBE2015-6-ATH	●	0.75	6	1.35	50	4	A73
EPDBE2015-6-PN	●	0.75	6	1.35	50	4	A76
EPDB2015-6-SD	●	0.75	6	1.35	50	4	A140
EPDB2015-6	□	0.75	6	1.35	50	4	A406
EPDB2015-6-TH	□	0.75	6	1.35	50	4	A406
CBN-EHB2015-7.5	●	0.75	7.5	1.35	50	4	A147
HPBLN2015-C	●	0.75	7.5	1.9	60	6	A157
EPDBEH2015F-8-TH3	●	0.75	8	1.35	42	4	A57
EPSBE2015-8-TH	●	0.75	8	1.35	45	6	A97
EPDBEH2015-8-TH3	●	0.75	8	1.35	50	4	A61
EPDBE2015-8-ATH	●	0.75	8	1.35	50	4	A73
EPDBE2015-8-PN	●	0.75	8	1.35	50	4	A76
EPDB2015-8	□	0.75	8	1.35	50	4	A406
EPDB2015-8-TH	□	0.75	8	1.35	50	4	A406
EPDBEH2015-8-S6-TH3	●	0.75	8	1.35	50	6	A61
EPDBPE2015-8-04-ATH	●	0.75	8	1.35	55	6	A86
EMBPE3015-8-09-ATH	●	0.75	8	1.35	55	6	A111
EPDBP2015-8-04-TH	△	0.75	8	1.35	55	6	A163
DEB2015-8-C	□	0.75	8	1.8	55	4	A448
CBN-EPSB2015-10-S	●	0.75	10	0.9	50	4	A151
CBN-EPSB2015-10-F	●	0.75	10	0.9	50	4	A151
EPDBEH2015F-10-TH3	●	0.75	10	1.35	42	4	A57
EPDBEH2015-10-TH3	●	0.75	10	1.35	50	4	A61
EPDBE2015-10-ATH	●	0.75	10	1.35	50	4	A73
EPDBE2015-10-PN	●	0.75	10	1.35	50	4	A76
EPDB2015-10	□	0.75	10	1.35	50	4	A406
EPDB2015-10-TH	□	0.75	10	1.35	50	4	A406
EPDBPE2015-10-04-ATH	●	0.75	10	1.35	55	6	A86
EPDBPE2015-10-09-ATH	●	0.75	10	1.35	55	6	A86

商品コード Item Code	在庫 Stock	ボール 半径 RE	首下長 Under neck length	刃長 Flute length	全長 Overall length	シャンク径 Shank dia.	ページ Page
EPDBPE2015-10-14-ATH	●	0.75	10	1.35	55	6	A86
EMBPE3015-10-09-ATH	●	0.75	10	1.35	55	6	A111
EPDBP2015-10-04-TH	△	0.75	10	1.35	55	6	A163
EPDBEH2015F-12-TH3	●	0.75	12	1.35	45	4	A57
EPDBEH2015-12-S6-TH3	●	0.75	12	1.35	50	6	A61
EPSBE2015-12-TH	●	0.75	12	1.35	50	6	A97
EPDBEH2015-12-TH3	●	0.75	12	1.35	55	4	A61
EPDBE2015-12-ATH	●	0.75	12	1.35	55	4	A73
EPDBE2015-12-PN	●	0.75	12	1.35	55	4	A76
EPDB2015-12-SD	●	0.75	12	1.35	55	4	A140
EPDB2015-12	□	0.75	12	1.35	55	4	A406
EPDB2015-12-TH	□	0.75	12	1.35	55	4	A406
EPDBPE2015-12-04-ATH	●	0.75	12	1.35	55	6	A86
EPDBP2015-12-04-TH	△	0.75	12	1.35	55	6	A163
DEB2015-12-C	□	0.75	12	1.8	55	4	A448
EPDBEH2015-14-TH3	●	0.75	14	1.35	55	4	A61
EPDBE2015-14-ATH	●	0.75	14	1.35	55	4	A73
EPDBE2015-14-PN	●	0.75	14	1.35	55	4	A76
EMBPE3015-14-09-ATH	●	0.75	14	1.35	60	6	A111
EPDBPE2015-15-09-ATH	●	0.75	15	1.35	60	6	A86
EPDBP2015-15-09-TH	△	0.75	15	1.35	60	6	A163
EPDBEH2015-16-TH3	●	0.75	16	1.35	55	4	A61
EPDBE2015-16-ATH	●	0.75	16	1.35	55	4	A73
EPDBE2015-16-PN	●	0.75	16	1.35	55	4	A76
EPDB2015-16	□	0.75	16	1.35	55	4	A406
EPDB2015-16-TH	□	0.75	16	1.35	55	4	A406
EMBPE3015-16							

外径別寸法早見表

超硬エンドミル・ボール

RE0.8 ~ RE1.5 Carbide End Mills -Ball

単位 unit : mm

商品コード Item Code	在庫 Stock	ボール 半径 RE	首下長 Under neck length	刃長 Flute length	全長 Overall length	シャンク径 Shank dia.	ページ Page
EPDBEH2016-4-TH3	●	0.8	4	1.4	50	4	A61
HYPB2016-C	●	0.8	5	2	50	6	A156
EPDBEH2016-8-TH3	●	0.8	8	1.4	50	4	A61
EPDBE2016-8-ATH	●	0.8	8	1.4	50	4	A73
EPDBE2016-8-PN	●	0.8	8	1.4	50	4	A76
EPDB2016-8	□	0.8	8	1.4	50	4	A406
EPDB2016-8-TH	□	0.8	8	1.4	50	4	A406
HPBLN2016-C	●	0.8	8	2	60	6	A157
EPDBEH2016-12-TH3	●	0.8	12	1.4	55	4	A61
EPDBE2016-12-ATH	●	0.8	12	1.4	55	4	A73
EPDBE2016-12-PN	●	0.8	12	1.4	55	4	A76
EPDB2016-12	□	0.8	12	1.4	55	4	A406
EPDB2016-12-TH	□	0.8	12	1.4	55	4	A406
EPDBEH2016-16-TH3	●	0.8	16	1.4	55	4	A61
EPDBE2016-16-ATH	●	0.8	16	1.4	55	4	A73
EPDBE2016-16-PN	●	0.8	16	1.4	55	4	A76
EPDB2016-16	□	0.8	16	1.4	55	4	A406
EPDB2016-16-TH	□	0.8	16	1.4	55	4	A406
DEB2016-16-C	□	0.8	16	1.8	55	4	A448
EPDBEH2016-20-TH3	●	0.8	20	1.4	60	4	A61
EPDBE2016-20-ATH	●	0.8	20	1.4	60	4	A73
EPDBE2016-20-PN	●	0.8	20	1.4	60	4	A76
EPDB2016-20	□	0.8	20	1.4	60	4	A406
EPDB2016-20-TH	□	0.8	20	1.4	60	4	A406
BESS2016	□	0.8	-	2.4	50	4	A421
BESS2017	□	0.85	-	2.6	50	4	A421
EPDBEH2018-4-TH3	●	0.9	4	1.6	50	4	A61
EPDBPE2018-4-04-ATH	●	0.9	4	1.6	50	6	A86
EPDBP2018-4-04-TH	△	0.9	4	1.6	50	6	A163
HYPB2018-C	●	0.9	5.3	2.3	50	6	A156
EPDBEH2018-8-TH3	●	0.9	8	1.6	50	4	A61
EPDBE2018-8-ATH	●	0.9	8	1.6	50	4	A74
EPDBE2018-8-PN	●	0.9	8	1.6	50	4	A77
EPDB2018-8	□	0.9	8	1.6	50	4	A406
EPDB2018-8-TH	□	0.9	8	1.6	50	4	A406
EPDBPE2018-8-04-ATH	●	0.9	8	1.6	50	6	A86
EPDBP2018-8-04-TH	△	0.9	8	1.6	50	6	A163
HPBLN2018-C	●	0.9	9	2.3	60	6	A157
EPDBEH2018-12-TH3	●	0.9	12	1.6	55	4	A61
EPDBE2018-12-ATH	●	0.9	12	1.6	55	4	A74
EPDBE2018-12-PN	●	0.9	12	1.6	55	4	A77
EPDB2018-12	□	0.9	12	1.6	55	4	A406
EPDB2018-12-TH	□	0.9	12	1.6	55	4	A406
EPDBPE2018-12-04-ATH	●	0.9	12	1.6	55	6	A86
EPDBP2018-12-04-TH	△	0.9	12	1.6	55	6	A163
EPDBEH2018-16-TH3	●	0.9	16	1.6	55	4	A61
EPDBE2018-16-ATH	●	0.9	16	1.6	55	4	A74
EPDBE2018-16-PN	●	0.9	16	1.6	55	4	A77
EPDB2018-16	□	0.9	16	1.6	55	4	A406
EPDB2018-16-TH	□	0.9	16	1.6	55	4	A406
EPDBPE2018-16-04-ATH	●	0.9	16	1.6	60	6	A86
EPDBP2018-16-04-TH	△	0.9	16	1.6	60	6	A163
DEB2018-16-C	□	0.9	16	2	55	4	A448
EPDBEH2018-20-TH3	●	0.9	20	1.6	60	4	A61
EPDBE2018-20-ATH	●	0.9	20	1.6	60	4	A74
EPDBE2018-20-PN	●	0.9	20	1.6	60	4	A77
EPDB2018-20	□	0.9	20	1.6	60	4	A406
EPDB2018-20-TH	□	0.9	20	1.6	60	4	A406
EPDBPE2018-20-04-ATH	●	0.9	20	1.6	65	6	A86
EPDBP2018-20-04-TH	△	0.9	20	1.6	65	6	A163
EPDBPE2018-24-04-ATH	●	0.9	24	1.6	65	6	A86
EPDBP2018-24-04-TH	△	0.9	24	1.6	65	6	A163
EPDBPE2018-28-04-ATH	●	0.9	28	1.6	70	6	A86
EPDBP2018-28-04-TH	△	0.9	28	1.6	70	6	A163
EPDBPE2018-32-04-ATH	●	0.9	32	1.6	70	6	A86
EPDBP2018-32-04-TH	△	0.9	32	1.6	70	6	A163
EPDBPE2018-36-04-ATH	●	0.9	36	1.6	75	6	A86
EPDBP2018-36-04-TH	△	0.9	36	1.6	75	6	A163
EPDBPE2018-38-04-ATH	●	0.9	38	1.6	80	6	A86

商品コード Item Code	在庫 Stock	ボール 半径 RE	首下長 Under neck length	刃長 Flute length	全長 Overall length	シャンク径 Shank dia.	ページ Page
EPDBP2018-38-04-TH	△	0.9	38	1.6	80	6	A163
EPDBPE2018-40-04-ATH	●	0.9	40	1.6	80	6	A86
EPDBP2018-40-04-TH	△	0.9	40	1.6	80	6	A163
BESS2018	□	0.9	-	2.7	50	4	A421
BESS2019	□	0.95	-	2.9	50	4	A421
BHB2020	□	1	2.5	1	60	6	A456
CBN-EHB2020-2.5	●	1	2.5	1.65	50	4	A147
EPDBEH2020F-2.5-TH3	●	1	2.5	1.7	35	4	A57
EPDBEH2020-2.5-TH3	●	1	2.5	1.7	50	4	A61
EPDBEH2020F-3-TH3	●	1	3	1.7	35	4	A57
EPSBE2020-3-TH	●	1	3	1.7	45	6	A97
EPSBE2020-3-H-TH	●	1	3	1.7	45	6	A98
EPSB2020-H-TH	●	1	3	1.7	45	6	A154
EPSB2020-N-TH	●	1	3	1.7	45	6	A154
EPDBEH2020-3-TH3	●	1	3	1.7	50	4	A61
EPDBE2020-3-ATH	●	1	3	1.7	50	4	A74
EPDBE2020-3-PN	●	1	3	1.7	50	4	A77
EPDB2020-3	□	1	3	1.7	50	4	A406
EPDB2020-3-TH	□	1	3	1.7	50	4	A406
EPDBEH2020-3-S6-TH3	●	1	3	1.7	50	6	A61
HPBS2020-C	●	1	3.5	2.5	50	6	A156
EPDBEH2020F-4-TH3	●	1	4	1.7	35	4	A57
EPDBEH2020-4-TH3	●	1	4	1.7	50	4	A61
EPDBE2020-4-ATH	●	1	4	1.7	50	4	A74
EPDBE2020-4-PN	●	1	4	1.7	50	4	A77
EPDB2020-4	□	1	4	1.7	50	4	A406
EPDB2020-4-TH	□	1	4	1.7	50	4	A406
EFB2020	●	1	4	2	50	6	A153
EPBT2020	●	1	4	3	50	6	A102
EMB3020-TH	△	1	4	3	50	6	A168
CBN-EPBS2020-5-S	●	1	5	1.2	50	4	A151
CBN-EPBS2020-5-F	●	1	5	1.2	50	4	A151
CBN-EHB2020-5	●	1	5	1.65	50	4	A147
EPDBEH2020F-5-TH3	●	1	5	1.7	38	4	A57
EPDBEH2020-5-TH3	●	1	5	1.7	50	4	A61
ESHB2020-H-TH	●	1	5	2	45	6	A108
ESHB2020-N-TH	●	1	5	2	45	6	A108
HYPB2020-C	●	1	5.5	2.5	50	6	A156
EPDBEH2020F-6-TH3	●	1	6	1.7	38	4	A57
EPSBE2020-6-TH	●	1	6	1.7	45	6	A97
EPSB2020-6-N-TH	●	1	6	1.7	45	6	A155
EPDBEH2020-6-TH3	●	1	6	1.7	50	4	A61
EPDBE2020-6-ATH	●	1	6	1.7	50	4	A74
EPDBE2020-6-PN	●	1	6	1.7	50	4	A77
EPDB2020-6	□	1	6	1.7	50	4	A406
EPDB2020-6-TH	□	1	6	1.7	50	4	A406
EPDBEH2020-6-S6-TH3	●	1	6	1.7	50	6	A61
EMB3020-S4-ATH	●	1	6	3	50	4	A110
EHHB4020-S4-TH3	●	1	6	3	50	4	A124
EHHB4020-S4-ATH	●	1	6	3	50	4	A127
EMB3020-S6-ATH	●	1	6	3	50	6	A110
EHHB4020-S6-TH3	●	1	6	3	50	6	A124
EHHB4020-S6-ATH	●	1	6	3	50	6	A127
HGOB2020-PN	●	1	6	5	50	6	A104
EPBC2020	□	1	6	5	50	6	A409
CBN-EHB2020-7.5	●	1	7.5	1.65	50	4	A147
EPDBEH2020F-8-TH3	●	1	8	1.7	42	4	A57
EPSBE2020-8-TH	●	1	8	1.7	45	6	A97
EPDBEH2020-8-TH3	●	1	8	1.7	50	4	A61
EPDBE2020-8-ATH	●	1	8	1.7	50	4	A74
EPDBE2020-8-PN	●	1	8	1.7	50	4	A77
EPDB2020-8-SD	●	1	8	1.7	50	4	A140
EPDB2020-8	□	1	8	1.7	50	4	A406
EPDB2020-8-TH	□	1	8	1.7	50	4	A406
EPDBEH2020-8-S6-TH3	●	1	8	1.7	50	6	A61
EPDBPE2020-8-04-ATH	●	1	8	1.7	50	6	A86
EPDBP2020-8-04-TH	△	1	8	1.7	50	6	A164
DEB2020-8-C	□	1	8	2	55	4	A448
CBN-EPBS2020-10-S	●	1	10	1.2	50	4	A151

商品コード Item Code	在庫 Stock	ボール 半径 RE	首下長 Under neck length	刃長 Flute length	全長 Overall length	シャンク径 Shank dia.	ページ Page
CBN-EPBS2020-10-F	●	1	10	1.2	50	4	A151
CBN-EHB2020-10	●	1	10	1.65	50	4	A147
EPDBEH2020F-10-TH3	●	1	10	1.7	42	4	A57
EPDBEH2020-10-TH3	●	1	10	1.7	50	4	A61
EPDBE2020-10-ATH	●	1	10	1.7	50	4	A74
EPDBE2020-10-PN	●	1	10	1.7	50	4	A77
EPDB2020-10	□	1	10	1.7	50	4	A406
EPDB2020-10-TH	□	1	10	1.7	50	4	A406
EPDBPE2020-10-14-ATH	●	1	10	1.7	55	6	A86
EMBPE3020-10-09-ATH	●	1	10	1.7	55	6	A111
HPBLN2020-C	●	1	10	2.5	60	6	A157
EPDBEH2020F-12-TH3	●	1	12	1.7	45	4	A57
EPDBEH2020-12-S6-TH3	●	1	12	1.7	50	6	A61
EPSBE2020-12-TH	●	1	12	1.7	50	6	A97
EPDBEH2020-12-TH3	●	1	12	1.7	55	4	A61
EPDBE2020-12-ATH	●	1	12	1.7	55	4	A74
EPDBE2020-12-PN	●	1	12	1.7	55	4	A77
EPDB2020-12	□	1	12	1.7	55	4	A406
EPDB2020-12-TH	□	1	12	1.7	55	4	A406
EPDBPE2020-12-04-ATH	●	1	12	1.7	55	6	A86
EPDBPE2020-12-09-ATH	●	1	12	1.7	55	6	A86
EPDBPE2020-12-29-ATH	●	1	12	1.7	55	6	A87
EPDBP2020-12-04-TH	△	1	12	1.7	55	6	A164
DEB2020-12-C	□	1	12	2	55	4	A448
EPDBEH2020F-13-TH3	●	1	13	1.7	45	4	A57
EPDBEH2020-13-TH3	●	1	13	1.7	55	4	A61
EPDBE2020-13-ATH	●	1	13	1.7	55	4	A74
EPDBE2020-13-PN	●	1	13	1.7	55	4	A77
EPDBEH2020F-14-TH3	●	1	14	1.7	45	4	A57
EPDBEH2020-14-TH3	●	1	14	1.7	55	4	A61
EPDBE2020-14-ATH	●	1	14	1.7			

単位 unit : mm

商品コード Item Code	在庫 Stock	ボール 半径 RE	首下長 Under neck length	刃長 Flute length	全長 Overall length	シャンク径 Shank dia.	ページ Page
EPDBPE2020-20-49-ATH	●	1	20	1.7	65	6	A87
EMBPE3020-20-09-ATH	●	1	20	1.7	65	6	A111
EPDBP2020-20-04-TH	△	1	20	1.7	65	6	A164
EPDBP2020-20-09-TH	△	1	20	1.7	65	6	A164
DEB2020-20-C	□	1	20	2	55	4	A448
EGDB2020-20-HD	●	1	20	3	60	4	A143
EPBPN2020-15	●	1	20	5	60	6	A158
EPBPN2020-50	●	1	20	5	60	6	A158
EPDBEH2020-22-TH3	●	1	22	1.7	60	4	A61
EPDBE2020-22-ATH	●	1	22	1.7	60	4	A74
EPDBE2020-22-PN	●	1	22	1.7	60	4	A77
EPDB2020-22	□	1	22	1.7	60	4	A406
EPDB2020-22-TH	□	1	22	1.7	60	4	A406
EPDBPE2020-22-14-ATH	●	1	22	1.7	65	6	A86
EPDB2020-24-SD	●	1	24	1.7	60	4	A140
EMBPE3020-24-09-ATH	●	1	24	1.7	65	6	A111
EPDBEH2020-25-TH3	●	1	25	1.7	65	4	A61
EPDBE2020-25-ATH	●	1	25	1.7	65	4	A74
EPDBE2020-25-PN	●	1	25	1.7	65	4	A77
EPDB2020-25	□	1	25	1.7	65	4	A406
EPDB2020-25-TH	□	1	25	1.7	65	4	A406
EPDBPE2020-25-04-ATH	●	1	25	1.7	65	6	A86
EPDBPE2020-25-09-ATH	●	1	25	1.7	65	6	A86
EPDBPE2020-25-14-ATH	●	1	25	1.7	65	6	A86
EPDBP2020-25-09-TH	△	1	25	1.7	65	6	A164
EPDBEH2020-30-TH3	●	1	30	1.7	70	4	A61
EPDBE2020-30-ATH	●	1	30	1.7	70	4	A74
EPDBE2020-30-PN	●	1	30	1.7	70	4	A77
EPDB2020-30	□	1	30	1.7	70	4	A406
EPDB2020-30-TH	□	1	30	1.7	70	4	A406
EPDBPE2020-30-04-ATH	●	1	30	1.7	70	6	A86
EPDBPE2020-30-09-ATH	●	1	30	1.7	70	6	A86
EPDBPE2020-30-14-ATH	●	1	30	1.7	70	6	A87
EMBPE3020-30-09-ATH	●	1	30	1.7	70	6	A111
EPDBP2020-30-04-TH	△	1	30	1.7	70	6	A164
EPDBP2020-30-09-TH	△	1	30	1.7	70	6	A164
EPDBEH2020-35-TH3	●	1	35	1.7	75	4	A61
EPDBE2020-35-ATH	●	1	35	1.7	75	4	A74
EPDBE2020-35-PN	●	1	35	1.7	75	4	A77
EPDB2020-35	□	1	35	1.7	75	4	A406
EPDB2020-35-TH	□	1	35	1.7	75	4	A406
EPDBPE2020-35-09-ATH	●	1	35	1.7	75	6	A86
EPDBP2020-35-09-TH	△	1	35	1.7	75	6	A164
EMBPE3020-36-09-ATH	●	1	36	1.7	80	6	A111
EPDBEH2020-40-TH3	●	1	40	1.7	80	4	A61
EPDBE2020-40-ATH	●	1	40	1.7	80	4	A74
EPDBE2020-40-PN	●	1	40	1.7	80	4	A77
EPDB2020-40	□	1	40	1.7	80	4	A406
EPDB2020-40-TH	□	1	40	1.7	80	4	A406
EPDBPE2020-40-04-ATH	●	1	40	1.7	80	6	A86
EPDBPE2020-40-09-ATH	●	1	40	1.7	80	6	A86
EPDBPE2020-40-14-ATH	●	1	40	1.7	80	6	A87
EMBPE3020-40-09-ATH	●	1	40	1.7	80	6	A111
EPDBP2020-40-04-TH	△	1	40	1.7	80	6	A164
EPDBP2020-40-09-TH	△	1	40	1.7	80	6	A164
EGDB2020-40-HD	●	1	40	3	80	4	A143
EPBPN2020-30	●	1	40	5	80	6	A158
EPDBPE2020-41-29-ATH	●	1	41	1.7	130	6	A87
EMBPE3020-46-09-ATH	●	1	46	1.7	90	6	A111
EPDBPE2020-50-09-ATH	●	1	50	1.7	90	6	A86
EPDBPE2020-50-14-ATH	●	1	50	1.7	90	6	A87
EPDBP2020-50-09-TH	△	1	50	1.7	90	6	A164
EPDBPE2020-60-09-ATH	●	1	60	1.7	100	6	A86
EMBPE3020-60-09-ATH	●	1	60	1.7	100	6	A111
EPDBP2020-60-09-TH	△	1	60	1.7	100	6	A164
EGDB2020-60-HD	●	1	60	3	100	4	A143
EPDBPE2020-70-09-ATH	●	1	70	1.7	110	6	A86
EPDBP2020-70-09-TH	△	1	70	1.7	110	6	A164
EPDBPE2020-75-09-ATH	●	1	75	1.7	115	6	A86

商品コード Item Code	在庫 Stock	ボール 半径 RE	首下長 Under neck length	刃長 Flute length	全長 Overall length	シャンク径 Shank dia.	ページ Page
EPDBPE2020-75-14-ATH	●	1	75	1.7	115	6	A87
EPBPX2020-15	●	1	79.88	2.5	150	6	A160
EPDBPE2020-80-04-ATH	●	1	80	1.7	120	6	A86
EPBPX2020-05	●	1	80	2.5	150	6	A160
EPBPX2020-10	●	1	80	2.5	150	6	A160
BESS2020	□	1	-	3	50	4	A421
CEPB2020	□	1	-	3	50	6	A411
YB2020-CS	□	1	-	3	60	6	A422
CEPBL2020	□	1	-	3	90	6	A411
BES2020M	□	1	-	5	50	4	A421
BEK2020	●	1	-	5	50	6	A161
BEK2020-C	□	1	-	5	50	6	A415
BES2020-C	□	1	-	5	50	6	A415
BES2020	□	1	-	5	50	6	A421
BEKLS2020-C	□	1	-	5	90	6	A415
GBS2020	□	1	-	10	80	4	A426
GBR2020	□	1	-	10	80	6	A425
GBD2020	□	1	-	10	100	4	A426
GXB2020	□	1	-	10	100	6	A426
GBL2020	□	1	-	20	100	6	A425
BESS2021	□	1.05	-	3.2	50	4	A421
BESS2022	□	1.1	-	3.3	50	4	A421
BESS2023	□	1.15	-	3.5	50	4	A421
BESS2024	□	1.2	-	3.6	50	4	A421
EFB2025	●	1.25	1	2.5	50	6	A153
EPBT2025	●	1.25	5	4	50	6	A102
EPDBEH2025F-6-TH3	●	1.25	6	2	38	4	A57
EPDBEH2025-6-TH3	●	1.25	6	2	50	4	A62
EPDBE2025-6-ATH	●	1.25	6	2	50	4	A74
EPDBE2025-6-PN	●	1.25	6	2	50	4	A77
HYPB2025-C	●	1.25	6	3	50	6	A156
ESHB2025-H-TH	●	1.25	6.25	2.5	45	6	A108
ESHB2025-N-TH	●	1.25	6.25	2.5	45	6	A108
EMBE3025-S4-ATH	●	1.25	7.5	4	50	4	A110
EHHBE4025-S4-TH3	●	1.25	7.5	4	50	4	A124
EHHB4025-S4-ATH	●	1.25	7.5	4	50	4	A127
EMBE3025-S6-ATH	●	1.25	7.5	4	50	6	A110
EHHBE4025-S6-TH3	●	1.25	7.5	4	50	6	A124
EHHB4025-S6-ATH	●	1.25	7.5	4	50	6	A127
HGOB2025-PN	●	1.25	8	7	50	6	A104
EPBC2025	□	1.25	8	7	50	6	A409
EPDBEH2025F-10-TH3	●	1.25	10	2	42	4	A57
EPDBEH2025-10-TH3	●	1.25	10	2	50	4	A62
EPDBE2025-10-ATH	●	1.25	10	2	50	4	A74
EPDBE2025-10-PN	●	1.25	10	2	50	4	A77
HPBLN2025-C	●	1.25	12.5	3	60	6	A157
EPDBEH2025F-15-TH3	●	1.25	15	2	45	4	A57
EPDBEH2025-15-TH3	●	1.25	15	2	55	4	A62
EPDBE2025-15-ATH	●	1.25	15	2	55	4	A74
EPDBE2025-15-PN	●	1.25	15	2	55	4	A77
EMBPE3025-16-09-ATH	●	1.25	16	2	60	6	A111
EPDBEH2025-20-TH3	●	1.25	20	2	60	4	A62
EPDBE2025-20-ATH	●	1.25	20	2	60	4	A74
EPDBE2025-20-PN	●	1.25	20	2	60	4	A77
EMBPE3025-24-09-ATH	●	1.25	24	2	65	6	A111
EPDBEH2025-25-TH3	●	1.25	25	2	65	4	A62
EPDBE2025-25-ATH	●	1.25	25	2	65	4	A74
EPDBE2025-25-PN	●	1.25	25	2	65	4	A77
EPDBEH2025-30-TH3	●	1.25	30	2	70	4	A62
EPDBE2025-30-ATH	●	1.25	30	2	70	4	A74
EPDBE2025-30-PN	●	1.25	30	2	70	4	A77
EMBPE3025-30-09-ATH	●	1.25	30	2	70	6	A111
EMBPE3025-40-09-ATH	●	1.25	40	2	80	6	A111
EMBPE3025-50-09-ATH	●	1.25	50	2	90	6	A111
BESS2025	□	1.25	-	3.8	50	4	A421
CEPB2025	□	1.25	-	4	50	6	A411
CEPBL2025	□	1.25	-	4	90	6	A411
BEK2025	●	1.25	-	7	50	6	A161
BEK2025-C	□	1.25	-	7	50	6	A415

商品コード Item Code	在庫 Stock	ボール 半径 RE	首下長 Under neck length	刃長 Flute length	全長 Overall length	シャンク径 Shank dia.	ページ Page
BEKLS2025-C	□	1.25	-	7	90	6	A415
GBR2025	□	1.25	-	10	80	6	A425
BESS2026	□	1.3	-	3.9	55	6	A421
BESS2027	□	1.35	-	4.1	55	6	A421
BESS2028	□	1.4	-	4.2	55	6	A421
BESS2029	□	1.45	-	4.4	55	6	A421
HPBS2030-C	●	1.5	5	4	50	6	A156
EPBTS2030-TH	●	1.5	5.5	4.5	70	6	A100
EPBT2030	●	1.5	5.5	4.5	70	6	A102
EMB3030-TH	△	1.5	5.5	4.5	70	6	A168
EPDBEH2030-6-TH3	●	1.5	6	2.5	50	6	A62
EFB2030	●	1.5	6	3	70	6	A153
ESHB2030-H-TH	●	1.5	7.5	3	45	6	A108
ESHB2030-N-TH	●	1.5	7.5	3	45	6	A108
EPDBPE2030-8-04-ATH	●	1.5	8	2.5	50	6	A87
EPDBP2030-8-04-TH	△	1.5	8	2.5	50	6	A164
EPDBEH2030-8-TH3	●	1.5	8	2.5	55	6	A62
EPDBE2030-8-ATH	●	1.5	8	2.5	55	6	A74
EPDBE2030-8-PN	●	1.5	8	2.5	55	6	A77
EPDB2030-8	□	1.5	8	2.5	55	6	A406
EPDB2030-8-TH	□	1.5	8	2.5	55	6	A406
HYPB2030-C	●	1.5	8	4	50	6	A156
EMBE3030-S4-ATH	●	1.5	9	4.5	70	4	A110
EHHBE4030-S4-TH3	●	1.5	9	4.5	70	4	A124
EHHB4030-S4-ATH	●	1.5	9	4.5	70	4	A127
EMBE3030-S6-ATH	●	1.5	9	4.5	70	6	A110
EHHBE4030-S6-TH3	●	1.5	9	4.5	70	6	A124
EHHB4030-S6-ATH	●	1.5	9	4.5	70	6	A127
HGOB2030-PN	●	1.5	9	8	70	6	A104
EPBC2030	□	1.5	9	8	70	6	A409
EPDBEH2030-10-TH3	●	1.5	10	2.5	55	6	A62
EPDBE2030-10-ATH	●	1.5	10	2.5	55	6	A74
EPDBE2030-10-PN	●	1.5	10	2.5	55	6	A77
EPDB2030-10	□	1.5	10	2.5	55	6	A406
EPDB2030-10-TH	□	1.5	10	2.5</			

Quick dimension reference table by mill diameter

外径別寸法早見表

超硬エンドミル・ボール

RE1.5 ~ RE4 Carbide End Mills -Ball

単位 unit : mm

商品コード Item Code	在庫 Stock	ボール 半径 RE	首下長 Under neck length	刃長 Flute length	全長 Overall length	シャンク径 Shank dia.	ページ Page
EPDBPE2030-30-09-ATH	●	1.5	30	2.5	70	6	A87
EPDBPE2030-30-14-ATH	●	1.5	30	2.5	70	6	A87
EPDBPE2030-30-29-ATH	●	1.5	30	2.5	70	6	A87
EMBP3030-30-09-ATH	●	1.5	30	2.5	70	6	A111
EPDBP2030-30-04-TH	△	1.5	30	2.5	70	6	A164
EPDBP2030-30-09-TH	△	1.5	30	2.5	70	6	A164
EPDBEH2030-30-TH3	●	1.5	30	2.5	75	6	A62
EPDBE2030-30-ATH	●	1.5	30	2.5	75	6	A74
EPDBE2030-30-PN	●	1.5	30	2.5	75	6	A77
EPDB2030-30	□	1.5	30	2.5	75	6	A406
EPDB2030-30-TH	□	1.5	30	2.5	75	6	A406
EPBPN2030-30	●	1.5	30	8	70	6	A158
EPDBPE2030-35-09-ATH	●	1.5	35	2.5	75	6	A87
EPDBEH2030-35-TH3	●	1.5	35	2.5	80	6	A62
EPDBE2030-35-ATH	●	1.5	35	2.5	80	6	A74
EPDBE2030-35-PN	●	1.5	35	2.5	80	6	A77
EPDB2030-35	□	1.5	35	2.5	80	6	A406
EPDB2030-35-TH	□	1.5	35	2.5	80	6	A406
BESL2030-C	□	1.5	35	4	100	6	A418
BESL2030-S-C	□	1.5	35	4	100	6	A418
EPDB2030-36-SD	●	1.5	36	2.5	80	6	A140
EPDBPE2030-40-04-ATH	●	1.5	40	2.5	80	6	A87
EPDBPE2030-40-09-ATH	●	1.5	40	2.5	80	6	A87
EPDBPE2030-40-14-ATH	●	1.5	40	2.5	80	6	A87
EMBP3030-40-09-ATH	●	1.5	40	2.5	80	6	A111
EPDBP2030-40-04-TH	△	1.5	40	2.5	80	6	A164
EPDBP2030-40-09-TH	△	1.5	40	2.5	80	6	A164
EGDB2030-40-HD	●	1.5	40	4.5	80	4	A143
EPDBPE2030-50-04-ATH	●	1.5	50	2.5	90	6	A87
EPDBPE2030-50-09-ATH	●	1.5	50	2.5	90	6	A87
EPDBPE2030-50-14-ATH	●	1.5	50	2.5	90	6	A87
EMBP3030-50-09-ATH	●	1.5	50	2.5	90	6	A111
EPDBP2030-50-09-TH	△	1.5	50	2.5	90	6	A164
EPBPN2030-15	●	1.5	50	8	90	6	A158
EPDBPE2030-60-09-ATH	●	1.5	60	2.5	100	6	A87
EMBP3030-60-09-ATH	●	1.5	60	2.5	100	6	A111
EPDBP2030-60-09-TH	△	1.5	60	2.5	100	6	A164
EGDB2030-60-HD	●	1.5	60	4.5	100	4	A143
EPDBPE2030-66-14-ATH	●	1.5	66	2.5	140	6	A87
EPDBPE2030-70-09-ATH	●	1.5	70	2.5	110	6	A87
EPDBP2030-70-09-TH	△	1.5	70	2.5	110	6	A164
EPDBPE2030-80-04-ATH	●	1.5	80	2.5	120	6	A87
EPBPX2030-05	●	1.5	87	3.5	150	6	A160
EPDBPE2030-90-09-ATH	●	1.5	90	2.5	130	6	A87
EPBPX2030-10	●	1.5	90.43	3.5	150	6	A160
EPBPX2030-15	●	1.5	99.97	3.5	150	8	A160
BES2030	□	1.5	-	4.5	55	6	A421
YB2030-CS	□	1.5	-	4.5	60	6	A422
CEPB2030	□	1.5	-	4.5	70	6	A411
CEPBL2030	□	1.5	-	4.5	100	6	A411
BEK2030	●	1.5	-	8	70	6	A161
BEK2030-C	□	1.5	-	8	70	6	A415
BES2030-C	□	1.5	-	8	70	6	A415
BES2030	□	1.5	-	8	70	6	A421
BES2030M	□	1.5	-	8	70	6	A421
BEKLS2030-C	□	1.5	-	8	100	6	A415
GBS2030	□	1.5	-	15	80	4	A426
GBR2030	□	1.5	-	15	80	6	A425
GBD2030	□	1.5	-	15	100	4	A426
GXB2030	□	1.5	-	15	100	6	A426
GBL2030	□	1.5	-	30	100	6	A425
HYPB2035-C	●	1.75	8.5	4.5	50	6	A156
ESHB2035-H-TH	●	1.75	8.75	3.5	45	6	A108
ESHB2035-N-TH	●	1.75	8.75	3.5	45	6	A108
EPDBEH2035-10-TH3	●	1.75	10	2.75	55	6	A62
EMBE3035-S4-ATH	●	1.75	10.5	5.3	70	4	A110
EMBE3035-S6-ATH	●	1.75	10.5	5.3	70	6	A110
EPDBEH2035-15-TH3	●	1.75	15	2.75	60	6	A62
EPDBE2035-15-ATH	●	1.75	15	2.75	60	6	A74

商品コード Item Code	在庫 Stock	ボール 半径 RE	首下長 Under neck length	刃長 Flute length	全長 Overall length	シャンク径 Shank dia.	ページ Page
EPDBE2035-15-PN	●	1.75	15	2.75	60	6	A77
HPBLN2035-C	●	1.75	17.5	4.5	80	6	A157
EMBP3035-20-09-ATH	●	1.75	20	2.75	60	6	A112
EPDBEH2035-25-TH3	●	1.75	25	2.75	70	6	A62
EPDBE2035-25-ATH	●	1.75	25	2.75	70	6	A74
EPDBE2035-25-PN	●	1.75	25	2.75	70	6	A77
EMBP3035-30-09-ATH	●	1.75	30	2.75	70	6	A112
EPDBE2035-35-TH3	●	1.75	35	2.75	80	6	A62
EPDBE2035-35-ATH	●	1.75	35	2.75	80	6	A74
EPDBE2035-35-PN	●	1.75	35	2.75	80	6	A77
EMBP3035-40-09-ATH	●	1.75	40	2.75	80	6	A112
EPDBEH2035-45-TH3	●	1.75	45	2.75	90	6	A62
EPDBE2035-45-ATH	●	1.75	45	2.75	90	6	A74
EPDBE2035-45-PN	●	1.75	45	2.75	90	6	A77
EMBP3035-50-09-ATH	●	1.75	50	2.75	90	6	A112
EMBP3035-60-09-ATH	●	1.75	60	2.75	100	6	A112
HPBS2040-C	●	2	6	5	50	6	A156
EPBTS2040-TH	●	2	7	6	70	6	A100
EPBT2040	●	2	7	6	70	6	A102
EMB3040-TH	△	2	7	6	70	6	A168
EPDBEH2040-8-TH3	●	2	8	3	55	6	A62
EFB2040	●	2	8	4	70	6	A153
HGOB2040-PN	●	2	9	8	70	6	A104
EPBC2040	□	2	9	8	70	6	A409
EPDBEH2040-10-TH3	●	2	10	3	55	6	A62
EPDBE2040-10-ATH	●	2	10	3	55	6	A74
EPDBE2040-10-PN	●	2	10	3	55	6	A77
EPDB2040-10	□	2	10	3	55	6	A406
EPDB2040-10-TH	□	2	10	3	55	6	A406
ESHB2040-H-TH	●	2	10	4	45	6	A108
ESHB2040-N-TH	●	2	10	4	45	6	A108
HYPB2040-C	●	2	10	5	50	6	A156
EPDBEH2040-12-TH3	●	2	12	3	60	6	A62
EMBE3040-S4-ATH	●	2	12	6	70	4	A110
EHHBE4040-S4-TH3	●	2	12	6	70	4	A124
EHHB4040-S4-ATH	●	2	12	6	70	4	A127
EMBE3040-S6-ATH	●	2	12	6	70	6	A110
EHHBE4040-S6-TH3	●	2	12	6	70	6	A124
EHHB4040-S6-ATH	●	2	12	6	70	6	A127
EPDBEH2040-13-TH3	●	2	13	3	60	6	A62
EPDBE2040-13-ATH	●	2	13	3	60	6	A74
EPDBE2040-13-PN	●	2	13	3	60	6	A77
EPDB2040-13	□	2	13	3	60	6	A406
EPDB2040-13-TH	□	2	13	3	60	6	A406
EPDBEH2040-16-TH3	●	2	16	3	60	6	A62
EPDBE2040-16-ATH	●	2	16	3	60	6	A74
EPDBE2040-16-PN	●	2	16	3	60	6	A77
EPDB2040-16-SD	●	2	16	3	60	6	A140
EPDB2040-16	□	2	16	3	60	6	A406
EPDB2040-16-TH	□	2	16	3	60	6	A406
EPDBEH2040-20-TH3	●	2	20	3	65	6	A62
EPDBE2040-20-ATH	●	2	20	3	65	6	A74
EPDBE2040-20-PN	●	2	20	3	65	6	A77
EPDB2040-20	□	2	20	3	65	6	A406
EPDB2040-20-TH	□	2	20	3	65	6	A406
HPBLN2040-C	●	2	20	5	80	6	A157
EMBP3040-20-09-ATH	●	2	20	6	70	6	A112
EPDBPE2040-20-09-ATH	●	2	20	8	70	8	A87
EPDBP2040-20-10-TH	△	2	20	8	70	8	A164
EPDBEH2040-25-TH3	●	2	25	3	70	6	A62
EPDBE2040-25-ATH	●	2	25	3	70	6	A74
EPDBE2040-25-PN	●	2	25	3	70	6	A77
EPDB2040-25	□	2	25	3	70	6	A406
EPDB2040-25-TH	□	2	25	3	70	6	A406
EPDBPE2040-25-29-ATH	●	2	25	8	75	8	A87
EPBPN2040-30	●	2	29.1	8	70	6	A158
EPDBEH2040-30-TH3	●	2	30	3	75	6	A62
EPDBE2040-30-ATH	●	2	30	3	75	6	A74
EPDBE2040-30-PN	●	2	30	3	75	6	A77

商品コード Item Code	在庫 Stock	ボール 半径 RE	首下長 Under neck length	刃長 Flute length	全長 Overall length	シャンク径 Shank dia.	ページ Page
EPDB2040-30	□	2	30	3	75	6	A406
EPDB2040-30-TH	□	2	30	3	75	6	A406
EMBP3040-30-09-ATH	●	2	30	6	80	6	A112
EMBP3040-30-10-TH	△	2	30	6	80	6	A170
EPDBPE2040-30-09-ATH	●	2	30	8	80	8	A87
EPDBP2040-30-10-TH	△	2	30	8	80	8	A164
EPDB2040-32-SD	●	2	32	3	75	6	A140
EPDBEH2040-35-TH3	●	2	35	3	80	6	A62
EPDBE2040-35-ATH	●	2	35	3	80	6	A74
EPDBE2040-35-PN	●	2	35	3	80	6	A77
EPDB2040-35	□	2	35	3	80	6	A406
EPDB2040-35-TH	□	2	35	3	80	6	A406
BESL2040-C	□	2	35	6	100	6	A418
BESL2040-S-C	□	2	35	6	100	6	A418
EPDBPE2040-35-09-ATH	●	2	35	8	85	8	A87
EPDBEH2040-40-TH3	●	2	40	3	80	6	A62
EPDBE2040-40-ATH	●	2	40	3	80	6	A74
EPDBE2040-40-PN	●	2	40	3	80	6	A77
EPDB2040-40	□	2	40	3	80	6	A406
EPDB2040-40-TH	□	2	40	3	80	6	A406
EMBP3040-40-09-ATH	●	2	40	6	90	6	A112
EMBP3040-40-10-TH	△	2	40	6	90	6	A170
EPDBPE2040-40-09-ATH	●	2	40	8	90	8	A87
EPDBP2040-40-10-TH	△	2	40	8	90	8	A164
EGB2040-HD	●	2	40	8	100	4	A145
EPDBEH2040-45-TH3	●	2	45	3	90	6	A62
EPDBE2040-45-ATH	●	2	45	3	90	6	A74
EPDBE2040-45-PN	●	2	45	3	90	6	A77
EPDB2040-45	□	2	45	3	90	6	A406
EPDB2040-45-TH	□	2	45	3	90	6	A406
EPDBPE2040-45-14-ATH	●	2	45	8	95	8	A87

単位 unit : mm

商品コード Item Code	在庫 Stock	ボール 半径 RE	首下長 Under neck length	刃長 Flute length	全長 Overall length	シャンク径 Shank dia.	ページ Page
GBR2040	□	2	-	20	80	6	A425
GBD2040	□	2	-	20	100	4	A426
GXB2040	□	2	-	20	110	6	A426
GBL2040	□	2	-	60	110	6	A425
GBR2045	□	2.25	-	25	100	6	A425
HPBS2050-C	●	2.5	7	6	50	6	A156
EPBTS2050-TH	●	2.5	8.5	7.5	80	6	A100
EPBT2050	●	2.5	8.5	7.5	80	6	A102
EMB3050-TH	△	2.5	8.5	7.5	80	6	A168
EPDBEH2050-10-TH3	●	2.5	10	3.5	55	6	A62
EFB2050	●	2.5	10	5	80	6	A153
HYPB2050-C	●	2.5	11	6	50	6	A156
HGOB2050-PN	●	2.5	11	10	80	6	A104
EPBC2050	□	2.5	11	10	80	6	A409
ESHB2050-H-TH	●	2.5	12.5	5	50	6	A108
ESHB2050-N-TH	●	2.5	12.5	5	50	6	A108
EMBE3050-ATH	●	2.5	15	7.5	80	6	A110
EHHBE4050-TH3	●	2.5	15	7.5	80	6	A124
EHHB4050-ATH	●	2.5	15	7.5	80	6	A127
EPDBEH2050-20-TH3	●	2.5	20	3.5	65	6	A62
EPDBE2050-20-ATH	●	2.5	20	3.5	65	6	A74
EPDBE2050-20-PN	●	2.5	20	3.5	65	6	A77
EPDB2050-20-SD	●	2.5	20	3.5	65	6	A140
EPDB2050-20	□	2.5	20	3.5	65	6	A406
EPDB2050-20-TH	□	2.5	20	3.5	65	6	A406
EPDBEH2050-25-TH3	●	2.5	25	3.5	70	6	A62
EPDBE2050-25-ATH	●	2.5	25	3.5	70	6	A74
EPDBE2050-25-PN	●	2.5	25	3.5	70	6	A77
EPDB2050-25	□	2.5	25	3.5	70	6	A406
EPDB2050-25-TH	□	2.5	25	3.5	70	6	A406
HPBLN2050-C	●	2.5	25	6	80	6	A157
EPDBEH2050-30-TH3	●	2.5	30	3.5	75	6	A62
EPDBE2050-30-ATH	●	2.5	30	3.5	75	6	A74
EPDBE2050-30-PN	●	2.5	30	3.5	75	6	A77
EPDB2050-30	□	2.5	30	3.5	75	6	A406
EPDB2050-30-TH	□	2.5	30	3.5	75	6	A406
EPBPE3050-30-09-ATH	●	2.5	30	7.5	80	8	A112
EPBPE2050-30-09-ATH	●	2.5	30	10	80	8	A87
EPDBP2050-30-10-TH	△	2.5	30	10	80	8	A164
EPDBEH2050-40-TH3	●	2.5	40	3.5	80	6	A62
EPDBE2050-40-ATH	●	2.5	40	3.5	80	6	A74
EPDBE2050-40-PN	●	2.5	40	3.5	80	6	A77
EPDB2050-40-SD	●	2.5	40	3.5	80	6	A140
EPDB2050-40	□	2.5	40	3.5	80	6	A406
EPDB2050-40-TH	□	2.5	40	3.5	80	6	A406
BESL2050-S-C	□	2.5	40	7	115	6	A418
BESL2050-C	□	2.5	40	7	115	6	A418
EMBPE3050-40-09-ATH	●	2.5	40	7.5	90	8	A112
EMBP3050-40-10-TH	△	2.5	40	7.5	90	8	A170
EPDBPE2050-40-09-ATH	●	2.5	40	10	90	8	A87
EPDBPE2050-40-29-ATH	●	2.5	40	10	90	8	A87
EPDBP2050-40-10-TH	△	2.5	40	10	90	8	A164
EPBPN2050-30	●	2.5	40.6	10	90	8	A158
EMBP3050-50-09-ATH	●	2.5	50	7.5	100	8	A112
EMBP3050-60-09-ATH	●	2.5	60	7.5	110	8	A112
EMBP3050-60-10-TH	△	2.5	60	7.5	110	8	A170
EPDBPE2050-60-09-ATH	●	2.5	60	10	110	8	A87
EPDBPE2050-60-14-ATH	●	2.5	60	10	110	8	A87
EPBPN2050-15	●	2.5	60	10	110	8	A158
EPDBP2050-60-10-TH	△	2.5	60	10	110	8	A164
EMBP3050-70-09-ATH	●	2.5	70	7.5	120	8	A112
EPDBPE2050-74-14-ATH	●	2.5	74	10	150	8	A87
EMBP3050-80-09-ATH	●	2.5	80	7.5	130	8	A112
EPDBPE2050-90-09-ATH	●	2.5	90	10	140	8	A87
EPBPX2050-10	●	2.5	92.43	5.5	180	8	A160
EPDBPE2050-100-04-ATH	●	2.5	100	10	150	8	A87
EPBPX2050-15	●	2.5	101.97	5.5	180	10	A160
EPBPX2050-05	●	2.5	110	5.5	180	8	A160
CEPB2050	□	2.5	-	7.5	80	6	A411

商品コード Item Code	在庫 Stock	ボール 半径 RE	首下長 Under neck length	刃長 Flute length	全長 Overall length	シャンク径 Shank dia.	ページ Page
YB2050-CS	□	2.5	-	7.5	80	6	A422
CEPBLS2050	□	2.5	-	7.5	125	6	A411
BEK2050	●	2.5	-	10	80	6	A161
BEK2050-C	□	2.5	-	10	80	6	A415
BEKLS2050-C	□	2.5	-	10	125	6	A415
BES2050-C	□	2.5	-	15	80	6	A415
BES2050	□	2.5	-	15	80	6	A421
BES2050M	□	2.5	-	15	80	6	A421
GBR2050	□	2.5	-	25	100	6	A425
GXB2050	□	2.5	-	25	125	6	A426
GBS2050	□	2.5	-	30	100	6	A426
GBD2050	□	2.5	-	30	120	6	A426
GBL2050	□	2.5	-	70	125	6	A425
HPBS2060-C	●	3	9	7.5	50	6	A156
EPDBEH2060-12-TH3	●	3	12	6	60	6	A62
EPDBE2060-12-ATH	●	3	12	6	60	6	A74
EPDBE2060-12-PN	●	3	12	6	60	6	A77
EFB2060	●	3	12	6	90	6	A153
HYPB2060-C	●	3	12.5	7.5	50	6	A156
ESHB2060-H-TH	●	3	15	6	50	6	A108
ESHB2060-N-TH	●	3	15	6	50	6	A108
EPAB2060-SD	●	3	15	6	90	6	A142
EMBE3060-ATH	●	3	18	9	90	6	A110
EHHBE4060-TH3	●	3	18	9	90	6	A124
EHHB4060-ATH	●	3	18	9	90	6	A127
EPDBEH2060-20-TH3	●	3	20	6	65	6	A62
EPDBE2060-20-ATH	●	3	20	6	65	6	A74
EPDBE2060-20-PN	●	3	20	6	65	6	A77
EPDBEH2060-30-TH3	●	3	30	6	75	6	A62
EPDBE2060-30-ATH	●	3	30	6	75	6	A74
EPDBE2060-30-PN	●	3	30	6	75	6	A77
EPDB2060-30	□	3	30	6	75	6	A406
EPDB2060-30-TH	□	3	30	6	75	6	A406
HPBLN2060-C	●	3	30	7.5	80	6	A157
EMBP3060-30-09-ATH	●	3	30	9	80	8	A112
EPDBPE2060-30-09-ATH	●	3	30	12	80	8	A87
EPDBP2060-30-10-TH	△	3	30	12	80	8	A164
EPDBPE2060-30-29-ATH	●	3	30	12	80	10	A87
EPBPN2060-30	●	3	33.1	12	90	8	A158
EMBP3060-40-09-ATH	●	3	40	9	90	8	A112
EPDBPE2060-40-09-ATH	●	3	40	12	90	8	A87
EPDBP2060-40-10-TH	△	3	40	12	90	8	A164
BESL2060-S-C	□	3	45	8	115	6	A418
JBELS2060	□	3	45	8	115	6	A422
BESL2060-C	□	3	45	8	115	6	A418
HGOBLS2060-45-PN	●	3	45	9	115	6	A104
EPDBPE2060-45-09-ATH	●	3	45	12	95	8	A87
EPDBEH2060-50-TH3	●	3	50	6	100	6	A62
EPDBE2060-50-ATH	●	3	50	6	100	6	A74
EPDBE2060-50-PN	●	3	50	6	100	6	A77
EPDB2060-50	□	3	50	6	100	6	A406
EPDB2060-50-TH	□	3	50	6	100	6	A406
EMBP3060-50-09-ATH	●	3	50	9	100	8	A112
EMBP3060-60-10-TH	△	3	50	9	100	8	A170
EPDBPE2060-50-09-ATH	●	3	50	12	100	8	A87
EPDBP2060-50-10-TH	△	3	50	12	100	8	A164
EPDBPE2060-50-14-ATH	●	3	50	12	100	10	A87
EPBPN2060-15	●	3	52.2	12	110	8	A158
EMBP3060-60-09-ATH	●	3	60	9	110	8	A112
EMBP3060-60-10-TH	△	3	60	9	110	8	A170
EPDBPE2060-60-09-ATH	●	3	60	12	110	10	A87
EPDBP2060-60-10-TH	△	3	60	12	110	10	A164
EGB2060-HD	●	3	60	12	120	6	A145
EMBP3060-70-09-ATH	●	3	70	9	120	10	A112
EMBP3060-70-10-TH	△	3	70	9	120	10	A170
EPDBPE2060-70-09-ATH	●	3	70	12	120	10	A87
EPDBP2060-70-10-TH	△	3	70	12	120	10	A164
HGOBLS2060-75-PN	●	3	75	9	150	6	A104
EMBP3060-80-09-ATH	●	3	80	9	130	10	A112

商品コード Item Code	在庫 Stock	ボール 半径 RE	首下長 Under neck length	刃長 Flute length	全長 Overall length	シャンク径 Shank dia.	ページ Page
EMBP3060-80-10-TH	△	3	80	9	130	10	A170
EPDBPE2060-80-09-ATH	●	3	80	12	130	10	A87
EPDBP2060-80-10-TH	△	3	80	12	130	10	A164
EPDBPE2060-96-14-ATH	●	3	96	12	200	10	A87
EMBP3060-100-09-ATH	●	3	100	9	150	10	A112
EMBP3060-120-09-ATH	●	3	120	9	200	10	A112
EPDBPE2060-120-04-ATH	●	3	120	12	200	8	A87
EPDBPE2060-120-09-ATH	●	3	120	12	200	10	A87
EPBPX2060-15	●	3	122.07	6.5	200	12	A160
EPBPX2060-10	●	3	122.08	6.5	200	10	A160
EPBPX2060-05	●	3	122.09	6.5	200	8	A160
EPHB6060-PN	●	3	-	6	90	6	A130
EPBTS2060-TH	●	3	-	9	90	6	A100
EPBT2060	●	3	-	9	90	6	A102
EMB3060-TH	△	3	-	9	90	6	A168
CEPB2060	□	3	-	9	90	6	A411
CEPB4060	□	3	-	9	90	6	A411
YB2060-CS	□	3	-	9	90	6	A422
JBER2060	□	3	-	9	90	6	A422
CEPBL2060	□	3	-	9	150	6	A411
HGOB2060-PN	●	3	-	12	90	6	A104
BEK2060	●	3	-	12	90	6	A161
EPBC2060	□	3	-	12	90	6	A409
BEK2060-C	□	3	-	12	90	6	A415
BEKLS2060-C	□	3	-	12	150	6	A415
BES2060M	□	3	-	15	80	6	A421
BES2060-C	□	3	-	15	90	6	A415
BES2060	□	3	-	15	90	6	A421
FE606	□	3	-	25	80	6	A425
GBR2060	□	3	-	30	100	6	A425
GBS2060	□	3	-	30	100	6	A426
GXB2060	□	3	-	30	130	6	A426
GBD2060	□	3	-	30	150	6	A426
GBL2060	□	3	-	80	130	6	A425
GBR2065	□	3.25	-	35	100	6	A425
EPDBPE2070-40-29-ATH	●	3.5	40</				

超硬エンドミル・ラジラス

φ0.2 ~ φ0.6
Carbide End Mills - Radius

単位 unit : mm

商品コード Item Code	在庫 Stock	ボール 半径 RE	首下長 Under neck length	刃長 Flute length	全長 Overall length	シャンク径 Shank dia.	ページ Page
CEPBL2160	□	8	-	24	250	16	A411
HGOB2160-PN	●	8	-	30	140	16	A104
BEK2160	●	8	-	30	140	16	A161
EPBC2160	□	8	-	30	140	16	A409
BEK2160-C	□	8	-	30	140	16	A415
BEKLS2160-C	□	8	-	30	250	16	A415
FE616	□	8	-	35	110	16	A425
BES2160M	□	8	-	40	120	16	A421
BES2160-C	□	8	-	40	140	16	A415
BES2160	□	8	-	40	140	16	A421
GBS4160	□	8	-	60	150	16	A426
GBD4160	□	8	-	60	250	16	A426
GBR4160	□	8	-	65	150	16	A425
GXB4160	□	8	-	65	230	16	A426
GBL4160	□	8	-	150	230	16	A425
GBS4170	□	8.5	-	60	150	16	A426
GBD4170	□	8.5	-	60	250	16	A426
GBR4170	□	8.5	-	65	150	16	A425
GXB4170	□	8.5	-	65	230	16	A426
GBL4170	□	8.5	-	150	230	16	A425
BEK2180	●	9	-	34	140	16	A161
BEK2180-C	□	9	-	34	140	16	A415
FE618	□	9	-	35	110	18	A425
BES2180M	□	9	-	40	130	16	A421
BES2180-C	□	9	-	40	140	16	A415
BES2180	□	9	-	40	140	16	A421
GBS4180	□	9	-	60	150	20	A426
GBD4180	□	9	-	60	250	20	A426
GBR4180	□	9	-	65	160	20	A425
GXB4180	□	9	-	65	250	16	A426
GBL4180	□	9	-	160	250	16	A425
EMBE3200-ATH	●	10	60	30	160	20	A110
BESL2200-S-C	□	10	90	30	150	20	A418
JBEL2200	□	10	115	30	200	20	A422
EPBT2200	●	10	-	30	160	20	A102
EMB3200-TH	△	10	-	30	160	20	A168
CEPB2200	□	10	-	30	160	20	A411
YB2200-CS	□	10	-	30	160	20	A422
JBEB2200	□	10	-	30	160	20	A422
HGOBLS2200-PN	●	10	-	30	250	18	A104
CEPBL2200	□	10	-	30	280	20	A411
FE620	□	10	-	35	110	20	A425
HGOB2200-PN	●	10	-	38	160	20	A104
BEK2200	●	10	-	38	160	20	A161
EPBC2200	□	10	-	38	160	20	A409
BEK2200-C	□	10	-	38	160	20	A415
BEKLS2200-C	□	10	-	38	280	20	A415
BES2200M	□	10	-	45	130	20	A421
BES2200-C	□	10	-	45	160	20	A415
BES2200	□	10	-	45	160	20	A421
GBS4200	□	10	-	60	150	20	A426
GBD4200	□	10	-	60	250	20	A426
GBR4200	□	10	-	75	160	20	A425
GXB4200	□	10	-	75	250	20	A426
GBL4200	□	10	-	180	250	20	A425
GBS4210	□	10.5	-	60	150	20	A426
GBD4210	□	10.5	-	60	250	20	A426
GBS4220	□	11	-	60	150	20	A426
GBD4220	□	11	-	60	250	20	A426
BESL2250-S-C	□	12.5	110	37	180	25	A418
CEPB2250	□	12.5	-	38	180	25	A411
CEPBL2250	□	12.5	-	38	300	25	A411
BES2250-C	□	12.5	-	50	180	25	A415
BES2250	□	12.5	-	50	180	25	A421
BEKLS2250-C	□	12.5	-	50	300	25	A415
GBS4250	□	12.5	-	60	180	25	A426
GBD4250	□	12.5	-	60	250	25	A426

商品コード Item Code	在庫 Stock	コーナ 半径 Corner radius	外径 Tool dia.	首下長 Under neck length	刃長 Flute length	全長 Overall length	シャンク径 Shank dia.	ページ Page
EPDREH2002-0.5-002-TH3	●	0.02	0.2	0.5	0.15	50	4	A172
EPDRE2002-0.5-002-ATH	●	0.02	0.2	0.5	0.15	50	4	A194
EPDREH2002-1-002-TH3	●	0.02	0.2	1	0.15	50	4	A172
EPDRE2002-1-002-ATH	●	0.02	0.2	1	0.15	50	4	A194
EPDRE2002-2-002-ATH	●	0.02	0.2	2	0.15	50	4	A194
CBN-EPDR2002-0.5-005	●	0.05	0.2	0.5	0.07	50	4	A281
EPDREH2002-0.5-005-TH3	●	0.05	0.2	0.5	0.15	50	4	A172
EPDRE2002-0.5-005-ATH	●	0.05	0.2	0.5	0.15	50	4	A194
EPDR2002-0.5-005-TH	△	0.05	0.2	0.5	0.15	50	4	A283
CBN-EPDR2002-1-005	●	0.05	0.2	1	0.07	50	4	A281
EPDREH2002-1-005-TH3	●	0.05	0.2	1	0.15	50	4	A172
EPDRE2002-1-005-ATH	●	0.05	0.2	1	0.15	50	4	A194
EPDR2002-1-005-TH	△	0.05	0.2	1	0.15	50	4	A283
EPDRE2002-1.5-005-TH3	●	0.05	0.2	1.5	0.15	50	4	A194
EPDR2002-1.5-005-TH	△	0.05	0.2	1.5	0.15	50	4	A283
EPDRE2002-2-005-ATH	●	0.05	0.2	2	0.15	50	4	A194
EPDR2002-2-005-TH	△	0.05	0.2	2	0.15	50	4	A283
EPDRP2002-2-09005-TH	●	0.05	0.2	2	0.15	50	4	A210
EPDREH2003-1-002-TH3	●	0.02	0.3	1	0.25	50	4	A172
EPDRE2003-1-002-ATH	●	0.02	0.3	1	0.25	50	4	A194
EPDREH2003-2-002-TH3	●	0.02	0.3	2	0.25	50	4	A172
EPDRE2003-2-002-ATH	●	0.02	0.3	2	0.25	50	4	A194
EPDRE2003-3-002-ATH	●	0.02	0.3	3	0.25	50	4	A194
CBN-EPDR2003-0.5-005	●	0.05	0.3	0.5	0.11	50	4	A281
CBN-EPDR2003-0.75-005	●	0.05	0.3	0.75	0.11	50	4	A281
EPDREH2003-1-005-TH3	●	0.05	0.3	1	0.25	50	4	A172
EPDRE2003-1-005-ATH	●	0.05	0.3	1	0.25	50	4	A194
EPDR2003-1-005-TH	△	0.05	0.3	1	0.25	50	4	A283
CBN-EPDR2003-1.5-005	●	0.05	0.3	1.5	0.11	50	4	A281
EPDRE2003-1.5-005-ATH	●	0.05	0.3	1.5	0.25	50	4	A194
EPDR2003-1.5-005-TH	△	0.05	0.3	1.5	0.25	50	4	A283
CBN-EPDR2003-2-005	●	0.05	0.3	2	0.11	50	4	A281
EPDREH2003-2-005-TH3	●	0.05	0.3	2	0.25	50	4	A172
EPDRE2003-2-005-ATH	●	0.05	0.3	2	0.25	50	4	A194
EPDR2003-2-005-TH	△	0.05	0.3	2	0.25	50	4	A283
EPDRE2003-2.5-005-ATH	●	0.05	0.3	2.5	0.25	50	4	A194
EPDR2003-2.5-005-TH	△	0.05	0.3	2.5	0.25	50	4	A283
EPDRE2003-3-005-ATH	●	0.05	0.3	3	0.25	50	4	A194
EPDR2003-3-005-TH	△	0.05	0.3	3	0.25	50	4	A283
EPDREH2004-1-002-TH3	●	0.02	0.4	1	0.3	50	4	A172
EPDRE2004-1-002-ATH	●	0.02	0.4	1	0.3	50	4	A194
EPDREH2004-2-002-TH3	●	0.02	0.4	2	0.3	50	4	A172
EPDRE2004-2-002-ATH	●	0.02	0.4	2	0.3	50	4	A194
EPDRE2004-3-002-ATH	●	0.02	0.4	3	0.3	50	4	A194
EPDRE2004-4-002-ATH	●	0.02	0.4	4	0.3	50	4	A194
CBN-EPDR2004-0.5-005	●	0.05	0.4	0.5	0.14	50	4	A281
CBN-EPDR2004-1-005	●	0.05	0.4	1	0.14	50	4	A281
EPDREH2004-1-005-TH3	●	0.05	0.4	1	0.3	50	4	A172
EPDRE2004-1-005-ATH	●	0.05	0.4	1	0.3	50	4	A194
EPDR2004-1-005-TH	△	0.05	0.4	1	0.3	50	4	A283
EPDRE2004-1.5-005-ATH	●	0.05	0.4	1.5	0.3	50	4	A194
EPDR2004-1.5-005-TH	△	0.05	0.4	1.5	0.3	50	4	A283
CBN-EPDR2004-2-005	●	0.05	0.4	2	0.14	50	4	A281
EPDREH2004-2-005-TH3	●	0.05	0.4	2	0.3	50	4	A172
EPDRE2004-2-005-ATH	●	0.05	0.4	2	0.3	50	4	A194
EPDR2004-2-005-TH	△	0.05	0.4	2	0.3	50	4	A283
EPDRE2004-2.5-005-ATH	●	0.05	0.4	2.5	0.3	50	4	A194
EPDR2004-2.5-005-TH	△	0.05	0.4	2.5	0.3	50	4	A283
EPDRE2004-3-005-ATH	●	0.05	0.4	3	0.3	50	4	A194
EPDR2004-3-005-TH	△	0.05	0.4	3	0.3	50	4	A283
EPDRE2004-3.5-005-ATH	●	0.05	0.4	3.5	0.3	50	4	A194
EPDR2004-3.5-005-TH	△	0.05	0.4	3.5	0.3	50	4	A283
EPDRE2004-4-005-ATH	●	0.05	0.4	4	0.3	50	4	A194
EPDR2004-4-005-TH	△	0.05	0.4	4	0.3	50	4	A283
EPDRP2004-4-09005-TH	●	0.05	0.4	4	0.3	50	4	A210
EPDRP2004-5-09005-TH	●	0.05	0.4	5	0.3	50	4	A210
EPDREH2004-1-01-TH3	●	0.1	0.4	1	0.3	50	4	A172
EPDRE2004-1-01-ATH	●	0.1	0.4	1	0.3	50	4	A194
EPDREH2004-2-01-TH3	●	0.1	0.4	2	0.3	50	4	A172

商品コード Item Code	在庫 Stock	コーナ 半径 Corner radius	外径 Tool dia.	首下長 Under neck length	刃長 Flute length	全長 Overall length	シャンク径 Shank dia.	ページ Page
EPDRE2004-2-01-ATH	●	0.1	0.4	2	0.3	50	4	A194
EPDR2004-2-01-TH	△	0.1	0.4	2	0.3	50	4	A283
EPDRE2004-3-01-ATH	●	0.1	0.4	3	0.3	50	4	A194
EPDR2004-3-01-TH	△	0.1	0.4	3	0.3	50	4	A283
EPDRE2004-4-01-ATH	●	0.1	0.4	4	0.3	50	4	A194
EPDR2004-4-01-TH	△	0.1	0.4	4	0.3	50	4	A283
EPDRP2004-4-0901-TH	●	0.1	0.4	4	0.3	50	4	A210
EPDRP2004-5-0901-TH	●	0.1	0.4	5	0.3	50	4	A210
EPDREH2005-1-002-TH3	●	0.02	0.5	1	0.35	50	4	A172
EPDRE2005-1-002-ATH	●	0.02	0.5	1	0.35	50	4	A194
EPDREH2005-2-002-TH3	●	0.02	0.5	2	0.35	50	4	A172
EPDRE2005-2-002-ATH	●	0.02	0.5	2	0.35	50	4	A194
EPDREH2005-3-002-TH3	●	0.02	0.5	3	0.35	50	4	A172
EPDRE2005-3-002-ATH	●	0.02	0.5	3	0.35	50	4	A194
EPDRE2005-4-002-ATH	●	0.02	0.5	4	0.35	50	4	A194
EPDRE2005-6-002-ATH	●	0.02	0.5	6	0.35	50	4	A194
CBN-EPDR2005-0.5-005	●	0.05	0.5	0.5	0.18	50	4	A281
EPDREH2005-1-005-TH3	●	0.05	0.5	1	0.35	50	4	A172
EPDRE2005-1-005-ATH								

Quick dimension reference table by mill diameter

外径別寸法早見表

超硬エンドミル・ラジラス

φ0.6 ~ φ1.75 Carbide End Mills -Radius

単位 unit : mm

商品コード Item Code	在庫 Stock	コーナ 半径 Corner radius	外径 Tool dia.	首下長 Under neck length	刃長 Flute length	全長 Overall length	シャンク 径 Shank dia.	ページ Page
EPDRE2006-8-005-ATH	●	0.05	0.6	8	0.4	50	4	A194
EPDRE2006-10-005-ATH	●	0.05	0.6	10	0.4	50	4	A194
CBN-EPDR2006-1.5-01	●	0.1	0.6	1.5	0.21	50	4	A281
EPDREH2006-2-01-TH3	●	0.1	0.6	2	0.4	50	4	A172
EPDRE2006-2-01-ATH	●	0.1	0.6	2	0.4	50	4	A194
EPDR2006-2-01-TH	△	0.1	0.6	2	0.4	50	4	A284
CBN-EPDR2006-3-01	●	0.1	0.6	3	0.21	50	4	A281
EPDREH2006-4-01-TH3	●	0.1	0.6	4	0.4	50	4	A172
EPDRE2006-4-01-ATH	●	0.1	0.6	4	0.4	50	4	A194
EPDR2006-4-01-TH	△	0.1	0.6	4	0.4	50	4	A284
EPDRE2006-6-01-ATH	●	0.1	0.6	6	0.4	50	4	A194
EPDR2006-6-01-TH	△	0.1	0.6	6	0.4	50	4	A284
EPDRE2006-8-01-ATH	●	0.1	0.6	8	0.4	50	4	A194
EPDR2006-8-01-TH	△	0.1	0.6	8	0.4	50	4	A284
EPDRE2006-10-01-ATH	●	0.1	0.6	10	0.4	50	4	A194
EPDR2006-10-01-TH	△	0.1	0.6	10	0.4	50	4	A284
EPDR2006-12-0901-TH	●	0.1	0.6	12	0.4	55	4	A210
EPDRP2006-15-0901-TH	●	0.1	0.6	15	0.4	55	4	A210
EPDRE2007-2-005-ATH	●	0.05	0.7	2	0.45	50	4	A195
EPDRE2007-4-005-ATH	●	0.05	0.7	4	0.45	50	4	A195
EPDRE2007-6-005-ATH	●	0.05	0.7	6	0.45	50	4	A195
EPDRE2007-2-01-ATH	●	0.1	0.7	2	0.45	50	4	A195
EPDRE2007-4-01-ATH	●	0.1	0.7	4	0.45	50	4	A195
EPDRE2007-6-01-ATH	●	0.1	0.7	6	0.45	50	4	A195
EPDREH2008-2-002-TH3	●	0.02	0.8	2	0.5	50	4	A172
EPDRE2008-2-002-ATH	●	0.02	0.8	2	0.5	50	4	A195
EPDREH2008-4-002-TH3	●	0.02	0.8	4	0.5	50	4	A172
EPDRE2008-4-002-ATH	●	0.02	0.8	4	0.5	50	4	A195
EPDRE2008-6-002-ATH	●	0.02	0.8	6	0.5	50	4	A195
EPDREH2008-2-005-TH3	●	0.05	0.8	2	0.5	50	4	A172
EPDRE2008-2-005-ATH	●	0.05	0.8	2	0.5	50	4	A195
EPDREH2008-4-005-TH3	●	0.05	0.8	4	0.5	50	4	A172
EPDRE2008-4-005-ATH	●	0.05	0.8	4	0.5	50	4	A195
EPDRE2008-6-005-ATH	●	0.05	0.8	6	0.5	50	4	A195
EPDRE2008-8-005-ATH	●	0.05	0.8	8	0.5	50	4	A195
EPDRE2008-12-005-ATH	●	0.05	0.8	12	0.5	55	4	A195
EPDREH2008-2-01-TH3	●	0.1	0.8	2	0.5	50	4	A172
EPDRE2008-2-01-ATH	●	0.1	0.8	2	0.5	50	4	A195
CBN-EPDR2008-2.5-01	●	0.1	0.8	2.5	0.28	50	4	A281
EPDREH2008-4-01-TH3	●	0.1	0.8	4	0.5	50	4	A172
EPDRE2008-4-01-ATH	●	0.1	0.8	4	0.5	50	4	A195
EPDR2008-4-01-TH	△	0.1	0.8	4	0.5	50	4	A284
CBN-EPDR2008-5-01	●	0.1	0.8	5	0.28	50	4	A281
EPDRE2008-6-01-ATH	●	0.1	0.8	6	0.5	50	4	A195
EPDR2008-6-01-TH	△	0.1	0.8	6	0.5	50	4	A284
EPDRE2008-8-01-ATH	●	0.1	0.8	8	0.5	50	4	A195
EPDR2008-8-01-TH	△	0.1	0.8	8	0.5	50	4	A284
EPDRE2008-12-01-ATH	●	0.1	0.8	12	0.5	55	4	A195
EPDR2008-12-01-TH	△	0.1	0.8	12	0.5	55	4	A284
EPDREH2008-2-02-TH3	●	0.2	0.8	2	0.5	50	4	A172
EPDRE2008-2-02-ATH	●	0.2	0.8	2	0.5	50	4	A195
EPDREH2008-4-02-TH3	●	0.2	0.8	4	0.5	50	4	A172
EPDRE2008-4-02-ATH	●	0.2	0.8	4	0.5	50	4	A195
EPDR2008-4-02-TH	△	0.2	0.8	4	0.5	50	4	A284
EPDRE2008-6-02-ATH	●	0.2	0.8	6	0.5	50	4	A195
EPDR2008-6-02-TH	△	0.2	0.8	6	0.5	50	4	A284
EPDRP2008-6-0402-TH	●	0.2	0.8	6	0.5	50	4	A210
EPDRE2008-8-02-ATH	●	0.2	0.8	8	0.5	50	4	A195
EPDRE2008-12-02-ATH	●	0.2	0.8	12	0.5	55	4	A195
EPDRP2008-12-0902-TH	●	0.2	0.8	12	0.5	55	4	A210
EPDREH4010-1.5-002-TH3	●	0.02	1	1.5	0.6	50	4	A174
EPDREH4010-2-002-TH3	●	0.02	1	2	0.6	50	4	A174
EPDREH2010-2-002-TH3	●	0.02	1	2	0.8	50	4	A173
EPDRE2010-2-002-ATH	●	0.02	1	2	0.8	50	4	A195
EPDREH4010-2.5-002-TH3	●	0.02	1	2.5	0.6	50	4	A174
EPDREH4010-3-002-TH3	●	0.02	1	3	0.6	50	4	A174
EPDREH4010-4-002-TH3	●	0.02	1	4	0.6	50	4	A174
EPDREH2010-4-002-TH3	●	0.02	1	4	0.8	50	4	A173
EPDRE2010-4-002-ATH	●	0.02	1	4	0.8	50	4	A195

商品コード Item Code	在庫 Stock	コーナ 半径 Corner radius	外径 Tool dia.	首下長 Under neck length	刃長 Flute length	全長 Overall length	シャンク 径 Shank dia.	ページ Page
EPDREH4010-5-002-TH3	●	0.02	1	5	0.6	50	4	A174
EPDREH4010-6-002-TH3	●	0.02	1	6	0.6	50	4	A174
EPDREH2010-6-002-TH3	●	0.02	1	6	0.8	50	4	A173
EPDRE2010-6-002-ATH	●	0.02	1	6	0.8	50	4	A195
EPDREH4010-8-002-TH3	●	0.02	1	8	0.6	50	4	A174
EPDREH2010-8-002-TH3	●	0.02	1	8	0.8	50	4	A173
EPDRE2010-8-002-ATH	●	0.02	1	8	0.8	50	4	A195
EPDRE2010-10-002-ATH	●	0.02	1	10	0.8	50	4	A195
EPDRE2010-12-002-ATH	●	0.02	1	12	0.8	55	4	A195
CBN-EPDR2010-1-005	●	0.05	1	1	0.35	50	4	A281
EPDREH4010-1.5-005-TH3	●	0.05	1	1.5	0.6	50	4	A174
EPDREH4010-2-005-TH3	●	0.05	1	2	0.6	50	4	A174
EPDREH2010-2-005-TH3	●	0.05	1	2	0.8	50	4	A173
EPDRE2010-2-005-ATH	●	0.05	1	2	0.8	50	4	A195
CBN-EPDR2010-2.5-005	●	0.05	1	2.5	0.35	50	4	A281
EPDREH4010-2.5-005-TH3	●	0.05	1	2.5	0.6	50	4	A174
EPDREH4010-3-005-TH3	●	0.05	1	3	0.6	50	4	A174
EPDRE2010-3-005-ATH	●	0.05	1	3	0.8	50	4	A195
EPDREH4010-4-005-TH3	●	0.05	1	4	0.6	50	4	A174
EPDREH2010-4-005-TH3	●	0.05	1	4	0.8	50	4	A173
EPDRE2010-4-005-ATH	●	0.05	1	4	0.8	50	4	A195
EPDRF4010-4-005-TH	●	0.05	1	4	0.8	50	4	A216
CBN-EPDR2010-5-005	●	0.05	1	5	0.35	50	4	A281
EPDREH4010-5-005-TH3	●	0.05	1	5	0.6	50	4	A174
EPDRE2010-5-005-ATH	●	0.05	1	5	0.8	50	4	A195
EPDREH4010-6-005-TH3	●	0.05	1	6	0.6	50	4	A174
EPDREH2010-6-005-TH3	●	0.05	1	6	0.8	50	4	A173
EPDRE2010-6-005-ATH	●	0.05	1	6	0.8	50	4	A195
EPDRF4010-6-005-TH	●	0.05	1	6	0.8	50	4	A216
EPDREH4010-8-005-TH3	●	0.05	1	8	0.6	50	4	A174
EPDREH2010-8-005-TH3	●	0.05	1	8	0.8	50	4	A173
EPDRE2010-8-005-ATH	●	0.05	1	8	0.8	50	4	A195
EPDRF4010-8-005-TH	●	0.05	1	8	0.8	50	4	A216
EPDRE2010-10-005-ATH	●	0.05	1	10	0.8	50	4	A195
EPDRF4010-10-005-TH	●	0.05	1	10	0.8	50	4	A216
EPDRE2010-12-005-ATH	●	0.05	1	12	0.8	55	4	A195
EPDRF4010-12-005-TH	●	0.05	1	12	0.8	60	4	A216
EPDRE2010-16-005-ATH	●	0.05	1	16	0.8	60	4	A195
EPDRF4010-16-005-TH	●	0.05	1	16	0.8	60	4	A216
EPDRE2010-20-005-ATH	●	0.05	1	20	0.8	60	4	A195
EPDRF4010-20-005-TH	●	0.05	1	20	0.8	60	4	A216
CBN-EPDR2010-1-01	●	0.1	1	1	0.35	50	4	A281
EPDREH4010-1.5-01-TH3	●	0.1	1	1.5	0.6	50	4	A174
EPDREH4010-2-01-TH3	●	0.1	1	2	0.6	50	4	A174
EPDREH2010-2-01-TH3	●	0.1	1	2	0.8	50	4	A173
EPDRE2010-2-01-ATH	●	0.1	1	2	0.8	50	4	A195
CBN-EPDR2010-2.5-01	●	0.1	1	2.5	0.35	50	4	A281
BHSR2010-0-2	□	0.1	1	2.5	0.5	60	6	A456
EPDREH4010-2.5-01-TH3	●	0.1	1	2.5	0.6	50	4	A174
EPDREH4010-3-01-TH3	●	0.1	1	3	0.6	50	4	A174
EPDRE2010-3-01-ATH	●	0.1	1	3	0.8	50	4	A195
EHHRE4010-S4-TH3	●	0.1	1	3	1	50	4	A263
EHHRE4010-S6-TH3	●	0.1	1	3	1	50	6	A263
EPDREH4010-4-01-TH3	●	0.1	1	4	0.6	50	4	A174
EPDREH2010-4-01-TH3	●	0.1	1	4	0.8	50	4	A173
EPDRE2010-4-01-ATH	●	0.1	1	4	0.8	50	4	A195
EPDRF4010-4-01-TH	●	0.1	1	4	0.8	50	4	A216
EPDR2010-4-01-TH	△	0.1	1	4	0.8	50	4	A284
CBN-EPDR2010-5-01	●	0.1	1	5	0.35	50	4	A281
EPDREH4010-5-01-TH3	●	0.1	1	5	0.6	50	4	A174
EPDRE2010-5-01-ATH	●	0.1	1	5	0.8	50	4	A195
EPSM4010-5-R0.1-PN	●	0.1	1	5	1.5	68	6	A238
EPDREH4010-6-01-TH3	●	0.1	1	6	0.6	50	4	A174
EPDREH2010-6-01-TH3	●	0.1	1	6	0.8	50	4	A173
EPDRE2010-6-01-ATH	●	0.1	1	6	0.8	50	4	A195
EPDRF4010-6-01-TH	●	0.1	1	6	0.8	50	4	A216
EPDR2010-6-01-TH	△	0.1	1	6	0.8	50	4	A284
EPDREH4010-8-01-TH3	●	0.1	1	8	0.6	50	4	A174
EPDREH2010-8-01-TH3	●	0.1	1	8	0.8	50	4	A173

商品コード Item Code	在庫 Stock	コーナ 半径 Corner radius	外径 Tool dia.	首下長 Under neck length	刃長 Flute length	全長 Overall length	シャンク 径 Shank dia.	ページ Page
EPDRE2010-8-01-ATH	●	0.1	1	8	0.8	50	4	A195
EPDRF4010-8-01-TH	●	0.1	1	8	0.8	50	4	A216
EPDR2010-8-01-TH	△	0.1	1	8	0.8	50	4	A284
EPDRE2010-10-01-ATH	●	0.1	1					

単位 unit : mm

商品コード Item Code	在庫 Stock	コーナ 半径 Corner radius	外径 Tool dia.	首下長 Under neck length	刃長 Flute length	全長 Overall length	シャンク径 Shank dia.	ページ Page
ETRP4010-25-02-TH	●	0.2	1	25	1	70	6	A222
ETRP4010-25-0902-TH	●	0.2	1	25	1	70	6	A223
ETRP4010-27.5-02-TH	●	0.2	1	27.5	1	70	6	A222
EPDRP2010-30-0902-TH	●	0.2	1	30	0.8	75	6	A210
ETRP4010-30-02-TH	●	0.2	1	30	1	70	6	A222
ETRP4010-30-0902-TH	●	0.2	1	30	1	80	6	A223
EGDR2010-30-02-HD	●	0.2	1	30	1.5	80	4	A277
EPDRP2010-35-0902-TH	●	0.2	1	35	0.8	80	6	A210
ETRP4010-35-0902-TH	●	0.2	1	35	1	80	6	A223
ETRP4010-40-0902-TH	●	0.2	1	40	1	90	6	A223
EGDR2010-40-02-HD	●	0.2	1	40	1.5	80	4	A277
ETRP4010-45-0902-TH	●	0.2	1	45	1	90	6	A223
ETRP4010-50-0902-TH	●	0.2	1	50	1	100	6	A223
EPDREH4010-1.5-03-TH3	●	0.3	1	1.5	0.6	50	4	A174
EPDREH4010-2-03-TH3	●	0.3	1	2	0.6	50	4	A174
EPDRE2010-2-03-ATH	●	0.3	1	2	0.8	50	4	A196
BHSR2010-0.3	□	0.3	1	2.5	0.5	60	6	A456
EPDREH4010-2.5-03-TH3	●	0.3	1	2.5	0.6	50	4	A174
EPDREH4010-3-03-TH3	●	0.3	1	3	0.6	50	4	A174
EPDRE2010-3-03-ATH	●	0.3	1	3	0.8	50	4	A196
EPDREH4010-4-03-TH3	●	0.3	1	4	0.6	50	4	A174
EPDRE2010-4-03-ATH	●	0.3	1	4	0.8	50	4	A196
EPDREH4010-5-03-TH3	●	0.3	1	5	0.6	50	4	A174
EPDRE2010-5-03-ATH	●	0.3	1	5	0.8	50	4	A196
EPDREH4010-6-03-TH3	●	0.3	1	6	0.6	50	4	A174
EPDRE2010-6-03-ATH	●	0.3	1	6	0.8	50	4	A196
EPDR2010-6-03-TH	△	0.3	1	6	0.8	50	4	A284
EPDREH4010-8-03-TH3	●	0.3	1	8	0.6	50	4	A174
EPDRE2010-8-03-ATH	●	0.3	1	8	0.8	50	4	A196
EPDRP2010-8-0403-TH	●	0.3	1	8	0.8	55	6	A210
EPDRE2010-10-03-ATH	●	0.3	1	10	0.8	50	4	A196
EPDR2010-10-03-TH	△	0.3	1	10	0.8	50	4	A284
EPDRE2010-12-03-ATH	●	0.3	1	12	0.8	55	4	A196
EPDRP2010-15-0903-TH	●	0.3	1	15	0.8	60	6	A210
EPDRE2010-16-03-ATH	●	0.3	1	16	0.8	60	4	A196
EPDR2010-16-03-TH	△	0.3	1	16	0.8	60	4	A284
EPDRE2010-20-03-ATH	●	0.3	1	20	0.8	60	4	A196
EPDR2010-20-03-TH	△	0.3	1	20	0.8	60	4	A284
EPDRP2010-25-0903-TH	●	0.3	1	25	0.8	70	6	A210
EPDRP2010-30-0903-TH	●	0.3	1	30	0.8	75	6	A210
EPDRE20125-5-01-ATH	●	0.1	1.25	5	1.15	50	4	A196
EPDRE20125-10-01-ATH	●	0.1	1.25	10	1.15	50	4	A196
EPDRE20125-15-01-ATH	●	0.1	1.25	15	1.15	55	4	A196
EPDRE20125-20-01-ATH	●	0.1	1.25	20	1.15	60	4	A196
EPDRE20125-5-02-ATH	●	0.2	1.25	5	1.15	50	4	A196
ETRA40125-5-02-TH	●	0.2	1.25	5	1.25	50	6	A222
EPDRE20125-10-02-ATH	●	0.2	1.25	10	1.15	50	4	A196
ETRA40125-10-02-TH	●	0.2	1.25	10	1.25	50	6	A222
ETRP40125-10-0902-TH	●	0.2	1.25	10	1.25	60	6	A223
EPDRE20125-15-02-ATH	●	0.2	1.25	15	1.15	55	4	A196
ETRA40125-15-02-TH	●	0.2	1.25	15	1.25	60	6	A222
ETRP40125-15-0902-TH	●	0.2	1.25	15	1.25	60	6	A223
EPDRE20125-20-02-ATH	●	0.2	1.25	20	1.15	60	4	A196
ETRA40125-20-02-TH	●	0.2	1.25	20	1.25	60	6	A222
ETRP40125-20-0902-TH	●	0.2	1.25	20	1.25	70	6	A223
ETRA40125-25-02-TH	●	0.2	1.25	25	1.25	70	6	A222
ETRA40125-30-02-TH	●	0.2	1.25	30	1.25	70	6	A222
ETRP40125-30-0902-TH	●	0.2	1.25	30	1.25	80	6	A223
ETRP40125-40-0902-TH	●	0.2	1.25	40	1.25	90	6	A223
EPDRE20125-50-0902-TH	●	0.2	1.25	50	1.25	100	6	A223
EPDRE20125-5-03-ATH	●	0.3	1.25	5	1.15	50	4	A196
EPDRE20125-10-03-ATH	●	0.3	1.25	10	1.15	50	4	A196
EPDRE20125-15-03-ATH	●	0.3	1.25	15	1.15	55	4	A196
EPDRE20125-20-03-ATH	●	0.3	1.25	20	1.15	60	4	A196
EPDREH4015-2-002-TH3	●	0.02	1.5	2	0.9	50	4	A175
EPDREH4015-3-002-TH3	●	0.02	1.5	3	0.9	50	4	A175
EPDREH4015-4-002-TH3	●	0.02	1.5	4	0.9	50	4	A175
EPDREH4015-5-002-TH3	●	0.02	1.5	5	0.9	50	4	A175
EPDREH4015-6-002-TH3	●	0.02	1.5	6	0.9	50	4	A175

商品コード Item Code	在庫 Stock	コーナ 半径 Corner radius	外径 Tool dia.	首下長 Under neck length	刃長 Flute length	全長 Overall length	シャンク径 Shank dia.	ページ Page
EPDREH4015-8-002-TH3	●	0.02	1.5	8	0.9	50	4	A175
EPDREH4015-10-002-TH3	●	0.02	1.5	10	0.9	50	4	A175
EPDREH4015-12-002-TH3	●	0.02	1.5	12	0.9	50	4	A175
CBN-EPDR2015-2-005	●	0.05	1.5	2	0.53	50	4	A281
EPDREH4015-2-005-TH3	●	0.05	1.5	2	0.9	50	4	A175
EPDREH4015-3-005-TH3	●	0.05	1.5	3	0.9	50	4	A175
EPDREH4015-4-005-TH3	●	0.05	1.5	4	0.9	50	4	A175
EPDRF4015-4-005-TH	●	0.05	1.5	4	1.35	50	4	A216
CBN-EPDR2015-5-005	●	0.05	1.5	5	0.53	50	4	A281
EPDREH4015-5-005-TH3	●	0.05	1.5	5	0.9	50	4	A175
EPDREH4015-6-005-TH3	●	0.05	1.5	6	0.9	50	4	A175
EPDREH4015-8-005-TH3	●	0.05	1.5	8	0.9	50	4	A175
EPDRF4015-8-005-TH	●	0.05	1.5	8	1.35	50	4	A216
EPDREH4015-10-005-TH3	●	0.05	1.5	10	0.9	50	4	A175
EPDREH4015-12-005-TH3	●	0.05	1.5	12	0.9	50	4	A175
EPDRF4015-12-005-TH	●	0.05	1.5	12	1.35	60	4	A216
EPDRF4015-15-005-TH	●	0.05	1.5	15	1.35	60	4	A216
EPDRF4015-20-005-TH	●	0.05	1.5	20	1.35	60	4	A216
CBN-EPDR2015-2-01	●	0.1	1.5	2	0.53	50	4	A281
EPDREH4015-2-01-TH3	●	0.1	1.5	2	0.9	50	4	A175
BHSR2015-0.1	□	0.1	1.5	2.5	0.75	60	6	A456
EPDREH4015-3-01-TH3	●	0.1	1.5	3	0.9	50	4	A175
EPDREH4015-4-01-TH3	●	0.1	1.5	4	0.9	50	4	A175
EPDRE2015-4-01-ATH	●	0.1	1.5	4	1.35	50	4	A196
EPDRF4015-4-01-TH	●	0.1	1.5	4	1.35	50	4	A216
EPDR2015-4-01-TH	△	0.1	1.5	4	1.35	50	4	A284
CBN-EPDR2015-5-01	●	0.1	1.5	5	0.53	50	4	A281
EPDREH4015-5-01-TH3	●	0.1	1.5	5	0.9	50	4	A175
EPDREH4015-6-01-TH3	●	0.1	1.5	6	0.9	50	4	A175
EPDRE2015-6-01-ATH	●	0.1	1.5	6	1.35	50	4	A196
EPDREH4015-8-01-TH3	●	0.1	1.5	8	0.9	50	4	A175
EPDRE2015-8-01-ATH	●	0.1	1.5	8	1.35	50	4	A196
EPDRF4015-8-01-TH	●	0.1	1.5	8	1.35	50	4	A216
EPDR2015-8-01-TH	△	0.1	1.5	8	1.35	50	4	A284
EPDREH4015-10-01-TH3	●	0.1	1.5	10	0.9	50	4	A175
EPDREH4015-12-01-TH3	●	0.1	1.5	12	0.9	50	4	A175
EPDRE2015-12-01-ATH	●	0.1	1.5	12	1.35	55	4	A196
EPDR2015-12-01-TH	△	0.1	1.5	12	1.35	55	4	A284
EPDRF4015-12-01-TH	●	0.1	1.5	12	1.35	60	4	A216
EPDRE2015-15-01-ATH	●	0.1	1.5	15	1.35	55	4	A196
EPDR2015-15-01-TH	△	0.1	1.5	15	1.35	55	4	A284
EPDRF4015-15-01-TH	●	0.1	1.5	15	1.35	60	4	A216
EPDRE2015-20-01-ATH	●	0.1	1.5	20	1.35	60	4	A196
EPDR2015-20-01-TH	△	0.1	1.5	20	1.35	60	4	A284
EPDREH4015-2-02-TH3	●	0.2	1.5	2	0.9	50	4	A175
BHSR2015-0.2	□	0.2	1.5	2.5	0.75	60	6	A456
EPDREH4015-3-02-TH3	●	0.2	1.5	3	0.9	50	4	A175
EPDREH4015-4-02-TH3	●	0.2	1.5	4	0.9	50	4	A175
EPDRE2015-4-02-ATH	●	0.2	1.5	4	1.35	50	4	A196
EPDR2015-4-02-TH	△	0.2	1.5	4	1.35	50	4	A284
CBN-EPDR2015-5-02	●	0.2	1.5	5	0.53	50	4	A281
EPDREH4015-5-02-TH3	●	0.2	1.5	5	0.9	50	4	A175
EPDREH4015-6-02-TH3	●	0.2	1.5	6	0.9	50	4	A175
EPDRE2015-6-02-ATH	●	0.2	1.5	6	1.35	50	4	A196
EPDREH4015-8-02-TH3	●	0.2	1.5	8	0.9	50	4	A175
EPDRE2015-8-02-ATH	●	0.2	1.5	8	1.35	50	4	A196
EPDR2015-8-02-TH	△	0.2	1.5	8	1.35	50	4	A284
CBN-EPDR2015-10-02	●	0.2	1.5	10	0.53	50	4	A281
EPDREH4015-10-02-TH3	●	0.2	1.5	10	0.9	50	4	A175
EPDRP2015-10-0402-TH	●	0.2	1.5	10	1.35	55	6	A210
EPDREH4015-12-02-TH3	●	0.2	1.5	12	0.9	50	4	A175
EPDRE2015-12-02-ATH	●	0.2	1.5	12	1.35	55	4	A196
EPDR2015-12-02-TH	△	0.2	1.5	12	1.35	55	4	A284
EPDRE2015-15-02-ATH	●	0.2	1.5	15	1.35	55	4	A196
EPDR2015-15-02-TH	△	0.2	1.5	15	1.35	55	4	A284
EPDRP2015-15-0902-TH	●	0.2	1.5	15	1.35	60	6	A210
EPDRE2015-20-02-ATH	●	0.2	1.5	20	1.35	60	4	A196
EPDR2015-20-02-TH	△	0.2	1.5	20	1.35	60	4	A284

商品コード Item Code	在庫 Stock	コーナ 半径 Corner radius	外径 Tool dia.	首下長 Under neck length	刃長 Flute length	全長 Overall length	シャンク径 Shank dia.	ページ Page
EPDRP2015-20-0902-TH	●	0.2	1.5	20	1.35	65	6	A210
EGDR2015-20-02-HD	●	0.2	1.5	20	2.25	60	4	A277
EPDRP2015-25-0902-TH	●	0.2	1.5	25	1.35	70	6	A210
EPDRP2015-30-0902-TH	●	0.2	1.5	30	1.35	75	6	A210
EGDR2015-40-02-HD	●	0.2	1.5	40	2.25	80	4	A27

Quick dimension reference table by mill diameter

外径別寸法早見表

超硬エンドミル・ラジラス

φ1.75 ~ φ4 Carbide End Mills -Radius

単位 unit : mm

商品コード Item Code	在庫 Stock	コーナ 半径 Corner radius	外径 Tool dia.	首下長 Under neck length	刃長 Flute length	全長 Overall length	シャンク 径 Shank dia.	ページ Page
ETRP40175-20-0903-TH	●	0.3	1.75	20	1.75	70	6	A223
ETRP40175-30-03-TH	●	0.3	1.75	30	1.75	70	6	A222
ETRP40175-30-0903-TH	●	0.3	1.75	30	1.75	80	6	A223
ETRP40175-40-03-TH	●	0.3	1.75	40	1.75	80	6	A222
ETRP40175-40-0903-TH	●	0.3	1.75	40	1.75	90	6	A223
ETRP40175-50-0903-TH	●	0.3	1.75	50	1.75	100	6	A223
EPDREH4020-2.5-002-TH3	●	0.02	2	2.5	1.2	50	4	A176
EPDREH4020-3-002-TH3	●	0.02	2	3	1.2	50	4	A176
EPDREH4020-4-002-TH3	●	0.02	2	4	1.2	50	4	A176
EPDREH4020-5-002-TH3	●	0.02	2	5	1.2	50	4	A176
EPDREH4020-6-002-TH3	●	0.02	2	6	1.2	50	4	A176
EPDREH4020-8-002-TH3	●	0.02	2	8	1.2	50	4	A176
EPDREH4020-10-002-TH3	●	0.02	2	10	1.2	50	4	A176
EPDREH4020-12-002-TH3	●	0.02	2	12	1.2	50	4	A176
EPDREH4020-2.5-005-TH3	●	0.05	2	2.5	1.2	50	4	A176
CBN-EPDR2020-3-005	●	0.05	2	3	0.7	50	4	A281
EPDREH4020-3-005-TH3	●	0.05	2	3	1.2	50	4	A176
EPDREH4020-4-005-TH3	●	0.05	2	4	1.2	50	4	A176
EPDRF4020-4-005-TH	●	0.05	2	4	1.7	50	4	A216
CBN-EPDR2020-5-005	●	0.05	2	5	0.7	50	4	A281
EPDREH4020-5-005-TH3	●	0.05	2	5	1.2	50	4	A176
EPDREH4020-6-005-TH3	●	0.05	2	6	1.2	50	4	A176
EPDRF4020-6-005-TH	●	0.05	2	6	1.7	50	4	A216
EPDREH4020-8-005-TH3	●	0.05	2	8	1.2	50	4	A176
EPDRF4020-8-005-TH	●	0.05	2	8	1.7	50	4	A216
CBN-EPDR2020-10-005	●	0.05	2	10	0.7	50	4	A281
EPDREH4020-10-005-TH3	●	0.05	2	10	1.2	50	4	A176
EPDREH4020-12-005-TH3	●	0.05	2	12	1.2	50	4	A176
EPDRF4020-12-005-TH	●	0.05	2	12	1.7	60	4	A216
EPDRF4020-16-005-TH	●	0.05	2	16	1.7	60	4	A216
EPDRF4020-20-005-TH	●	0.05	2	20	1.7	60	4	A216
BHSR2020-0.1	□	0.1	2	2.5	1	60	6	A456
EPDREH4020-2.5-01-TH3	●	0.1	2	2.5	1.2	50	4	A176
CBN-EPDR2020-3-01	●	0.1	2	3	0.7	50	4	A281
EPDREH4020-3-01-TH3	●	0.1	2	3	1.2	50	4	A176
EPDREH4020-4-01-TH3	●	0.1	2	4	1.2	50	4	A176
EPDRE2020-4-01-ATH	●	0.1	2	4	1.7	50	4	A197
EPDRF4020-4-01-TH	●	0.1	2	4	1.7	50	4	A216
CBN-EPDR2020-5-01	●	0.1	2	5	0.7	50	4	A281
EPDREH4020-5-01-TH3	●	0.1	2	5	1.2	50	4	A176
EPDREH4020-6-01-TH3	●	0.1	2	6	1.2	50	4	A176
EPDRE2020-6-01-ATH	●	0.1	2	6	1.7	50	4	A197
EPDRF4020-6-01-TH	●	0.1	2	6	1.7	50	4	A216
EHHRE4020-S4-TH3	●	0.1	2	6	2	50	4	A263
EHHRE4020-S6-TH3	●	0.1	2	6	2	50	6	A263
EPDREH4020-8-01-TH3	●	0.1	2	8	1.2	50	4	A176
EPDRE2020-8-01-ATH	●	0.1	2	8	1.7	50	4	A197
EPDRF4020-8-01-TH	●	0.1	2	8	1.7	50	4	A216
CBN-EPDR2020-10-01	●	0.1	2	10	0.7	50	4	A281
EPDREH4020-10-01-TH3	●	0.1	2	10	1.2	50	4	A176
EPDR2020-10-01-ATH	●	0.1	2	10	1.7	55	4	A197
EPDRF4020-10-01-TH	●	0.1	2	10	1.7	60	4	A216
EPDRE2020-16-01-ATH	●	0.1	2	16	1.7	55	4	A197
EPDRF4020-16-01-TH	●	0.1	2	16	1.7	60	4	A216
EPDRE2020-20-01-ATH	●	0.1	2	20	1.7	60	4	A197
EPDRF4020-20-01-TH	●	0.1	2	20	1.7	60	4	A216
EPDRE2020-25-01-ATH	●	0.1	2	25	1.7	65	4	A197
EPDRE2020-30-01-ATH	●	0.1	2	30	1.7	70	4	A197
EPDR2020-30-01-ATH	●	0.1	2	30	1.7	70	6	A235
BHSR2020-0.2	□	0.2	2	2.5	1	60	6	A456
EPDREH4020-2.5-02-TH3	●	0.2	2	2.5	1.2	50	4	A176
EPDREH4020-3-02-TH3	●	0.2	2	3	1.2	50	4	A176
EPDREH4020-4-02-TH3	●	0.2	2	4	1.2	50	4	A176
EPDRE2020-4-02-ATH	●	0.2	2	4	1.7	50	4	A197
EPDRF4020-4-02-TH	●	0.2	2	4	1.7	50	4	A216
CBN-EPDR2020-5-02	●	0.2	2	5	0.7	50	4	A281
EPDREH4020-5-02-TH3	●	0.2	2	5	1.2	50	4	A176

商品コード Item Code	在庫 Stock	コーナ 半径 Corner radius	外径 Tool dia.	首下長 Under neck length	刃長 Flute length	全長 Overall length	シャンク 径 Shank dia.	ページ Page
EPDREH4020-6-02-TH3	●	0.2	2	6	1.2	50	4	A176
EPDRE2020-6-02-ATH	●	0.2	2	6	1.7	50	4	A197
EPDRF4020-6-02-TH	●	0.2	2	6	1.7	50	4	A216
EPDR2020-6-02-TH	△	0.2	2	6	1.7	50	4	A285
EPDREH4020-8-02-TH3	●	0.2	2	8	1.2	50	4	A176
EPDRE2020-8-02-ATH	●	0.2	2	8	1.7	50	4	A197
EPDRF4020-8-02-TH	●	0.2	2	8	1.7	50	4	A216
EPDR2020-8-02-TH	△	0.2	2	8	1.7	50	4	A285
CBN-EPDR2020-10-02	●	0.2	2	10	0.7	50	4	A281
EPDREH4020-10-02-TH3	●	0.2	2	10	1.2	50	4	A176
EPDR2020-10-02-ATH	●	0.2	2	10	1.7	55	4	A197
EPDRF4020-10-02-TH	●	0.2	2	10	1.7	55	4	A216
EPDR2020-12-02-TH	△	0.2	2	12	1.7	55	4	A285
EPDRF4020-12-02-TH	●	0.2	2	12	1.7	60	4	A216
EPDR2020-16-02-ATH	●	0.2	2	16	1.7	55	4	A197
EPDR2020-16-02-TH	△	0.2	2	16	1.7	55	4	A285
EPDRF4020-16-02-TH	●	0.2	2	16	1.7	60	4	A216
CBN-EPDR2020-20-02	●	0.2	2	20	0.7	55	4	A281
EPDRE2020-20-02-ATH	●	0.2	2	20	1.7	60	4	A197
EPDRF4020-20-02-TH	●	0.2	2	20	1.7	60	4	A216
EPDR2020-20-02-TH	△	0.2	2	20	1.7	60	4	A285
EGDR2020-20-02-HD	●	0.2	2	20	3	60	4	A277
EPDRE2020-25-02-ATH	●	0.2	2	25	1.7	65	4	A197
EPDR2020-25-02-TH	△	0.2	2	25	1.7	65	4	A285
EPDRF4020-25-02-TH	●	0.2	2	25	1.7	70	4	A216
EPDRE2020-30-02-ATH	●	0.2	2	30	1.7	70	4	A197
EPDRF4020-30-02-TH	●	0.2	2	30	1.7	70	4	A216
EPDR2020-30-02-TH	△	0.2	2	30	1.7	70	4	A285
EPDRP2020-30-0902-TH	●	0.2	2	30	1.7	70	6	A211
EPDRP2020-40-0902-TH	●	0.2	2	40	1.7	80	6	A211
EGDR2020-40-02-HD	●	0.2	2	40	3	80	4	A277
EPDRP2020-50-0902-TH	●	0.2	2	50	1.7	90	6	A211
EGDR2020-60-02-HD	●	0.2	2	60	3	100	4	A277
EPDR2020-0.3	□	0.3	2	2.5	1	60	6	A456
EPDREH4020-2.5-03-TH3	●	0.3	2	2.5	1.2	50	4	A176
EPDREH4020-3-03-TH3	●	0.3	2	3	1.2	50	4	A176
EPDREH4020-4-03-TH3	●	0.3	2	4	1.2	50	4	A176
EPDRE2020-4-03-ATH	●	0.3	2	4	1.7	50	4	A197
EPDRF4020-4-03-TH	●	0.3	2	4	1.7	50	4	A217
EPDR2020-5-03-TH3	●	0.3	2	5	1.2	50	4	A176
EPDRF4020-5-03-TH3	●	0.3	2	5	1.2	50	4	A176
EPDRE2020-6-03-ATH	●	0.3	2	6	1.7	50	4	A197
EPDREH4020-8-03-TH3	●	0.3	2	8	1.2	50	4	A176
EPDRE2020-8-03-ATH	●	0.3	2	8	1.7	50	4	A197
EPDRF4020-8-03-TH	●	0.3	2	8	1.7	50	4	A217
EPDR2020-8-03-TH	△	0.3	2	8	1.7	50	4	A285
EPDREH4020-10-03-TH3	●	0.3	2	10	1.2	50	4	A176
EPDREH4020-12-03-TH3	●	0.3	2	12	1.2	50	4	A176
EPDRE2020-12-03-ATH	●	0.3	2	12	1.7	55	4	A197
EPDRP2020-12-0403-TH	●	0.3	2	12	1.7	55	6	A211
EPDRF4020-12-03-TH	●	0.3	2	12	1.7	60	4	A217
EPDRE2020-16-03-ATH	●	0.3	2	16	1.7	55	4	A197
EPDR2020-16-03-TH	△	0.3	2	16	1.7	55	4	A285
EPDRF4020-16-03-TH	●	0.3	2	16	1.7	60	4	A217
EPDRE2020-20-03-ATH	●	0.3	2	20	1.7	60	4	A197
EPDRF4020-20-03-TH	●	0.3	2	20	1.7	60	4	A217
EPDR2020-20-03-TH	△	0.3	2	20	1.7	60	4	A285
EPDRP2020-20-0903-TH	●	0.3	2	20	1.7	65	6	A211
EPDRE2020-25-03-ATH	●	0.3	2	25	1.7	65	4	A197
EPDRE2020-30-03-ATH	●	0.3	2	30	1.7	70	4	A197
EPDRP2020-30-0903-TH	●	0.3	2	30	1.7	70	6	A211
EPDRP2020-40-0903-TH	●	0.3	2	40	1.7	80	6	A211
EPDRP2020-50-0903-TH	●	0.3	2	50	1.7	90	6	A211
BHSR2020-0.5	□	0.5	2	2.5	1	60	6	A456
EPDREH4020-2.5-05-TH3	●	0.5	2	2.5	1.2	50	4	A176
EPDREH4020-3-05-TH3	●	0.5	2	3	1.2	50	4	A176
EPDREH4020-4-05-TH3	●	0.5	2	4	1.2	50	4	A176

商品コード Item Code	在庫 Stock	コーナ 半径 Corner radius	外径 Tool dia.	首下長 Under neck length	刃長 Flute length	全長 Overall length	シャンク 径 Shank dia.	ページ Page
EPDRF4020-4-05-TH	●	0.5	2	4	1.7	50	4	A217
EPDREH4020-5-05-TH3	●	0.5	2	5	1.2	50	4	A177
HGOF4020-05-TH	●	0.5	2	6	1	60	6	A232
EPDREH4020-6-05-TH3	●	0.5	2	6	1.2	50	4	A177
EPDRE2020-6-05-ATH	●	0.5	2	6	1.7	50	4	A197
EPDRF4020-6-05-TH	●	0.5	2	6	1.7	50	4	A217
EPDR2020-6-05-TH	△	0.5	2	6	1.7	50	4	A285
HGOF2020-05-TH	●	0.5	2	6	3	60	6	A232
ETM4020-05-TH	●	0.5	2	6	4	70	6	A226
EPR3020-05	□	0.5						

単位 unit : mm

商品コード Item Code	在庫 Stock	コーナ 半径 Corner radius	外径 Tool dia.	首下長 Under neck length	刃長 Flute length	全長 Overall length	シャンク径 Shank dia.	ページ Page
EPDR2020-20-08-TH	△	0.8	2	20	1.7	60	4	A285
EPDRE2020-25-08-ATH	●	0.8	2	25	1.7	65	4	A197
EPDRE2020-30-08-ATH	●	0.8	2	30	1.7	70	4	A197
EPDRF4025-8-01-TH	●	0.1	2.5	8	2	50	4	A217
EPDRE2025-10-01-ATH	●	0.1	2.5	10	2	50	4	A197
EPDRF4025-16-01-TH	●	0.1	2.5	16	2	60	4	A217
EPDRE2025-20-01-ATH	●	0.1	2.5	20	2	60	4	A217
EPDRF4025-20-01-TH	●	0.1	2.5	20	2	60	4	A217
EPDRE2025-30-01-ATH	●	0.1	2.5	30	2	70	4	A197
EPDRF4025-8-02-TH	●	0.2	2.5	8	2	50	4	A217
EPDRE2025-10-02-ATH	●	0.2	2.5	10	2	50	4	A197
EPDRF4025-16-02-TH	●	0.2	2.5	16	2	60	4	A217
EPDRE2025-20-02-ATH	●	0.2	2.5	20	2	60	4	A217
EPDRF4025-20-02-TH	●	0.2	2.5	20	2	60	4	A217
EPDRE2025-30-02-ATH	●	0.2	2.5	30	2	70	4	A197
EPDRE2025-10-03-ATH	●	0.3	2.5	10	2	50	4	A197
EPDRF4025-12-03-TH	●	0.3	2.5	12	2	60	4	A217
EPDRE2025-20-03-ATH	●	0.3	2.5	20	2	60	4	A197
EPDRF4025-20-03-TH	●	0.3	2.5	20	2	60	4	A217
EPDRE2025-30-03-ATH	●	0.3	2.5	30	2	70	4	A197
EPDRE2025-10-05-ATH	●	0.5	2.5	10	2	50	4	A197
ETR4025-10-05-TH	●	0.5	2.5	10	2.5	50	6	A222
EPDRF4025-12-05-TH	●	0.5	2.5	12	2	60	4	A217
EPDRE2025-20-05-ATH	●	0.5	2.5	20	2	60	4	A217
EPDRF4025-20-05-TH	●	0.5	2.5	20	2	60	4	A217
ETRP4025-20-05-TH	●	0.5	2.5	20	2.5	60	6	A222
ETRP4025-20-0905-TH	●	0.5	2.5	20	2.5	70	6	A223
EPDRE2025-30-05-ATH	●	0.5	2.5	30	2	70	4	A197
ETRA4025-30-05-TH	●	0.5	2.5	30	2.5	70	6	A222
ETRP4025-30-0905-TH	●	0.5	2.5	30	2.5	80	6	A223
ETRA4025-40-05-TH	●	0.5	2.5	40	2.5	90	6	A223
ETRP4025-40-0905-TH	●	0.5	2.5	40	2.5	90	6	A223
ETRP4025-50-0905-TH	●	0.5	2.5	50	2.5	100	6	A223
ETRP4025-60-0905-TH	●	0.5	2.5	60	2.5	110	6	A223
EPDREH4030-4-005-TH3	●	0.05	3	4	1.8	50	6	A177
CBN-EPDR2030-6-005	●	0.05	3	6	1.05	50	4	A281
EPDREH4030-6-005-TH3	●	0.05	3	6	1.8	50	6	A177
EPDREH4030-8-005-TH3	●	0.05	3	8	1.8	55	6	A177
EPDREH4030-10-005-TH3	●	0.05	3	10	1.8	55	6	A177
EPDREH4030-12-005-TH3	●	0.05	3	12	1.8	60	6	A177
EPDREH4030-14-005-TH3	●	0.05	3	14	1.8	60	6	A177
EPDREH4030-16-005-TH3	●	0.05	3	16	1.8	60	6	A177
EPDREH4030-18-005-TH3	●	0.05	3	18	1.8	65	6	A177
EPDREH4030-20-005-TH3	●	0.05	3	20	1.8	65	6	A177
EPDREH4030-4-01-TH3	●	0.1	3	4	1.8	50	6	A177
CBN-EPDR2030-6-01	●	0.1	3	6	1.05	50	4	A281
EPDREH4030-6-01-TH3	●	0.1	3	6	1.8	50	6	A177
EPDRE2030-6-01-ATH	●	0.1	3	6	2.5	50	6	A197
EPDREH4030-8-01-TH3	●	0.1	3	8	1.8	55	6	A177
EPDRE2030-8-01-ATH	●	0.1	3	8	2.5	55	6	A197
EPDRF4030-8-01-TH	●	0.1	3	8	2.5	60	6	A217
EPDREH4030-10-01-TH3	●	0.1	3	10	1.8	55	6	A177
EPDRF4030-12-01-TH3	●	0.1	3	12	1.8	60	6	A177
EPDRE2030-12-01-ATH	●	0.1	3	12	2.5	60	6	A197
EPDREH4030-14-01-TH3	●	0.1	3	14	1.8	60	6	A177
EPDREH4030-16-01-TH3	●	0.1	3	16	1.8	60	6	A177
EPDRE2030-16-01-ATH	●	0.1	3	16	2.5	60	6	A197
EPDRF4030-16-01-TH	●	0.1	3	16	2.5	60	6	A217
EPDREH4030-18-01-TH3	●	0.1	3	18	1.8	65	6	A177
EPDRE2030-18-01-ATH	●	0.1	3	18	2.5	65	6	A197
EPDREH4030-20-01-TH3	●	0.1	3	20	1.8	65	6	A177
EPDRE2030-20-01-ATH	●	0.1	3	20	2.5	65	6	A197
EPDRF4030-25-01-TH	●	0.1	3	25	2.5	70	6	A217
EPDRE2030-30-01-ATH	●	0.1	3	30	2.5	75	6	A197
EPDRF4030-30-01-TH	●	0.1	3	30	2.5	80	6	A217
EPDRE2030-35-01-ATH	●	0.1	3	35	2.5	80	6	A197
EPDREH4030-4-02-TH3	●	0.2	3	4	1.8	50	6	A177
EPDREH4030-6-02-TH3	●	0.2	3	6	1.8	50	6	A177

商品コード Item Code	在庫 Stock	コーナ 半径 Corner radius	外径 Tool dia.	首下長 Under neck length	刃長 Flute length	全長 Overall length	シャンク径 Shank dia.	ページ Page
EPDRE2030-6-02-ATH	●	0.2	3	6	2.5	50	6	A198
EPDREH4030-8-02-TH3	●	0.2	3	8	1.8	55	6	A177
EPDRE2030-8-02-ATH	●	0.2	3	8	2.5	55	6	A198
EPDR2030-8-02-TH	△	0.2	3	8	2.5	55	6	A285
EPDRF4030-8-02-TH	●	0.2	3	8	2.5	60	6	A217
EHHRE4030-S4-TH3	●	0.2	3	9	3	60	4	A263
EHHRE4030-S6-TH3	●	0.2	3	9	3	60	6	A263
EPDREH4030-10-02-TH3	●	0.2	3	10	1.8	55	6	A177
EPPLS4030-02	●	0.2	3	10.5	4.5	80	6	A250
EPDREH4030-12-02-TH3	●	0.2	3	12	1.8	60	6	A177
EPDRE2030-12-02-ATH	●	0.2	3	12	2.5	60	6	A198
EPDRF4030-12-02-TH	●	0.2	3	12	2.5	60	6	A217
EPDR2030-12-02-TH	△	0.2	3	12	2.5	60	6	A285
EPDREH4030-14-02-TH3	●	0.2	3	14	1.8	60	6	A177
EPSM4030-15-R0.2-PN	●	0.2	3	15	4.5	68	6	A238
EPDREH4030-16-02-TH3	●	0.2	3	16	1.8	60	6	A177
EPDRE2030-16-02-ATH	●	0.2	3	16	2.5	60	6	A198
EPDRF4030-16-02-TH	●	0.2	3	16	2.5	60	6	A217
EPDR2030-16-02-TH	△	0.2	3	16	2.5	60	6	A285
EPDREH4030-18-02-TH3	●	0.2	3	18	1.8	65	6	A177
EPDRE2030-18-02-ATH	●	0.2	3	18	2.5	65	6	A198
EPDREH4030-20-02-TH3	●	0.2	3	20	1.8	65	6	A177
EPDRE2030-20-02-ATH	●	0.2	3	20	2.5	65	6	A198
EPDR2030-20-02-TH	△	0.2	3	20	2.5	65	6	A285
EPDRF4030-20-02-TH	●	0.2	3	20	2.5	70	6	A217
EGDR2030-20-02-HD	●	0.2	3	20	4.5	60	4	A277
EPDRF4030-25-02-TH	●	0.2	3	25	2.5	70	6	A217
EPDRE2030-30-02-ATH	●	0.2	3	30	2.5	75	6	A198
EPDR2030-30-02-TH	△	0.2	3	30	2.5	75	6	A285
EPDRF4030-30-02-TH	●	0.2	3	30	2.5	80	6	A217
EPDR2030-35-02-ATH	●	0.2	3	35	2.5	80	6	A198
EPDR2030-35-02-TH	△	0.2	3	35	2.5	80	6	A285
EPDRP2030-40-0902-TH	●	0.2	3	40	2.5	80	6	A211
EGDR2030-40-02-HD	●	0.2	3	40	4.5	80	4	A277
EPDRP2030-50-0902-TH	●	0.2	3	50	2.5	90	6	A211
EPDRP2030-60-0902-TH	●	0.2	3	60	2.5	100	6	A211
EGDR2030-60-02-HD	●	0.2	3	60	4.5	100	4	A277
EPSM4030-R0.2-PN	●	0.2	3	-	7.5	56	6	A235
EPP4030-02-TH	●	0.2	3	-	8	60	6	A247
EPP4030-02	●	0.2	3	-	8	60	6	A249
EPDREH4030-4-03-TH3	●	0.3	3	4	1.8	50	6	A177
EPDREH4030-6-03-TH3	●	0.3	3	6	1.8	50	6	A177
EPDRE2030-6-03-ATH	●	0.3	3	6	2.5	50	6	A198
EPDREH4030-8-03-TH3	●	0.3	3	8	1.8	55	6	A177
EPDRE2030-8-03-ATH	●	0.3	3	8	2.5	55	6	A198
EPDR2030-8-03-TH	△	0.3	3	8	2.5	55	6	A285
EPDRF4030-8-03-TH	●	0.3	3	8	2.5	60	6	A217
EPDREH4030-10-03-TH3	●	0.3	3	10	1.8	55	6	A177
EPDREH4030-12-03-TH3	●	0.3	3	12	1.8	60	6	A177
EPDRE2030-12-03-ATH	●	0.3	3	12	2.5	60	6	A198
EPDREH4030-14-03-TH3	●	0.3	3	14	1.8	60	6	A177
EPDREH4030-16-03-TH3	●	0.3	3	16	1.8	60	6	A177
EPDRE2030-16-03-ATH	●	0.3	3	16	2.5	60	6	A198
EPDRF4030-16-03-TH	●	0.3	3	16	2.5	60	6	A217
EPDR2030-16-03-TH	△	0.3	3	16	2.5	60	6	A285
EPDREH4030-18-03-TH3	●	0.3	3	18	1.8	65	6	A177
EPDRE2030-18-03-ATH	●	0.3	3	18	2.5	65	6	A198
EPDREH4030-20-03-TH3	●	0.3	3	20	1.8	65	6	A177
EPDRE2030-20-03-ATH	●	0.3	3	20	2.5	65	6	A198
EPDR2030-20-03-TH	△	0.3	3	20	2.5	65	6	A285
EPDRF4030-20-03-TH	●	0.3	3	20	2.5	70	6	A217
EPDRF4030-25-03-TH	●	0.3	3	25	2.5	70	6	A217
EPDRE2030-30-03-ATH	●	0.3	3	30	2.5	75	6	A198
EPDR2030-30-03-TH	△	0.3	3	30	2.5	75	6	A285
EPDRF4030-30-03-TH	●	0.3	3	30	2.5	80	6	A217
EPDR2030-35-03-ATH	●	0.3	3	35	2.5	80	6	A198
EPDRP2030-40-0903-TH	●	0.3	3	40	2.5	80	6	A211
EPDRP2030-50-0903-TH	●	0.3	3	50	2.5	90	6	A211
EPDRP2030-60-0903-TH	●	0.3	3	60	2.5	100	6	A211

商品コード Item Code	在庫 Stock	コーナ 半径 Corner radius	外径 Tool dia.	首下長 Under neck length	刃長 Flute length	全長 Overall length	シャンク径 Shank dia.	ページ Page
EPDREH4030-4-05-TH3	●	0.5	3	4	1.8	50	6	A177
CBN-EPDR2030-6-05	●	0.5	3	6	1.05	50	4	A281
EPDREH4030-6-05-TH3	●	0.5	3	6	1.8	50	6	A177
EPDREH4030-8-05-TH3	●	0.5	3	8	1.8	55	6	A177
EPDRE2030-8-05-ATH	●	0.5	3	8	2.5	55	6	A198
EPDR2030-8-05-TH	△	0.5	3	8	2.5	55	6	A285
EPDRF4030-8-05-TH	●	0.5	3	8	2.5	60	6	A217
EMXA3030-9-05	◎	0.5	3	9	4.5	60	6	A272
EPDREH4030-10-05-TH3	●	0.5	3	10	1.8			

Quick dimension reference table by mill diameter

外径別寸法早見表

超硬エンドミル・ラジラス

φ4~φ10 Carbide End Mills-Radius

単位 unit : mm

商品コード Item Code	在庫 Stock	コーナ 半径 Corner radius	外径 Tool dia.	首下長 Under neck length	刃長 Flute length	全長 Overall length	シャンク 径 Shank dia.	ページ Page
EPDRE2040-12-01-ATH	●	0.1	4	12	3.5	60	6	A198
EPDREH4040-12-01-TH3	●	0.1	4	12	3.5	60	6	A178
EPDRF4040-12-01-TH	●	0.1	4	12	4	60	6	A218
EPDREH4040-14-01-TH3	●	0.1	4	14	3.5	60	6	A178
EPDRE2040-16-01-ATH	●	0.1	4	16	3.5	60	6	A198
EPDREH4040-16-01-TH3	●	0.1	4	16	3.5	60	6	A178
EPDREH4040-18-01-TH3	●	0.1	4	18	3.5	60	6	A178
EPDRE2040-20-01-ATH	●	0.1	4	20	3.5	65	6	A198
EPDREH4040-20-01-TH3	●	0.1	4	20	3.5	65	6	A178
EPDRF4040-20-01-TH	●	0.1	4	20	4	60	6	A218
EPDREH4040-22-01-TH3	●	0.1	4	22	3.5	65	6	A178
EPDREH4040-24-01-TH3	●	0.1	4	24	3.5	70	6	A178
EPDRE2040-30-01-ATH	●	0.1	4	30	3.5	75	6	A198
EPDRF4040-30-01-TH	●	0.1	4	30	4	80	6	A218
EPDRE2040-35-01-ATH	●	0.1	4	35	3.5	80	6	A198
EPDRF4040-40-01-TH	●	0.1	4	40	4	80	6	A218
EPDRE2040-45-01-ATH	●	0.1	4	45	3.5	90	6	A198
EPDRE2040-8-02-ATH	●	0.2	4	8	3.5	55	6	A198
EPDREH4040-8-02-TH3	●	0.2	4	8	3.5	55	6	A178
EPDRE2040-10-02-TH3	●	0.2	4	10	3.5	60	6	A178
EPDRE2040-12-02-ATH	●	0.2	4	12	3.5	60	6	A198
EPDREH4040-12-02-TH3	●	0.2	4	12	3.5	60	6	A178
EHHRE6040-S4-TH3	●	0.2	4	12	4	60	4	A263
EPDRF4040-12-02-TH	●	0.2	4	12	4	60	6	A218
EHHRE6040-S6-TH3	●	0.2	4	12	4	60	6	A263
EPDRE2040-14-02-TH3	●	0.2	4	14	3.5	60	6	A178
EPPLS4040-02	●	0.2	4	14	6	80	6	A250
EPDRE2040-16-02-ATH	●	0.2	4	16	3.5	60	6	A198
EPDREH4040-16-02-TH3	●	0.2	4	16	3.5	60	6	A178
EPDREH4040-18-02-TH3	●	0.2	4	18	3.5	60	6	A178
EPDRE2040-20-02-ATH	●	0.2	4	20	3.5	65	6	A198
EPDREH4040-20-02-TH3	●	0.2	4	20	3.5	65	6	A178
EPDRF4040-20-02-TH	●	0.2	4	20	4	60	6	A218
EPSM4040-20-R0.2-PN	●	0.2	4	20	6	68	6	A238
EPDREH4040-22-02-TH3	●	0.2	4	22	3.5	65	6	A178
EPDREH4040-24-02-TH3	●	0.2	4	24	3.5	70	6	A178
EPDRE2040-30-02-ATH	●	0.2	4	30	3.5	75	6	A198
EPDRF4040-30-02-TH	●	0.2	4	30	4	80	6	A218
EPDRE2040-35-02-ATH	●	0.2	4	35	3.5	80	6	A198
EPDRF4040-40-02-TH	●	0.2	4	40	4	80	6	A218
EPDRE2040-45-02-ATH	●	0.2	4	45	3.5	90	6	A198
EPSM4040-R0.2-PN	●	0.2	4	-	10	56	6	A235
EPP4040-02-TH	●	0.2	4	-	11	60	6	A247
EPP4040-02	●	0.2	4	-	11	60	6	A249
EPDRE2040-8-03-ATH	●	0.3	4	8	3.5	55	6	A198
EPDREH4040-8-03-TH3	●	0.3	4	8	3.5	55	6	A178
EPDREH4040-10-03-TH3	●	0.3	4	10	3.5	60	6	A178
EPDRE2040-12-03-ATH	●	0.3	4	12	3.5	60	6	A198
EPDREH4040-12-03-TH3	●	0.3	4	12	3.5	60	6	A178
EPDRF4040-12-03-TH	●	0.3	4	12	4	60	6	A218
EPDREH4040-14-03-TH3	●	0.3	4	14	3.5	60	6	A178
EPJS2040-03-J	□	0.3	4	14	6	70	4	A427
EPDRE2040-16-03-ATH	●	0.3	4	16	3.5	60	6	A198
EPDREH4040-16-03-TH3	●	0.3	4	16	3.5	60	6	A178
EPDREH4040-18-03-TH3	●	0.3	4	18	3.5	60	6	A178
EPDRE2040-20-03-ATH	●	0.3	4	20	3.5	65	6	A198
EPDREH4040-20-03-TH3	●	0.3	4	20	3.5	65	6	A178
EPDRF4040-20-03-TH	●	0.3	4	20	4	60	6	A218
EPDREH4040-22-03-TH3	●	0.3	4	22	3.5	65	6	A178
EPDREH4040-24-03-TH3	●	0.3	4	24	3.5	70	6	A178
EPJLS2040-03-J	□	0.3	4	24	6	100	4	A427
EPDRE2040-30-03-ATH	●	0.3	4	30	3.5	75	6	A198
EPDRF4040-30-03-TH	●	0.3	4	30	4	80	6	A218
EPDRE2040-35-03-ATH	●	0.3	4	35	3.5	80	6	A198
EPDRF4040-40-03-TH	●	0.3	4	40	4	80	6	A218
EPDRE2040-45-03-ATH	●	0.3	4	45	3.5	90	6	A198
EPDREH4040-8-05-TH3	●	0.5	4	8	3.5	55	6	A178
EPDREH4040-10-05-TH3	●	0.5	4	10	3.5	60	6	A178
EPDRE2040-12-05-ATH	●	0.5	4	12	3.5	60	6	A198

商品コード Item Code	在庫 Stock	コーナ 半径 Corner radius	外径 Tool dia.	首下長 Under neck length	刃長 Flute length	全長 Overall length	シャンク 径 Shank dia.	ページ Page
EPDREH4040-12-05-TH3	●	0.5	4	12	3.5	60	6	A178
EPDRF4040-12-05-TH	●	0.5	4	12	4	60	6	A218
EMXA3040-12-05	◎	0.5	4	12	6	60	6	A272
EPDREH4040-14-05-TH3	●	0.5	4	14	3.5	60	6	A178
EPPLS4040-05	●	0.5	4	14	6	80	6	A250
EPDRE2040-16-05-ATH	●	0.5	4	16	3.5	60	6	A198
EPDREH4040-16-05-TH3	●	0.5	4	16	3.5	60	6	A178
EPDRE2040-18-05-TH3	●	0.5	4	18	3.5	60	6	A178
EPDRE2040-20-05-ATH	●	0.5	4	20	3.5	65	6	A198
EPDREH4040-20-05-TH3	●	0.5	4	20	3.5	65	6	A178
EPDRF4040-20-05-TH	●	0.5	4	20	4	60	6	A218
EPSM4040-20-R0.5-PN	●	0.5	4	20	6	68	6	A238
EPDREH4040-22-05-TH3	●	0.5	4	22	3.5	65	6	A178
EPDREH4040-24-05-TH3	●	0.5	4	24	3.5	70	6	A178
EPDRE2040-30-05-ATH	●	0.5	4	30	3.5	75	6	A198
EPDRF4040-30-05-TH	●	0.5	4	30	4	80	6	A218
EPDRE2040-35-05-ATH	●	0.5	4	35	3.5	80	6	A198
EPDRF4040-40-05-TH	●	0.5	4	40	4	80	6	A218
EGR2040-05-HD	●	0.5	4	40	8	100	4	A279
EPDRE2040-45-05-ATH	●	0.5	4	45	3.5	90	6	A198
EPSM4040-R0.5-PN	●	0.5	4	-	10	56	6	A235
EPP4040-05-TH	●	0.5	4	-	11	60	6	A247
EPP4040-05	●	0.5	4	-	11	60	6	A249
EPDREH4040-8-10-TH3	●	1	4	8	3.5	55	6	A178
EPDREH4040-10-10-TH3	●	1	4	10	3.5	60	6	A178
HGOF4040-10-TH	●	1	4	12	2	60	6	A232
EPDRE2040-12-1-ATH	●	1	4	12	3.5	60	6	A199
EPDREH4040-12-10-TH3	●	1	4	12	3.5	60	6	A178
HGOF2040-10-TH	●	1	4	12	6	60	6	A232
ETM4040-10-TH	●	1	4	12	8	70	6	A226
EPR3040-10	□	1	4	12	8	70	6	A429
EPDREH4040-14-10-TH3	●	1	4	14	3.5	60	6	A178
EPDRE2040-16-1-ATH	●	1	4	16	3.5	60	6	A199
EPDREH4040-16-10-TH3	●	1	4	16	3.5	60	6	A178
EPDREH4040-18-10-TH3	●	1	4	18	3.5	60	6	A178
EPDRE2040-20-1-ATH	●	1	4	20	3.5	65	6	A199
EPDREH4040-20-10-TH3	●	1	4	20	3.5	65	6	A178
EPSM4040-20-R1.0-PN	●	1	4	20	6	68	6	A238
ETMLN4040-20-10-TH	●	1	4	20	6	70	4	A226
EPDREH4040-22-10-TH3	●	1	4	22	3.5	65	6	A178
EPDREH4040-24-10-TH3	●	1	4	24	3.5	70	6	A178
ETMP4040-24-10-TH	●	1	4	24	6	90	6	A227
EPRPN3040-24-10	□	1	4	24	6	90	6	A429
ETMLN4040-28-10-TH	●	1	4	28	6	70	4	A226
EPDRE2040-30-1-ATH	●	1	4	30	3.5	75	6	A199
ETMP4040-32-10-TH	●	1	4	32	6	90	6	A227
EPRPN3040-32-10	□	1	4	32	6	90	6	A429
EPDRE2040-35-1-ATH	●	1	4	35	3.5	80	6	A199
ETMP4040-40-10-TH	●	1	4	40	6	90	6	A227
EPRPN3040-40-10	□	1	4	40	6	90	6	A429
EPDRE2040-45-1-ATH	●	1	4	45	3.5	90	6	A199
EPSM4040-R1.0-PN	●	1	4	-	10	56	6	A235
EPP4040-10-TH	●	1	4	-	11	60	6	A247
EPP4040-10	●	1	4	-	11	60	6	A249
EPDREH4050-10-01-TH3	●	0.1	5	10	4	60	6	A178
EPDREH4050-15-01-TH3	●	0.1	5	15	4	60	6	A178
EPDRE2050-20-01-ATH	●	0.1	5	20	4	65	6	A199
EPDREH4050-20-01-TH3	●	0.1	5	20	4	65	6	A178
EPDRF4050-20-01-TH	●	0.1	5	20	5	70	6	A218
EPDREH4050-25-01-TH3	●	0.1	5	25	4	70	6	A178
EPDRE2050-40-01-ATH	●	0.1	5	40	4	85	6	A199
EPDRF4050-40-01-TH	●	0.1	5	40	5	90	6	A218
EPDREH4050-10-02-TH3	●	0.2	5	10	4	60	6	A178
EPDREH4050-15-02-TH3	●	0.2	5	15	4	60	6	A178
EPPLS4050-02	●	0.2	5	17.5	7.5	100	6	A250
EPDRE2050-20-02-ATH	●	0.2	5	20	4	65	6	A199
EPDREH4050-20-02-TH3	●	0.2	5	20	4	65	6	A179
EPDRF4050-20-02-TH	●	0.2	5	20	5	70	6	A218
EPDREH4050-25-02-TH3	●	0.2	5	25	4	70	6	A179

商品コード Item Code	在庫 Stock	コーナ 半径 Corner radius	外径 Tool dia.	首下長 Under neck length	刃長 Flute length	全長 Overall length	シャンク 径 Shank dia.	ページ Page
EPSM4050-25-R0.2-PN	●	0.2	5	25	7.5	68	6	A238
EPDRE2050-40-02-ATH	●	0.2	5	40	4	85	6	A199
EPDRF4050-40-02-TH	●	0.2	5	40	5	90	6	A218
EPSM4050-R0.2-PN	●	0.2	5	-	12.5	56	6	A235
EPP4050-02-TH	●	0.2	5	-	13	60	6	A247
EPP4050-02	●	0.2	5	-	13	60	6	A249
EPDREH4050-10-03-TH3	●	0.3	5	10	4	60	6	A179
EPDREH4050-15-03-TH3	●	0.3	5	15	4	60	6	A179
EHHRE6050-TH3	●	0.3						

単位 unit : mm

商品コード Item Code	在庫 Stock	コーナ 半径 Corner radius	外径 Tool dia.	首下長 Under neck length	刃長 Flute length	全長 Overall length	シャンク 径 Shank dia.	ページ Page
EPDRF4060-54-02-TH	●	0.2	6	54	6	100	6	A218
EPDRE2060-55-02-ATH	●	0.2	6	55	5	100	6	A199
EPDRF4060-72-02-TH	●	0.2	6	72	6	120	6	A218
EPDRE2060-12-03-ATH	●	0.3	6	12	5	50	6	A199
EPDRH4060-12-03-TH3	●	0.3	6	12	5	60	6	A179
EPDRE2060-18-03-ATH	●	0.3	6	18	5	60	6	A199
EPDRH4060-18-03-TH3	●	0.3	6	18	5	60	6	A179
EHHRE6060-TH3	●	0.3	6	18	6	60	6	A263
EPDRE2060-24-03-ATH	●	0.3	6	24	5	70	6	A199
EPDRH4060-24-03-TH3	●	0.3	6	24	5	70	6	A179
EPDRH4060-30-03-TH3	●	0.3	6	30	5	80	6	A179
EPDRF4060-30-03-TH	●	0.3	6	30	6	80	6	A218
EPSM4060-30-R0.3-PN	●	0.3	6	30	9	68	6	A238
EPDR2060-35-03-ATH	●	0.3	6	35	5	80	6	A199
EPDRF4060-54-03-TH	●	0.3	6	54	6	100	6	A218
EPDRE2060-55-03-ATH	●	0.3	6	55	5	100	6	A199
EPDRF4060-72-03-TH	●	0.3	6	72	6	120	6	A218
EPPLS4060-03	●	0.3	6	-	9	120	5	A250
EPP4060-03-TH	●	0.3	6	-	13	60	6	A247
EPP4060-03	●	0.3	6	-	13	60	6	A249
EPSM4060-R0.3-PN	●	0.3	6	-	15	56	6	A235
CEPR6060-03-TH	●	0.3	6	-	15	60	6	A265
CEPR6060-03	●	0.3	6	-	15	60	6	A267
EPFML4060-R0.3-PN	□	0.3	6	-	30	70	6	A237
EPDRH4060-12-05-TH3	●	0.5	6	12	5	60	6	A179
EPDRE2060-18-05-ATH	●	0.5	6	18	5	60	6	A199
EPDRH4060-18-05-TH3	●	0.5	6	18	5	60	6	A179
EMXN4060-18-05-TH	●	0.5	6	18	9	60	6	A260
EMXA3060-18-05	◎	0.5	6	18	9	80	6	A272
EPJS2060-05-J	□	0.5	6	21	9	90	6	A427
ER5HS06-PN	●	0.5	6	21	18	60	6	A257
EPDRE2060-24-05-ATH	●	0.5	6	24	5	70	6	A199
EPDRH4060-24-05-TH3	●	0.5	6	24	5	70	6	A179
EPDRH4060-30-05-TH3	●	0.5	6	30	5	80	6	A179
EPDRF4060-30-05-TH	●	0.5	6	30	6	80	6	A218
EPSM4060-30-R0.5-PN	●	0.5	6	30	9	68	6	A238
ER5HS06-30-PN	●	0.5	6	30	18	70	6	A257
EPDRE2060-35-05-ATH	●	0.5	6	35	5	80	6	A199
EPJSL2060-05-J	□	0.5	6	36	9	120	6	A427
EPDRF4060-54-05-TH	●	0.5	6	54	6	100	6	A218
EPDRE2060-55-05-ATH	●	0.5	6	55	5	100	6	A199
EGR2060-05-HD	●	0.5	6	60	12	120	6	A279
EPDRF4060-72-05-TH	●	0.5	6	72	6	120	6	A218
EPPLS4060-05	●	0.5	6	-	9	120	5	A250
EPP4060-05-TH	●	0.5	6	-	13	60	6	A247
EPP4060-05	●	0.5	6	-	13	60	6	A249
EPSM4060-R0.5-PN	●	0.5	6	-	15	56	6	A235
CEPR6060-05-TH	●	0.5	6	-	15	60	6	A265
CEPR6060-05	●	0.5	6	-	15	60	6	A267
EAP4060-05-TH	◎	0.5	6	-	15	60	6	A269
EAP6060-05-TH	◎	0.5	6	-	15	60	6	A269
EPPL4060-05	●	0.5	6	-	25	70	6	A249
EPFML4060-R0.5-PN	□	0.5	6	-	30	70	6	A237
SCE6060-R0.75	●	0.75	6	-	6	60	6	A280
EPDRH4060-12-10-TH3	●	1	6	12	5	60	6	A179
EPDRE2060-18-1-ATH	●	1	6	18	5	60	6	A199
EPDRH4060-18-10-TH3	●	1	6	18	5	60	6	A179
ER8WB0800LN-20-R1.0-ATH	●	1	6	20	7	70	6	A254
EPJS2060-10-J	□	1	6	21	9	90	6	A427
EPDRE2060-24-1-ATH	●	1	6	24	5	70	6	A199
EPDRH4060-24-10-TH3	●	1	6	24	5	70	6	A179
EPDRH4060-30-10-TH3	●	1	6	30	5	80	6	A179
EPDRF4060-30-10-TH	●	1	6	30	6	80	6	A218
ER8WB0800LN-30-R1.0-ATH	●	1	6	30	7	80	6	A254
EPSM4060-30-R1.0-PN	●	1	6	30	9	68	6	A238
EPDR2060-35-1-ATH	●	1	6	35	5	80	6	A199
EPJSL2060-10-J	□	1	6	36	9	120	6	A427
ER8WB0800LN-40-R1.0-ATH	●	1	6	40	7	90	6	A254
ER8WB0800LN-50-R1.0-ATH	●	1	6	50	7	100	6	A254

商品コード Item Code	在庫 Stock	コーナ 半径 Corner radius	外径 Tool dia.	首下長 Under neck length	刃長 Flute length	全長 Overall length	シャンク 径 Shank dia.	ページ Page
EPDRF4060-54-10-TH	●	1	6	54	6	100	6	A218
EPDRE2060-55-1-ATH	●	1	6	55	5	100	6	A199
EPDRF4060-72-10-TH	●	1	6	72	6	120	6	A218
EPPLS4060-10	●	1	6	-	9	120	5	A250
EPP4060-10-TH	●	1	6	-	13	60	6	A247
EPP4060-10	●	1	6	-	13	60	6	A249
EPSM4060-R1.0-PN	●	1	6	-	15	56	6	A235
CEPR6060-10-TH	●	1	6	-	15	60	6	A265
CEPR6060-10	●	1	6	-	15	60	6	A267
EAP4060-10-TH	◎	1	6	-	15	60	6	A269
EAP6060-10-TH	◎	1	6	-	15	60	6	A269
EPPL4060-10	●	1	6	-	25	70	6	A249
EPFML4060-R1.0-PN	□	1	6	-	30	70	6	A237
HGOF4060-15-TH	●	1.5	6	18	3	60	6	A232
HGOF2060-15-TH	●	1.5	6	18	9	60	6	A232
EMXR4060-18-15-TH	●	1.5	6	18	9	60	6	A259
EMXN4060-18-15-TH	●	1.5	6	18	9	60	6	A260
EPSM4060-30-R1.5-PN	●	1.5	6	30	9	68	6	A238
ETMLN4060-30-15-TH	●	1.5	6	30	9	75	6	A226
EMXR4060-30-15-TH	●	1.5	6	30	9	75	6	A259
EMXN4060-30-15-TH	●	1.5	6	30	9	75	6	A260
ETMP4060-40-15-TH	●	1.5	6	40	9	100	8	A227
EPRPN3060-40-15	□	1.5	6	40	9	100	8	A429
ETMLN4060-42-15-TH	●	1.5	6	42	9	90	6	A226
ETMLN4060-54-15-TH	●	1.5	6	54	9	100	6	A226
ETMP4060-55-15-TH	●	1.5	6	55	9	110	8	A227
EPRPN3060-55-15	□	1.5	6	55	9	110	8	A429
ETMP4060-67-15-TH	●	1.5	6	67	9	125	8	A227
EPRPN3060-67-15	□	1.5	6	67	9	125	8	A429
ETM4060-15-TH	●	1.5	6	-	12	90	6	A226
EPR3060-15	□	1.5	6	-	12	90	6	A429
EPP4060-15-TH	●	1.5	6	-	13	60	6	A247
EPP4060-15	●	1.5	6	-	13	60	6	A249
EPSM4060-R1.5-PN	●	1.5	6	-	15	56	6	A235
EPFML4060-R1.5-PN	□	1.5	6	-	30	70	6	A237
EPSM4070-35-R0.3-PN	●	0.3	7	35	10.5	80	8	A238
EPMS4070-03	●	0.3	7	-	9	120	6	A250
EPSM4070-R0.3-PN	●	0.3	7	-	17.5	63	8	A235
EPMS4070-35-R0.5-PN	●	0.5	7	35	10.5	80	8	A238
EPPLS4070-05	●	0.5	7	-	9	120	6	A250
EPSM4070-R0.5-PN	●	0.5	7	-	17.5	63	8	A235
EPMS4070-35-R1.0-PN	●	1	7	35	10.5	80	8	A238
EPPLS4070-10	●	1	7	-	9	120	6	A250
EPSM4070-R1.0-PN	●	1	7	-	17.5	63	8	A235
ER8WB0700LS-R1.0-ATH	●	1	7	-	8	90	6	A254
EPSM4080-40-R0.3-PN	●	0.3	8	40	12	80	8	A238
EPP4080-03-TH	●	0.3	8	-	19	75	8	A247
EPP4080-03	●	0.3	8	-	19	75	8	A249
EPSM4080-R0.3-PN	●	0.3	8	-	20	63	8	A235
CEPR6080-03-TH	●	0.3	8	-	20	75	8	A265
CEPR6080-03	●	0.3	8	-	20	75	8	A267
EPFML4080-R0.3-PN	□	0.3	8	-	40	80	8	A237
EHHRE6080-TH3	●	0.5	8	24	8	75	8	A263
EMXN4080-24-05-TH	●	0.5	8	24	12	75	8	A260
EMXA3080-24-05	◎	0.5	8	24	12	90	8	A272
EPJS2080-05-J	□	0.5	8	28	12	100	8	A427
EPMS4080-40-R0.3-PN	●	0.5	8	40	12	80	8	A238
EPJSL2080-05-J	□	0.5	8	48	12	135	8	A427
EGR2080-05-HD	●	0.5	8	80	16	140	8	A279
EPPLS4080-10	●	0.5	8	-	12	135	7	A250
EPP4080-05-TH	●	0.5	8	-	19	75	8	A247
EPP4080-05	●	0.5	8	-	19	75	8	A249
EPSM4080-R0.5-PN	●	0.5	8	-	20	63	8	A235
CEPR6080-05-TH	●	0.5	8	-	20	75	8	A265
CEPR6080-05	●	0.5	8	-	20	75	8	A267
EAP4080-05-TH	◎	0.5	8	-	20	75	8	A269
EAP6080-05-TH	◎	0.5	8	-	20	75	8	A269
EPPL4080-05	●	0.5	8	-	35	90	8	A249
EPFML4080-R0.5-PN	□	0.5	8	-	40	80	8	A237

商品コード Item Code	在庫 Stock	コーナ 半径 Corner radius	外径 Tool dia.	首下長 Under neck length	刃長 Flute length	全長 Overall length	シャンク 径 Shank dia.	ページ Page
EPJS2080-10-J	□	1	8	28	12	100	8	A427
ER5HS08-PN	●	1	8	28	24	75	8	A257
ER8WB0800LN-30-R1.0-ATH	●	1	8	30	9	75	8	A254
ER8WB0800LN-40-R1.0-ATH	●	1	8	40	9	90	8	A254
EPSM4080-40-R1.0-PN	●	1	8	40	12	80	8	A238
ER5HS08-40-PN	●	1	8	40	24	80	8	A257
EPJSL2080-10-J	□	1	8	48	12	135	8	A427
ER8WB0800LN-50-R1.0-ATH	●	1	8	50	9	100	8	A254
ER8WB0800LN-60-R1.0-ATH	●	1	8	60	9	110	8	A254
SCE6080-R1.00	●	1	8	-	8	70	8	A280
EPPLS4080-10	●	1	8	-	12	135	7	A250
EPP4080-10-TH	●	1	8	-	19	75	8	A247
EPP4080-10	●	1	8	-	19	75	8	A249
EPSM4080-R1.0-PN	●	1	8	-	20	63	8	A235
CEPR6080-10-TH	●	1	8	-	20	75	8	A265
CEPR6080-10	●	1	8	-	20	75	8	A267
EAP4080-10-TH	◎	1	8	-	20	75	8	A269
EAP6080-10-TH	◎	1	8	-				

Quick dimension reference table by mill diameter

外径別寸法早見表

超硬エンドミル・ラジアス

φ10~φ30 Carbide End Mills -Radius

単位 unit : mm

商品コード Item Code	在庫 Stock	コーナ 半径 Corner radius	外径 Tool dia.	首下長 Under neck length	刃長 Flute length	全長 Overall length	シャンク 径 Shank dia.	ページ Page
EPJS2100-05-J	●	0.5	10	35	15	100	10	A427
EPMS4100-50-R0.5-PN	●	0.5	10	50	15	94	10	A238
EPJLS2100-05-J	●	0.5	10	60	15	150	10	A427
EGR2100-05-HD	●	0.5	10	100	20	150	10	A279
EHHRE6100-TH3	●	0.5	10	210	10	80	10	A263
EPPLS4100-05	●	0.5	10	-	15	150	9	A250
EPP4100-05-TH	●	0.5	10	-	22	80	10	A247
EPP4100-05	●	0.5	10	-	22	80	10	A249
EPMS4100-R0.5-PN	●	0.5	10	-	25	74	10	A235
CEPR6100-05-TH	●	0.5	10	-	25	80	10	A265
CEPR6100-05	●	0.5	10	-	25	80	10	A267
EAP4100-05-TH	◎	0.5	10	-	25	80	10	A269
EAP6100-05-TH	◎	0.5	10	-	25	80	10	A269
EPP4100-05	●	0.5	10	-	45	100	10	A249
EPSML4100-R0.5-PN	□	0.5	10	-	50	100	10	A237
EMXA3100-30-10	◎	1	10	30	15	100	10	A272
ER8WB100LN-35-R1.0-ATH	●	1	10	35	11	80	10	A254
EPJS2100-10-J	□	1	10	35	15	100	10	A427
ERHS10-10-PN	●	1	10	35	30	80	10	A257
EMXA2100-45-10	◎	1	10	45	8	80	10	A272
ER8WB100LN-50-R1.0-ATH	●	1	10	50	11	100	10	A254
EPMS4100-50-R1.0-PN	●	1	10	50	15	94	10	A238
ERHS10-50-PN	●	1	10	50	30	100	10	A257
ER8WB100LN-60-R1.0-ATH	●	1	10	60	11	110	10	A254
EPJLS2100-10-J	□	1	10	60	15	150	10	A427
ER8WB100LN-80-R1.0-ATH	●	1	10	80	11	130	10	A254
EPPLS4100-10	●	1	10	-	15	150	9	A250
EPP4100-10-TH	●	1	10	-	22	80	10	A247
EPP4100-10	●	1	10	-	22	80	10	A249
EPMS4100-R1.0-PN	●	1	10	-	25	74	10	A235
CEPR6100-10-TH	●	1	10	-	25	80	10	A265
CEPR6100-10	●	1	10	-	25	80	10	A267
EAP4100-10-TH	◎	1	10	-	25	80	10	A269
EAP6100-10-TH	◎	1	10	-	25	80	10	A269
EPPL4100-10	●	1	10	-	45	100	10	A249
EPSML4100-R1.0-PN	□	1	10	-	50	100	10	A237
SCE6100-R1.25	●	1.25	10	-	10	80	10	A280
EPMS4100-50-R1.5-PN	●	1.5	10	50	15	94	10	A238
EPPLS4100-15	●	1.5	10	-	15	150	9	A250
EPP4100-15-TH	●	1.5	10	-	22	80	10	A247
EPP4100-15	●	1.5	10	-	22	80	10	A249
EPMS4100-R1.5-PN	●	1.5	10	-	25	74	10	A235
CEPR6100-15-TH	●	1.5	10	-	25	80	10	A265
CEPR6100-15	●	1.5	10	-	25	80	10	A267
EAP4100-15-TH	◎	1.5	10	-	25	80	10	A269
EAP6100-15-TH	◎	1.5	10	-	25	80	10	A269
EPPL4100-15	●	1.5	10	-	45	100	10	A249
EPSML4100-R1.5-PN	□	1.5	10	-	50	100	10	A237
HGOF4100-20-TH	●	2	10	30	5	80	10	A232
HGOF2100-20-TH	●	2	10	30	15	80	10	A232
EMXR4100-30-20-TH	●	2	10	30	15	80	10	A259
EMXN4100-30-20-TH	●	2	10	30	15	80	10	A260
EPJS2100-20-J	□	2	10	35	15	100	10	A427
EPMS4100-50-R2.0-PN	●	2	10	50	15	94	10	A238
ETMLN4100-50-20-TH	●	2	10	50	15	100	10	A226
EMXR4100-50-20-TH	●	2	10	50	15	100	10	A259
EMXN4100-50-20-TH	●	2	10	50	15	100	10	A260
EPJLS2100-20-J	□	2	10	60	15	150	10	A427
ETMLN4100-70-20-TH	●	2	10	70	15	120	10	A226
ETMP4100-73-20-TH	●	2	10	73	15	135	12	A227
EPRPN3100-73-20	□	2	10	73	15	135	12	A429
ETMLN4100-90-20-TH	●	2	10	90	15	140	10	A226
ETMP4100-95-20-TH	●	2	10	95	15	150	16	A227
EPRPN3100-95-20	□	2	10	95	15	150	16	A429
ETMP4100-115-20-TH	●	2	10	115	15	170	16	A227
EPRPN3100-115-20	□	2	10	115	15	170	16	A429
ETM4100-20-TH	●	2	10	-	20	110	10	A226
EPR3100-20	□	2	10	-	20	110	10	A429
EPP4100-20-TH	●	2	10	-	22	80	10	A247

商品コード Item Code	在庫 Stock	コーナ 半径 Corner radius	外径 Tool dia.	首下長 Under neck length	刃長 Flute length	全長 Overall length	シャンク 径 Shank dia.	ページ Page
EPP4100-20	●	2	10	-	22	80	10	A249
EPMS4100-R2.0-PN	●	2	10	-	25	74	10	A235
CEPR6100-20-TH	●	2	10	-	25	80	10	A265
CEPR6100-20	●	2	10	-	25	80	10	A267
EAP4100-20-TH	◎	2	10	-	25	80	10	A269
EAP6100-20-TH	◎	2	10	-	25	80	10	A269
EPL4100-20	●	2	10	-	45	100	10	A249
EPSML4100-R2.0-PN	□	2	10	-	50	100	10	A237
EPMS4110-55-R0.3-PN	●	0.3	11	55	16.5	110	12	A238
EPMS4110-R0.3-PN	●	0.3	11	-	27.5	86	12	A235
EPMS4110-55-R0.5-PN	●	0.5	11	55	16.5	110	12	A238
EPPLS4110-05	●	0.5	11	-	15	150	10	A250
EPMS4110-R0.5-PN	●	0.5	11	-	27.5	86	12	A235
EPMS4110-55-R1.0-PN	●	1	11	55	16.5	110	12	A238
EPPLS4110-10	●	1	11	-	15	150	10	A250
EPMS4110-R1.0-PN	●	1	11	-	27.5	86	12	A235
ER8WB1100LS-R1.0-ATH	●	1	11	-	12	110	10	A254
EPPLS4110-15	●	1.5	11	-	15	150	10	A250
EPMS4120-60-R0.3-PN	●	0.3	12	60	18	110	12	A238
EPMS4120-R0.3-PN	●	0.3	12	-	30	86	12	A235
EPSML4120-R0.3-PN	□	0.3	12	-	60	120	12	A237
EHHRE6120-TH3	●	0.5	12	36	12	100	12	A263
EMXN4120-36-05-TH	●	0.5	12	36	18	100	12	A260
EPJS2120-05-J	□	0.5	12	42	18	110	12	A427
EPMS4120-60-R0.5-PN	●	0.5	12	60	18	110	12	A238
EPJLS2120-05-J	□	0.5	12	72	18	160	12	A427
EHX12-EPP4120-05-TH	●	0.5	12	-	9.6	19	-	A399
EPPLS4120-05	●	0.5	12	-	18	160	11	A250
EPP4120-05-TH	●	0.5	12	-	26	100	12	A247
EPP4120-05	●	0.5	12	-	26	100	12	A249
EPMS4120-R0.5-PN	●	0.5	12	-	30	86	12	A235
CEPR6120-05-TH	●	0.5	12	-	30	100	12	A265
CEPR6120-05	●	0.5	12	-	30	100	12	A267
EAP4120-05-TH	◎	0.5	12	-	30	100	12	A269
EAP6120-05-TH	◎	0.5	12	-	30	100	12	A269
EPL4120-05	●	0.5	12	-	55	120	12	A249
EPMS4120-R0.5-PN	□	0.5	12	-	60	120	12	A237
EMXA3120-36-10	◎	1	12	36	18	120	12	A272
ER8WB1200LN-40-R1.0-ATH	●	1	12	40	13	90	12	A254
EPJS2120-10-J	□	1	12	42	18	110	12	A427
ERHS12-20-PN	●	1	12	42	36	100	12	A257
EMXA2120-60-10	◎	1	12	60	10	100	12	A272
ER8WB1200LN-60-R1.0-ATH	●	1	12	60	13	110	12	A254
EPMS4120-60-R1.0-PN	●	1	12	60	18	110	12	A238
ERHS12-60-PN	●	1	12	60	36	120	12	A257
EPJLS2120-10-J	□	1	12	72	18	160	12	A427
ER8WB1200LN-80-R1.0-ATH	●	1	12	80	13	130	12	A254
ER8WB1200LN-100-R1.0-ATH	●	1	12	100	13	150	12	A254
EHX12-EPP4120-10-TH	●	1	12	-	9.6	19	-	A399
EPPLS4120-10	●	1	12	-	18	160	11	A250
EPP4120-10-TH	●	1	12	-	26	100	12	A247
EPP4120-10	●	1	12	-	26	100	12	A249
EPMS4120-R1.0-PN	●	1	12	-	30	86	12	A235
CEPR6120-10-TH	●	1	12	-	30	100	12	A265
CEPR6120-10	●	1	12	-	30	100	12	A267
EAP4120-10-TH	◎	1	12	-	30	100	12	A269
EAP6120-10-TH	◎	1	12	-	30	100	12	A269
EPL4120-10	●	1	12	-	55	120	12	A249
EPSML4120-R1.0-PN	□	1	12	-	60	120	12	A237
EPMS4120-60-R1.5-PN	●	1.5	12	60	18	110	12	A238
EHX12-EPP4120-15-TH	●	1.5	12	-	9.6	19	-	A399
SCE6120-R1.50	●	1.5	12	-	12	80	12	A280
EPPLS4120-15	●	1.5	12	-	18	160	11	A250
EPP4120-15-TH	●	1.5	12	-	26	100	12	A247
EPP4120-15	●	1.5	12	-	26	100	12	A249
EPMS4120-R1.5-PN	●	1.5	12	-	30	86	12	A235
CEPR6120-15-TH	●	1.5	12	-	30	100	12	A265
CEPR6120-15	●	1.5	12	-	30	100	12	A267
EAP4120-15-TH	◎	1.5	12	-	30	100	12	A269

商品コード Item Code	在庫 Stock	コーナ 半径 Corner radius	外径 Tool dia.	首下長 Under neck length	刃長 Flute length	全長 Overall length	シャンク 径 Shank dia.	ページ Page
EAP6120-15-TH	◎	1.5	12	-	30	100	12	A269
EPPL4120-15	●	1.5	12	-	55	120	12	A249
EPSML4120-R1.5-PN	□	1.5	12	-	60	120	12	A237
HGOF4120-20-TH	●	2	12	36	6	100	12	A232
HGOF2120-20-TH	●	2	12	36	18	100	12	A232
EMXR4120-36-20-TH	●	2	12	36	18	100	12	A259
EMXN4120-36-20-TH	●	2	12	36	18	100	12	A260
EPJS2120-20-J	□	2	12	42	18	110	12	A427
ETMLN4120-60-20-TH	●	2	12	60	18	110	12	A226
EPMS4120-60-R2.0-PN	●	2	12	60	18	110	12	A238
EMXR4120-60-20-TH	●	2	12	60	18	110	12	A259
EMXN4120-60-20-TH	●	2	12	60	18	110	12	A260
EPJLS2120-20-J	□	2	12	72	18			

単位 unit : mm

商品コード Item Code	在庫 Stock	コーナ 半径 Corner radius	外径 Tool dia.	首下長 Under neck length	刃長 Flute length	全長 Overall length	シャンク径 Shank dia.	ページ Page
EPSM4150-R0.5-PN	□	0.5	15	-	37.5	110	16	A236
EPSM4150-75-R1.0-PN	□	1	15	75	22.5	135	16	A239
EPSM4150-R1.0-PN	□	1	15	-	37.5	110	16	A236
EPSM4150-75-R1.5-PN	□	1.5	15	75	22.5	135	16	A239
EPSM4150-R1.5-PN	□	1.5	15	-	37.5	110	16	A236
EPSM4150-75-R2.0-PN	□	2	15	75	22.5	135	16	A239
EPSM4150-R2.0-PN	□	2	15	-	37.5	110	16	A236
EPSM4150-75-R3.0-PN	□	3	15	75	22.5	135	16	A239
EPSM4150-R3.0-PN	□	3	15	-	37.5	110	16	A236
EPSM4160-80-R0.5-PN	●	0.5	16	80	24	135	16	A239
EPSM4160-R0.5-PN	●	0.5	16	-	40	110	16	A236
EPSSL4160-R0.5-PN	□	0.5	16	-	80	135	16	A237
EMXA3160-45-10	◎	1	16	45	19	90	16	A272
ER5HS16-PN	●	1	16	56	48	110	16	A257
EMXA2160-75-10	◎	1	16	75	13	120	16	A272
EPSM4160-80-R1.0-PN	●	1	16	80	24	135	16	A239
ER5HS16-80-PN	●	1	16	80	48	135	16	A257
EHX16-EPP4160-10-TH	●	1	16	-	12.8	24	-	A399
EPPLS4160-10	●	1	16	-	24	180	15	A250
EPP4160-10-TH	●	1	16	-	32	110	16	A247
EPP4160-10	●	1	16	-	32	110	16	A249
EPSM4160-R1.0-PN	●	1	16	-	40	110	16	A236
CEPR6160-10-TH	●	1	16	-	40	110	16	A265
CEPR6160-10	●	1	16	-	40	110	16	A267
EAP4160-10-TH	◎	1	16	-	40	110	16	A269
EAP6160-10-TH	◎	1	16	-	40	110	16	A269
EPPL4160-10	●	1	16	-	65	135	16	A249
EPSSL4160-R1.0-PN	□	1	16	-	80	135	16	A237
EPSM4160-80-R1.5-PN	●	1.5	16	80	24	135	16	A239
EHX16-EPP4160-15-TH	●	1.5	16	-	12.8	24	-	A399
EPPLS4160-15	●	1.5	16	-	24	180	15	A250
EPP4160-15-TH	●	1.5	16	-	32	110	16	A247
EPP4160-15	●	1.5	16	-	32	110	16	A249
EPSM4160-R1.5-PN	●	1.5	16	-	40	110	16	A236
CEPR6160-15	●	1.5	16	-	40	110	16	A267
EAP4160-15-TH	◎	1.5	16	-	40	110	16	A269
EAP6160-15-TH	◎	1.5	16	-	40	110	16	A269
EPPL4160-15	●	1.5	16	-	65	135	16	A249
EPSSL4160-R1.5-PN	□	1.5	16	-	80	135	16	A237
EPSM4160-80-R2.0-PN	●	2	16	80	24	135	16	A239
EHX16-EPP4160-20-TH	●	2	16	-	12.8	24	-	A399
EPPLS4160-20	●	2	16	-	24	180	15	A250
EPP4160-20-TH	●	2	16	-	32	110	16	A247
EPP4160-20	●	2	16	-	32	110	16	A249
EPSM4160-R2.0-PN	●	2	16	-	40	110	16	A236
CEPR6160-20-TH	●	2	16	-	40	110	16	A265
CEPR6160-20	●	2	16	-	40	110	16	A267
EAP4160-20-TH	◎	2	16	-	40	110	16	A269
EPPL4160-20	●	2	16	-	65	135	16	A249
EPSSL4160-R2.0-PN	□	2	16	-	80	135	16	A237
CEPR6160-25	●	2.5	16	-	40	110	16	A267
EPSM4160-80-R3.0-PN	●	3	16	80	24	135	16	A239
ETMLN4160-80-30-TH	●	3	16	80	24	140	16	A226
ETMP4160-105-30-TH	●	3	16	105	24	160	20	A227
EPRPN3160-105-30	□	3	16	105	24	160	20	A429
ETMLN4160-120-30-TH	●	3	16	120	24	175	16	A226
ETMP4160-140-30-TH	●	3	16	140	24	200	20	A227
EPRPN3160-140-30	□	3	16	140	24	200	20	A429
EHX16-EPP4160-30-TH	●	3	16	-	12.8	24	-	A399
EHX16-ETM4160-30-TH	●	3	16	-	16	24	-	A398
EHX16H-ETM4160-30-TH	●	3	16	-	16	24	-	A398
EPP4160-30-TH	●	3	16	-	32	110	16	A247
EPP4160-30	●	3	16	-	32	110	16	A249
ETM4160-30-TH	●	3	16	-	32	140	16	A226
EPR3160-30	□	3	16	-	32	140	16	A429
EPSM4160-R3.0-PN	●	3	16	-	40	110	16	A236
EAP4160-30-TH	◎	3	16	-	40	110	16	A269
EPPL4160-30	●	3	16	-	65	135	16	A249
EPSSL4160-R3.0-PN	□	3	16	-	80	135	16	A237

商品コード Item Code	在庫 Stock	コーナ 半径 Corner radius	外径 Tool dia.	首下長 Under neck length	刃長 Flute length	全長 Overall length	シャンク径 Shank dia.	ページ Page
EPSM4170-85-R0.5-PN	□	0.5	17	85	25.5	145	20	A239
EPSM4170-R0.5-PN	□	0.5	17	-	42.5	120	20	A236
EPSM4170-85-R1.0-PN	□	1	17	85	25.5	145	20	A239
EPPLS4170-10	●	1	17	-	24	180	16	A250
EPSM4170-R1.0-PN	□	1	17	-	42.5	120	20	A236
EPSM4170-85-R1.5-PN	□	1.5	17	85	25.5	145	20	A239
EPPLS4170-15	●	1.5	17	-	24	180	16	A250
EPSM4170-R1.5-PN	□	1.5	17	-	42.5	120	20	A236
EPSM4170-85-R2.0-PN	□	2	17	85	25.5	145	20	A239
EPPLS4170-20	●	2	17	-	24	180	16	A250
EPSM4170-R2.0-PN	□	2	17	-	42.5	120	20	A236
EPSM4170-85-R3.0-PN	□	3	17	85	25.5	145	20	A239
EPSM4170-R3.0-PN	□	3	17	-	42.5	120	20	A236
EPSM4180-90-R0.5-PN	□	0.5	18	90	27	145	20	A239
EPSM4180-R0.5-PN	□	0.5	18	-	45	120	20	A236
EPSM4180-90-R1.0-PN	□	1	18	90	27	145	20	A239
EPSM4180-R1.0-PN	□	1	18	-	45	120	20	A236
EPSM4180-90-R1.5-PN	□	1.5	18	90	27	145	20	A239
EPSM4180-R1.5-PN	□	1.5	18	-	45	120	20	A236
EPSM4180-90-R2.0-PN	□	2	18	90	27	145	20	A239
EPSM4180-R2.0-PN	□	2	18	-	45	120	20	A236
EPSM4180-90-R3.0-PN	□	3	18	90	27	145	20	A239
EPSM4180-R3.0-PN	□	3	18	-	45	120	20	A236
EPSM4190-95-R0.5-PN	□	0.5	19	95	28.5	155	20	A239
EPSM4190-R0.5-PN	□	0.5	19	-	47.5	125	20	A236
EPSM4190-95-R1.0-PN	□	1	19	95	28.5	155	20	A239
EPSM4190-R1.0-PN	□	1	19	-	47.5	125	20	A236
EPSM4190-95-R1.5-PN	□	1.5	19	95	28.5	155	20	A239
EPSM4190-R1.5-PN	□	1.5	19	-	47.5	125	20	A236
EPSM4190-95-R2.0-PN	□	2	19	95	28.5	155	20	A239
EPSM4190-R2.0-PN	□	2	19	-	47.5	125	20	A236
EPSM4190-95-R3.0-PN	□	3	19	95	28.5	155	20	A239
EPSM4190-R3.0-PN	□	3	19	-	47.5	125	20	A236
EPSM4200-100-R0.5-PN	●	0.5	20	100	30	155	20	A239
EPSM4200-R0.5-PN	●	0.5	20	-	50	125	20	A236
EPSSL4200-R0.5-PN	□	0.5	20	-	100	155	20	A237
ER5HS20-PN	●	1	20	70	60	125	20	A257
EPSM4200-100-R1.0-PN	●	1	20	100	30	155	20	A239
ER5HS20-100-PN	●	1	20	100	60	155	20	A257
EHX20-EPP4200-10-TH	●	1	20	-	16	30	-	A399
EPP4200-10-TH	●	1	20	-	38	125	20	A247
EPP4200-10	●	1	20	-	38	125	20	A249
CEPR6200-10-TH	●	1	20	-	45	125	20	A265
CEPR6200-10	●	1	20	-	45	125	20	A267
EAP4200-10-TH	◎	1	20	-	45	125	20	A269
EAP6200-10-TH	◎	1	20	-	45	125	20	A269
EPSM4200-R1.0-PN	●	1	20	-	50	125	20	A236
EPPL4200-10	●	1	20	-	75	155	20	A249
EPSSL4200-R1.0-PN	□	1	20	-	100	155	20	A237
EPSM4200-100-R1.5-PN	●	1.5	20	100	30	155	20	A239
EHX20-EPP4200-15-TH	●	1.5	20	-	16	30	-	A399
EPP4200-15-TH	●	1.5	20	-	38	125	20	A247
EPP4200-15	●	1.5	20	-	38	125	20	A249
CEPR6200-15	●	1.5	20	-	45	125	20	A267
EAP4200-15-TH	◎	1.5	20	-	45	125	20	A269
EAP6200-15-TH	◎	1.5	20	-	45	125	20	A269
EPSM4200-R1.5-PN	●	1.5	20	-	50	125	20	A236
EPPL4200-15	●	1.5	20	-	75	155	20	A249
EPSSL4200-R1.5-PN	□	1.5	20	-	100	155	20	A237
EPSM4200-100-R2.0-PN	●	2	20	100	30	155	20	A239
EHX20-EPP4200-20-TH	●	2	20	-	16	30	-	A399
EPP4200-20-TH	●	2	20	-	38	125	20	A247
EPP4200-20	●	2	20	-	38	125	20	A249
CEPR6200-20-TH	●	2	20	-	45	125	20	A265
CEPR6200-20	●	2	20	-	45	125	20	A267
EAP4200-20-TH	◎	2	20	-	45	125	20	A269
EPSM4200-R2.0-PN	●	2	20	-	50	125	20	A236
EPPL4200-20	●	2	20	-	75	155	20	A249
EPSSL4200-R2.0-PN	□	2	20	-	100	155	20	A237

商品コード Item Code	在庫 Stock	コーナ 半径 Corner radius	外径 Tool dia.	首下長 Under neck length	刃長 Flute length	全長 Overall length	シャンク径 Shank dia.	ページ Page
CEPR6200-25	●	2.5	20	-	45	125	20	A267
EMXA2200-80-30	◎	3	20	80	16	125	20	A272
EPSM4200-100-R3.0-PN	●	3	20	100	30	155	20	A239
EHX20-EPP4200-30-TH	●	3	20	-	16	30	-	A399
EHX20-ETM4200-30-TH	●	3	20	-	20	30	-	A398
EHX20H-ETM4200-30-TH	●	3	20	-	20	30	-	A398
EPP4200-30-TH	●	3	20	-	38	125	20	A247
EPP4200-30	●	3	20	-	38	125	20	A249
ETM4200-30-TH	●	3	20	-	40	150	20	A226
EPR3200-30	□	3	20	-	40	150	20	A429
CEPR6200-30-TH	●	3	20	-	45	125	20	A265
CEPR6200-30	●	3	20	-	45	125	20	A267
EAP4200-30-TH	◎	3	20	-	45	125	20	A269
EPSM4200-R3.0-PN	●	3	20	-	50	125	20	A236
EPPL4200-30	●	3	20	-	75	1		

Quick dimension reference table by mill diameter

外径別寸法早見表

超硬エンドミル・スクエア

φ0.03 ~ φ1.2 Carbide End Mills -Square

単位 unit : mm

商品コード Item Code	在庫 Stock	外径 Tool dia.	首下長 Under neck length	刃長 Flute length	全長 Overall length	シャンク径 Shank dia.	ページ Page
EMM20003	●	0.03	—	0.045	40	4	A384
EMM20003-TH	●	0.03	—	0.045	40	4	A384
EMM20004	●	0.04	—	0.06	40	4	A384
EMM20004-TH	●	0.04	—	0.06	40	4	A384
EMM20005	●	0.05	—	0.075	40	4	A384
EMM20005-TH	●	0.05	—	0.075	40	4	A384
EMM20006	●	0.06	—	0.09	40	4	A384
EMM20006-TH	●	0.06	—	0.09	40	4	A384
EMM20007	●	0.07	—	0.105	40	4	A384
EMM20007-TH	●	0.07	—	0.105	40	4	A384
EMM20008	●	0.08	—	0.12	40	4	A384
EMM20008-TH	●	0.08	—	0.12	40	4	A384
EMM20009	●	0.09	—	0.135	40	4	A384
EMM20009-TH	●	0.09	—	0.135	40	4	A384
EPDSE2001-0.3-ATH	●	0.1	0.3	0.15	45	4	A292
EPDSE2001-0.3-PN	●	0.1	0.3	0.15	45	4	A295
EPDS2001-0.3	□	0.1	0.3	0.15	45	4	A430
EPDS2001-0.3-TH	□	0.1	0.3	0.15	45	4	A430
EPDSE2001-0.5-ATH	●	0.1	0.5	0.15	45	4	A292
EPDSE2001-0.5-PN	●	0.1	0.5	0.15	45	4	A295
EPDS2001-0.5	□	0.1	0.5	0.15	45	4	A430
EPDS2001-0.5-TH	□	0.1	0.5	0.15	45	4	A430
EPDSE2001-1-ATH	●	0.1	1	0.15	45	4	A292
EPDSE2001-1-PN	●	0.1	1	0.15	45	4	A295
EPDS2001-1	□	0.1	1	0.15	45	4	A430
EPDS2001-1-TH	□	0.1	1	0.15	45	4	A430
EPCDS4001	●	0.1	3	0.01	40	4	A383
EMM20010	●	0.1	—	0.15	40	4	A384
EMM20010-TH	●	0.1	—	0.15	40	4	A384
HES2001-C	□	0.1	—	0.2	38	3	A387
HES2001	●	0.1	—	0.2	38	3	A390
EPDSE2002-0.5-ATH	●	0.2	0.5	0.3	50	4	A292
EPDSE2002-0.5-PN	●	0.2	0.5	0.3	50	4	A295
EPDS2002-0.5	□	0.2	0.5	0.3	50	4	A430
EPDS2002-0.5-TH	□	0.2	0.5	0.3	50	4	A430
HGOS2002-PN	●	0.2	0.6	0.4	40	4	A304
EPDSE2002-1-ATH	●	0.2	1	0.3	50	4	A292
EPDSE2002-1-PN	●	0.2	1	0.3	50	4	A295
EPDS2002-1	□	0.2	1	0.3	50	4	A430
EPDS2002-1-TH	□	0.2	1	0.3	50	4	A430
EPDSE2002-1.5-ATH	●	0.2	1.5	0.3	50	4	A292
EPDSE2002-1.5-PN	●	0.2	1.5	0.3	50	4	A295
EPDS2002-1.5	□	0.2	1.5	0.3	50	4	A430
EPDS2002-1.5-TH	□	0.2	1.5	0.3	50	4	A430
EPDSE2002-2-ATH	●	0.2	2	0.3	50	4	A292
EPDSE2002-2-PN	●	0.2	2	0.3	50	4	A295
EPCDS4002	●	0.2	3	0.02	40	4	A383
EPDSE2002-3-ATH	●	0.2	3	0.3	50	4	A292
EPDSE2002-3-PN	●	0.2	3	0.3	50	4	A295
EMM20020	●	0.2	—	0.3	40	4	A384
EMM20020-TH	●	0.2	—	0.3	40	4	A384
HYP2002-C	●	0.2	—	0.3	50	6	A385
HES2002-C	□	0.2	—	0.4	38	3	A387
HES2002	●	0.2	—	0.4	38	3	A390
YS2002-CS	□	0.2	—	0.4	40	4	A437
HGOS2003-PN	●	0.3	0.9	0.6	40	4	A304
EPDSE2003-1-ATH	●	0.3	1	0.45	50	4	A292
EPDSE2003-1-PN	●	0.3	1	0.45	50	4	A295
EPDS2003-1	□	0.3	1	0.45	50	4	A430
EPDS2003-1-TH	□	0.3	1	0.45	50	4	A430
EPDSE2003-1.5-ATH	●	0.3	1.5	0.45	50	4	A292
EPDSE2003-1.5-PN	●	0.3	1.5	0.45	50	4	A295
EPDS2003-1.5	□	0.3	1.5	0.45	50	4	A430
EPDS2003-1.5-TH	□	0.3	1.5	0.45	50	4	A430
EPDSE2003-2-ATH	●	0.3	2	0.45	50	4	A292
EPDSE2003-2-PN	●	0.3	2	0.45	50	4	A295
EPDS2003-2	□	0.3	2	0.45	50	4	A430
EPDS2003-2-TH	□	0.3	2	0.45	50	4	A430
EPDSE2003-2.5-ATH	●	0.3	2.5	0.45	50	4	A292

商品コード Item Code	在庫 Stock	外径 Tool dia.	首下長 Under neck length	刃長 Flute length	全長 Overall length	シャンク径 Shank dia.	ページ Page
EPDSE2003-2.5-PN	●	0.3	2.5	0.45	50	4	A295
EPDS2003-2.5	□	0.3	2.5	0.45	50	4	A430
EPDS2003-2.5-TH	□	0.3	2.5	0.45	50	4	A430
EPCDS4003	●	0.3	3	0.04	40	4	A383
EPDSE2003-3-ATH	●	0.3	3	0.45	50	4	A292
EPDSE2003-3-PN	●	0.3	3	0.45	50	4	A295
EPDS2003-3	□	0.3	3	0.45	50	4	A430
EPDS2003-3-TH	□	0.3	3	0.45	50	4	A430
HYP2003-C	●	0.3	—	0.4	50	6	A385
EMM20030	●	0.3	—	0.45	40	4	A384
EMM20030-TH	●	0.3	—	0.45	40	4	A384
YS2003-CS	□	0.3	—	0.6	40	4	A437
HES2003-C	□	0.3	—	1	38	3	A387
HES2003	●	0.3	—	1	38	3	A390
EPDSE2004-1-ATH	●	0.4	1	0.6	50	4	A292
EPDSE2004-1-PN	●	0.4	1	0.6	50	4	A295
EPDS2004-1	□	0.4	1	0.6	50	4	A430
EPDS2004-1-TH	□	0.4	1	0.6	50	4	A430
HGOS2004-PN	●	0.4	1.1	0.8	40	4	A304
EPDSE2004-1.5-ATH	●	0.4	1.5	0.6	50	4	A292
EPDSE2004-1.5-PN	●	0.4	1.5	0.6	50	4	A295
EPDS2004-1.5	□	0.4	1.5	0.6	50	4	A430
EPDS2004-1.5-TH	□	0.4	1.5	0.6	50	4	A430
EPDSE2004-2-ATH	●	0.4	2	0.6	50	4	A292
EPDSE2004-2-PN	●	0.4	2	0.6	50	4	A295
EPDS2004-2	□	0.4	2	0.6	50	4	A430
EPDS2004-2-TH	□	0.4	2	0.6	50	4	A430
EPDSE2004-2.5-ATH	●	0.4	2.5	0.6	50	4	A292
EPDSE2004-2.5-PN	●	0.4	2.5	0.6	50	4	A295
EPDS2004-2.5	□	0.4	2.5	0.6	50	4	A430
EPDS2004-2.5-TH	□	0.4	2.5	0.6	50	4	A430
EPCDS6004	●	0.4	3	0.04	40	6	A383
EPDSE2004-3-ATH	●	0.4	3	0.6	50	4	A292
EPDSE2004-3-PN	●	0.4	3	0.6	50	4	A295
EPDS2004-3	□	0.4	3	0.6	50	4	A430
EPDS2004-3-TH	□	0.4	3	0.6	50	4	A430
EPDSE2004-3.5-ATH	●	0.4	3.5	0.6	50	4	A292
EPDSE2004-3.5-PN	●	0.4	3.5	0.6	50	4	A295
EPDS2004-3.5	□	0.4	3.5	0.6	50	4	A430
EPDS2004-3.5-TH	□	0.4	3.5	0.6	50	4	A430
EPDSE2004-4-ATH	●	0.4	4	0.6	50	4	A292
EPDSE2004-4-PN	●	0.4	4	0.6	50	4	A295
EPDS2004-4	□	0.4	4	0.6	50	4	A430
EPDS2004-4-TH	□	0.4	4	0.6	50	4	A430
EPDSE2004-5-ATH	●	0.4	5	0.6	50	4	A292
EPDSE2004-5-PN	●	0.4	5	0.6	50	4	A295
EPDS2004-5	□	0.4	5	0.6	50	4	A430
EPDS2004-5-TH	□	0.4	5	0.6	50	4	A430
EPDSE2004-6-ATH	●	0.4	6	0.6	50	4	A292
EPDSE2004-6-PN	●	0.4	6	0.6	50	4	A295
EPDS2004-6	□	0.4	6	0.6	50	4	A430
EPDS2004-6-TH	□	0.4	6	0.6	50	4	A430
EPDSE2004-8-ATH	●	0.4	8	0.6	50	4	A292
EPDSE2004-8-PN	●	0.4	8	0.6	50	4	A295
EPDS2004-8	□	0.4	8	0.6	50	4	A430
EPDSE2004-10-ATH	●	0.4	10	0.6	50	4	A292
EPDSE2004-10-PN	●	0.4	10	0.6	50	4	A295
HYP2004-C	●	0.4	—	0.5	50	6	A385
EMM20040	●	0.4	—	0.6	40	4	A384
EMM20040-TH	●	0.4	—	0.6	40	4	A384
YS2004-CS	□	0.4	—	0.8	40	4	A437
HES2004-C	□	0.4	—	1	38	3	A387
HES2004	●	0.4	—	1	38	3	A390
EPDSE2005-1-ATH	●	0.5	1	0.75	50	4	A292
EPDSE2005-1-PN	●	0.5	1	0.75	50	4	A295
EPDS2005-1	□	0.5	1	0.75	50	4	A430
EPDS2005-1-TH	□	0.5	1	0.75	50	4	A430
HGOS2005-PN	●	0.5	1.3	1	40	4	A304
EPDSE2005-1.5-ATH	●	0.5	1.5	0.75	50	4	A292
EPDSE2005-1.5-PN	●	0.5	1.5	0.75	50	4	A295

商品コード Item Code	在庫 Stock	外径 Tool dia.	首下長 Under neck length	刃長 Flute length	全長 Overall length	シャンク径 Shank dia.	ページ Page
EPDSE2005-1.5	□	0.5	1.5	0.75	50	4	A430
EPDS2005-1.5-TH	□	0.5	1.5	0.75	50	4	A430
HYP2005-C	●	0.5	1.6	0.6	50	6	A385
EPDSE2005-2-ATH	●	0.5	2	0.75	50	4	A292
EPDSE2005-2-PN	●	0.5	2	0.75	50	4	A295
EPDS2005-2-SD	●	0.5	2	0.75	50	4	A378
EPDS2005-2	□	0.5	2	0.75	50	4	A430
EPDS2005-2-TH	□	0.5	2	0.75	50	4	A430
DES2005-4-C	□	0.5	2	0.8	55	4	A452
HPSLN2005-C	●	0.5	2.5	0.6	60	6	A385
EPDSE2005-2.5-ATH	●	0.5	2.5	0.75	50	4	A292
EPDSE2005-2.5-PN	●	0.5	2.5	0.75	50	4	A295
EPDS2005-2.5	□	0.5	2.5	0.75	50	4	A430
EPDS2005-2.5-TH	□	0.5	2.5	0.75	50	4	A430
EPCDS6005	●	0.5	3	0.05	40	6	A383
EPDSE2005-3-ATH	●	0.5	3	0.75	50	4	A292
EPDSE2005-3-PN	●	0.5	3	0.75	50	4	A295
EPDS2005-3	□	0.5	3	0.75	50	4	A430
EPDS2005-3-TH	□	0.5	3	0.75	50	4	A430
DES2005-7-C	□	0.5	3.5	0.8	55	4	A452
EPDSE2005-4-ATH	●	0.5	4	0.75	50	4	A292
EPDSE2005-4-PN	●	0.5	4	0.75	50	4	A295
EPDS2005-4-SD	●	0.5	4	0.75	50	4	A378
EPDS2005-4	□	0.5	4	0.75	50	4	A430
EPDS2005-4-TH	□	0.5	4	0.75	50	4	A430
EPDSE2005-5-ATH	●	0.5	5	0.75	50	4	A292
EPDSE2005-5-PN	●	0.5	5	0.75	50	4	A295
EPDS2005-5	□	0.5	5	0.75	50	4	A430
EPDS2005-5-TH							

単位 unit : mm

商品コード Item Code	在庫 Stock	外径 Tool dia.	首下長 Under neck length	刃長 Flute length	全長 Overall length	シャンク径 Shank dia.	ページ Page
EPDS2006-6	□	0.6	6	0.9	50	4	A430
EPDS2006-6-TH	□	0.6	6	0.9	50	4	A430
DES2006-10-C	□	0.6	6	1	55	4	A452
EPDSE2006-7-ATH	●	0.6	7	0.9	50	4	A292
EPDSE2006-7-PN	●	0.6	7	0.9	50	4	A295
EPDSE2006-8-ATH	●	0.6	8	0.9	50	4	A292
EPDSE2006-8-PN	●	0.6	8	0.9	50	4	A295
EPDS2006-8	□	0.6	8	0.9	50	4	A430
EPDS2006-8-TH	□	0.6	8	0.9	50	4	A430
EPDSE2006-9-ATH	●	0.6	9	0.9	50	4	A292
EPDSE2006-9-PN	●	0.6	9	0.9	50	4	A295
EPDSE2006-10-ATH	●	0.6	10	0.9	50	4	A292
EPDSE2006-10-PN	●	0.6	10	0.9	50	4	A295
EPDS2006-10	□	0.6	10	0.9	50	4	A430
EPDS2006-10-TH	□	0.6	10	0.9	50	4	A430
YS2006-CS	□	0.6	-	1.2	40	4	A437
HES2006-C	□	0.6	-	1.5	38	3	A387
HES2006	●	0.6	-	1.5	38	3	A390
HGOS2007-PN	●	0.7	1.7	1.4	40	4	A304
EPDSE2007-2-ATH	●	0.7	2	1.05	50	4	A292
EPDSE2007-2-PN	●	0.7	2	1.05	50	4	A295
EPDS2007-2	□	0.7	2	1.05	50	4	A430
EPDS2007-2-TH	□	0.7	2	1.05	50	4	A430
DES2007-4-C	□	0.7	2.8	1.1	55	4	A452
EPDSE2007-4-ATH	●	0.7	4	1.05	50	4	A292
EPDSE2007-4-PN	●	0.7	4	1.05	50	4	A295
EPDS2007-4	□	0.7	4	1.05	50	4	A430
EPDS2007-4-TH	□	0.7	4	1.05	50	4	A430
DES2007-7-C	□	0.7	4.9	1.1	55	4	A452
EPDSE2007-6-ATH	●	0.7	6	1.05	50	4	A292
EPDSE2007-6-PN	●	0.7	6	1.05	50	4	A295
EPDS2007-6	□	0.7	6	1.05	50	4	A430
EPDS2007-6-TH	□	0.7	6	1.05	50	4	A430
DES2007-10-C	□	0.7	7	1.1	55	4	A452
EPDSE2007-8-ATH	●	0.7	8	1.05	50	4	A292
EPDSE2007-8-PN	●	0.7	8	1.05	50	4	A295
EPDS2007-8	□	0.7	8	1.05	50	4	A430
EPDS2007-8-TH	□	0.7	8	1.05	50	4	A430
EPDSE2007-10-ATH	●	0.7	10	1.05	50	4	A292
EPDSE2007-10-PN	●	0.7	10	1.05	50	4	A295
EPDS2007-10	□	0.7	10	1.05	50	4	A430
EPDS2007-10-TH	□	0.7	10	1.05	50	4	A430
YS2007-CS	□	0.7	-	1.4	40	4	A437
HES2007-C	□	0.7	-	1.5	38	3	A387
HES2007	●	0.7	-	1.5	38	3	A390
HGOS2008-PN	●	0.8	1.9	1.6	40	4	A304
EPDSE2008-2-ATH	●	0.8	2	1.2	50	4	A293
EPDSE2008-2-PN	●	0.8	2	1.2	50	4	A296
HYPS2008-C	●	0.8	2.5	1	50	6	A385
EPCDS6008	●	0.8	3	0.1	40	6	A383
HPSLN2008-C	●	0.8	4	1	60	6	A385
EPDSE2008-4-ATH	●	0.8	4	1.2	50	4	A293
EPDSE2008-4-PN	●	0.8	4	1.2	50	4	A296
EPDS2008-4-SD	●	0.8	4	1.2	50	4	A378
EPDS2008-4	□	0.8	4	1.2	50	4	A430
EPDS2008-4-TH	□	0.8	4	1.2	50	4	A430
DES2008-5-C	□	0.8	4	1.3	55	4	A452
DES2008-6-C	□	0.8	4.8	1.3	55	4	A452
DES2008-7-C	□	0.8	5.6	1.3	55	4	A452
EPDSE2008-6-ATH	●	0.8	6	1.2	50	4	A293
EPDSE2008-6-PN	●	0.8	6	1.2	50	4	A296
EPDS2008-6-SD	●	0.8	6	1.2	50	4	A378
EPDS2008-6	□	0.8	6	1.2	50	4	A430
EPDS2008-6-TH	□	0.8	6	1.2	50	4	A430
DES2008-8.5-C	□	0.8	6.8	1.3	65	4	A452
EPDSE2008-8-ATH	●	0.8	8	1.2	50	4	A293
EPDSE2008-8-PN	●	0.8	8	1.2	50	4	A296
EPDS2008-8-SD	●	0.8	8	1.2	50	4	A378
EPDS2008-8	□	0.8	8	1.2	50	4	A430

商品コード Item Code	在庫 Stock	外径 Tool dia.	首下長 Under neck length	刃長 Flute length	全長 Overall length	シャンク径 Shank dia.	ページ Page
EPDS2008-8-TH	□	0.8	8	1.2	50	4	A430
DES2008-10-C	□	0.8	8	1.3	65	4	A452
EPDSE2008-10-ATH	●	0.8	10	1.2	50	4	A293
EPDSE2008-10-PN	●	0.8	10	1.2	50	4	A296
EPDS2008-10	□	0.8	10	1.2	50	4	A430
EPDS2008-10-TH	□	0.8	10	1.2	50	4	A430
EPDSE2008-12-ATH	●	0.8	12	1.2	55	4	A293
EPDSE2008-12-PN	●	0.8	12	1.2	55	4	A296
EPDS2008-12	□	0.8	12	1.2	55	4	A430
EPDS2008-12-TH	□	0.8	12	1.2	55	4	A430
YS2008-CS	□	0.8	-	1.6	40	4	A437
HES2008-C	□	0.8	-	2	38	3	A387
HES2008	●	0.8	-	2	38	3	A390
EPDSE2009-2-ATH	●	0.9	2	1.35	50	4	A293
EPDSE2009-2-PN	●	0.9	2	1.35	50	4	A296
HGOS2009-PN	●	0.9	2.1	1.8	40	4	A304
EPDSE2009-4-ATH	●	0.9	4	1.35	50	4	A293
EPDSE2009-4-PN	●	0.9	4	1.35	50	4	A296
EPDSE2009-6-ATH	●	0.9	6	1.35	50	4	A293
EPDSE2009-6-PN	●	0.9	6	1.35	50	4	A296
EPDS2009-6	□	0.9	6	1.35	50	4	A430
EPDS2009-6-TH	□	0.9	6	1.35	50	4	A430
DES2009-7-C	□	0.9	6.3	1.4	55	4	A452
DES2009-8.5-C	□	0.9	7.7	1.4	55	4	A452
EPDSE2009-8-ATH	●	0.9	8	1.35	50	4	A293
EPDSE2009-8-PN	●	0.9	8	1.35	50	4	A296
EPDS2009-8	□	0.9	8	1.35	50	4	A430
EPDS2009-8-TH	□	0.9	8	1.35	50	4	A430
DES2009-10-C	□	0.9	9	1.4	55	4	A452
EPDSE2009-10-ATH	●	0.9	10	1.35	50	4	A293
EPDSE2009-10-PN	●	0.9	10	1.35	50	4	A296
EPDS2009-10	□	0.9	10	1.35	50	4	A430
EPDS2009-10-TH	□	0.9	10	1.35	50	4	A430
EPDSE2009-12-ATH	●	0.9	12	1.35	55	4	A293
EPDSE2009-12-PN	●	0.9	12	1.35	55	4	A296
EPDS2009-12	□	0.9	12	1.35	55	4	A430
EPDS2009-12-TH	□	0.9	12	1.35	55	4	A430
YS2009-CS	□	0.9	-	1.8	40	4	A437
HES2009-C	□	0.9	-	2	38	3	A387
HES2009	●	0.9	-	2	38	3	A390
EPDSE2010-2-ATH	●	1	2	1.5	50	4	A293
EPDSE2010-2-PN	●	1	2	1.5	50	4	A296
EPDS2010-2	□	1	2	1.5	50	4	A430
EPDS2010-2-TH	□	1	2	1.5	50	4	A430
BHS2010	□	1	2.5	0.5	60	6	A456
HGOS2010-PN	●	1	2.5	2	40	4	A304
EPCDS6010	●	1	3	0.1	40	6	A383
EPDSE2010-3-ATH	●	1	3	1.5	50	4	A293
EPDSE2010-3-PN	●	1	3	1.5	50	4	A296
EPSM4010-3-PN	●	1	3	1.5	56	6	A317
HGOS4010-PN	●	1	3	2.5	40	4	A305
HYPS2010-C	●	1	3.3	1.3	50	6	A385
EPDSE2010-4-ATH	●	1	4	1.5	50	4	A293
EPDSE2010-4-PN	●	1	4	1.5	50	4	A296
EPDS2010-4-SD	●	1	4	1.5	50	4	A378
EPDS2010-4	□	1	4	1.5	50	4	A430
EPDS2010-4-TH	□	1	4	1.5	50	4	A430
HPSLN2010-C	●	1	5	1.3	60	6	A385
EPDSE2010-5-ATH	●	1	5	1.5	50	4	A293
EPDSE2010-5-PN	●	1	5	1.5	50	4	A296
EPSM4010-5-PN	●	1	5	1.5	68	6	A318
DES2010-5-C	□	1	5	1.6	55	4	A452
EPDSE2010-6-ATH	●	1	6	1.5	50	4	A293
EPDSE2010-6-PN	●	1	6	1.5	50	4	A296
EPDS2010-6	□	1	6	1.5	50	4	A430
EPDS2010-6-TH	□	1	6	1.5	50	4	A430
DES2010-6-C	□	1	6	1.6	55	4	A452
EPDSE2010-7-ATH	●	1	7	1.5	50	4	A293
EPDSE2010-7-PN	●	1	7	1.5	50	4	A296

商品コード Item Code	在庫 Stock	外径 Tool dia.	首下長 Under neck length	刃長 Flute length	全長 Overall length	シャンク径 Shank dia.	ページ Page
DES2010-7-C	□	1	7	1.6	55	4	A452
EPDSE2010-8-ATH	●	1	8	1.5	50	4	A293
EPDSE2010-8-PN	●	1	8	1.5	50	4	A296
EPDS2010-8-SD	●	1	8	1.5	50	4	A378
EPDS2010-8	□	1	8	1.5	50	4	A430
EPDS2010-8-TH	□	1	8	1.5	50	4	A430
DES2010-8.5-C	□	1	8.5	1.6	65	4	A452
EPDSE2010-9-ATH	●	1	9	1.5	50	4	A293
EPDSE2010-9-PN	●	1	9	1.5	50	4	A296
EPDSE2010-10-ATH	●	1	10	1.5	50	4	A293
EPDSE2010-10-PN	●	1	10	1.5	50	4	A296
EPDS2010-10	□	1	10	1.5	50	4	A430
EPDS2010-10-TH	□	1	10	1.5	50	4	A430
DES2010-10-C	□	1	10	1.6	65	4	A452
EPDSE2010-12-ATH	●	1	12	1.5	55	4	A293
EPDSE2010-12-PN	●	1	12	1.5	55	4	A296
EPDS2010-12-SD	●	1	12	1.5	55	4	A378
EPDS2010-12	□	1	12	1.5	55	4	A430
EPDS2010-12-TH	□	1	12	1.5	55	4	A430
EPDSE2010-14-ATH	●	1	14	1.5	55	4	A293
EPDSE2010-14-PN	●	1	14	1.5	55	4	A296
EPDS2010-14	□	1	14	1.5	55	4	A430
EPDS2010-14-TH	□	1	14	1.5	55	4	A430
EPDSE2010-16-ATH	●	1	16	1.5	55	4	A293
EPDSE2010-16-PN	●	1	16	1.5	55	4	A296
EPDS2010-16	□	1	16	1.5	60	4	A430
EPDS2010-16-TH	□	1	16	1.5	60	4	A430
EPDSE2010-20-ATH	●	1	20	1.5	60	4	A293
EPDSE2010-20-PN	●	1	20	1.5	60	4	A296
EPDSE2010-25-ATH	●	1	25	1.5	65	4	A293
EPDSE2010-25-PN	●	1	25	1.5	65	4	A296
EPPS4010-P-CS	●	1	-	1.5	50	6	A332
EPSMS4010-PN	□	1	-	1.5	56	6	A311
EPPS4010	□	1	-	1.5	60	6	A336
PESS2010-C	□	1	-	2	40	4	A434
PESS2010	□	1	-	2	40</		

外径別寸法早見表

超硬エンドミル・スクエア

φ1.2 ~ φ2.8 Carbide End Mills - Square

単位 unit : mm

商品コード Item Code	在庫 Stock	外径 Tool dia.	首下長 Under neck length	刃長 Flute length	全長 Overall length	シャンク径 Shank dia.	ページ Page
EPDS2012-8	□	1.2	8	1.8	50	4	A430
EPDS2012-8-TH	□	1.2	8	1.8	50	4	A430
DES2012-7-C	□	1.2	8.4	1.9	55	4	A452
EPDSE2012-10-ATH	●	1.2	10	1.8	50	4	A293
EPDSE2012-10-PN	●	1.2	10	1.8	50	4	A296
EPDS2012-10	□	1.2	10	1.8	50	4	A430
EPDS2012-10-TH	□	1.2	10	1.8	50	4	A430
DES2012-8.5-C	□	1.2	10.2	1.9	65	4	A452
EPDSE2012-12-ATH	●	1.2	12	1.8	55	4	A293
EPDSE2012-12-PN	●	1.2	12	1.8	55	4	A296
EPDS2012-12	□	1.2	12	1.8	55	4	A430
EPDS2012-12-TH	□	1.2	12	1.8	55	4	A430
DES2012-10-C	□	1.2	12	1.9	65	4	A452
EPDSE2012-16-ATH	●	1.2	16	1.8	55	4	A293
EPDSE2012-16-PN	●	1.2	16	1.8	55	4	A296
EPDS2012-16	□	1.2	16	1.8	55	4	A430
EPDS2012-16-TH	□	1.2	16	1.8	55	4	A430
EPSMS4012-PN	□	1.2	-	1.8	56	6	A311
EPPS4012	□	1.2	-	1.8	60	6	A336
HES2012-C	□	1.2	-	3	40	4	A387
HES2012	●	1.2	-	3	40	4	A390
EPSM4012-PN	□	1.2	-	3	56	6	A313
EPSM40125-PN	□	1.25	-	3.3	56	6	A313
EPSMS4013-PN	□	1.3	-	2	56	6	A311
EPPS4013	□	1.3	-	2	60	6	A336
EPMS4013-PN	□	1.3	-	3.3	56	6	A313
HES2013-C	□	1.3	-	4	40	4	A387
HES2013	●	1.3	-	4	40	4	A390
EPSM40135-PN	□	1.35	-	3.5	56	6	A313
HYPS2014-C	●	1.4	3.8	1.8	50	6	A385
EPDSE2014-6-ATH	●	1.4	6	2.1	50	4	A293
EPDSE2014-6-PN	●	1.4	6	2.1	50	4	A296
EPDS2014-6	□	1.4	6	2.1	50	4	A431
EPDS2014-6-TH	□	1.4	6	2.1	50	4	A431
HPSLN2014-C	●	1.4	7	1.8	60	6	A385
DES2014-5-C	□	1.4	7	2.2	55	4	A452
EPDS2014-8	□	1.4	8	2.1	50	4	A431
EPDS2014-8-TH	□	1.4	8	2.1	50	4	A431
DES2014-6-C	□	1.4	8.4	2.2	55	4	A452
DES2014-7-C	□	1.4	9.8	2.2	55	4	A452
EPDS2014-10	□	1.4	10	2.1	50	4	A431
EPDS2014-10-TH	□	1.4	10	2.1	50	4	A431
DES2014-8.5-C	□	1.4	11.9	2.2	65	4	A452
EPDSE2014-12-ATH	●	1.4	12	2.1	55	4	A293
EPDSE2014-12-PN	●	1.4	12	2.1	55	4	A296
EPDS2014-12	□	1.4	12	2.1	55	4	A431
EPDS2014-12-TH	□	1.4	12	2.1	55	4	A431
EPDS2014-14	□	1.4	14	2.1	55	4	A431
EPDS2014-14-TH	□	1.4	14	2.1	55	4	A431
DES2014-10-C	□	1.4	14	2.2	65	4	A452
EPDS2014-16	□	1.4	16	2.1	55	4	A431
EPDS2014-16-TH	□	1.4	16	2.1	55	4	A431
EPSMS4014-PN	□	1.4	-	2.1	56	6	A311
EPPS4014	□	1.4	-	2.1	60	6	A336
EPSM4014-PN	□	1.4	-	3.5	56	6	A313
HES2014-C	□	1.4	-	4	40	4	A387
HES2014	●	1.4	-	4	40	4	A390
EPSM40145-PN	□	1.45	-	3.8	56	6	A313
BHS2015	□	1.5	2.5	0.75	60	6	A456
HGOS2015-PN	●	1.5	3.5	3	40	4	A304
EPDSE2015-4-ATH	●	1.5	4	2.25	50	4	A293
EPDSE2015-4-PN	●	1.5	4	2.25	50	4	A296
EPDS2015-4	□	1.5	4	2.25	50	4	A431
EPDS2015-4-TH	□	1.5	4	2.25	50	4	A431
EPSM4015-4.5-PN	□	1.5	4.5	2.3	56	6	A317
HGOS4015-PN	●	1.5	4.5	4	40	4	A305
HYPS2015-C	●	1.5	4.9	1.9	50	6	A385
EPDSE2015-6-ATH	●	1.5	6	2.25	50	4	A293
EPDSE2015-6-PN	●	1.5	6	2.25	50	4	A296

商品コード Item Code	在庫 Stock	外径 Tool dia.	首下長 Under neck length	刃長 Flute length	全長 Overall length	シャンク径 Shank dia.	ページ Page
EPDS2015-6-SD	●	1.5	6	2.25	50	4	A378
EPDS2015-6	□	1.5	6	2.25	50	4	A431
EPDS2015-6-TH	□	1.5	6	2.25	50	4	A431
HPSLN2015-C	●	1.5	7.5	1.9	60	6	A385
EPSM4015-7.5-PN	□	1.5	7.5	2.3	68	6	A318
DES2015-5-C	□	1.5	7.5	2.4	55	4	A452
EPDSE2015-8-ATH	●	1.5	8	2.25	50	4	A293
EPDSE2015-8-PN	●	1.5	8	2.25	50	4	A296
EPDS2015-8	□	1.5	8	2.25	50	4	A431
EPDS2015-8-TH	□	1.5	8	2.25	50	4	A431
DES2015-6-C	□	1.5	9	2.4	55	4	A452
EPDSE2015-10-ATH	●	1.5	10	2.25	50	4	A293
EPDSE2015-10-PN	●	1.5	10	2.25	50	4	A296
EPDS2015-10	□	1.5	10	2.25	50	4	A431
EPDS2015-10-TH	□	1.5	10	2.25	50	4	A431
DES2015-7-C	□	1.5	10.5	2.4	55	4	A452
EPDSE2015-12-ATH	●	1.5	12	2.25	55	4	A293
EPDSE2015-12-PN	●	1.5	12	2.25	55	4	A296
EPDS2015-12-SD	●	1.5	12	2.25	55	4	A378
EPDS2015-12	□	1.5	12	2.25	55	4	A431
EPDS2015-12-TH	□	1.5	12	2.25	55	4	A431
DES2015-8.5-C	□	1.5	12.75	2.4	65	4	A452
EPDSE2015-14-ATH	●	1.5	14	2.25	55	4	A293
EPDSE2015-14-PN	●	1.5	14	2.25	55	4	A296
EPDS2015-14	□	1.5	14	2.25	55	4	A431
EPDS2015-14-TH	□	1.5	14	2.25	55	4	A431
DES2015-10-C	□	1.5	15	2.4	65	4	A452
EPDSE2015-16-ATH	●	1.5	16	2.25	55	4	A293
EPDSE2015-16-PN	●	1.5	16	2.25	55	4	A296
EPDS2015-16	□	1.5	16	2.25	55	4	A431
EPDS2015-16-TH	□	1.5	16	2.25	55	4	A431
EPDSE2015-18-ATH	●	1.5	18	2.25	60	4	A293
EPDSE2015-18-PN	●	1.5	18	2.25	60	4	A296
EPDS2015-18-SD	●	1.5	18	2.25	60	4	A378
EPDS2015-18	□	1.5	18	2.25	60	4	A431
EPDS2015-18-TH	□	1.5	18	2.25	60	4	A431
EPDSE2015-20-ATH	●	1.5	20	2.25	60	4	A293
EPDSE2015-20-PN	●	1.5	20	2.25	60	4	A296
EPDS2015-20	□	1.5	20	2.25	60	4	A431
EPDS2015-20-TH	□	1.5	20	2.25	60	4	A431
EPDSE2015-25-ATH	●	1.5	25	2.25	65	4	A293
EPDSE2015-25-PN	●	1.5	25	2.25	65	4	A296
EPDS2015-25	□	1.5	25	2.25	65	4	A431
EPDS2015-25-TH	□	1.5	25	2.25	65	4	A431
EPDSE2015-30-ATH	●	1.5	30	2.25	70	4	A293
EPDSE2015-30-PN	●	1.5	30	2.25	70	4	A296
EPDSE2015-35-ATH	●	1.5	35	2.25	75	4	A293
EPDSE2015-35-PN	●	1.5	35	2.25	75	4	A296
EPDSE2015-40-ATH	●	1.5	40	2.25	80	4	A293
EPDSE2015-40-PN	●	1.5	40	2.25	80	4	A296
EPPS4015-P-CS	●	1.5	-	2.3	50	6	A332
EPSMS4015-PN	□	1.5	-	2.3	56	6	A311
EPPS4015	□	1.5	-	2.3	60	6	A336
PESS2015-C	□	1.5	-	3	40	4	A434
PESS2015	□	1.5	-	3	40	4	A435
YS2015-CS	□	1.5	-	3	40	4	A437
CEPS4015-TH	●	1.5	-	3	60	6	A352
EPSM4015-PN	□	1.5	-	3.8	56	6	A313
HES2015-C	●	1.5	-	4	40	4	A387
HES2015	●	1.5	-	4	40	4	A390
PESR2015-C	□	1.5	-	4	40	4	A434
PESR2015	□	1.5	-	4	40	4	A435
YR4015-CS	□	1.5	-	4	40	4	A437
EPP4015-P-CS	●	1.5	-	4	60	6	A332
CEPR4015-TH	●	1.5	-	5	60	6	A352
CEPR4015	●	1.5	-	5	60	6	A355
HESL2015-C	●	1.5	-	8	50	4	A388
HESL2015	●	1.5	-	8	50	4	A391
EPMS40155-PN	□	1.55	-	4	56	6	A313

商品コード Item Code	在庫 Stock	外径 Tool dia.	首下長 Under neck length	刃長 Flute length	全長 Overall length	シャンク径 Shank dia.	ページ Page
HYPS2016-C	●	1.6	5	2	50	6	A385
EPDSE2016-6-ATH	●	1.6	6	2.4	50	4	A293
EPDSE2016-6-PN	●	1.6	6	2.4	50	4	A296
EPDS2016-6	□	1.6	6	2.4	50	4	A431
EPDS2016-6-TH	□	1.6	6	2.4	50	4	A431
HPSLN2016-C	●	1.6	8	2	60	6	A385
EPDSE2016-8-ATH	●	1.6	8	2.4	50	4	A293
EPDSE2016-8-PN	●	1.6	8	2.4	50	4	A296
EPDS2016-8	□	1.6	8	2.4	50	4	A431
EPDS2016-8-TH	□	1.6	8	2.4	50	4	A431
DES2016-5-C	□	1.6	8	2.6	55	4	A452
DES2016-6-C	□	1.6	9.6	2.6	55	4	A452
EPDS2016-10	□	1.6	10	2.4	50	4	A431
EPDS2016-10-TH	□	1.6	10	2.4	50	4	A431
DES2016-7-C	□	1.6	11.2	2.6	55	4	A452
EPDS2016-12	□	1.6	12	2.4	55	4	A431
EPDS2016-12-TH	□	1.6	12	2.4	55	4	A431
DES2016-8.5-C	□	1.6	13.6	2.6	65	4	A452
EPDS2016-14	□	1.6	14	2.4	55	4	A431
EPDS2016-14-TH	□	1.6	14	2.4	55	4	A431
EPDS2016-16	□	1.6	16	2.4	55	4	A431
EPDS2016-16-TH	□	1.6	16	2.4	55	4	A431
DES2016-10-C	□	1.6	16	2.6	65	4	A452
EPDS2016-18	□	1.6	18	2.4	60	4	A431
EPDS2016-18-TH	□	1.6	18	2.4	60	4	A431
EPDS2016-20	□	1.6	20	2.4	60	4	A431
EPDS2016-20-TH	□	1.6	20	2.4	60	4	A431
EPSMS4016-PN	□	1.6	-	2.4	56	6	A311
EPPS4016	□	1.6	-	2.4	60	6	A336
EPSM4016-PN	□	1.6	-	4	56	6	A313
HES2016-C	□	1.6	-	5	40	4	A387
HES2016	●	1.6	-	5	40	4	A390
EPSM40165-PN							

単位 unit : mm

商品コード Item Code	在庫 Stock	外径 Tool dia.	首下長 Under neck length	刃長 Flute length	全長 Overall length	シャンク径 Shank dia.	ページ Page
HES2018-C	□	1.8	-	5	40	4	A387
HES2018	●	1.8	-	5	40	4	A390
EPSM40185-PN	□	1.85	-	4.8	56	6	A313
EPSMS4019-PN	□	1.9	-	2.9	56	6	A311
EPDS4019	□	1.9	-	2.9	60	6	A336
EPSM4019-PN	□	1.9	-	4.8	56	6	A313
HES2019-C	□	1.9	-	6	40	4	A387
HES2019	●	1.9	-	6	40	4	A390
EPSM40195-PN	□	1.95	-	5	56	6	A313
BHS2020	□	2	2.5	1	60	6	A456
EPDSE2020-4-ATH	●	2	4	3	50	4	A294
EPDSE2020-4-PN	●	2	4	3	50	4	A297
EPDS2020-4	□	2	4	3	50	4	A431
EPDS2020-4-TH	□	2	4	3	50	4	A431
HYPS2020-C	●	2	5.5	2.5	50	6	A385
EPDSE2020-6-ATH	●	2	6	3	50	4	A294
EPDSE2020-6-PN	●	2	6	3	50	4	A297
EPDS2020-6	□	2	6	3	50	4	A431
EPDS2020-6-TH	□	2	6	3	50	4	A431
EPSM4020-6-PN	●	2	6	3	56	6	A317
DES2020-3-C	□	2	6	3.2	55	4	A452
HGOS2020-PN	●	2	7	6	40	4	A304
HGOS4020-PN	●	2	7	6	40	4	A305
EPDSE2020-8-ATH	●	2	8	3	50	4	A294
EPDSE2020-8-PN	●	2	8	3	50	4	A297
EPDS2020-8-SD	●	2	8	3	50	4	A378
EPDS2020-8	□	2	8	3	50	4	A431
EPDS2020-8-TH	□	2	8	3	50	4	A431
DES2020-4-C	□	2	8	3.2	55	4	A452
HPSLN2020-C	●	2	10	2.5	60	6	A385
EPDSE2020-10-ATH	●	2	10	3	50	4	A294
EPDSE2020-10-PN	●	2	10	3	50	4	A297
EPDS2020-10	□	2	10	3	50	4	A431
EPDS2020-10-TH	□	2	10	3	50	4	A431
EPSM4020-10-PN	●	2	10	3	68	6	A318
DES2020-5-C	□	2	10	3.2	55	4	A452
EPDSE2020-12-ATH	●	2	12	3	55	4	A294
EPDSE2020-12-PN	●	2	12	3	55	4	A297
EPDS2020-12	□	2	12	3	55	4	A431
EPDS2020-12-TH	□	2	12	3	55	4	A431
DES2020-6-C	□	2	12	3.2	55	4	A452
EPDSE2020-14-ATH	●	2	14	3	55	4	A294
EPDSE2020-14-PN	●	2	14	3	55	4	A297
EPDS2020-14	□	2	14	3	55	4	A431
EPDS2020-14-TH	□	2	14	3	55	4	A431
DES2020-7-C	□	2	14	3.2	55	4	A452
EPDSE2020-16-ATH	●	2	16	3	55	4	A294
EPDSE2020-16-PN	●	2	16	3	55	4	A297
EPDS2020-16-SD	●	2	16	3	55	4	A378
EPDS2020-16	□	2	16	3	55	4	A431
EPDS2020-16-TH	□	2	16	3	55	4	A431
DES2020-8.5-C	□	2	17	3.2	65	4	A452
EPDSE2020-18-ATH	●	2	18	3	60	4	A294
EPDSE2020-18-PN	●	2	18	3	60	4	A297
EPDS2020-18	□	2	18	3	60	4	A431
EPDS2020-18-TH	□	2	18	3	60	4	A431
EPDSE2020-20-ATH	●	2	20	3	60	4	A294
EPDSE2020-20-PN	●	2	20	3	60	4	A297
EPDS2020-20	□	2	20	3	60	4	A431
EPDS2020-20-TH	□	2	20	3	60	4	A431
DES2020-10-C	□	2	20	3.2	65	4	A452
EPDS2020-24-SD	●	2	24	3	60	4	A378
EPDSE2020-25-ATH	●	2	25	3	65	4	A294
EPDSE2020-25-PN	●	2	25	3	65	4	A297
EPDS2020-25	□	2	25	3	65	4	A431
EPDS2020-25-TH	□	2	25	3	65	4	A431
EPDSE2020-30-ATH	●	2	30	3	70	4	A294
EPDSE2020-30-PN	●	2	30	3	70	4	A297
EPDS2020-30	□	2	30	3	70	4	A431

商品コード Item Code	在庫 Stock	外径 Tool dia.	首下長 Under neck length	刃長 Flute length	全長 Overall length	シャンク径 Shank dia.	ページ Page
EPDSE2020-30-TH	□	2	30	3	70	4	A431
EPDSE2020-35-ATH	●	2	35	3	75	4	A294
EPDSE2020-35-PN	●	2	35	3	75	4	A297
EPDSE2020-40-ATH	●	2	40	3	80	4	A294
EPDSE2020-40-PN	●	2	40	3	80	4	A297
EPDSE2020-50-ATH	●	2	50	3	90	4	A294
EPDSE2020-50-PN	●	2	50	3	90	4	A297
TES2020	□	2	-	3	40	4	A440
EPPS4020-P-CS	●	2	-	3	50	6	A332
KES2020	□	2	-	3	50	6	A440
KESU2020	□	2	-	3	50	6	A440
EPSMS4020-PN	□	2	-	3	56	6	A311
EPPS4020	□	2	-	3	60	6	A336
PESS2020-C	□	2	-	4	40	4	A434
PESS2020	□	2	-	4	40	4	A435
SES2020	□	2	-	4	40	4	A439
SES2020-C	□	2	-	4	40	4	A439
CEPS4020-TH	●	2	-	4	60	6	A352
EPSM4020-PN	●	2	-	5	56	6	A313
AES2020	●	2	-	6	40	4	A386
HES2020-C	●	2	-	6	40	4	A387
HES2020	●	2	-	6	40	4	A390
HES4020-C	●	2	-	6	40	4	A394
HES4020	●	2	-	6	40	4	A396
PESR2020-C	□	2	-	6	40	4	A434
PESR4020-C	□	2	-	6	40	4	A434
PESR2020	□	2	-	6	40	4	A435
PESR4020	□	2	-	6	40	4	A435
YR4020-CS	□	2	-	6	40	4	A437
YPS2020-CS	□	2	-	6	40	4	A437
EPDSE2020-10-ATH	●	2	-	6	60	6	A308
EPP4020-P-CS	●	2	-	6	60	6	A332
EPP4020	□	2	-	6	60	6	A337
CEPR4020-TH	●	2	-	7	60	6	A352
CEPR4020	●	2	-	7	60	6	A355
GSE4020	□	2	-	10	80	4	A432
GSR2020	□	2	-	10	80	6	A441
GSD4020	□	2	-	10	100	4	A432
GXR2020	□	2	-	10	100	6	A441
HESL2020-C	●	2	-	14	50	4	A388
HESL2020	●	2	-	14	50	4	A391
GSL2020	□	2	-	20	100	6	A441
EPSM40205-PN	□	2.05	-	5.3	56	6	A313
EPSMS4021-PN	□	2.1	-	3.2	56	6	A311
EPPS4021	□	2.1	-	3.2	60	6	A336
EPSM4021-PN	□	2.1	-	5.3	56	6	A313
HES2021-C	□	2.1	-	8	40	4	A387
HES2021	●	2.1	-	8	40	4	A390
EPSM40215-PN	□	2.15	-	5.5	56	6	A313
EPSMS4022-PN	□	2.2	-	3.3	56	6	A311
EPPS4022	□	2.2	-	3.3	60	6	A336
EPSM4022-PN	□	2.2	-	5.5	56	6	A313
HES2022-C	□	2.2	-	8	40	4	A387
HES2022	●	2.2	-	8	40	4	A390
EPSM40225-PN	□	2.25	-	5.8	56	6	A313
EPSMS4023-PN	□	2.3	-	3.5	56	6	A311
EPPS4023	□	2.3	-	3.5	60	6	A336
EPSM4023-PN	□	2.3	-	5.8	56	6	A313
HES2023-C	□	2.3	-	8	40	4	A387
HES2023	●	2.3	-	8	40	4	A390
EPSM40235-PN	□	2.35	-	6	56	6	A313
EPSMS4024-PN	□	2.4	-	3.6	56	6	A311
EPPS4024	□	2.4	-	3.6	60	6	A336
EPSM4024-PN	□	2.4	-	6	56	6	A313
HES2024-C	□	2.4	-	8	40	4	A387
HES2024	●	2.4	-	8	40	4	A390
EPSM40245-PN	□	2.45	-	6.3	56	6	A313
HYPS2025-C	●	2.5	6	3	50	6	A385
EPSM4025-7.5-PN	□	2.5	7.5	3.8	56	6	A317

商品コード Item Code	在庫 Stock	外径 Tool dia.	首下長 Under neck length	刃長 Flute length	全長 Overall length	シャンク径 Shank dia.	ページ Page
DES2025-3-C	□	2.5	7.5	4	55	4	A452
EPDSE2025-8-ATH	●	2.5	8	3.75	50	4	A294
EPDSE2025-8-PN	●	2.5	8	3.75	50	4	A297
EPDS2025-8	□	2.5	8	3.75	50	4	A431
EPDS2025-8-TH	□	2.5	8	3.75	50	4	A431
HGOS2025-PN	●	2.5	9	8	40	4	A304
HGOS4025-PN	●	2.5	9	8	40	4	A305
EPDSE2025-12-ATH	●	2.5	12	3.75	55	4	A294
EPDSE2025-12-PN	●	2.5	12	3.75	55	4	A297
EPDS2025-12	□	2.5	12	3.75	55	4	A431
EPDS2025-12-TH	□	2.5	12	3.75	55	4	A431
HPSLN2025-C	●	2.5	12.5	3	60	6	A385
EPSM4025-12.5-PN	□	2.5	12.5	3.8	68	6	A318
DES2025-5-C	□	2.5	12.5	4	55	4	A452
DES2025-6-C	□	2.5	15	4	55	4	A452
EPDSE2025-16-ATH	●	2.5	16	3.75	55	4	A294
EPDSE2025-16-PN	●	2.5	16	3.75	55	4	A297
EPDS2025-16	□	2.5	16	3.75	55	4	A431
EPDS2025-16-TH	□	2.5	16	3.75	55	4	A431
DES2025-7-C	□	2.5	17.5	4	55	4	A452
EPDSE2025-20-ATH	●	2.5	20	3.75	60	4	A294
EPDSE2025-20-PN	●	2.5	20	3.75	60	4	A297
EPDS2025-20	□	2.5	20	3.75	60	4	A431
EPDS2025-20-TH	□	2.5	20	3.75	60	4	A431
DES2025-8.5-C	□	2.5	21.3	4	55	4	A452
EPDSE2025-30-ATH	●	2.5	30	3.75	70	4	A294
EPDSE2025-30-PN	●	2.5	30	3.75	70	4	A297
EPDSE2025-40-ATH	●	2.5	40	3.75	80	4	A294
EPDSE2025-40-PN	●	2.5	40	3.75	80	4	A297
EPDSE2025-50-ATH	●	2.5	50	3.75	90	4	A294
EPDSE2025-50-PN	●	2.5	50	3.75	90	4	A297
EPPS4025-P-CS	●	2.5	-	3.8	50	6	A332
EPSMS4025-PN	□	2.5	-	3.8	56	6	A311
EPPS4025	□	2.5	-	3.8	60	6	A336
PESS2025-C	□	2.5	-	5	40	4	A434
PESS2025	□	2.5	-	5	40	4	A435
CEPS4025-TH	●	2.5	-	5	60	6	A352
EPSM4025-PN	□	2.5	-	6.3	56	6	A313
HES2025-C	●	2.5	-	8	40	4	A387
HES2025	●	2.5	-	8	40	4	A390
HES4025-C	●	2.5	-	8	40	4	A394
HES4025	●	2.5	-	8	40	4	A396
PESR2025-C	□	2.5	-	8	40	4	A434
PESR4025-C	□	2.5	-</				

外径別寸法早見表

超硬エンドミル・スクエア

φ2.8 ~ φ5 Carbide End Mills -Square

単位 unit : mm

商品コード Item Code	在庫 Stock	外径 Tool dia.	首下長 Under neck length	刃長 Flute length	全長 Overall length	シャンク径 Shank dia.	ページ Page
EPPS4028	□	2.8	-	4.2	60	6	A336
EPMS4028-PN	□	2.8	-	7	56	6	A313
HES2028-C	□	2.8	-	10	45	6	A387
HES2028	●	2.8	-	10	45	6	A390
EPMS40285-PN	□	2.85	-	7.3	56	6	A313
EPMS4029-PN	□	2.9	-	4.4	56	6	A311
EPPS4029	□	2.9	-	4.4	60	6	A336
EPMS4029-PN	□	2.9	-	7.3	56	6	A313
HES2029-C	□	2.9	-	10	45	6	A387
HES2029	●	2.9	-	10	45	6	A390
EPMS40295-PN	□	2.95	-	7.5	56	6	A313
HYP2030-C	●	3	8	4	50	6	A385
EPDSE2030-8-ATH	●	3	8	4.5	55	6	A294
EPDSE2030-8-PN	●	3	8	4.5	55	6	A297
EPDS2030-8	□	3	8	4.5	55	6	A431
EPDS2030-8-TH	□	3	8	4.5	55	6	A431
EPMS4030-9-PN	●	3	9	4.5	56	6	A317
EMXA3030-9	○	3	9	4.5	60	6	A374
DES2030-3-C	□	3	9	4.8	80	6	A452
HGOS2030-PN	●	3	9	8	45	6	A304
EPMS4030-PN	●	3	10.5	4.5	80	6	A316
EPPLS4030	●	3	10.5	4.5	80	6	A338
HGOS4030-PN	●	3	11	10	45	6	A305
EPDSE2030-12-ATH	●	3	12	4.5	60	6	A294
EPDSE2030-12-PN	●	3	12	4.5	60	6	A297
EPDS2030-12-SD	●	3	12	4.5	60	6	A378
EPDS2030-12	□	3	12	4.5	60	6	A431
EPDS2030-12-TH	□	3	12	4.5	60	6	A431
DES2030-4-C	□	3	12	4.8	80	6	A452
HPSLN2030-C	●	3	15	4	80	6	A385
EPMS4030-15-PN	●	3	15	4.5	68	6	A318
DES2030-5-C	□	3	15	4.8	80	6	A452
EPDSE2030-16-ATH	●	3	16	4.5	60	6	A294
EPDSE2030-16-PN	●	3	16	4.5	60	6	A297
EPDS2030-16	□	3	16	4.5	60	6	A431
EPDS2030-16-TH	□	3	16	4.5	60	6	A431
DES2030-6-C	□	3	18	4.8	80	6	A452
EPDSE2030-20-ATH	●	3	20	4.5	65	6	A294
EPDSE2030-20-PN	●	3	20	4.5	65	6	A297
EPDS2030-20	□	3	20	4.5	65	6	A431
EPDS2030-20-TH	□	3	20	4.5	65	6	A431
DES2030-7-C	□	3	21	4.8	80	6	A452
EPDS2030-24-SD	●	3	24	4.5	65	6	A378
EPDSE2030-25-ATH	●	3	25	4.5	70	6	A294
EPDSE2030-25-PN	●	3	25	4.5	70	6	A297
EPDS2030-25	□	3	25	4.5	70	6	A431
EPDS2030-25-TH	□	3	25	4.5	70	6	A431
DES2030-8.5-C	□	3	25.5	4.8	80	6	A452
EPDSE2030-30-ATH	●	3	30	4.5	75	6	A294
EPDSE2030-30-PN	●	3	30	4.5	75	6	A297
EPDS2030-30	□	3	30	4.5	75	6	A431
EPDS2030-30-TH	□	3	30	4.5	75	6	A431
EPDS2030-36-SD	●	3	36	4.5	80	6	A378
EPDSE2030-40-ATH	●	3	40	4.5	90	6	A294
EPDSE2030-40-PN	●	3	40	4.5	90	6	A297
EPDS2030-40	□	3	40	4.5	90	6	A431
EPDS2030-40-TH	□	3	40	4.5	90	6	A431
EPDSE2030-50-ATH	●	3	50	4.5	100	6	A294
EPDSE2030-50-PN	●	3	50	4.5	100	6	A297
EPPS4030-P-C	●	3	-	4.5	50	6	A332
KES2030	□	3	-	4.5	50	6	A440
KESU2030	□	3	-	4.5	50	6	A440
EPMS4030-PN	□	3	-	4.5	56	6	A311
EPPS4030-TH	●	3	-	4.5	60	6	A328
EPPS4030	●	3	-	4.5	60	6	A336
TES2030	□	3	-	5	45	6	A440
SES2030	□	3	-	6	45	6	A439
SES2030-C	□	3	-	6	45	6	A439
CEPS4030-TH	●	3	-	6	60	6	A352

商品コード Item Code	在庫 Stock	外径 Tool dia.	首下長 Under neck length	刃長 Flute length	全長 Overall length	シャンク径 Shank dia.	ページ Page
CEPH4030	●	3	-	6	60	6	A356
PESS2030-C	□	3	-	7	45	6	A434
PESS2030	□	3	-	7	45	6	A435
EPSF4030-PN	●	3	-	7.5	56	6	A310
EPMS4030-PN	●	3	-	7.5	56	6	A313
AES2030	●	3	-	8	45	6	A386
YS2030-CS	□	3	-	8	45	6	A437
EPP3030-CS	●	3	-	8	60	6	A308
EPP4030-TH	●	3	-	8	60	6	A328
EPP4030-CS	●	3	-	8	60	6	A332
EPP4030-P-CS	●	3	-	8	60	6	A332
EPP4030	●	3	-	8	60	6	A337
EPAS2030-SD	●	3	-	8	60	6	A380
HES2030-C	●	3	-	10	45	6	A387
HES2030	●	3	-	10	45	6	A390
HES4030-C	●	3	-	10	45	6	A394
HES4030	●	3	-	10	45	6	A396
PESR2030-C	□	3	-	10	45	6	A434
PESR4030-C	□	3	-	10	45	6	A434
PESR2030	□	3	-	10	45	6	A435
PESR4030	□	3	-	10	45	6	A435
YR4030-CS	□	3	-	10	45	6	A437
CEPR4030-TH	●	3	-	10	60	6	A352
CEPR4030	●	3	-	10	60	6	A355
EPFSM4030-PN	●	3	-	12	56	6	A310
EPMSM4030-PN	●	3	-	12	56	6	A315
HESM2030-C	●	3	-	15	50	6	A388
HESM2030	●	3	-	15	50	6	A391
HESM4030-C	●	3	-	15	50	6	A394
HESM4030	●	3	-	15	50	6	A396
EPFL4030-PN	●	3	-	15	56	6	A310
EPPM4030-TH	●	3	-	15	60	6	A328
EPPM4030	●	3	-	15	60	6	A338
CEPL4030-TH	●	3	-	15	60	6	A352
CEPL4030	●	3	-	15	60	6	A355
GSE4030	□	3	-	15	80	4	A432
GSR2030	□	3	-	15	80	6	A441
GSD4030	□	3	-	15	100	4	A432
GXR2030	□	3	-	15	100	6	A441
EPPL4030	□	3	-	18	65	6	A338
HESL2030-C	●	3	-	20	55	6	A388
HESL2030	●	3	-	20	55	6	A391
HESL4030-C	●	3	-	20	55	6	A394
HESL4030	●	3	-	20	55	6	A396
GSL2030	□	3	-	30	100	6	A441
EPMS40305-PN	□	3.05	-	7.8	56	6	A313
EPMS4031-PN	□	3.1	-	4.7	56	6	A311
EPPS4031	□	3.1	-	4.7	60	6	A336
EPMS4031-PN	□	3.1	-	7.8	56	6	A313
HES2031-C	□	3.1	-	11	45	6	A387
HES2031	●	3.1	-	11	45	6	A390
EPMS40315-PN	□	3.15	-	8	56	6	A313
EPMS4032-PN	□	3.2	-	4.8	56	6	A311
EPPS4032	□	3.2	-	4.8	60	6	A336
EPMS4032-PN	□	3.2	-	8	56	6	A313
HES2032-C	□	3.2	-	11	45	6	A387
HES2032	●	3.2	-	11	45	6	A390
EPMS40325-PN	□	3.25	-	8.3	56	6	A313
EPMS4033-PN	□	3.3	-	5	56	6	A311
EPPS4033	□	3.3	-	5	60	6	A336
EPMS4033-PN	□	3.3	-	8.3	56	6	A313
HES2033-C	□	3.3	-	11	45	6	A387
HES2033	●	3.3	-	11	45	6	A390
EPMS40335-PN	□	3.35	-	8.5	56	6	A313
EPMS4034-PN	□	3.4	-	5.1	56	6	A311
EPPS4034	□	3.4	-	5.1	60	6	A336
EPMS4034-PN	□	3.4	-	8.5	56	6	A313
HES2034-C	□	3.4	-	11	45	6	A387
HES2034	●	3.4	-	11	45	6	A390

商品コード Item Code	在庫 Stock	外径 Tool dia.	首下長 Under neck length	刃長 Flute length	全長 Overall length	シャンク径 Shank dia.	ページ Page
EPMS40345-PN	□	3.45	-	8.8	56	6	A313
HYP2035-C	●	3.5	8.5	4.5	50	6	A385
EPMS4035-10.5-PN	□	3.5	10.5	5.3	56	6	A317
DES2035-3-C	□	3.5	10.5	5.6	80	6	A452
HGOS2035-PN	●	3.5	11	10	45	6	A304
HPSLN2035-C	●	3.5	17.5	4.5	80	6	A385
EPMS4035-17.5-PN	□	3.5	17.5	5.3	68	6	A318
DES2035-5-C	□	3.5	17.5	5.6	80	6	A452
DES2035-6-C	□	3.5	21	5.6	80	6	A452
DES2035-7-C	□	3.5	24.5	5.6	80	6	A452
DES2035-8.5-C	□	3.5	29.8	5.6	80	6	A452
EPPS4035-P-CS	●	3.5	-	5.3	50	6	A332
EPMS4035-PN	□	3.5	-	5.3	56	6	A311
EPPS4035-TH	●	3.5	-	5.3	60	6	A328
EPPS4035	●	3.5	-	5.3	60	6	A336
PESS2035-C	□	3.5	-	8	45	6	A434
PESS2035	□	3.5	-	8	45	6	A435
EPSF4035-PN	●	3.5	-	8.8	56	6	A310
EPMS4035-PN	□	3.5	-	8.8	56	6	A313
YS2035-CS	□	3.5	-	10	45	6	A437
EPP3035-CS	□	3.5	-	10	60	6	A308
EPP4035	□	3.5	-	10	60	6	A337
HES2035-C	●	3.5	-	11	45	6	A387
HES2035	●	3.5	-	11	45	6	A390
HES4035-C	●	3.5	-	11	45	6	A394
HES4035	●	3.5	-	11	45	6	A396
PESR2035-C	□	3.5	-	11	45	6	A434
PESR4035-C	□	3.5	-	11	45	6	A434
PESR2035	□	3.5	-	11	45	6	A435
PESR4035	□	3.5	-	11	45	6	A435
CEPR4035-TH	●	3.5	-	12	60	6	A352
CEPR4035	●	3.5	-	12	60	6	A355
EPFSM4035-PN	●	3.5	-	14	56	6	A310
EPMS40355-PN	□	3.55	-	9	56	6	A313
EPMS4036-PN	□	3.6	-	5.4	56	6	A311
EPPS4036	□	3.6	-	5.4	60	6	A336
EPMS4036-PN	□	3.6	-	9	56	6	A313
HES2036-C	□	3.6	-	12	45	6	A387
HES2036	●	3.6	-	12	45	6	A390
EPMS40365-PN	□	3.65	-	9.3	56	6	A313
EPMS4037-PN	□	3.7	-	5.6	56	6	A311
EPPS4037	□	3.7	-	5.6	60	6	A336
EPMS4037-PN	□	3.7	-	9.3			

単位 unit : mm

商品コード Item Code	在庫 Stock	外径 Tool dia.	首下長 Under neck length	刃長 Flute length	全長 Overall length	シャンク径 Shank dia.	ページ Page
EPSMLS4040-PN	●	4	14	6	80	6	A316
EPPLS4040	●	4	14	6	80	6	A338
EPDSE2040-16-ATH	●	4	16	6	60	6	A294
EPDSE2040-16-PN	●	4	16	6	60	6	A297
EPDSE2040-16-SD	●	4	16	6	60	6	A378
EPDSE2040-16	□	4	16	6	60	6	A431
EPDSE2040-16-TH	□	4	16	6	60	6	A431
DES2040-4-C	□	4	16	6.4	80	6	A452
HPSLN2040-C	●	4	20	5	80	6	A385
EPSM4040-20-PN	●	4	20	6	68	6	A318
EPSW3040-20-PN	●	4	20	6	68	6	A363
EPDSE2040-20-ATH	●	4	20	6	70	6	A294
EPDSE2040-20-PN	●	4	20	6	70	6	A297
EPDSE2040-20	□	4	20	6	70	6	A431
EPDSE2040-20-TH	□	4	20	6	70	6	A431
DES2040-5-C	□	4	20	6.4	80	6	A452
DES2040-6-C	□	4	24	6.4	80	6	A452
EPDSE2040-25-ATH	●	4	25	6	70	6	A294
EPDSE2040-25-PN	●	4	25	6	70	6	A297
EPDSE2040-25	□	4	25	6	70	6	A431
EPDSE2040-25-TH	□	4	25	6	70	6	A431
DES2040-7-C	□	4	28	6.4	80	6	A452
EPDSE2040-30-ATH	●	4	30	6	80	6	A294
EPDSE2040-30-PN	●	4	30	6	80	6	A297
EPDSE2040-30	□	4	30	6	80	6	A431
EPDSE2040-30-TH	□	4	30	6	80	6	A431
EPDSE2040-32-SD	●	4	32	6	80	6	A378
DES2040-8.5-C	□	4	34	6.4	80	6	A452
EPDSE2040-35-ATH	●	4	35	6	80	6	A294
EPDSE2040-35-PN	●	4	35	6	80	6	A297
EPDSE2040-35	□	4	35	6	80	6	A431
EPDSE2040-35-TH	□	4	35	6	80	6	A431
EPDSE2040-40-ATH	●	4	40	6	90	6	A294
EPDSE2040-40-PN	●	4	40	6	90	6	A297
EPDSE2040-40	□	4	40	6	90	6	A431
EPDSE2040-40-TH	□	4	40	6	90	6	A431
EPDSE2040-48-SD	●	4	48	6	90	6	A378
EPDSE2040-50-ATH	●	4	50	6	100	6	A294
EPDSE2040-50-PN	●	4	50	6	100	6	A297
EPPS4040-P-CS	●	4	-	6	50	6	A332
KES2040	□	4	-	6	55	8	A440
KESU2040	□	4	-	6	55	8	A440
EPMS4040-PN	□	4	-	6	56	6	A311
EPPS4040-TH	●	4	-	6	60	6	A328
EPPS4040	●	4	-	6	60	6	A336
TES2040	□	4	-	7	45	6	A440
PESS2040-C	□	4	-	8	45	6	A434
PESS2040	□	4	-	8	45	6	A435
SES2040	□	4	-	8	45	6	A439
SES2040-C	□	4	-	8	45	6	A439
CEPS4040-TH	●	4	-	8	60	6	A352
CEPH4040	●	4	-	8	60	6	A356
EPSF4040-PN	●	4	-	10	56	6	A310
EPSM4040-PN	●	4	-	10	56	6	A313
EPSW3040-PN	●	4	-	10	56	6	A361
AES2040	●	4	-	11	45	6	A386
YS2040-CS	□	4	-	11	45	6	A437
EPP3040-CS	●	4	-	11	60	6	A308
EPP4040-TH	●	4	-	11	60	6	A328
EPP4040-CS	●	4	-	11	60	6	A332
EPP4040-P-CS	●	4	-	11	60	6	A332
EPP4040	●	4	-	11	60	6	A337
EPAS2040-SD	●	4	-	11	60	6	A380
HES2040-C	●	4	-	12	45	6	A387
HES2040	●	4	-	12	45	6	A390
HES4040-C	●	4	-	12	45	6	A394
HES4040	●	4	-	12	45	6	A396
PESR2040-C	□	4	-	12	45	6	A434
PESR4040-C	□	4	-	12	45	6	A434

商品コード Item Code	在庫 Stock	外径 Tool dia.	首下長 Under neck length	刃長 Flute length	全長 Overall length	シャンク径 Shank dia.	ページ Page
PESR2040	□	4	-	12	45	6	A435
PESR4040	□	4	-	12	45	6	A435
YR4040-CS	□	4	-	12	45	6	A437
CEPR4040-TH	●	4	-	12	60	6	A352
CEPR4040	●	4	-	12	60	6	A355
CEPU4040	●	4	-	12	60	6	A356
EPSFM4040-PN	●	4	-	16	56	6	A310
EPMSM4040-PN	●	4	-	16	56	6	A315
HESM2040-C	●	4	-	17	50	6	A388
HESM2040	●	4	-	17	50	6	A391
HESM4040-C	●	4	-	17	50	6	A394
HESM4040	●	4	-	17	50	6	A396
EPPM4040-TH	●	4	-	17	60	6	A328
EPPM4040	●	4	-	17	60	6	A338
FE704	□	4	-	20	65	4	A440
EPPL4040	□	4	-	20	65	6	A338
CEPL4040-TH	●	4	-	20	65	6	A352
CEPL4040	●	4	-	20	65	6	A355
EPSFL4040-PN	●	4	-	20	70	6	A310
GSE4040	□	4	-	20	80	4	A432
GSR2040	□	4	-	20	80	6	A441
GSD4040	□	4	-	20	100	4	A432
GXR2040	□	4	-	20	110	6	A441
HESL2040-C	●	4	-	24	57	6	A388
HESL2040	●	4	-	24	57	6	A391
HESL4040-C	●	4	-	24	57	6	A394
HESL4040	●	4	-	24	57	6	A396
GSL2040	□	4	-	60	110	6	A441
EPSM40405-PN	□	4.05	-	10.3	56	6	A313
EPMS4041-PN	□	4.1	-	6.2	56	6	A311
EPPS4041	□	4.1	-	6.2	60	6	A336
EPSM4041-PN	□	4.1	-	10.3	56	6	A313
HES2041-C	□	4.1	-	14	45	6	A387
HES2041	●	4.1	-	14	45	6	A390
EPSM40415-PN	□	4.15	-	10.5	56	6	A313
EPMS4042-PN	□	4.2	-	6.3	56	6	A311
EPPS4042	□	4.2	-	6.3	60	6	A336
EPSM4042-PN	□	4.2	-	10.5	56	6	A313
HES2042-C	□	4.2	-	14	45	6	A387
HES2042	●	4.2	-	14	45	6	A390
EPSM40425-PN	□	4.25	-	10.8	56	6	A313
EPMS4043-PN	□	4.3	-	6.5	56	6	A311
EPPS4043	□	4.3	-	6.5	60	6	A336
EPSM4043-PN	□	4.3	-	10.8	56	6	A313
HES2043-C	□	4.3	-	14	45	6	A387
HES2043	●	4.3	-	14	45	6	A390
EPSM40435-PN	□	4.35	-	11	56	6	A313
EPMS4044-PN	□	4.4	-	6.6	56	6	A311
EPPS4044	□	4.4	-	6.6	60	6	A336
EPSM4044-PN	□	4.4	-	11	56	6	A313
HES2044-C	□	4.4	-	14	45	6	A387
HES2044	●	4.4	-	14	45	6	A390
EPSM40445-PN	□	4.45	-	11.3	56	6	A313
HGOS2045-PN	●	4.5	12	11	45	6	A304
EPSM4045-13.5-PN	□	4.5	13.5	6.8	56	6	A317
EPSM4045-22.5-PN	□	4.5	22.5	6.8	68	6	A318
DES2045-7-C	□	4.5	31.5	7.2	80	6	A452
EPPS4045-P-CS	●	4.5	-	6.8	50	6	A332
EPMS4045-PN	□	4.5	-	6.8	56	6	A311
EPPS4045-TH	●	4.5	-	6.8	60	6	A328
EPPS4045	●	4.5	-	6.8	60	6	A336
PESS2045-C	□	4.5	-	10	45	6	A434
PESS2045	□	4.5	-	10	45	6	A435
YS2045-CS	□	4.5	-	11	45	6	A437
EPP3045-CS	□	4.5	-	11	60	6	A308
EPP4045	□	4.5	-	11	60	6	A337
EPSF4045-PN	●	4.5	-	11.3	56	6	A310
EPSM4045-PN	□	4.5	-	11.3	56	6	A313
EPSW3045-PN	□	4.5	-	11.3	56	6	A361

商品コード Item Code	在庫 Stock	外径 Tool dia.	首下長 Under neck length	刃長 Flute length	全長 Overall length	シャンク径 Shank dia.	ページ Page
HES2045-C	●	4.5	-	14	45	6	A387
HES2045	●	4.5	-	14	45	6	A390
HES4045-C	●	4.5	-	14	45	6	A394
HES4045	●	4.5	-	14	45	6	A396
PESR2045-C	□	4.5	-	14	45	6	A434
PESR4045-C	□	4.5	-	14	45	6	A434
PESR2045	□	4.5	-	14	45	6	A435
PESR4045	□	4.5	-	14	45	6	A435
CEPR4045-TH	●	4.5	-	15	60	6	A352
CEPR4045	●	4.5	-	15	60	6	A355
EPSFM4045-PN	●	4.5	-	18	70	6	A310
EPMS40455-PN	□	4.55	-	11.5	56	6	A313
EPMS4046-PN	□	4.6	-	6.9	56	6	A311
EPPS4046	□	4.6	-	6.9	60	6	A336
EPMS4046-PN	□	4.6	-	11.5	56	6	A313
HES2046-C	□	4.6	-	15	50	6	A387
HES2046	●	4.6	-	15	50	6	A390
EPMS40465-PN	□	4.65	-	11.8	56	6	A313
EPMS4047-PN	□	4.7	-	7.1	56	6	A311
EPPS4047	□	4.7	-	7.1	60	6	A336
EPMS4047-PN	□	4.7	-	11.8	56	6	A313
HES2047-C	□	4.7	-	15	50	6	A387
HES2047	●	4.7	-	15	50	6	A390
EPMS40475-PN	□	4.75	-	12	56	6	A313
EPMS4048-PN	□	4.8	-	7.2	56	6	A311
EPPS4048	□	4.8	-	7.2	60	6	A336
EPMS4048-PN	□	4.8	-	12	56	6	A313
HES2048-C	□	4.8	-	15	50	6	A387
HES2048	●	4.8	-	15	50	6	A390
EPMS40485-PN	□	4.85	-	12.3	56	6	A313
EPMS4049-PN	□	4.9	-	7.4	56	6	A311
EPPS4049	□	4.9	-	7.4	60	6	A336
EPMS4049-PN	□	4.9	-	12.3	56	6	A313
HES2049-C	□	4.9	-	15	50	6	A387
HES2049	●	4.9	-	15	50	6	A390
EPMS40495-PN	□	4.95	-	12.5	56	6	A313
HYPS2050-C	●	5	11	6	50	6	A385
HGOS2050-PN	●	5	14	13	60	6	A304
EPMS4050-15-PN	●	5	15	7.5	56	6	A317
EPSW3050-15-PN	●	5	15	7.5	56	6	A363
EMXA3050-15	◎	5	15	7.5	80	6	A374
DES2050-3-C	□	5	15	8	80	6	A452
HGOS4050-PN	●	5	16	15	60	6	A305
EPSMLS4050-PN	●	5	17.5	7.5	100	6	A316
EPPLS4050	●	5	17.5	7.5	100	6	A338
EPDSE2050-20-ATH	●	5	20	7.5	70	6	A294
EPDSE2050-20-PN							

Quick dimension reference table by mill diameter

外径別寸法早見表

超硬エンドミル・スクエア

φ5 ~ φ7.6 Carbide End Mills -Square

単位 unit : mm

商品コード Item Code	在庫 Stock	外径 Tool dia.	首下長 Under neck length	刃長 Flute length	全長 Overall length	シャンク径 Shank dia.	ページ Page
TES2050	□	5	-	9	50	6	A440
PESS2050-C	□	5	-	10	50	6	A434
PESS2050	□	5	-	10	50	6	A435
SES2050	□	5	-	10	50	6	A439
SES2050-C	□	5	-	10	50	6	A439
CEPS4050-TH	●	5	-	10	60	6	A352
CEPH4050	●	5	-	10	60	6	A356
EPF4050-PN	●	5	-	12.5	56	6	A310
EPSM4050-PN	●	5	-	12.5	56	6	A313
EPSW3050-PN	●	5	-	12.5	56	6	A361
AES2050	●	5	-	13	50	6	A386
YS2050-CS	□	5	-	13	50	6	A437
EPP3050-CS	●	5	-	13	60	6	A308
EPP4050-TH	●	5	-	13	60	6	A328
EPP4050-CS	●	5	-	13	60	6	A332
EPP4050-P-CS	●	5	-	13	60	6	A332
EPP4050	●	5	-	13	60	6	A337
EPAS2050-SD	●	5	-	13	60	6	A380
HES2050-C	●	5	-	15	50	6	A387
HES2050	●	5	-	15	50	6	A390
HES4050-C	●	5	-	15	50	6	A394
HES4050	●	5	-	15	50	6	A396
PESR2050-C	□	5	-	15	50	6	A434
PESR4050-C	□	5	-	15	50	6	A434
PESR2050	□	5	-	15	50	6	A435
PESR4050	□	5	-	15	50	6	A435
YR4050-CS	□	5	-	15	50	6	A437
CEPR4050-TH	●	5	-	15	60	6	A352
CEPR4050	●	5	-	15	60	6	A355
HESM2050-C	●	5	-	20	53	6	A388
HESM2050	●	5	-	20	53	6	A391
HESM4050-C	●	5	-	20	53	6	A394
HESM4050	●	5	-	20	53	6	A396
EPPM4050-TH	●	5	-	20	60	6	A328
EPPM4050	●	5	-	20	60	6	A338
EPSFM4050-PN	●	5	-	20	70	6	A310
EPSMM4050-PN	●	5	-	20	70	6	A315
EPSFL4050-PN	●	5	-	25	70	6	A310
EPPL4050	□	5	-	25	70	6	A338
CEPL4050-TH	●	5	-	25	70	6	A352
CEPL4050	●	5	-	25	70	6	A355
GSR2050	□	5	-	25	100	6	A441
GXR2050	□	5	-	25	125	6	A441
HESL2050-C	●	5	-	30	65	6	A388
HESL2050	●	5	-	30	65	6	A391
HESL4050-C	●	5	-	30	65	6	A394
HESL4050	●	5	-	30	65	6	A396
GSE4050	□	5	-	30	100	6	A432
GSD4050	□	5	-	30	120	6	A432
GSL2050	□	5	-	70	125	6	A441
EPSM40505-PN	□	5.05	-	12.8	56	6	A313
EPSMS4051-PN	□	5.1	-	7.7	56	6	A311
EPPS4051	□	5.1	-	7.7	60	6	A336
EPSM4051-PN	□	5.1	-	12.8	56	6	A313
HES2051-C	□	5.1	-	15	50	6	A387
HES2051	●	5.1	-	15	50	6	A390
EPSM40515-PN	□	5.15	-	13	56	6	A313
EPSMS4052-PN	□	5.2	-	7.8	56	6	A311
EPPS4052	□	5.2	-	7.8	60	6	A336
EPSM4052-PN	□	5.2	-	13	56	6	A313
HES2052-C	□	5.2	-	15	50	6	A387
HES2052	●	5.2	-	15	50	6	A390
EPSM40525-PN	□	5.25	-	13.3	56	6	A313
EPSMS4053-PN	□	5.3	-	8	56	6	A311
EPPS4053	□	5.3	-	8	60	6	A336
EPSM4053-PN	□	5.3	-	13.3	56	6	A313
HES2053-C	□	5.3	-	15	50	6	A387
HES2053	●	5.3	-	15	50	6	A390
EPSM40535-PN	□	5.35	-	13.5	56	6	A313

商品コード Item Code	在庫 Stock	外径 Tool dia.	首下長 Under neck length	刃長 Flute length	全長 Overall length	シャンク径 Shank dia.	ページ Page
EPSMS4054-PN	□	5.4	-	8.1	56	6	A311
EPPS4054	□	5.4	-	8.1	60	6	A336
EPSM4054-PN	□	5.4	-	13.5	56	6	A313
HES2054-C	□	5.4	-	15	50	6	A387
HES2054	●	5.4	-	15	50	6	A390
EPSM40545-PN	□	5.45	-	13.8	56	6	A313
HGOS2055-PN	●	5.5	14	13	60	6	A304
EPSM4055-16.5-PN	□	5.5	16.5	8.3	56	6	A317
EPSM4055-27.5-PN	□	5.5	27.5	8.3	68	6	A318
DES2055-7-C	□	5.5	38.5	8.8	90	6	A452
EPSMS4055-PN	□	5.5	-	8.3	56	6	A311
EPPS4055-TH	●	5.5	-	8.3	60	6	A328
EPPS4055	●	5.5	-	8.3	60	6	A336
PESS2055-C	□	5.5	-	12	50	6	A434
PESS2055	□	5.5	-	12	50	6	A435
YS2055-CS	□	5.5	-	13	50	6	A437
EPP3055-CS	□	5.5	-	13	60	6	A308
EPP4055	□	5.5	-	13	60	6	A337
EPF4055-PN	●	5.5	-	13.8	56	6	A310
EPSM4055-PN	□	5.5	-	13.8	56	6	A313
EPSW3055-PN	□	5.5	-	13.8	56	6	A361
HES2055-C	●	5.5	-	15	50	6	A387
HES2055	●	5.5	-	15	50	6	A390
HES4055-C	●	5.5	-	15	50	6	A394
HES4055	●	5.5	-	15	50	6	A396
PESR2055-C	□	5.5	-	15	50	6	A434
PESR4055-C	□	5.5	-	15	50	6	A434
PESR2055	□	5.5	-	15	50	6	A435
PESR4055	□	5.5	-	15	50	6	A435
CEPR4055-TH	●	5.5	-	15	60	6	A352
CEPR4055	●	5.5	-	15	60	6	A355
EPSFM4055-PN	●	5.5	-	22	70	6	A310
EPSM40555-PN	□	5.55	-	14	56	6	A313
EPSMS4056-PN	□	5.6	-	8.4	56	6	A311
EPPS4056	□	5.6	-	8.4	60	6	A336
EPSM4056-PN	□	5.6	-	14	56	6	A313
HES2056-C	□	5.6	-	15	50	6	A387
HES2056	●	5.6	-	15	50	6	A390
EPSM40565-PN	□	5.65	-	14.3	56	6	A313
EPSMS4057-PN	□	5.7	-	8.6	56	6	A311
EPPS4057	□	5.7	-	8.6	60	6	A336
EPSM4057-PN	□	5.7	-	14.3	56	6	A313
HES2057-C	□	5.7	-	15	50	6	A387
HES2057	●	5.7	-	15	50	6	A390
EPSM40575-PN	□	5.75	-	14.5	56	6	A313
EPSMS4058-PN	□	5.8	-	8.7	56	6	A311
EPPS4058	□	5.8	-	8.7	60	6	A336
EPSM4058-PN	□	5.8	-	14.5	56	6	A313
HES2058-C	□	5.8	-	15	50	6	A387
HES2058	●	5.8	-	15	50	6	A390
EPSM40585-PN	□	5.85	-	14.8	56	6	A313
EPSMS4059-PN	□	5.9	-	8.9	56	6	A311
EPPS4059	□	5.9	-	8.9	60	6	A336
EPSM4059-PN	□	5.9	-	14.8	56	6	A313
HES2059-C	□	5.9	-	15	50	6	A387
HES2059	●	5.9	-	15	50	6	A390
EPSM40595-PN	□	5.95	-	15	56	6	A313
HYPS2060-C	●	6	12.5	7.5	50	6	A385
EPSM4060-18-PN	●	6	18	9	56	6	A317
EPSW4060-18-PN	●	6	18	9	56	6	A363
EMXA3060-18	◎	6	18	9	80	6	A374
ES8WB0600LN-20-ATH	●	6	20	6	70	6	A344
EPDSE2060-20-ATH	●	6	20	9	70	6	A294
EPDSE2060-20-PN	●	6	20	9	70	6	A297
ES8WB0600LN-30-ATH	●	6	30	6	80	6	A344
HPSLN2060-C	●	6	30	7.5	80	6	A385
EPSM4060-30-PN	●	6	30	9	68	6	A318
EPSW4060-30-PN	●	6	30	9	68	6	A363
EPDSE2060-30-ATH	●	6	30	9	80	6	A294

商品コード Item Code	在庫 Stock	外径 Tool dia.	首下長 Under neck length	刃長 Flute length	全長 Overall length	シャンク径 Shank dia.	ページ Page
EPDSE2060-30-PN	●	6	30	9	80	6	A297
ES8WB0600LN-40-ATH	●	6	40	6	90	6	A344
EPDSE2060-40-ATH	●	6	40	9	90	6	A294
EPDSE2060-40-PN	●	6	40	9	90	6	A297
DES2060-7-C	□	6	42	9.6	90	6	A452
ES8WB0600LN-50-ATH	●	6	50	6	100	6	A344
EPDSE2060-50-ATH	●	6	50	9	100	6	A294
EPDSE2060-50-PN	●	6	50	9	100	6	A297
EPPS4060-P-CS	●	6	-	9	50	6	A332
KES2060	□	6	-	9	55	8	A440
KESU2060	□	6	-	9	55	8	A440
EPSMS4060-PN	□	6	-	9	56	6	A311
EPS4060-TH	●	6	-	9	60	6	A328
EPPS4060	●	6	-	9	60	6	A336
EMXR4060-TH	●	6	-	9	60	6	A346
EMXN4060-TH	●	6	-	9	60	6	A347
EPSMLS4060-PN	●	6	-	9	120	5	A316
EPPLS4060	●	6	-	9	120	5	A338
EPQLS4060-CS	□	6	-	9	120	5	A455
TES2060	□	6	-	10	50	6	A440
PESS2060-C	□	6	-	12	50	6	A434
PESS2060	□	6	-	12	50	6	A435
SES3060	□	6	-	12	50	6	A439
SES3060-C	□	6	-	12	50	6	A439
EPQS4060-CS	□	6	-	12	50	6	A455
CEPS6060-TH	●	6	-	12	60	6	A352
CEPH6060	●	6	-	12	60	6	A356
CEPLS6060	●	6	-	12	70	6	A356
AES2060	●	6	-	13	50	6	A386
YS2060-CS	□	6	-	13	50	6	A437
HGOS2060-PN	●	6	-	13	60	6	A304
EPP3060-CS	●	6	-	13	60	6	A308
EPP4060-TH	●	6	-	13	60	6	A328
EPP4060-CS	●	6	-	13	60	6	A332
EPP4060-P-CS	●	6	-	13	60	6	A332
EPP4060	●	6	-	13	60	6	A337
EPAS2060-SD	●	6	-	13	70	6	A380
HES2060-C	●	6	-	15	50	6	A387
HES2060	●	6	-	15	50	6	A390
HES4060-C	●	6	-	15	50	6	A394
HES4060	●	6	-	15	50	6	A396
PESR2060-C	□	6	-	15	50	6	A434
PESR4060-C	□	6	-	15	50	6	A434
PESR2060	□	6	-	15	50	6	A435
PESR4060	□	6	-	15	50	6	A435
YR4060-CS	□	6	-	15			

単位 unit : mm

商品コード Item Code	在庫 Stock	外径 Tool dia.	首下長 Under neck length	刃長 Flute length	全長 Overall length	シャンク径 Shank dia.	ページ Page
EPPL4060-TH	●	6	-	25	70	6	A328
EPPL4060	●	6	-	25	70	6	A338
CEPL6060-TH	●	6	-	25	70	6	A352
CEPL6060	●	6	-	25	70	6	A355
FE706	□	6	-	25	80	6	A440
HESL2060-C	●	6	-	30	65	6	A388
HESL2060	●	6	-	30	65	6	A391
HESL4060-C	●	6	-	30	65	6	A394
HESL4060	●	6	-	30	65	6	A396
EPSFL4060-PN	●	6	-	30	70	6	A310
EPSML4060-PN	●	6	-	30	70	6	A315
EPSWL4060-PN	●	6	-	30	70	6	A362
EPQL4060-CS	●	6	-	30	70	6	A369
GSR2060	□	6	-	30	100	6	A441
GSE4060	□	6	-	30	100	6	A432
GXR2060	□	6	-	30	130	6	A441
GSD4060	□	6	-	30	150	6	A432
GSL2060	□	6	-	80	130	6	A441
EPMS40605-PN	□	6.05	-	15.3	63	8	A313
EPPS4061	□	6.1	-	9.2	60	6	A336
EPMS4061-PN	□	6.1	-	9.2	63	8	A311
HES2061-C	□	6.1	-	15	50	6	A387
HES2061	●	6.1	-	15	50	6	A390
EPMS4061-PN	□	6.1	-	15.3	63	8	A313
EPMS40615-PN	□	6.15	-	15.5	63	8	A313
EPPS4062	□	6.2	-	9.3	60	6	A336
EPMS4062-PN	□	6.2	-	9.3	63	8	A311
HES2062-C	□	6.2	-	15	50	6	A387
HES2062	●	6.2	-	15	50	6	A390
EPMS4062-PN	□	6.2	-	15.5	63	8	A313
EPMS40625-PN	□	6.25	-	15.8	63	8	A313
EPPS4063	□	6.3	-	9.5	60	6	A336
EPMS4063-PN	□	6.3	-	9.5	63	8	A311
HES2063-C	□	6.3	-	15	50	6	A387
HES2063	●	6.3	-	15	50	6	A390
EPMS4063-PN	□	6.3	-	15.8	63	8	A313
EPMS40635-PN	□	6.35	-	16	63	8	A313
ECN080635-HD	◎	6.35	-	18	75	6.35	A382
ECW090635-HD	◎	6.35	-	18	75	6.35	A382
EPPS4064	□	6.4	-	9.6	60	6	A336
EPMS4064-PN	□	6.4	-	9.6	63	8	A311
HES2064-C	□	6.4	-	15	50	6	A387
HES2064	●	6.4	-	15	50	6	A390
EPMS4064-PN	□	6.4	-	16	63	8	A313
EPMS40645-PN	□	6.45	-	16.3	63	8	A313
EPMS4065-19.5-PN	□	6.5	19.5	9.8	63	8	A317
EPMS4065-32.5-PN	□	6.5	32.5	9.8	80	8	A318
EPMS4065-PN	□	6.5	-	9.8	63	8	A311
EPPS4065-TH	●	6.5	-	9.8	70	8	A328
EPPS4065	●	6.5	-	9.8	70	8	A336
PESS2065-C	□	6.5	-	14	50	6	A434
PESS2065	□	6.5	-	14	50	6	A435
HES2065-C	●	6.5	-	15	50	6	A387
HES2065	●	6.5	-	15	50	6	A390
HES4065-C	●	6.5	-	15	50	6	A394
HES4065	●	6.5	-	15	50	6	A396
PESR2065-C	□	6.5	-	15	50	6	A434
PESR4065-C	□	6.5	-	15	50	6	A434
PESR2065	□	6.5	-	15	50	6	A435
PESR4065	□	6.5	-	15	50	6	A435
EPP3065-CS	□	6.5	-	16	70	8	A308
EPP4065	□	6.5	-	16	70	8	A337
EPMS4065-PN	□	6.5	-	16.3	63	8	A314
EPMS4065-PN	□	6.5	-	16.3	63	8	A361
CEPR6065-TH	●	6.5	-	20	75	8	A352
CEPR6065	●	6.5	-	20	75	8	A355
EPMS40655-PN	□	6.55	-	16.5	63	8	A314
EPMS4066-PN	□	6.6	-	9.9	63	8	A311
EPPS4066	□	6.6	-	9.9	70	8	A336

商品コード Item Code	在庫 Stock	外径 Tool dia.	首下長 Under neck length	刃長 Flute length	全長 Overall length	シャンク径 Shank dia.	ページ Page
EPMS4066-PN	□	6.6	-	16.5	63	8	A314
HES2066-C	□	6.6	-	20	60	8	A387
HES2066	●	6.6	-	20	60	8	A390
EPMS40665-PN	□	6.65	-	16.8	63	8	A314
EPMS4067-PN	□	6.7	-	10.1	63	8	A311
EPPS4067	□	6.7	-	10.1	70	8	A336
EPMS4067-PN	□	6.7	-	16.8	63	8	A314
HES2067-C	□	6.7	-	20	60	8	A387
HES2067	●	6.7	-	20	60	8	A390
EPMS40675-PN	□	6.75	-	17	63	8	A314
EPMS4068-PN	□	6.8	-	10.2	63	8	A311
EPPS4068	□	6.8	-	10.2	70	8	A336
EPMS4068-PN	□	6.8	-	17	63	8	A314
HES2068-C	□	6.8	-	20	60	8	A387
HES2068	●	6.8	-	20	60	8	A390
EPMS40685-PN	□	6.85	-	17.3	63	8	A314
EPMS4069-PN	□	6.9	-	10.4	63	8	A311
EPPS4069	□	6.9	-	10.4	70	8	A336
EPMS4069-PN	□	6.9	-	17.3	63	8	A314
HES2069-C	□	6.9	-	20	60	8	A387
HES2069	●	6.9	-	20	60	8	A390
EPMS40695-PN	□	6.95	-	17.5	63	8	A314
HGOS2070-PN	●	7	17	16	70	8	A304
EPMS4070-21-PN	●	7	21	10.5	63	8	A317
EPMS4070-21-PN	●	7	21	10.5	63	8	A363
EPMS4070-35-PN	●	7	35	10.5	80	8	A318
EPMS4070-35-PN	●	7	35	10.5	80	8	A363
EMXR4070-SR-TH	●	7	-	9	90	6	A346
EMXN4070-SR-TH	●	7	-	9	90	6	A347
EPPL4070	●	7	-	9	120	6	A338
EPQLS4070-CS	□	7	-	9	120	6	A455
EPPS4070-P-CS	●	7	-	10.5	60	8	A332
KES2070	□	7	-	10.5	60	10	A440
KESU2070	□	7	-	10.5	60	10	A440
EPMS4070-PN	□	7	-	10.5	63	8	A311
EPPS4070-TH	●	7	-	10.5	70	8	A328
EPPS4070	●	7	-	10.5	70	8	A336
EPMS4070-PN	●	7	-	10.5	120	6	A316
TES2070	□	7	-	12	60	8	A440
PESS2070-C	□	7	-	14	60	8	A434
PESS2070	□	7	-	14	60	8	A435
SES3070-C	□	7	-	14	60	8	A439
YS2070-CS	□	7	-	16	60	8	A437
EPP3070-CS	□	7	-	16	70	8	A308
EPP4070-TH	●	7	-	16	70	8	A328
EPP4070	●	7	-	16	70	8	A337
EPFS4070-PN	●	7	-	17.5	63	8	A310
EPMS4070-PN	●	7	-	17.5	63	8	A314
EPMS4070-PN	●	7	-	17.5	63	8	A361
AES2070	●	7	-	20	60	8	A386
HES2070-C	●	7	-	20	60	8	A387
HES2070	●	7	-	20	60	8	A390
HES4070-C	●	7	-	20	60	8	A394
HES4070	●	7	-	20	60	8	A396
PESR2070-C	□	7	-	20	60	8	A434
PESR4070-C	□	7	-	20	60	8	A434
PESR2070	□	7	-	20	60	8	A435
PESR4070	□	7	-	20	60	8	A435
EPQR4070-CS	●	7	-	20	65	8	A369
EPAS2070-SD	●	7	-	20	70	8	A380
CEPR6070-TH	●	7	-	20	75	8	A352
CEPR6070	●	7	-	20	75	8	A355
EPPM4070	□	7	-	23	75	8	A338
HESM2070-C	●	7	-	25	63	8	A388
HESM2070	●	7	-	25	63	8	A391
HESM4070-C	●	7	-	25	63	8	A394
HESM4070	●	7	-	25	63	8	A396
EPMS4070-PN	●	7	-	28	75	8	A310

商品コード Item Code	在庫 Stock	外径 Tool dia.	首下長 Under neck length	刃長 Flute length	全長 Overall length	シャンク径 Shank dia.	ページ Page
EPMSM4070-PN	●	7	-	28	75	8	A315
EPQM4070-CS	□	7	-	30	80	8	A455
GSE4070	□	7	-	30	100	6	A432
GSD4070	□	7	-	30	150	6	A432
EPSFL4070-PN	●	7	-	35	80	8	A310
EPSML4070-PN	□	7	-	35	80	8	A315
EPSWL4070-PN	□	7	-	35	80	8	A362
EPPL4070	□	7	-	35	90	8	A338
CEPL6070-TH	●	7	-	35	90	8	A352
CEPL6070	●	7	-	35	90	8	A355
GSR2070	□	7	-	35	100	6	A441
GXR2070	□	7	-	35	140	6	A441
EPQL4070-CS	□	7	-	40	80	8	A369
HESL2070-C	●	7	-	40	80	8	A388
HESL2070	●	7	-	40	80	8	A391
HESL4070-C	●	7	-	40	80	8	A394
HESL4070	●	7	-	40	80	8	A396
GSL2070	□	7	-	90	140	6	A441
ES8WB0700LS-ATH	●	7	-	7	90	6	A344
EPMS40705-PN	□	7.05	-	17.8	63	8	A314
EPMS4071-PN	□	7.1	-	10.7	63	8	A311
EPPS4071	□	7.1	-	10.7	70	8	A336
EPMS4071-PN	□	7.1	-	17.8	63	8	A314
HES2071-C	□	7.1	-	20	60	8	A387
HES2071	□	7.1	-	20	60	8	A390
EPMS40715-PN	□	7.15	-	18	63	8	A314
EPMS4072-PN	□	7.2	-	10.8	63	8	A311
EPPS4072	□	7.2	-	10.8	70	8	A336
EPMS4072-PN	□	7.2	-	18	63	8	A314
HES2072-C	□	7.2	-	20	60	8	A387
HES2072	□	7.2	-	20	60	8	A390
EPMS40725-PN	□	7.25	-	18.3	63	8	A314
EPMS4073-PN	□	7.3	-	11	63	8	A311
EPPS4073	□	7.3	-	11	70	8	A336
EPMS4073-PN	□	7.3	-	18.3	63	8	A314
HES2073-C	□	7.3	-	20	60	8	A387
HES2073	□	7.3	-	20	60	8	A390
EPMS40735-PN	□	7.35	-	18.5	63	8	A314
EPMS4074-PN	□	7.4	-	11.1	63	8	A311
EPPS4074	□	7.4	-	11.1	70	8	A336
EPMS4074-PN	□	7.4	-	18.5	63	8	A314
HES2074-C	□	7.4	-	20	60	8	A387
HES2074	□	7.4	-	20	60	8	A390
EPMS40745-PN	□	7.45	-	18.8	63	8	A314
EPMS4075-22.5-PN	□	7.5	22.5	11.3	63	8	A317
EPMS4075-37.5-PN	□	7.5	37.5	11.3	80	8	A318
EPMS4075-PN	□	7.5	-	11.3	63	8	A311
EPPS4075-TH	●	7.5	-	11.3	75	8	A328
E							

外径別寸法早見表

超硬エンドミル・スクエア

φ7.6 ~ φ10.5 Carbide End Mills -Square

単位 unit : mm

商品コード Item Code	在庫 Stock	外径 Tool dia.	首下長 Under neck length	刃長 Flute length	全長 Overall length	シャンク径 Shank dia.	ページ Page
HES2076-C	□	7.6	-	20	60	8	A387
HES2076	□	7.6	-	20	60	8	A390
EPSM40765-PN	□	7.65	-	19.3	63	8	A314
EPSMS4077-PN	□	7.7	-	11.6	63	8	A311
EPPS4077	□	7.7	-	11.6	75	8	A336
EPSM4077-PN	□	7.7	-	19.3	63	8	A314
HES2077-C	□	7.7	-	20	60	8	A387
HES2077	□	7.7	-	20	60	8	A390
EPSM40775-PN	□	7.75	-	19.5	63	8	A314
EPSMS4078-PN	□	7.8	-	11.7	63	8	A311
EPPS4078	□	7.8	-	11.7	75	8	A336
EPSM4078-PN	□	7.8	-	19.5	63	8	A314
HES2078-C	□	7.8	-	20	60	8	A387
HES2078	□	7.8	-	20	60	8	A390
EPSM40785-PN	□	7.85	-	19.8	63	8	A314
EPSMS4079-PN	□	7.9	-	11.9	63	8	A311
EPPS4079	□	7.9	-	11.9	75	8	A336
EPSM4079-PN	□	7.9	-	19.8	63	8	A314
HES2079-C	□	7.9	-	20	60	8	A387
HES2079	□	7.9	-	20	60	8	A390
EPSM40795-PN	□	7.95	-	20	63	8	A314
EPSM4080-24-PN	●	8	24	12	63	8	A317
EPSW4080-24-PN	●	8	24	12	63	8	A363
EMXA3080-24	◎	8	24	12	90	8	A374
ES8WB0800LN-30-ATH	●	8	30	8	75	8	A344
ES8WB0800LN-40-ATH	●	8	40	8	90	8	A344
EPSM4080-40-PN	●	8	40	12	80	8	A318
EPSW4080-40-PN	●	8	40	12	80	8	A363
ES8WB0800LN-50-ATH	●	8	50	8	100	8	A344
ES8WB0800LN-60-ATH	●	8	60	8	110	8	A344
EPSS4080-P-CS	●	8	-	12	60	8	A332
KES2080	□	8	-	12	60	10	A440
KESU2080	□	8	-	12	60	10	A440
EPSMS4080-PN	□	8	-	12	63	8	A311
EPPS4080-TH	●	8	-	12	75	8	A328
EPPS4080	●	8	-	12	75	8	A336
EMXR4080-TH	●	8	-	12	75	8	A346
EMXN4080-TH	●	8	-	12	75	8	A347
EPSMLS4080-PN	●	8	-	12	135	7	A316
EPPLS4080	●	8	-	12	135	7	A338
EPQLS4080-CS	□	8	-	12	135	7	A455
TES2080	□	8	-	14	60	8	A440
PESS2080-C	□	8	-	16	60	8	A434
PESS2080	□	8	-	16	60	8	A435
SES3080	□	8	-	16	60	8	A439
SES3080-C	□	8	-	16	60	8	A439
EPQS4080-CS	□	8	-	16	60	8	A455
CEPH6080	●	8	-	16	75	8	A356
CEPLS6080	●	8	-	16	90	8	A356
YS2080-CS	□	8	-	19	60	8	A437
HGOS2080-PN	●	8	-	19	75	8	A304
EPP3080-CS	●	8	-	19	75	8	A308
EPP4080-TH	●	8	-	19	75	8	A328
EPP4080-CS	●	8	-	19	75	8	A332
EPP4080-P-CS	●	8	-	19	75	8	A332
EPP4080	●	8	-	19	75	8	A337
AES2080	●	8	-	20	60	8	A386
HES2080-C	●	8	-	20	60	8	A387
HES2080	●	8	-	20	60	8	A390
HES4080-C	●	8	-	20	60	8	A394
HES4080	●	8	-	20	60	8	A396
PESR2080-C	□	8	-	20	60	8	A434
PESR4080-C	□	8	-	20	60	8	A434
PESR2080	□	8	-	20	60	8	A435
PESR4080	□	8	-	20	60	8	A435
YR4080-CS	□	8	-	20	60	8	A437
EPSF4080-PN	●	8	-	20	63	8	A310
EPSM4080-PN	●	8	-	20	63	8	A314
EPSW4080-PN	●	8	-	20	63	8	A361

商品コード Item Code	在庫 Stock	外径 Tool dia.	首下長 Under neck length	刃長 Flute length	全長 Overall length	シャンク径 Shank dia.	ページ Page
EPQR4080-CS	●	8	-	20	70	8	A369
HGOS4080-PN	●	8	-	20	75	8	A305
CEPR6080-TH	●	8	-	20	75	8	A352
CEPR6080	●	8	-	20	75	8	A355
CEPU4080	●	8	-	20	75	8	A356
EAP4080-TH	◎	8	-	20	75	8	A371
EAP6080-TH	◎	8	-	20	75	8	A371
EPAS2080-SD	●	8	-	20	75	8	A380
ECH4080-SD	●	8	-	20	75	8	A381
ECX3080-SD	●	8	-	20	75	8	A381
ECN10080-HD	◎	8	-	24	90	8	A382
ECW11080-HD	◎	8	-	24	90	8	A382
EPPM4080-TH	●	8	-	25	75	8	A328
EPPM4080	●	8	-	25	75	8	A338
HESM2080-C	●	8	-	25	75	8	A388
HESM2080	●	8	-	25	75	8	A391
HESM4080-C	●	8	-	25	75	8	A394
HESM4080	●	8	-	25	75	8	A396
FE708	□	8	-	25	80	8	A440
EPQM4080-CS	□	8	-	30	80	8	A455
EPSFM4080-PN	●	8	-	32	80	8	A310
EPSMM4080-PN	●	8	-	32	80	8	A315
EPPL4080-TH	●	8	-	35	90	8	A328
EPPL4080	●	8	-	35	90	8	A338
CEPL6080-TH	●	8	-	35	90	8	A352
CEPL6080	●	8	-	35	90	8	A355
EPSFL4080-PN	●	8	-	40	80	8	A310
EPSML4080-PN	●	8	-	40	80	8	A315
EPSWL4080-PN	●	8	-	40	80	8	A362
EPQL4080-CS	●	8	-	40	80	8	A369
HESL2080-C	●	8	-	40	80	8	A388
HESL2080	●	8	-	40	80	8	A391
HESL4080-C	●	8	-	40	80	8	A394
HESL4080	●	8	-	40	80	8	A396
GSR2080	□	8	-	40	110	8	A441
GSE4080	□	8	-	40	110	8	A432
GXR2080	□	8	-	40	150	8	A441
GSD4080	□	8	-	40	150	8	A432
GSL2080	□	8	-	100	150	8	A441
EPSM40805-PN	□	8.05	-	20.3	74	10	A314
EPSMS4081-PN	□	8.1	-	12.2	74	10	A311
EPPS4081	□	8.1	-	12.2	75	8	A336
HES2081-C	□	8.1	-	20	60	8	A387
HES2081	□	8.1	-	20	60	8	A390
EPSM4081-PN	□	8.1	-	20.3	74	10	A314
EPSM40815-PN	□	8.15	-	20.5	74	10	A314
EPSMS4082-PN	□	8.2	-	12.3	74	10	A311
EPPS4082	□	8.2	-	12.3	75	8	A336
HES2082-C	□	8.2	-	20	60	8	A387
HES2082	□	8.2	-	20	60	8	A390
EPSM4082-PN	□	8.2	-	20.5	74	10	A314
EPSM40825-PN	□	8.25	-	20.8	74	10	A314
EPSMS4083-PN	□	8.3	-	12.5	74	10	A311
EPPS4083	□	8.3	-	12.5	75	8	A336
HES2083-C	□	8.3	-	20	60	8	A387
HES2083	□	8.3	-	20	60	8	A390
EPSM4083-PN	□	8.3	-	20.8	74	10	A314
EPSM40835-PN	□	8.35	-	21	74	10	A314
EPSMS4084-PN	□	8.4	-	12.6	74	10	A311
EPPS4084	□	8.4	-	12.6	75	8	A336
HES2084-C	□	8.4	-	20	60	8	A387
HES2084	□	8.4	-	20	60	8	A390
EPSM4084-PN	□	8.4	-	21	74	10	A314
EPSM40845-PN	□	8.45	-	21.3	74	10	A314
EPSM4085-25.5-PN	□	8.5	25.5	12.8	74	10	A317
EPSM4085-42.5-PN	□	8.5	42.5	12.8	94	10	A318
EPSMS4085-PN	□	8.5	-	12.8	74	10	A311
EPPS4085-TH	●	8.5	-	12.8	80	10	A328
EPPS4085	●	8.5	-	12.8	80	10	A336

商品コード Item Code	在庫 Stock	外径 Tool dia.	首下長 Under neck length	刃長 Flute length	全長 Overall length	シャンク径 Shank dia.	ページ Page
PESS2085-C	□	8.5	-	16	60	8	A434
PESS2085	□	8.5	-	16	60	8	A435
EPP3085-CS	□	8.5	-	19	80	10	A308
EPP4085	□	8.5	-	19	80	10	A337
HES2085-C	●	8.5	-	20	60	8	A387
HES2085	●	8.5	-	20	60	8	A390
HES4085-C	●	8.5	-	20	60	8	A394
HES4085	●	8.5	-	20	60	8	A396
PESR2085-C	□	8.5	-	20	60	8	A434
PESR4085-C	□	8.5	-	20	60	8	A434
PESR2085	□	8.5	-	20	60	8	A435
PESR4085	□	8.5	-	20	60	8	A435
EPSM4085-PN	□	8.5	-	21.3	74	10	A314
EPSW4085-PN	□	8.5	-	21.3	74	10	A361
CEPR6085-TH	●	8.5	-	25	80	10	A352
CEPR6085	●	8.5	-	25	80	10	A355
EPSM40855-PN	□	8.55	-	21.5	74	10	A314
EPSMS4086-PN	□	8.6	-	12.9	74	10	A311
EPPS4086	□	8.6	-	12.9	80	10	A336
HES2086-C	□	8.6	-	20	65	10	A387
HES2086	□	8.6	-	20	65	10	A390
EPSM4086-PN	□	8.6	-	21.5	74	10	A314
EPSM40865-PN	□	8.65	-	21.8	74	10	A314
EPSMS4087-PN	□	8.7	-	13.1	74	10	A311
EPPS4087	□	8.7	-	13.1	80	10	A336
HES2087-C	□	8.7	-	20	65	10	A387
HES2087	□	8.7	-	20	65	10	A390
EPSM4087-PN	□	8.7	-	21.8	74	10	A314
EPSM40875-PN	□	8.75	-	22	74	10	A314
EPSMS4088-PN	□	8.8	-	13.2	74	10	A311
EPPS4088	□	8.8	-	13.2	80	10	A336
HES2088-C	□	8.8	-	20	65	10	A387
HES2088	□	8.8	-	20	65	10	A390
EPSM4088-PN	□	8.8	-	22	74	10	A314
EPSM40885-PN	□	8.85	-	22.3	74	10	A314
EPSMS4089-PN	□	8.9	-	13.4	74	10	A311
EPPS4089	□	8.9	-	13.4	80	10	A336
HES2089-C	□	8.9	-	20	65	10	A387
HES2089	□	8.9	-	20	65	10	A390
EPSM4089-PN	□	8.9	-	22.3	74	10	A314
EPSM40895-PN	□	8.95	-	22.5	74	10	A314
HGOS2090-PN	●	9	20	19	80	10	A304
EPSM4090-27-PN	●	9	27	13.5	74	10	A317
EPSW4090-27-PN	●	9	27	13.5			

単位 unit : mm

商品コード Item Code	在庫 Stock	外径 Tool dia.	首下長 Under neck length	刃長 Flute length	全長 Overall length	シャンク径 Shank dia.	ページ Page
PESR2090-C	□	9	-	20	65	10	A434
PESR4090-C	□	9	-	20	65	10	A434
PESR2090	□	9	-	20	65	10	A435
PESR4090	□	9	-	20	65	10	A435
SES3090	□	9	-	20	65	10	A439
EPAS2090-SD	●	9	-	20	80	10	A380
EPSF4090-PN	●	9	-	22.5	74	10	A310
EPSM4090-PN	●	9	-	22.5	74	10	A314
EPSW4090-PN	●	9	-	22.5	74	10	A361
EPQR4090-CS	●	9	-	25	75	10	A369
CEPR6090-TH	●	9	-	25	80	10	A352
CEPR6090	●	9	-	25	80	10	A355
HESM2090	□	9	-	28	75	10	A391
HESM4090-C	●	9	-	28	75	10	A394
HESM4090	●	9	-	28	75	10	A396
EPPM4090	□	9	-	30	80	10	A338
EPGM4090-CS	□	9	-	35	90	10	A455
EPSFM4090-PN	●	9	-	36	100	10	A310
EPSMM4090-PN	●	9	-	36	100	10	A315
HESL2090-C	●	9	-	40	85	10	A388
HESL2090	●	9	-	40	85	10	A391
HESL4090-C	●	9	-	40	85	10	A394
HESL4090	●	9	-	40	85	10	A396
GSE4090	□	9	-	40	110	8	A432
GSD4090	□	9	-	40	150	8	A432
EPSFL4090-PN	●	9	-	45	100	10	A310
EPSML4090-PN	□	9	-	45	100	10	A315
EPPL4090	□	9	-	45	100	10	A338
CEPL6090-TH	●	9	-	45	100	10	A352
CEPL6090	●	9	-	45	100	10	A355
EPSWL4090-PN	□	9	-	45	100	10	A362
GSR2090	□	9	-	45	110	8	A441
GXR2090	□	9	-	45	160	8	A441
EPQL4090-CS	□	9	-	50	100	10	A369
GSL2090	□	9	-	110	160	8	A441
ES8WB0900LS-ATH	●	9	-	9	100	8	A344
EPSM40905-PN	□	9.05	-	22.8	74	10	A314
EPSMS4091-PN	□	9.1	-	13.7	74	10	A312
EPPS4091	□	9.1	-	13.7	80	10	A336
HES2091-C	□	9.1	-	20	65	10	A387
HES2091	□	9.1	-	20	65	10	A390
EPSM4091-PN	□	9.1	-	22.8	74	10	A314
EPSM40915-PN	□	9.15	-	23	74	10	A314
EPSMS4092-PN	□	9.2	-	13.8	74	10	A312
EPPS4092	□	9.2	-	13.8	80	10	A336
HES2092-C	□	9.2	-	20	65	10	A387
HES2092	□	9.2	-	20	65	10	A390
EPSM4092-PN	□	9.2	-	23	74	10	A314
EPSM40925-PN	□	9.25	-	23.3	74	10	A314
EPSMS4093-PN	□	9.3	-	14	74	10	A312
EPPS4093	□	9.3	-	14	80	10	A336
HES2093-C	□	9.3	-	20	65	10	A387
HES2093	□	9.3	-	20	65	10	A390
EPSM4093-PN	□	9.3	-	23.3	74	10	A314
EPSM40935-PN	□	9.35	-	23.5	74	10	A314
EPSMS4094-PN	□	9.4	-	14.1	74	10	A312
EPPS4094	□	9.4	-	14.1	80	10	A336
HES2094-C	□	9.4	-	20	65	10	A387
HES2094	□	9.4	-	20	65	10	A390
EPSM4094-PN	□	9.4	-	23.5	74	10	A314
EPSM40945-PN	□	9.45	-	23.8	74	10	A314
EPSM4095-28.5-PN	□	9.5	28.5	14.3	74	10	A317
EPSM4095-47.5-PN	□	9.5	47.5	14.3	94	10	A318
EPSMS4095-PN	□	9.5	-	14.3	74	10	A312
EPPS4095-TH	●	9.5	-	14.3	80	10	A328
EPPS4095	●	9.5	-	14.3	80	10	A336
PESS2095-C	□	9.5	-	18	65	10	A434
PESS2095	□	9.5	-	18	65	10	A435
EPP3095-CS	□	9.5	-	19	80	10	A308

商品コード Item Code	在庫 Stock	外径 Tool dia.	首下長 Under neck length	刃長 Flute length	全長 Overall length	シャンク径 Shank dia.	ページ Page
EPP4095	□	9.5	-	19	80	10	A337
HES2095-C	●	9.5	-	20	65	10	A387
HES2095	●	9.5	-	20	65	10	A390
HES4095-C	●	9.5	-	20	65	10	A394
HES4095	●	9.5	-	20	65	10	A396
PESR2095-C	□	9.5	-	20	65	10	A434
PESR4095-C	□	9.5	-	20	65	10	A434
PESR2095	□	9.5	-	20	65	10	A435
PESR4095	□	9.5	-	20	65	10	A435
EPSM4095-PN	□	9.5	-	23.8	74	10	A314
EPSW4095-PN	□	9.5	-	23.8	74	10	A361
CEPR6095-TH	●	9.5	-	25	80	10	A352
CEPR6095	●	9.5	-	25	80	10	A355
EPSM40955-PN	□	9.55	-	24	74	10	A314
EPSMS4096-PN	□	9.6	-	14.4	74	10	A312
EPPS4096	□	9.6	-	14.4	80	10	A336
EPSM4096-PN	□	9.6	-	24	74	10	A314
HES2096-C	□	9.6	-	25	70	10	A387
HES2096	□	9.6	-	25	70	10	A390
EPSM40965-PN	□	9.65	-	24.3	74	10	A314
EPSMS4097-PN	□	9.7	-	14.6	74	10	A312
EPPS4097	□	9.7	-	14.6	80	10	A336
EPSM4097-PN	□	9.7	-	24.3	74	10	A314
HES2097-C	□	9.7	-	25	70	10	A387
HES2097	□	9.7	-	25	70	10	A390
EPSM40975-PN	□	9.75	-	24.5	74	10	A314
EPSMS4098-PN	□	9.8	-	14.7	74	10	A312
EPPS4098	□	9.8	-	14.7	80	10	A336
EPSM4098-PN	□	9.8	-	24.5	74	10	A314
HES2098-C	□	9.8	-	25	70	10	A387
HES2098	□	9.8	-	25	70	10	A390
EPSM40985-PN	□	9.85	-	24.8	74	10	A314
EPSMS4099-PN	□	9.9	-	14.9	74	10	A312
EPPS4099	□	9.9	-	14.9	80	10	A336
EPSM4099-PN	□	9.9	-	24.8	74	10	A314
HES2099-C	□	9.9	-	25	70	10	A387
HES2099	□	9.9	-	25	70	10	A390
EPSM40995-PN	□	9.95	-	25	74	10	A314
EPSM4100-30-PN	●	10	30	15	74	10	A317
EPSW4100-30-PN	●	10	30	15	74	10	A363
EMXA3100-30	◎	10	30	15	100	10	A374
ES8WB1000LN-35-ATH	●	10	35	10	80	10	A344
ES8WB1000LN-50-ATH	●	10	50	10	100	10	A344
EPSM4100-50-PN	●	10	50	15	94	10	A318
EPSW4100-50-PN	●	10	50	15	94	10	A363
ES8WB1000LN-60-ATH	●	10	60	10	110	10	A344
ES8WB1000LN-80-ATH	●	10	80	10	130	10	A344
KESU2100	□	10	-	15	65	12	A440
KESU2100	□	10	-	15	65	12	A440
EPPS4100-P-CS	●	10	-	15	70	10	A332
EPSMS4100-PN	□	10	-	15	74	10	A312
EPPS4100-TH	●	10	-	15	80	10	A328
EPPS4100	●	10	-	15	80	10	A336
EMXR4100-TH	●	10	-	15	80	10	A346
EMXN4100-TH	●	10	-	15	80	10	A347
EPSMLS4100-PN	●	10	-	15	150	9	A316
EPPLS4100	●	10	-	15	150	9	A338
EPQLS4100-CS	□	10	-	15	150	9	A455
PESS2100-C	□	10	-	18	70	10	A434
PESS2100	□	10	-	18	70	10	A435
TES2100	□	10	-	18	70	10	A440
EPQS4100-CS	□	10	-	18	70	10	A455
CEPH6100	●	10	-	20	80	10	A356
CEPLS6100	●	10	-	20	100	10	A356
YS2100-CS	□	10	-	22	70	10	A437
HGOS2100-PN	●	10	-	22	80	10	A304
EPP3100-CS	●	10	-	22	80	10	A308
EPP4100-TH	●	10	-	22	80	10	A328
EPP4100-CS	●	10	-	22	80	10	A332

商品コード Item Code	在庫 Stock	外径 Tool dia.	首下長 Under neck length	刃長 Flute length	全長 Overall length	シャンク径 Shank dia.	ページ Page
EPP4100-P-CS	●	10	-	22	80	10	A332
EPP4100	●	10	-	22	80	10	A337
AES2100	●	10	-	25	70	10	A386
HES2100-C	●	10	-	25	70	10	A387
HES2100	●	10	-	25	70	10	A390
HES4100-C	●	10	-	25	70	10	A394
HES4100	●	10	-	25	70	10	A396
PESR2100-C	□	10	-	25	70	10	A434
PESR4100-C	□	10	-	25	70	10	A434
PESR2100	□	10	-	25	70	10	A435
PESR4100	□	10	-	25	70	10	A435
YR4100-CS	□	10	-	25	70	10	A437
SES3100	□	10	-	25	70	10	A439
SES3100-C	□	10	-	25	70	10	A439
EPSF4100-PN	●	10	-	25	74	10	A310
EPSM4100-PN	●	10	-	25	74	10	A314
EPSW4100-PN	●	10	-	25	74	10	A361
HGOS4100-PN	●	10	-	25	80	10	A305
CEPR6100-TH	●	10	-	25	80	10	A352
CEPR6100	●	10	-	25	80	10	A355
CEPU4100	●	10	-	25	80	10	A356
EPQR4100-CS	●	10	-	25	80	10	A369
EAP4100-TH	◎	10	-	25	80	10	A371
EAP6100-TH	◎	10	-	25	80	10	A371
EPAS2100-SD	◎	10	-	25	80	10	A380
ECH4100-SD	●	10	-	25	100	10	A381
ECX3100-SD	●	10	-	25	100	10	A381
FE710	□	10	-	30	80	10	A440
ECN12100-HD	◎	10	-	30	100	10	A382
ECW13100-HD	◎	10	-	30	100	10	A382
EPPM4100-TH	◎	10	-	33	80	10	A328
EPPM4100	●	10	-	33	80	10	A338
HESM2100-C	●	10	-	33	80	10	A388
HESM2100	●	10	-	33	80	10	A391
HESM4100-C	●	10	-	33	80	10	A394
HESM4100	●	10	-	33	80	10	A396
EPQM4100-CS	□	10	-	35	90	10	A455
EPSFM4100-PN	●	10	-	40	100	10	A310
EPSMM4100-PN	●	10	-	40	100	10	A315
EPPL4100-TH	●	10	-	45	100	10	A328
EPPL4100	●	10	-	45	100	10	A338
CEPL6100-TH	◎	10	-	45	100	10	A352
CEPL6100	●	10	-	45	100	10	A355
HESL2100-C	●	10	-	50	95	10	A388
HESL2100	●	10	-				

外径別寸法早見表

超硬エンドミル・スクエア

φ10.5 ~ φ16 Carbide End Mills -Square

単位 unit : mm

商品コード Item Code	在庫 Stock	外径 Tool dia.	首下長 Under neck length	刃長 Flute length	全長 Overall length	シャンク径 Shank dia.	ページ Page
EPSM4105-52.5-PN	□	10.5	52.5	15.8	110	12	A318
EPSMS4105-PN	□	10.5	-	15.8	86	12	A312
EPSP4105	□	10.5	-	15.8	100	12	A336
PESS2105	□	10.5	-	22	70	10	A435
HES2105-C	●	10.5	-	25	70	10	A387
HES2105	●	10.5	-	25	70	10	A390
HES4105	□	10.5	-	25	70	10	A396
PESR2105	□	10.5	-	25	70	10	A435
PESR4105	□	10.5	-	25	70	10	A435
EPSM4105-PN	□	10.5	-	26.3	86	12	A314
EPSP4105-PN	□	10.5	-	26.3	86	12	A361
CEPR6105-TH	●	10.5	-	30	100	12	A352
CEPR6105	●	10.5	-	30	100	12	A355
EPSMS4106-PN	□	10.6	-	15.9	86	12	A312
HES2106	□	10.6	-	25	75	12	A390
EPSM4106-PN	□	10.6	-	26.5	86	12	A314
EPSMS4107-PN	□	10.7	-	16.1	86	12	A312
HES2107	□	10.7	-	25	75	12	A390
EPSM4107-PN	□	10.7	-	26.8	86	12	A314
EPSMS4108-PN	□	10.8	-	16.2	86	12	A312
HES2108	□	10.8	-	25	75	12	A390
EPSM4108-PN	□	10.8	-	27	86	12	A314
EPSMS4109-PN	□	10.9	-	16.4	86	12	A312
HES2109	□	10.9	-	25	75	12	A390
EPSM4109-PN	□	10.9	-	27.3	86	12	A314
EPSM4110-33-PN	●	11	33	16.5	86	12	A317
EPSP4110-33-PN	●	11	33	16.5	86	12	A363
EPSM4110-55-PN	●	11	55	16.5	110	12	A318
EPSP4110-55-PN	●	11	55	16.5	110	12	A363
EMXR4110-SR-TH	●	11	-	15	110	10	A346
EMXN4110-SR-TH	●	11	-	15	110	10	A347
EPPLS4110	●	11	-	15	150	10	A338
EPQLS4110-CS	□	11	-	15	150	10	A455
KES2110	□	11	-	16.5	65	12	A440
KESU2110	□	11	-	16.5	65	12	A440
EPSP4110-P-CS	●	11	-	16.5	75	12	A332
EPSMS4110-PN	□	11	-	16.5	86	12	A312
EPSP4110	□	11	-	16.5	100	12	A336
EPSMLS4110-PN	●	11	-	16.5	150	10	A316
TES2110	□	11	-	20	75	12	A440
PESS2110-C	□	11	-	22	75	12	A434
PESS2110	□	11	-	22	75	12	A435
EPP3110-CS	□	11	-	22	100	12	A308
EPP4110-TH	●	11	-	22	100	12	A328
EPP4110	●	11	-	22	100	12	A337
AES2110	●	11	-	25	75	12	A386
HES2110-C	●	11	-	25	75	12	A387
HES2110	●	11	-	25	75	12	A390
HES4110-C	●	11	-	25	75	12	A394
HES4110	●	11	-	25	75	12	A396
PESR2110-C	□	11	-	25	75	12	A434
PESR4110-C	□	11	-	25	75	12	A434
PESR2110	□	11	-	25	75	12	A435
PESR4110	□	11	-	25	75	12	A435
SES3110	□	11	-	25	75	12	A439
EPAS2110-SD	●	11	-	25	100	12	A380
EPSF4110-PN	●	11	-	27.5	86	12	A310
EPSM4110-PN	●	11	-	27.5	86	12	A314
EPSP4110-PN	●	11	-	27.5	86	12	A361
EPQR4110-CS	●	11	-	30	85	12	A369
CEPR6110-TH	●	11	-	30	100	12	A352
CEPR6110	●	11	-	30	100	12	A355
HESM2110	□	11	-	33	90	12	A391
HESM4110	□	11	-	33	90	12	A396
EPPM4110	□	11	-	33	100	12	A338
EPSPM4110-PN	●	11	-	44	120	12	A310
EPSPMM4110-PN	●	11	-	44	120	12	A315
EPQM4110-CS	□	11	-	45	110	12	A455
HESL2110	□	11	-	50	95	12	A391

商品コード Item Code	在庫 Stock	外径 Tool dia.	首下長 Under neck length	刃長 Flute length	全長 Overall length	シャンク径 Shank dia.	ページ Page
HESL4110	□	11	-	50	100	12	A396
GSR2110	□	11	-	50	120	10	A441
GSE4110	□	11	-	50	120	10	A432
GXR2110	□	11	-	50	170	10	A441
GSD4110	□	11	-	50	180	10	A432
EPSFL4110-PN	●	11	-	55	120	12	A310
EPSML4110-PN	□	11	-	55	120	12	A315
EPPL4110	□	11	-	55	120	12	A338
CEPL6110-TH	●	11	-	55	120	12	A352
CEPL6110	●	11	-	55	120	12	A355
EPSP4110-PN	□	11	-	55	120	12	A362
EPQL4110-CS	□	11	-	60	120	12	A369
GSL2110	□	11	-	120	170	10	A441
ES8WB1100LS-ATH	●	11	-	11	110	10	A344
EPSMS4111-PN	□	11.1	-	16.7	86	12	A312
HES2111	□	11.1	-	25	75	12	A390
EPSM4111-PN	□	11.1	-	27.8	86	12	A314
EPSMS4112-PN	□	11.2	-	16.8	86	12	A312
HES2112	□	11.2	-	25	75	12	A390
EPSM4112-PN	□	11.2	-	28	86	12	A314
EPSMS4113-PN	□	11.3	-	17	86	12	A312
HES2113	□	11.3	-	25	75	12	A390
EPSM4113-PN	□	11.3	-	28.3	86	12	A314
EPSMS4114-PN	□	11.4	-	17.1	86	12	A312
HES2114	□	11.4	-	25	75	12	A390
EPSM4114-PN	□	11.4	-	28.5	86	12	A314
EPSM4115-34.5-PN	□	11.5	34.5	17.3	86	12	A317
EPSM4115-57.5-PN	□	11.5	57.5	17.3	110	12	A318
EPSMS4115-PN	□	11.5	-	17.3	86	12	A312
EPPS4115	□	11.5	-	17.3	100	12	A336
PESS2115	□	11.5	-	22	75	12	A435
HES2115	□	11.5	-	25	75	12	A390
HES4115	□	11.5	-	25	75	12	A396
PESR2115	□	11.5	-	25	75	12	A435
PESR4115	□	11.5	-	25	75	12	A435
EPSM4115-PN	□	11.5	-	28.8	86	12	A314
EPSP4115-PN	□	11.5	-	28.8	86	12	A361
CEPR6115-TH	●	11.5	-	30	100	12	A352
CEPR6115	●	11.5	-	30	100	12	A355
EPSMS4116-PN	□	11.6	-	17.4	86	12	A312
HES2116	□	11.6	-	25	75	12	A390
EPSM4116-PN	□	11.6	-	29	86	12	A314
EPSMS4117-PN	□	11.7	-	17.6	86	12	A312
HES2117	□	11.7	-	25	75	12	A390
EPSM4117-PN	□	11.7	-	29.3	86	12	A314
EPSMS4118-PN	□	11.8	-	17.7	86	12	A312
HES2118	□	11.8	-	25	75	12	A390
EPSM4118-PN	□	11.8	-	29.5	86	12	A314
EPSMS4119-PN	□	11.9	-	17.9	86	12	A312
HES2119	□	11.9	-	25	75	12	A390
EPSM4119-PN	□	11.9	-	29.8	86	12	A314
EPSM4120-36-PN	●	12	36	18	86	12	A317
EPSP4120-36-PN	●	12	36	18	86	12	A363
EMXA3120-36	◎	12	36	18	120	12	A374
ES8WB1200LN-40-ATH	●	12	40	12	90	12	A344
ES8WB1200LN-60-ATH	●	12	60	12	110	12	A344
EPSM4120-60-PN	●	12	60	18	110	12	A318
EPSP4120-60-PN	●	12	60	18	110	12	A363
ES8WB1200LN-80-ATH	●	12	80	12	130	12	A344
ES8WB1200LN-100-ATH	●	12	100	12	150	12	A344
EHX12-EPP4120-TH	●	12	-	9.6	19	-	A399
EHX12-CEPR6120-TH	●	12	-	12	19	-	A398
KES2120	□	12	-	18	65	12	A440
KESU2120	□	12	-	18	65	12	A440
EPPS4120-P-CS	●	12	-	18	75	12	A332
EPSMS4120-PN	□	12	-	18	86	12	A312
EPPS4120-TH	●	12	-	18	100	12	A328
EPPS4120	●	12	-	18	100	12	A337
EMXR4120-TH	●	12	-	18	100	12	A346

商品コード Item Code	在庫 Stock	外径 Tool dia.	首下長 Under neck length	刃長 Flute length	全長 Overall length	シャンク径 Shank dia.	ページ Page
EMXN4120-TH	●	12	-	18	100	12	A347
EPSMLS4120-PN	□	12	-	18	160	11	A316
EPPLS4120	●	12	-	18	160	11	A338
EPQLS4120-CS	□	12	-	18	160	11	A455
PESS2120-C	□	12	-	22	75	12	A434
PESS2120	□	12	-	22	75	12	A435
TES2120	□	12	-	22	75	12	A440
EPQS4120-CS	□	12	-	22	75	12	A455
CEPH6120	●	12	-	24	100	12	A356
CEPLS6120-10	●	12	-	24	120	10	A356
CEPLS6120	●	12	-	24	120	12	A356
AES2120	●	12	-	25	75	12	A386
HES2120-C	●	12	-	25	75	12	A387
HES2120	●	12	-	25	75	12	A390
HES4120-C	●	12	-	25	75	12	A394
HES4120	●	12	-	25	75	12	A396
PESR2120-C	□	12	-	25	75	12	A434
PESR4120-C	□	12	-	25	75	12	A434
PESR2120	□	12	-	25	75	12	A435
PESR4120	□	12	-	25	75	12	A435
SES3120	□	12	-	25	75	12	A439
SES3120-C	□	12	-	25	75	12	A439
EPAS2120-SD	●	12	-	25	100	12	A380
YS2120-CS	□	12	-	26	75	12	A437
HGOS2120-PN	□	12	-	26	100	12	A304
EPP3120-CS	●	12	-	26	100	12	A308
EPP4120-TH	●	12	-	26	100	12	A328
EPP4120-CS	●	12	-	26	100	12	A332
EPP4120-P-CS	●	12	-	26	100	12	A332
EPP4120	●	12	-	26	100	12	A337
YR4120-CS	□	12	-	30	75	12	A437
FE712	□	12	-	30	80	12	A440
EPSF4120-PN	●	12	-	30	86	12	A310
EPSM4120-PN	●	12	-	30	86	12	A314
EPSP4120-PN	●	12	-	30	86	12	A361
EPQR4120-CS	●	12	-	30	90	12	A369
HGOS4120-PN	●	12	-	30	100	12	A305
CEPR6120-TH	●	12	-	30	100	12	A352
CEPR6120	●	12	-	30	100	12	A355

単位 unit : mm

商品コード Item Code	在庫 Stock	外径 Tool dia.	首下長 Under neck length	刃長 Flute length	全長 Overall length	シャンク径 Shank dia.	ページ Page
EPSWL4120-PN	●	12	-	60	120	12	A362
EPQL4120-CS	●	12	-	60	120	12	A369
GSL2120	□	12	-	130	190	12	A441
EPPS4125	□	12.5	-	18.8	100	12	A337
EPSMS4125-PN	□	12.5	-	18.8	100	16	A312
EPSM4125-PN	□	12.5	-	31.3	105	16	A314
EPSM4130-39-PN	□	13	39	19.5	105	16	A317
EPSM4130-65-PN	□	13	65	19.5	125	16	A318
EMXR4130-SR-TH	●	13	-	18	120	12	A346
EMXN4130-SR-TH	●	13	-	18	120	12	A347
EPPLS4130	●	13	-	18	160	12	A338
EPQLS4130-CS	□	13	-	18	160	12	A455
KES2130	□	13	-	19.5	70	16	A440
KESU2130	□	13	-	19.5	70	16	A440
EPPS4130	□	13	-	19.5	100	12	A337
EPSMS4130-PN	□	13	-	19.5	100	16	A312
EPSMLS4130-PN	●	13	-	19.5	160	12	A316
PESS2130-C	□	13	-	22	75	12	A434
PESS2130	□	13	-	22	75	12	A435
AES2130	●	13	-	25	75	12	A386
HES2130-C	●	13	-	25	75	12	A387
HES2130	●	13	-	25	75	12	A390
HES4130-C	●	13	-	25	75	12	A394
HES4130	●	13	-	25	75	12	A396
PESR2130-C	□	13	-	25	75	12	A434
PESR4130-C	□	13	-	25	75	12	A434
SES3130	□	13	-	25	75	12	A439
EPP3130-CS	□	13	-	26	100	12	A308
EPP4130-TH	●	13	-	26	100	12	A328
EPP4130	●	13	-	26	100	12	A337
EPSM4130-PN	□	13	-	32.5	105	16	A314
EPSW4130-PN	□	13	-	32.5	105	16	A361
EPQR4130-CS	□	13	-	35	100	16	A369
CEPR6130-TH	●	13	-	35	105	16	A352
CEPR6130	●	13	-	35	105	16	A355
HESM2130	□	13	-	37	100	12	A391
HESM4130-C	□	13	-	37	100	12	A394
HESM4130	□	13	-	37	100	12	A396
EPPM4130	□	13	-	43	100	12	A338
HESL2130	□	13	-	50	100	12	A391
HESL4130-C	□	13	-	50	100	12	A394
HESL4130	□	13	-	50	100	12	A396
EPQM4130-CS	□	13	-	50	120	16	A455
EPPL4130	□	13	-	55	120	12	A338
CEPL6130	□	13	-	55	125	16	A355
GSR2130	□	13	-	55	130	12	A441
GSE4130	□	13	-	55	130	12	A432
GXR2130	□	13	-	55	190	12	A441
GSD4130	□	13	-	55	200	12	A432
EPSML4130-PN	□	13	-	65	130	16	A315
EPSWL4130-PN	□	13	-	65	130	16	A362
EPQL4130-CS	□	13	-	70	130	16	A369
GSL2130	□	13	-	130	190	12	A441
EPPS4135	□	13.5	-	20.3	100	12	A337
EPSMS4135-PN	□	13.5	-	20.3	100	16	A312
EPSM4135-PN	□	13.5	-	33.8	105	16	A314
EPSM4140-42-PN	□	14	42	21	105	16	A317
EPSM4140-70-PN	□	14	70	21	125	16	A318
EPPLS4140	□	14	-	18	160	13	A455
EPQLS4140-CS	□	14	-	18	160	13	A455
KES2140	□	14	-	21	70	16	A440
KESU2140	□	14	-	21	70	16	A440
EPPS4140	□	14	-	21	100	12	A337
EPSMS4140-PN	□	14	-	21	100	16	A312
EPP3140-CS	□	14	-	26	110	16	A308
EPP4140-TH	●	14	-	26	110	16	A328
EPP4140	●	14	-	26	110	16	A337
PESS2140-C	□	14	-	27	90	16	A434
PESS2140	□	14	-	27	90	16	A435

商品コード Item Code	在庫 Stock	外径 Tool dia.	首下長 Under neck length	刃長 Flute length	全長 Overall length	シャンク径 Shank dia.	ページ Page
FE714	□	14	-	35	80	14	A440
AES2140	●	14	-	35	90	12	A386
HES2140-C	●	14	-	35	90	16	A387
HES2140	●	14	-	35	90	16	A390
HES4140-C	●	14	-	35	90	16	A394
HES4140	●	14	-	35	90	16	A396
PESR2140-C	□	14	-	35	90	16	A434
PESR4140-C	□	14	-	35	90	16	A434
SES3140	□	14	-	35	90	16	A439
SES3140-C	□	14	-	35	90	16	A439
EPQR4140-CS	□	14	-	35	100	16	A369
EPSM4140-PN	□	14	-	35	105	16	A314
CEPR6140-TH	●	14	-	35	105	16	A352
CEPR6140	●	14	-	35	105	16	A355
EPSW4140-PN	□	14	-	35	105	16	A361
HESM2140-C	□	14	-	42	100	16	A388
HESM2140	□	14	-	42	100	16	A391
HESM4140-C	□	14	-	42	100	16	A394
HESM4140	□	14	-	42	100	16	A396
EPPM4140	□	14	-	43	110	16	A338
EPQM4140-CS	□	14	-	50	120	16	A455
EPPL4140	□	14	-	55	125	16	A338
CEPL6140-TH	●	14	-	55	125	16	A352
CEPL6140	●	14	-	55	125	16	A355
GSR4140	□	14	-	60	140	12	A441
GXR4140	□	14	-	60	210	12	A441
HESL2140-C	□	14	-	70	125	16	A388
HESL2140	□	14	-	70	125	16	A391
HESL4140-C	□	14	-	70	125	16	A394
HESL4140	□	14	-	70	125	16	A396
EPSML4140-PN	□	14	-	70	130	16	A315
EPSWL4140-PN	□	14	-	70	130	16	A362
EPQL4140-CS	□	14	-	70	130	16	A369
GSL4140	□	14	-	140	210	12	A441
EPSMS4145-PN	□	14.5	-	21.8	100	16	A312
EPPS4145	□	14.5	-	21.8	110	16	A337
EPSM4145-PN	□	14.5	-	36.3	110	16	A314
EPSM4150-45-PN	□	15	45	22.5	110	16	A317
EPSM4150-75-PN	□	15	75	22.5	135	16	A318
EPPLS4150	□	15	-	22	180	14	A338
EPQLS4150-CS	□	15	-	22	180	14	A455
KES2150	□	15	-	22.5	70	16	A440
KESU2150	□	15	-	22.5	70	16	A440
EPSMS4150-PN	□	15	-	22.5	100	16	A312
EPPS4150	□	15	-	22.5	110	16	A337
EPP3150-CS	□	15	-	26	110	16	A308
EPP4150-TH	●	15	-	26	110	16	A328
EPP4150	●	15	-	26	110	16	A337
PESS2150-C	□	15	-	27	90	16	A434
PESS2150	□	15	-	27	90	16	A435
AES2150	●	15	-	35	90	16	A386
HES2150-C	●	15	-	35	90	16	A387
HES2150	●	15	-	35	90	16	A390
HES4150-C	●	15	-	35	90	16	A394
HES4150	●	15	-	35	90	16	A396
PESR2150-C	□	15	-	35	90	16	A434
PESR4150-C	□	15	-	35	90	16	A434
SES3150	□	15	-	35	90	16	A439
SES3150-C	□	15	-	35	90	16	A439
EPQR4150-CS	□	15	-	35	100	16	A369
EPSM4150-PN	□	15	-	37.5	110	16	A314
EPSW4150-PN	□	15	-	37.5	110	16	A361
CEPR6150-TH	●	15	-	40	110	16	A352
CEPR6150	●	15	-	40	110	16	A355
HESM2150-C	□	15	-	42	110	16	A388
HESM2150	□	15	-	42	110	16	A391
HESM4150-C	□	15	-	42	110	16	A394
HESM4150	□	15	-	42	110	16	A396
EPPM4150	□	15	-	47	110	16	A338

商品コード Item Code	在庫 Stock	外径 Tool dia.	首下長 Under neck length	刃長 Flute length	全長 Overall length	シャンク径 Shank dia.	ページ Page
EPQM4150-CS	□	15	-	50	120	16	A455
GSR4150	□	15	-	60	140	12	A441
GXR4150	□	15	-	60	210	12	A441
EPPL4150	□	15	-	65	135	16	A338
CEPL6150	●	15	-	65	135	16	A355
HESL2150-C	□	15	-	70	125	16	A388
HESL2150	□	15	-	70	125	16	A391
HESL4150-C	□	15	-	70	125	16	A394
HESL4150	□	15	-	70	125	16	A396
EPQL4150-CS	□	15	-	70	130	16	A369
EPSML4150-PN	□	15	-	75	130	16	A315
EPSWL4150-PN	□	15	-	75	130	16	A362
GSL4150	□	15	-	140	210	12	A441
EPSMS4155-PN	□	15.5	-	23.3	100	16	A312
EPPS4155	□	15.5	-	23.3	110	16	A337
EPSM4155-PN	□	15.5	-	38.8	110	16	A314
EMXA3160-45	◎	16	45	19	90	16	A374
EPSM4160-48-PN	●	16	48	24	110	16	A317
EPSW4160-48-PN	●	16	48	24	110	16	A363
EPSM4160-80-PN	●	16	80	24	135	16	A318
EPSW4160-80-PN	●	16	80	24	135	16	A363
EHX16-EPP4160-TH	●	16	-	12.8	24	-	A399
EHX16-CEPR6160-TH	●	16	-	16	24	-	A398
KES2160	□	16	-	24	70	16	A440
KESU2160	□	16	-	24	70	16	A440
EPSMS4160-PN	□	16	-	24	100	16	A312
EPPS4160-TH	●	16	-	24	110	16	A328
EPPS4160	●	16	-	24	110	16	A337
EMXR4160-TH	●	16	-	24	110	16	A346
EMXN4160-TH	●	16	-	24	110	16	A347
EPSMLS4160-PN	●	16	-	24	180	15	A316
EPPLS4160	●	16	-	24	180	15	A338
EPQLS4160-CS	□	16	-	24	180	15	A455
PESS2160-C	□	16	-	27	90	16	A434
PESS2160	□	16	-	27	90	16	A435
EPQS4160-CS	□	16	-	27	90	16	A455
EPP3160-CS	●	16	-	32	110	16	A308
EPP4160-TH	●	16	-	32	110	16	A328
EPP4160-CS	●	16	-	32	110	16	A332
EPP4160-P-CS	●	16	-	32	110	16	A332
EPP4160	●	16	-	32	110	16	A337
CEPH6160	□	16	-	32	110	16	A356
CEPLS6160-12	●	16	-	32	135	12	A356
CEPLS6160	●	16	-	32	135	16	A356
AES216							

外径別寸法早見表

超硬エンドミル・スクエア

φ16 ~ φ32 Carbide End Mills -Square

単位 unit : mm

商品コード Item Code	在庫 Stock	外径 Tool dia.	首下長 Under neck length	刃長 Flute length	全長 Overall length	シャンク径 Shank dia.	ページ Page
HESM2160	●	16	-	47	110	16	A391
HESM4160-C	●	16	-	47	110	16	A394
HESM4160	●	16	-	47	110	16	A396
EPQM4160-CS	□	16	-	55	125	16	A455
GSE4160	□	16	-	60	150	16	A432
GSD4160	□	16	-	60	250	16	A432
EPSMM4160-PN	●	16	-	64	135	16	A315
EPPL4160-TH	●	16	-	65	135	16	A328
EPPL4160	●	16	-	65	135	16	A338
CEPL6160-TH	●	16	-	65	135	16	A352
CEPL6160	●	16	-	65	135	16	A355
GSR4160	□	16	-	65	150	16	A441
GXR4160	□	16	-	65	230	16	A441
HESL2160-C	●	16	-	70	125	16	A388
HESL2160	●	16	-	70	125	16	A391
HESL4160-C	●	16	-	70	125	16	A394
HESL4160	●	16	-	70	125	16	A396
EPQL4160-CS	●	16	-	75	135	16	A369
EPSML4160-PN	●	16	-	80	135	16	A315
EPSWL4160-PN	●	16	-	80	135	16	A362
GSL4160	□	16	-	150	230	16	A441
EPSMS4165-PN	□	16.5	-	24.8	110	20	A312
EPSM4165-PN	□	16.5	-	41.3	120	20	A314
EPSM4170-51-PN	□	17	51	25.5	120	20	A317
EPSM4170-85-PN	□	17	85	25.5	145	20	A318
EPPLS4170	●	17	-	24	180	16	A338
EPQLS4170-CS	□	17	-	24	180	16	A455
EPPS4170	□	17	-	25.5	110	16	A337
EPSMS4170-PN	□	17	-	25.5	110	20	A312
EPSMLS4170-PN	●	17	-	25.5	180	16	A316
PESS2170	□	17	-	30	90	16	A435
EPP3170-CS	□	17	-	32	110	16	A308
EPP4170-TH	●	17	-	32	110	16	A328
EPP4170	●	17	-	32	110	16	A337
HES2170-C	□	17	-	35	90	16	A387
HES2170	□	17	-	35	90	16	A390
HES4170	□	17	-	35	90	16	A396
EPQR4170-CS	□	17	-	40	110	20	A369
CEPR6170-TH	●	17	-	40	120	20	A352
CEPR6170	●	17	-	40	120	20	A355
EPSM4170-PN	□	17	-	42.5	120	20	A314
EPSW4170-PN	□	17	-	42.5	120	20	A361
EPPM4170	□	17	-	47	110	16	A338
HESM2170	□	17	-	47	110	16	A391
HESM4170	□	17	-	47	110	16	A396
EPQM4170-CS	□	17	-	55	125	20	A455
EPPL4170	□	17	-	65	145	20	A338
CEPL6170	□	17	-	65	145	20	A355
GSR4170	□	17	-	65	150	16	A441
GXR4170	□	17	-	65	230	16	A441
HESL2170	□	17	-	70	135	16	A391
HESL4170	□	17	-	70	135	16	A396
EPQL4170-CS	□	17	-	75	135	20	A369
EPSML4170-PN	□	17	-	85	135	20	A315
EPSWL4170-PN	□	17	-	85	135	20	A362
GSL4170	□	17	-	150	230	16	A441
EPSMS4175-PN	□	17.5	-	26.3	110	20	A312
EPSM4175-PN	□	17.5	-	43.8	120	20	A314
EPSM4180-54-PN	□	18	54	27	120	20	A317
EPSM4180-90-PN	□	18	90	27	145	20	A318
EPPS4180	□	18	-	27	110	16	A337
EPSMS4180-PN	□	18	-	27	110	20	A312
EPPLS4180	□	18	-	27	180	16	A338
EPQLS4180-CS	□	18	-	27	180	16	A455
PESS2180-C	□	18	-	30	105	20	A434
PESS2180	□	18	-	30	105	20	A435
EPP3180-CS	□	18	-	32	125	20	A308
EPP4180-TH	●	18	-	32	125	20	A328
EPP4180	●	18	-	32	125	20	A337

商品コード Item Code	在庫 Stock	外径 Tool dia.	首下長 Under neck length	刃長 Flute length	全長 Overall length	シャンク径 Shank dia.	ページ Page
CEPLS6180	●	18	-	36	145	16	A356
AES2180	●	18	-	40	105	16	A386
HES2180-C	●	18	-	40	105	20	A387
HES2180	●	18	-	40	105	20	A390
HES4180-C	●	18	-	40	105	20	A394
HES4180	●	18	-	40	105	20	A396
PESR2180-C	□	18	-	40	105	20	A434
PESR4180-C	□	18	-	40	105	20	A434
SES3180	□	18	-	40	105	20	A439
FE718	□	18	-	40	110	18	A440
CEPR6180-TH	●	18	-	40	120	20	A352
CEPR6180	●	18	-	40	120	20	A355
EPSM4180-PN	□	18	-	45	120	20	A314
EPSW4180-PN	□	18	-	45	120	20	A361
EPQR4180-CS	□	18	-	45	120	20	A369
HESM2180-C	□	18	-	50	120	20	A388
HESM2180	□	18	-	50	120	20	A391
HESM4180-C	□	18	-	50	120	20	A394
HESM4180	□	18	-	50	120	20	A396
EPPM4180	□	18	-	55	125	20	A338
EPQM4180-CS	□	18	-	65	135	20	A455
EPPL4180	□	18	-	65	145	20	A338
CEPL6180-TH	●	18	-	65	145	20	A352
CEPL6180	●	18	-	65	145	20	A355
GSR4180	□	18	-	65	160	16	A441
GXR4180	□	18	-	65	250	16	A441
HESL2180-C	□	18	-	75	135	20	A388
HESL2180	□	18	-	75	135	20	A391
HESL4180-C	□	18	-	75	135	20	A394
HESL4180	□	18	-	75	135	20	A396
EPQL4180-CS	□	18	-	80	145	20	A369
EPSML4180-PN	□	18	-	90	145	20	A315
EPSWL4180-PN	□	18	-	90	145	20	A362
GSL4180	□	18	-	160	250	16	A441
EPSMS4185-PN	□	18.5	-	27.8	110	20	A312
EPSM4185-PN	□	18.5	-	46.3	125	20	A314
EPSM4190-57-PN	□	19	57	28.5	125	20	A317
EPSM4190-95-PN	□	19	95	28.5	155	20	A318
EPSMS4190-PN	□	19	-	28.5	110	20	A312
EPPS4190	□	19	-	28.5	125	20	A337
PESS2190	□	19	-	30	105	20	A435
EPQLS4190-CS	□	19	-	30	200	18	A455
EPP3190-CS	□	19	-	32	125	20	A308
EPP4190-TH	●	19	-	32	125	20	A328
EPP4190	●	19	-	32	125	20	A337
HES2190-C	□	19	-	40	105	20	A387
HES2190	□	19	-	40	105	20	A390
HES4190	□	19	-	40	105	20	A396
EPQR4190-CS	□	19	-	45	120	20	A369
CEPR6190-TH	●	19	-	45	125	20	A352
CEPR6190	●	19	-	45	125	20	A355
EPSM4190-PN	□	19	-	47.5	125	20	A314
EPSW4190-PN	□	19	-	47.5	125	20	A361
HESM2190	□	19	-	50	120	20	A391
HESM4190-C	□	19	-	50	120	20	A394
HESM4190	□	19	-	50	120	20	A396
EPPM4190	□	19	-	55	125	20	A338
EPQM4190-CS	□	19	-	65	135	20	A455
HESL2190	□	19	-	75	140	20	A391
HESL4190	□	19	-	75	140	20	A396
EPPL4190	□	19	-	75	155	20	A338
CEPL6190	□	19	-	75	155	20	A355
EPQL4190-CS	□	19	-	80	145	20	A369
EPSML4190-PN	□	19	-	95	145	20	A315
EPSWL4190-PN	□	19	-	95	145	20	A362
EPSMS4195-PN	□	19.5	-	29.3	110	20	A312
EPSM4195-PN	□	19.5	-	48.8	125	20	A314
EPSM4200-60-PN	●	20	60	30	125	20	A317

商品コード Item Code	在庫 Stock	外径 Tool dia.	首下長 Under neck length	刃長 Flute length	全長 Overall length	シャンク径 Shank dia.	ページ Page
EPSW4200-60-PN	●	20	60	30	125	20	A363
EPSM4200-100-PN	●	20	100	30	155	20	A318
EPSW4200-100-PN	●	20	100	30	155	20	A363
EHX20-EPP4200-TH	●	20	-	16	30	-	A399
EHX20-CEPR6200-TH	●	20	-	20	30	-	A398
EPSMS4200-PN	□	20	-	30	110	20	A312
EPPS4200-TH	●	20	-	30	125	20	A328
EPPS4200	●	20	-	30	125	20	A337
EMXR4200-TH	●	20	-	30	125	20	A346
EMXN4200-TH	●	20	-	30	125	20	A347
EPQLS4200-CS	□	20	-	30	200	18	A455
EPPLS4200	□	20	-	30	200	20	A338
EPQS4200-CS	□	20	-	35	100	20	A455
PESS2200-C	□	20	-	35	105	20	A434
PESS2200	□	20	-	35	105	20	A435
EPP3200-CS	●	20	-	38	125	20	A308
EPP4200-TH	●	20	-	38	125	20	A328
EPP4200-CS	●	20	-	38	125	20	A332
EPP4200-P-CS	●	20	-	38	125	20	A332
EPP4200	●	20	-	38	125	20	A337
AES2200	●	20	-	40	105	20	A386
HES2200-C	●	20	-	40	105	20	A387
HES2200	●	20	-	40	105	20	A390
HES4200-C	●	20	-	40	105	20	A394
HES4200	●	20	-	40	105	20	A396
PESR2200-C	□	20	-	40	105	20	A434
PESR4200-C	□	20	-	40	105	20	A434
YR4200-CS	□	20	-	40	105	20	A437
YS2200-CS	□	20	-	40	105	20	A437
FE720	□	20	-	40	110	20	A440
HGOS2200-PN	●	20	-	40	125	20	A304
HGOS4200-PN	●	20	-	40	125	20	A305
CEPH6200	●	20	-	40	125	20	A356
CEPLS6200-16	●	20	-	40	155	16	A356
CEPLS6200	●	20	-	40	155	20	A356
SES3200	□	20	-	45	110	20	A439
SES3200-C	□	20	-	45	110	20	A439
CEPR6200-TH	●	20	-	45	125	20	A352
CEPR6200	●	20	-	45	125	20	A355
CEPU4200	●	20	-	45	125	20	A356
EAP4200-TH	○	20	-	45	125	20	A371
EAP6200-TH	○	20	-	45	125	20	A371

単位 unit : mm







商品コード Item Code	在庫 Stock	外径 Tool dia.	首下長 Under neck length	刃長 Flute length	全長 Overall length	シャンク径 Shank dia.	ページ Page
EPPS4210	<input type="checkbox"/>	21	-	31.5	125	20	A337
EPP3210-CS	<input type="checkbox"/>	21	-	38	125	20	A308
EPP4210	<input type="checkbox"/>	21	-	38	125	20	A337
HES2210	<input type="checkbox"/>	21	-	40	105	20	A390
HES4210	<input type="checkbox"/>	21	-	40	105	20	A396
HESM2210	<input type="checkbox"/>	21	-	55	130	20	A391
HESM4210	<input type="checkbox"/>	21	-	55	130	20	A396
GSE4210	<input type="checkbox"/>	21	-	60	150	20	A432
GSD4210	<input type="checkbox"/>	21	-	60	250	20	A432
HESL2210	<input type="checkbox"/>	21	-	75	140	20	A391
EPPS4220	<input type="checkbox"/>	22	-	33	125	20	A337
EPP3220-CS	<input type="checkbox"/>	22	-	38	125	20	A308
EPP4220	<input type="checkbox"/>	22	-	38	125	20	A337
HES2220-C	<input checked="" type="checkbox"/>	22	-	45	115	20	A387
HES2220	<input checked="" type="checkbox"/>	22	-	45	115	20	A390
HES4220	<input type="checkbox"/>	22	-	45	115	20	A396
CEPR6220-TH	<input checked="" type="checkbox"/>	22	-	45	135	20	A352
CEPR6220	<input checked="" type="checkbox"/>	22	-	45	135	20	A355
CEPLS6220	<input checked="" type="checkbox"/>	22	-	45	165	20	A356
HESM2220	<input type="checkbox"/>	22	-	60	130	20	A391
HESM4220	<input type="checkbox"/>	22	-	60	130	20	A396
CEPL6220-TH	<input checked="" type="checkbox"/>	22	-	75	165	20	A352
CEPL6220	<input checked="" type="checkbox"/>	22	-	75	165	20	A355
HESL2220	<input type="checkbox"/>	22	-	80	150	20	A391
EPPS4230	<input type="checkbox"/>	23	-	34.5	130	25	A337
HES2230	<input type="checkbox"/>	23	-	45	115	20	A390
HES4230	<input type="checkbox"/>	23	-	45	115	20	A396
EPP3230-CS	<input type="checkbox"/>	23	-	45	140	25	A308
EPP4230	<input type="checkbox"/>	23	-	45	140	25	A337
HESM2230	<input type="checkbox"/>	23	-	60	130	20	A391
HESM4230	<input type="checkbox"/>	23	-	60	130	20	A396
HESL2230	<input type="checkbox"/>	23	-	80	150	20	A391
EPPS4240	<input type="checkbox"/>	24	-	36	130	25	A337
EPP3240-CS	<input type="checkbox"/>	24	-	45	140	25	A308
EPP4240	<input type="checkbox"/>	24	-	45	140	25	A337
HES2240	<input type="checkbox"/>	24	-	50	120	20	A390
HES4240	<input type="checkbox"/>	24	-	50	120	20	A396
CEPR6240-TH	<input checked="" type="checkbox"/>	24	-	50	140	25	A352
CEPR6240	<input checked="" type="checkbox"/>	24	-	50	140	25	A355
HESM2240	<input type="checkbox"/>	24	-	65	140	20	A391
HESM4240	<input type="checkbox"/>	24	-	65	140	20	A396
HESL2240	<input type="checkbox"/>	24	-	80	150	20	A391
CEPL6240	<input type="checkbox"/>	24	-	90	180	25	A355
EPPS4250	<input type="checkbox"/>	25	-	37.5	130	25	A337
CEPLS8250-20	<input checked="" type="checkbox"/>	25	-	45	180	20	A356
CEPLS8250	<input checked="" type="checkbox"/>	25	-	45	180	25	A356
HES2250-C	<input checked="" type="checkbox"/>	25	-	50	120	25	A387
HES2250	<input checked="" type="checkbox"/>	25	-	50	120	25	A390
HES4250-C	<input checked="" type="checkbox"/>	25	-	50	120	25	A394
HES4250	<input checked="" type="checkbox"/>	25	-	50	120	25	A396
SES4250	<input type="checkbox"/>	25	-	50	120	25	A439
CEPR8250-TH	<input checked="" type="checkbox"/>	25	-	50	140	25	A352
CEPR8250	<input checked="" type="checkbox"/>	25	-	50	140	25	A355
GSE4250	<input type="checkbox"/>	25	-	60	180	25	A432
GSD4250	<input type="checkbox"/>	25	-	60	250	25	A432
EPP3250-CS	<input type="checkbox"/>	25	-	63	140	25	A308
EPP4250	<input type="checkbox"/>	25	-	63	140	25	A337
HESM2250-C	<input type="checkbox"/>	25	-	65	140	25	A388
HESM2250	<input type="checkbox"/>	25	-	65	140	25	A391
HESM4250-C	<input type="checkbox"/>	25	-	65	140	25	A394
HESM4250	<input type="checkbox"/>	25	-	65	140	25	A396
HESL2250-C	<input type="checkbox"/>	25	-	80	150	25	A388
HESL2250	<input type="checkbox"/>	25	-	80	150	25	A391
HESL4250-C	<input type="checkbox"/>	25	-	80	150	25	A394
HESL4250	<input type="checkbox"/>	25	-	80	150	25	A396
CEPL8250-TH	<input checked="" type="checkbox"/>	25	-	90	180	25	A352
CEPL8250	<input checked="" type="checkbox"/>	25	-	90	180	25	A355
HES2260	<input type="checkbox"/>	26	-	50	120	25	A390
HES4260	<input type="checkbox"/>	26	-	50	120	25	A396

商品コード Item Code	在庫 Stock	外径 Tool dia.	首下長 Under neck length	刃長 Flute length	全長 Overall length	シャンク径 Shank dia.	ページ Page
CEPR8260-TH	<input checked="" type="checkbox"/>	26	-	50	140	25	A352
CEPR8260	<input checked="" type="checkbox"/>	26	-	50	140	25	A355
HESM2260	<input type="checkbox"/>	26	-	65	140	25	A391
HESM4260	<input type="checkbox"/>	26	-	65	140	25	A396
CEPL8260	<input type="checkbox"/>	26	-	90	180	25	A355
HES2270	<input type="checkbox"/>	27	-	55	130	25	A390
HES4270	<input type="checkbox"/>	27	-	55	130	25	A396
HESM2270	<input type="checkbox"/>	27	-	70	145	25	A391
HESM4270	<input type="checkbox"/>	27	-	70	145	25	A396
CEPLS8280	<input type="checkbox"/>	28	-	50	180	25	A356
HES2280	<input type="checkbox"/>	28	-	55	130	25	A390
HES4280	<input type="checkbox"/>	28	-	55	130	25	A396
CEPR8280-TH	<input checked="" type="checkbox"/>	28	-	55	145	25	A352
CEPR8280	<input checked="" type="checkbox"/>	28	-	55	145	25	A355
HESM2280	<input type="checkbox"/>	28	-	70	145	25	A391
HESM4280	<input type="checkbox"/>	28	-	70	145	25	A396
CEPL8280	<input checked="" type="checkbox"/>	28	-	90	180	25	A355
HES2290	<input type="checkbox"/>	29	-	55	130	25	A390
HES4290	<input type="checkbox"/>	29	-	55	130	25	A396
HESM2290	<input type="checkbox"/>	29	-	70	145	25	A391
HESM4290	<input type="checkbox"/>	29	-	70	145	25	A396
CEPLS8300	<input type="checkbox"/>	30	-	50	195	25	A356
HES2300-C	<input type="checkbox"/>	30	-	55	130	32	A387
HES2300	<input type="checkbox"/>	30	-	55	130	32	A390
HES4300-C	<input type="checkbox"/>	30	-	55	130	32	A394
HES4300	<input type="checkbox"/>	30	-	55	130	32	A396
SES4300	<input type="checkbox"/>	30	-	55	130	32	A439
CEPR8300-TH	<input checked="" type="checkbox"/>	30	-	60	165	32	A352
CEPR8300	<input checked="" type="checkbox"/>	30	-	60	165	32	A355
GSE4300	<input type="checkbox"/>	30	-	60	200	32	A432
GSD4300	<input type="checkbox"/>	30	-	60	250	32	A432
HESM2300	<input type="checkbox"/>	30	-	70	145	32	A391
HESM4300-C	<input type="checkbox"/>	30	-	70	145	32	A394
HESM4300	<input type="checkbox"/>	30	-	70	145	32	A396
CEPL8300	<input checked="" type="checkbox"/>	30	-	90	195	32	A355
CEPLS8320-25	<input type="checkbox"/>	32	-	55	195	25	A356
CEPLS8320	<input type="checkbox"/>	32	-	55	195	32	A356
CEPR8320-TH	<input checked="" type="checkbox"/>	32	-	70	175	32	A352
CEPR8320	<input checked="" type="checkbox"/>	32	-	70	175	32	A355
CEPL8320	<input type="checkbox"/>	32	-	95	195	32	A355

印：特定代理店在庫です。弊社営業へお問合せください。 ：Stocked by specified distributor. Contact with our sales department.

ディープシリーズラインナップ

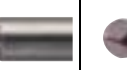
超硬コーティング加工用ドリル

刃形 Geometry	ボール Ball nose								コーナラジウス Corner radius									
	EPDBEH-TH3		EPDBE		EPDBPE		EPDB-SD		EGDB-HD		CBN-EHB		CBN-EPSSB		EPDREH-TH3			
アイテム Items																		
Page 掲載頁	A56		A72		A84		A140		A143		A147		A151		A172			
エポック エボリューションハード -TH3 Epoch Deep Ball Evolution Hard-TH3	エポック ディープボール エボリューション Epoch Deep Ball Evolution		エポックペンシル ディープボール エボリューション Epoch Pencil Deep Ball Evolution		エポック SD(S-DLC) ディープボール Epoch SD(S-DLC) Deep Ball		エポック HDコーティング ディープボール Epoch HD Coating Deep Ball		エポック CBN ハイプレジジョン ボールエンドミル Epoch CBN High Precision Ball End Mill		エポック CBN スーパーボール エンドミル Epoch CBN Super Ball End Mill		エポックディープラジウス エボリューションハード -TH3 Epoch Deep Radius Evolution Hard-TH3					
首形状 Neck shape	ストレート Straight		ストレート Straight		ペンシル Pencil		ストレート Straight		ストレート Straight		ストレート Straight		ストレート Straight					
首角度 Neck angle	-		-		0.4°, 0.9°, 1.4°, 2.9°, 4.9°		-		-		-		-					
コーティング Coating	TH3		PN, RTH		RTH		SD		HD		-		TH3					
アイテム数 No. of items	331		164, 164		261		26		19		37		40		53, 266			
工具径 Tool dia.	φ0.1 ~ 12		φ0.1 ~ 6		φ0.2 ~ 12		φ0.2 ~ 5		φ0.4 ~ 3		φ0.2 ~ 2		φ0.2 ~ 2		φ0.2~1, φ1~6			
コーナ R Corner Radius	-		-		-		-		-		-		-		RE0.02~0.2, RE0.02~1			
刃 数 No. of flutes	2		2		2		2		2		2		2		2, 4			
バックドラフト Backdraft	○		-		○		-		-		-		-		○, -			
RE精度 (mm) RE accuracy	±0.003(RE≤0.25) ±0.005(0.25<RE)		±0.003(RE≤0.25) ±0.005(0.25<RE)		±0.003(RE≤0.25) ±0.005(0.25<RE≤3) ±0.01 (3<RE)		±0.003(RE≤0.25) ±0.005(0.25<RE)		-		±0.003(RE≤0.3) ±0.005(0.3<RE)		±0.005		±0.005 (中心基準) (Central axis)			
シャンク径公差 Tolerance on shank	h4 (φ4) h5 (φ6~φ12)		h5		h5		h5		h5		h4		h4		h4, h5 (φ4) h5 (φ6)			
用途 Application	荒加工 Roughing		中仕上げ加工 Semi-finishing		仕上げ加工 Finishing		-		-		-		-		-			
被削材 Work material	炭素鋼・合金鋼 Carbon steels, Alloy steels		プリハードン鋼 45HRC以下 or less		高硬度材 45~55HRC		高硬度材 55~65HRC		高硬度材 65HRC超 more than		ステンレス鋼 Stainless steels		チタン合金・耐熱合金 Ti alloy, Heat-resistant alloy		銅合金 Copper alloy		アルミ合金 Aluminium alloy	
最大深さ対応 Maximum depth capability	10DC 20DC 30DC 40DC 50DC 60DC 70DC 80DC 90DC		10DC 20DC 30DC 40DC 50DC 60DC 70DC 80DC 90DC		10DC 20DC 30DC 40DC 50DC 60DC 70DC 80DC 90DC		10DC 20DC 30DC 40DC 50DC 60DC 70DC 80DC 90DC		10DC 20DC 30DC 40DC 50DC 60DC 70DC 80DC 90DC		10DC 20DC 30DC 40DC 50DC 60DC 70DC 80DC 90DC		10DC 20DC 30DC 40DC 50DC 60DC 70DC 80DC 90DC		10DC 20DC 30DC 40DC 50DC 60DC 70DC 80DC 90DC			
	20DC		20DC		90DC		12DC		40DC		10DC		10DC		8DC			

コーナラジアス Corner radius							スクエア Square		
EPDRE エポック ディーブラジアス エボリューション Epoch Deep Radius Evolution	EPDRF エポック ディーブラジアス F Epoch Deep Radius F	ETR エポック ターボリブ Epoch Turbo Rib	ETRP エポック ターボリブ (ペンシルネック) Epoch Turbo Rib (Pencil neck)	EGDR-HD エポック HDコーティング ディーブラジアス Epoch HD Coating Deep Radius	CBN-EPDR エポックCBN スーパーラジアス エンドミル Epoch CBN Super Radius End Mill	EPDRP エポック ペンシルディーブ ラジアス Epoch Pencil Deep Radius	EPDSE エポック ディーブスクエア エボリューション Epoch Deep Square Evolution	EPDS-SD エポック SD(S-DLC) ディーブスクエア Epoch SD(S-DLC) Deep Square	
A194	A216	A222	A223	A277	A281	A210	A292	A378	
ストレート Straight	ストレート Straight	ストレート Straight	ペンシル Pencil	ストレート Straight	ストレート Straight	ペンシル Pencil	ストレート Straight	ストレート Straight	
-	-	-	0.9°	-	-	0.4°, 0.9°	-	-	
					-				
332	127	44	49	16	46	57	145	145	24
φ0.2 ~ 6	φ1 ~ 6	φ1 ~ 3	φ1 ~ 3	φ0.5 ~ 3	φ0.2 ~ 3	φ0.2 ~ 3	φ0.1 ~ 6	φ0.5 ~ 4	
RE0.02~1	RE0.05~1	RE0.2~0.8	-	RE0.1~0.2	-	RE0.05~0.5	-	-	
2	4	4	4	2	2	2	2	2	
○	○	-	-	○	-	○	-	-	
±0.005 (中心基準) (Central axis)	±0.005 (中心基準) (Central axis)	±0.01	±0.01	-	±0.005 (中心基準) (Central axis)	±0.005	-	-	
h5	h5	h5	h5	h5	h4	h5	h5	h5	
○	○	○	○	グラファイト・FRP 高シリコンニッケル合金 for Graphite, FRP, High Si aluminum alloy, etc	○	○	○	○	○
○	○	○	○		○	○	○	○	○
○	○	○	○		○	○	○	○	○
○	○	○	○		○	○	○	○	○
○	○	○	○		○	○	○	○	○
○	○	○	○		○	○	○	○	○
○	○	○	○		○	○	○	○	○
○	○	○	○		○	○	○	○	○
○	○	○	○		○	○	○	○	○
○	○	○	○		○	○	○	○	○
20DC	15DC	30DC	50DC	40DC	10DC	35DC	27DC	12DC	



ショートシャクタイプ Short shank type

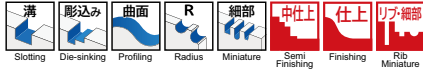

新開発した次世代ハードコーティングTH3を採用!
 高硬度鋼の加工において優れた耐摩耗性を発揮
 Applies newly developed next-generation hard coating "TH3".
 Excellent wear resistance when machining hardened steel.

RE公差 RE tolerance
 RE ≤ 0.25 : ±0.003
 0.25 < RE : ±0.005
 h4



外径実測値付き Includes actual measured mill diameter value.

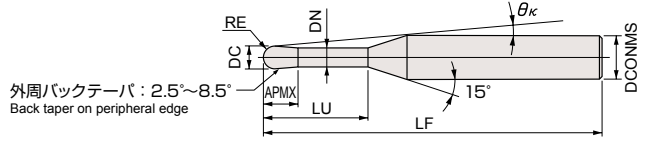

Aタイプ A type

EPDBEH2○○○F-○○○-TH3



商品コード Item code	在庫 Stock	寸法 Size(mm)							タイプ Type	干渉角度 Interference angle (°) θκ	勾配角に対する実有効首下長 Effective under neck length with respect to draft angle					希望小売価格 (円) Suggested retail price (¥)
		ボール半径 Ball radius RE	外径 Tool dia. DC	首下長 Under neck length LU	刃長 Flute length APMX	首径 Neck dia. DN	全長 Overall length LF	シャク径 Shank dia. DCONMS			0.5°	1°	1.5°	2°	3°	
EPDBEH2001F-0.08-TH3	●	0.05	0.1	0.08	0.08	-	35	4	B	20.93	-	-	-	-	16,290	
EPDBEH2001F-0.2-TH3	●			0.2	0.08	0.08	35	4	A	14.64	0.24	0.25	0.25	0.26	0.28	16,290
EPDBEH2001F-0.3-TH3	●			0.3	0.08	0.08	35	4	A	14.46	0.34	0.35	0.36	0.38	0.40	16,720
EPDBEH2001F-0.5-TH3	●			0.5	0.08	0.08	35	4	A	14.10	0.55	0.57	0.59	0.61	0.65	18,110
EPDBEH20015F-0.12-TH3	●	0.075	0.15	0.12	0.12	-	35	4	B	15.25	-	-	-	-	16,720	
EPDBEH20015F-0.3-TH3	●			0.3	0.12	0.13	35	4	A	14.50	0.34	0.35	0.36	0.37	0.40	16,720
EPDBEH20015F-0.5-TH3	●			0.5	0.12	0.13	35	4	A	14.14	0.55	0.56	0.58	0.60	0.65	18,110
EPDBEH20015F-0.75-TH3	●			0.75	0.12	0.13	35	4	A	13.71	0.81	0.83	0.86	0.89	0.96	19,710
EPDBEH2002F-0.15-TH3	●	0.1	0.2	0.15	0.15	-	35	4	B	20.23	-	-	-	-	11,680	
EPDBEH2002F-0.3-TH3	●			0.3	0.15	0.18	35	4	A	14.54	0.34	0.35	0.36	0.37	0.39	11,680
EPDBEH2002F-0.5-TH3	●			0.5	0.15	0.18	35	4	A	14.17	0.55	0.56	0.58	0.60	0.64	11,680
EPDBEH2002F-0.75-TH3	●			0.75	0.15	0.18	35	4	A	13.73	0.81	0.83	0.86	0.89	0.95	11,680
EPDBEH2002F-1-TH3	●			1	0.15	0.18	38	4	A	13.32	1.06	1.10	1.13	1.17	1.26	11,680
EPDBEH2003F-0.25-TH3	●	0.15	0.3	0.25	0.25	-	35	4	B	14.45	-	-	-	-	11,470	
EPDBEH2003F-0.5-TH3	●			0.5	0.25	0.27	35	4	A	14.21	0.56	0.58	0.60	0.61	0.65	11,470
EPDBEH2003F-0.75-TH3	●			0.75	0.25	0.27	35	4	A	13.76	0.82	0.85	0.87	0.90	0.96	11,470
EPDBEH2003F-1-TH3	●			1	0.25	0.27	35	4	A	13.33	1.08	1.11	1.15	1.19	1.27	11,470
EPDBEH2003F-1.5-TH3	●			1.5	0.25	0.27	38	4	A	12.56	1.60	1.65	1.70	1.76	1.89	12,220
EPDBEH2004F-0.3-TH3	●	0.2	0.4	0.3	0.3	-	35	4	B	14.53	-	-	-	-	7,810	
EPDBEH2004F-0.5-TH3	●			0.5	0.3	0.37	35	4	A	14.28	0.56	0.58	0.59	0.60	0.64	7,810
EPDBEH2004F-0.75-TH3	●			0.75	0.3	0.37	35	4	A	13.81	0.82	0.84	0.87	0.89	0.95	7,810
EPDBEH2004F-1-TH3	●			1	0.3	0.37	35	4	A	13.37	1.08	1.11	1.14	1.18	1.26	7,810
EPDBEH2004F-1.5-TH3	●			1.5	0.3	0.37	38	4	A	12.57	1.60	1.65	1.70	1.75	1.88	7,940
EPDBEH2004F-2-TH3	●			2	0.3	0.37	38	4	A	11.86	2.11	2.18	2.25	2.33	2.50	8,230
EPDBEH2004F-2.5-TH3	●			2.5	0.3	0.37	38	4	A	11.23	2.63	2.72	2.81	2.90	3.13	8,500
EPDBEH2004F-3-TH3	●			3	0.3	0.37	38	4	A	10.65	3.15	3.25	3.36	3.48	3.75	9,060
EPDBEH2004F-4-TH3	●	4	0.3	0.37	38	4	A	9.67	4.18	4.32	4.47	4.63	4.99	9,760		
EPDBEH2005F-0.35-TH3	●	0.25	0.5	0.35	0.35	-	35	4	B	14.10	-	-	-	-	7,810	
EPDBEH2005F-0.75-TH3	●			0.75	0.35	0.47	35	4	A	13.88	0.82	0.84	0.86	0.88	0.94	7,810
EPDBEH2005F-1-TH3	●			1	0.35	0.47	35	4	A	13.42	1.08	1.11	1.14	1.17	1.25	7,810
EPDBEH2005F-1.5-TH3	●			1.5	0.35	0.47	38	4	A	12.59	1.59	1.64	1.69	1.75	1.87	7,810
EPDBEH2005F-2-TH3	●			2	0.35	0.47	38	4	A	11.86	2.11	2.18	2.25	2.32	2.49	7,810
EPDBEH2005F-2.5-TH3	●			2.5	0.35	0.47	38	4	A	11.21	2.63	2.71	2.80	2.90	3.11	7,810
EPDBEH2005F-3-TH3	●			3	0.35	0.47	38	4	A	10.62	3.15	3.25	3.36	3.47	3.73	7,810
EPDBEH2005F-4-TH3	●			4	0.35	0.47	38	4	A	9.61	4.18	4.32	4.46	4.62	4.98	7,810
EPDBEH2005F-5-TH3	●	5	0.35	0.47	42	4	A	8.78	5.21	5.39	5.57	5.77	6.22	7,940		
EPDBEH2006F-0.4-TH3	●	0.3	0.6	0.4	0.4	-	35	4	B	14.16	-	-	-	-	6,740	
EPDBEH2006F-0.75-TH3	●			0.75	0.4	0.57	35	4	A	13.94	0.82	0.84	0.86	0.88	0.93	6,740
EPDBEH2006F-1-TH3	●			1	0.4	0.57	35	4	A	13.47	1.08	1.10	1.13	1.17	1.24	6,740
EPDBEH2006F-1.5-TH3	●			1.5	0.4	0.57	35	4	A	12.61	1.59	1.64	1.69	1.74	1.86	6,000
EPDBEH2006F-2-TH3	●			2	0.4	0.57	38	4	A	11.86	2.11	2.17	2.24	2.31	2.48	6,000
EPDBEH2006F-2.5-TH3	●			2.5	0.4	0.57	38	4	A	11.19	2.63	2.71	2.80	2.89	3.10	6,140
EPDBEH2006F-3-TH3	●			3	0.4	0.57	38	4	A	10.59	3.14	3.24	3.35	3.46	3.72	6,140
EPDBEH2006F-3.5-TH3	●			3.5	0.4	0.57	38	4	A	10.05	3.66	3.78	3.90	4.04	4.34	6,410
EPDBEH2006F-4-TH3	●			4	0.4	0.57	38	4	A	9.56	4.18	4.31	4.46	4.61	4.97	6,410
EPDBEH2006F-5-TH3	●			5	0.4	0.57	42	4	A	8.71	5.21	5.38	5.57	5.76	6.21	6,410
EPDBEH2006F-6-TH3	●	6	0.4	0.57	42	4	A	8.00	6.24	6.45	6.67	6.91	7.45	6,410		

● : 標準在庫品です。● : Stocked items.

超硬エンドミル
ボールエンドミル

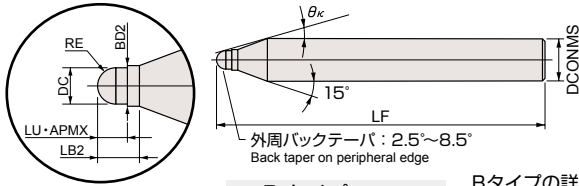

B タイプ B type

Bタイプの詳細はA63をご確認ください
For details of B type, refer to page A63.

EPDBEH2007F-0.45-TH3

商品コード Item code	在庫 Stock	寸法 Size(mm)							タイプ Type	干渉角度 Interference angle (°)	勾配角に対する実有効首下長 Effective under neck length with respect to draft angle					希望小売 価格(円) Suggested retail price (¥)
		ボール半径 Ball radius	外径 Tool dia.	首下長 Under neck length	刃長 Flute length	首径 Neck dia.	全長 Overall length	シャンク径 Shank dia.								
		RE	DC	LU	APMX	DN	LF	DCONMS			θκ	0.5°	1°	1.5°	2°	
EPDBEH2007F-0.45-TH3	●	0.35	0.7	0.45	0.45	—	35	4	B	14.13	—	—	—	—	—	6,000
EPDBEH2007F-2-TH3	●			2	0.45	0.67	38	4	A	11.85	2.11	2.17	2.24	2.31	2.47	6,000
EPDBEH2007F-4-TH3	●			4	0.45	0.67	38	4	A	9.50	4.18	4.31	4.45	4.61	4.95	6,410
EPDBEH2008F-0.5-TH3	●	0.4	0.8	0.5	0.5	—	35	4	B	14.20	—	—	—	—	—	6,000
EPDBEH2008F-1-TH3	●			1	0.5	0.77	35	4	A	13.58	1.07	1.10	1.12	1.15	1.21	6,000
EPDBEH2008F-1.5-TH3	●			1.5	0.5	0.77	35	4	A	12.66	1.59	1.63	1.68	1.73	1.83	6,000
EPDBEH2008F-2-TH3	●			2	0.5	0.77	38	4	A	11.85	2.11	2.17	2.23	2.30	2.46	6,000
EPDBEH2008F-2.5-TH3	●			2.5	0.5	0.77	38	4	A	11.14	2.62	2.70	2.79	2.88	3.08	6,220
EPDBEH2008F-3-TH3	●			3	0.5	0.77	38	4	A	10.51	3.14	3.24	3.34	3.45	3.70	6,410
EPDBEH2008F-4-TH3	●			4	0.5	0.77	38	4	A	9.44	4.17	4.31	4.45	4.60	4.94	6,410
EPDBEH2008F-5-TH3	●			5	0.5	0.77	42	4	A	8.57	5.21	5.38	5.56	5.75	6.19	6,410
EPDBEH2008F-6-TH3	●			6	0.5	0.77	42	4	A	7.84	6.24	6.45	6.66	6.90	7.43	6,410
EPDBEH2008F-8-TH3	●			8	0.5	0.77	42	4	A	6.70	8.31	8.58	8.88	9.20	9.92	6,410
EPDBEH2009F-0.6-TH3	●	0.45	0.9	0.6	0.6	—	35	4	B	13.84	—	—	—	—	—	6,000
EPDBEH2009F-2-TH3	●			2	0.6	0.87	35	4	A	11.85	2.11	2.16	2.23	2.29	2.44	6,000
EPDBEH2009F-4-TH3	●			4	0.6	0.87	38	4	A	9.38	4.17	4.30	4.44	4.59	4.93	6,410
EPDBEH2009F-6-TH3	●			6	0.6	0.87	42	4	A	7.75	6.24	6.44	6.66	6.89	7.42	6,410
EPDBEH2010F-0.8-TH3	●	0.5	1	0.8	0.8	—	35	4	B	13.47	—	—	—	—	—	5,020
EPDBEH2010F-1.5-TH3	●			1.5	0.8	0.96	35	4	A	12.67	1.61	1.64	1.69	1.73	1.83	5,020
EPDBEH2010F-2-TH3	●			2	0.8	0.96	35	4	A	11.82	2.12	2.18	2.24	2.31	2.46	5,020
EPDBEH2010F-2.5-TH3	●			2.5	0.8	0.96	38	4	A	11.07	2.64	2.71	2.80	2.88	3.08	5,020
EPDBEH2010F-3-TH3	●			3	0.8	0.96	38	4	A	10.41	3.16	3.25	3.35	3.46	3.70	5,020
EPDBEH2010F-4-TH3	●			4	0.8	0.96	38	4	A	9.29	4.19	4.32	4.46	4.61	4.94	5,720
EPDBEH2010F-5-TH3	●			5	0.8	0.96	38	4	A	8.39	5.22	5.39	5.57	5.76	6.19	5,720
EPDBEH2010F-6-TH3	●			6	0.8	0.96	42	4	A	7.65	6.26	6.46	6.67	6.91	7.43	6,140
EPDBEH2010F-7-TH3	●			7	0.8	0.96	42	4	A	7.03	7.29	7.53	7.78	8.06	8.67	6,140
EPDBEH2010F-8-TH3	●			8	0.8	0.96	42	4	A	6.50	8.32	8.60	8.89	9.21	9.91	6,140
EPDBEH2010F-10-TH3	●			10	0.8	0.96	45	4	A	5.65	10.39	10.74	11.11	11.51	12.40	6,140
EPDBEH2010F-12-TH3	●			12	0.8	0.96	45	4	A	5.00	12.46	12.88	13.32	13.81	14.89	6,140
EPDBEH2015F-2-TH3	●	0.75	1.5	2	1.35	1.45	35	4	A	11.76	2.13	2.18	2.23	2.29	2.42	5,850
EPDBEH2015F-2.5-TH3	●			2.5	1.35	1.45	35	4	A	10.88	2.65	2.72	2.79	2.87	3.04	5,850
EPDBEH2015F-3-TH3	●			3	1.35	1.45	35	4	A	10.12	3.17	3.25	3.34	3.44	3.66	5,850
EPDBEH2015F-4-TH3	●			4	1.35	1.45	38	4	A	8.88	4.20	4.32	4.45	4.59	4.91	5,850
EPDBEH2015F-5-TH3	●			5	1.35	1.45	38	4	A	7.90	5.23	5.39	5.56	5.74	6.15	5,850
EPDBEH2015F-6-TH3	●			6	1.35	1.45	38	4	A	7.12	6.27	6.46	6.67	6.89	7.39	5,850
EPDBEH2015F-8-TH3	●			8	1.35	1.45	42	4	A	5.95	8.34	8.60	8.88	9.19	9.88	6,140
EPDBEH2015F-10-TH3	●			10	1.35	1.45	42	4	A	5.10	10.40	10.74	11.10	11.49	12.36	6,690
EPDBEH2015F-12-TH3	●			12	1.35	1.45	45	4	A	4.47	12.47	12.88	13.32	13.79	14.85	7,250
EPDBEH2020F-2.5-TH3	●			1	2	2.5	1.7	1.94	35	4	A	10.60	2.66	2.72	2.78	2.85
EPDBEH2020F-3-TH3	●	3	1.7			1.94	35	4	A	9.72	3.18	3.25	3.34	3.43	3.63	5,020
EPDBEH2020F-4-TH3	●	4	1.7			1.94	35	4	A	8.32	4.21	4.32	4.45	4.58	4.87	5,020
EPDBEH2020F-5-TH3	●	5	1.7			1.94	38	4	A	7.27	5.25	5.39	5.55	5.73	6.11	5,720
EPDBEH2020F-6-TH3	●	6	1.7			1.94	38	4	A	6.46	6.28	6.46	6.66	6.88	7.36	5,720
EPDBEH2020F-8-TH3	●	8	1.7			1.94	42	4	A	5.27	8.35	8.60	8.88	9.18	9.84	6,140
EPDBEH2020F-10-TH3	●	10	1.7			1.94	42	4	A	4.46	10.41	10.74	11.10	11.48	12.33	6,140
EPDBEH2020F-12-TH3	●	12	1.7			1.94	45	4	A	3.86	12.48	12.88	13.31	13.77	14.82	6,140
EPDBEH2020F-13-TH3	●	13	1.7			1.94	45	4	A	3.62	13.51	13.95	14.42	14.92	16.06	6,140
EPDBEH2020F-14-TH3	●	14	1.7			1.94	45	4	A	3.40	14.55	15.02	15.53	16.07	17.30	6,140
EPDBEH2020F-16-TH3	●	16	1.7			1.94	50	4	A	3.04	16.62	17.16	17.75	18.37	19.79	6,140
EPDBEH2020F-20-TH3	●	20	1.7			1.94	55	4	A	2.51	20.75	21.44	22.18	22.97	干渉なし	6,140
EPDBEH2025F-6-TH3	●	1.25	2.5	6	2	2.4	38	4	A	5.54	6.35	6.53	6.72	6.92	7.39	7,720
EPDBEH2025F-10-TH3	●			10	2	2.4	42	4	A	3.66	10.48	10.81	11.15	11.52	12.36	8,230
EPDBEH2025F-15-TH3	●			15	2	2.4	45	4	A	2.57	15.65	16.15	16.69	17.27	干渉なし	8,380

Epoch Deep Ball Evolution Hard-TH3

エポックディープボールエボリューションハード-TH3



レギュラーシャンクタイプ Regular shank type

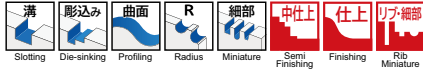

新開発した次世代ハードコーティングTH3を採用!
 高硬度鋼の加工において優れた耐摩耗性を発揮
 Applies newly developed next-generation hard coating "TH3".
 Excellent wear resistance when machining hardened steel.

RE公差 RE tolerance	RE ≤ 0.25 : ±0.003 0.25 < RE : ±0.005	h4 g4	h5 g6-12	(mm)
----------------------	--	----------	-------------	------

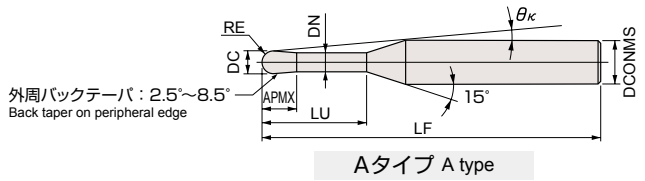

【注意】RE 2mm以上はバックドラフト形状ではありません。
 【Note】RE 2mm or larger does not have backdraft shape.

EPDBEH2-0.08-0.1-0.15-0.2-0.25-0.3-0.35-0.4-0.45-0.5-(S6)-TH3



商品コード Item code	在庫 Stock	寸法 Size(mm)							タイプ Type	干渉角度 Interference angle (°) θκ	勾配角に対する実有効首下長 Effective under neck length with respect to draft angle					希望小売 価格 (円) Suggested retail price (¥)
		ボール半径 Ball radius RE	外径 Tool dia. DC	首下長 Under neck length LU	刃長 Flute length APMX	首径 Neck dia. DN	全長 Overall length LF	シャンク径 Shank dia. DCONMS			0.5°	1°	1.5°	2°	3°	
EPDBEH2001-0.08-TH3	●	0.05	0.1	0.08	0.08	-	45	4	B	20.93	-	-	-	-	16,290	
EPDBEH2001-0.2-TH3	●			0.2	0.08	0.08	45	4	A	14.64	0.24	0.25	0.25	0.26	0.28	16,290
EPDBEH2001-0.3-TH3	●			0.3	0.08	0.08	45	4	A	14.46	0.34	0.35	0.36	0.38	0.40	16,720
EPDBEH2001-0.5-TH3	●			0.5	0.08	0.08	45	4	A	14.10	0.55	0.57	0.59	0.61	0.65	18,110
EPDBEH20015-0.12-TH3	●	0.075	0.15	0.12	0.12	-	45	4	B	15.25	-	-	-	-	16,720	
EPDBEH20015-0.3-TH3	●			0.3	0.12	0.13	45	4	A	14.50	0.34	0.35	0.36	0.37	0.40	16,720
EPDBEH20015-0.5-TH3	●			0.5	0.12	0.13	45	4	A	14.14	0.55	0.56	0.58	0.60	0.65	18,110
EPDBEH20015-0.75-TH3	●			0.75	0.12	0.13	45	4	A	13.71	0.81	0.83	0.86	0.89	0.96	19,710
EPDBEH20015-1-TH3	●			1	0.12	0.13	45	4	A	13.30	1.06	1.10	1.14	1.18	19,710	
EPDBEH2002-0.15-TH3	●	0.1	0.2	0.15	0.15	-	50	4	B	20.23	-	-	-	-	11,680	
EPDBEH2002-0.3-TH3	●			0.3	0.15	0.18	50	4	A	14.54	0.34	0.35	0.36	0.37	0.39	11,680
EPDBEH2002-0.5-TH3	●			0.5	0.15	0.18	50	4	A	14.17	0.55	0.56	0.58	0.60	0.64	11,680
EPDBEH2002-0.75-TH3	●			0.75	0.15	0.18	50	4	A	13.73	0.81	0.83	0.86	0.89	0.95	11,680
EPDBEH2002-1-TH3	●			1	0.15	0.18	50	4	A	13.32	1.06	1.10	1.13	1.17	1.26	11,680
EPDBEH2002-1.25-TH3	●			1.25	0.15	0.18	50	4	A	12.93	1.32	1.37	1.41	1.46	1.57	12,650
EPDBEH2002-1.5-TH3	●			1.5	0.15	0.18	50	4	A	12.56	1.58	1.63	1.69	1.75	1.88	12,650
EPDBEH2002-2-TH3	●			2	0.15	0.18	50	4	A	11.89	2.10	2.17	2.24	2.32	2.50	13,930
EPDBEH2002-2.5-TH3	●			2.5	0.15	0.18	50	4	A	11.28	2.61	2.70	2.80	2.90	3.13	15,220
EPDBEH2002-3-TH3	●			3	0.15	0.18	50	4	A	10.73	3.13	3.24	3.35	3.47	3.75	16,290
EPDBEH2003-0.25-TH3	●	0.15	0.3	0.25	0.25	-	50	4	B	14.45	-	-	-	-	11,470	
EPDBEH2003-0.5-TH3	●			0.5	0.25	0.27	50	4	A	14.21	0.56	0.58	0.60	0.61	0.65	11,470
EPDBEH2003-0.75-TH3	●			0.75	0.25	0.27	50	4	A	13.76	0.82	0.85	0.87	0.90	0.96	11,470
EPDBEH2003-1-TH3	●			1	0.25	0.27	50	4	A	13.33	1.08	1.11	1.15	1.19	1.27	11,470
EPDBEH2003-1.25-TH3	●			1.25	0.25	0.27	50	4	A	12.93	1.34	1.38	1.43	1.47	1.58	12,220
EPDBEH2003-1.5-TH3	●			1.5	0.25	0.27	50	4	A	12.56	1.60	1.65	1.70	1.76	1.89	12,220
EPDBEH2003-2-TH3	●			2	0.25	0.27	50	4	A	11.86	2.12	2.18	2.26	2.34	2.52	12,220
EPDBEH2003-2.5-TH3	●			2.5	0.25	0.27	50	4	A	11.24	2.63	2.72	2.81	2.91	3.14	12,650
EPDBEH2003-3-TH3	●			3	0.25	0.27	50	4	A	10.68	3.15	3.25	3.37	3.49	3.76	12,650
EPDBEH2003-3.5-TH3	●			3.5	0.25	0.27	50	4	A	10.18	3.67	3.79	3.92	4.06	4.38	12,650
EPDBEH2003-4-TH3	●	4	0.25	0.27	50	4	A	9.72	4.18	4.32	4.47	4.64	5.00	12,860		
EPDBEH2004-0.3-TH3	●	0.2	0.4	0.3	0.3	-	50	4	B	14.53	-	-	-	-	7,810	
EPDBEH2004-0.5-TH3	●			0.5	0.3	0.37	50	4	A	14.28	0.56	0.58	0.59	0.60	0.64	7,810
EPDBEH2004-0.75-TH3	●			0.75	0.3	0.37	50	4	A	13.81	0.82	0.84	0.87	0.89	0.95	7,810
EPDBEH2004-1-TH3	●			1	0.3	0.37	50	4	A	13.37	1.08	1.11	1.14	1.18	1.26	7,810
EPDBEH2004-1.5-TH3	●			1.5	0.3	0.37	50	4	A	12.57	1.60	1.65	1.70	1.75	1.88	7,940
EPDBEH2004-2-TH3	●			2	0.3	0.37	50	4	A	11.86	2.11	2.18	2.25	2.33	2.50	8,230
EPDBEH2004-2.5-TH3	●			2.5	0.3	0.37	50	4	A	11.23	2.63	2.72	2.81	2.90	3.13	8,500
EPDBEH2004-3-TH3	●			3	0.3	0.37	50	4	A	10.65	3.15	3.25	3.36	3.48	3.75	9,060
EPDBEH2004-3.5-TH3	●			3.5	0.3	0.37	50	4	A	10.14	3.66	3.78	3.91	4.05	4.37	9,760
EPDBEH2004-4-TH3	●			4	0.3	0.37	50	4	A	9.67	4.18	4.32	4.47	4.63	4.99	9,760
EPDBEH2004-4.5-TH3	●	4.5	0.3	0.37	50	4	A	9.24	4.70	4.85	5.02	5.20	5.61	10,320		
EPDBEH2004-5-TH3	●	5	0.3	0.37	50	4	A	8.85	5.21	5.39	5.58	5.78	6.23	10,320		
EPDBEH2005-0.35-TH3	●	0.25	0.5	0.35	0.35	-	50	4	B	14.10	-	-	-	-	7,810	
EPDBEH2005-0.75-TH3	●			0.75	0.35	0.47	50	4	A	13.88	0.82	0.84	0.86	0.88	0.94	7,810

● : 標準在庫品です。 ● : Stocked items.

超硬コーティング
ボールエンドミル

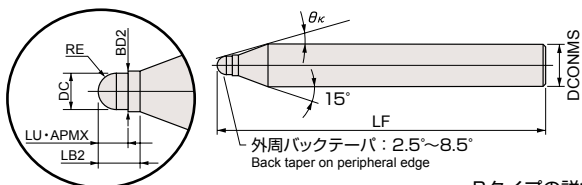

Bタイプ B type

Bタイプの詳細はA63をご確認ください
For details of B type, refer to page A63.

EPDBEH2○○○-○○○-(S6)-TH3

商品コード Item code	在庫 Stock	寸法 Size(mm)							タイプ Type	干渉角度 Interference angle (°) θκ	勾配角に対する実有効首下長 Effective under neck length with respect to draft angle					希望小売 価格(円) Suggested retail price (¥)
		ボール半径 Ball radius	外径 Tool dia.	首下長 Under neck length	刃長 Flute length	首径 Neck dia.	全長 Overall length	シャンク径 Shank dia.			0.5°	1°	1.5°	2°	3°	
		RE	DC	LU	APMX	DN	LF	DCONMS								
EPDBEH2005-1-TH3	●	0.25	0.5	1	0.35	0.47	50	4	A	13.42	1.08	1.11	1.14	1.17	1.25	7,810
EPDBEH2005-1.5-TH3	●			1.5	0.35	0.47	50	4	A	12.59	1.59	1.64	1.69	1.75	1.87	7,810
EPDBEH2005-2-TH3	●			2	0.35	0.47	50	4	A	11.86	2.11	2.18	2.25	2.32	2.49	7,810
EPDBEH2005-2.5-TH3	●			2.5	0.35	0.47	50	4	A	11.21	2.63	2.71	2.80	2.90	3.11	7,810
EPDBEH2005-3-TH3	●			3	0.35	0.47	50	4	A	10.62	3.15	3.25	3.36	3.47	3.73	7,810
EPDBEH2005-4-TH3	●			4	0.35	0.47	50	4	A	9.61	4.18	4.32	4.46	4.62	4.98	7,810
EPDBEH2005-5-TH3	●			5	0.35	0.47	50	4	A	8.78	5.21	5.39	5.57	5.77	6.22	7,940
EPDBEH2005-5.5-TH3	●			5.5	0.35	0.47	50	4	A	8.41	5.73	5.92	6.13	6.35	6.84	8,230
EPDBEH2005-6-TH3	●			6	0.35	0.47	50	4	A	8.08	6.25	6.46	6.68	6.92	7.46	8,230
EPDBEH2005-7-TH3	●			7	0.35	0.47	50	4	A	7.48	7.28	7.53	7.79	8.07	8.71	9,760
EPDBEH2005-8-TH3	●	8	0.35	0.47	50	4	A	6.96	8.31	8.60	8.90	9.22	9.95	9,760		
EPDBEH2006-0.4-TH3	●	0.3	0.6	0.4	0.4	-	50	4	B	14.16	-	-	-	-	-	6,740
EPDBEH2006-0.75-TH3	●			0.75	0.4	0.57	50	4	A	13.94	0.82	0.84	0.86	0.88	0.93	6,740
EPDBEH2006-1-TH3	●			1	0.4	0.57	50	4	A	13.47	1.08	1.10	1.13	1.17	1.24	6,740
EPDBEH2006-1.5-TH3	●			1.5	0.4	0.57	50	4	A	12.61	1.59	1.64	1.69	1.74	1.86	6,000
EPDBEH2006-2-TH3	●			2	0.4	0.57	50	4	A	11.86	2.11	2.17	2.24	2.31	2.48	6,000
EPDBEH2006-2.5-TH3	●			2.5	0.4	0.57	50	4	A	11.19	2.63	2.71	2.80	2.89	3.10	6,140
EPDBEH2006-3-TH3	●			3	0.4	0.57	50	4	A	10.59	3.14	3.24	3.35	3.46	3.72	6,140
EPDBEH2006-3.5-TH3	●			3.5	0.4	0.57	50	4	A	10.05	3.66	3.78	3.90	4.04	4.34	6,410
EPDBEH2006-4-TH3	●			4	0.4	0.57	50	4	A	9.56	4.18	4.31	4.46	4.61	4.97	6,410
EPDBEH2006-4.5-TH3	●			4.5	0.4	0.57	50	4	A	9.12	4.69	4.85	5.01	5.19	5.59	6,410
EPDBEH2006-5-TH3	●			5	0.4	0.57	50	4	A	8.71	5.21	5.38	5.57	5.76	6.21	6,410
EPDBEH2006-5.5-TH3	●			5.5	0.4	0.57	50	4	A	8.34	5.73	5.92	6.12	6.34	6.83	6,410
EPDBEH2006-6-TH3	●			6	0.4	0.57	50	4	A	8.00	6.24	6.45	6.67	6.91	7.45	6,410
EPDBEH2006-7-TH3	●			7	0.4	0.57	50	4	A	7.40	7.28	7.52	7.78	8.06	8.70	7,250
EPDBEH2006-8-TH3	●			8	0.4	0.57	50	4	A	6.88	8.31	8.59	8.89	9.21	9.94	8,500
EPDBEH2006-9-TH3	●			9	0.4	0.57	50	4	A	6.43	9.35	9.66	10.00	10.36	11.18	9,060
EPDBEH2006-10-TH3	●	10	0.4	0.57	50	4	A	6.03	10.38	10.73	11.11	11.51	12.43	8,650		
EPDBEH2006-12-TH3	●	12	0.4	0.57	50	4	A	5.37	12.45	12.87	13.32	13.81	14.91	9,760		
EPDBEH2007-0.45-TH3	●	0.35	0.7	0.45	0.45	-	50	4	B	14.13	-	-	-	-	-	6,000
EPDBEH2007-2-TH3	●			2	0.45	0.67	50	4	A	11.85	2.11	2.17	2.24	2.31	2.47	6,000
EPDBEH2007-4-TH3	●			4	0.45	0.67	50	4	A	9.50	4.18	4.31	4.45	4.61	4.95	6,410
EPDBEH2007-6-TH3	●			6	0.45	0.67	50	4	A	7.92	6.24	6.45	6.67	6.91	7.44	6,410
EPDBEH2007-8-TH3	●			8	0.45	0.67	50	4	A	6.79	8.31	8.59	8.89	9.21	9.93	6,410
EPDBEH2008-0.5-TH3	●	0.4	0.8	0.5	0.5	-	50	4	B	14.20	-	-	-	-	-	6,000
EPDBEH2008-1-TH3	●			1	0.5	0.77	50	4	A	13.58	1.07	1.10	1.12	1.15	1.21	6,000
EPDBEH2008-1.5-TH3	●			1.5	0.5	0.77	50	4	A	12.66	1.59	1.63	1.68	1.73	1.83	6,000
EPDBEH2008-2-TH3	●			2	0.5	0.77	50	4	A	11.85	2.11	2.17	2.23	2.30	2.46	6,000
EPDBEH2008-2.5-TH3	●			2.5	0.5	0.77	50	4	A	11.14	2.62	2.70	2.79	2.88	3.08	6,220
EPDBEH2008-3-TH3	●			3	0.5	0.77	50	4	A	10.51	3.14	3.24	3.34	3.45	3.70	6,410
EPDBEH2008-4-TH3	●			4	0.5	0.77	50	4	A	9.44	4.17	4.31	4.45	4.60	4.94	6,410
EPDBEH2008-5-TH3	●			5	0.5	0.77	50	4	A	8.57	5.21	5.38	5.56	5.75	6.19	6,410
EPDBEH2008-6-TH3	●			6	0.5	0.77	50	4	A	7.84	6.24	6.45	6.66	6.90	7.43	6,410
EPDBEH2008-8-TH3	●			8	0.5	0.77	50	4	A	6.70	8.31	8.58	8.88	9.20	9.92	6,410
EPDBEH2008-10-TH3	●			10	0.5	0.77	50	4	A	5.85	10.38	10.72	11.10	11.50	12.40	8,500
EPDBEH2008-12-TH3	●			12	0.5	0.77	50	4	A	5.19	12.44	12.86	13.31	13.80	14.89	10,450
EPDBEH2009-0.6-TH3	●	0.45	0.9	0.6	0.6	-	50	4	B	13.84	-	-	-	-	-	6,000
EPDBEH2009-2-TH3	●			2	0.6	0.87	50	4	A	11.85	2.11	2.16	2.23	2.29	2.44	6,000
EPDBEH2009-4-TH3	●			4	0.6	0.87	50	4	A	9.38	4.17	4.30	4.44	4.59	4.93	6,410
EPDBEH2009-6-TH3	●			6	0.6	0.87	50	4	A	7.75	6.24	6.44	6.66	6.89	7.42	6,410
EPDBEH2009-8-TH3	●			8	0.6	0.87	50	4	A	6.61	8.31	8.58	8.88	9.19	9.90	6,410

エポックディープボールエボリューションハード-TH3

超硬加工用超硬ボール

EPDBEH2○○○-○○○-(S6)-TH3

商品コード Item code	在庫 Stock	寸法 Size(mm)							タイプ Type	干渉角度 Interference angle (°)	勾配角に対する実有効首下長 Effective under neck length with respect to draft angle					希望小売 価格(円) Suggested retail price (¥)
		ボール半径 Ball radius	外径 Tool dia.	首下長 Under neck length	刃長 Flute length	首径 Neck dia.	全長 Overall length	シャンク径 Shank dia.			0.5°	1°	1.5°	2°	3°	
		RE	DC	LU	APMX	DN	LF	DCONMS								
EPDBEH2010-0.8-TH3	●	0.5	1	0.8	0.8	-	50	4	B	13.47	-	-	-	-	5,020	
EPDBEH2010-1.5-TH3	●			1.5	0.8	0.96	50	4	A	12.67	1.61	1.64	1.69	1.73	1.83	5,020
EPDBEH2010-2-TH3	●			2	0.8	0.96	50	4	A	11.82	2.12	2.18	2.24	2.31	2.46	5,020
EPDBEH2010-2.5-TH3	●			2.5	0.8	0.96	50	4	A	11.07	2.64	2.71	2.80	2.88	3.08	5,020
EPDBEH2010-3-TH3	●			3	0.8	0.96	50	4	A	10.41	3.16	3.25	3.35	3.46	3.70	5,020
EPDBEH2010-4-TH3	●			4	0.8	0.96	50	4	A	9.29	4.19	4.32	4.46	4.61	4.94	5,720
EPDBEH2010-5-TH3	●			5	0.8	0.96	50	4	A	8.39	5.22	5.39	5.57	5.76	6.19	5,720
EPDBEH2010-6-TH3	●			6	0.8	0.96	50	4	A	7.65	6.26	6.46	6.67	6.91	7.43	6,140
EPDBEH2010-7-TH3	●			7	0.8	0.96	50	4	A	7.03	7.29	7.53	7.78	8.06	8.67	6,140
EPDBEH2010-8-TH3	●			8	0.8	0.96	50	4	A	6.50	8.32	8.60	8.89	9.21	9.91	6,140
EPDBEH2010-9-TH3	●			9	0.8	0.96	50	4	A	6.05	9.36	9.67	10.00	10.36	11.16	6,140
EPDBEH2010-10-TH3	●			10	0.8	0.96	50	4	A	5.65	10.39	10.74	11.11	11.51	12.40	6,140
EPDBEH2010-12-TH3	●			12	0.8	0.96	55	4	A	5.00	12.46	12.88	13.32	13.81	14.89	6,140
EPDBEH2010-13-TH3	●			13	0.8	0.96	55	4	A	4.72	13.49	13.95	14.43	14.96	16.13	7,250
EPDBEH2010-14-TH3	●			14	0.8	0.96	55	4	A	4.48	14.53	15.02	15.54	16.11	17.37	7,250
EPDBEH2010-16-TH3	●			16	0.8	0.96	55	4	A	4.06	16.59	17.16	17.76	18.40	19.86	8,500
EPDBEH2010-18-TH3	●			18	0.8	0.96	60	4	A	3.71	18.66	19.29	19.97	20.70	22.35	8,500
EPDBEH2010-20-TH3	●			20	0.8	0.96	60	4	A	3.42	20.73	21.43	22.19	23.00	24.83	10,320
EPDBEH2010-2-S6-TH3	●			2	0.8	0.96	50	6	A	12.92	2.12	2.18	2.24	2.31	2.46	7,530
EPDBEH2010-3-S6-TH3	●			3	0.8	0.96	50	6	A	11.86	3.16	3.25	3.35	3.46	3.70	7,530
EPDBEH2010-6-S6-TH3	●	6	0.8	0.96	50	6	A	9.53	6.26	6.46	6.67	6.91	7.43	9,200		
EPDBEH2010-8-S6-TH3	●	8	0.8	0.96	50	6	A	8.42	8.32	8.60	8.89	9.21	9.91	9,200		
EPDBEH2010-10-S6-TH3	●	10	0.8	0.96	50	6	A	7.54	10.39	10.74	11.11	11.51	12.40	9,200		
EPDBEH2011-2-TH3	●	0.55	1.1	2	1	1.05	50	4	A	11.78	2.14	2.20	2.26	2.32	2.47	6,740
EPDBEH2011-4-TH3	●			4	1	1.05	50	4	A	9.20	4.21	4.34	4.47	4.62	4.95	7,670
EPDBEH2011-6-TH3	●			6	1	1.05	50	4	A	7.54	6.28	6.47	6.69	6.92	7.44	8,360
EPDBEH2011-8-TH3	●			8	1	1.05	50	4	A	6.39	8.34	8.61	8.91	9.22	9.93	8,360
EPDBEH2011-10-TH3	●			10	1	1.05	50	4	A	5.54	10.41	10.75	11.12	11.52	12.41	8,360
EPDBEH2012-2-TH3	●	0.6	1.2	2	1.1	1.15	50	4	A	11.78	2.14	2.19	2.25	2.31	2.46	7,670
EPDBEH2012-3-TH3	●			3	1.1	1.15	50	4	A	10.29	3.17	3.26	3.36	3.46	3.70	7,670
EPDBEH2012-4-TH3	●			4	1.1	1.15	50	4	A	9.13	4.21	4.33	4.47	4.61	4.94	7,670
EPDBEH2012-6-TH3	●			6	1.1	1.15	50	4	A	7.45	6.27	6.47	6.68	6.91	7.43	8,360
EPDBEH2012-8-TH3	●			8	1.1	1.15	50	4	A	6.29	8.34	8.61	8.90	9.21	9.91	8,360
EPDBEH2012-10-TH3	●			10	1.1	1.15	50	4	A	5.44	10.41	10.75	11.12	11.51	12.40	8,360
EPDBEH2012-12-TH3	●			12	1.1	1.15	55	4	A	4.79	12.48	12.89	13.33	13.81	14.89	8,360
EPDBEH2012-2-S6-TH3	●			2	1.1	1.15	50	6	A	12.94	2.14	2.19	2.25	2.31	2.46	11,470
EPDBEH2012-4-S6-TH3	●			4	1.1	1.15	50	6	A	10.92	4.21	4.33	4.47	4.61	4.94	11,470
EPDBEH2014-3-TH3	●			0.7	1.4	3	1.3	1.34	50	4	A	10.15	3.19	3.28	3.37	3.47
EPDBEH2014-8-TH3	●	8	1.3			1.34	50	4	A	6.06	8.36	8.62	8.91	9.22	9.91	7,250
EPDBEH2014-12-TH3	●	12	1.3			1.34	55	4	A	4.58	12.49	12.90	13.34	13.82	14.89	7,250
EPDBEH2014-16-TH3	●	16	1.3			1.34	55	4	A	3.68	16.63	17.18	17.78	18.42	19.86	7,250
EPDBEH2015-2-TH3	●	0.75	1.5	2	1.35	1.45	50	4	A	11.76	2.13	2.18	2.23	2.29	2.42	5,850
EPDBEH2015-2.5-TH3	●			2.5	1.35	1.45	50	4	A	10.88	2.65	2.72	2.79	2.87	3.04	5,850
EPDBEH2015-3-TH3	●			3	1.35	1.45	50	4	A	10.12	3.17	3.25	3.34	3.44	3.66	5,850
EPDBEH2015-4-TH3	●			4	1.35	1.45	50	4	A	8.88	4.20	4.32	4.45	4.59	4.91	5,850
EPDBEH2015-5-TH3	●			5	1.35	1.45	50	4	A	7.90	5.23	5.39	5.56	5.74	6.15	5,850

● : 標準在庫品です。● : Stocked items. 干渉なし : No interference.

EPDBEH2○○○-○○○-(S6)-TH3

商品コード Item code	在庫 Stock	寸法 Size(mm)							タイプ Type	干渉角度 Interference angle (°)	勾配角に対する実有効首下長 Effective under neck length with respect to draft angle					希望小売 価格(円) Suggested retail price (¥)
		ボール半径 Ball radius	外径 Tool dia.	首下長 Under neck length	刃長 Flute length	首径 Neck dia.	全長 Overall length	シャンク径 Shank dia.								
		RE	DC	LU	APMX	DN	LF	DCONMS			0.5°	1°	1.5°	2°	3°	
EPDBEH2015-6-TH3	●	0.75	1.5	6	1.35	1.45	50	4	A	7.12	6.27	6.46	6.67	6.89	7.39	5,850
EPDBEH2015-8-TH3	●			8	1.35	1.45	50	4	A	5.95	8.34	8.60	8.88	9.19	9.88	6,140
EPDBEH2015-10-TH3	●			10	1.35	1.45	50	4	A	5.10	10.40	10.74	11.10	11.49	12.36	6,690
EPDBEH2015-12-TH3	●			12	1.35	1.45	55	4	A	4.47	12.47	12.88	13.32	13.79	14.85	7,250
EPDBEH2015-14-TH3	●			14	1.35	1.45	55	4	A	3.98	14.54	15.02	15.53	16.09	17.34	7,250
EPDBEH2015-16-TH3	●			16	1.35	1.45	55	4	A	3.58	16.60	17.16	17.75	18.39	19.82	7,250
EPDBEH2015-18-TH3	●			18	1.35	1.45	60	4	A	3.26	18.67	19.30	19.97	20.69	22.31	7,250
EPDBEH2015-20-TH3	●			20	1.35	1.45	60	4	A	2.99	20.74	21.44	22.18	22.99	干渉なし	7,250
EPDBEH2015-3-S6-TH3	●			3	1.35	1.45	50	6	A	11.84	3.17	3.25	3.34	3.44	3.66	8,780
EPDBEH2015-5-S6-TH3	●			5	1.35	1.45	50	6	A	10.02	5.23	5.39	5.56	5.74	6.15	8,780
EPDBEH2015-8-S6-TH3	●			8	1.35	1.45	50	6	A	8.14	8.34	8.60	8.88	9.19	9.88	9,200
EPDBEH2015-12-S6-TH3	●			12	1.35	1.45	50	6	A	6.51	12.47	12.88	13.32	13.79	14.85	10,830
EPDBEH2016-4-TH3	●	0.8	1.6	4	1.4	1.54	50	4	A	8.76	4.22	4.34	4.47	4.61	4.92	8,360
EPDBEH2016-8-TH3	●			8	1.4	1.54	50	4	A	5.82	8.35	8.62	8.90	9.20	9.89	8,360
EPDBEH2016-12-TH3	●			12	1.4	1.54	55	4	A	4.35	12.49	12.90	13.33	13.80	14.86	8,360
EPDBEH2016-16-TH3	●			16	1.4	1.54	55	4	A	3.47	16.62	17.17	17.77	18.40	19.84	8,360
EPDBEH2016-20-TH3	●			20	1.4	1.54	60	4	A	2.89	20.76	21.45	22.20	23.00	干渉なし	8,360
EPDBEH2018-4-TH3	●	0.9	1.8	4	1.6	1.73	50	4	A	8.53	4.23	4.35	4.48	4.61	4.92	7,250
EPDBEH2018-8-TH3	●			8	1.6	1.73	50	4	A	5.55	8.37	8.63	8.91	9.21	9.89	7,250
EPDBEH2018-12-TH3	●			12	1.6	1.73	55	4	A	4.11	12.50	12.91	13.34	13.81	14.86	7,250
EPDBEH2018-16-TH3	●			16	1.6	1.73	55	4	A	3.26	16.64	17.19	17.78	18.41	19.83	7,250
EPDBEH2018-20-TH3	●			20	1.6	1.73	60	4	A	2.70	20.77	21.47	22.21	23.01	干渉なし	7,250
EPDBEH2020-2.5-TH3	●	1	2	2.5	1.7	1.94	50	4	A	10.60	2.66	2.72	2.78	2.85	3.01	5,020
EPDBEH2020-3-TH3	●			3	1.7	1.94	50	4	A	9.72	3.18	3.25	3.34	3.43	3.63	5,020
EPDBEH2020-4-TH3	●			4	1.7	1.94	50	4	A	8.32	4.21	4.32	4.45	4.58	4.87	5,020
EPDBEH2020-5-TH3	●			5	1.7	1.94	50	4	A	7.27	5.25	5.39	5.55	5.73	6.11	5,720
EPDBEH2020-6-TH3	●			6	1.7	1.94	50	4	A	6.46	6.28	6.46	6.66	6.88	7.36	5,720
EPDBEH2020-8-TH3	●			8	1.7	1.94	50	4	A	5.27	8.35	8.60	8.88	9.18	9.84	6,140
EPDBEH2020-10-TH3	●			10	1.7	1.94	50	4	A	4.46	10.41	10.74	11.10	11.48	12.33	6,140
EPDBEH2020-12-TH3	●			12	1.7	1.94	55	4	A	3.86	12.48	12.88	13.31	13.77	14.82	6,140
EPDBEH2020-13-TH3	●			13	1.7	1.94	55	4	A	3.62	13.51	13.95	14.42	14.92	16.06	6,140
EPDBEH2020-14-TH3	●			14	1.7	1.94	55	4	A	3.40	14.55	15.02	15.53	16.07	17.30	6,140
EPDBEH2020-16-TH3	●			16	1.7	1.94	55	4	A	3.04	16.62	17.16	17.75	18.37	19.79	6,140
EPDBEH2020-18-TH3	●			18	1.7	1.94	60	4	A	2.75	18.68	19.30	19.96	20.67	干渉なし	6,140
EPDBEH2020-20-TH3	●			20	1.7	1.94	60	4	A	2.51	20.75	21.44	22.18	22.97	干渉なし	6,140
EPDBEH2020-22-TH3	●			22	1.7	1.94	60	4	A	2.31	22.82	23.58	24.40	25.27	干渉なし	8,500
EPDBEH2020-25-TH3	●			25	1.7	1.94	65	4	A	2.06	25.92	26.79	27.72	28.72	干渉なし	8,650
EPDBEH2020-30-TH3	●			30	1.7	1.94	70	4	A	1.75	31.09	32.14	33.26	干渉なし	干渉なし	9,900
EPDBEH2020-35-TH3	●			35	1.7	1.94	75	4	A	1.52	36.26	37.48	38.80	干渉なし	干渉なし	13,390
EPDBEH2020-40-TH3	●			40	1.7	1.94	80	4	A	1.34	41.42	42.83	干渉なし	干渉なし	干渉なし	13,390
EPDBEH2020-3-S6-TH3	●			3	1.7	1.94	50	6	A	11.80	3.18	3.25	3.34	3.43	3.63	7,530
EPDBEH2020-6-S6-TH3	●			6	1.7	1.94	50	6	A	9.04	6.28	6.46	6.66	6.88	7.36	8,570
EPDBEH2020-8-S6-TH3	●			8	1.7	1.94	50	6	A	7.82	8.35	8.60	8.88	9.18	9.84	9,200
EPDBEH2020-12-S6-TH3	●			12	1.7	1.94	50	6	A	6.15	12.48	12.88	13.31	13.77	14.82	9,200
EPDBEH2020-16-S6-TH3	●			16	1.7	1.94	50	6	A	5.07	16.62	17.16	17.75	18.37	19.79	9,200
EPDBEH2020-20-S6-TH3	●			20	1.7	1.94	60	6	A	4.31	20.75	21.44	22.18	22.97	24.76	9,200

エポックディープボールエボリューションハード-TH3

超硬ボールエンドミル
ボールエンドミル

EPDBEH2○○○-○○○-(S6)-TH3

商品コード Item code	在庫 Stock	寸法 Size(mm)							タイプ Type	干渉角度 Interference angle (°) θ_K	勾配角に対する実有効首下長 Effective under neck length with respect to draft angle					希望小売 価格 (円) Suggested retail price (¥)
		ボール半径 Ball radius	外径 Tool dia.	首下長 Under neck length	刃長 Flute length	首径 Neck dia.	全長 Overall length	シャンク径 Shank dia.			0.5°	1°	1.5°	2°	3°	
		RE	DC	LU	APMX	DN	LF	DCONMS								
EPDBEH2025-6-TH3	●	1.25	2.5	6	2	2.4	50	4	A	5.54	6.35	6.53	6.72	6.92	7.39	7,720
EPDBEH2025-10-TH3	●			10	2	2.4	50	4	A	3.66	10.48	10.81	11.15	11.52	12.36	8,230
EPDBEH2025-15-TH3	●			15	2	2.4	55	4	A	2.57	15.65	16.15	16.69	17.27	干渉なし	8,380
EPDBEH2025-20-TH3	●			20	2	2.4	60	4	A	1.98	20.82	21.50	22.23	干渉なし	干渉なし	9,830
EPDBEH2025-25-TH3	●			25	2	2.4	65	4	A	1.61	25.99	26.85	27.78	干渉なし	干渉なし	10,460
EPDBEH2025-30-TH3	●			30	2	2.4	70	4	A	1.36	31.16	32.20	干渉なし	干渉なし	干渉なし	12,110
EPDBEH2030-6-TH3	●	1.5	3	6	2.5	2.88	50	6	A	8.27	6.38	6.55	6.73	6.93	7.38	6,270
EPDBEH2030-8-TH3	●			8	2.5	2.88	55	6	A	6.95	8.45	8.69	8.95	9.23	9.86	6,270
EPDBEH2030-10-TH3	●			10	2.5	2.88	55	6	A	5.98	10.51	10.83	11.17	11.53	12.35	7,250
EPDBEH2030-13-TH3	●			13	2.5	2.88	60	6	A	4.95	13.61	14.04	14.49	14.98	16.08	8,290
EPDBEH2030-16-TH3	●			16	2.5	2.88	60	6	A	4.23	16.71	17.25	17.82	18.43	19.81	8,380
EPDBEH2030-20-TH3	●			20	2.5	2.88	65	6	A	3.53	20.85	21.52	22.25	23.03	24.78	8,060
EPDBEH2030-25-TH3	●			25	2.5	2.88	70	6	A	2.93	26.02	26.87	27.79	28.78	干渉なし	8,060
EPDBEH2030-30-TH3	●			30	2.5	2.88	75	6	A	2.51	31.19	32.22	33.33	34.53	干渉なし	9,190
EPDBEH2030-35-TH3	●			35	2.5	2.88	80	6	A	2.19	36.35	37.57	38.87	40.28	干渉なし	11,580
EPDBEH2035-10-TH3	●			1.75	3.5	10	2.75	3.35	55	6	A	5.42	10.56	10.87	11.20	11.56
EPDBEH2035-15-TH3	●	15	2.75			3.35	60	6	A	3.94	15.73	16.22	16.74	17.31	18.58	10,630
EPDBEH2035-25-TH3	●	25	2.75			3.35	70	6	A	2.54	26.07	26.92	27.83	28.81	干渉なし	11,250
EPDBEH2035-35-TH3	●	35	2.75			3.35	80	6	A	1.88	36.40	37.61	38.91	干渉なし	干渉なし	14,460
EPDBEH2035-45-TH3	●	45	2.75			3.35	90	6	A	1.49	46.74	48.31	干渉なし	干渉なし	干渉なし	17,680
EPDBEH2040-8-TH3	●	2	4	8	3	3.85	55	6	A	5.71	8.49	8.71	8.96	9.22	9.81	6,450
EPDBEH2040-10-TH3	●			10	3	3.85	55	6	A	4.76	10.55	10.85	11.17	11.52	12.30	6,450
EPDBEH2040-12-TH3	●			12	3	3.85	60	6	A	4.09	12.62	12.99	13.39	13.82	14.79	8,380
EPDBEH2040-13-TH3	●			13	3	3.85	60	6	A	3.82	13.65	14.06	14.50	14.97	16.03	8,380
EPDBEH2040-16-TH3	●			16	3	3.85	60	6	A	3.18	16.76	17.27	17.82	18.42	19.76	8,380
EPDBEH2040-20-TH3	●			20	3	3.85	65	6	A	2.61	20.89	21.55	22.26	23.02	干渉なし	8,380
EPDBEH2040-25-TH3	●			25	3	3.85	70	6	A	2.13	26.06	26.90	27.80	28.77	干渉なし	8,380
EPDBEH2040-30-TH3	●			30	3	3.85	75	6	A	1.79	31.23	32.25	33.34	干渉なし	干渉なし	8,380
EPDBEH2040-35-TH3	●			35	3	3.85	80	6	A	1.55	36.40	37.60	38.88	干渉なし	干渉なし	9,660
EPDBEH2040-40-TH3	●			40	3	3.85	80	6	A	1.37	41.56	42.94	干渉なし	干渉なし	干渉なし	10,830
EPDBEH2040-45-TH3	●			45	3	3.85	90	6	A	1.22	46.73	48.29	干渉なし	干渉なし	干渉なし	14,040
EPDBEH2040-50-TH3	●			50	3	3.85	100	6	A	1.11	51.90	53.64	干渉なし	干渉なし	干渉なし	15,320
EPDBEH2050-10-TH3	●	2.5	5	10	3.5	4.85	55	6	A	2.97	10.54	10.82	11.12	11.45	干渉なし	13,250
EPDBEH2050-20-TH3	●			20	3.5	4.85	65	6	A	1.46	20.87	21.52	干渉なし	干渉なし	干渉なし	14,710
EPDBEH2050-25-TH3	●			25	3.5	4.85	70	6	A	1.17	26.04	26.86	干渉なし	干渉なし	干渉なし	14,710
EPDBEH2050-30-TH3	●			30	3.5	4.85	75	6	A	0.97	31.21	干渉なし	干渉なし	干渉なし	干渉なし	15,710
EPDBEH2050-40-TH3	●			40	3.5	4.85	80	6	A	0.73	41.55	干渉なし	干渉なし	干渉なし	干渉なし	19,530
EPDBEH2060-12-TH3	●	3	6	12	6	5.85	60	6	A	0	干渉なし	干渉なし	干渉なし	干渉なし	干渉なし	10,960
EPDBEH2060-20-TH3	●			20	6	5.85	65	6	A	0	干渉なし	干渉なし	干渉なし	干渉なし	干渉なし	10,960
EPDBEH2060-30-TH3	●			30	6	5.85	75	6	A	0	干渉なし	干渉なし	干渉なし	干渉なし	干渉なし	11,350
EPDBEH2060-50-TH3	●			50	6	5.85	100	6	A	0	干渉なし	干渉なし	干渉なし	干渉なし	干渉なし	13,360
EPDBEH2080-24-TH3	●	4	8	24	12	7.6	100	8	A	0	干渉なし	干渉なし	干渉なし	干渉なし	干渉なし	16,050
EPDBEH2100-30-TH3	●	5	10	30	15	9.5	100	10	A	0	干渉なし	干渉なし	干渉なし	干渉なし	干渉なし	19,980
EPDBEH2120-36-TH3	●	6	12	36	18	11.5	110	12	A	0	干渉なし	干渉なし	干渉なし	干渉なし	干渉なし	25,930

●印：標準在庫品です。 ●：Stocked items. 干渉なし：No interference

ストロングネックタイプ×ショートシャックタイプ Strong neck type × Short shank type



RE公差 RE tolerance
 $RE \leq 0.25 : \pm 0.003$
 $0.25 < RE : \pm 0.005$



(mm)

2枚刃
2 Flutes

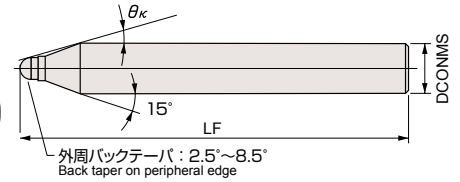
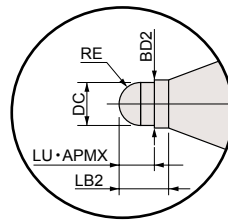

EPDBEH2○○○F-○○.○○-TH3



商品コード Item code	在庫 Stock	寸法 Size(mm)								干渉角度 Interference angle (°) θ_K	希望小売 価格(円) Suggested retail price(¥)
		ボール半径 Ball radius RE	外径 Tool dia. DC	首下長 Under neck length LU	刃長 Flute length APMX	全長 Overall length LF	シャック径 Shank dia. DCONMS	首寸法 Neck size LB2, BD2			
EPDBEH2001F-0.08-TH3	●	0.05	0.1	0.08	0.08	35	4	0.2	0.13	20.93	16,290
EPDBEH20015F-0.12-TH3	●	0.075	0.15	0.12	0.12	35	4	0.3	0.18	15.25	16,720
EPDBEH2002F-0.15-TH3	●	0.1	0.2	0.15	0.15	35	4	0.3	0.25	20.23	11,680
EPDBEH2003F-0.25-TH3	●	0.15	0.3	0.25	0.25	35	4	0.5	0.35	14.45	11,470
EPDBEH2004F-0.3-TH3	●	0.2	0.4	0.3	0.3	35	4	0.5	0.45	14.53	7,810
EPDBEH2005F-0.35-TH3	●	0.25	0.5	0.35	0.35	35	4	0.75	0.55	14.10	7,810
EPDBEH2006F-0.4-TH3	●	0.3	0.6	0.4	0.4	35	4	0.75	0.65	14.16	6,740
EPDBEH2007F-0.45-TH3	●	0.35	0.7	0.45	0.45	35	4	0.8	0.75	14.13	6,000
EPDBEH2008F-0.5-TH3	●	0.4	0.8	0.5	0.5	35	4	0.8	0.85	14.20	6,000
EPDBEH2009F-0.6-TH3	●	0.45	0.9	0.6	0.6	35	4	1	0.95	13.84	6,000
EPDBEH2010F-0.8-TH3	●	0.5	1	0.8	0.8	35	4	1.2	1.05	13.47	5,020

ストロングネックタイプ Strong neck type



RE公差 RE tolerance
 $RE \leq 0.25 : \pm 0.003$
 $0.25 < RE : \pm 0.005$



(mm)

2枚刃
2 Flutes



EPDBEH2○○○-○○.○○-TH3



商品コード Item code	在庫 Stock	寸法 Size(mm)								干渉角度 Interference angle (°) θ_K	希望小売 価格(円) Suggested retail price(¥)
		ボール半径 Ball radius RE	外径 Tool dia. DC	首下長 Under neck length LU	刃長 Flute length APMX	全長 Overall length LF	シャック径 Shank dia. DCONMS	首寸法 Neck size LB2, BD2			
EPDBEH2001-0.08-TH3	●	0.05	0.1	0.08	0.08	45	4	0.2	0.13	20.93	16,290
EPDBEH20015-0.12-TH3	●	0.075	0.15	0.12	0.12	45	4	0.3	0.18	15.25	16,720
EPDBEH2002-0.15-TH3	●	0.1	0.2	0.15	0.15	50	4	0.3	0.25	20.23	11,680
EPDBEH2003-0.25-TH3	●	0.15	0.3	0.25	0.25	50	4	0.5	0.35	14.45	11,470
EPDBEH2004-0.3-TH3	●	0.2	0.4	0.3	0.3	50	4	0.5	0.45	14.53	7,810
EPDBEH2005-0.35-TH3	●	0.25	0.5	0.35	0.35	50	4	0.75	0.55	14.10	7,810
EPDBEH2006-0.4-TH3	●	0.3	0.6	0.4	0.4	50	4	0.75	0.65	14.16	6,740
EPDBEH2007-0.45-TH3	●	0.35	0.7	0.45	0.45	50	4	0.8	0.75	14.13	6,000
EPDBEH2008-0.5-TH3	●	0.4	0.8	0.5	0.5	50	4	0.8	0.85	14.20	6,000
EPDBEH2009-0.6-TH3	●	0.45	0.9	0.6	0.6	50	4	1	0.95	13.84	6,000
EPDBEH2010-0.8-TH3	●	0.5	1	0.8	0.8	50	4	1.2	1.05	13.47	5,020

対応被削材 Applicable work material

炭素鋼 合金鋼 Carbon steel Alloy steel	プリハー ド鋼 Pre-hardened steel	高硬度 Hardened steel			ステン レス鋼 Stainless steel	チタン 合金 耐熱合金 Titanium alloy Heat-resistant alloy	銅合金 Copper alloy	アルミ 合金 Aluminum alloy
		> 45HRC ≤ 55HRC	> 55HRC ≤ 65HRC	> 65HRC				
○	○	◎	◎	◎	○	◎	○	

再研磨対応外径範囲 Re-grinding compatibility range

商品コード Item code	外周 Outer dia. (mm)	エンド End (mm)
EPDBEH-TH3	× (N/A)	4 ~ 12

【注意】首下長/外径が10DCを超える工具の再研磨可否については、弊社営業にお問い合わせください。
 【Note】Contact our sales office regarding whether or not regrinding is possible for tools where under neck length/tool diameter more than 10DC



標準切削条件表
Recommended cutting conditions

高能率切削条件
High efficiency cutting conditions

高精度切削条件
High accuracy cutting conditions

EPDBEH-TH3

高精度切削条件はA68ページを参照してください。Please refer to P.A68 about high accuracy cutting conditions

被削材 Work material				1		2		3		4		5	
				プリハードン鋼 Pre-hardened steels (35~45HRC)		焼入れ鋼 Hardened steels (45~55HRC)		焼入れ鋼 Hardened steels (55~65HRC)		焼入れ鋼 Hardened steels (65~68HRC)		焼入れ鋼 Hardened steels (68~72HRC)	
切り込み比率 Ratio to standard depth of cut				100%		85%		80%		65%		55%	
ボール半径RE Ball radius (mm)	外径DC Tool dia. (mm)	首下長LU Under neck length (mm)	ap (mm)	回転数 n min ⁻¹	送り速度 Vf mm/min	回転数 n min ⁻¹	送り速度 Vf mm/min	回転数 n min ⁻¹	送り速度 Vf mm/min	回転数 n min ⁻¹	送り速度 Vf mm/min	回転数 n min ⁻¹	送り速度 Vf mm/min
0.05	0.1	0.08	0.006	50,000	230	50,000	200	50,000	190	45,000	170	42,500	130
		0.2	0.006	50,000	230	50,000	200	50,000	190	45,000	170	42,500	130
		0.3	0.005	50,000	230	50,000	200	50,000	190	45,000	170	42,500	130
		0.5	0.003	50,000	230	50,000	200	50,000	190	45,000	170	42,500	130
0.075	0.15	0.12	0.009	50,000	280	46,000	230	42,000	180	37,500	160	35,500	120
		0.3	0.009	50,000	280	46,000	230	42,000	180	37,500	160	35,500	120
		0.5	0.008	50,000	280	46,000	230	42,000	180	37,500	160	35,500	120
		0.75	0.007	50,000	280	46,000	230	42,000	180	37,500	160	35,500	120
0.1	0.2	1	0.005	46,000	230	41,400	190	37,800	150	33,750	130	31,950	100
		0.15	0.016	50,000	330	45,500	270	42,000	210	37,800	190	35,700	150
		0.3	0.016	50,000	330	45,500	270	42,000	210	37,800	190	35,700	150
		0.5	0.016	50,000	330	45,500	270	42,000	210	37,800	190	35,700	150
		0.75	0.014	50,000	330	45,500	270	42,000	210	37,800	190	35,700	150
		1	0.011	50,000	330	45,500	270	42,000	210	37,800	190	35,700	150
		1.25	0.009	45,900	270	40,500	220	37,800	170	34,020	150	32,130	120
		1.5	0.006	45,900	270	40,500	220	37,800	170	34,020	150	32,130	120
0.15	0.3	2	0.006	45,900	270	40,500	220	37,800	170	34,020	150	32,130	120
		2.5	0.005	40,800	210	36,000	170	33,600	130	30,240	120	28,560	90
		3	0.003	40,800	210	36,000	170	33,600	130	30,240	120	28,560	90
		0.25	0.022	50,000	450	45,000	380	42,000	340	37,800	300	35,700	240
		0.5	0.022	50,000	450	45,000	380	42,000	340	37,800	300	35,700	240
		0.75	0.019	50,000	450	45,000	380	42,000	340	37,800	300	35,700	240
		1	0.017	50,000	450	45,000	380	42,000	340	37,800	300	35,700	240
		1.25	0.015	50,000	450	45,000	380	42,000	340	37,800	300	35,700	240
		1.5	0.013	50,000	450	45,000	380	42,000	340	37,800	300	35,700	240
		2	0.01	45,900	370	40,500	310	37,800	270	34,020	250	32,130	190
0.2	0.4	2.5	0.008	45,900	370	40,500	310	37,800	270	34,020	250	32,130	190
		3	0.006	45,900	370	40,500	310	37,800	270	34,020	250	32,130	190
		3.5	0.004	36,720	260	29,400	210	26,400	180	23,760	160	22,440	130
		4	0.003	36,720	260	29,400	210	26,400	180	23,760	160	22,440	130
		0.3	0.034	50,000	770	46,800	660	43,680	610	39,310	550	37,130	430
		0.5	0.034	50,000	770	46,800	660	43,680	610	39,310	550	37,130	430
		0.75	0.034	50,000	770	46,800	660	43,680	610	39,310	550	37,130	430
		1	0.032	50,000	770	46,800	660	43,680	610	39,310	550	37,130	430
		1.5	0.027	50,000	660	46,800	470	43,680	440	39,310	390	37,130	310
		2	0.022	50,000	550	46,800	470	43,680	440	39,310	390	37,130	310
		2.5	0.018	36,720	360	32,400	290	36,290	270	32,660	250	30,850	190
		3	0.013	36,720	360	32,400	290	36,290	270	32,660	250	30,850	190
0.25	0.5	3.5	0.01	36,720	360	32,400	290	36,290	270	32,660	250	30,850	190
		4	0.008	36,720	360	32,400	290	36,290	270	32,660	250	30,850	190
		4.5	0.006	32,640	310	28,800	250	26,880	230	24,190	210	22,850	160
		5	0.004	32,640	310	28,800	250	26,880	230	24,190	210	22,850	160
		0.35	0.036	50,000	1,190	47,130	1,050	43,930	740	39,820	670	37,560	520
		0.75	0.036	50,000	1,190	47,130	1,050	43,930	740	39,820	670	37,560	520
		1	0.036	50,000	1,190	47,130	1,050	43,930	740	39,820	670	37,560	520
		1.5	0.032	50,000	1,190	47,130	1,050	43,930	680	39,820	610	37,560	480
		2	0.028	50,000	960	47,130	840	43,930	680	39,820	610	37,560	480
		2.5	0.026	45,450	650	42,840	570	39,940	500	36,220	450	34,180	350
		3	0.024	45,450	650	42,840	570	39,940	390	36,220	350	34,180	270
		4	0.016	34,970	500	32,950	520	30,730	390	28,540	350	26,290	270
		5	0.014	34,970	500	32,950	520	30,730	390	28,540	350	26,290	270
		5.5	0.012	31,080	420	29,300	370	27,310	320	24,770	290	23,370	230
6	0.01	31,080	420	29,300	370	27,310	320	24,770	290	23,370	230		
7	0.008	31,080	420	29,300	370	27,310	320	24,770	290	23,370	230		
0.3	0.6	8	0.006	31,080	420	29,300	370	27,310	320	24,770	290	23,370	230
		0.4	0.06	50,000	1,950	48,000	1,730	44,800	1,340	40,320	1,210	38,080	940
		0.75	0.06	50,000	1,950	48,000	1,730	44,800	1,340	40,320	1,210	38,080	940

超硬ボールエンドミル

被削材 Work material				1		2		3		4		5	
				プリハードン鋼 Pre-hardened steels (35~45HRC)		焼入れ鋼 Hardened steels (45~55HRC)		焼入れ鋼 Hardened steels (55~65HRC)		焼入れ鋼 Hardened steels (65~68HRC)		焼入れ鋼 Hardened steels (68~72HRC)	
切り込み比率 Ratio to standard depth of cut				100%		85%		80%		65%		55%	
ボール半径RE Ball radius (mm)	外径DC Tool dia. (mm)	首下長LU Under neck length (mm)	ap (mm)	回転数 n min ⁻¹	送り速度 Vf mm/min	回転数 n min ⁻¹	送り速度 Vf mm/min	回転数 n min ⁻¹	送り速度 Vf mm/min	回転数 n min ⁻¹	送り速度 Vf mm/min	回転数 n min ⁻¹	送り速度 Vf mm/min
0.3	0.6	1	0.06	50,000	1,950	48,000	1,730	44,800	1,340	40,320	1,210	38,080	940
		1.5	0.055	50,000	1,950	48,000	1,730	44,800	1,340	40,320	1,210	38,080	940
		2	0.05	50,000	1,950	48,000	1,730	44,800	1,340	40,320	1,210	38,080	940
		2.5	0.036	50,000	1,560	48,000	1,380	44,800	990	40,320	890	38,080	690
		3	0.033	50,000	1,560	48,000	1,380	44,800	990	40,320	890	38,080	690
		3.5	0.028	48,960	1,450	43,200	1,180	40,320	840	36,290	760	34,270	590
		4	0.021	48,960	1,450	43,200	1,180	40,320	770	36,290	690	34,270	540
		4.5	0.018	45,900	1,070	40,500	880	37,800	680	34,020	610	32,130	480
		5	0.016	39,780	930	35,100	760	32,760	590	29,480	530	27,850	410
		5.5	0.014	39,780	930	35,100	760	32,760	590	29,480	530	27,850	410
		6	0.012	39,780	930	35,100	760	32,760	590	29,480	530	27,850	410
		7	0.012	27,200	600	24,000	490	22,400	420	20,160	370	19,040	290
8	0.012	27,200	600	24,000	490	22,400	380	20,160	340	19,040	270		
9	0.01	27,200	600	24,000	490	22,400	380	20,160	340	19,040	270		
10	0.007	23,800	530	21,000	430	19,600	330	17,640	300	16,660	230		
12	0.006	20,400	420	18,000	350	16,800	270	15,120	240	14,280	190		
0.35	0.7	0.45	0.073	50,000	2,160	48,000	1,930	44,800	1,190	40,320	1,070	38,080	830
		2	0.073	50,000	2,160	48,000	1,930	44,800	1,190	40,320	1,070	38,080	830
		4	0.033	48,960	1,600	43,200	1,320	43,870	850	39,480	760	37,370	590
		6	0.022	39,780	1,030	35,100	850	35,650	640	32,080	580	30,370	450
		8	0.016	27,200	630	24,000	520	24,370	420	21,940	380	20,760	300
0.4	0.8	0.5	0.12	50,000	2,400	48,000	2,590	44,800	1,880	40,320	1,690	38,080	1,320
		1	0.12	50,000	2,400	48,000	2,590	44,800	1,880	40,320	1,690	38,080	1,320
		1.5	0.12	50,000	2,400	48,000	2,590	44,800	1,880	40,320	1,690	38,080	1,320
		2	0.096	50,000	2,400	48,000	2,590	44,800	1,880	40,320	1,690	38,080	1,320
		2.5	0.088	50,000	2,400	48,000	2,590	44,800	1,880	40,320	1,690	38,080	1,320
		3	0.08	50,000	2,400	48,000	2,590	44,800	1,880	40,320	1,690	38,080	1,320
		4	0.063	50,000	2,400	48,000	2,590	44,800	1,880	40,320	1,690	38,080	1,320
		5	0.047	48,960	2,110	43,200	2,120	40,320	1,520	36,290	1,370	34,270	1,070
		6	0.033	42,840	1,730	37,800	1,430	35,280	1,250	31,750	1,120	29,990	870
		8	0.016	35,360	1,020	31,200	840	29,120	730	26,210	660	24,750	510
10	0.016	27,200	740	24,000	610	22,400	530	20,160	480	19,040	370		
12	0.01	27,200	740	24,000	610	22,400	530	20,160	480	19,040	370		
0.45	0.9	0.6	0.108	50,000	2,820	45,600	2,410	42,560	2,140	38,300	1,930	36,180	1,500
		2	0.108	50,000	2,820	45,600	2,410	42,560	2,140	38,300	1,930	36,180	1,500
		4	0.065	48,450	2,370	42,750	1,960	39,900	1,740	35,910	1,560	33,920	1,220
		6	0.044	40,700	1,520	35,910	1,250	33,520	1,110	30,160	1,000	28,490	780
		8	0.029	31,010	1,050	27,360	870	25,540	770	22,980	690	21,710	540
0.5	1	0.8	0.18	45,900	3,100	43,200	2,720	37,800	2,270	34,020	2,040	32,130	1,590
		1.5	0.18	45,900	3,100	43,200	2,720	37,800	2,270	34,020	2,040	32,130	1,590
		2	0.16	45,900	3,100	43,200	2,720	37,800	2,270	34,020	2,040	32,130	1,590
		2.5	0.16	45,900	3,100	43,200	2,720	37,800	2,270	34,020	2,040	32,130	1,590
		3	0.16	45,900	3,100	43,200	2,720	37,800	2,270	34,020	2,040	32,130	1,590
		4	0.112	45,900	3,100	43,200	2,720	37,800	2,270	34,020	2,040	32,130	1,590
		5	0.072	39,780	2,600	43,200	2,540	32,760	1,840	29,480	1,650	27,850	1,280
		6	0.048	38,560	2,320	38,880	2,350	29,480	1,380	26,540	1,240	25,060	970
		7	0.048	33,050	1,340	31,590	1,320	27,220	1,060	24,490	960	23,130	740
		8	0.048	33,050	1,340	31,590	1,320	27,220	980	24,490	880	23,130	690
		9	0.036	33,050	1,340	31,590	1,320	27,220	980	24,490	880	23,130	690
		10	0.03	33,050	1,340	31,590	1,320	27,220	980	24,490	880	23,130	690
		12	0.02	24,480	940	21,600	770	20,160	690	18,140	620	17,140	480
		13	0.018	24,480	940	21,600	770	20,160	690	18,140	620	17,140	480
		14	0.016	24,480	940	21,600	770	20,160	690	18,140	620	17,140	480
16	0.012	24,480	940	21,600	770	20,160	690	18,140	620	17,140	480		
18	0.01	21,420	770	18,900	640	17,640	560	15,880	510	14,990	400		
20	0.008	18,360	660	16,200	540	15,120	480	13,610	440	12,850	340		

【注意】ご使用にあたっては、A67ページの表下の項目と注意を参照してください。【Note】 Upon usage, please refer to comments and notes below table on page A67.

EPDBEH-TH3

高能率切削条件
High efficiency cutting condition

高精度切削条件
High accuracy cutting condition

高精度切削条件はA68ページを参照してください。
Please refer to P.A68 about high accuracy cutting conditions

被削材 Work material				1		2		3		4		5	
				プリハードン鋼 Pre-hardened steels (35~45HRC)		焼入れ鋼 Hardened steels (45~55HRC)		焼入れ鋼 Hardened steels (55~65HRC)		焼入れ鋼 Hardened steels (65~68HRC)		焼入れ鋼 Hardened steels (68~72HRC)	
切り込み比率 Ratio to standard depth of cut				100%		85%		80%		65%		55%	
ボール半径RE Ball radius (mm)	外径DC Tool dia. (mm)	首下長LU Under neck length (mm)	ap (mm)	回転数 n min ⁻¹	送り速度 Vi mm/min	回転数 n min ⁻¹	送り速度 Vi mm/min	回転数 n min ⁻¹	送り速度 Vi mm/min	回転数 n min ⁻¹	送り速度 Vi mm/min	回転数 n min ⁻¹	送り速度 Vi mm/min
0.55	1.1	2	0.16	42,840	2,930	37,800	2,450	35,280	2,180	31,750	1,960	29,990	1,520
		4	0.112	42,840	2,930	37,800	2,450	35,280	2,180	31,750	1,960	29,990	1,520
		6	0.048	33,810	1,710	29,840	1,430	27,850	1,270	25,060	1,140	23,670	890
		8	0.048	31,210	1,310	27,540	1,100	25,700	980	23,130	880	21,850	680
		10	0.03	31,210	1,310	27,540	1,100	25,700	980	23,130	880	21,850	680
0.6	1.2	2	0.154	39,230	2,720	36,920	2,560	32,310	1,860	29,080	1,670	27,460	1,300
		3	0.154	39,230	2,720	36,920	2,560	32,310	1,860	29,080	1,670	27,460	1,300
		4	0.128	39,230	2,720	36,920	2,560	32,310	1,860	29,080	1,670	27,460	1,300
		6	0.088	39,230	2,720	36,920	2,560	32,310	1,860	29,080	1,670	27,460	1,300
		8	0.048	31,820	2,070	30,240	2,060	26,210	1,050	23,590	940	22,280	730
		10	0.042	29,380	1,320	27,000	1,070	24,190	870	21,770	780	20,560	610
0.7	1.4	3	0.158	33,420	2,350	29,480	1,990	27,520	1,790	24,770	1,610	23,390	1,250
		8	0.088	27,850	1,810	24,570	1,530	22,930	1,380	20,640	1,240	19,490	960
		12	0.042	25,700	1,250	22,680	1,060	21,170	950	19,050	860	17,990	670
		16	0.028	19,040	870	16,800	740	15,680	670	14,110	600	13,330	470
0.75	1.5	2	0.192	35,700	3,210	31,500	2,550	29,400	2,210	26,460	1,990	24,990	1,540
		2.5	0.192	35,700	3,210	31,500	2,550	29,400	2,210	26,460	1,990	24,990	1,540
		3	0.192	35,700	3,210	31,500	2,550	29,400	2,210	26,460	1,990	24,990	1,540
		4	0.16	35,700	3,210	31,500	2,550	29,400	2,210	26,460	1,990	24,990	1,540
		5	0.16	35,700	3,210	31,500	2,550	29,400	2,210	26,460	1,990	24,990	1,540
		6	0.16	35,700	3,210	31,500	2,550	29,400	2,210	26,460	1,990	24,990	1,540
		8	0.072	27,850	1,810	24,570	1,430	22,930	1,240	20,640	1,120	19,490	870
		10	0.072	25,700	1,670	22,680	1,320	21,170	1,140	19,050	1,030	17,990	800
		14	0.06	22,850	1,170	20,160	930	18,820	800	16,930	720	15,990	560
		16	0.03	19,040	970	16,800	770	15,680	670	14,110	600	13,330	470
0.8	1.6	4	0.23	33,110	3,340	29,210	2,850	25,320	2,130	22,780	1,920	21,520	1,490
		8	0.176	30,940	2,490	27,300	2,130	23,660	1,590	21,290	1,430	20,110	1,110
		12	0.078	27,850	2,180	24,570	1,860	21,290	1,290	19,170	1,160	18,100	900
		16	0.048	23,870	1,330	21,060	1,140	19,660	990	17,690	890	16,710	690
		20	0.032	17,680	930	15,600	800	14,560	690	13,100	620	12,380	490
0.9	1.8	4	0.29	28,730	2,410	25,350	2,010	23,660	1,700	21,290	1,530	20,110	1,190
		8	0.208	28,730	2,410	25,350	2,010	23,660	1,700	21,290	1,530	20,110	1,190
		12	0.084	23,870	1,500	21,060	1,250	19,660	1,060	17,690	960	16,710	740
		16	0.054	23,870	1,500	21,060	1,250	19,660	1,060	17,690	960	16,710	740
		20	0.036	17,680	1,050	15,600	880	14,560	740	13,100	670	12,380	520
1	2	2.5	0.32	26,780	3,620	23,630	3,050	22,050	2,650	19,850	2,380	18,740	1,850
		3	0.32	26,780	3,620	23,630	3,050	22,050	2,650	19,850	2,380	18,740	1,850
		4	0.32	26,780	3,620	23,630	3,050	22,050	2,650	19,850	2,380	18,740	1,850
		5	0.32	26,780	3,620	23,630	3,050	22,050	2,650	19,850	2,380	18,740	1,850
		6	0.32	26,780	3,210	23,630	2,690	22,050	2,380	19,850	2,140	18,740	1,670
		8	0.224	26,780	3,210	23,630	2,690	22,050	2,380	19,850	2,140	18,740	1,670
		10	0.168	24,990	2,700	22,050	2,250	19,110	1,470	17,200	1,320	16,240	1,030
		12	0.096	22,490	2,430	19,850	2,050	17,200	1,320	15,480	1,190	14,620	930
		13	0.096	22,490	2,430	19,850	2,020	15,880	1,020	14,290	920	13,500	710
		14	0.096	22,490	2,110	18,430	1,630	15,880	1,020	14,290	920	13,500	710
		16	0.096	20,890	1,350	18,430	1,470	15,880	910	14,290	820	13,500	640
		18	0.072	19,280	1,250	18,430	1,350	15,880	910	14,290	820	13,500	640
		20	0.06	19,280	1,250	18,430	1,130	15,880	910	14,290	820	13,500	640
		22	0.04	15,170	930	13,390	770	14,990	820	13,500	730	12,750	570
25	0.04	14,280	870	12,600	730	14,110	770	12,700	690	12,000	540		
30	0.024	14,280	870	12,600	730	14,110	770	12,700	690	12,000	540		
35	0.02	12,500	720	11,030	600	10,290	530	9,260	470	8,750	370		
40	0.018	10,710	620	9,450	510	8,820	450	7,940	410	7,500	320		

超硬ボールエンドミル

ボールエンドミル

被削材 Work material				1		2		3		4		5	
				プリハードン鋼 Pre-hardened steels (35~45HRC)		焼入れ鋼 Hardened steels (45~55HRC)		焼入れ鋼 Hardened steels (55~65HRC)		焼入れ鋼 Hardened steels (65~68HRC)		焼入れ鋼 Hardened steels (68~72HRC)	
切り込み比率 Ratio to standard depth of cut				100%		85%		80%		65%		55%	
ボール半径RE Ball radius (mm)	外径DC Tool dia. (mm)	首下長LU Under neck length (mm)	ap (mm)	回転数 n min ⁻¹	送り速度 Vf mm/min	回転数 n min ⁻¹	送り速度 Vf mm/min	回転数 n min ⁻¹	送り速度 Vf mm/min	回転数 n min ⁻¹	送り速度 Vf mm/min	回転数 n min ⁻¹	送り速度 Vf mm/min
1.25	2.5	6	0.4	23,590	3,800	20,810	3,090	19,430	2,530	17,480	2,280	16,610	1,820
		10	0.272	23,590	3,800	20,810	3,090	19,430	2,530	17,480	2,280	16,610	1,820
		15	0.12	18,400	2,130	16,230	2,020	15,150	1,420	13,640	1,280	12,950	1,020
		20	0.096	16,980	1,640	16,230	1,450	13,990	1,090	12,590	980	11,960	790
		25	0.078	16,980	1,480	14,990	1,200	13,990	980	12,590	880	11,960	710
		30	0.044	12,580	1,150	11,100	930	10,360	770	9,320	690	8,860	550
1.5	3	6	0.48	20,400	4,100	18,000	3,400	16,800	3,020	15,120	2,720	14,360	2,180
		8	0.48	20,400	4,100	18,000	3,400	16,800	3,020	15,120	2,720	14,360	2,180
		10	0.336	20,400	4,100	18,000	3,400	16,800	3,020	15,120	2,720	14,360	2,180
		13	0.252	19,040	3,060	16,800	2,540	15,680	2,260	14,110	2,030	13,410	1,630
		16	0.252	19,040	2,760	16,800	2,290	14,560	1,890	13,100	1,700	12,450	1,360
		20	0.144	15,910	1,920	14,040	1,590	12,100	1,310	10,890	1,180	10,340	940
		25	0.096	15,910	1,920	14,040	1,590	12,100	1,310	10,890	1,180	10,340	940
		30	0.096	14,690	1,770	12,960	1,470	12,100	1,310	10,890	1,180	10,340	940
1.75	3.5	10	0.328	15,190	2,750	13,410	2,240	12,510	1,830	11,260	1,650	10,700	1,320
		15	0.288	15,190	2,750	13,410	2,240	12,510	1,830	11,260	1,650	10,700	1,320
		25	0.168	12,620	1,710	11,140	1,390	10,400	1,140	9,360	1,030	8,890	820
		35	0.072	12,620	1,710	11,140	1,390	10,400	1,140	9,360	1,030	8,890	820
		45	0.072	9,350	1,200	8,250	980	7,700	800	6,930	720	6,580	580
2	4	8	0.48	14,660	3,960	12,940	3,300	12,080	2,900	10,870	2,610	10,320	2,090
		10	0.48	14,660	3,960	12,940	3,300	12,080	2,900	10,870	2,610	10,320	2,090
		12	0.384	14,660	3,960	12,940	3,300	12,080	2,900	10,870	2,610	10,320	2,090
		13	0.384	14,660	3,960	12,940	3,300	12,080	2,900	10,870	2,610	10,320	2,090
		16	0.336	14,660	3,960	12,940	3,300	12,080	2,900	10,870	2,610	10,320	2,090
		20	0.336	12,710	2,750	11,210	2,290	10,470	2,010	9,420	1,810	8,950	1,450
		25	0.192	11,440	2,220	10,090	2,160	9,420	1,630	8,480	1,460	8,050	1,170
		30	0.128	10,560	1,710	9,320	1,430	8,690	1,250	7,820	1,130	7,430	900
		35	0.08	10,560	1,710	9,320	1,430	8,690	1,250	7,820	1,130	7,430	900
		40	0.08	10,560	1,710	9,320	1,430	8,690	1,250	7,820	1,130	7,430	900
		45	0.08	7,820	1,200	6,900	1,000	6,440	880	5,800	790	5,510	630
2.5	5	10	0.584	10,710	3,210	9,450	2,840	8,820	2,380	7,940	2,140	7,540	1,710
		20	0.42	10,710	3,210	9,450	2,840	8,820	2,380	7,940	2,140	7,540	1,710
		25	0.42	9,950	2,980	8,780	2,630	8,190	2,210	7,370	1,990	7,000	1,590
		30	0.24	8,950	2,690	7,900	2,370	7,370	1,990	6,630	1,790	6,300	1,430
		40	0.16	8,260	1,490	7,290	1,310	6,800	1,100	6,120	990	5,820	790
3	6	12	0.48	11,480	4,250	10,130	3,460	9,450	2,840	8,510	2,550	8,080	2,040
		20	0.4	10,840	3,730	9,560	3,030	8,930	2,490	8,030	2,240	7,630	1,790
		30	0.336	8,840	2,120	7,800	2,030	7,280	1,570	6,550	1,410	6,220	1,130
		50	0.12	7,340	1,590	6,480	1,400	6,050	1,180	5,440	1,060	5,170	850
4	8	24	0.5	8,750	3,420	7,550	2,600	7,100	2,450	6,390	1,850	5,750	1,270
5	10	30	0.6	7,000	3,000	6,050	2,250	5,680	2,130	5,110	1,610	4,600	1,030
6	12	36	0.8	5,850	2,600	5,050	1,980	4,720	1,840	4,250	1,440	3,820	880

※(1) apは被削材グループ1での目安を示しています。その他のグループの場合は、上表の切り込み比率を目安に調整してください。
 ※(2) リブ加工や止まり溝など、切りくずがつまりやすい切削の場合、切り込み設定は基本切り込み率に切り込み比率をかけて算出した切り込み量を、さらにその80%まで小さくして使用してください。
 ※(3) aeの設定はap×切り込み比率×3~5倍を目安に調整してください。仕上げ加工を行う場合、理論カスプハイトを計算し設定してください。

※(1) ap is shown as the criteria for Group 1 workpieces. For other groups, adjust the cutting depth according to the cutting depth factors in the above table.
 ※(2) When performing cutting where cutting chips may cause clogging, such as for rib cutting, blind grooves, etc., cutting depth setting should be set by multiplying a cutting depth factor to calculate the cutting depth amount, and this amount should then be reduced to 80% of the calculated value.
 ※(3) Adjust by setting ae to (3 to 5) × (ap) × (cutting depth ratio). When performing finishing processing, calculate the theoretical cusp height and set accordingly.

【切り込み設定例】 EPDBEH2020-10-TH3の工具で焼入れ鋼(50HRC)をリブ溝等高線切削する場合、
 切り込み=0.168(ap)×0.85(焼入れ鋼グループ2の切り込み比率)×0.8(閉鎖域の切削)=0.11mm
 Cutting depth setting example: When cutting rib groove contours in hardened steel (50HRC) using an EPDBEH2020-10-TH3 tool:
 Cutting depth = 0.168 (ap) × 0.85 (cutting depth factor for Group 2 hardened steel) × 0.8 (for closed-area cutting) = 0.11mm

【注意】 ①基本的にはDry(エアブロー)切削を推奨しますが、被削材、加工形状に合わせて、適切なクーラントを使用してください。
 ②この標準切削条件表は切削条件の目安を示すものです。実際の加工では加工形状、目的、使用機械等により条件を調整してください。
 ③機械の回転数が足りない場合は、回転数と送り速度を同じ比率で下げてください。

【Note】 ① Although basically dry (air blow) cutting is recommended, please use appropriate coolant according to the work material and machining shape.
 ② These Recommended Cutting Conditions indicate only the rule of a thumb for the cutting conditions. In actual machining, the condition should be adjusted according to the machining shape, purpose and the machine type.
 ③ If the rpm of the machine is low, lower the feed rate also to put the rpm and feed rate in the same ratio.



標準切削条件表

Recommended cutting conditions

高能率切削条件

高精度切削条件

High accuracy cutting condition

EPDBEH-TH3

高能率切削条件はA64ページを参照してください。Please refer to P.A64 about high efficiency cutting conditions

被削材 Work material				1		2		3		4		5	
				プリハードン鋼 Pre-hardened steels (35~45HRC)		焼入れ鋼 Hardened steels (45~55HRC)		焼入れ鋼 Hardened steels (55~65HRC)		焼入れ鋼 Hardened steels (65~68HRC)		焼入れ鋼 Hardened steels (68~72HRC)	
切り込み比率 Ratio to standard depth of cut				100%		85%		80%		65%		55%	
ボール半径RE Ball radius (mm)	外径DC Tool dia. (mm)	首下長LU Under neck length (mm)	ap (mm)	回転数 n min ⁻¹	送り速度 Vf mm/min	回転数 n min ⁻¹	送り速度 Vf mm/min	回転数 n min ⁻¹	送り速度 Vf mm/min	回転数 n min ⁻¹	送り速度 Vf mm/min	回転数 n min ⁻¹	送り速度 Vf mm/min
0.05	0.1	0.08	0.003	50,000	230	50,000	200	50,000	190	45,000	170	42,500	130
		0.2	0.003	50,000	230	50,000	200	50,000	190	45,000	170	42,500	130
		0.3	0.002	50,000	230	50,000	200	50,000	190	45,000	170	42,500	130
		0.5	0.002	50,000	230	50,000	200	50,000	190	45,000	170	42,500	130
0.075	0.15	0.12	0.007	50,000	280	46,000	230	42,000	180	37,500	160	35,500	120
		0.3	0.007	50,000	280	46,000	230	42,000	180	37,500	160	35,500	120
		0.5	0.006	50,000	280	46,000	230	42,000	180	37,500	160	35,500	120
		0.75	0.005	50,000	280	46,000	230	42,000	180	37,500	160	35,500	120
0.1	0.2	1	0.003	46,000	230	41,400	190	37,800	150	33,750	130	31,950	100
		0.15	0.012	50,000	330	45,500	270	42,000	210	37,800	190	35,700	150
		0.3	0.012	50,000	330	45,500	270	42,000	210	37,800	190	35,700	150
		0.5	0.012	50,000	330	45,500	270	42,000	210	37,800	190	35,700	150
		0.75	0.01	50,000	330	45,500	270	42,000	210	37,800	190	35,700	150
		1	0.009	50,000	330	45,500	270	42,000	210	37,800	190	35,700	150
		1.25	0.006	45,900	270	40,500	220	37,800	170	34,020	150	32,130	120
		1.5	0.006	45,900	270	40,500	220	37,800	170	34,020	150	32,130	120
0.15	0.3	2	0.005	45,900	270	40,500	220	37,800	170	34,020	150	32,130	120
		2.5	0.004	40,800	210	36,000	170	33,600	130	30,240	120	28,560	90
		3	0.002	40,800	210	36,000	170	33,600	130	30,240	120	28,560	90
		0.25	0.016	50,000	450	45,000	380	42,000	340	37,800	300	35,700	240
		0.5	0.016	50,000	450	45,000	380	42,000	340	37,800	300	35,700	240
		0.75	0.014	50,000	450	45,000	380	42,000	340	37,800	300	35,700	240
		1	0.013	50,000	450	45,000	380	42,000	340	37,800	300	35,700	240
		1.25	0.011	50,000	450	45,000	380	42,000	340	37,800	300	35,700	240
		1.5	0.01	50,000	450	45,000	380	42,000	340	37,800	300	35,700	240
		2	0.007	45,900	370	40,500	310	37,800	270	34,020	250	32,130	190
0.2	0.4	2.5	0.006	45,900	370	40,500	310	37,800	270	34,020	250	32,130	190
		3	0.005	45,900	370	40,500	310	37,800	270	34,020	250	32,130	190
		3.5	0.003	36,720	260	29,400	210	26,400	180	23,760	160	22,440	130
		4	0.002	36,720	260	29,400	210	26,400	180	23,760	160	22,440	130
		0.3	0.034	40,800	450	36,000	360	33,600	340	30,240	300	28,560	240
		0.5	0.034	40,800	450	36,000	360	33,600	340	30,240	300	28,560	240
		0.75	0.034	40,800	450	36,000	360	33,600	340	30,240	300	28,560	240
		1	0.032	40,800	450	36,000	360	33,600	340	30,240	300	28,560	240
		1.5	0.027	40,800	450	36,000	360	33,600	340	30,240	300	28,560	240
		2	0.022	40,800	450	36,000	360	33,600	340	30,240	300	28,560	240
0.25	0.5	2.5	0.013	36,720	360	32,400	290	30,240	270	27,220	250	25,700	190
		3	0.009	36,720	360	32,400	290	30,240	270	27,220	250	25,700	190
		3.5	0.006	36,720	360	32,400	290	30,240	270	27,220	250	25,700	190
		4	0.004	36,720	360	32,400	290	30,240	270	27,220	250	25,700	190
		4.5	0.003	32,640	310	28,800	250	26,880	230	24,190	210	22,850	160
		5	0.002	32,640	310	28,800	250	26,880	230	24,190	210	22,850	160
		0.35	0.036	34,000	610	30,000	540	28,000	480	25,200	430	23,800	330
		0.75	0.036	34,000	610	30,000	540	28,000	480	25,200	430	23,800	330
		1	0.036	34,000	610	30,000	540	28,000	480	25,200	430	23,800	330
		1.5	0.032	34,000	610	30,000	540	28,000	480	25,200	430	23,800	330
0.3	0.6	2	0.028	34,000	610	30,000	540	28,000	480	25,200	430	23,800	330
		2.5	0.026	30,600	500	27,000	440	25,200	390	22,680	350	21,420	270
		3	0.024	30,600	500	27,000	440	25,200	390	22,680	350	21,420	270
		4	0.016	30,600	500	27,000	440	25,200	390	22,680	350	21,420	270
		5	0.014	30,600	500	27,000	440	25,200	390	22,680	350	21,420	270
		5.5	0.006	27,200	420	24,000	370	22,400	320	20,160	290	19,040	230
		6	0.005	27,200	420	24,000	370	22,400	320	20,160	290	19,040	230
		7	0.004	27,200	420	24,000	370	22,400	320	20,160	290	19,040	230
0.3	0.6	8	0.003	27,200	420	24,000	370	22,400	320	20,160	290	19,040	230
		0.4	0.04	34,000	880	30,000	720	28,000	560	25,200	500	23,800	390
		0.75	0.04	34,000	880	30,000	720	28,000	560	25,200	500	23,800	390

超硬ボールエンドミル

被削材 Work material				1		2		3		4		5	
				プリハードン鋼 Pre-hardened steels (35~45HRC)		焼入れ鋼 Hardened steels (45~55HRC)		焼入れ鋼 Hardened steels (55~65HRC)		焼入れ鋼 Hardened steels (65~68HRC)		焼入れ鋼 Hardened steels (68~72HRC)	
切り込み比率 Ratio to standard depth of cut				100%		85%		80%		65%		55%	
ボール半径RE Ball radius (mm)	外径DC Tool dia. (mm)	首下長LU Under neck length (mm)	ap (mm)	回転数 n min ⁻¹	送り速度 Vf mm/min	回転数 n min ⁻¹	送り速度 Vf mm/min	回転数 n min ⁻¹	送り速度 Vf mm/min	回転数 n min ⁻¹	送り速度 Vf mm/min	回転数 n min ⁻¹	送り速度 Vf mm/min
0.3	0.6	1	0.04	34,000	880	30,000	720	28,000	560	25,200	500	23,800	390
		1.5	0.038	34,000	880	30,000	720	28,000	560	25,200	500	23,800	390
		2	0.034	34,000	880	30,000	720	28,000	560	25,200	500	23,800	390
		2.5	0.03	34,000	880	30,000	720	28,000	560	25,200	500	23,800	390
		3	0.027	34,000	880	30,000	720	28,000	560	25,200	500	23,800	390
		3.5	0.023	30,600	760	27,000	620	25,200	480	22,680	430	21,420	340
		4	0.019	30,600	760	27,000	620	25,200	480	22,680	430	21,420	340
		4.5	0.018	30,600	720	27,000	580	25,200	450	22,680	410	21,420	320
		5	0.016	30,600	720	27,000	580	25,200	450	22,680	410	21,420	320
		5.5	0.014	30,600	720	27,000	580	25,200	450	22,680	410	21,420	320
		6	0.012	30,600	720	27,000	580	25,200	450	22,680	410	21,420	320
		7	0.006	27,200	600	24,000	490	22,400	380	20,160	340	19,040	270
8	0.006	27,200	600	24,000	490	22,400	380	20,160	340	19,040	270		
9	0.005	27,200	600	24,000	490	22,400	380	20,160	340	19,040	270		
10	0.004	23,800	530	21,000	430	19,600	330	17,640	300	16,660	230		
12	0.003	20,400	420	18,000	350	16,800	270	15,120	240	14,280	190		
0.35	0.7	0.45	0.049	34,000	980	30,000	810	28,000	660	25,200	590	23,800	460
		2	0.049	34,000	980	30,000	810	28,000	660	25,200	590	23,800	460
		4	0.027	30,600	840	27,000	690	25,200	560	22,680	510	21,420	400
		6	0.022	30,600	790	27,000	650	25,200	540	22,680	480	21,420	370
		8	0.008	27,200	630	24,000	520	22,400	420	20,160	380	19,040	300
0.4	0.8	0.5	0.08	34,000	1,090	30,000	900	28,000	780	25,200	710	23,800	550
		1	0.08	34,000	1,090	30,000	900	28,000	780	25,200	710	23,800	550
		1.5	0.08	34,000	1,090	30,000	900	28,000	780	25,200	710	23,800	550
		2	0.064	34,000	1,090	30,000	900	28,000	780	25,200	710	23,800	550
		2.5	0.06	34,000	1,090	30,000	900	28,000	780	25,200	710	23,800	550
		3	0.055	34,000	1,090	30,000	900	28,000	780	25,200	710	23,800	550
		4	0.045	34,000	1,090	30,000	900	28,000	780	25,200	710	23,800	550
		5	0.036	30,600	880	27,000	730	25,200	640	22,680	570	21,420	450
		6	0.026	30,600	880	27,000	730	25,200	640	22,680	570	21,420	450
		8	0.016	27,200	780	24,000	650	22,400	560	20,160	510	19,040	400
10	0.008	27,200	740	24,000	610	22,400	530	20,160	480	19,040	370		
12	0.006	27,200	740	24,000	610	22,400	530	20,160	480	19,040	370		
0.45	0.9	0.6	0.072	32,300	1,220	28,500	1,000	26,600	890	23,940	800	22,610	620
		2	0.072	32,300	1,220	28,500	1,000	26,600	890	23,940	800	22,610	620
		4	0.046	32,300	1,220	28,500	1,000	26,600	890	23,940	800	22,610	620
		6	0.034	29,070	980	25,650	810	23,940	720	21,550	650	20,350	510
		8	0.024	25,840	880	22,800	720	21,280	640	19,150	580	18,090	450
0.5	1	0.8	0.09	30,600	1,380	27,000	1,130	25,200	1,010	22,680	910	21,420	710
		1.5	0.09	30,600	1,380	27,000	1,130	25,200	1,010	22,680	910	21,420	710
		2	0.08	30,600	1,380	27,000	1,130	25,200	1,010	22,680	910	21,420	710
		2.5	0.08	30,600	1,380	27,000	1,130	25,200	1,010	22,680	910	21,420	710
		3	0.08	30,600	1,380	27,000	1,130	25,200	1,010	22,680	910	21,420	710
		4	0.056	30,600	1,380	27,000	1,130	25,200	1,010	22,680	910	21,420	710
		5	0.048	30,600	1,380	27,000	1,130	25,200	1,010	22,680	910	21,420	710
		6	0.032	27,540	1,120	24,300	920	22,680	820	20,410	730	19,280	570
		7	0.032	27,540	1,120	24,300	920	22,680	820	20,410	730	19,280	570
		8	0.032	27,540	1,120	24,300	920	22,680	820	20,410	730	19,280	570
		9	0.024	27,540	1,120	24,300	920	22,680	820	20,410	730	19,280	570
		10	0.02	27,540	1,120	24,300	920	22,680	820	20,410	730	19,280	570
		12	0.01	24,480	940	21,600	770	20,160	690	18,140	620	17,140	480
		13	0.009	24,480	940	21,600	770	20,160	690	18,140	620	17,140	480
		14	0.008	24,480	940	21,600	770	20,160	690	18,140	620	17,140	480
16	0.006	24,480	940	21,600	770	20,160	690	18,140	620	17,140	480		
18	0.005	21,420	770	18,900	640	17,640	560	15,880	510	14,990	400		
20	0.004	18,360	660	16,200	540	15,120	480	13,610	440	12,850	340		

[注意] ご使用にあたっては、A71ページの表下の項目と注意を参照してください。 **[Note]** Upon usage, please refer to comments and notes below table on page A71.

EPDBEH-TH3

高能率切削条件
High efficiency cutting condition

高精度切削条件
High accuracy cutting condition

高能率切削条件はA64ページを参照してください。
Please refer to P.A64 about high efficiency cutting conditions.

超硬ボールエンドミル
ボールエンドミル

被削材 Work material				1		2		3		4		5	
				プリハードン鋼 Pre-hardened steels (35~45HRC)		焼入れ鋼 Hardened steels (45~55HRC)		焼入れ鋼 Hardened steels (55~65HRC)		焼入れ鋼 Hardened steels (65~68HRC)		焼入れ鋼 Hardened steels (68~72HRC)	
切り込み比率 Ratio to standard depth of cut				100%		85%		80%		65%		55%	
ボール半径RE Ball radius (mm)	外径DC Tool dia. (mm)	首下長LU Under neck length (mm)	ap (mm)	回転数 n min ⁻¹	送り速度 Vf mm/min	回転数 n min ⁻¹	送り速度 Vf mm/min	回転数 n min ⁻¹	送り速度 Vf mm/min	回転数 n min ⁻¹	送り速度 Vf mm/min	回転数 n min ⁻¹	送り速度 Vf mm/min
0.55	1.1	2	0.08	28,560	1,300	25,200	1,090	23,520	970	21,170	870	19,990	680
		4	0.056	28,560	1,300	25,200	1,090	23,520	970	21,170	870	19,990	680
		6	0.032	26,010	1,090	22,950	920	21,420	810	19,280	730	18,210	570
		8	0.032	26,010	1,090	22,950	920	21,420	810	19,280	730	18,210	570
		10	0.02	26,010	1,090	22,950	920	21,420	810	19,280	730	18,210	570
0.6	1.2	2	0.077	26,150	1,210	23,080	1,000	21,540	890	19,380	800	18,310	620
		3	0.077	26,150	1,210	23,080	1,000	21,540	890	19,380	800	18,310	620
		4	0.064	26,150	1,210	23,080	1,000	21,540	890	19,380	800	18,310	620
		6	0.048	26,150	1,210	23,080	1,000	21,540	890	19,380	800	18,310	620
		8	0.032	24,480	1,130	21,600	950	20,160	810	18,140	730	17,140	560
		10	0.028	24,480	1,100	21,600	860	20,160	730	18,140	650	17,140	510
0.7	1.4	3	0.088	21,420	1,160	18,900	980	17,640	880	15,880	790	14,990	620
		8	0.044	21,420	1,160	18,900	980	17,640	880	15,880	790	14,990	620
		12	0.028	21,420	1,040	18,900	890	17,640	790	15,880	720	14,990	560
		16	0.014	19,040	870	16,800	740	15,680	670	14,110	600	13,330	470
0.75	1.5	2	0.096	23,800	1,430	21,000	1,130	19,600	980	17,640	880	16,660	690
		2.5	0.096	23,800	1,430	21,000	1,130	19,600	980	17,640	880	16,660	690
		3	0.096	23,800	1,430	21,000	1,130	19,600	980	17,640	880	16,660	690
		4	0.08	23,800	1,430	21,000	1,130	19,600	980	17,640	880	16,660	690
		5	0.08	23,800	1,430	21,000	1,130	19,600	980	17,640	880	16,660	690
		6	0.08	23,800	1,430	21,000	1,130	19,600	980	17,640	880	16,660	690
		8	0.048	21,420	1,160	18,900	920	17,640	790	15,880	720	14,990	560
		10	0.048	21,420	1,160	18,900	920	17,640	790	15,880	720	14,990	560
		12	0.048	21,420	1,160	18,900	920	17,640	790	15,880	720	14,990	560
		14	0.04	19,040	970	16,800	770	15,680	670	14,110	600	13,330	470
		16	0.015	19,040	970	16,800	770	15,680	670	14,110	600	13,330	470
0.8	1.6	4	0.11	22,100	1,370	19,500	1,170	18,200	1,020	16,380	920	15,470	710
		8	0.088	22,100	1,370	19,500	1,170	18,200	1,020	16,380	920	15,470	710
		12	0.052	19,890	1,110	17,550	950	16,380	830	14,740	740	13,920	580
		16	0.032	19,890	1,110	17,550	950	16,380	830	14,740	740	13,920	580
		20	0.016	17,680	930	15,600	800	14,560	690	13,100	620	12,380	490
0.9	1.8	4	0.147	22,100	1,550	19,500	1,290	18,200	1,090	16,380	980	15,470	760
		8	0.104	22,100	1,550	19,500	1,290	18,200	1,090	16,380	980	15,470	760
		12	0.056	19,890	1,250	17,550	1,040	16,380	890	14,740	800	13,920	620
		16	0.036	19,890	1,250	17,550	1,040	16,380	890	14,740	800	13,920	620
		20	0.018	17,680	1,050	15,600	880	14,560	740	13,100	670	12,380	520
1	2	2.5	0.16	17,850	1,610	15,750	1,360	14,700	1,180	13,230	1,060	12,500	820
		3	0.16	17,850	1,610	15,750	1,360	14,700	1,180	13,230	1,060	12,500	820
		4	0.16	17,850	1,610	15,750	1,360	14,700	1,180	13,230	1,060	12,500	820
		5	0.16	17,850	1,610	15,750	1,360	14,700	1,180	13,230	1,060	12,500	820
		6	0.16	17,850	1,430	15,750	1,200	14,700	1,060	13,230	950	12,500	740
		8	0.112	17,850	1,430	15,750	1,200	14,700	1,060	13,230	950	12,500	740
		10	0.112	17,850	1,290	15,750	1,070	14,700	940	13,230	850	12,500	660
		12	0.064	16,070	1,160	14,180	960	13,230	850	11,910	760	11,250	590
		13	0.064	16,070	1,160	14,180	960	13,230	850	11,910	760	11,250	590
		14	0.064	16,070	1,160	14,180	960	13,230	850	11,910	760	11,250	590
		16	0.064	16,070	1,040	14,180	870	13,230	760	11,910	690	11,250	530
		18	0.048	16,070	1,040	14,180	870	13,230	760	11,910	690	11,250	530
		20	0.04	16,070	1,040	14,180	870	13,230	760	11,910	690	11,250	530
		22	0.034	15,170	930	13,390	770	12,500	680	11,250	610	10,620	480
		25	0.028	14,280	870	12,600	730	11,760	640	10,580	580	10,000	450
30	0.012	14,280	870	12,600	730	11,760	640	10,580	580	10,000	450		
35	0.01	12,500	720	11,030	600	10,290	530	9,260	470	8,750	370		
40	0.008	10,710	620	9,450	510	8,820	450	7,940	410	7,500	320		

被削材 Work material				1		2		3		4		5	
				プリハードン鋼 Pre-hardened steels (35~45HRC)		焼入れ鋼 Hardened steels (45~55HRC)		焼入れ鋼 Hardened steels (55~65HRC)		焼入れ鋼 Hardened steels (65~68HRC)		焼入れ鋼 Hardened steels (68~72HRC)	
切り込み比率 Ratio to standard depth of cut				100%		85%		80%		65%		55%	
ボール半径RE Ball radius (mm)	外径DC Tool dia. (mm)	首下長LU Under neck length (mm)	ap (mm)	回転数 n min ⁻¹	送り速度 Vf mm/min	回転数 n min ⁻¹	送り速度 Vf mm/min	回転数 n min ⁻¹	送り速度 Vf mm/min	回転数 n min ⁻¹	送り速度 Vf mm/min	回転数 n min ⁻¹	送り速度 Vf mm/min
1.25	2.5	6	0.2	15,730	1,690	13,880	1,370	12,950	1,130	11,660	1,010	11,070	810
		10	0.136	15,730	1,690	13,880	1,370	12,950	1,130	11,660	1,010	11,070	810
		15	0.08	14,150	1,370	12,490	1,110	11,660	910	10,490	820	9,970	660
		20	0.064	14,150	1,370	12,490	1,110	11,660	910	10,490	820	9,970	660
		25	0.052	14,150	1,230	12,490	1,000	11,660	820	10,490	740	9,970	590
1.5	3	6	0.24	13,600	1,820	12,000	1,510	11,200	1,340	10,080	1,210	9,580	970
		8	0.24	13,600	1,820	12,000	1,510	11,200	1,340	10,080	1,210	9,580	970
		10	0.168	13,600	1,820	12,000	1,510	11,200	1,340	10,080	1,210	9,580	970
		13	0.168	13,600	1,820	12,000	1,510	11,200	1,340	10,080	1,210	9,580	970
		16	0.168	13,600	1,640	12,000	1,360	11,200	1,210	10,080	1,090	9,580	870
		20	0.096	12,240	1,480	10,800	1,230	10,080	1,090	9,070	980	8,620	780
		25	0.064	12,240	1,480	10,800	1,230	10,080	1,090	9,070	980	8,620	780
1.75	3.5	10	0.216	11,690	1,760	10,310	1,430	9,630	1,180	8,660	1,060	8,230	850
		15	0.192	11,690	1,760	10,310	1,430	9,630	1,180	8,660	1,060	8,230	850
		25	0.112	10,520	1,430	9,280	1,160	8,660	950	7,800	860	7,410	680
		35	0.072	10,520	1,430	9,280	1,160	8,660	950	7,800	860	7,410	680
		45	0.058	9,350	1,200	8,250	980	7,700	800	6,930	720	6,580	580
2	4	8	0.32	9,780	1,760	8,630	1,470	8,050	1,290	7,250	1,160	6,880	930
		10	0.32	9,780	1,760	8,630	1,470	8,050	1,290	7,250	1,160	6,880	930
		12	0.256	9,780	1,760	8,630	1,470	8,050	1,290	7,250	1,160	6,880	930
		13	0.256	9,780	1,760	8,630	1,470	8,050	1,290	7,250	1,160	6,880	930
		16	0.224	9,780	1,760	8,630	1,470	8,050	1,290	7,250	1,160	6,880	930
		20	0.224	9,780	1,760	8,630	1,470	8,050	1,290	7,250	1,160	6,880	930
		25	0.128	8,800	1,430	7,760	1,190	7,250	1,040	6,520	940	6,190	750
		30	0.128	8,800	1,430	7,760	1,190	7,250	1,040	6,520	940	6,190	750
		35	0.08	8,800	1,430	7,760	1,190	7,250	1,040	6,520	940	6,190	750
		40	0.08	8,800	1,430	7,760	1,190	7,250	1,040	6,520	940	6,190	750
		45	0.064	7,820	1,200	6,900	1,000	6,440	880	5,800	790	5,510	630
2.5	5	10	0.392	7,650	1,530	6,750	1,350	6,300	1,130	5,670	1,020	5,390	820
		20	0.28	7,650	1,530	6,750	1,350	6,300	1,130	5,670	1,020	5,390	820
		25	0.28	7,650	1,530	6,750	1,350	6,300	1,130	5,670	1,020	5,390	820
		30	0.16	6,890	1,380	6,080	1,220	5,670	1,020	5,100	920	4,850	740
		40	0.16	6,890	1,240	6,080	1,090	5,670	920	5,100	830	4,850	660
3	6	12	0.48	7,650	1,890	6,750	1,540	6,300	1,260	5,670	1,130	5,390	910
		20	0.4	7,230	1,660	6,380	1,350	5,950	1,110	5,360	990	5,090	800
		30	0.336	6,800	1,360	6,000	1,200	5,600	1,010	5,040	910	4,790	730
		50	0.12	6,120	1,100	5,400	970	5,040	820	4,540	730	4,310	590
4	8	24	0.5	6,400	1,690	5,720	1,320	4,180	1,170	3,960	870	3,760	700
5	10	30	0.6	5,100	1,460	4,510	1,130	3,520	1,000	3,190	770	3,030	620
6	12	36	0.8	4,200	1,240	3,850	1,000	2,640	880	2,640	660	2,510	530

- ※(1) apは被削材グループ1での目安を示しています。その他のグループの場合は、上表の切り込み比率を目安に調整してください。
- ※(2) リブ加工や止まり溝など、切りくずがつまりやすい切削の場合、切り込み設定は基本切り込みで切り込み比率をかけて算出した切り込み量を、さらにその80%まで小さくして使用してください。
- ※(3) aeの設定はap×切り込み比率×3~5倍を目安に調整してください。仕上げ加工を行う場合、理論カスプハイトを計算し設定してください。
- ※(1) ap is shown as the criteria for Group 1 workpieces. For other groups, adjust the cutting depth according to the cutting depth factors in the above table.
- ※(2) When performing cutting where cutting chips may cause clogging, such as for rib cutting, blind grooves, etc., cutting depth setting should be set by multiplying a cutting depth factor to calculate the cutting depth amount, and this amount should then be reduced to 80% of the calculated value.
- ※(3) Adjust by setting ae to (3 to 5) × (ap) × (cutting depth ratio). When performing finishing processing, calculate the theoretical cusp height and set accordingly.

【切り込み設定例】 EPDBEH2020-10-TH3の工具で焼入れ鋼(50HRC)をリブ溝等高線切削する場合、
 切り込み=0.112(ap)×0.85(焼入れ鋼グループ2の切り込み比率)×0.8(閉鎖域の切削)=0.076mm
 Cutting depth setting example: When cutting rib groove contours in hardened steel (50HRC) using an EPDBEH2020-10-TH3 tool:
 Cutting depth = 0.112 (ap) × 0.85 (cutting depth factor for Group 2 hardened steel) × 0.8 (for closed-area cutting) = 0.076mm

- 【注意】** ① 基本的にはDry(エアブロー)切削を推奨しますが、被削材、加工形状に合わせて、適切なクーラントを使用してください。
- ② この標準切削条件表は切削条件の目安を示すものです。実際の加工では加工形状、目的、使用機械等により条件を調整してください。
- ③ 機械の回転数が足りない場合は、回転数と送り速度を同じ比率で下げてください。
- 【Note】** ① Although basically dry (air blow) cutting is recommended, please use appropriate coolant according to the work material and machining shape.
- ② These Recommended Cutting Conditions indicate only the rule of a thumb for the cutting conditions. In actual machining, the condition should be adjusted according to the machining shape, purpose and the machine type.
- ③ If the rpm of the machine is low, lower the feed rate also to put the rpm and feed rate in the same ratio.

エポックディープボールエボリューション **ATHCoating**

ストレートネック Straight Neck



	RE公差 RE tolerance	RE ≤ 0.25 : ±0.003 0.25 < RE : ±0.005		(mm)
--	----------------------	--	--	------

刃先と首形状の改良によりタオレを抑制し高精度加工を実現。
ATH&PNコーティングの採用で更なる長寿命加工。
Improved flute tip shape and neck shape suppresses warping to enable high-accuracy cutting. Use of ATH and PN coatings further extends tool life.

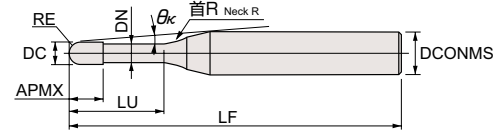

切削条件表 **A78**
Cutting Conditions



EPDBE2-ATH

商品コード Item code	在庫 Stock ATH	寸法 Size(mm)									干渉角度 Interference angle θ_k	勾配角に対する実有効首下長 Effective under neck length with respect to draft angle					希望小売 価格(円) Suggested retail price (¥)
		ボール半径 Ball radius RE	外径 Tool dia. DC	首下長 Under Neck length LU	刃長 Flute length APMX	首径 Neck dia. DN	全長 Overall length LF	シャンク径 Shank dia. DCONMS	首R Neck R	0.5° 1° 1.5° 2° 3°							
										0.5°		1°	1.5°	2°	3°		
EPDBE2001-0.2-ATH	●	0.05	0.1	0.2	0.08	0.08	45	4	1	11.76	0.35	0.37	0.39	0.41	0.44	16,290	
EPDBE2001-0.3-ATH	●			0.3	0.08	0.08	45	4	1	11.64	0.46	0.48	0.50	0.52	0.57	16,720	
EPDBE2001-0.5-ATH	●			0.5	0.08	0.08	45	4	1	11.40	0.67	0.70	0.73	0.76	0.81	18,110	
EPDBE2002-0.5-ATH	●	0.1	0.2	0.5	0.15	0.17	50	4	1	11.42	0.70	0.72	0.75	0.77	0.82	11,680	
EPDBE2002-0.75-ATH	●			0.75	0.15	0.17	50	4	1	11.13	0.96	0.99	1.02	1.05	1.11	11,680	
EPDBE2002-1-ATH	●			1	0.15	0.17	50	4	1	10.86	1.22	1.26	1.30	1.33	1.39	11,680	
EPDBE2002-1.25-ATH	●			1.25	0.15	0.17	50	4	1	10.60	1.48	1.52	1.57	1.61	1.72	12,650	
EPDBE2002-1.5-ATH	●			1.5	0.15	0.17	50	4	1	10.35	1.74	1.79	1.84	1.88	2.05	12,650	
EPDBE2002-2-ATH	●			2	0.15	0.17	50	4	1	9.88	2.25	2.32	2.37	2.45	2.71	13,930	
EPDBE2002-2.5-ATH	●			2.5	0.15	0.17	50	4	1	9.46	2.77	2.84	2.91	3.05	3.37	15,220	
EPDBE2002-3-ATH	●			3	0.15	0.17	50	4	1	9.07	3.28	3.37	3.48	3.65	4.04	16,290	
EPDBE2003-0.5-ATH	●			0.15	0.3	0.5	0.25	0.27	50	4	2	11.47	0.78	0.82	0.86	0.90	0.98
EPDBE2003-0.75-ATH	●	0.75	0.25			0.27	50	4	2	11.17	1.05	1.10	1.15	1.20	1.29	11,470	
EPDBE2003-1-ATH	●	1	0.25			0.27	50	4	2	10.89	1.31	1.38	1.43	1.49	1.59	11,470	
EPDBE2003-1.25-ATH	●	1.25	0.25			0.27	50	4	2	10.62	1.58	1.65	1.72	1.78	1.89	12,220	
EPDBE2003-1.5-ATH	●	1.5	0.25			0.27	50	4	2	10.36	1.84	1.92	1.99	2.06	2.18	12,220	
EPDBE2003-2-ATH	●	2	0.25			0.27	50	4	2	9.88	2.36	2.46	2.55	2.62	2.76	12,220	
EPDBE2003-2.5-ATH	●	2.5	0.25			0.27	50	4	2	9.45	2.89	3.00	3.10	3.18	3.36	12,650	
EPDBE2003-3-ATH	●	3	0.25			0.27	50	4	2	9.05	3.41	3.53	3.64	3.73	4.02	12,650	
EPDBE2004-0.75-ATH	●	0.2	0.4			0.75	0.3	0.37	50	4	2	11.21	1.04	1.09	1.14	1.19	1.28
EPDBE2004-1-ATH	●			1	0.3	0.37	50	4	2	10.91	1.31	1.37	1.43	1.48	1.58	7,810	
EPDBE2004-1.5-ATH	●			1.5	0.3	0.37	50	4	2	10.37	1.84	1.92	1.99	2.06	2.17	7,940	
EPDBE2004-2-ATH	●			2	0.3	0.37	50	4	2	9.88	2.36	2.46	2.54	2.62	2.75	8,230	
EPDBE2004-2.5-ATH	●			2.5	0.3	0.37	50	4	2	9.43	2.89	3.00	3.09	3.18	3.34	8,500	
EPDBE2004-3-ATH	●			3	0.3	0.37	50	4	2	9.03	3.41	3.53	3.63	3.73	4.01	9,060	
EPDBE2004-3.5-ATH	●			3.5	0.3	0.37	50	4	2	8.65	3.93	4.06	4.18	4.27	4.67	9,760	
EPDBE2004-4-ATH	●			4	0.3	0.37	50	4	2	8.30	4.45	4.59	4.71	4.83	5.33	9,760	
EPDBE2004-4.5-ATH	●			4.5	0.3	0.37	50	4	2	7.99	4.97	5.12	5.25	5.43	6.00	10,320	
EPDBE2005-1-ATH	●	0.25	0.5	1	0.35	0.47	50	4	2	10.94	1.31	1.37	1.42	1.47	1.57	7,810	
EPDBE2005-1.5-ATH	●			1.5	0.35	0.47	50	4	2	10.39	1.83	1.91	1.98	2.05	2.17	7,810	
EPDBE2005-2-ATH	●			2	0.35	0.47	50	4	2	9.88	2.36	2.45	2.54	2.61	2.75	7,810	
EPDBE2005-2.5-ATH	●			2.5	0.35	0.47	50	4	2	9.42	2.88	2.99	3.09	3.17	3.33	7,810	
EPDBE2005-3-ATH	●			3	0.35	0.47	50	4	2	9.00	3.41	3.53	3.63	3.72	3.99	7,810	
EPDBE2005-4-ATH	●			4	0.35	0.47	50	4	2	8.27	4.45	4.59	4.71	4.82	5.32	7,810	
EPDBE2005-5-ATH	●			5	0.35	0.47	50	4	2	7.64	5.48	5.65	5.78	6.01	6.65	7,940	
EPDBE2005-5.5-ATH	●			5.5	0.35	0.47	50	4	2	7.36	6.00	6.17	6.31	6.61	7.31	8,230	
EPDBE2005-6-ATH	●			6	0.35	0.47	50	4	2	7.10	6.52	6.70	6.88	7.21	7.97	8,230	
EPDBE2005-8-ATH	●	8	0.35	0.47	50	4	2	6.23	8.58	8.79	9.16	9.60	10.63	9,760			
EPDBE2006-1-ATH	●	0.3	0.6	1	0.4	0.57	50	4	4	10.98	1.44	1.54	1.63	1.71	1.88	6,740	
EPDBE2006-2-ATH	●			2	0.4	0.57	50	4	4	9.88	2.52	2.66	2.79	2.91	3.13	6,000	
EPDBE2006-2.5-ATH	●			2.5	0.4	0.57	50	4	4	9.41	3.05	3.22	3.36	3.49	3.73	6,140	
EPDBE2006-3-ATH	●			3	0.4	0.57	50	4	4	8.98	3.58	3.77	3.93	4.07	4.32	6,140	
EPDBE2006-3.5-ATH	●			3.5	0.4	0.57	50	4	4	8.58	4.12	4.32	4.49	4.64	4.91	6,410	
EPDBE2006-4-ATH	●			4	0.4	0.57	50	4	4	8.22	4.64	4.86	5.04	5.20	5.48	6,410	
EPDBE2006-4.5-ATH	●			4.5	0.4	0.57	50	4	4	7.89	5.17	5.40	5.59	5.76	6.06	6,410	
EPDBE2006-5-ATH	●			5	0.4	0.57	50	4	4	7.59	5.70	5.94	6.14	6.32	6.63	6,410	
EPDBE2006-5.5-ATH	●			5.5	0.4	0.57	50	4	4	7.31	6.22	6.48	6.69	6.87	7.29	6,410	
EPDBE2006-6-ATH	●			6	0.4	0.57	50	4	4	7.04	6.75	7.02	7.23	7.42	7.96	6,410	
EPDBE2006-7-ATH	●			7	0.4	0.57	50	4	4	6.57	7.79	8.08	8.32	8.52	9.28	7,250	
EPDBE2006-8-ATH	●			8	0.4	0.57	50	4	4	6.16	8.84	9.15	9.40	9.61	10.61	8,500	
EPDBE2006-9-ATH	●	9	0.4	0.57	50	4	4	5.79	9.88	10.21	10.47	10.79	11.94	9,060			
EPDBE2006-10-ATH	●	10	0.4	0.57	50	4	4	5.47	10.92	11.26	11.54	11.99	13.27	8,650			
EPDBE2006-12-ATH	●	12	0.4	0.57	50	4	4	4.92	12.99	13.37	13.72	14.38	15.92	9,760			

● : 標準在庫品です。 ● : Stocked items. 干渉なし : No interference

超硬ATHコートボールエンドミル

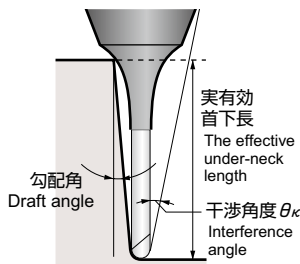
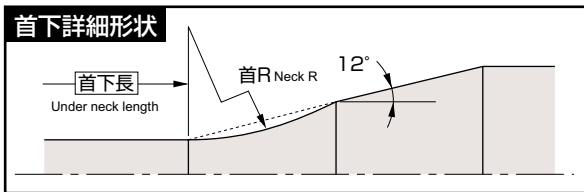

【注意】

エポックディープボールEPDBとは有効首下長が異なります。再度ご確認ください。

【Note】

The effective under-neck length is different from Epoch Deep Ball EPDB. Please recheck the interference region.

EPDBE2○○○-○○.○○-ATH

商品コード Item code	在庫 Stock ATH	寸法 Size(mm)								干渉角度 Interference angle θ_k	勾配角に対する実有効首下長 Effective under neck length with respect to draft angle					希望小売 価格(円) Suggested retail price (¥)
		ボール半径 Ball radius	外径 Tool dia.	首下長 Under Neck length	刃長 Flute length	首径 Neck dia.	全長 Overall length	シャンク径 Shank dia.	首R Neck R		0.5°	1°	1.5°	2°	3°	
		RE	DC	LU	APMX	DN	LF	DCONMS	R							
EPDBE2007-2-ATH	●	0.35	0.7	2	0.45	0.67	50	4	4	9.88	2.52	2.66	2.79	2.90	3.12	6,000
EPDBE2007-4-ATH	●			4	0.45	0.67	50	4	4	8.18	4.64	4.86	5.04	5.20	5.48	6,410
EPDBE2007-6-ATH	●			6	0.45	0.67	50	4	4	6.98	6.74	7.01	7.23	7.42	7.94	6,410
EPDBE2007-8-ATH	●			8	0.45	0.67	50	4	4	6.09	8.83	9.14	9.39	9.61	10.60	6,410
EPDBE2008-2-ATH	●	0.4	0.8	2	0.5	0.77	50	4	4	9.87	2.51	2.65	2.78	2.89	3.11	6,000
EPDBE2008-4-ATH	●			4	0.5	0.77	50	4	4	8.14	4.64	4.85	5.03	5.19	5.47	6,410
EPDBE2008-5-ATH	●			5	0.5	0.77	50	4	4	7.48	5.69	5.93	6.13	6.31	6.61	6,410
EPDBE2008-6-ATH	●			6	0.5	0.77	50	4	4	6.92	6.74	7.01	7.23	7.41	7.92	6,410
EPDBE2008-8-ATH	●			8	0.5	0.77	50	4	4	6.01	8.83	9.14	9.39	9.60	10.58	6,410
EPDBE2008-10-ATH	●			10	0.5	0.77	50	4	4	5.32	10.91	11.26	11.53	11.97	13.23	8,500
EPDBE2009-2-ATH	●	0.45	0.9	2	0.6	0.87	50	4	4	9.87	2.51	2.65	2.77	2.89	3.10	6,000
EPDBE2009-4-ATH	●			4	0.6	0.87	50	4	4	8.09	4.64	4.85	5.03	5.18	5.46	6,410
EPDBE2009-6-ATH	●			6	0.6	0.87	50	4	4	6.85	6.74	7.00	7.22	7.41	7.91	6,410
EPDBE2009-8-ATH	●			8	0.6	0.87	50	4	4	5.94	8.83	9.14	9.38	9.60	10.56	6,410
EPDBE2010-2-ATH	●	0.5	1	2	0.8	0.96	50	4	4	9.84	2.54	2.67	2.79	2.90	3.11	5,020
EPDBE2010-3-ATH	●			3	0.8	0.96	50	4	4	8.84	3.61	3.78	3.93	4.06	4.30	5,020
EPDBE2010-4-ATH	●			4	0.8	0.96	50	4	4	8.02	4.66	4.87	5.04	5.20	5.47	5,720
EPDBE2010-5-ATH	●			5	0.8	0.96	50	4	4	7.34	5.72	5.95	6.14	6.31	6.61	5,720
EPDBE2010-6-ATH	●			6	0.8	0.96	50	4	4	6.77	6.76	7.02	7.23	7.42	7.92	6,140
EPDBE2010-7-ATH	●			7	0.8	0.96	50	4	4	6.28	7.81	8.09	8.32	8.52	9.25	6,140
EPDBE2010-8-ATH	●			8	0.8	0.96	50	4	4	5.85	8.85	9.15	9.40	9.61	10.58	6,140
EPDBE2010-9-ATH	●			9	0.8	0.96	50	4	4	5.48	9.89	10.21	10.47	10.78	11.91	6,140
EPDBE2010-10-ATH	●			10	0.8	0.96	50	4	4	5.15	10.93	11.27	11.54	11.98	13.23	6,140
EPDBE2010-12-ATH	●			12	0.8	0.96	55	4	4	4.60	13.00	13.37	13.72	14.37	15.89	6,140
EPDBE2010-13-ATH	●			13	0.8	0.96	55	4	4	4.37	14.04	14.42	14.86	15.57	17.21	7,250
EPDBE2010-14-ATH	●			14	0.8	0.96	55	4	4	4.16	15.07	15.47	16.00	16.76	18.54	7,250
EPDBE2010-16-ATH	●	16	0.8	0.96	55	4	4	3.79	17.13	17.56	18.28	19.16	21.20	8,500		
EPDBE2010-18-ATH	●	18	0.8	0.96	60	4	4	3.49	19.19	19.66	20.56	21.55	23.85	8,500		
EPDBE2010-20-ATH	●	20	0.8	0.96	60	4	4	3.23	21.25	21.84	22.84	23.94	26.51	10,320		
EPDBE2011-2-ATH	●	0.55	1.1	2	1	1.05	50	4	4	9.81	2.58	2.70	2.81	2.92	3.12	6,740
EPDBE2011-4-ATH	●			4	1	1.05	50	4	4	7.95	4.69	4.89	5.06	5.21	5.48	7,670
EPDBE2011-6-ATH	●			6	1	1.05	50	4	4	6.68	6.79	7.04	7.25	7.43	7.94	8,360
EPDBE2011-8-ATH	●			8	1	1.05	50	4	4	5.76	8.87	9.17	9.41	9.61	10.59	8,360
EPDBE2011-10-ATH	●			10	1	1.05	50	4	4	5.06	10.95	11.28	11.55	12.00	13.25	8,360
EPDBE2012-4-ATH	●	0.6	1.2	4	1.1	1.15	50	4	4	7.89	4.69	4.88	5.05	5.20	5.47	7,670
EPDBE2012-6-ATH	●			6	1.1	1.15	50	4	4	6.60	6.79	7.03	7.24	7.42	7.92	8,360
EPDBE2012-8-ATH	●			8	1.1	1.15	50	4	4	5.67	8.87	9.16	9.40	9.61	10.58	8,360
EPDBE2012-10-ATH	●			10	1.1	1.15	50	4	4	4.97	10.95	11.28	11.54	11.99	13.23	8,360
EPDBE2012-12-ATH	●			12	1.1	1.15	55	4	4	4.43	13.02	13.38	13.73	14.38	15.89	8,360
EPDBE2014-8-ATH	●	0.7	1.4	8	1.3	1.34	50	4	4	5.48	8.89	9.18	9.41	9.61	10.58	7,250
EPDBE2014-12-ATH	●			12	1.3	1.34	55	4	4	4.24	13.04	13.39	13.74	14.39	15.89	7,250
EPDBE2014-16-ATH	●			16	1.3	1.34	55	4	4	3.46	17.16	17.57	18.31	19.17	21.20	7,250
EPDBE2015-4-ATH	●	0.75	1.5	4	1.35	1.44	50	4	4	7.68	4.71	4.89	5.06	5.20	5.46	5,850
EPDBE2015-6-ATH	●			6	1.35	1.44	50	4	4	6.33	6.81	7.04	7.25	7.42	7.91	5,850
EPDBE2015-8-ATH	●			8	1.35	1.44	50	4	4	5.39	8.89	9.17	9.41	9.61	10.56	6,140
EPDBE2015-10-ATH	●			10	1.35	1.44	50	4	4	4.68	10.96	11.29	11.55	11.98	13.22	6,690
EPDBE2015-12-ATH	●			12	1.35	1.44	55	4	4	4.14	13.03	13.39	13.74	14.38	15.87	7,250
EPDBE2015-14-ATH	●			14	1.35	1.44	55	4	4	3.72	15.10	15.48	16.02	16.77	18.52	7,250
EPDBE2015-16-ATH	●			16	1.35	1.44	55	4	4	3.77	17.16	17.57	18.30	19.16	21.18	7,250
EPDBE2015-18-ATH	●			18	1.35	1.44	60	4	4	3.08	19.22	19.69	20.58	21.56	23.83	7,250
EPDBE2015-20-ATH	●			20	1.35	1.44	60	4	4	2.84	21.27	21.87	22.86	23.95	干渉なし	7,250
EPDBE2016-8-ATH	●			0.8	1.6	8	1.4	1.54	50	4	4	5.28	8.89	9.17	9.40	9.60
EPDBE2016-12-ATH	●	12	1.4			1.54	55	4	4	4.05	13.03	13.39	13.73	14.37	15.85	8,360
EPDBE2016-16-ATH	●	16	1.4			1.54	55	4	4	3.28	17.16	17.57	18.29	19.15	21.16	8,360
EPDBE2016-20-ATH	●	20	1.4			1.54	60	4	4	2.75	21.27	21.87	22.86	23.94	干渉なし	8,360

EPDBE2○○○-○○.○○○-ATH

超硬ボールエポック

商品コード Item code	在庫 Stock ATH	寸法 Size(mm)										干渉角度 Interference angle θκ	勾配角に対する実有効首下長 Effective under neck length with respect to draft angle					希望小売 価格(円) Suggested retail price (¥)
		ボール半径 Ball radius	外径 Tool dia.	首下長 Under Neck length	刃長 Flute length	首径 Neck dia.	全長 Overall length	シャンク径 Shank dia.	首R Neck R	0.5°	1°		1.5°	2°	3°			
		RE	DC	LU	APMX	DN	LF	DCONMS	R									
EPDBE2018-8-ATH	●	0.9	1.8	8	1.6	1.73	50	4	4	5.06	8.91	9.18	9.41	9.61	10.54	7,250		
EPDBE2018-12-ATH	●			12	1.6	1.73	55	4	4	3.83	13.05	13.40	13.74	14.38	15.85	7,250		
EPDBE2018-16-ATH	●			16	1.6	1.73	55	4	4	3.09	17.17	17.58	18.31	19.16	21.16	7,250		
EPDBE2018-20-ATH	●			20	1.6	1.73	60	4	4	2.58	21.28	21.88	22.87	23.95	干涉なし	7,250		
EPDBE2020-3-ATH	●	1	2	3	1.7	1.92	50	4	4	8.26	3.71	3.84	3.96	4.07	4.29	5,020		
EPDBE2020-4-ATH	●			4	1.7	1.92	50	4	4	7.23	4.75	4.92	5.07	5.21	5.45	5,020		
EPDBE2020-6-ATH	●			6	1.7	1.92	50	4	4	5.78	6.84	7.07	7.26	7.43	7.89	5,720		
EPDBE2020-8-ATH	●			8	1.7	1.92	50	4	4	4.81	8.92	9.19	9.42	9.61	10.54	6,140		
EPDBE2020-10-ATH	●			10	1.7	1.92	50	4	4	4.12	11.00	11.30	11.56	11.99	13.20	6,140		
EPDBE2020-12-ATH	●			12	1.7	1.92	55	4	4	3.61	13.06	13.41	13.76	14.39	15.85	6,140		
EPDBE2020-13-ATH	●			13	1.7	1.92	55	4	4	3.39	14.10	14.45	14.90	15.58	17.18	6,140		
EPDBE2020-14-ATH	●			14	1.7	1.92	55	4	4	3.20	15.13	15.50	16.04	16.78	18.51	6,140		
EPDBE2020-16-ATH	●			16	1.7	1.92	55	4	4	2.88	17.19	17.59	18.32	19.17	干涉なし	6,140		
EPDBE2020-18-ATH	●			18	1.7	1.92	60	4	4	2.62	19.24	19.72	20.60	21.57	干涉なし	6,140		
EPDBE2020-20-ATH	●			20	1.7	1.92	60	4	4	2.40	21.30	21.90	22.88	23.96	干涉なし	6,140		
EPDBE2020-22-ATH	●			22	1.7	1.92	60	4	4	2.22	23.35	24.08	25.16	26.35	干涉なし	8,500		
EPDBE2020-25-ATH	●			25	1.7	1.92	65	4	4	1.99	26.42	27.35	28.58	干涉なし	干涉なし	8,650		
EPDBE2020-30-ATH	●			30	1.7	1.92	70	4	4	1.70	31.53	32.80	34.29	干涉なし	干涉なし	9,900		
EPDBE2020-35-ATH	●			35	1.7	1.92	75	4	4	1.48	36.65	38.24	干涉なし	干涉なし	干涉なし	13,390		
EPDBE2020-40-ATH	●			40	1.7	1.92	80	4	4	1.31	41.86	43.69	干涉なし	干涉なし	干涉なし	13,390		
EPDBE2025-6-ATH	●	1.25	2.5	6	2	2.4	50	4	4	5.04	6.88	7.09	7.27	7.43	7.87	6,690		
EPDBE2025-10-ATH	●			10	2	2.4	50	4	4	3.43	11.03	11.32	11.56	12.00	13.18	7,050		
EPDBE2025-15-ATH	●			15	2	2.4	55	4	4	2.46	16.18	16.56	17.20	17.98	干涉なし	8,360		
EPDBE2025-20-ATH	●			20	2	2.4	60	4	4	1.91	21.32	21.93	22.90	干涉なし	干涉なし	9,760		
EPDBE2025-25-ATH	●			25	2	2.4	65	4	4	1.57	26.44	27.38	28.60	干涉なし	干涉なし	10,450		
EPDBE2025-30-ATH	●	30	2	2.4	70	4	4	1.33	31.55	32.82	干涉なし	干涉なし	干涉なし	10,450				
EPDBE2030-8-ATH	●	1.5	3	8	2.5	2.88	55	6	4	6.19	8.99	9.23	9.44	9.62	10.51	6,270		
EPDBE2030-10-ATH	●			10	2.5	2.88	55	6	4	5.41	11.06	11.34	11.57	12.01	13.16	7,110		
EPDBE2030-13-ATH	●			13	2.5	2.88	60	6	4	4.56	14.15	14.48	14.94	15.60	17.15	8,360		
EPDBE2030-16-ATH	●			16	2.5	2.88	60	6	4	3.93	17.24	17.61	18.36	19.19	21.13	8,360		
EPDBE2030-20-ATH	●			20	2.5	2.88	65	6	4	3.33	21.34	21.96	22.92	23.97	26.44	8,090		
EPDBE2030-25-ATH	●			25	2.5	2.88	70	6	4	2.79	26.46	27.41	28.62	29.96	干涉なし	8,090		
EPDBE2030-30-ATH	●	30	2.5	2.88	75	6	4	2.40	31.57	32.85	34.32	35.94	干涉なし	9,200				
EPDBE2030-35-ATH	●	35	2.5	2.88	80	6	4	2.11	36.72	38.30	40.03	41.92	干涉なし	11,680				
EPDBE2035-15-ATH	●	1.75	3.5	15	2.75	3.35	60	6	4	3.68	16.25	16.60	17.26	18.03	19.81	9,200		
EPDBE2035-25-ATH	●			25	2.75	3.35	70	6	4	2.43	26.49	27.46	28.67	29.99	干涉なし	9,760		
EPDBE2035-35-ATH	●			35	2.75	3.35	80	6	4	1.82	36.79	38.36	40.07	干涉なし	干涉なし	12,540		
EPDBE2035-45-ATH	●			45	2.75	3.35	90	6	4	1.45	47.22	49.25	干涉なし	干涉なし	干涉なし	15,320		
EPDBE2040-10-ATH	●	2	4	10	3	3.85	55	6	4	4.38	11.10	11.36	11.58	12.00	13.10	6,410		
EPDBE2040-13-ATH	●			13	3	3.85	60	6	4	3.57	14.19	14.50	14.95	15.59	17.08	8,360		
EPDBE2040-16-ATH	●			16	3	3.85	60	6	4	3.01	17.27	17.63	18.37	19.18	干涉なし	8,360		
EPDBE2040-20-ATH	●			20	3	3.85	65	6	4	2.49	21.37	21.99	22.93	23.96	干涉なし	8,360		
EPDBE2040-25-ATH	●			25	3	3.85	70	6	4	2.05	26.49	27.44	28.63	29.95	干涉なし	8,360		
EPDBE2040-30-ATH	●			30	3	3.85	75	6	4	1.74	31.59	32.89	34.34	干涉なし	干涉なし	8,360		
EPDBE2040-35-ATH	●			35	3	3.85	80	6	4	1.51	36.78	38.33	40.04	干涉なし	干涉なし	9,610		
EPDBE2040-40-ATH	●			40	3	3.85	80	6	4	1.34	41.99	43.78	干涉なし	干涉なし	干涉なし	10,830		
EPDBE2040-45-ATH	●	45	3	3.85	90	6	4	1.20	47.20	49.23	干涉なし	干涉なし	干涉なし	13,930				
EPDBE2040-50-ATH	●	50	3	3.85	100	6	4	1.08	52.42	54.68	干涉なし	干涉なし	干涉なし	14,890				
EPDBE2050-20-ATH	●	2.5	5	20	3.5	4.85	65	6	4	1.42	21.36	21.95	干涉なし	干涉なし	干涉なし	14,590		
EPDBE2050-25-ATH	●			25	3.5	4.85	70	6	4	1.14	26.48	27.39	干涉なし	干涉なし	干涉なし	14,590		
EPDBE2050-30-ATH	●			30	3.5	4.85	75	6	4	0.95	31.58	干涉なし	干涉なし	干涉なし	干涉なし	15,600		
EPDBE2050-40-ATH	●			40	3.5	4.85	80	6	4	0.72	41.97	干涉なし	干涉なし	干涉なし	干涉なし	19,760		
EPDBE2060-12-ATH	●	3	6	12	6	5.85	60	6	-	0	干涉なし	干涉なし	干涉なし	干涉なし	干涉なし	10,950		
EPDBE2060-20-ATH	●			20	6	5.85	65	6	-	0	干涉なし	干涉なし	干涉なし	干涉なし	干涉なし	干涉なし	10,950	
EPDBE2060-30-ATH	●			30	6	5.85	75	6	-	0	干涉なし	干涉なし	干涉なし	干涉なし	干涉なし	干涉なし	11,220	
EPDBE2060-50-ATH	●			50	6	5.85	100	6	-	0	干涉なし	干涉なし	干涉なし	干涉なし	干涉なし	干涉なし	13,470	

● 対応被削材 Applicable work material

炭素鋼 合金鋼 Carbon steel Alloy steel	プリハー ド鋼 Pre-hardened steel	高硬度 Hardened steel			ステン レス鋼 Stainless steel	チタン合金 耐熱合金 Titanium alloy Heat-resistant alloy	銅合金 Copper alloy	アルミ 合金 Aluminum alloy
		> 45HRC ≤ 45HRC	> 55HRC ≤ 55HRC	> 65HRC ≤ 65HRC				
○	○	○	○	○	○	○	○	

● : 標準在庫品です。● : Stocked items. 干涉なし : No interference

● 再研磨対応外径範囲 Re-grinding compatibility range

商品コード Item code	外周 Outer dia. (mm)	エンド End (mm)
EPDBE-ATH	× (N/A)	1 ~ 6

[注意] 首下長/外径が10DCを超える工具の再研磨可否については、弊社営業にお問い合わせください。
[Note] Contact our sales office regarding whether or not regrinding is possible for tools where under neck length/tool diameter more than 10DC

エポックディープボールエボリューション **PN Coating**

ストレートネック

Straight Neck



RE公差
RE ≤ 0.25 : ±0.003
0.25 < RE : ±0.005



(mm)

刃先と首形状の改良によりタオレを抑制し高精度加工を実現。

ATH&PNコーティングの採用で更なる長寿命加工。

Improved flute tip shape and neck shape suppresses warping to enable high-accuracy cutting. Use of ATH and PN coatings further extends tool life.

2枚刃
2 Flutes

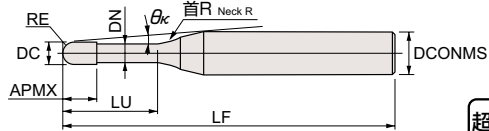

切削条件表 **A78**
Cutting Conditions

超硬 **PN** 傾角30°
Carbide Helix angle

EPDBE2-0.05-0.1-0.15-0.2-0.25-0.3-PN

商品コード Item code	在庫 Stock PN	寸法 Size(mm)								干渉角度 Interference angle θκ	勾配角に対する実有効首下長 Effective under neck length with respect to draft angle					希望小売 価格(円) Suggested retail price (¥)
		ボール半径 Ball radius RE	外径 Tool dia. DC	首下長 Under Neck length LU	刃長 Flute length APMX	首径 Neck dia. DN	全長 Overall length LF	シャンク径 Shank dia. DCONMS	首R Neck R		0.5°	1°	1.5°	2°	3°	
EPDBE2001-0.2-PN	●	0.05	0.1	0.2	0.08	0.08	45	4	1	11.76	0.35	0.37	0.39	0.41	0.44	13,820
EPDBE2001-0.3-PN	●			0.3	0.08	0.08	45	4	1	11.64	0.46	0.48	0.50	0.52	0.57	14,150
EPDBE2001-0.5-PN	●			0.5	0.08	0.08	45	4	1	11.40	0.67	0.70	0.73	0.76	0.81	15,320
EPDBE2002-0.5-PN	●	0.1	0.2	0.5	0.15	0.17	50	4	1	11.42	0.70	0.72	0.75	0.77	0.82	9,910
EPDBE2002-0.75-PN	●			0.75	0.15	0.17	50	4	1	11.13	0.96	0.99	1.02	1.05	1.11	9,910
EPDBE2002-1-PN	●			1	0.15	0.17	50	4	1	10.86	1.22	1.26	1.30	1.33	1.39	9,910
EPDBE2002-1.25-PN	●			1.25	0.15	0.17	50	4	1	10.60	1.48	1.52	1.57	1.61	1.72	10,710
EPDBE2002-1.5-PN	●			1.5	0.15	0.17	50	4	1	10.35	1.74	1.79	1.84	1.88	2.05	10,710
EPDBE2002-2-PN	●			2	0.15	0.17	50	4	1	9.88	2.25	2.32	2.37	2.45	2.71	11,790
EPDBE2002-2.5-PN	●			2.5	0.15	0.17	50	4	1	9.46	2.77	2.84	2.91	3.05	3.37	12,860
EPDBE2002-3-PN	●			3	0.15	0.17	50	4	1	9.07	3.28	3.37	3.48	3.65	4.04	13,820
EPDBE2003-0.5-PN	●			0.15	0.3	0.5	0.25	0.27	50	4	2	11.47	0.78	0.82	0.86	0.90
EPDBE2003-0.75-PN	●	0.75	0.25			0.27	50	4	2	11.17	1.05	1.10	1.15	1.20	1.29	9,680
EPDBE2003-1-PN	●	1	0.25			0.27	50	4	2	10.89	1.31	1.38	1.43	1.49	1.59	9,680
EPDBE2003-1.25-PN	●	1.25	0.25			0.27	50	4	2	10.62	1.58	1.65	1.72	1.78	1.89	10,380
EPDBE2003-1.5-PN	●	1.5	0.25			0.27	50	4	2	10.36	1.84	1.92	1.99	2.06	2.18	10,380
EPDBE2003-2-PN	●	2	0.25			0.27	50	4	2	9.88	2.36	2.46	2.55	2.62	2.76	10,380
EPDBE2003-2.5-PN	●	2.5	0.25			0.27	50	4	2	9.45	2.89	3.00	3.10	3.18	3.36	10,710
EPDBE2003-3-PN	●	3	0.25			0.27	50	4	2	9.05	3.41	3.53	3.64	3.73	4.02	10,710
EPDBE2004-0.75-PN	●	0.2	0.4			0.75	0.3	0.37	50	4	2	11.21	1.04	1.09	1.14	1.19
EPDBE2004-1-PN	●			1	0.3	0.37	50	4	2	10.91	1.31	1.37	1.43	1.48	1.58	6,610
EPDBE2004-1.5-PN	●			1.5	0.3	0.37	50	4	2	10.37	1.84	1.92	1.99	2.06	2.17	6,720
EPDBE2004-2-PN	●			2	0.3	0.37	50	4	2	9.88	2.36	2.46	2.54	2.62	2.75	6,960
EPDBE2004-2.5-PN	●			2.5	0.3	0.37	50	4	2	9.43	2.89	3.00	3.09	3.18	3.34	7,200
EPDBE2004-3-PN	●			3	0.3	0.37	50	4	2	9.03	3.41	3.53	3.63	3.73	4.01	7,670
EPDBE2004-3.5-PN	●			3.5	0.3	0.37	50	4	2	8.65	3.93	4.06	4.18	4.27	4.67	8,260
EPDBE2004-4-PN	●			4	0.3	0.37	50	4	2	8.30	4.45	4.59	4.71	4.83	5.33	8,260
EPDBE2004-4.5-PN	●			4.5	0.3	0.37	50	4	2	7.99	4.97	5.12	5.25	5.43	6.00	8,730
EPDBE2005-1-PN	●	0.25	0.5	1	0.35	0.47	50	4	2	10.94	1.31	1.37	1.42	1.47	1.57	6,610
EPDBE2005-1.5-PN	●			1.5	0.35	0.47	50	4	2	10.39	1.83	1.91	1.98	2.05	2.17	6,610
EPDBE2005-2-PN	●			2	0.35	0.47	50	4	2	9.88	2.36	2.45	2.54	2.61	2.75	6,610
EPDBE2005-2.5-PN	●			2.5	0.35	0.47	50	4	2	9.42	2.88	2.99	3.09	3.17	3.33	6,610
EPDBE2005-3-PN	●			3	0.35	0.47	50	4	2	9.00	3.41	3.53	3.63	3.72	3.99	6,610
EPDBE2005-4-PN	●			4	0.35	0.47	50	4	2	8.27	4.45	4.59	4.71	4.82	5.32	6,610
EPDBE2005-5-PN	●			5	0.35	0.47	50	4	2	7.64	5.48	5.65	5.78	6.01	6.65	6,720
EPDBE2005-5.5-PN	●			5.5	0.35	0.47	50	4	2	7.36	6.00	6.17	6.31	6.61	7.31	6,960
EPDBE2005-6-PN	●			6	0.35	0.47	50	4	2	7.10	6.52	6.70	6.88	7.21	7.97	6,960
EPDBE2005-8-PN	●	8	0.35	0.47	50	4	2	6.23	8.58	8.79	9.16	9.60	10.63	8,260		
EPDBE2006-1-PN	●	0.3	0.6	1	0.4	0.57	50	4	4	10.98	1.44	1.54	1.63	1.71	1.88	5,700
EPDBE2006-2-PN	●			2	0.4	0.57	50	4	4	9.88	2.52	2.66	2.79	2.91	3.13	5,080
EPDBE2006-2.5-PN	●			2.5	0.4	0.57	50	4	4	9.41	3.05	3.22	3.36	3.49	3.73	5,190
EPDBE2006-3-PN	●			3	0.4	0.57	50	4	4	8.98	3.58	3.77	3.93	4.07	4.32	5,190
EPDBE2006-3.5-PN	●			3.5	0.4	0.57	50	4	4	8.58	4.12	4.32	4.49	4.64	4.91	5,430
EPDBE2006-4-PN	●			4	0.4	0.57	50	4	4	8.22	4.64	4.86	5.04	5.20	5.48	5,430
EPDBE2006-4.5-PN	●			4.5	0.4	0.57	50	4	4	7.89	5.17	5.40	5.59	5.76	6.06	5,430
EPDBE2006-5-PN	●			5	0.4	0.57	50	4	4	7.59	5.70	5.94	6.14	6.32	6.63	5,430
EPDBE2006-5.5-PN	●			5.5	0.4	0.57	50	4	4	7.31	6.22	6.48	6.69	6.87	7.29	5,430
EPDBE2006-6-PN	●			6	0.4	0.57	50	4	4	7.04	6.75	7.02	7.23	7.42	7.96	5,430
EPDBE2006-7-PN	●			7	0.4	0.57	50	4	4	6.57	7.79	8.08	8.32	8.52	9.28	6,140
EPDBE2006-8-PN	●			8	0.4	0.57	50	4	4	6.16	8.84	9.15	9.40	9.61	10.61	7,200
EPDBE2006-9-PN	●	9	0.4	0.57	50	4	4	5.79	9.88	10.21	10.47	10.79	11.94	7,670		
EPDBE2006-10-PN	●	10	0.4	0.57	50	4	4	5.47	10.92	11.26	11.54	11.99	13.27	7,310		
EPDBE2006-12-PN	●	12	0.4	0.57	50	4	4	4.92	12.99	13.37	13.72	14.38	15.92	8,260		

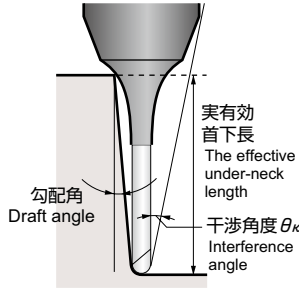
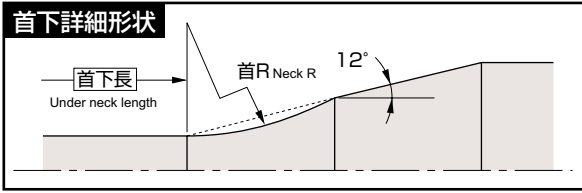

【注意】

エポックディープボールEPDBとは有効首下長が異なります。再度ご確認ください。

【Note】

The effective under-neck length is different from Epoch Deep Ball EPDB. Please recheck the interference region.

EPDBE2-0000-0000-PN

商品コード Item code	在庫 Stock PN	寸法 Size(mm)								干渉角度 Interference angle θ_k	勾配角に対する実有効首下長 Effective under neck length with respect to draft angle					希望小売 価格(円) Suggested retail price (¥)
		ボール半径 Ball radius RE	外径 Tool dia. DC	首下長 Under Neck length LU	刃長 Flute length APMX	首径 Neck dia. DN	全長 Overall length LF	シャク径 Shank dia. DCONMS	首R Neck R		勾配角に対する実有効首下長					
											0.5°	1°	1.5°	2°	3°	
EPDBE2007-2-PN	●	0.35	0.7	2	0.45	0.67	50	4	4	9.88	2.52	2.66	2.79	2.90	3.12	5,080
EPDBE2007-4-PN	●			4	0.45	0.67	50	4	4	8.18	4.64	4.86	5.04	5.20	5.48	5,430
EPDBE2007-6-PN	●			6	0.45	0.67	50	4	4	6.98	6.74	7.01	7.23	7.42	7.94	5,430
EPDBE2007-8-PN	●			8	0.45	0.67	50	4	4	6.09	8.83	9.14	9.39	9.61	10.60	5,430
EPDBE2008-2-PN	●	0.4	0.8	2	0.5	0.77	50	4	4	9.87	2.51	2.65	2.78	2.89	3.11	5,080
EPDBE2008-4-PN	●			4	0.5	0.77	50	4	4	8.14	4.64	4.85	5.03	5.19	5.47	5,430
EPDBE2008-5-PN	●			5	0.5	0.77	50	4	4	7.48	5.69	5.93	6.13	6.31	6.61	5,430
EPDBE2008-6-PN	●			6	0.5	0.77	50	4	4	6.92	6.74	7.01	7.23	7.41	7.92	5,430
EPDBE2008-8-PN	●			8	0.5	0.77	50	4	4	6.01	8.83	9.14	9.39	9.60	10.58	5,430
EPDBE2008-10-PN	●			10	0.5	0.77	50	4	4	5.32	10.91	11.26	11.53	11.97	13.23	7,200
EPDBE2009-2-PN	●	0.45	0.9	2	0.6	0.87	50	4	4	9.87	2.51	2.65	2.77	2.89	3.10	5,080
EPDBE2009-4-PN	●			4	0.6	0.87	50	4	4	8.09	4.64	4.85	5.03	5.18	5.46	5,430
EPDBE2009-6-PN	●			6	0.6	0.87	50	4	4	6.85	6.74	7.00	7.22	7.41	7.91	5,430
EPDBE2009-8-PN	●			8	0.6	0.87	50	4	4	5.94	8.83	9.14	9.38	9.60	10.56	5,430
EPDBE2010-2-PN	●	0.5	1	2	0.8	0.96	50	4	4	9.84	2.54	2.67	2.79	2.90	3.11	4,250
EPDBE2010-3-PN	●			3	0.8	0.96	50	4	4	8.84	3.61	3.78	3.93	4.06	4.30	4,250
EPDBE2010-4-PN	●			4	0.8	0.96	50	4	4	8.02	4.66	4.87	5.04	5.20	5.47	4,850
EPDBE2010-5-PN	●			5	0.8	0.96	50	4	4	7.34	5.72	5.95	6.14	6.31	6.61	4,850
EPDBE2010-6-PN	●			6	0.8	0.96	50	4	4	6.77	6.76	7.02	7.23	7.42	7.92	5,190
EPDBE2010-7-PN	●			7	0.8	0.96	50	4	4	6.28	7.81	8.09	8.32	8.52	9.25	5,190
EPDBE2010-8-PN	●			8	0.8	0.96	50	4	4	5.85	8.85	9.15	9.40	9.61	10.58	5,190
EPDBE2010-9-PN	●			9	0.8	0.96	50	4	4	5.48	9.89	10.21	10.47	10.78	11.91	5,190
EPDBE2010-10-PN	●			10	0.8	0.96	50	4	4	5.15	10.93	11.27	11.54	11.98	13.23	5,190
EPDBE2010-12-PN	●			12	0.8	0.96	55	4	4	4.60	13.00	13.37	13.72	14.37	15.89	5,190
EPDBE2010-13-PN	●			13	0.8	0.96	55	4	4	4.37	14.04	14.42	14.86	15.57	17.21	6,140
EPDBE2010-14-PN	●			14	0.8	0.96	55	4	4	4.16	15.07	15.47	16.00	16.76	18.54	6,140
EPDBE2010-16-PN	●	16	0.8	0.96	55	4	4	3.79	17.13	17.56	18.28	19.16	21.20	7,200		
EPDBE2010-18-PN	●	18	0.8	0.96	60	4	4	3.49	19.19	19.66	20.56	21.55	23.85	7,200		
EPDBE2010-20-PN	●	20	0.8	0.96	60	4	4	3.23	21.25	21.84	22.84	23.94	26.51	8,730		
EPDBE2011-2-PN	●	0.55	1.1	2	1	1.05	50	4	4	9.81	2.58	2.70	2.81	2.92	3.12	5,700
EPDBE2011-4-PN	●			4	1	1.05	50	4	4	7.95	4.69	4.89	5.06	5.21	5.48	6,490
EPDBE2011-6-PN	●			6	1	1.05	50	4	4	6.68	6.79	7.04	7.25	7.43	7.94	7,080
EPDBE2011-8-PN	●			8	1	1.05	50	4	4	5.76	8.87	9.17	9.41	9.61	10.59	7,080
EPDBE2011-10-PN	●			10	1	1.05	50	4	4	5.06	10.95	11.28	11.55	12.00	13.25	7,080
EPDBE2012-4-PN	●	0.6	1.2	4	1.1	1.15	50	4	4	7.89	4.69	4.88	5.05	5.20	5.47	6,490
EPDBE2012-6-PN	●			6	1.1	1.15	50	4	4	6.60	6.79	7.03	7.24	7.42	7.92	7,080
EPDBE2012-8-PN	●			8	1.1	1.15	50	4	4	5.67	8.87	9.16	9.40	9.61	10.58	7,080
EPDBE2012-10-PN	●			10	1.1	1.15	50	4	4	4.97	10.95	11.28	11.54	11.99	13.23	7,080
EPDBE2012-12-PN	●			12	1.1	1.15	55	4	4	4.43	13.02	13.38	13.73	14.38	15.89	7,080
EPDBE2014-8-PN	●	0.7	1.4	8	1.3	1.34	50	4	4	5.48	8.89	9.18	9.41	9.61	10.58	6,140
EPDBE2014-12-PN	●			12	1.3	1.34	55	4	4	4.24	13.04	13.39	13.74	14.39	15.89	6,140
EPDBE2014-16-PN	●			16	1.3	1.34	55	4	4	3.46	17.16	17.57	18.31	19.17	21.20	6,140
EPDBE2015-4-PN	●	0.75	1.5	4	1.35	1.44	50	4	4	7.68	4.71	4.89	5.06	5.20	5.46	4,960
EPDBE2015-6-PN	●			6	1.35	1.44	50	4	4	6.33	6.81	7.04	7.25	7.42	7.91	4,960
EPDBE2015-8-PN	●			8	1.35	1.44	50	4	4	5.39	8.89	9.17	9.41	9.61	10.56	5,190
EPDBE2015-10-PN	●			10	1.35	1.44	50	4	4	4.68	10.96	11.29	11.55	11.98	13.22	5,660
EPDBE2015-12-PN	●			12	1.35	1.44	55	4	4	4.14	13.03	13.39	13.74	14.38	15.87	6,140
EPDBE2015-14-PN	●			14	1.35	1.44	55	4	4	3.72	15.10	15.48	16.02	16.77	18.52	6,140
EPDBE2015-16-PN	●			16	1.35	1.44	55	4	4	3.77	17.16	17.57	18.30	19.16	21.18	6,140
EPDBE2015-18-PN	●			18	1.35	1.44	60	4	4	3.08	19.22	19.69	20.58	21.56	23.83	6,140
EPDBE2015-20-PN	●	20	1.35	1.44	60	4	4	2.84	21.27	21.87	22.86	23.95	干涉なし	6,140		
EPDBE2016-8-PN	●	0.8	1.6	8	1.4	1.54	50	4	4	5.28	8.89	9.17	9.40	9.60	10.55	7,080
EPDBE2016-12-PN	●			12	1.4	1.54	55	4	4	4.05	13.03	13.39	13.73	14.37	15.85	7,080
EPDBE2016-16-PN	●			16	1.4	1.54	55	4	4	3.28	17.16	17.57	18.29	19.15	21.16	7,080
EPDBE2016-20-PN	●			20	1.4	1.54	60	4	4	2.75	21.27	21.87	22.86	23.94	干涉なし	7,080

● : 標準在庫品です。● : Stocked items. 干涉なし : No interference

超硬ボールエボリューション

EPDBE2000-00.00-PN

商品コード Item code	在庫 Stock PN	寸法 Size(mm)								干渉角度 Interference angle θ_k	勾配角に対する実有効首下長 Effective under neck length with respect to draft angle					希望小売 価格(円) Suggested retail price (¥)
		ボール半径 Ball radius RE	外径 Tool dia. DC	首下長 Under Neck length LU	刃長 Flute length APMX	首径 Neck dia. DN	全長 Overall length LF	シャンク径 Shank dia. DCONMS	首R Neck R		0.5°	1°	1.5°	2°	3°	
EPDBE2018-8-PN	●	0.9	1.8	8	1.6	1.73	50	4	4	5.06	8.91	9.18	9.41	9.61	10.54	6,140
EPDBE2018-12-PN	●			12	1.6	1.73	55	4	4	3.83	13.05	13.40	13.74	14.38	15.85	6,140
EPDBE2018-16-PN	●			16	1.6	1.73	55	4	4	3.09	17.17	17.58	18.31	19.16	21.16	6,140
EPDBE2018-20-PN	●			20	1.6	1.73	60	4	4	2.58	21.28	21.88	22.87	23.95	干渉なし	6,140
EPDBE2020-3-PN	●	1	2	3	1.7	1.92	50	4	4	8.26	3.71	3.84	3.96	4.07	4.29	4,250
EPDBE2020-4-PN	●			4	1.7	1.92	50	4	4	7.23	4.75	4.92	5.07	5.21	5.45	4,250
EPDBE2020-6-PN	●			6	1.7	1.92	50	4	4	5.78	6.84	7.07	7.26	7.43	7.89	4,850
EPDBE2020-8-PN	●			8	1.7	1.92	50	4	4	4.81	8.92	9.19	9.42	9.61	10.54	5,190
EPDBE2020-10-PN	●			10	1.7	1.92	50	4	4	4.12	11.00	11.30	11.56	11.99	13.20	5,190
EPDBE2020-12-PN	●			12	1.7	1.92	55	4	4	3.61	13.06	13.41	13.76	14.39	15.85	5,190
EPDBE2020-13-PN	●			13	1.7	1.92	55	4	4	3.39	14.10	14.45	14.90	15.58	17.18	5,190
EPDBE2020-14-PN	●			14	1.7	1.92	55	4	4	3.20	15.13	15.50	16.04	16.78	18.51	5,190
EPDBE2020-16-PN	●			16	1.7	1.92	55	4	4	2.88	17.19	17.59	18.32	19.17	干渉なし	5,190
EPDBE2020-18-PN	●			18	1.7	1.92	60	4	4	2.62	19.24	19.72	20.60	21.57	干渉なし	5,190
EPDBE2020-20-PN	●			20	1.7	1.92	60	4	4	2.40	21.30	21.90	22.88	23.96	干渉なし	5,190
EPDBE2020-22-PN	●			22	1.7	1.92	60	4	4	2.22	23.35	24.08	25.16	26.35	干渉なし	7,200
EPDBE2020-25-PN	●			25	1.7	1.92	65	4	4	1.99	26.42	27.35	28.58	干渉なし	干渉なし	7,310
EPDBE2020-30-PN	●			30	1.7	1.92	70	4	4	1.70	31.53	32.80	34.29	干渉なし	干渉なし	8,370
EPDBE2020-35-PN	●			35	1.7	1.92	75	4	4	1.48	36.65	38.24	干渉なし	干渉なし	干渉なし	11,370
EPDBE2020-40-PN	●			40	1.7	1.92	80	4	4	1.31	41.86	43.69	干渉なし	干渉なし	干渉なし	11,370
EPDBE2025-6-PN	●	1.25	2.5	6	2	2.4	50	4	4	5.04	6.88	7.09	7.27	7.43	7.87	5,660
EPDBE2025-10-PN	●			10	2	2.4	50	4	4	3.43	11.03	11.32	11.56	12.00	13.18	5,970
EPDBE2025-15-PN	●			15	2	2.4	55	4	4	2.46	16.18	16.56	17.20	17.98	干渉なし	7,080
EPDBE2025-20-PN	●			20	2	2.4	60	4	4	1.91	21.32	21.93	22.90	干渉なし	干渉なし	8,260
EPDBE2025-25-PN	●			25	2	2.4	65	4	4	1.57	26.44	27.38	28.60	干渉なし	干渉なし	8,850
EPDBE2025-30-PN	●			30	2	2.4	70	4	4	1.33	31.55	32.82	干渉なし	干渉なし	干渉なし	8,850
EPDBE2030-8-PN	●	1.5	3	8	2.5	2.88	55	6	4	6.19	8.99	9.23	9.44	9.62	10.51	5,310
EPDBE2030-10-PN	●			10	2.5	2.88	55	6	4	5.41	11.06	11.34	11.57	12.01	13.16	6,020
EPDBE2030-13-PN	●			13	2.5	2.88	60	6	4	4.56	14.15	14.48	14.94	15.60	17.15	7,080
EPDBE2030-16-PN	●			16	2.5	2.88	60	6	4	3.93	17.24	17.61	18.36	19.19	21.13	7,080
EPDBE2030-20-PN	●			20	2.5	2.88	65	6	4	3.33	21.34	21.96	22.92	23.97	26.44	6,840
EPDBE2030-25-PN	●			25	2.5	2.88	70	6	4	2.79	26.46	27.41	28.62	29.96	干渉なし	6,840
EPDBE2030-30-PN	●			30	2.5	2.88	75	6	4	2.40	31.57	32.85	34.32	35.94	干渉なし	7,790
EPDBE2030-35-PN	●			35	2.5	2.88	80	6	4	2.11	36.72	38.30	40.03	41.92	干渉なし	9,910
EPDBE2035-15-PN	●	1.75	3.5	15	2.75	3.35	60	6	4	3.68	16.25	16.60	17.26	18.03	19.81	7,790
EPDBE2035-25-PN	●			25	2.75	3.35	70	6	4	2.43	26.49	27.46	28.67	29.99	干渉なし	8,260
EPDBE2035-35-PN	●			35	2.75	3.35	80	6	4	1.82	36.79	38.36	40.07	干渉なし	干渉なし	10,610
EPDBE2035-45-PN	●			45	2.75	3.35	90	6	4	1.45	47.22	49.25	干渉なし	干渉なし	干渉なし	12,970
EPDBE2040-10-PN	●	2	4	10	3	3.85	55	6	4	4.38	11.10	11.36	11.58	12.00	13.10	5,430
EPDBE2040-13-PN	●			13	3	3.85	60	6	4	3.57	14.19	14.50	14.95	15.59	17.08	7,080
EPDBE2040-16-PN	●			16	3	3.85	60	6	4	3.01	17.27	17.63	18.37	19.18	干渉なし	7,080
EPDBE2040-20-PN	●			20	3	3.85	65	6	4	2.49	21.37	21.99	22.93	23.96	干渉なし	7,080
EPDBE2040-25-PN	●			25	3	3.85	70	6	4	2.05	26.49	27.44	28.63	29.95	干渉なし	7,080
EPDBE2040-30-PN	●			30	3	3.85	75	6	4	1.74	31.59	32.89	34.34	干渉なし	干渉なし	7,080
EPDBE2040-35-PN	●			35	3	3.85	80	6	4	1.51	36.78	38.33	40.04	干渉なし	干渉なし	8,140
EPDBE2040-40-PN	●			40	3	3.85	80	6	4	1.34	41.99	43.78	干渉なし	干渉なし	干渉なし	9,200
EPDBE2040-45-PN	●			45	3	3.85	90	6	4	1.20	47.20	49.23	干渉なし	干渉なし	干渉なし	11,790
EPDBE2040-50-PN	●			50	3	3.85	100	6	4	1.08	52.42	54.68	干渉なし	干渉なし	干渉なし	12,650
EPDBE2050-20-PN	●	2.5	5	20	3.5	4.85	65	6	4	1.42	21.36	21.95	干渉なし	干渉なし	干渉なし	12,350
EPDBE2050-25-PN	●			25	3.5	4.85	70	6	4	1.14	26.48	27.39	干渉なし	干渉なし	干渉なし	12,350
EPDBE2050-30-PN	●			30	3.5	4.85	75	6	4	0.95	31.58	干渉なし	干渉なし	干渉なし	干渉なし	13,250
EPDBE2050-40-PN	●			40	3.5	4.85	80	6	4	0.72	41.97	干渉なし	干渉なし	干渉なし	干渉なし	16,720
EPDBE2060-12-PN	●	3	6	12	6	5.85	60	6	-	0	干渉なし	干渉なし	干渉なし	干渉なし	干渉なし	9,270
EPDBE2060-20-PN	●			20	6	5.85	65	6	-	0	干渉なし	干渉なし	干渉なし	干渉なし	干渉なし	9,270
EPDBE2060-30-PN	●			30	6	5.85	75	6	-	0	干渉なし	干渉なし	干渉なし	干渉なし	干渉なし	9,510
EPDBE2060-50-PN	●			50	6	5.85	100	6	-	0	干渉なし	干渉なし	干渉なし	干渉なし	干渉なし	11,350

Ball End Mills

Ball End Mills

○ 対応被削材 Applicable work material

炭素鋼 合金鋼 Carbon steel Alloy steel	プリハー ド鋼 Pre-hardened steel	高硬度 Hardened steel			ステン レス鋼 Stainless steel	チタン合金 耐熱合金 Titanium alloy Heat-resistant alloy	銅合金 Copper alloy	アルミ 合金 Aluminum alloy
○	○	> 45HRC ≤ 55HRC	> 55HRC ≤ 65HRC	> 65HRC	○	○	○	○

○ 再研磨対応外径範囲 Re-grinding compatibility range

商品コード Item code	外周 Outer dia. (mm)	エンド End (mm)
EPDBE-PN	× (N/A)	1 ~ 6

【注意】首下長/外径が10DCを超える工具の再研磨可否については、弊社営業にお問い合わせください。
【Note】Contact our sales office regarding whether or not regrinding is possible for tools where under neck length/tool diameter more than 10DC



標準切削条件表

Recommended cutting conditions

高能率切削条件

High efficiency cutting conditions

高精度切削条件

High accuracy cutting conditions

EPDBE-ATH EPDBE-PN

高精度切削条件はA81ページを参照してください。
Please refer to P.A81 about high accuracy cutting conditions

推奨領域 Recommended range				PNシリーズ PN series											
				ATHシリーズ ATH series											
被削材 Work material				1	2	3	4	5	6						
				銅 Copper	炭素鋼・合金鋼 Carbon steels, Alloy steels (180~250HB)	ステンレス鋼・工具鋼 Stainless steels, Tool steels (25~35HRC)	プリハードン鋼 Pre-hardened steels (35~45HRC)	焼入れ鋼 Hardened steels (45~55HRC)	焼入れ鋼 Hardened steels (55~65HRC)						
切込み比率 Ratio to standard depth of cut				120%		100%		90%		80%		65%		60%	
ボール半径RE Ball radius (mm)	外径DC Tool dia. (mm)	首下長LU Under neck length (mm)	ap (mm)	回転数 n min ⁻¹	送り速度 vf mm/min	回転数 n min ⁻¹	送り速度 vf mm/min	回転数 n min ⁻¹	送り速度 vf mm/min	回転数 n min ⁻¹	送り速度 vf mm/min	回転数 n min ⁻¹	送り速度 vf mm/min	回転数 n min ⁻¹	送り速度 vf mm/min
0.05	0.1	0.2	0.008	50,000	300	50,000	250	50,000	250	50,000	225	50,000	200	50,000	188
		0.3	0.006	50,000	300	50,000	250	50,000	250	50,000	225	50,000	200	50,000	188
		0.5	0.004	50,000	300	50,000	250	50,000	250	50,000	225	50,000	200	50,000	188
0.1	0.2	0.5	0.02	50,000	420	50,000	350	50,000	350	50,000	325	45,500	273	42,000	210
		0.75	0.017	50,000	420	50,000	350	50,000	350	50,000	325	45,500	273	42,000	210
		1	0.014	50,000	420	50,000	350	50,000	350	50,000	325	45,500	273	42,000	210
		1.25	0.011	50,000	378	50,000	315	48,600	306	45,900	269	40,500	219	37,800	170
		1.5	0.008	50,000	378	50,000	315	48,600	306	45,900	269	40,500	219	37,800	170
		2	0.008	50,000	378	50,000	315	48,600	306	45,900	269	40,500	219	37,800	170
		2.5	0.006	48,000	323	48,000	269	43,200	242	40,800	212	36,000	173	33,600	134
		3	0.004	48,000	323	48,000	269	43,200	242	40,800	212	36,000	173	33,600	134
0.15	0.3	0.5	0.027	50,000	600	50,000	500	50,000	500	50,000	450	45,000	383	42,000	336
		0.75	0.024	50,000	600	50,000	500	50,000	500	50,000	450	45,000	383	42,000	336
		1	0.021	50,000	600	50,000	500	50,000	500	50,000	450	45,000	383	42,000	336
		1.25	0.019	50,000	600	50,000	500	50,000	500	50,000	450	45,000	383	42,000	336
		1.5	0.016	50,000	600	50,000	500	50,000	500	50,000	450	45,000	383	42,000	336
		2	0.012	50,000	540	50,000	450	48,600	437	45,900	372	40,500	310	37,800	272
0.2	0.4	2.5	0.01	50,000	540	50,000	450	48,600	437	45,900	372	40,500	310	37,800	272
		3	0.008	50,000	540	50,000	450	48,600	437	45,900	372	40,500	310	37,800	272
		0.75	0.043	50,000	967	50,000	840	50,000	839	50,000	770	46,800	655	43,680	612
		1	0.04	50,000	967	50,000	840	50,000	839	50,000	770	46,800	655	43,680	612
		1.5	0.034	50,000	829	50,000	720	50,000	719	50,000	660	46,800	468	43,680	437
		2	0.028	50,000	691	50,000	600	50,000	600	50,000	550	46,800	468	43,680	437
		2.5	0.022	50,000	560	43,200	467	38,880	420	36,720	364	32,400	292	36,288	272
		3	0.016	50,000	560	43,200	467	38,880	420	36,720	364	32,400	292	36,288	272
0.25	0.5	3.5	0.012	50,000	560	43,200	467	38,880	420	36,720	364	32,400	292	36,288	272
		4	0.01	50,000	560	43,200	467	38,880	420	36,720	364	32,400	292	36,288	272
		4.5	0.008	46,080	470	38,400	392	34,560	353	32,640	305	28,800	245	26,880	228
		1	0.045	50,000	1,500	50,000	1,500	46,800	1,404	44,200	1,193	39,000	1,053	36,400	743
		1.5	0.04	50,000	1,500	50,000	1,500	46,800	1,404	44,200	1,193	39,000	1,053	36,400	681
		2	0.035	50,000	1,200	50,000	1,200	46,800	1,123	44,200	955	39,000	842	36,400	681
		2.5	0.033	50,000	1,081	50,000	1,000	42,120	758	39,780	645	35,100	568	32,760	502
		3	0.03	50,000	900	46,800	842	42,120	758	39,780	645	35,100	568	25,200	386
		4	0.02	43,200	778	36,000	648	32,400	583	30,600	496	32,400	524	25,200	386
		5	0.018	43,200	778	36,000	648	32,400	583	30,600	496	32,400	524	25,200	386
0.3	0.6	5.5	0.015	38,400	653	32,000	544	28,800	490	27,200	416	24,000	367	22,400	324
		6	0.013	38,400	653	32,000	544	28,800	490	27,200	416	24,000	367	22,400	324
		8	0.008	38,400	653	32,000	544	28,800	490	27,200	416	24,000	367	22,400	324
		1	0.075	50,000	2,250	50,000	2,250	50,000	2,250	50,000	1,950	48,000	1,728	44,800	1,344
		2	0.063	50,000	2,250	50,000	2,250	50,000	2,250	50,000	1,950	48,000	1,728	44,800	1,344
		2.5	0.046	50,000	1,800	50,000	1,800	50,000	1,800	50,000	1,560	48,000	1,382	44,800	986
		3	0.041	50,000	1,800	50,000	1,800	50,000	1,800	50,000	1,560	48,000	1,382	44,800	986
		3.5	0.035	50,000	1,710	50,000	1,710	50,000	1,709	48,960	1,452	43,200	1,183	40,320	843
		4	0.026	50,000	1,710	50,000	1,710	50,000	1,709	48,960	1,452	43,200	1,183	40,320	766
		4.5	0.022	50,000	1,350	50,000	1,350	48,600	1,313	45,900	1,074	40,500	875	37,800	681
		5	0.02	50,000	1,350	46,800	1,264	42,120	1,138	39,780	931	35,100	758	32,760	590
		5.5	0.017	50,000	1,350	46,800	1,264	42,120	1,138	39,780	931	35,100	758	32,760	590
0.35	0.7	6	0.015	50,000	1,350	46,800	1,264	42,120	1,138	39,780	931	35,100	758	32,760	590
		7	0.015	38,400	979	32,000	816	28,800	881	27,200	601	24,000	490	22,400	495
		8	0.015	38,400	979	32,000	816	28,800	734	27,200	601	24,000	490	22,400	381
		9	0.012	38,400	979	32,000	816	28,800	734	27,200	601	24,000	490	22,400	381
		10	0.009	33,600	857	28,000	714	25,200	643	23,800	526	21,000	428	19,600	333
		12	0.007	28,800	691	24,000	576	21,600	518	20,400	424	18,000	346	16,800	269
		2	0.092	50,000	2,475	50,000	2,475	50,000	2,475	50,000	2,155	48,000	1,932	42,000	1,188
		4	0.041	50,000	1,880	50,000	1,880	50,000	1,880	48,960	1,603	43,200	1,321	37,800	846
6	0.027	50,000	1,485	46,800	1,390	42,120	1,251	39,780	1,028	35,100	848	30,240	641		
8	0.02	38,400	1,013	32,000	844	28,800	760	27,200	625	24,000	515	22,400	422		

超硬ボールエポック

推奨領域 Recommended range				PNシリーズ PN series											
				ATHシリーズ ATH series											
被削材 Work material				1		2		3		4		5		6	
				銅 Copper		炭素鋼・合金鋼 Carbon steels, Alloy steels (180~250HB)		ステンレス鋼・工具鋼 Stainless steels, Tool steels (25~35HRC)		プリハードン鋼 Pre-hardened steels (35~45HRC)		焼入れ鋼 Hardened steels (45~55HRC)		焼入れ鋼 Hardened steels (55~65HRC)	
切込み比率 Ratio to standard depth of cut				120%		100%		90%		80%		65%		60%	
ボール半径RE Ball radius (mm)	外径DC Tool dia. (mm)	首下長LU Under neck length (mm)	ap (mm)	回転数 n min ⁻¹	送り速度 Vf mm/min	回転数 n min ⁻¹	送り速度 Vf mm/min	回転数 n min ⁻¹	送り速度 Vf mm/min	回転数 n min ⁻¹	送り速度 Vf mm/min	回転数 n min ⁻¹	送り速度 Vf mm/min	回転数 n min ⁻¹	送り速度 Vf mm/min
0.4	0.8	2	0.12	50,000	2,700	50,000	2,700	50,000	2,700	50,000	2,400	48,000	2,592	44,800	1,882
		4	0.078	50,000	2,700	50,000	2,700	50,000	2,700	50,000	2,400	48,000	2,592	44,800	1,882
		5	0.059	50,000	2,431	50,000	2,429	50,000	2,431	48,960	2,114	43,200	2,123	40,320	1,524
		6	0.042	50,000	2,269	50,000	2,267	45,360	2,058	42,840	1,727	37,800	1,429	35,280	1,245
		8	0.02	49,920	1,617	41,600	1,348	37,440	1,213	35,360	1,018	31,200	842	29,120	733
		10	0.02	38,400	1,175	32,000	979	28,800	881	27,200	740	24,000	612	22,400	533
0.45	0.9	2	0.135	50,000	3,197	50,000	3,197	50,000	3,197	50,000	2,821	45,600	2,411	42,560	2,138
		4	0.081	50,000	2,771	50,000	2,771	50,000	2,771	48,450	2,369	42,750	1,959	39,900	1,737
		6	0.05	50,000	2,302	47,880	2,020	43,092	1,818	40,698	1,515	35,910	1,253	33,516	1,111
		8	0.036	43,776	1,679	36,480	1,399	32,832	1,259	31,008	1,049	27,360	868	25,536	770
0.5	1	2	0.2	50,000	3,750	50,000	3,750	48,600	3,645	45,900	3,098	43,200	2,722	37,800	2,268
		3	0.2	50,000	3,750	50,000	3,750	48,600	3,645	45,900	3,098	43,200	2,722	37,800	2,268
		4	0.14	50,000	3,750	50,000	3,750	48,600	3,645	45,900	3,098	43,200	2,722	37,800	2,268
		5	0.09	50,000	3,500	46,800	3,276	42,120	2,948	39,780	2,596	43,200	2,540	32,760	1,835
		6	0.06	50,000	3,151	42,120	2,654	40,824	2,558	38,556	2,319	38,880	2,353	29,484	1,379
		7	0.06	46,656	2,100	38,880	1,750	34,992	1,574	33,048	1,338	31,590	1,323	27,216	1,061
		8	0.06	46,656	2,100	38,880	1,750	34,992	1,574	33,048	1,338	31,590	1,323	27,216	979
		9	0.045	46,656	2,100	38,880	1,750	34,992	1,574	33,048	1,338	31,590	1,323	27,216	979
		10	0.038	46,656	2,100	38,880	1,750	34,992	1,574	33,048	1,338	31,590	1,323	27,216	979
		12	0.025	34,560	1,469	28,800	1,224	25,920	1,102	24,480	936	21,600	771	20,160	685
		13	0.023	34,560	1,469	28,800	1,224	25,920	1,102	24,480	936	21,600	771	20,160	685
		14	0.02	34,560	1,469	28,800	1,224	25,920	1,102	24,480	936	21,600	771	20,160	685
		16	0.015	34,560	1,469	28,800	1,224	25,920	1,102	24,480	936	21,600	771	20,160	685
18	0.012	30,240	1,210	25,200	1,008	22,680	907	21,420	771	18,900	635	17,640	564		
20	0.01	25,920	1,037	21,600	864	19,440	778	18,360	661	16,200	544	15,120	484		
0.55	1.1	2	0.2	50,000	3,924	50,000	3,924	45,360	3,560	42,840	2,927	37,800	2,452	35,280	2,176
		4	0.14	50,000	3,924	50,000	3,924	45,360	3,560	42,840	2,927	37,800	2,452	35,280	2,176
		6	0.06	47,736	2,767	39,780	2,306	35,802	2,075	33,813	1,706	29,835	1,430	27,846	1,268
		8	0.06	47,736	2,306	39,780	2,306	35,802	1,729	31,212	1,312	27,540	1,100	25,704	975
		10	0.038	47,736	2,306	39,780	1,774	35,802	1,729	31,212	1,312	27,540	1,100	25,704	975
0.6	1.2	4	0.16	50,000	3,924	46,154	3,743	41,538	3,260	39,230	2,717	36,923	2,555	32,307	1,860
		6	0.11	44,928	2,570	37,440	2,142	33,696	2,103	31,824	2,069	30,240	2,062	26,208	1,048
		8	0.06	44,928	2,570	37,440	2,142	33,696	2,103	31,824	2,069	30,240	2,062	26,208	1,048
		10	0.053	41,472	1,940	34,560	1,708	31,104	1,456	29,376	1,322	27,000	1,069	24,192	871
		12	0.045	41,472	1,940	34,560	1,618	31,104	1,456	29,376	1,322	25,920	1,026	24,192	871
0.7	1.4	8	0.11	39,312	2,830	32,760	2,359	29,484	2,123	27,846	1,805	24,570	1,533	22,932	1,376
		12	0.053	36,288	1,960	30,240	1,633	27,216	1,470	25,704	1,249	22,680	1,062	21,168	953
		16	0.035	26,880	1,371	22,400	1,142	20,160	1,028	19,040	874	16,800	743	15,680	666
0.75	1.5	4	0.2	50,000	4,951	42,000	4,158	37,800	3,742	35,700	3,213	31,500	2,552	29,400	2,205
		6	0.2	50,000	4,951	42,000	4,158	37,800	3,742	35,700	3,213	31,500	2,552	29,400	2,205
		8	0.09	39,312	2,802	32,760	2,627	29,484	2,101	27,846	1,805	24,570	1,434	22,932	1,239
		10	0.09	36,288	2,586	30,240	2,156	27,216	1,940	25,704	1,666	22,680	1,323	21,168	1,143
		12	0.09	36,288	2,155	30,240	1,796	27,216	1,616	25,704	1,388	22,680	1,103	21,168	953
		14	0.075	32,256	1,810	30,240	1,796	24,192	1,357	22,848	1,165	20,160	925	18,816	799
		16	0.038	26,880	1,508	22,400	1,257	20,160	1,131	19,040	971	16,800	771	15,680	666
		18	0.038	26,880	1,508	22,400	1,257	20,160	1,131	19,040	971	16,800	771	15,680	666
		20	0.038	26,880	1,508	22,400	1,257	20,160	1,131	19,040	971	16,800	771	15,680	666
0.8	1.6	8	0.22	43,680	3,669	36,400	3,058	32,760	2,752	30,940	2,493	27,300	2,129	23,660	1,590
		12	0.098	39,312	3,467	32,760	2,889	29,484	2,601	27,846	2,176	24,570	1,858	21,294	1,289
		16	0.06	33,696	2,123	28,080	1,769	25,272	1,592	23,868	1,332	21,060	1,138	19,656	991
		20	0.04	24,960	1,485	20,800	1,238	18,720	1,114	17,680	932	15,600	796	14,560	693
0.9	1.8	8	0.26	40,560	3,894	33,800	3,245	30,420	2,920	28,730	2,413	25,350	2,008	23,660	1,704
		12	0.105	33,696	2,426	28,080	2,022	25,272	1,819	23,868	1,504	21,060	1,250	19,656	1,062
		16	0.068	33,696	2,426	28,080	2,022	25,272	1,819	23,868	1,504	21,060	1,250	19,656	1,062
		20	0.045	24,960	1,697	20,800	1,414	18,720	1,273	17,680	1,052	15,600	875	14,560	743
1	2	3	0.4	37,800	5,670	31,500	4,725	28,350	4,253	26,775	3,616	23,625	3,049	22,050	2,646
		4	0.4	37,800	5,670	31,500	4,725	28,350	4,253	26,775	3,616	23,625	3,049	22,050	2,646
		6	0.4	37,800	5,103	31,500	4,253	28,350	3,827	26,775	3,213	23,625	2,693	22,050	2,381
		8	0.28	37,800	5,103	31,500	4,253	28,350	3,827	26,775	3,213	23,625	2,693	22,050	2,381
		10	0.21	35,280	4,234	29,400	3,528	26,460	3,175	24,990	2,699	22,050	2,249	19,110	1,468

[注意] ご使用にあたっては、A80ページの表下の項目と注意を参照してください。 **[Note]** Upon usage, please refer to comments and notes below table on page A80.

EPDBE-ATH EPDBE-PN

高能率切削条件
High efficiency cutting conditions

高精度切削条件
High accuracy cutting conditions

高精度切削条件はA81ページを参照してください。
Please refer to P.A81 about high accuracy cutting conditions

推奨領域 Recommended range		PNシリーズ PN series													
		ATHシリーズ ATH series													
被削材 Work material		1		2		3		4		5		6			
		銅 Copper		炭素鋼・合金鋼 Carbon steels, Alloy steels (180~250HB)		ステンレス鋼・工具鋼 Stainless steels, Tool steels (25~35HRC)		プリハードン鋼 Pre-hardened steels (35~45HRC)		焼入れ鋼 Hardened steels (45~55HRC)		焼入れ鋼 Hardened steels (55~65HRC)			
切込み比率 Ratio to standard depth of cut		120%		100%		90%		80%		65%		60%			
ボール半径RE Ball radius (mm)	外径DC Tool dia. (mm)	首下長LU Under neck length (mm)	ap (mm)	回転数 n min ⁻¹	送り速度 vf mm/min	回転数 n min ⁻¹	送り速度 vf mm/min	回転数 n min ⁻¹	送り速度 vf mm/min	回転数 n min ⁻¹	送り速度 vf mm/min	回転数 n min ⁻¹	送り速度 vf mm/min		
1	2	12	0.12	31,752	3,809	26,460	3,175	23,814	2,858	22,491	2,430	19,845	2,051	17,199	1,321
		13	0.12	31,752	3,809	26,460	3,175	23,814	2,858	22,491	2,430	19,845	2,024	15,876	1,016
		14	0.12	31,752	3,301	26,460	2,752	23,814	2,477	22,491	2,106	18,428	1,629	15,876	1,016
		16	0.12	29,484	2,123	24,570	1,769	22,113	1,593	20,885	1,353	18,428	1,467	15,876	914
		18	0.09	27,216	1,960	22,680	1,633	20,412	1,470	19,278	1,249	18,428	1,354	15,876	914
		20	0.075	27,216	1,960	22,680	1,633	20,412	1,470	19,278	1,249	18,428	1,128	15,876	914
		22	0.05	21,420	1,457	17,850	1,214	16,065	1,092	15,173	929	13,388	774	14,994	816
		25	0.05	20,160	1,371	16,800	1,142	15,120	1,028	14,280	874	12,600	728	14,112	768
		30	0.03	20,160	1,371	16,800	1,142	15,120	1,028	14,280	874	12,600	728	14,112	768
		35	0.025	17,640	1,129	14,700	941	13,230	847	12,495	720	11,025	600	10,290	527
		40	0.022	15,120	968	12,600	806	11,340	726	10,710	617	9,450	514	8,820	452
1.25	2.5	6	0.5	33,300	6,075	27,750	5,063	24,975	4,556	23,588	3,797	20,813	3,088	19,425	2,531
		10	0.34	33,300	6,075	27,750	5,063	24,975	4,556	23,588	3,797	20,813	3,088	19,425	2,531
		15	0.15	25,974	3,411	21,645	2,842	19,481	2,558	18,398	2,132	16,234	2,023	15,152	1,421
		20	0.12	23,976	2,624	19,980	2,186	17,982	1,968	16,983	1,640	16,234	1,445	13,986	1,093
		25	0.098	23,976	2,360	19,980	1,967	17,982	1,770	16,983	1,475	14,985	1,200	13,986	983
		30	0.055	17,760	1,836	14,800	1,530	13,320	1,377	12,580	1,148	11,100	933	10,360	765
1.5	3	8	0.6	28,800	6,480	24,000	5,400	21,600	4,860	20,400	4,100	18,000	3,402	16,800	3,024
		10	0.42	28,800	6,480	24,000	5,400	21,600	4,860	20,400	4,100	18,000	3,402	16,800	3,024
		13	0.315	26,880	4,838	22,400	4,032	20,160	3,629	19,040	3,061	16,800	2,540	15,680	2,258
		16	0.315	26,880	4,355	22,400	3,629	20,160	3,266	19,040	2,755	16,800	2,286	14,560	1,888
		20	0.18	22,464	3,033	18,720	2,527	16,848	2,275	15,912	1,919	14,040	1,593	12,096	1,307
		25	0.12	22,464	3,033	18,720	2,527	16,848	2,275	15,912	1,919	14,040	1,593	12,096	1,307
		30	0.12	20,736	2,800	17,280	2,333	15,552	2,100	14,688	1,771	12,960	1,470	12,096	1,307
		35	0.08	15,360	1,958	12,800	1,632	11,520	1,469	10,880	1,239	9,600	1,028	10,752	1,097
1.75	3.5	15	0.36	21,450	4,399	17,875	3,666	16,088	3,299	15,194	2,750	13,406	2,236	12,513	1,833
		25	0.21	17,820	2,736	14,850	2,280	13,365	2,052	12,623	1,710	11,138	1,391	10,395	1,140
		35	0.09	17,820	2,736	14,850	2,280	13,365	2,052	12,623	1,710	11,138	1,391	10,395	1,140
		45	0.09	13,200	1,918	11,000	1,598	9,900	1,438	9,350	1,199	8,250	975	7,700	799
2	4	10	0.6	20,700	6,210	17,250	5,175	15,525	4,658	14,663	3,960	12,938	3,299	12,075	2,898
		13	0.48	20,700	6,210	17,250	5,175	15,525	4,658	14,663	3,960	12,938	3,299	12,075	2,898
		16	0.42	20,700	6,210	17,250	5,175	15,525	4,658	14,663	3,960	12,938	3,299	12,075	2,898
		20	0.42	17,940	4,306	14,950	3,588	13,455	3,229	12,708	2,746	11,213	2,287	10,465	2,009
		25	0.24	16,146	3,488	13,455	2,906	12,110	2,616	11,437	2,223	10,092	2,162	9,419	1,627
		30	0.16	14,904	2,683	12,420	2,236	11,178	2,012	10,558	1,710	9,316	1,426	8,694	1,252
		35	0.1	14,904	2,683	12,420	2,236	11,178	2,012	10,558	1,710	9,316	1,426	8,694	1,252
		40	0.1	14,904	2,683	12,420	2,236	11,178	2,012	10,558	1,710	9,316	1,426	8,694	1,252
		45	0.1	11,040	1,877	9,200	1,564	8,280	1,408	7,820	1,196	6,900	997	6,440	876
		50	0.1	11,040	1,877	9,200	1,564	8,280	1,408	7,820	1,196	6,900	997	6,440	876
2.5	5	20	0.525	15,120	5,443	12,600	4,536	11,340	4,082	10,710	3,213	9,450	2,835	8,820	2,381
		25	0.525	14,040	5,054	11,700	3,650	10,530	3,791	9,945	2,984	8,775	2,633	8,190	2,211
		30	0.3	12,636	4,549	10,530	2,780	9,477	3,413	8,951	2,685	7,898	2,369	7,371	1,991
		40	0.2	11,664	2,520	9,720	2,100	8,748	1,890	8,262	1,487	7,290	1,313	6,804	1,103
3	6	12	0.6	16,200	6,804	13,500	5,670	12,150	5,103	11,475	4,253	10,125	3,459	9,450	2,835
		20	0.5	15,300	5,967	12,750	4,973	11,475	4,475	10,838	3,729	9,563	3,033	8,925	2,486
		30	0.42	12,480	3,594	10,400	2,995	9,360	2,696	8,840	2,122	7,800	2,028	7,280	1,572
		50	0.15	10,368	2,687	8,640	2,239	7,776	2,016	7,344	1,587	6,480	1,400	6,048	1,175

- ※(1) apは被削材グループ2での目安を示しています。その他のグループの場合は、上表の切込み比率を目安に調整してください。
- ※(2) リブ加工や止まり溝など、切りくずがつまりやすい切削の場合、切込み設定は基本切込み比に切込み比率をかけて算出した切込み量を、さらにその80%まで小さくして使用してください。
- ※(3) aeの設定は ap×切込み比率×3~5倍を目安に調整してください。仕上げ加工を行う場合、理論カスプハイトを計算し設定してください。

※(1) ap is shown as the criteria for Group 2 workpieces. For other groups, adjust the cutting depth according to the cutting depth factors in the above table.
 ※(2) When performing cutting where cutting chips may cause clogging, such as for rib cutting, blind grooves, etc., cutting depth setting should be set by multiplying a cutting depth factor to calculate the cutting depth amount, and this amount should then be reduced to 80% of the calculated value.
 ※(3) Adjust by setting ae to (3 to 5) × (ap) × (cutting depth ratio). When performing finishing processing, calculate the theoretical cusp height and set accordingly.

【切込み設定例】 EPDBE2020-10-ATHの工具で焼入れ鋼(50HRC)をリブ溝等高線切削する場合、
 切込み=0.21 (ap) × 0.65 (焼入れ鋼グループ5の切込み比率) × 0.8 (閉鎖域の切削) = 0.11 mm

Cutting depth setting example: When cutting rib groove contours in hardened steel (50HRC) using an EPDBE2020-10-ATH tool:
 Cutting depth = 0.21 (ap) × 0.65 (cutting depth factor for Group 5 hardened steel) × 0.8 (for closed-area cutting) = 0.11 mm

【注意】 ①PNコーティングはその性質上、通電性が微小です。従って、通電方式の工具長測定装置をご使用の際にはご注意ください。

②被削材、加工形状に合わせて、適切なクーラントを使用してください。
 ③この標準切削条件表は切削条件の目安を示すものです。実際の加工では加工形状、目的、使用機械等により条件を調整してください。
 ④機械の回転数が足りない場合は、回転数と送り速度を同じ比率で下げてください。

【Note】 ① PN coating is less electro conductive. Therefore, electric transmitted measuring systems may not work.
 ② Use the appropriate coolant for the work material and machining shape.
 ③ These Recommended Cutting Conditions indicate only the rule of a thumb for the cutting conditions. In actual machining, the condition should be adjusted according to the machining shape, purpose and the machine type.
 ④ If the rpm of the machine is low, lower the feed rate also to put the rpm and feed rate in the same ratio.



標準切削条件表

Recommended cutting conditions

高能率切削条件
High efficiency cutting condition

高精度切削条件
High accuracy cutting condition

EPDBE-ATH | EPDBE-PN

高能率切削条件はA78ページを参照してください。
Please refer to P.A78 about high efficiency cutting conditions

推奨領域 Recommended range				PNシリーズ PN series											
				ATHシリーズ ATH series											
被削材 Work material				1	2	3	4	5	6						
				銅 Copper	炭素鋼・合金鋼 Carbon steels, Alloy steels (180~250HB)	ステンレス鋼・工具鋼 Stainless steels, Tool steels (25~35HRC)	プリハードン鋼 Pre-hardened steels (35~45HRC)	焼入れ鋼 Hardened steels (45~55HRC)	焼入れ鋼 Hardened steels (55~65HRC)						
切込み比率 Ratio to standard depth of cut				120%		100%		90%		80%		65%		60%	
ボール半径R Ball radius (mm)	外径DC Tool dia. (mm)	首下長LU Under neck length (mm)	ap (mm)	回転数 n min ⁻¹	送り速度 vf mm/min	回転数 n min ⁻¹	送り速度 vf mm/min	回転数 n min ⁻¹	送り速度 vf mm/min	回転数 n min ⁻¹	送り速度 vf mm/min	回転数 n min ⁻¹	送り速度 vf mm/min	回転数 n min ⁻¹	送り速度 vf mm/min
0.05	0.1	0.2	0.004	50,000	300	50,000	250	50,000	250	50,000	225	50,000	200	50,000	188
		0.3	0.003	50,000	300	50,000	250	50,000	250	50,000	225	50,000	200	50,000	188
		0.5	0.002	50,000	300	50,000	250	50,000	250	50,000	225	50,000	200	50,000	188
0.1	0.2	0.5	0.015	50,000	420	50,000	350	50,000	350	50,000	325	45,500	273	42,000	210
		0.75	0.013	50,000	420	50,000	350	50,000	350	50,000	325	45,500	273	42,000	210
		1	0.011	50,000	420	50,000	350	50,000	350	50,000	325	45,500	273	42,000	210
		1.25	0.008	50,000	378	50,000	315	48,600	306	45,900	269	40,500	219	37,800	170
		1.5	0.007	50,000	378	50,000	315	48,600	306	45,900	269	40,500	219	37,800	170
		2	0.006	50,000	378	50,000	315	48,600	306	45,900	269	40,500	219	37,800	170
		2.5	0.005	48,000	323	48,000	269	43,200	242	40,800	212	36,000	173	33,600	134
		3	0.003	48,000	323	48,000	269	43,200	242	40,800	212	36,000	173	33,600	134
0.15	0.3	0.5	0.02	50,000	600	50,000	500	50,000	500	50,000	450	45,000	383	42,000	336
		0.75	0.018	50,000	600	50,000	500	50,000	500	50,000	450	45,000	383	42,000	336
		1	0.016	50,000	600	50,000	500	50,000	500	50,000	450	45,000	383	42,000	336
		1.25	0.014	50,000	600	50,000	500	50,000	500	50,000	450	45,000	383	42,000	336
		1.5	0.012	50,000	600	50,000	500	50,000	500	50,000	450	45,000	383	42,000	336
		2	0.009	50,000	540	50,000	450	48,600	437	45,900	372	40,500	310	37,800	272
		2.5	0.008	50,000	540	50,000	450	48,600	437	45,900	372	40,500	310	37,800	272
		3	0.006	50,000	540	50,000	450	48,600	437	45,900	372	40,500	310	37,800	272
0.2	0.4	0.75	0.043	50,000	691	48,000	576	43,200	518	40,800	449	36,000	360	33,600	336
		1	0.04	50,000	691	48,000	576	43,200	518	40,800	449	36,000	360	33,600	336
		1.5	0.034	50,000	691	48,000	576	43,200	518	40,800	449	36,000	360	33,600	336
		2	0.028	50,000	691	48,000	576	43,200	518	40,800	449	36,000	360	33,600	336
		2.5	0.016	50,000	560	43,200	467	38,880	420	36,720	364	32,400	292	30,240	272
		3	0.011	50,000	560	43,200	467	38,880	420	36,720	364	32,400	292	30,240	272
		3.5	0.008	50,000	560	43,200	467	38,880	420	36,720	364	32,400	292	30,240	272
		4	0.005	50,000	560	43,200	467	38,880	420	36,720	364	32,400	292	30,240	272
0.25	0.5	4.5	0.004	46,080	470	38,400	392	34,560	353	32,640	305	28,800	245	26,880	228
		1	0.045	48,000	960	40,000	800	36,000	720	34,000	612	30,000	540	28,000	476
		1.5	0.04	48,000	960	40,000	800	36,000	720	34,000	612	30,000	540	28,000	476
		2	0.035	48,000	960	40,000	800	36,000	720	34,000	612	30,000	540	28,000	476
		2.5	0.033	43,200	778	40,000	800	32,400	583	30,600	496	27,000	437	25,200	386
		3	0.03	43,200	778	36,000	648	32,400	583	30,600	496	27,000	437	25,200	386
		4	0.02	43,200	778	36,000	648	32,400	583	30,600	496	27,000	437	25,200	386
		5	0.018	43,200	778	36,000	648	32,400	583	30,600	496	27,000	437	25,200	386
0.3	0.6	5.5	0.008	38,400	653	32,000	544	28,800	490	27,200	416	24,000	367	22,400	324
		6	0.007	38,400	653	32,000	544	28,800	490	27,200	416	24,000	367	22,400	324
		8	0.004	38,400	653	32,000	544	28,800	490	27,200	416	24,000	367	22,400	324
		1	0.05	48,000	1,440	40,000	1,200	36,000	1,080	34,000	884	30,000	720	28,000	560
		2	0.042	48,000	1,440	40,000	1,200	36,000	1,080	34,000	884	30,000	720	28,000	560
		2.5	0.038	48,000	1,440	40,000	1,200	36,000	1,080	34,000	884	30,000	720	28,000	560
		3	0.034	48,000	1,440	40,000	1,200	36,000	1,080	34,000	884	30,000	720	28,000	560
		3.5	0.029	43,200	1,231	36,000	1,026	32,400	923	30,600	756	27,000	616	25,200	479
		4	0.024	43,200	1,231	36,000	1,026	32,400	923	30,600	756	27,000	616	25,200	479
		4.5	0.022	43,200	1,166	36,000	972	32,400	875	30,600	716	27,000	583	25,200	454
		5	0.02	43,200	1,166	36,000	972	32,400	875	30,600	716	27,000	583	25,200	454
		5.5	0.017	43,200	1,166	36,000	972	32,400	875	30,600	716	27,000	583	25,200	454
0.35	0.7	6	0.015	43,200	1,166	36,000	972	32,400	875	30,600	716	27,000	583	25,200	454
		7	0.008	38,400	979	32,000	816	28,800	734	27,200	601	24,000	490	22,400	381
		8	0.008	38,400	979	32,000	816	28,800	734	27,200	601	24,000	490	22,400	381
		9	0.006	38,400	979	32,000	816	28,800	734	27,200	601	24,000	490	22,400	381
		10	0.005	33,600	857	28,000	714	25,200	643	23,800	526	21,000	428	19,600	333
		12	0.004	28,800	691	24,000	576	21,600	518	20,400	424	18,000	346	16,800	269
		2	0.061	48,000	1,584	40,000	1,320	36,000	1,188	34,000	977	30,000	805	28,000	660
		4	0.034	43,200	1,354	36,000	1,128	32,400	1,015	30,600	835	27,000	688	25,200	564
6	0.027	43,200	1,283	36,000	1,069	32,400	962	30,600	791	27,000	652	25,200	535		
8	0.01	38,400	1,013	32,000	844	28,800	760	27,200	625	24,000	515	22,400	422		

[注意] ご使用にあたっては、A83ページの表下の項目と注意を参照してください。 **[Note]** Upon usage, please refer to comments and notes below table on page A83.

EPDBE-ATH

EPDBE-PN

高能率切削条件
High efficiency cutting condition

高精度切削条件
High accuracy cutting condition

高能率切削条件はA78ページを参照してください。
Please refer to P.A78 about high efficiency cutting conditions

超硬加工用ボール

推奨領域 Recommended range		PNシリーズ PN series													
		ATHシリーズ ATH series						PNシリーズ PN series							
被削材 Work material		1		2		3		4		5		6			
		銅 Copper		炭素鋼・合金鋼 Carbon Steels, Alloy Steels (180~250HB)		ステンレス鋼・工具鋼 Stainless Steels, Tool Steels (25~35HRC)		プリハードン鋼 Pre-hardened Steels (35~45HRC)		焼入れ鋼 Hardened Steels (45~55HRC)		焼入れ鋼 Hardened Steels (55~65HRC)			
切込み比率 Ratio to standard depth of cut		120%		100%		90%		80%		65%		60%			
ボール半径 Ball radius (mm)	外径DC Tool dia. (mm)	首下長LU Under neck length (mm)	ap (mm)	回転数 n min ⁻¹		送り速度 vf mm/min		回転数 n min ⁻¹		送り速度 vf mm/min		回転数 n min ⁻¹		送り速度 vf mm/min	
				0.4	0.8	2	0.08	48,000	1,728	40,000	1,440	36,000	1,296	34,000	1,088
		4	0.056	48,000	1,728	40,000	1,440	36,000	1,296	34,000	1,088	30,000	900	28,000	784
		5	0.045	43,200	1,400	36,000	1,166	32,400	1,050	30,600	881	27,000	729	25,200	635
		6	0.032	43,200	1,400	36,000	1,166	32,400	1,050	30,600	881	27,000	729	25,200	635
		8	0.02	38,400	1,244	32,000	1,037	28,800	933	27,200	783	24,000	648	22,400	564
		10	0.01	38,400	1,175	32,000	979	28,800	881	27,200	740	24,000	612	22,400	533
0.45	0.9	2	0.09	45,600	1,944	38,000	1,620	34,200	1,458	32,300	1,215	28,500	1,004	26,600	891
		4	0.058	45,600	1,944	38,000	1,620	34,200	1,458	32,300	1,215	28,500	1,004	26,600	891
		6	0.042	41,040	1,574	34,200	1,312	30,780	1,181	29,070	984	25,650	813	23,940	722
		8	0.03	36,480	1,399	30,400	1,166	27,360	1,049	25,840	875	22,800	723	21,280	641
0.5	1	2	0.1	43,200	2,160	36,000	1,800	32,400	1,620	30,600	1,377	27,000	1,134	25,200	1,008
		3	0.1	43,200	2,160	36,000	1,800	32,400	1,620	30,600	1,377	27,000	1,134	25,200	1,008
		4	0.07	43,200	2,160	36,000	1,800	32,400	1,620	30,600	1,377	27,000	1,134	25,200	1,008
		5	0.06	43,200	2,160	36,000	1,800	32,400	1,620	30,600	1,377	27,000	1,134	25,200	1,008
		6	0.04	38,880	1,750	32,400	1,458	29,160	1,312	27,540	1,115	24,300	919	22,680	816
		7	0.04	38,880	1,750	32,400	1,458	29,160	1,312	27,540	1,115	24,300	919	22,680	816
		8	0.04	38,880	1,750	32,400	1,458	29,160	1,312	27,540	1,115	24,300	919	22,680	816
		9	0.03	38,880	1,750	32,400	1,458	29,160	1,312	27,540	1,115	24,300	919	22,680	816
		10	0.025	38,880	1,750	32,400	1,458	29,160	1,312	27,540	1,115	24,300	919	22,680	816
		12	0.013	34,560	1,469	28,800	1,224	25,920	1,102	24,480	936	21,600	771	20,160	685
		13	0.011	34,560	1,469	28,800	1,224	25,920	1,102	24,480	936	21,600	771	20,160	685
		14	0.01	34,560	1,469	28,800	1,224	25,920	1,102	24,480	936	21,600	771	20,160	685
		16	0.008	34,560	1,469	28,800	1,224	25,920	1,102	24,480	936	21,600	771	20,160	685
		18	0.006	30,240	1,210	25,200	1,008	22,680	907	21,420	771	18,900	635	17,640	564
		20	0.005	25,920	1,037	21,600	864	19,440	778	18,360	661	16,200	544	15,120	484
0.55	1.1	2	0.1	40,320	2,110	33,600	1,758	30,240	1,582	28,560	1,301	25,200	1,090	23,520	967
		4	0.07	40,320	2,110	33,600	1,758	30,240	1,582	28,560	1,301	25,200	1,090	23,520	967
		6	0.04	36,720	1,774	30,600	1,478	27,540	1,330	26,010	1,094	22,950	916	21,420	813
		8	0.04	36,720	1,774	30,600	1,478	27,540	1,330	26,010	1,094	22,950	916	21,420	813
		10	0.025	36,720	1,774	30,600	1,478	27,540	1,330	26,010	1,094	22,950	916	21,420	813
0.6	1.2	4	0.08	36,923	1,932	30,769	1,610	27,692	1,449	26,154	1,208	23,077	998	21,538	886
		6	0.06	34,560	1,797	28,800	1,498	25,920	1,348	24,480	1,102	21,600	950	20,160	806
		8	0.04	34,560	1,797	28,800	1,498	25,920	1,348	24,480	1,102	21,600	950	20,160	806
		10	0.035	34,560	1,617	28,800	1,423	25,920	1,213	24,480	1,102	21,600	855	20,160	726
		12	0.03	34,560	1,617	28,800	1,348	25,920	1,213	24,480	1,102	21,600	855	20,160	726
0.7	1.4	8	0.055	30,240	1,814	25,200	1,512	22,680	1,361	21,420	1,157	18,900	983	17,640	882
		12	0.035	30,240	1,633	25,200	1,361	22,680	1,225	21,420	1,041	18,900	885	17,640	794
		16	0.017	26,880	1,371	22,400	1,142	20,160	1,028	19,040	874	16,800	743	15,680	666
0.75	1.5	4	0.1	33,600	2,218	28,000	1,848	25,200	1,663	23,800	1,428	21,000	1,134	19,600	980
		6	0.1	33,600	2,218	28,000	1,848	25,200	1,663	23,800	1,428	21,000	1,134	19,600	980
		8	0.06	30,240	1,796	25,200	1,497	22,680	1,347	21,420	1,157	18,900	919	17,640	794
		10	0.06	30,240	1,796	25,200	1,497	22,680	1,347	21,420	1,157	18,900	919	17,640	794
		12	0.06	30,240	1,796	25,200	1,497	22,680	1,347	21,420	1,157	18,900	919	17,640	794
		14	0.05	26,880	1,508	22,400	1,497	20,160	1,131	19,040	971	16,800	771	15,680	666
		16	0.019	26,880	1,508	22,400	1,257	20,160	1,131	19,040	971	16,800	771	15,680	666
		18	0.019	26,880	1,508	22,400	1,257	20,160	1,131	19,040	971	16,800	771	15,680	666
		20	0.019	26,880	1,508	22,400	1,257	20,160	1,131	19,040	971	16,800	771	15,680	666
0.8	1.6	8	0.11	31,200	2,184	26,000	1,820	23,400	1,638	22,100	1,370	19,500	1,170	18,200	1,019
		12	0.065	28,080	1,769	23,400	1,474	21,060	1,327	19,890	1,110	17,550	948	16,380	826
		16	0.04	28,080	1,769	23,400	1,474	21,060	1,327	19,890	1,110	17,550	948	16,380	826
		20	0.02	24,960	1,485	20,800	1,238	18,720	1,114	17,680	932	15,600	796	14,560	693
0.9	1.8	8	0.13	31,200	2,496	26,000	2,080	23,400	1,872	22,100	1,547	19,500	1,287	18,200	1,092
		12	0.07	28,080	2,022	23,400	1,685	21,060	1,516	19,890	1,253	17,550	1,042	16,380	885
		16	0.045	28,080	2,022	23,400	1,685	21,060	1,516	19,890	1,253	17,550	1,042	16,380	885
		20	0.022	24,960	1,697	20,800	1,414	18,720	1,273	17,680	1,052	15,600	875	14,560	743
1	2	3	0.2	25,200	2,520	21,000	2,100	18,900	1,890	17,850	1,607	15,750	1,355	14,700	1,176
		4	0.2	25,200	2,520	21,000	2,100	18,900	1,890	17,850	1,607	15,750	1,355	14,700	1,176
		6	0.2	25,200	2,268	21,000	1,890	18,900	1,701	17,850	1,428	15,750	1,197	14,700	1,058
		8	0.14	25,200	2,268	21,000	1,890	18,900	1,701	17,850	1,428	15,750	1,197	14,700	1,058
		10	0.14	25,200	2,016	21,000	1,680	18,900	1,512	17,850	1,285	15,750	1,071	14,700	941

推奨領域 Recommended range				PNシリーズ PN series												
				ATHシリーズ ATH series												
被削材 Work material				1	2		3		4		5		6			
				銅 Copper	炭素鋼・合金鋼 Carbon steels, Alloy steels (180~250HB)		ステンレス鋼・工具鋼 Stainless steels, Tool steels (25~35HRC)		プリハードン鋼 Pre-hardened steels (35~45HRC)		焼入れ鋼 Hardened steels (45~55HRC)		焼入れ鋼 Hardened steels (55~65HRC)			
切込み比率 Ratio to standard depth of cut				120%		100%		90%		80%		65%		60%		
ボール半径RE Ball radius (mm)	外径DC Tool dia. (mm)	首下長LU Under neck length (mm)	ap (mm)	回転数 n min ⁻¹	送り速度 vf mm/min	回転数 n min ⁻¹	送り速度 vf mm/min	回転数 n min ⁻¹	送り速度 vf mm/min	回転数 n min ⁻¹	送り速度 vf mm/min	回転数 n min ⁻¹	送り速度 vf mm/min	回転数 n min ⁻¹	送り速度 vf mm/min	
1	2		12	0.08	22,680	1,814	18,900	1,512	17,010	1,361	16,065	1,157	14,175	964	13,230	847
			13	0.08	22,680	1,814	18,900	1,512	17,010	1,361	16,065	1,157	14,175	964	13,230	847
			14	0.08	22,680	1,814	18,900	1,512	17,010	1,361	16,065	1,157	14,175	964	13,230	847
			16	0.08	22,680	1,633	18,900	1,361	17,010	1,225	16,065	1,041	14,175	868	13,230	762
			18	0.06	22,680	1,633	18,900	1,361	17,010	1,225	16,065	1,041	14,175	868	13,230	762
			20	0.05	22,680	1,633	18,900	1,361	17,010	1,225	16,065	1,041	14,175	868	13,230	762
			22	0.042	21,420	1,457	17,850	1,214	16,065	1,092	15,173	929	13,388	774	12,495	680
			25	0.035	20,160	1,371	16,800	1,142	15,120	1,028	14,280	874	12,600	728	11,760	640
			30	0.015	20,160	1,371	16,800	1,142	15,120	1,028	14,280	874	12,600	728	11,760	640
			35	0.012	17,640	1,129	14,700	941	13,230	847	12,495	720	11,025	600	10,290	527
40	0.01	15,120	968	12,600	806	11,340	726	10,710	617	9,450	514	8,820	452			
1.25	2.5		6	0.25	22,200	2,700	18,500	2,250	16,650	2,025	15,725	1,688	13,875	1,373	12,950	1,125
			10	0.17	22,200	2,700	18,500	2,250	16,650	2,025	15,725	1,688	13,875	1,373	12,950	1,125
			15	0.1	19,980	2,186	16,650	1,822	14,985	1,640	14,153	1,367	12,488	1,111	11,655	911
			20	0.08	19,980	2,186	16,650	1,822	14,985	1,640	14,153	1,367	12,488	1,111	11,655	911
			25	0.065	19,980	1,967	16,650	1,639	14,985	1,475	14,153	1,229	12,488	1,000	11,655	820
			30	0.044	17,760	1,836	14,800	1,530	13,320	1,377	12,580	1,148	11,100	933	10,360	765
1.5	3		8	0.3	19,200	2,880	16,000	2,400	14,400	2,160	13,600	1,822	12,000	1,512	11,200	1,344
			10	0.21	19,200	2,880	16,000	2,400	14,400	2,160	13,600	1,822	12,000	1,512	11,200	1,344
			13	0.21	19,200	2,880	16,000	2,400	14,400	2,160	13,600	1,822	12,000	1,512	11,200	1,344
			16	0.21	19,200	2,592	16,000	2,160	14,400	1,944	13,600	1,640	12,000	1,361	11,200	1,210
			20	0.12	17,280	2,333	14,400	1,944	12,960	1,750	12,240	1,476	10,800	1,225	10,080	1,089
			25	0.08	17,280	2,333	14,400	1,944	12,960	1,750	12,240	1,476	10,800	1,225	10,080	1,089
			30	0.08	17,280	2,333	14,400	1,944	12,960	1,750	12,240	1,476	10,800	1,225	10,080	1,089
			35	0.064	15,360	1,958	12,800	1,632	11,520	1,469	10,880	1,239	9,600	1,028	8,960	914
1.75	3.5		15	0.24	16,500	2,820	13,750	2,350	12,375	2,115	11,688	1,763	10,313	1,434	9,625	1,175
			25	0.14	14,850	2,280	12,375	1,900	11,138	1,710	10,519	1,425	9,281	1,159	8,663	950
			35	0.09	14,850	2,280	12,375	1,900	11,138	1,710	10,519	1,425	9,281	1,159	8,663	950
			45	0.072	13,200	1,918	11,000	1,598	9,900	1,438	9,350	1,199	8,250	975	7,700	799
2	4		10	0.4	13,800	2,760	11,500	2,300	10,350	2,070	9,775	1,760	8,625	1,466	8,050	1,288
			13	0.32	13,800	2,760	11,500	2,300	10,350	2,070	9,775	1,760	8,625	1,466	8,050	1,288
			16	0.28	13,800	2,760	11,500	2,300	10,350	2,070	9,775	1,760	8,625	1,466	8,050	1,288
			20	0.28	13,800	2,760	11,500	2,300	10,350	2,070	9,775	1,760	8,625	1,466	8,050	1,288
			25	0.16	12,420	2,236	10,350	1,863	9,315	1,677	8,798	1,425	7,763	1,188	7,245	1,043
			30	0.16	12,420	2,236	10,350	1,863	9,315	1,677	8,798	1,425	7,763	1,188	7,245	1,043
			35	0.1	12,420	2,236	10,350	1,863	9,315	1,677	8,798	1,425	7,763	1,188	7,245	1,043
			40	0.1	12,420	2,236	10,350	1,863	9,315	1,677	8,798	1,425	7,763	1,188	7,245	1,043
			45	0.08	11,040	1,877	9,200	1,564	8,280	1,408	7,820	1,196	6,900	997	6,440	876
			50	0.07	11,040	1,877	9,200	1,564	8,280	1,408	7,820	1,196	6,900	997	6,440	876
2.5	5		20	0.35	10,800	2,592	9,000	2,160	8,100	1,944	7,650	1,530	6,750	1,350	6,300	1,134
			25	0.35	10,800	2,592	9,000	2,160	8,100	1,944	7,650	1,530	6,750	1,350	6,300	1,134
			30	0.2	9,720	2,333	8,100	1,944	7,290	1,750	6,885	1,377	6,075	1,215	5,670	1,021
			40	0.2	9,720	2,100	8,100	1,750	7,290	1,575	6,885	1,239	6,075	1,094	5,670	919
3	6		12	0.6	10,800	3,024	9,000	2,520	8,100	2,268	7,650	1,890	6,750	1,537	6,300	1,260
			20	0.5	10,200	2,652	8,500	2,210	7,650	1,989	7,225	1,658	6,375	1,348	5,950	1,105
			30	0.42	9,600	2,304	8,000	1,920	7,200	1,728	6,800	1,360	6,000	1,200	5,600	1,008
			50	0.15	8,640	1,866	7,200	1,555	6,480	1,400	6,120	1,102	5,400	972	5,040	816

※(1) apは被削材グループ2での目安を示しています。その他のグループの場合は、上表の切込み比率を目安に調整してください。
 ※(2) リブ加工や止まり溝など、切りくずがつまりやすい切削の場合、切込み設定は基本切込みに切込み比率をかけて算出した切込み量を、さらにその80%まで小さくして使用してください。
 ※(3) aeの設定はap×切込み比率×3~5倍を目安に調整してください。仕上げ加工を行う場合、理論カスプハイトを計算し設定してください。
 ※(1) ap is shown as the criteria for Group 2 workpieces. For other groups, adjust the cutting depth according to the cutting depth factors in the above table.
 ※(2) When performing cutting where cutting chips may cause clogging, such as for rib cutting, blind grooves, etc., cutting depth setting should be set by multiplying a cutting depth factor to calculate the cutting depth amount, and this amount should then be reduced to 80% of the calculated value.
 ※(3) Adjust by setting ae to (3 to 5) × (ap) × (cutting depth ratio). When performing finishing processing, calculate the theoretical cusp height and set accordingly.

【切込み設定例】 EPDBE2020-10-ATHの工具で焼き入れ鋼(50HRC)をリブ溝等高線切削する場合、
 切込み=0.14(ap)×0.65(焼入れ鋼グループ5の切込み比率)×0.8(閉鎖域の切削)=0.073mm
 Cutting depth setting example: When cutting rib groove contours in hardened steel (50HRC) using an EPDBE2020-10-ATH tool:
 Cutting depth = 0.14 (ap) × 0.65 (cutting depth factor for Group 5 hardened steel) × 0.8 (for closed-area cutting) = 0.073mm

【注意】 ①PNコーティングはその性質上、通電性が微小です。従って、通電方式の工具長測定装置をご使用の際にはご注意ください。
 ②被削材、加工形状に合わせて、適切なクーラントを使用してください。
 ③この標準切削条件表は切削条件の目安を示すものです。実際の加工では加工形状、目的、使用機械等により条件を調整してください。
 ④機械の回転数が足りない場合は、回転数と送り速度を同じ比率で下げてください。

【Note】 ①PN coating is less electro conductive. Therefore, electric transmitted measuring systems may not work.
 ② Use the appropriate coolant for the work material and machining shape.
 ③ These Recommended Cutting Conditions indicate only the rule of a thumb for the cutting conditions. In actual machining, the condition should be adjusted according to the machining shape, purpose and the machine type.
 ④ If the rpm of the machine is low, lower the feed rate also to put the rpm and feed rate in the same ratio.

Epoch Pencil Deep Ball Evolution

エポックペンシルディープボールエボリューション

ペンシルネック Pencil neck



RE公差 RE tolerance	RE ≤ 0.25 : ±0.003 0.25 < RE ≤ 3 : ±0.005 3 < RE : ±0.01 *1	h5 *2
----------------------	---	-------

(mm)

*1 RE4~RE5、および首下長80を超えるものは±0.015です。RE6はすべて±0.015です。
±0.015 for RE4 to RE5 types or types with under neck lengths of more than 80. ±0.015 for all RE6 types.
*2 全長140mm以上のものはシャング径公差h6です。
The shank tolerance is h6 when the overall length is 140 mm or more.



首角度、首下長さのバリエーションを増やし、あらゆる深リブ加工へ対応。
Wider range of neck angle and under-neck length variations to handle all kinds of deep rib cutting.

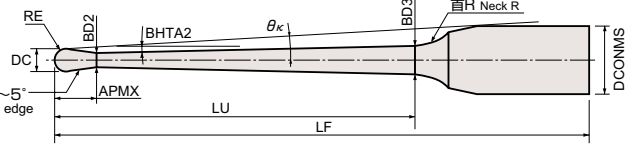
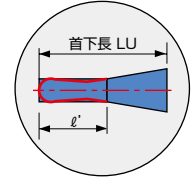

EPDBPE2-ATH



商品コード Item code	在庫 Stock	寸法 Size(mm)													干渉角度 Interference angle (°)	勾配角に対する実有効首下長 Effective under neck length with respect to draft angle					希望小売 価格 (円) Suggested retail price (¥)		
		ボール半径 Ball radius	外径 Tool dia.	首部 テーパー角 Neck angle	首下長 Under neck length	刃長 Flute length	首径 Neck dia.	首元径 Under neck dia.	全長 Overall length	シャング径 Shank dia.	首R Neck R	首形状 Neck shape	仮想首長 Approx neck length	0.5°		1°	1.5°	2°	3°				
		RE	DC	BHTA2	LU	APMX	BD2	BD3	LF	DCONMS	Neck R	Neck shape	l'	θκ									
EPDBPE2002-1-04-ATH	●	0.1	0.2	0.4	1	0.15	0.17	0.182	50	4	7	A	1.35	10.89	1.55	1.72	1.88	2.03	2.31	10,610			
EPDBPE2002-1.5-04-ATH	●				1.5	0.15	0.17	0.189	50	4	7	A	1.77	10.39	2.06	2.28	2.47	2.64	2.97	11,370			
EPDBPE2002-2-04-ATH	●				2	0.15	0.17	0.196	50	4	10	A	2.20	9.94	2.70	3.03	3.30	3.56	4.02	11,900			
EPDBPE2002-3-04-ATH	●				3	0.15	0.17	0.210	50	4	10	A	2.29	9.14	3.73	4.14	4.47	4.77	5.29	14,040			
EPDBPE2002-2-09-ATH	●				2	0.15	0.17	0.228	50	4	10	A	1.10	10.01	2.32	2.81	3.14	3.42	3.92	11,900			
EPDBPE2002-2.5-09-ATH	●				2.5	0.15	0.17	0.244	50	4	10	A	1.10	9.60	2.36	3.32	3.70	4.01	4.54	12,970			
EPDBPE2002-3-09-ATH	●			3	0.15	0.17	0.260	50	4	10	A	1.10	9.23	2.36	3.84	4.25	4.58	5.15	14,040				
EPDBPE2002-1-14-ATH	●			1.4	0.2	0.4	1	0.15	0.17	0.212	50	4	7	A	0.76	10.96	1.24	1.51	1.71	1.88	2.20	10,610	
EPDBPE2002-2-14-ATH	●						2	0.15	0.17	0.260	50	4	10	A	0.76	10.08	1.13	2.47	2.93	3.26	3.80	11,900	
EPDBPE2002-3-14-ATH	●						3	0.15	0.17	0.309	50	4	10	A	0.76	9.32	1.13	2.42	3.96	4.37	5.00	14,040	
EPDBPE2002-1-29-ATH	●						1	0.15	0.17	0.256	50	4	7	A	0.44	11.08	0.51	0.62	0.81	1.57	1.99	10,610	
EPDBPE2002-2-29-ATH	●						2	0.15	0.17	0.357	50	4	10	A	0.44	10.29	0.51	0.62	0.81	1.21	3.35	11,900	
EPDBPE2002-3-29-ATH	●	3	0.15				0.17	0.459	50	4	10	A	0.44	9.61	0.51	0.62	0.81	1.21	4.37	14,040			
EPDBPE2003-2-04-ATH	●	0.15	0.3	0.4	2	0.25	0.27	0.294	50	4	7	A	2.19	9.94	2.57	2.83	3.04	3.24	3.59	11,370			
EPDBPE2003-3-04-ATH	●				3	0.25	0.27	0.308	50	4	10	A	2.39	9.12	3.73	4.14	4.47	4.76	5.28	11,900			
EPDBPE2003-3-09-ATH	●				3	0.25	0.27	0.356	50	4	10	A	1.20	9.21	2.52	3.85	4.25	4.58	5.15	11,900			
EPDBPE2003-4-09-ATH	●				4	0.25	0.27	0.388	50	4	10	A	1.20	8.53	2.52	4.87	5.35	5.73	6.35	12,220			
EPDBPE2004-2-04-ATH	●				0.2	0.4	0.4	2	0.3	0.37	0.394	50	4	7	A	2.20	9.93	2.57	2.82	3.03	3.23	3.57	8,730
EPDBPE2004-3-04-ATH	●							3	0.3	0.37	0.408	50	4	7	A	2.44	9.10	3.60	3.92	4.18	4.40	4.80	8,730
EPDBPE2004-4-04-ATH	●	4	0.3	0.37				0.422	50	4	10	A	2.44	8.39	4.76	5.23	5.61	5.93	6.51	8,730			
EPDBPE2004-5-04-ATH	●	5	0.3	0.37				0.436	50	4	10	A	2.44	7.78	5.78	6.33	6.74	7.10	7.71	9,070			
EPDBPE2004-6-04-ATH	●	6	0.3	0.37				0.450	50	4	10	A	2.44	7.25	6.81	7.41	7.86	8.25	8.90	9,350			
EPDBPE2004-8-04-ATH	●	8	0.3	0.37				0.478	50	4	10	A	2.44	6.39	8.85	9.57	10.08	10.51	11.24	9,890			
EPDBPE2004-2-09-ATH	●	0.9	0.4	0.4			2	0.3	0.37	0.423	50	4	7	A	1.25	10.00	2.30	2.66	2.90	3.12	3.49	8,730	
EPDBPE2004-4-09-ATH	●						4	0.3	0.37	0.486	50	4	10	A	1.25	8.49	2.57	4.87	5.35	5.72	6.34	8,730	
EPDBPE2004-5-09-ATH	●						5	0.3	0.37	0.518	50	4	10	A	1.25	7.89	2.57	5.90	6.44	6.85	7.53	9,070	
EPDBPE2004-6-09-ATH	●						6	0.3	0.37	0.549	50	4	10	A	1.25	7.37	2.57	6.92	7.52	7.97	8.69	9,350	
EPDBPE2004-2-14-ATH	●						2	0.3	0.37	0.453	50	4	7	A	0.91	10.07	1.31	2.41	2.75	2.99	3.40	8,730	
EPDBPE2004-4-14-ATH	●						4	0.3	0.37	0.551	50	4	10	A	0.91	8.60	1.31	2.70	5.00	5.47	6.16	8,730	
EPDBPE2004-6-14-ATH	●	6	0.3	0.37	0.649	50	4	10	A	0.91	7.50	1.31	2.70	7.04	7.64	8.46	9,350						
EPDBPE2004-2-29-ATH	●	2.9	0.4	0.4	2	0.3	0.37	0.542	50	4	7	A	0.59	10.28	0.67	0.80	1.02	1.48	3.04	8,730			
EPDBPE2004-4-29-ATH	●				4	0.3	0.37	0.745	50	4	10	A	0.59	8.93	0.67	0.80	1.02	1.48	5.42	8,730			
EPDBPE2004-6-29-ATH	●				6	0.3	0.37	0.947	50	4	10	A	0.59	7.90	0.67	0.80	1.02	1.48	7.45	9,350			
EPDBPE2005-4-04-ATH	●				0.25	0.5	0.4	4	0.35	0.47	0.521	50	4	7	A	2.49	8.35	4.62	5.00	5.30	5.55	5.99	8,220
EPDBPE2005-6-04-ATH	●							6	0.35	0.47	0.549	50	4	10	A	2.49	7.20	6.80	7.41	7.86	8.24	8.89	8,690
EPDBPE2005-6-09-ATH	●							6	0.35	0.47	0.648	50	4	10	A	1.30	7.32	2.62	6.92	7.52	7.97	8.69	8,690
EPDBPE2005-8-09-ATH	●	8	0.35	0.47				0.710	50	4	10	A	1.30	6.45	2.62	8.96	9.67	10.18	10.99	8,690			
EPDBPE2005-12-09-ATH	●	12	0.35	0.47				0.836	50	4	10	A	1.30	5.21	2.62	13.05	13.94	14.55	15.49	9,700			
EPDBPE20054-2-04-ATH	●	0.27	0.54	0.4				2	0.37	0.52	0.543	50	4	4	A	1.80	9.95	2.56	2.55	2.70	2.83	3.06	10,020
EPDBPE20054-4-04-ATH	●				4	0.37	0.52	0.571	50	4	7	A	1.80	8.35	4.55	4.96	5.26	5.52	5.97	10,020			
EPDBPE20054-5-04-ATH	●				5	0.37	0.52	0.585	50	4	7	A	1.80	7.72	5.57	6.04	6.38	6.66	7.15	10,020			
EPDBPE20054-6-04-ATH	●				6	0.37	0.52	0.599	50	4	10	A	1.80	7.19	6.73	7.37	7.82	8.21	8.87	11,040			
EPDBPE20054-6.5-04-ATH	●				6.5	0.37	0.52	0.606	50	4	10	A	1.80	6.94	7.24	7.91	8.38	8.78	9.46	11,040			
EPDBPE20054-7-04-ATH	●				7	0.37	0.52	0.613	50	4	10	A	1.80	6.72	7.76	8.45	8.94	9.35	10.05	11,040			
EPDBPE2006-2-04-ATH	●	0.3	0.6	0.4	2	0.4	0.57	0.592	50	4	4	A	2.17	9.93	2.42	2.59	2.73	2.85	3.08	7,500			
EPDBPE2006-4-04-ATH	●				4	0.4	0.57	0.620	50	4	7	A	2.54	8.31	4.62	5.00	5.29	5.54	5.98	7,790			
EPDBPE2006-6-04-ATH	●				6	0.4	0.57	0.648	50	4	10	A	2.54	7.14	6.80	7.41	7.85	8.23	8.88	8,140			
EPDBPE2006-8-04-ATH	●				8	0.4	0.57	0.676	50	4	10	A	2.54	6.26	8.85	9.56	10.07	10.50	11.22	8,370			
EPDBPE2006-10-04-ATH	●				10	0.4	0.57	0.704	50	4	10	A	2.54	5.57	10.89	11.70	12.27	12.73	13.52	8,450			
EPDBPE2006-12-04-ATH	●				12	0.4	0.57	0.732	55	4	10	A	2.54	5.02	12.94	13.83	14.44	14.93	15.79	9,150			
EPDBPE2006-15-04-ATH	●	15	0.4	0.57	0.774	55	4	10	A	2.54	4.37	15.99	17.01	17.68	18.24	19.27	9,150						

● : 標準在庫品です。● : Stocked items. 干渉なし : No interference

■首形状詳細 Detail of neck shape

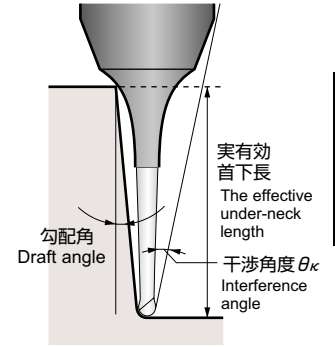
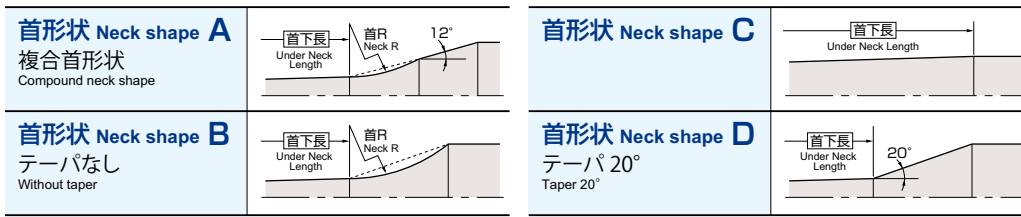

EPDBPE2 - ATH

商品コード Item code	在庫 Stock	寸法 Size(mm)											干渉角度 Interference angle (°)	勾配角に対する実有効首下長 Effective under neck length with respect to draft angle					希望小売 価格 (円) Suggested retail price (¥)								
		ボール半径 Ball radius RE	外径 Tool dia. DC	首部 テーパ半角 Neck angle BHTA2	首下長 Under neck length LU	刃長 Flute length APMX	首径 Neck dia. BD2	首元径 Under neck dia. BD3	全長 Overall length LF	シャンク径 Shank dia. DCONMS	首R Neck R	首形状 Neck shape		仮想首長 Approx neck length l'	θ_k	0.5°	1°	1.5°		2°	3°						
																						0.5°	1°	1.5°	2°	3°	
EPDBPE2006-4-09-ATH	●	0.3	0.6	0.9	4	0.4	0.57	0.683	50	4	7	A	1.35	8.41	2.67	4.70	5.07	5.37	5.85	7,790							
EPDBPE2006-6-09-ATH	●				6	0.4	0.57	0.746	50	4	10	A	1.35	7.26	2.67	6.92	7.51	7.96	8.68	8,140							
EPDBPE2006-8-09-ATH	●				8	0.4	0.57	0.809	50	4	10	A	1.35	6.38	2.67	8.96	9.67	10.18	10.98	8,370							
EPDBPE2006-10-09-ATH	●				10	0.4	0.57	0.872	50	4	10	A	1.35	5.70	2.67	11.01	11.81	12.37	13.25	8,450							
EPDBPE2006-12-09-ATH	●				12	0.4	0.57	0.934	55	4	10	A	1.35	5.14	2.67	13.05	13.94	14.54	15.49	9,150							
EPDBPE2006-15-09-ATH	●				15	0.4	0.57	1.029	55	4	10	A	1.35	4.49	2.67	16.10	17.11	17.78	18.81	9,150							
EPDBPE2006-4-14-ATH	●			0.3	0.6	1.4	4	0.4	0.57	0.746	50	4	7	A	1.01	8.52	1.41	2.80	4.78	5.16	5.70	7,790					
EPDBPE2006-5-14-ATH	●						5	0.4	0.57	0.795	50	4	7	A	1.01	7.91	1.41	2.80	5.80	6.23	6.83	8,140					
EPDBPE2006-6-14-ATH	●						6	0.4	0.57	0.844	50	4	10	A	1.01	7.39	1.41	2.80	7.04	7.63	8.45	8,140					
EPDBPE2006-8-14-ATH	●						8	0.4	0.57	0.941	50	4	10	A	1.01	6.52	1.41	2.80	9.08	9.78	10.71	8,370					
EPDBPE2006-10-14-ATH	●						10	0.4	0.57	1.039	50	4	10	A	1.01	5.83	1.41	2.80	11.13	11.92	12.94	8,450					
EPDBPE2006-20-14-ATH	●						20	0.4	0.57	1.528	60	4	10	A	1.01	3.82	1.41	2.80	21.31	22.47	23.84	10,150					
EPDBPE2006-6-29-ATH	●					0.3	0.6	2.9	6	0.4	0.57	1.137	50	4	10	A	0.69	7.79	0.77	0.90	1.12	1.58	7.45	8,140			
EPDBPE2006-8-29-ATH	●								8	0.4	0.57	1.340	50	4	10	A	0.69	6.95	0.77	0.90	1.12	1.58	9.49	8,370			
EPDBPE2006-12-29-ATH	●								12	0.4	0.57	1.745	55	4	10	A	0.69	5.71	0.77	0.90	1.12	1.58	13.56	9,150			
EPDBPE2006-20-29-ATH	●								20	0.4	0.57	2.556	60	4	10	B	0.69	4.15	0.77	0.90	1.12	1.58	21.68	10,150			
EPDBPE2008-4-04-ATH	●	0.4	0.8						0.4	4	0.5	0.77	0.819	50	4	7	A	2.64	8.22	4.61	4.99	5.28	5.53	5.97	8,520		
EPDBPE2008-6-04-ATH	●									6	0.5	0.77	0.847	50	4	7	A	2.64	7.01	4.66	7.14	7.50	7.79	8.30	8,730		
EPDBPE2008-8-04-ATH	●							8		0.5	0.77	0.875	50	4	10	A	2.64	6.11	4.85	9.56	10.06	10.49	11.21	8,730			
EPDBPE2008-12-04-ATH	●							12		0.5	0.77	0.931	55	4	10	A	2.64	4.86	4.86	12.93	13.83	14.44	14.94	15.77	9,200		
EPDBPE2008-8-09-ATH	●							8		0.5	0.77	1.006	50	4	10	A	1.45	6.24	2.77	8.96	9.66	10.17	10.97	8,730			
EPDBPE2008-12-09-ATH	●							12		0.5	0.77	1.131	55	4	10	A	1.45	4.99	2.77	13.04	13.93	14.54	15.48	9,200			
EPDBPE2008-16-09-ATH	●			2.9	0.8			0.9	16	0.5	0.77	1.257	55	4	10	A	1.45	4.15	2.77	17.12	18.16	18.85	19.90	9,530			
EPDBPE2008-16-29-ATH	●								16	0.5	0.77	2.340	55	4	10	B	0.79	4.67	0.87	1.00	1.22	1.69	17.62	9,530			
EPDBPE2008-20-29-ATH	●								20	0.5	0.77	2.746	60	4	10	B	0.79	3.97	0.87	1.00	1.22	1.69	21.68	10,120			
EPDBPE2009-4-04-ATH	●								0.45	0.9	0.4	4	0.6	0.86	0.907	50	4	4	A	3.46	8.15	4.50	4.75	4.94	5.11	5.41	8,100
EPDBPE2009-8-04-ATH	●											8	0.6	0.86	0.963	55	4	7	A	3.46	6.03	8.75	9.30	9.70	10.03	10.60	8,100
EPDBPE2009-12-04-ATH	●											12	0.6	0.86	1.019	55	4	10	A	3.46	4.78	12.99	13.86	14.46	14.95	15.78	8,370
EPDBPE2009-16-04-ATH	●			16	0.6	0.86	1.075	60				4	10	A	3.46	3.96	17.07	18.08	18.77	19.33	20.54	10,020					
EPDBPE2009-18-04-ATH	●			18	0.6	0.86	1.103	65				4	10	A	3.46	3.65	19.10	20.19	20.91	21.50	23.11	11,680					
EPDBPE2009-20-04-ATH	●			20	0.6	0.86	1.131	65				4	10	A	3.46	3.38	21.13	22.29	23.05	23.66	25.68	11,680					
EPDBPE2009-22-04-ATH	●			0.9	1	0.4	22	0.6			0.86	1.159	65	4	10	A	3.46	3.15	23.17	24.38	25.17	25.81	28.24	11,680			
EPDBPE2009-24-04-ATH	●	24	0.6				0.86	1.187			70	4	10	A	3.46	2.95	25.20	26.47	27.29	27.96	干渉なし	12,220					
EPDBPE2010-6-04-ATH	●	0.5	1				0.4	6			0.8	0.94	1.013	50	6	7	A	5.09	8.26	6.82	7.24	7.57	7.85	8.34	6,140		
EPDBPE2010-8-04-ATH	●							8			0.8	0.94	1.041	55	6	7	A	5.09	7.44	8.85	9.36	9.74	10.07	10.62	6,720		
EPDBPE2010-10-04-ATH	●							10			0.8	0.94	1.068	55	6	10	A	5.09	6.76	11.07	11.79	12.33	12.78	13.54	7,430		
EPDBPE2010-15-04-ATH	●							15			0.8	0.94	1.138	60	6	10	A	5.09	5.51	16.16	17.08	17.73	18.27	19.31	7,790		
EPDBPE2010-20-04-ATH	●			20	0.8	0.94		1.208			65	6	10	A	5.09	4.65	21.23	22.33	23.08	23.69	25.73	9,430					
EPDBPE2010-25-04-ATH	●			25	0.8	0.94		1.278			70	6	10	A	5.09	4.02	26.31	27.56	28.38	29.05	32.15	10,020					
EPDBPE2010-30-04-ATH	●			0.9	1	0.4	30	0.8			0.94	1.348	75	6	10	A	5.09	3.54	31.37	32.76	33.66	34.82	38.57	10,310			
EPDBPE2010-50-04-ATH	●						50	0.8			0.94	1.627	95	6	10	A	5.09	2.40	51.62	53.44	55.27	57.96	干渉なし	11,900			
EPDBPE2010-70-04-ATH	●						70	0.8	0.94	1.906	115	6	10	A	5.09	1.81	71.83	73.98	77.33	干渉なし	13,390						
EPDBPE2010-6-09-ATH	●						0.5	1	0.9	6	0.8	0.94	1.103	50	6	7	A	2.70	8.36	5.47	6.91	7.32	7.65	8.19	6,140		
EPDBPE2010-10-09-ATH	●									10	0.8	0.94	1.229	55	6	10	A	2.70	6.88	5.47	11.20	11.91	12.44	13.28	7,430		
EPDBPE2010-15-09-ATH	●									15	0.8	0.94	1.386	60	6	10	A	2.70	5.64	5.47	16.28	17.19	17.84	18.84	7,790		
EPDBPE2010-16-09-ATH	●			16	0.8	0.94				1.418	60	6	10	A	2.70	5.44	5.47	17.29	18.24	18.91	19.94	7,790					
EPDBPE2010-20-09-ATH	●			20	0.8	0.94				1.543	65	6	10	A	2.70	4.77	5.47	21.35	22.44	23.18	24.68	9,430					
EPDBPE2010-25-09-ATH	●			25	0.8	0.94				1.700	70	6	10	A	2.70	4.14	5.47	26.42	27.66	28.48	30.83	10,020					
EPDBPE2010-30-09-ATH	●			0.9	1	0.9			30	0.8	0.94	1.857	75	6	10	A	2.70	3.65	5.47	31.49	32.86	33.75	36.98	10,310			
EPDBPE2010-35-09-ATH	●	35	0.8						0.94	2.015	80	6	10	A	2.70	3.27	5.47	36.55	38.04	39.00	43.12	10,940					
EPDBPE2010-40-09-ATH	●	40	0.8						0.94	2.172	85	6	10	A	2.70	2.96	5.47	41.61	43.22	44.46	干渉なし	11,150					
EPDBPE2010-50-09-ATH	●	50	0.8						0.94	2.486	95	6	10	A	2.70	2.48	5.47	51.73	53.53	55.55	干渉なし	11,900					
EPDBPE2010-60-09-ATH	●	60	0.8						0.94	2.800	105	6	10	A	2.70	2.14	5.47	61.84	63.81	66.63	干渉なし	12,650					
EPDBPE2010-70-09-ATH	●	70	0.8						0.94	3.114	115	6	10	A	2.70	1.88	5.47	71.94	74.09	干渉なし	干渉なし	13,390					

エポックペンシルディープボールエボリューション

EPDBPE2○○○○○-○○○.○-○○-ATH

超
ミ
ニ
マ
ス
ハ
ン
ド
レ
ン
ル
ボ
ー
ル
エ
ン
ド
レ
ン
ル

商品コード Item code	在庫 Stock	寸法 Size(mm)														干渉角度 Interference angle (°)	勾配角に対する実有効首下長 Effective under neck length with respect to draft angle					希望小売 価格(円) Suggested retail price (¥)	
		ボール半径 Ball radius	外径 Tool dia.	首部 アール(半角) Neck angle	首下長 Under neck length	刃長 Flute length	首径 Neck dia.	首元径 Under neck dia.	全長 Overall length	シャンク径 Shank dia.	首R Neck R	首形状 Neck shape	仮首長 Approx neck length	φ'	φK		0.5°	1°	1.5°	2°	3°		
																							RE
EPDBPE2010-6-14-ATH	●	0.5	1	1.4	6	0.8	0.94	1.194	50	6	7	A	2.02	8.47	2.87	5.85	7.01	7.41	8.01	6,140			
EPDBPE2010-12-14-ATH	●				12	0.8	0.94	1.487	60	6	10	A	2.02	6.45	2.87	5.85	13.36	14.14	15.20	7,430			
EPDBPE2010-16-14-ATH	●				16	0.8	0.94	1.683	60	6	10	A	2.02	5.57	2.87	5.85	17.42	18.36	19.56	7,790			
EPDBPE2010-20-14-ATH	●				20	0.8	0.94	1.878	65	6	10	A	2.02	4.90	2.87	5.85	21.48	22.55	23.88	9,430			
EPDBPE2010-22-14-ATH	●				22	0.8	0.94	1.976	70	6	10	A	2.02	4.62	2.87	5.85	23.50	24.64	26.03	9,680			
EPDBPE2010-25-14-ATH	●				25	0.8	0.94	2.123	70	6	10	A	2.02	4.26	2.87	5.85	26.55	27.76	29.51	10,020			
EPDBPE2010-50-14-ATH	●				50	0.8	0.94	3.345	95	6	10	A	2.02	2.57	2.87	5.85	51.84	53.63	干渉なし	11,900			
EPDBPE2010-90-14-ATH	●				90	0.8	0.94	5.300	135	6	10	B	2.02	1.56	2.87	5.85	92.23	干渉なし	18,000				
EPDBPE2010-10-29-ATH	●				2.9	10	0.8	0.94	1.872	55	6	10	A	1.39	7.42	1.57	1.86	2.35	3.39	11.74	7,430		
EPDBPE2010-15-29-ATH	●			15		0.8	0.94	2.379	60	6	10	A	1.39	6.20	1.57	1.86	2.35	3.39	16.81	7,790			
EPDBPE2010-20-29-ATH	●			20		0.8	0.94	2.885	65	6	10	A	1.39	5.33	1.57	1.86	2.35	3.39	21.88	9,430			
EPDBPE2010-30-29-ATH	●			30		0.8	0.94	3.898	75	6	10	A	1.39	4.16	1.57	1.86	2.35	3.39	32.00	10,310			
EPDBPE2010-40-29-ATH	●			40		0.8	0.94	4.912	85	6	10	B	1.39	3.35	1.57	1.86	2.35	3.39	42.11	11,150			
EPDBPE2010-50-29-ATH	●			50		0.8	0.94	6.000	130	6	-	C	1.39	2.89	1.57	1.86	2.35	3.39	干渉なし	15,220			
EPDBPE2010-20-49-ATH	●			4.9		20	0.8	0.94	4.232	65	6	10	B	1.14	6.04	1.22	1.31	1.43	1.60	2.19	11,470		
EPDBPE2012-20-29-ATH	●			0.6		1.2	2.9	20	1.1	1.13	3.045	65	6	10	A	1.79	5.21	2.03	2.41	3.07	4.45	21.98	11,470
EPDBPE2012-35-29-ATH	●							35	1.1	1.13	4.565	80	6	10	B	1.79	3.61	2.03	2.41	3.07	4.45	37.15	12,540
EPDBPE2015-8-04-ATH	●			0.75	1.5	0.4	8	1.35	1.42	1.513	55	6	7	A	7.07	7.21	8.95	9.41	9.78	10.09	10.62	7,490	
EPDBPE2015-10-04-ATH	●	10	1.35				1.42	1.541	55	6	7	A	7.07	6.51	10.97	11.52	11.93	12.28	12.90	7,790			
EPDBPE2015-12-04-ATH	●	12	1.35				1.42	1.569	55	6	7	A	7.07	5.93	13.00	13.62	14.07	14.45	15.47	7,790			
EPDBPE2015-30-04-ATH	●	30	1.35				1.42	1.820	75	6	10	A	7.07	3.30	31.46	32.79	33.68	34.85	38.57	11,900			
EPDBPE2015-10-09-ATH	●	0.9	10				1.35	1.42	1.692	55	6	7	A	3.89	6.63	7.83	11.08	11.61	12.02	12.67	7,790		
EPDBPE2015-15-09-ATH	●		15				1.35	1.42	1.849	60	6	10	A	3.89	5.36	7.83	16.40	17.25	17.88	18.86	8,490		
EPDBPE2015-20-09-ATH	●		20			1.35	1.42	2.006	65	6	10	A	3.89	4.50	7.83	21.47	22.49	23.21	24.72	9,430			
EPDBPE2015-30-09-ATH	●		30			1.35	1.42	2.320	75	6	10	A	3.89	3.40	7.83	31.59	32.90	33.78	37.01	11,900			
EPDBPE2015-10-14-ATH	●		1.4			10	1.35	1.42	1.843	55	6	7	A	2.98	6.75	4.23	8.59	11.19	11.70	12.45	7,790		
EPDBPE2015-20-14-ATH	●					20	1.35	1.42	2.332	65	6	10	A	2.98	4.62	4.23	8.59	21.61	22.61	23.91	9,430		
EPDBPE2015-30-14-ATH	●	30				1.35	1.42	2.820	75	6	10	A	2.98	3.51	4.23	8.59	31.73	33.02	35.45	11,900			
EPDBPE2015-40-14-ATH	●	40				1.35	1.42	3.309	85	6	10	A	2.98	2.83	4.23	8.59	41.84	43.36	干渉なし	12,750			
EPDBPE2015-50-14-ATH	●	50				1.35	1.42	3.798	95	6	10	A	2.98	2.37	4.23	8.59	51.95	53.67	干渉なし	13,390			
EPDBPE2015-20-29-ATH	●	2.9				20	1.35	1.42	3.310	65	6	10	A	2.13	5.03	2.42	2.87	3.63	5.25	22.05	10,380		
EPDBPE2015-46-29-ATH	●	46	1.35			1.42	6.000	95	6	-	C	2.13	2.84	2.42	2.87	3.63	5.25	干渉なし	13,290				
EPDBPE2018-4-04-ATH	●	0.9	1.8			0.4	4	1.6	1.73	1.764	50	6	4	A	4.38	9.14	4.63	4.82	4.99	5.14	5.40	8,860	
EPDBPE2018-8-04-ATH	●						8	1.6	1.73	1.819	50	6	4	A	6.61	7.07	8.68	9.01	9.27	9.49	10.27	8,860	
EPDBPE2018-12-04-ATH	●						12	1.6	1.73	1.875	55	6	7	A	6.61	5.77	12.97	13.59	14.05	14.43	15.40	8,860	
EPDBPE2018-16-04-ATH	●			16	1.6		1.73	1.931	60	6	7	A	6.61	4.87	17.02	17.77	18.30	18.73	20.53	8,860			
EPDBPE2018-20-04-ATH	●			20	1.6		1.73	1.987	65	6	10	A	6.61	4.21	21.29	22.35	23.08	23.68	25.67	8,860			
EPDBPE2018-24-04-ATH	●			24	1.6		1.73	2.043	65	6	10	A	6.61	3.71	25.35	26.53	27.33	27.97	30.80	10,120			
EPDBPE2018-28-04-ATH	●			28	1.6		1.73	2.099	70	6	10	A	6.61	3.32	29.40	30.69	31.55	32.49	35.94	12,010			
EPDBPE2018-32-04-ATH	●			32	1.6		1.73	2.154	70	6	10	A	6.61	3.00	33.45	34.85	35.76	37.11	干渉なし	12,010			
EPDBPE2018-36-04-ATH	●			36	1.6		1.73	2.210	75	6	10	A	6.61	2.74	37.50	38.99	39.96	41.74	干渉なし	12,010			
EPDBPE2018-38-04-ATH	●			38	1.6		1.73	2.238	80	6	10	A	6.61	2.62	39.53	41.06	42.05	44.06	干渉なし	12,860			
EPDBPE2018-40-04-ATH	●			40	1.6		1.73	2.266	80	6	10	A	6.61	2.52	41.55	43.13	44.24	46.37	干渉なし	12,860			
EPDBPE2020-8-04-ATH	●			1	2		0.4	8	1.7	1.92	2.008	50	6	4	A	7.42	6.96	8.70	9.03	9.28	9.50	10.27	6,560
EPDBPE2020-12-04-ATH	●							12	1.7	1.92	2.064	55	6	7	A	7.42	5.64	13.00	13.61	14.06	14.43	15.40	6,840
EPDBPE2020-16-04-ATH	●							16	1.7	1.92	2.120	60	6	7	A	7.42	4.74	17.05	17.79	18.31	18.74	20.54	7,080
EPDBPE2020-20-04-ATH	●	20	1.7			1.92		2.176	65	6	10	A	7.42	4.09	21.33	22.37	23.09	23.68	25.67	8,490			
EPDBPE2020-25-04-ATH	●	25	1.7			1.92		2.245	65	6	10	A	7.42	3.49	26.40	27.59	28.39	29.05	32.09	9,430			
EPDBPE2020-30-04-ATH	●	30	1.7			1.92		2.315	70	6	10	A	7.42	3.04	31.46	32.79	33.67	34.81	38.51	10,380			
EPDBPE2020-40-04-ATH	●	40	1.7			1.92		2.455	80	6	10	A	7.42	2.42	41.58	43.14	44.26	46.39	干渉なし	12,220			
EPDBPE2020-80-04-ATH	●	80	1.7			1.92		3.013	120	6	10	A	7.42	1.34	81.99	84.47	干渉なし	干渉なし	干渉なし	16,720			
EPDBPE2020-12-09-ATH	●	0.9	12			1.7		1.92	2.244	55	6	7	A	4.24	5.76	8.30	13.11	13.70	14.14	14.84	6,840		
EPDBPE2020-16-09-ATH	●		16			1.7	1.92	2.369	60	6	7	A	4.24	4.86	8.30	17.16	17.88	18.39	19.76	7,080			
EPDBPE2020-20-09-ATH	●		20			1.7	1.92	2.495	65	6	10	A	4.24	4.20	8.30	21.48	22.49	23.20	24.68	8,490			
EPDBPE2020-25-09-ATH	●		25			1.7	1.92	2.652	65	6	10	A	4.24	3.60	8.30	26.54	27.70	28.50	30.82	9,430			
EPDBPE2020-30-09-ATH	●		30			1.7	1.92	2.809	70	6	10	A	4.24	3.14	8.30	31.60	32.90	33.77	36.97	10,380			
EPDBPE2020-35-09-ATH	●		35			1.7	1.92	2.966	75	6	10	A	4.24	2.79	8.30	36.66	38.08	39.02	干渉なし	13,390			
EPDBPE2020-40-09-ATH	●		40			1.7	1.92	3.123	80	6	10	A	4.24	2.51	8.30	41.72	43.25	44.50	干渉なし	14,150			
EPDBPE2020-50-09-ATH	●		50			1.7	1.92	3.438	90	6	10	A	4.24	2.09	8.30	51.82	53.56	55.58	干渉なし	15,530			
EPDBPE2020-60-09-ATH	●		60			1.7	1.92	3.752	100	6	10	A	4.24	1.79	8.30	61.92	63.84	干渉なし	干渉なし	16,290			
EPDBPE2020-70-09-ATH	●	70	1.7			1.92	4.066	110	6	10	A	4.24	1.56	8.30	72.02	74.15	干渉なし	干渉なし	17,260				
EPDBPE2020-75-09-ATH	●	75	1.7	1.92	4.223	115	6	10	B	4.24	1.47	8.30	77.06	干渉なし	干渉なし	干渉なし	18,000						
EPDBPE2020-10-14-ATH	●	1.4	10	1.7	1.92	2.326	55	6	7	A	3.33	6.47	4.63	9.19	11.20	11.70	12.43	6,800					
EPDBPE2020-16-14-ATH	●		16	1.7	1.92	2.619	60	6	7	A	3.33	4.98	4.63	9.19	17.27	17.97	18.98	7,080					
EPDBPE2020-20-14-ATH	●		20	1.7	1.92	2.814	65	6	10	A	3.33	4.32	4.63	9.19	21.62	22.61	23.90	8,490					
EPDBPE2020-22-14-ATH	●		22	1.7	1.92	2.912	65	6	10	A	3.33	4.05	4.63	9.19	23.65	24.70	26.05	8,490					
EPDBPE2020-25-14-ATH	●		25	1.7	1.92	3.059	65	6	10	A	3.33	3.71	4.63	9.19	26.68	27.82	29.55	9,430					

● : 標準在庫品です。● : Stocked items. 干渉なし : No interference

EPDBPE2○○○○-○○○○-○○-ATH

商品コード Item code	在庫 Stock	寸法 Size(mm)														干渉角度 Interference angle (°)					勾配角に対する実有効首下長 Effective under neck length with respect to draft angle					希望小売 価格 (円) Suggested retail price (¥)
		ボール半径 Ball radius	外径 Tool dia.	首部 テーパー角 Neck angle	首下長 Under neck length	刃長 Flute length	首径 Neck dia.	首元径 Under neck dia.	全長 Overall length	シャンク径 Shank dia.	首R Neck R	首形状 Neck shape	仮想首長 Approx neck length	φ'	θκ	0.5°	1°	1.5°	2°	3°						
																					RE	DC	BHTA2	LU	APMX	
EPDBPE2020-30-14-ATH	●				30	1.7	1.92	3.303	70	6	10	A	3.33	3.24	4.63	9.19	31.74	33.02	35.42	12,220						
EPDBPE2020-40-14-ATH	●				40	1.7	1.92	3.792	80	6	10	A	3.33	2.60	4.63	9.19	41.85	43.36	干渉なし	14,150						
EPDBPE2020-50-14-ATH	●				50	1.7	1.92	4.281	90	6	10	B	3.33	2.16	4.63	9.19	51.96	53.67	干渉なし	15,530						
EPDBPE2020-75-14-ATH	●				75	1.7	1.92	5.503	115	6	10	B	3.33	1.51	4.63	9.19	77.19	干渉なし	干渉なし	18,000						
EPDBPE2020-12-29-ATH	●	1	2		12	1.7	1.92	2.964	55	6	7	A	2.48	6.30	2.80	3.27	4.09	5.83	13.57	6,840						
EPDBPE2020-15-29-ATH	●				15	1.7	1.92	3.267	60	6	7	A	2.48	5.60	2.80	3.27	4.09	5.83	16.59	7,080						
EPDBPE2020-20-29-ATH	●				20	1.7	1.92	3.774	65	6	10	A	2.48	4.72	2.80	3.27	4.09	5.83	22.08	9,430						
EPDBPE2020-41-29-ATH	●				41	1.7	1.92	6.000	130	6	-	C	2.48	2.85	2.8	3.27	4.09	5.83	干渉なし	14,680						
EPDBPE2020-20-49-ATH	●				4.9	20	1.7	1.92	5.058	65	6	10	B	2.16	5.19	2.29	2.46	2.68	2.98	4.04	12,970					
EPDBPE2030-8-04-ATH	●				8	2.5	2.86	2.937	50	6	4	A	8.50	6.25	8.87	9.13	9.35	9.55	10.33	8,490						
EPDBPE2030-16-04-ATH	●				16	2.5	2.86	3.048	55	6	7	A	12.52	4.01	17.25	17.89	18.38	18.79	20.60	9,430						
EPDBPE2030-20-04-ATH	●				20	2.5	2.86	3.104	60	6	7	A	12.52	3.40	21.29	22.04	22.60	23.34	25.74	10,020						
EPDBPE2030-30-04-ATH	●				30	2.5	2.86	3.244	70	6	10	A	12.52	2.46	31.67	32.88	33.73	34.92	干渉なし	11,680						
EPDBPE2030-40-04-ATH	●				40	2.5	2.86	3.384	80	6	10	A	12.52	1.93	41.78	43.23	44.38	干渉なし	干渉なし	12,970						
EPDBPE2030-50-04-ATH	●				50	2.5	2.86	3.523	90	6	10	A	12.52	1.59	51.87	53.53	55.41	干渉なし	干渉なし	15,000						
EPDBPE2030-80-04-ATH	●				80	2.5	2.86	3.942	120	6	10	A	12.52	1.04	82.14	84.60	干渉なし	干渉なし	干渉なし	19,280						
EPDBPE2030-15-09-ATH	●				15	2.5	2.86	3.253	55	6	7	A	6.95	4.30	13.78	16.35	16.95	17.41	18.64	9,430						
EPDBPE2030-20-09-ATH	●				20	2.5	2.86	3.410	60	6	7	A	6.95	3.50	13.78	21.40	22.14	22.68	24.78	10,020						
EPDBPE2030-30-09-ATH	●				30	2.5	2.86	3.724	70	6	10	A	6.95	2.54	13.78	31.82	33.00	33.84	干渉なし	11,680						
EPDBPE2030-35-09-ATH	●	1.5	3		35	2.5	2.86	3.881	75	6	10	A	6.95	2.24	13.78	36.87	38.18	39.11	干渉なし	12,320						
EPDBPE2030-40-09-ATH	●				40	2.5	2.86	4.038	80	6	10	A	6.95	2.00	13.78	41.92	43.34	干渉なし	干渉なし	12,970						
EPDBPE2030-50-09-ATH	●				50	2.5	2.86	4.352	90	6	10	B	6.95	1.64	13.78	52.01	53.64	干渉なし	干渉なし	15,000						
EPDBPE2030-60-09-ATH	●				60	2.5	2.86	4.667	100	6	10	B	6.95	1.39	13.78	62.10	干渉なし	干渉なし	干渉なし	16,500						
EPDBPE2030-70-09-ATH	●				70	2.5	2.86	4.981	110	6	10	B	6.95	1.20	13.78	72.19	干渉なし	干渉なし	干渉なし	18,540						
EPDBPE2030-90-09-ATH	●				90	2.5	2.86	5.609	130	6	10	B	6.95	0.95	13.78	干渉なし	干渉なし	干渉なし	干渉なし	21,650						
EPDBPE2030-30-14-ATH	●				30	2.5	2.86	4.204	70	6	10	B	5.36	2.63	7.51	15.05	31.97	33.13	干渉なし	11,680						
EPDBPE2030-40-14-ATH	●				40	2.5	2.86	4.693	80	6	10	B	5.36	2.05	7.51	15.05	42.06	43.46	干渉なし	12,970						
EPDBPE2030-50-14-ATH	●				50	2.5	2.86	5.182	90	6	10	B	5.36	1.68	7.51	15.05	52.16	干渉なし	干渉なし	15,000						
EPDBPE2030-66-14-ATH	●				66	2.5	2.86	6.000	140	6	-	C	5.36	1.34	7.51	15.05	干渉なし	干渉なし	干渉なし	16,500						
EPDBPE2030-30-29-ATH	●				2.9	30	2.5	2.86	5.646	70	6	10	B	3.88	2.83	4.37	5.14	6.45	9.22	干渉なし	13,610					
EPDBPE2040-60-04-ATH	●				60	8	3.86	4.586	110	8	10	A	18.02	1.74	62.14	63.88	66.58	干渉なし	干渉なし	18,860						
EPDBPE2040-100-04-ATH	●				100	8	3.86	5.145	150	8	10	B	18.02	1.10	102.44	105.83	干渉なし	干渉なし	干渉なし	25,390						
EPDBPE2040-20-09-ATH	●				20	8	3.86	4.237	70	8	7	A	12.45	4.26	20.79	21.76	22.37	22.87	25.16	11,370						
EPDBPE2040-30-09-ATH	●				30	8	3.86	4.551	80	8	7	A	12.45	3.17	25.53	31.83	32.66	33.95	37.45	11,370						
EPDBPE2040-35-09-ATH	●				35	8	3.86	4.708	85	8	7	A	12.45	2.82	25.53	36.87	37.79	39.50	干渉なし	12,320						
EPDBPE2040-40-09-ATH	●				40	8	3.86	4.865	90	8	10	B	12.45	2.53	25.53	42.31	43.56	45.04	干渉なし	14,460						
EPDBPE2040-50-09-ATH	●				50	8	3.86	5.180	100	8	10	B	12.45	2.10	25.53	52.39	53.84	56.12	干渉なし	17,040						
EPDBPE2040-60-09-ATH	●				60	8	3.86	5.494	110	8	10	B	12.45	1.80	25.53	62.46	64.14	干渉なし	干渉なし	18,640						
EPDBPE2040-120-09-ATH	●				120	8	3.86	7.379	170	8	-	D	12.45	0.97	25.53	干渉なし	干渉なし	干渉なし	干渉なし	38,780						
EPDBPE2040-45-14-ATH	●				45	8	3.86	5.669	95	8	10	B	10.86	2.37	15.79	33.06	47.66	48.93	干渉なし	15,000						
EPDBPE2040-80-14-ATH	●				80	8	3.86	7.379	130	8	10	B	10.86	1.43	15.79	33.06	干渉なし	干渉なし	干渉なし	23,360						
EPDBPE2040-25-29-ATH	●				2.9	25	8	3.86	5.582	75	8	7	B	9.38	3.99	10.91	13.27	17.30	25.73	27.74	11,370					
EPDBPE2050-100-04-ATH	●				0.4	100	10	4.86	6.117	150	8	10	B	20.02	0.85	102.48	干渉なし	干渉なし	干渉なし	干渉なし	26,370					
EPDBPE2050-30-09-ATH	●				30	10	4.86	5.488	80	8	7	B	14.45	2.58	29.41	31.92	32.71	34.04	干渉なし	17,850						
EPDBPE2050-40-09-ATH	●				40	10	4.86	5.803	90	8	7	B	14.45	2.02	29.41	41.98	43.12	45.12	干渉なし	18,300						
EPDBPE2050-60-09-ATH	●				60	10	4.86	6.431	110	8	10	B	14.45	1.40	29.41	62.56	干渉なし	干渉なし	干渉なし	19,870						
EPDBPE2050-90-09-ATH	●				90	10	4.86	7.373	140	8	10	B	14.45	0.96	29.41	干渉なし	干渉なし	干渉なし	干渉なし	25,370						
EPDBPE2050-60-14-ATH	●				60	10	4.86	7.304	110	8	10	B	12.86	1.43	18.62	38.82	干渉なし	干渉なし	干渉なし	19,870						
EPDBPE2050-74-14-ATH	●				74	10	4.86	8.000	150	8	-	C	12.86	1.21	18.62	38.82	干渉なし	干渉なし	干渉なし	24,020						
EPDBPE2050-40-29-ATH	●				2.9	40	10	4.86	8.000	90	8	-	C	11.38	2.28	13.23	16.06	20.92	31.18	干渉なし	18,300					
EPDBPE2060-120-04-ATH	●				0.4	120	12	5.86	7.368	200	8	-	D	22.02	0.49	干渉なし	干渉なし	干渉なし	干渉なし	干渉なし	42,080					
EPDBPE2060-30-09-ATH	●				30	12	5.86	6.426	80	8	7	B	16.45	1.87	30.63	32.00	32.76	干渉なし	干渉なし	干渉なし	17,850					
EPDBPE2060-40-09-ATH	●				40	12	5.86	6.740	90	8	7	B	16.45	1.44	33.29	42.06	干渉なし	干渉なし	干渉なし	19,080						
EPDBPE2060-45-09-ATH	●				45	12	5.86	6.897	95	8	7	B	16.45	1.29	33.29	47.09	干渉なし	干渉なし	干渉なし	20,540						
EPDBPE2060-50-09-ATH	●				50	12	5.86	7.054	100	8	7	B	16.45	1.16	33.29	52.12	干渉なし	干渉なし	干渉なし	20,880						
EPDBPE2060-60-09-ATH	●				60	12	5.86	7.368	110	10	10	B	16.45	1.82	33.29	62.65	64.34	干渉なし	干渉なし	29,630						
EPDBPE2060-70-09-ATH	●				70	12	5.86	7.682	120	10	10	B	16.45	1.59	33.29	72.71	74.90	干渉なし	干渉なし	31,420						
EPDBPE2060-80-09-ATH	●				80	12	5.86	7.996	130	10	10	B	16.45	1.41	33.29	82.78	干渉なし	干渉なし	干渉なし	33,220						
EPDBPE2060-120-09-ATH	●				120	12	5.86	9.253	200	10	-	D	16.45	0.98	33.29	干渉なし	干渉なし	干渉なし	干渉なし	43,760						
EPDBPE2060-50-14-ATH	●				50	12	5.86	7.717	100	10	7	B	14.86	2.19	21.46	44.58	52.43	54.41	干渉なし	20,880						
EPDBPE2060-96-14-ATH	●				96	12	5.86	10.000	200	10	-	C	14.86	1.24	21.46	44.58	干渉なし	干渉なし	干渉なし	43,760						
EPDBPE2060-30-29-ATH	●				2.9	30	12	5.86	7.684	80	10	7	B	13.38	3.53	15.54	18.85	24.53	31.45	33.60	19,640					
EPDBPE2070-45-09-ATH	●				0.9	45	14	6.86	7.834	95	10	7	B	18.45	1.85	37.16	47.17	48.59	干渉なし	干渉なし	23,010					
EPDBPE2070-60-14-ATH	●				1.4	60	14	6.86	9.108	110	10	7	B	16.86	1.46	24.29	50.33	干渉なし	干渉なし	干渉なし	25,700					
EPDBPE2070-40-29-ATH	●				2.9	40	14	6.86	9.494	90	10	7	B	15.38	2.24	17.85	21.64	28.14	40.93	干渉なし	22,220					

Carbide End Mills
Ball End Mills

EPDBPE2○○○○-○○○.○-○○○-ATH

商品コード Item code	在庫 Stock	寸法 Size(mm)													干渉角度 Interference angle (°)	勾配角に対する実有効首下長 Effective under neck length with respect to draft angle					希望小売 価格(円) Suggested retail price (¥)			
		ボール半径 Ball radius	外径 Tool dia.	首部 テーパー 角 Neck angle	首下長 Under neck length	刃長 Flute length	首径 Neck dia.	首元径 Under neck dia.	全長 Overall length	シャンク径 Shank dia.	首R	首形状	仮想首長 Approx neck length											
														RE		DC	BHTA2	LU	APMX	BD2		BD3	LF	DCONMS
EPDBPE2080-120-04-ATH	●	4	8	0.9	0.4	120	14	7.86	9.340	200	10	-	D	24.02	0.50	干渉なし	干渉なし	干渉なし	干渉なし	干渉なし	43,760			
EPDBPE2080-50-09-ATH	●				50	14	7.86	8.991	110	10	7	B	18.45	1.18	36.54	52.17	干渉なし	干渉なし	干渉なし	干渉なし	干渉なし	25,140		
EPDBPE2080-55-09-ATH	●				55	14	7.86	9.148	115	10	7	B	18.45	1.08	36.54	57.20	干渉なし	干渉なし	干渉なし	干渉なし	干渉なし	25,930		
EPDBPE2080-60-09-ATH	●				60	14	7.86	9.305	120	10	7	B	18.45	0.99	36.54	干渉なし	干渉なし	干渉なし	干渉なし	干渉なし	干渉なし	26,710		
EPDBPE2080-70-09-ATH	●				70	14	7.86	9.619	130	10	7	B	18.45	0.85	36.54	干渉なし	干渉なし	干渉なし	干渉なし	干渉なし	干渉なし	28,290		
EPDBPE2080-80-09-ATH	●				80	14	7.86	9.934	140	12	10	B	18.45	1.42	36.54	82.83	干渉なし	干渉なし	干渉なし	干渉なし	干渉なし	34,910		
EPDBPE2080-120-09-ATH	●				120	14	7.86	11.190	200	12	-	D	18.45	0.98	36.54	干渉なし	干渉なし	干渉なし	干渉なし	干渉なし	干渉なし	47,130		
EPDBPE2080-50-14-ATH	●				1.4	8	0.9	50	14	7.86	9.620	110	10	7	B	16.86	1.21	24.01	49.10	干渉なし	干渉なし	干渉なし	干渉なし	25,140
EPDBPE2080-98-14-ATH	●							98	14	7.86	12.000	200	12	-	C	16.86	1.22	24.01	49.10	干渉なし	干渉なし	干渉なし	干渉なし	47,130
EPDBPE2080-35-29-ATH	●							2.9	35	14	7.86	10.000	95	10	-	C	15.38	1.85	17.75	21.38	27.61	干渉なし	干渉なし	干渉なし
EPDBPE2100-120-04-ATH	●	5	10	0.9	0.4	120	18	9.86	11.284	200	12	-	D	28.02	0.50	干渉なし	干渉なし	干渉なし	干渉なし	干渉なし	51,180			
EPDBPE2100-60-09-ATH	●				60	18	9.86	11.180	130	12	7	B	22.45	1.00	44.30	干渉なし	干渉なし	干渉なし	干渉なし	干渉なし	32,990			
EPDBPE2100-65-09-ATH	●				65	18	9.86	11.337	135	12	7	B	22.45	0.93	44.30	干渉なし	干渉なし	干渉なし	干渉なし	干渉なし	33,900			
EPDBPE2100-75-09-ATH	●				75	18	9.86	11.651	140	12	7	B	22.45	0.81	44.30	干渉なし	干渉なし	干渉なし	干渉なし	干渉なし	34,910			
EPDBPE2100-86-09-ATH	●				86	18	9.86	12.000	200	12	-	C	22.45	0.71	44.30	干渉なし	干渉なし	干渉なし	干渉なし	干渉なし	51,180			
EPDBPE2100-55-14-ATH	●				1.4	10	0.9	55	18	9.86	11.669	125	12	7	B	20.86	1.12	29.68	55.87	干渉なし	干渉なし	干渉なし	干渉なし	31,420
EPDBPE2100-120-14-ATH	●							120	18	9.86	14.846	200	16	-	D	20.86	1.48	29.68	60.62	干渉なし	干渉なし	干渉なし	干渉なし	58,240
EPDBPE2100-35-29-ATH	●							2.9	35	18	9.86	11.582	105	12	4	B	19.38	1.84	22.37	26.96	34.84	干渉なし	干渉なし	干渉なし
EPDBPE2120-120-04-ATH	●				6	12	0.9	0.4	120	22	11.86	13.228	200	14	-	D	32.02	0.50	干渉なし	干渉なし	干渉なし	干渉なし	干渉なし	57,570
EPDBPE2120-75-09-ATH	●							75	22	11.86	13.525	150	14	-	D	26.45	0.83	52.05	干渉なし	干渉なし	干渉なし	干渉なし	干渉なし	45,120
EPDBPE2120-120-09-ATH	●	120	22	11.86				14.939	200	16	-	D	26.45	1.00	52.05	干渉なし	干渉なし	干渉なし	干渉なし	干渉なし	61,380			
EPDBPE2120-80-14-ATH	●	1.4	12	0.9				80	22	11.86	14.695	160	16	-	D	24.86	1.52	35.35	72.13	81.75	干渉なし	干渉なし	干渉なし	51,740
EPDBPE2120-106-14-ATH	●							106	22	11.86	16.000	200	16	-	C	24.86	1.15	35.35	72.13	干渉なし	干渉なし	干渉なし	干渉なし	61,380
EPDBPE2120-60-29-ATH	●	2.9	60	22	11.86	15.710	140	16	-	D	23.38	2.11	27.00	32.54	42.06	60.10	干渉なし	干渉なし	干渉なし	47,130				

首形状Cの商品の突き出し長さについて

Regarding over-hang length for products with neck shape C

首形状Cの商品は首部テーパー部が直接シャンクにつながっており、首下長よりも長い突出しでもご使用いただけます。また突出し長さを首下長よりも長くしてご使用される場合は、切削条件を調整してください。

Products with neck shape C have a neck taper section that runs directly into the shank, and can be used with over-hang lengths longer than the under-neck length.

Further, when using over-hang lengths longer than the under-neck length, the cutting conditions should be adjusted accordingly.

対象の商品コード Item code
EPDBPE2010-50-29-ATH
EPDBPE2015-46-29-ATH
EPDBPE2020-41-29-ATH
EPDBPE2030-66-14-ATH
EPDBPE2050-74-14-ATH
EPDBPE2050-40-29-ATH
EPDBPE2060-96-14-ATH
EPDBPE2080-98-14-ATH
EPDBPE2080-35-29-ATH
EPDBPE2100-86-09-ATH
EPDBPE2120-106-14-ATH

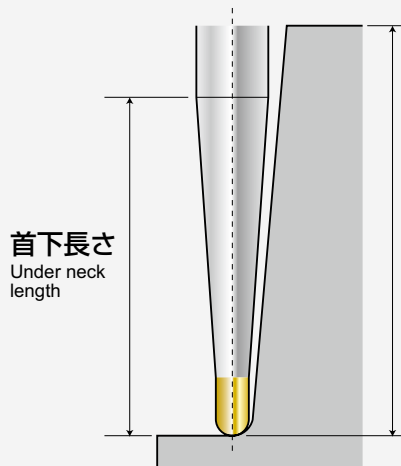

加工深さ Cutting depth

加工深さが首下長さ以上に深い場合でも、突出し長さを調整することにより加工可能です。

Even if the processing depth is longer than the under-neck length, cutting can be performed by adjusting the over-hang length.

対応被削材 Applicable work material

炭素鋼 合金鋼 Carbon steel Alloy steel	プリハー ド鋼 Pre-hardened steel	高硬度 Hardened steel			ステン レス鋼 Stainless steel	チタン合金 耐熱合金 Titanium alloy Heat-resistant alloy	銅合金 Copper alloy	アルミ 合金 Aluminum alloy
○	◎	> 45HRC ≤ 55HRC	> 55HRC ≤ 65HRC	> 65HRC	◎	◎	○	○

再研磨対応外径範囲 Re-grinding compatibility range

商品コード Item code	外周 Outer dia. (mm)	エンド End (mm)
EPDBPE-ATH	× (N/A)	4 ~ 12

[注意] 首下長/外径が10DCを超える工具の再研磨可否については、弊社営業にお問い合わせください。
[Note] Contact our sales office regarding whether or not regrinding is possible for tools where under neck length/tool diameter more than 10DC

● : 標準在庫品です。● : Stocked items. 干渉なし : No interference



標準切削条件表

Recommended cutting conditions

高能率切削条件

High efficiency cutting conditions

高精度切削条件

High accuracy cutting conditions

EPDBPE-ATH

高精度切削条件はA93ページを参照してください。Please refer to P.A93 about high accuracy cutting conditions

被削材 Work material					1		2		3		4		5			
					炭素鋼・合金鋼 Carbon steels, Alloy steels (180~250HB)		ステンレス鋼・工具鋼 Stainless steels, Tool steels (25~35HRC)		プリハードン鋼 Pre-hardened steels (35~45HRC)		焼入れ鋼 Hardened steels (45~55HRC)		焼入れ鋼 Hardened steels (55~65HRC)			
切り込み比率 Ratio to standard depth of cut					100%		90%		80%		65%		60%			
ボール半径RE Ball radius (mm)	外径DC Tool dia. (mm)	首副テーパ半角 BHTA2 Neck angle (°)	首下長LU Under neck length (mm)	ap (mm)	回転数 n min ⁻¹	送り速度 Vf mm/min	回転数 n min ⁻¹	送り速度 Vf mm/min	回転数 n min ⁻¹	送り速度 Vf mm/min	回転数 n min ⁻¹	送り速度 Vf mm/min	回転数 n min ⁻¹	送り速度 Vf mm/min		
0.1	0.2	0.4	1	0.017	40,000	800	34,000	680	28,000	504	26,000	416	26,000	364		
			1.5	0.009	40,000	800	34,000	680	28,000	504	26,000	416	26,000	364		
			2	0.006	32,000	461	27,200	392	22,400	323	20,800	266	20,800	233		
			3	0.003	21,000	235	17,850	200	14,640	164	13,200	147	13,200	132		
		0.9	2	0.007	32,000	461	27,200	392	22,400	323	20,800	266	20,800	233		
			2.5	0.004	26,000	333	22,100	283	18,200	204	16,900	189	16,900	162		
			3	0.004	21,000	235	17,850	200	14,640	164	13,200	147	13,200	132		
			1	0.020	40,000	800	34,000	680	28,000	504	26,000	416	26,000	364		
		1.4	2	0.008	32,000	461	27,200	392	22,400	323	20,800	266	20,800	233		
			3	0.005	21,000	235	17,850	200	14,640	164	13,200	147	13,200	132		
			1	0.022	40,000	800	34,000	680	28,000	504	26,000	416	26,000	364		
			2	0.009	32,000	461	27,200	392	22,400	323	20,800	266	20,800	233		
	2.9	3	0.006	21,000	235	17,850	200	14,640	164	13,200	147	13,200	132			
		2	0.025	40,000	1,200	34,000	1,020	28,000	756	26,000	624	26,000	546			
		3	0.012	32,000	691	27,200	588	22,400	484	20,800	399	20,800	349			
		3	0.013	32,000	691	27,200	588	22,400	484	20,800	399	20,800	349			
	0.2	0.4	0.4	2	0.035	40,000	1,600	34,000	1,360	28,000	1,008	26,000	832	26,000	728	
				3	0.020	40,000	1,600	34,000	1,360	28,000	1,008	26,000	832	26,000	728	
				4	0.007	32,000	922	27,200	783	22,400	645	20,800	532	20,800	466	
				5	0.006	26,000	666	22,100	566	18,200	408	16,900	379	16,900	324	
			0.9	6	0.004	21,000	471	17,850	400	14,640	295	13,200	266	13,200	239	
				8	0.002	17,000	272	14,450	231	11,850	189	10,700	153	10,700	137	
				2	0.038	40,000	1,600	34,000	1,360	28,000	1,008	26,000	832	26,000	728	
				4	0.009	32,000	922	27,200	783	22,400	645	20,800	532	20,800	466	
1.4			5	0.007	26,000	666	22,100	566	18,200	408	16,900	379	16,900	324		
			6	0.005	21,000	471	17,850	400	14,640	328	13,200	266	13,200	239		
			2	0.042	40,000	1,600	34,000	1,360	28,000	1,008	26,000	832	26,000	728		
			4	0.010	32,000	922	27,200	783	22,400	645	20,800	532	20,800	466		
2.9		6	0.006	21,000	471	17,850	400	14,640	328	13,200	266	13,200	239			
		2	0.045	40,000	1,600	34,000	1,360	28,000	1,008	26,000	832	26,000	728			
		4	0.011	32,000	922	27,200	783	22,400	645	20,800	532	20,800	466			
		6	0.007	21,000	471	17,850	400	14,640	328	13,200	266	13,200	239			
0.25		0.5	0.4	4	0.026	40,000	2,000	34,000	1,700	28,000	1,260	26,000	1,040	26,000	910	
				6	0.020	26,000	1,040	22,100	884	18,200	728	16,900	608	16,900	547	
				6	0.022	26,000	1,040	22,100	884	18,200	728	16,900	608	16,900	547	
			0.9	8	0.010	26,000	728	22,100	619	18,200	446	16,900	414	16,900	355	
				12	0.005	22,400	627	19,040	533	15,680	384	14,560	357	14,560	306	
				2	0.050	40,000	2,160	34,000	1,836	28,000	1,361	26,000	1,123	26,000	983	
		0.27	0.54	0.4	4	0.037	40,000	2,160	34,000	1,836	28,000	1,361	26,000	1,123	26,000	983
					5	0.031	40,000	1,512	34,000	1,428	28,000	1,176	26,000	1,040	26,000	832
	6				0.025	26,000	1,244	22,100	1,058	18,200	871	16,900	676	16,900	629	
	6.5				0.020	26,000	1,011	22,100	859	18,200	619	16,900	575	16,900	493	
	7				0.015	26,000	899	22,100	812	18,200	585	16,900	543	16,900	465	
	2				0.055	40,000	2,400	34,000	2,040	28,000	1,512	26,000	1,248	26,000	1,092	
0.3	0.6	0.4	4	0.035	40,000	2,400	34,000	2,040	28,000	1,512	26,000	1,248	26,000	1,092		
			6	0.018	32,000	1,382	27,200	1,175	22,400	968	20,800	799	20,800	699		
			8	0.015	26,000	998	22,100	848	18,200	698	16,900	583	16,900	524		
			10	0.013	26,000	874	22,100	743	18,200	535	16,900	497	16,900	426		
			12	0.008	26,000	874	22,100	743	18,200	535	16,900	497	16,900	426		
			15	0.005	22,400	753	19,040	640	15,680	461	14,560	367	14,560	311		
		0.9	4	0.038	40,000	2,400	34,000	2,040	28,000	1,512	26,000	1,248	26,000	1,092		
			6	0.020	32,000	1,382	27,200	1,175	22,400	968	20,800	799	20,800	699		
			8	0.018	26,000	998	22,100	849	18,200	612	16,900	568	16,900	487		
			10	0.015	26,000	874	22,100	743	18,200	535	16,900	497	16,900	426		
			12	0.010	26,000	874	22,100	743	18,200	535	16,900	497	16,900	426		
			15	0.006	22,400	753	19,040	640	15,680	461	14,560	367	14,560	311		
	1.4	4	0.042	40,000	2,400	34,000	2,040	28,000	1,512	26,000	1,248	26,000	1,092			
		5	0.029	36,000	1,800	30,600	1,530	25,090	1,254	22,580	1,015	20,320	822			
		6	0.022	32,000	1,382	27,200	1,175	22,400	968	20,800	799	20,800	699			
		8	0.020	26,000	998	22,100	849	18,200	612	16,900	568	16,900	487			
		10	0.016	26,000	874	22,100	743	18,200	535	16,900	497	16,900	426			
		20	0.005	19,300	583	16,410	495	13,460	406	12,110	328	12,110	295			
	2.9	6	0.023	32,000	1,382	27,200	1,175	22,400	968	20,800	799	20,800	699			
		8	0.022	26,000	998	22,100	849	18,200	612	16,900	568	16,900	487			
		12	0.011	26,000	874	22,100	743	18,200	535	16,900	497	16,900	426			
		20	0.006	19,300	583	16,410	495	13,460	406	12,110	328	12,110	295			
		0.4	0.8	0.4	4	0.062	32,000	2,560	27,200	2,176	22,400	1,613	20,800	1,331	20,800	1,165
					6	0.045	32,000	2,560	27,200	2,176	22,400	1,613	20,800	1,331	20,800	1,165
8	0.023				25,600	1,475	21,760	1,253	17,920	1,032	16,640	852	16,640	745		
12	0.018				20,800	1,065	17,680	905	14,560	699	13,520	606	13,520	519		

【注意】ご使用にあたっては、A92ページの表下の項目と注意を参照してください。

【Note】Upon usage, please refer to comments and notes below table on page A92.

Carbide End Mills

Ball End Mills

EPDBPE-ATH

高能率切削条件
High efficiency cutting conditions

高精度切削条件
High accuracy cutting conditions

高精度切削条件はA93 ページを参照してください。
Please refer to P.A93 about high accuracy cutting conditions

被削材 Work material				1		2		3		4		5							
				炭素鋼・合金鋼 Carbon steels, Alloy steels (180~250HB)		ステンレス鋼・工具鋼 Stainless steels, Tool steels (25~35HRC)		プリハードン鋼 Pre-hardened steels (35~45HRC)		焼入れ鋼 Hardened steels (45~55HRC)		焼入れ鋼 Hardened steels (55~65HRC)							
切り込み比率 Ratio to standard depth of cut				100%		90%		80%		65%		60%							
ボール半径RE Ball radius (mm)	外径DC Tool dia. (mm)	首下長LU Under neck length (mm)	首下長LU Under neck length (mm)	ap (mm)	回転数 n min ⁻¹	送り速度 Vi mm/min	回転数 n min ⁻¹	送り速度 Vi mm/min	回転数 n min ⁻¹	送り速度 Vi mm/min	回転数 n min ⁻¹	送り速度 Vi mm/min	回転数 n min ⁻¹	送り速度 Vi mm/min					
0.4	0.8	0.9	8	0.026	25,600	1,475	21,760	1,253	17,920	1,032	16,640	852	16,640	745					
			12	0.020	20,800	1,065	17,680	905	14,560	699	13,520	606	13,520	519					
		2.9	16	0.018	20,800	932	17,680	792	14,560	612	13,520	530	13,520	454					
			20	0.020	20,800	932	17,680	792	14,560	612	13,520	530	13,520	454					
0.45	0.9	0.4	4	0.063	28,300	2,547	24,060	2,164	19,730	1,774	17,760	1,437	17,760	1,293					
			8	0.050	28,300	2,547	24,060	2,164	19,730	1,774	17,760	1,437	17,760	1,293					
			12	0.037	18,400	1,325	15,640	1,126	12,820	922	11,540	746	11,540	671					
			16	0.024	18,400	1,325	15,640	1,126	12,820	922	11,540	746	11,540	671					
			18	0.018	18,400	1,325	15,640	1,126	12,820	922	11,540	746	11,540	671					
			20	0.015	15,850	1,141	13,470	969	11,050	794	9,950	643	9,950	578					
			22	0.012	15,850	1,141	13,470	969	11,050	794	9,950	643	9,950	578					
			24	0.009	14,150	1,009	12,030	856	9,860	699	8,870	564	8,870	479					
0.5	1	0.4	6	0.055	25,600	2,560	21,760	2,176	17,920	1,613	16,640	1,331	16,640	1,165					
			8	0.055	25,600	2,560	21,760	2,176	17,920	1,613	16,640	1,331	16,640	1,165					
			10	0.032	20,800	1,872	17,680	1,591	14,560	1,310	13,520	1,082	13,520	946					
			15	0.027	16,640	1,331	14,140	1,132	11,650	874	10,820	757	10,820	649					
			20	0.018	16,640	1,331	14,140	1,132	11,650	874	10,820	757	10,820	649					
			25	0.017	14,560	1,165	12,380	990	10,190	764	9,460	662	9,460	568					
			30	0.015	12,480	874	10,610	743	8,740	568	8,110	487	8,110	406					
			50	0.006	9,500	665	8,080	565	6,650	432	6,180	371	6,180	309					
			70	0.002	8,500	595	7,230	505	5,950	387	5,530	332	5,530	276					
			0.9	6	0.063	25,600	2,560	21,760	2,176	17,920	1,613	16,640	1,331	16,640	1,165				
				10	0.035	20,800	1,872	17,680	1,591	14,560	1,310	13,520	1,082	13,520	946				
				15	0.028	16,640	1,331	14,140	1,132	11,650	874	10,820	757	10,820	649				
		16		0.028	16,640	1,331	14,140	1,132	11,650	874	10,820	757	10,820	649					
		20		0.020	16,640	1,331	14,140	1,132	11,650	874	10,820	757	10,820	649					
		25		0.017	14,560	1,165	12,380	990	10,190	764	9,460	662	9,460	568					
		30		0.017	12,480	874	10,610	743	8,740	568	8,110	487	8,110	406					
		35		0.010	10,400	728	8,840	619	7,280	473	6,760	406	6,760	338					
		40		0.009	10,000	700	8,500	595	7,000	455	6,500	390	6,500	325					
		50		0.007	9,500	665	8,080	565	6,650	432	6,180	371	6,180	309					
		60		0.005	9,000	630	7,650	536	6,300	410	5,850	351	5,850	293					
		70		0.003	8,500	595	7,230	506	5,950	387	5,530	332	5,530	276					
		1.4	6	0.068	25,600	2,560	21,760	2,176	17,920	1,613	16,640	1,331	16,640	1,165					
			12	0.040	20,800	1,872	17,680	1,591	14,560	1,310	13,520	1,082	13,520	946					
			16	0.033	16,640	1,331	14,140	1,132	11,650	874	10,820	757	10,820	649					
			20	0.022	16,640	1,331	14,140	1,132	11,650	874	10,820	757	10,820	649					
			22	0.022	16,640	1,331	14,140	1,132	11,650	874	10,820	757	10,820	649					
			25	0.021	14,560	1,165	12,380	990	10,190	764	9,460	662	9,460	568					
			50	0.008	9,500	665	8,080	565	6,650	432	6,180	371	6,180	309					
			90	0.002	8,500	595	7,230	506	5,950	387	5,530	332	5,530	276					
			2.9	10	0.043	20,800	1,872	17,680	1,591	14,560	1,310	13,520	1,082	13,520	946				
				15	0.036	16,640	1,331	14,140	1,132	11,650	874	10,820	757	10,820	649				
				20	0.024	16,640	1,331	14,140	1,132	11,650	874	10,820	757	10,820	649				
				30	0.020	12,480	874	10,610	743	8,740	568	8,110	487	8,110	406				
		40		0.011	10,000	700	8,500	595	7,000	455	6,500	390	6,500	325					
		50		0.009	9,500	665	8,080	565	6,650	432	6,180	371	6,180	309					
		20		0.026	16,640	1,331	14,140	1,132	11,650	874	10,820	757	10,820	649					
		4.9		0.009	9,500	665	8,080	565	6,650	432	6,180	371	6,180	309					
		0.6	1.2	2.9	20	0.026	16,640	1,331	14,140	1,132	11,650	874	10,820	757	10,820	649			
					35	0.014	10,000	700	8,500	595	7,000	455	6,500	390	6,500	325			
					0.75	1.5	0.4	8	0.070	16,960	2,544	14,420	2,162	11,870	1,603	11,020	1,323	11,020	1,158
								10	0.070	16,960	2,544	14,420	2,162	11,870	1,603	11,020	1,323	11,020	1,158
		12	0.070	16,960				2,544	14,420	2,162	11,870	1,603	11,020	1,323	11,020	1,158			
		30	0.024	11,020				1,323	9,370	1,124	7,720	810	7,170	752	7,170	645			
		0.9	10	0.080			16,960	2,544	14,420	2,162	11,870	1,603	11,020	1,323	11,020	1,158			
			15	0.045			13,570	1,832	11,530	1,557	9,500	1,282	8,820	1,058	8,820	926			
			20	0.040			11,020	1,323	9,370	1,124	7,720	810	7,170	752	7,170	645			
			30	0.028			11,020	1,323	9,370	1,124	7,720	810	7,170	752	7,170	645			
		1.4	10	0.090	16,960	2,544	14,420	2,162	11,870	1,603	11,020	1,323	11,020	1,158					
20	0.045		11,020	1,323	9,370	1,124	7,720	810	7,170	752	7,170	645							
30	0.030		11,020	1,323	9,370	1,124	7,720	810	7,170	752	7,170	645							
40	0.015		9,500	1,045	8,080	888	6,630	728	5,970	589	5,970	530							
50	0.011		9,500	950	8,080	807	6,630	662	5,970	536	5,970	482							
20	0.048		11,020	1,323	9,370	1,124	7,720	810	7,170	752	7,170	645							
46	0.013		9,500	950	8,080	807	6,630	662	5,970	536	5,970	482							
0.9	1.8		0.4	4	0.120	14,200	2,556	12,070	2,173	9,940	1,610	9,230	1,329	9,230	1,163				
		8		0.100	14,200	2,556	12,070	2,173	9,940	1,610	9,230	1,329	9,230	1,163					
		12		0.080	14,200	2,556	12,070	2,173	9,940	1,610	9,230	1,329	9,230	1,163					
		16		0.071	14,200	2,556	12,070	2,173	9,940	1,610	9,230	1,329	9,230	1,163					
		20		0.062	9,230	1,329	7,850	1,130	6,460	814	6,000	756	6,000	648					

超硬ボールエンドミル

被削材 Work material					1		2		3		4		5			
					炭素鋼・合金鋼 Carbon steels, Alloy steels (180~250HB)		ステンレス鋼・工具鋼 Stainless steels, Tool steels (25~35HRC)		プリハードン鋼 Pre-hardened steels (35~45HRC)		焼入れ鋼 Hardened steels (45~55HRC)		焼入れ鋼 Hardened steels (55~65HRC)			
切り込み比率 Ratio to standard depth of cut					100%		90%		80%		65%		60%			
ボール半径RE Ball radius (mm)	外径DC Tool dia. (mm)	首下長LU Under neck length (mm)	首下長LU Under neck length (mm)	ap (mm)	回転数 n min ⁻¹	送り速度 Vf mm/min	回転数 n min ⁻¹	送り速度 Vf mm/min	回転数 n min ⁻¹	送り速度 Vf mm/min	回転数 n min ⁻¹	送り速度 Vf mm/min	回転数 n min ⁻¹	送り速度 Vf mm/min		
0.9	1.8	0.4	24	0.053	9,230	1,329	7,850	1,130	6,460	814	6,000	756	6,000	648		
			28	0.044	9,230	1,329	7,850	1,130	6,460	814	6,000	756	6,000	648		
			32	0.036	9,230	1,329	7,850	1,130	6,460	814	6,000	756	6,000	648		
			36	0.028	9,230	1,329	7,850	1,130	6,460	814	6,000	756	6,000	648		
			38	0.020	8,000	1,152	6,800	979	5,600	706	5,200	655	5,200	562		
			40	0.015	8,000	1,152	6,800	979	5,600	706	5,200	655	5,200	562		
1	2	0.4	8	0.150	15,200	3,040	12,920	2,584	10,640	1,915	9,880	1,581	9,880	1,383		
			12	0.090	15,200	3,040	12,920	2,584	10,640	1,915	9,880	1,581	9,880	1,383		
			16	0.090	15,200	3,040	12,920	2,584	10,640	1,915	9,880	1,581	9,880	1,383		
			20	0.060	12,160	2,189	10,340	1,860	8,510	1,532	7,900	1,265	7,900	1,107		
			25	0.050	9,880	1,581	8,400	1,344	6,916	968	6,420	899	6,420	771		
			30	0.040	9,880	1,581	8,400	1,344	6,920	968	6,420	899	6,420	771		
			40	0.030	9,880	1,581	8,400	1,344	6,920	968	6,420	899	6,420	771		
		80	0.004	6,150	861	5,230	731	4,305	560	4,000	480	4,000	400	400		
		0.9	12	0.100	15,200	3,040	12,920	2,584	10,640	1,915	9,880	1,581	9,880	1,383		
			16	0.100	15,200	3,040	12,920	2,584	10,640	1,915	9,880	1,581	9,880	1,383		
			20	0.070	12,160	2,189	10,340	1,860	8,512	1,532	7,900	1,265	7,900	1,107		
			25	0.070	9,880	1,581	8,400	1,344	6,916	968	6,420	899	6,420	771		
			30	0.045	9,880	1,581	8,400	1,344	6,916	968	6,420	899	6,420	771		
			35	0.045	9,880	1,581	8,400	1,344	6,916	968	6,420	899	6,420	771		
			40	0.035	9,880	1,581	8,400	1,344	6,916	968	6,420	899	6,420	771		
		1.4	50	0.017	8,510	1,192	7,240	1,013	5,958	775	5,530	664	5,530	553		
			60	0.009	7,240	1,013	6,150	861	5,065	658	4,700	564	4,700	470		
			70	0.005	6,150	861	5,230	731	4,305	560	4,000	480	4,000	400		
			75	0.005	6,150	861	5,230	731	4,305	560	4,000	480	4,000	400		
			10	0.110	15,200	3,040	12,920	2,584	10,640	1,915	9,880	1,581	9,880	1,383		
			16	0.110	15,200	3,040	12,920	2,584	10,640	1,915	9,880	1,581	9,880	1,383		
			20	0.075	12,160	2,189	10,340	1,860	8,512	1,532	7,900	1,265	7,900	1,107		
		2.9	22	0.075	12,160	2,189	10,340	1,860	8,512	1,532	7,900	1,265	7,900	1,107		
			25	0.062	9,880	1,581	8,400	1,344	6,916	968	6,420	899	6,420	771		
			30	0.050	9,880	1,581	8,400	1,344	6,916	968	6,420	899	6,420	771		
			40	0.037	9,880	1,581	8,400	1,344	6,916	968	6,420	899	6,420	771		
			50	0.019	8,510	1,192	7,240	1,013	5,958	775	5,530	664	5,530	553		
			75	0.006	6,150	861	5,230	731	4,305	560	4,000	480	4,000	400		
			12	0.120	15,200	3,040	12,920	2,584	10,640	1,915	9,880	1,581	9,880	1,383		
		4.9	15	0.120	15,200	3,040	12,920	2,584	10,640	1,915	9,880	1,581	9,880	1,383		
			20	0.080	12,160	2,189	10,340	1,860	8,512	1,532	7,900	1,265	7,900	1,107		
			41	0.040	9,880	1,581	8,400	1,344	6,916	968	6,420	899	6,420	771		
		20	0.087	12,160	2,189	10,340	1,860	8,512	1,532	7,900	1,265	7,900	1,107			
		1.5	3	0.4	8	0.320	12,720	3,816	10,810	3,244	8,904	2,404	8,270	1,984	8,270	1,736
					16	0.220	12,720	3,816	10,810	3,244	8,904	2,404	8,270	1,984	8,270	1,736
20	0.150				12,720	3,434	10,810	2,919	8,904	2,137	8,270	1,736	8,270	1,488		
30	0.080				10,176	2,748	8,650	2,335	7,123	1,496	6,610	1,389	6,610	1,191		
40	0.060				8,270	1,984	7,030	1,687	5,788	1,215	5,370	1,129	5,370	967		
0.9	50			0.043	8,270	1,984	7,030	1,687	5,788	1,215	5,370	1,129	5,370	967		
	80			0.016	6,230	1,371	5,300	1,165	4,363	896	4,050	748	4,050	673		
	15			0.250	12,720	3,816	10,810	3,244	8,904	2,404	8,270	1,984	8,270	1,736		
	20			0.170	12,720	3,434	10,810	2,919	8,904	2,137	8,270	1,736	8,270	1,488		
	30			0.090	10,180	2,748	8,650	2,335	7,123	1,496	6,610	1,389	6,610	1,191		
1.4	35			0.080	10,180	2,748	8,650	2,335	7,123	1,496	6,610	1,389	6,610	1,191		
	40			0.070	8,270	1,984	7,030	1,687	5,788	1,215	5,370	1,129	5,370	967		
	50			0.050	8,270	1,984	7,030	1,687	5,788	1,215	5,370	1,129	5,370	967		
	60			0.030	7,120	1,710	6,060	1,453	4,986	1,047	4,630	972	4,630	833		
	70			0.020	6,230	1,496	5,300	1,271	4,363	916	4,050	851	4,050	729		
2.9	90			0.013	6,230	1,371	5,300	1,165	4,363	896	4,050	748	4,050	673		
	30			0.100	10,180	2,748	8,650	2,335	7,123	1,496	6,610	1,389	6,610	1,191		
	40			0.075	8,270	1,984	7,030	1,687	5,788	1,215	5,370	1,129	5,370	967		
	50			0.053	8,270	1,984	7,030	1,687	5,788	1,215	5,370	1,129	5,370	967		
	66			0.022	6,230	1,496	5,300	1,165	4,363	916	4,050	748	4,050	673		
2	4	0.4	30	0.110	10,180	2,748	8,650	2,335	7,123	1,496	6,610	1,389	6,610	1,191		
			60	0.060	7,800	1,590	6,600	1,350	5,800	1,120	5,000	920	5,000	870		
		0.9	100	0.030	6,230	1,246	5,300	1,059	4,350	869	3,920	704	3,920	633		
			20	0.320	11,900	2,860	10,100	2,420	9,000	2,050	7,800	1,680	7,800	1,590		
			30	0.230	11,900	2,570	10,100	2,180	9,000	1,850	7,800	1,520	7,800	1,430		
			35	0.200	11,900	2,570	10,100	2,180	9,000	1,850	7,800	1,520	7,800	1,430		
			40	0.140	9,500	1,940	8,100	1,650	7,200	1,400	6,200	1,140	6,200	1,080		
			50	0.110	7,800	1,590	6,600	1,350	5,800	1,120	5,000	920	5,000	870		
			60	0.070	7,800	1,590	6,600	1,350	5,800	1,120	5,000	920	5,000	870		
			120	0.030	6,230	1,246	5,300	1,059	4,350	869	3,920	704	3,920	633		

[注意] ご使用にあたっては、A92ページの表下の項目と注意を参照してください。

[Note] Upon usage, please refer to comments and notes below table on page A92.

EPDBPE-ATH

高能率切削条件
High efficiency cutting conditions

高精度切削条件
High accuracy cutting conditions

高精度切削条件はA93ページを参照してください。
Please refer to P.A93 about high accuracy cutting conditions

被削材 Work material					1		2		3		4		5			
					炭素鋼・合金鋼 Carbon steels, Alloy steels (180~250HB)		ステンレス鋼・工具鋼 Stainless steels, Tool steels (25~35HRC)		プリハードン鋼 Pre-hardened steels (35~45HRC)		焼入れ鋼 Hardened steels (45~55HRC)		焼入れ鋼 Hardened steels (55~65HRC)			
切り込み比率 Ratio to standard depth of cut					100%		90%		80%		65%		60%			
ボール半径RE Ball radius (mm)	外径DC Tool dia. (mm)	首径D Neck dia. (mm)	首下長LU Under neck length (mm)	首下長LU Under neck length (mm)	回転数 n min ⁻¹	送り速度 Vf mm/min	回転数 n min ⁻¹	送り速度 Vf mm/min	回転数 n min ⁻¹	送り速度 Vf mm/min	回転数 n min ⁻¹	送り速度 Vf mm/min	回転数 n min ⁻¹	送り速度 Vf mm/min		
2	4	1.4	45	0.120	7,800	1,590	6,600	1,350	5,800	1,120	5,000	920	5,000	870		
			80	0.060	6,230	1,246	5,300	1,059	4,350	869	3,920	704	3,920	633		
2.5	5	0.4	25	0.250	11,900	2,570	10,100	2,180	9,000	1,850	7,800	1,520	7,800	1,430		
			100	0.055	4,050	850	3,440	722	2,820	591	2,540	479	2,540	431		
		0.9	30	0.340	9,500	2,140	8,100	1,820	7,200	1,540	6,200	1,260	6,200	1,190		
			40	0.250	9,500	2,140	8,100	1,820	7,200	1,540	6,200	1,260	6,200	1,190		
			60	0.150	6,200	1,320	5,300	1,130	4,700	950	4,000	770	4,000	720		
		1.4	60	0.080	4,050	850	3,440	722	2,820	591	2,540	479	2,540	431		
			60	0.165	6,200	1,320	5,300	1,130	4,700	950	4,000	770	4,000	720		
			74	0.160	6,200	1,320	5,300	1,130	4,700	950	4,000	770	4,000	720		
		2.9	40	0.300	9,500	2,140	8,100	1,820	7,200	1,540	6,200	1,260	6,200	1,190		
		3	6	0.4	120	0.060	4,200	840	3,570	714	2,930	586	2,900	522	2,900	469
30	0.450				8,000	2,000	6,800	1,700	6,000	1,430	5,200	1,170	5,200	1,110		
0.9	40			0.400	8,000	1,800	6,800	1,530	6,000	1,280	5,200	1,050	5,200	990		
	45			0.370	8,000	1,800	6,800	1,530	6,000	1,280	5,200	1,050	5,200	990		
	50			0.320	8,000	1,800	6,800	1,530	6,000	1,280	5,200	1,050	5,200	990		
	60			0.220	6,400	1,360	5,400	1,150	4,800	970	4,100	780	4,100	740		
	70			0.180	5,200	1,110	4,400	940	3,900	790	3,400	650	3,400	610		
	80			0.140	5,200	1,110	4,400	940	3,900	790	3,400	650	3,400	610		
1.4	120			0.072	4,200	840	3,570	714	2,930	586	2,640	475	2,640	427		
	50			0.350	8,000	1,800	6,800	1,530	6,000	1,280	5,200	1,050	5,200	990		
2.9	30			0.540	8,000	2,000	6,800	1,700	6,000	1,430	5,200	1,170	5,200	1,110		
3.5	7			0.9	45	0.370	8,000	1,800	6,800	1,530	6,000	1,280	5,200	1,050	5,200	990
					1.4	60	0.350	6,400	1,360	5,400	1,150	4,800	970	4,100	780	4,100
				2.9	40	0.500	8,000	1,800	6,800	1,530	6,000	1,280	5,200	1,050	5,200	990
		0.4	120		0.170	3,840	805	3,260	684	2,670	560	2,400	453	2,400	407	
4	8	0.9	50	0.500	6,000	1,460	5,100	1,240	4,500	1,040	3,900	850	3,900	810		
			55	0.470	6,000	1,460	5,100	1,240	4,500	1,040	3,900	850	3,900	810		
			60	0.430	6,000	1,460	5,100	1,240	4,500	1,040	3,900	850	3,900	810		
			70	0.330	6,000	1,460	5,100	1,240	4,500	1,040	3,900	850	3,900	810		
			80	0.250	4,800	1,100	4,080	935	3,350	767	3,020	622	3,020	559		
			120	0.190	3,840	805	3,260	684	2,670	560	2,400	453	2,400	407		
		1.4	50	0.550	6,000	1,460	5,100	1,240	4,500	1,040	3,900	850	3,900	810		
			98	0.250	3,840	805	3,260	684	2,670	560	2,400	453	2,400	407		
		2.9	35	0.700	6,000	1,460	5,100	1,240	4,500	1,040	3,900	850	3,900	810		
		5	10	0.4	120	0.250	3,120	780	2,650	663	2,170	542	1,950	438	1,950	394
60	0.700				4,800	1,300	4,100	1,110	3,600	920	3,100	750	3,100	710		
65	0.600				4,800	1,300	4,100	1,110	3,600	920	3,100	750	3,100	710		
75	0.500				4,800	1,300	4,100	1,110	3,600	920	3,100	750	3,100	710		
0.9	86			0.400	3,840	1,000	3,260	850	2,670	696	2,400	563	2,400	506		
	55			0.800	4,800	1,300	4,100	1,110	3,600	920	3,100	750	3,100	710		
1.4	120			0.270	3,120	780	2,650	663	2,170	542	1,950	438	1,950	394		
	2.9			35	0.900	5,280	1,480	4,490	1,258	3,680	1,031	3,310	834	3,310	750	
6	12	0.4	120	0.380	2,500	750	2,130	637	1,810	541	1,630	438	1,630	394		
			75	0.720	3,840	1,250	3,260	1,062	2,770	902	2,490	729	2,490	656		
			120	0.400	2,500	750	2,130	637	1,810	541	1,630	438	1,630	394		
			80	0.790	3,840	1,250	3,260	1,062	2,770	902	2,490	729	2,490	656		
		0.9	106	0.450	2,500	750	2,130	637	1,810	541	1,630	438	1,630	394		
			2.9	60	0.900	3,840	1,250	3,260	1,062	2,770	902	2,490	729	2,490	656	

※(1) 基本切り込みは被削材グループ1での目安を示しています。その他のグループの場合は、上表の切り込み比率を目安に調整して下さい。
 ※(2) リブ加工や止まり溝など、切りくずがつまりやすい切削の場合、切り込み設定は基本切り込みで切り込み比率をかけて算出した切り込み量を、さらにその80%まで小さくして使用して下さい。

※(1) Standard cutting depth is shown as the criteria for Group 1 workpieces. For other groups, adjust the cutting depth according to the cutting depth factors in the above table.
 ※(2) When performing cutting where cutting chips may cause clogging, such as for rib cutting, blind grooves, etc., cutting depth setting should be set by multiplying a cutting depth factor to calculate the cutting depth amount, and this amount should then be reduced to 80% of the calculated value.

【切り込み設定例】 EPDBPE2020-25-09-ATHの工具で焼き入れ鋼(50HRC)をリブ溝等高線切削する場合、
 切り込み=0.07(基本切り込み)×0.65(焼き入れ鋼グループ4の切り込み比率)×0.8(閉鎖域の切削)=0.036

Cutting depth setting example: When cutting rib groove contours in pre-harden steel (50HRC) using an EPDBPE2020-25-09-ATH tool:
 Cutting depth = 0.07 (standard cutting depth) × 0.65 (cutting depth factor for Group 4 pre-harden steel) × 0.8 (for closed-area cutting) = 0.036mm

- 【注意】**
- ① 被削材、加工形状に合わせて、適切なクーラントを使用して下さい。
 - ② この標準切削条件表は切削条件の目安を示すものです。実際の加工では加工形状、目的、使用機械等により条件を調整して下さい。
 - ③ 機械の回転数が足りない場合は、回転数と送り速度を同じ比率で下げてください。

【Note】

- ① Use the appropriate coolant for the work material and machining shape.
- ② These Recommended Cutting Conditions indicate only the rule of a thumb for the cutting conditions. In actual machining, the condition should be adjusted according to the machining shape, purpose and the machine type.
- ③ If the rpm of the machine is low, lower the feed rate also to put the rpm and feed rate in the same ratio.



標準切削条件表

Recommended cutting conditions

高能率切削条件

High efficiency cutting condition

高精度切削条件

High accuracy cutting condition

EPDBPE-ATH

高能率切削条件はA89ページを参照してください。Please refer to P.A89 about high efficiency cutting conditions

Carbide End Mills

Ball End Mills

被削材 Work material					1		2		3		4		5		
					炭素鋼・合金鋼 Carbon steels, Alloy steels (180~250HB)		ステンレス鋼・工具鋼 Stainless steels, Tool steels (25~35HRC)		プリハードン鋼 Pre-hardened steels (35~45HRC)		焼入れ鋼 Hardened steels (45~55HRC)		焼入れ鋼 Hardened steels (55~65HRC)		
切り込み比率 Ratio to standard depth of cut					100%		90%		80%		65%		60%		
ボール半径RE Ball radius (mm)	外径DC Tool dia. (mm)	首下長LU Under neck length (mm)	首下長LU Under neck length (mm)	首下長LU Under neck length (mm)	回転数 n min ⁻¹	送り速度 Vf mm/min	回転数 n min ⁻¹	送り速度 Vf mm/min	回転数 n min ⁻¹	送り速度 Vf mm/min	回転数 n min ⁻¹	送り速度 Vf mm/min	回転数 n min ⁻¹	送り速度 Vf mm/min	
0.1	0.2	0.4	1	0.012	40,000	560	34,000	476	28,000	353	26,000	291	26,000	255	
			1.5	0.006	40,000	560	34,000	476	28,000	353	26,000	291	26,000	255	
			2	0.004	32,000	323	27,200	274	22,400	226	20,800	186	20,800	163	
		0.9	3	0.003	21,000	165	17,850	140	14,640	115	13,200	103	13,200	92	
			2	0.005	32,000	323	27,200	274	22,400	226	20,800	186	20,800	163	
			2.5	0.003	26,000	233	22,100	198	18,200	143	16,900	132	16,900	113	
		1.4	3	0.003	21,000	165	17,850	140	14,640	115	13,200	103	13,200	92	
			1	0.014	40,000	560	34,000	476	28,000	353	26,000	291	26,000	255	
			2	0.006	32,000	323	27,200	274	22,400	226	20,800	186	20,800	163	
		2.9	3	0.004	21,000	165	17,850	140	14,640	115	13,200	103	13,200	92	
			1	0.015	40,000	560	34,000	476	28,000	353	26,000	291	26,000	255	
			2	0.006	32,000	323	27,200	274	22,400	226	20,800	186	20,800	163	
	0.15	0.3	0.4	2	0.018	40,000	840	34,000	714	28,000	529	26,000	437	26,000	382
				3	0.008	32,000	484	27,200	412	22,400	339	20,800	279	20,800	244
				3	0.009	32,000	484	27,200	412	22,400	339	20,800	279	20,800	244
			0.9	4	0.005	26,000	349	22,100	297	18,200	214	16,900	199	16,900	170
				2	0.025	40,000	1,120	34,000	952	28,000	706	26,000	582	26,000	510
				3	0.014	40,000	1,120	34,000	952	28,000	706	26,000	582	26,000	510
		0.4	0.4	4	0.005	32,000	645	27,200	548	22,400	452	20,800	372	20,800	326
				5	0.004	26,000	466	22,100	396	18,200	286	16,900	265	16,900	227
				6	0.003	21,000	330	17,850	280	14,640	230	13,200	186	13,200	167
			0.9	2	0.027	40,000	1,120	34,000	952	28,000	706	26,000	582	26,000	510
				4	0.006	32,000	645	27,200	548	22,400	452	20,800	372	20,800	326
				5	0.005	26,000	466	22,100	396	18,200	286	16,900	265	16,900	227
1.4	2	0.004	21,000	330	17,850	280	14,640	230	13,200	186	13,200	167			
	2	0.029	40,000	1,120	34,000	952	28,000	706	26,000	582	26,000	510			
	4	0.007	32,000	645	27,200	548	22,400	452	20,800	372	20,800	326			
0.25	0.5	0.4	2	0.032	40,000	1,120	34,000	952	28,000	706	26,000	582	26,000	510	
			4	0.008	32,000	645	27,200	548	22,400	452	20,800	372	20,800	326	
			6	0.006	21,000	330	17,850	280	14,640	230	13,200	186	13,200	167	
		0.9	4	0.018	40,000	1,400	34,000	1,190	28,000	882	26,000	728	26,000	637	
			6	0.010	26,000	728	22,100	619	18,200	510	16,900	426	16,900	383	
			6	0.012	26,000	728	22,100	619	18,200	510	16,900	426	16,900	383	
0.27	0.54	0.4	8	0.009	26,000	510	22,100	433	18,200	312	16,900	290	16,900	249	
			12	0.004	22,400	502	19,040	426	15,680	307	14,560	286	14,560	245	
			2	0.034	40,000	1,512	34,000	1,285	28,000	953	26,000	786	26,000	688	
			4	0.024	40,000	1,512	34,000	1,285	28,000	953	26,000	786	26,000	688	
			5	0.018	40,000	1,058	34,000	1,000	28,000	823	26,000	728	26,000	582	
			6	0.014	26,000	871	22,100	741	18,200	610	16,900	473	16,900	440	
		0.6	6.5	0.013	26,000	708	22,100	601	18,200	433	16,900	403	16,900	345	
			7	0.012	26,000	629	22,100	568	18,200	410	16,900	380	16,900	326	
			2	0.039	40,000	1,680	34,000	1,428	28,000	1,058	26,000	874	26,000	764	
			4	0.025	40,000	1,680	34,000	1,428	28,000	1,058	26,000	874	26,000	764	
			6	0.013	32,000	967	27,200	823	22,400	678	20,800	559	20,800	489	
			8	0.012	26,000	699	22,100	594	18,200	489	16,900	408	16,900	367	
0.3	0.6	0.4	10	0.011	26,000	612	22,100	520	18,200	375	16,900	348	16,900	298	
			12	0.007	26,000	612	22,100	520	18,200	375	16,900	348	16,900	298	
			15	0.004	22,400	602	19,040	512	15,680	369	14,560	294	14,560	249	
			4	0.027	40,000	1,680	34,000	1,428	28,000	1,058	26,000	874	26,000	764	
			6	0.015	32,000	967	27,200	823	22,400	678	20,800	559	20,800	489	
			8	0.014	26,000	699	22,100	594	18,200	428	16,900	398	16,900	341	
		0.9	10	0.013	26,000	612	22,100	520	18,200	375	16,900	348	16,900	298	
			12	0.009	26,000	612	22,100	520	18,200	375	16,900	348	16,900	298	
			15	0.005	22,400	602	19,040	512	15,680	369	14,560	294	14,560	249	
			4	0.029	40,000	1,680	34,000	1,428	28,000	1,058	26,000	874	26,000	764	
			5	0.020	36,000	1,260	30,600	1,071	25,090	878	22,580	711	20,320	575	
			6	0.017	32,000	967	27,200	823	22,400	678	20,800	559	20,800	489	
	1.4	8	0.015	26,000	699	22,100	594	18,200	428	16,900	398	16,900	341		
		10	0.014	26,000	612	22,100	520	18,200	375	16,900	348	16,900	298		
		20	0.004	19,300	466	16,410	396	13,460	325	12,110	262	12,110	236		
		6	0.016	32,000	967	27,200	823	22,400	678	20,800	559	20,800	489		
		8	0.015	26,000	699	22,100	594	18,200	428	16,900	398	16,900	341		
		12	0.009	26,000	612	22,100	520	18,200	375	16,900	348	16,900	298		
	0.4	0.8	0.4	20	0.005	19,300	466	16,410	396	13,460	325	12,110	262	12,110	236
				4	0.043	32,000	1,792	27,200	1,523	22,400	1,129	20,800	932	20,800	816
				6	0.032	32,000	1,792	27,200	1,523	22,400	1,129	20,800	932	20,800	816
				8	0.016	25,600	1,033	21,760	877	17,920	722	16,640	596	16,640	522
				12	0.015	20,800	746	17,680	634	14,560	489	13,520	424	13,520	363

[注意] ご使用にあたっては、A96ページの表下の項目と注意を参照してください。 **[Note]** Upon usage, please refer to comments and notes below table on page A96.

EPDBPE-ATH

高能率切削条件
High efficiency cutting condition

高精度切削条件
High accuracy cutting condition

高能率切削条件はA89ページを参照してください。
Please refer to P.A89 about high efficiency cutting conditions

被削材 Work material					1		2		3		4		5	
					炭素鋼・合金鋼 Carbon steels, Alloy steels (180~250HB)		ステンレス鋼・工具鋼 Stainless steels, Tool steels (25~35HRC)		プリハードン鋼 Pre-hardened steels (35~45HRC)		焼入れ鋼 Hardened steels (45~55HRC)		焼入れ鋼 Hardened steels (55~65HRC)	
切り込み比率 Ratio to standard depth of cut					100%		90%		80%		65%		60%	
ボール半径RE Ball radius (mm)	外径DC Tool dia. (mm)	首下長LU Under neck length (mm)	首下長LU Under neck length (mm)	ap (mm)	回転数 n min ⁻¹	送り速度 Vf mm/min	回転数 n min ⁻¹	送り速度 Vf mm/min	回転数 n min ⁻¹	送り速度 Vf mm/min	回転数 n min ⁻¹	送り速度 Vf mm/min	回転数 n min ⁻¹	送り速度 Vf mm/min
0.4	0.8	0.9	8	0.018	25,600	1,033	21,760	877	17,920	722	16,640	596	16,640	522
			12	0.017	20,800	746	17,680	634	14,560	489	13,520	424	13,520	363
			16	0.015	20,800	652	17,680	554	14,560	428	13,520	371	13,520	318
			16	0.017	20,800	652	17,680	554	14,560	428	13,520	371	13,520	318
0.45	0.9	0.4	4	0.044	28,300	1,783	24,060	1,515	19,730	1,242	17,760	1,006	17,760	905
			8	0.035	28,300	1,783	24,060	1,515	19,730	1,242	17,760	1,006	17,760	905
			12	0.031	18,400	928	15,640	788	12,820	645	11,540	522	11,540	470
			16	0.020	18,400	928	15,640	788	12,820	645	11,540	522	11,540	470
			18	0.015	18,400	928	15,640	788	12,820	645	11,540	522	11,540	470
			20	0.015	15,850	913	13,470	775	11,050	635	9,950	514	9,950	462
			22	0.012	15,850	913	13,470	775	11,050	635	9,950	514	9,950	462
			24	0.009	14,150	807	12,030	685	9,860	559	8,870	451	8,870	383
0.5	1	0.4	6	0.039	25,600	1,792	21,760	1,523	17,920	1,129	16,640	932	16,640	816
			8	0.039	25,600	1,792	21,760	1,523	17,920	1,129	16,640	932	16,640	816
			10	0.023	20,800	1,310	17,680	1,114	14,560	917	13,520	757	13,520	662
			15	0.022	16,640	932	14,140	792	11,650	612	10,820	530	10,820	454
			20	0.015	16,640	932	14,140	792	11,650	612	10,820	530	10,820	454
			25	0.014	14,560	816	12,380	693	10,190	535	9,460	463	9,460	397
			30	0.013	12,480	699	10,610	594	8,740	454	8,110	390	8,110	325
			50	0.006	9,500	532	8,080	452	6,650	346	6,180	297	6,180	247
		70	0.002	8,500	476	7,230	404	5,950	310	5,530	266	5,530	221	
		0.9	6	0.044	25,600	1,792	21,760	1,523	17,920	1,129	16,640	932	16,640	816
			10	0.025	20,800	1,310	17,680	1,114	14,560	917	13,520	757	13,520	662
			15	0.024	16,640	932	14,140	792	11,650	612	10,820	530	10,820	454
			16	0.024	16,640	932	14,140	792	11,650	612	10,820	530	10,820	454
			20	0.017	16,640	932	14,140	792	11,650	612	10,820	530	10,820	454
			25	0.016	14,560	816	12,380	693	10,190	535	9,460	463	9,460	397
			30	0.015	12,480	699	10,610	594	8,740	454	8,110	390	8,110	325
			35	0.010	10,400	582	8,840	495	7,280	378	6,760	325	6,760	270
		1.4	40	0.009	10,000	560	8,500	476	7,000	364	6,500	312	6,500	260
			50	0.007	9,500	532	8,080	452	6,650	346	6,180	297	6,180	247
			60	0.005	9,000	504	7,650	429	6,300	328	5,850	281	5,850	234
			70	0.003	8,500	476	7,230	405	5,950	310	5,530	266	5,530	221
			6	0.048	25,600	1,792	21,760	1,523	17,920	1,129	16,640	932	16,640	816
			12	0.034	20,800	1,310	17,680	1,114	14,560	917	13,520	757	13,520	662
			16	0.028	16,640	932	14,140	792	11,650	612	10,820	530	10,820	454
			20	0.020	16,640	932	14,140	792	11,650	612	10,820	530	10,820	454
		2.9	22	0.018	16,640	932	14,140	792	11,650	612	10,820	530	10,820	454
			25	0.017	14,560	816	12,380	693	10,190	535	9,460	463	9,460	397
			50	0.008	9,500	532	8,080	452	6,650	346	6,180	297	6,180	247
			90	0.002	8,500	476	7,230	405	5,950	310	5,530	266	5,530	221
			10	0.032	20,800	1,310	17,680	1,114	14,560	917	13,520	757	13,520	662
			15	0.030	16,640	932	14,140	792	11,650	612	10,820	530	10,820	454
			20	0.020	16,640	932	14,140	792	11,650	612	10,820	530	10,820	454
30	0.018		12,480	699	10,610	594	8,740	454	8,110	390	8,110	325		
4.9	40	0.011	10,000	560	8,500	476	7,000	364	6,500	312	6,500	260		
	50	0.009	9,500	532	8,080	452	6,650	346	6,180	297	6,180	247		
	20	0.022	16,640	932	14,140	792	11,650	612	10,820	530	10,820	454		
	35	0.013	10,000	560	8,500	476	7,000	364	6,500	312	6,500	260		
0.75	1.5	0.4	8	0.049	16,960	1,781	14,420	1,513	11,870	1,122	11,020	926	11,020	811
			10	0.049	16,960	1,781	14,420	1,513	11,870	1,122	11,020	926	11,020	811
			12	0.049	16,960	1,781	14,420	1,513	11,870	1,122	11,020	926	11,020	811
			30	0.020	11,020	926	9,370	787	7,720	567	7,170	526	7,170	452
		0.9	10	0.056	16,960	1,781	14,420	1,513	11,870	1,122	11,020	926	11,020	811
			15	0.034	13,570	1,282	11,530	1,090	9,500	897	8,820	741	8,820	648
			20	0.032	11,020	926	9,370	787	7,720	567	7,170	526	7,170	452
			30	0.024	11,020	926	9,370	787	7,720	567	7,170	526	7,170	452
		1.4	10	0.063	16,960	1,781	14,420	1,513	11,870	1,122	11,020	926	11,020	811
			20	0.038	11,020	926	9,370	787	7,720	567	7,170	526	7,170	452
			30	0.026	11,020	926	9,370	787	7,720	567	7,170	526	7,170	452
			40	0.015	9,500	836	8,080	710	6,630	582	5,970	471	5,970	424
		2.9	50	0.011	9,500	760	8,080	646	6,630	530	5,970	429	5,970	386
			20	0.041	11,020	926	9,370	787	7,720	567	7,170	526	7,170	452
			46	0.013	9,500	760	8,080	646	6,630	530	5,970	429	5,970	386
			4	0.084	14,200	1,789	12,070	1,521	9,940	1,127	9,230	930	9,230	814
0.9	1.8	0.4	8	0.070	14,200	1,789	12,070	1,521	9,940	1,127	9,230	930	9,230	814
			12	0.056	14,200	1,789	12,070	1,521	9,940	1,127	9,230	930	9,230	814
			16	0.053	14,200	1,789	12,070	1,521	9,940	1,127	9,230	930	9,230	814
			20	0.050	9,230	930	7,850	791	6,460	570	6,000	529	6,000	454

超硬ボールペンシル

被削材 Work material					1		2		3		4		5				
					炭素鋼・合金鋼 Carbon steels, Alloy steels (180~250HB)		ステンレス鋼・工具鋼 Stainless steels, Tool steels (25~35HRC)		プリハードン鋼 Pre-hardened steels (35~45HRC)		焼入れ鋼 Hardened steels (45~55HRC)		焼入れ鋼 Hardened steels (55~65HRC)				
切り込み比率 Ratio to standard depth of cut					100%		90%		80%		65%		60%				
ボール半径RE Ball radius (mm)	外径DC Tool dia. (mm)	首下長LU Under neck length (mm)	首下長LU Under neck length (mm)	首下長LU Under neck length (mm)	回転数 n min ⁻¹	送り速度 V _f mm/min	回転数 n min ⁻¹	送り速度 V _f mm/min	回転数 n min ⁻¹	送り速度 V _f mm/min	回転数 n min ⁻¹	送り速度 V _f mm/min	回転数 n min ⁻¹	送り速度 V _f mm/min			
0.9	1.8	0.4	24	0.045	9,230	930	7,850	791	6,460	570	6,000	529	6,000	454			
			28	0.037	9,230	930	7,850	791	6,460	570	6,000	529	6,000	454			
			32	0.031	9,230	930	7,850	791	6,460	570	6,000	529	6,000	454			
			36	0.024	9,230	930	7,850	791	6,460	570	6,000	529	6,000	454			
			38	0.020	8,000	922	6,800	783	5,600	565	5,200	524	5,200	450			
			40	0.015	8,000	922	6,800	783	5,600	565	5,200	524	5,200	450			
1	2	0.4	8	0.105	15,200	2,128	12,920	1,809	10,640	1,341	9,880	1,107	9,880	968			
			12	0.063	15,200	2,128	12,920	1,809	10,640	1,341	9,880	1,107	9,880	968			
			16	0.063	15,200	2,128	12,920	1,809	10,640	1,341	9,880	1,107	9,880	968			
			20	0.043	12,160	1,532	10,340	1,302	8,510	1,072	7,900	886	7,900	775			
			25	0.042	9,880	1,107	8,400	941	6,916	678	6,420	629	6,420	540			
			30	0.034	9,880	1,107	8,400	941	6,920	678	6,420	629	6,420	540			
			40	0.026	9,880	1,107	8,400	941	6,920	678	6,420	629	6,420	540			
		0.9	80	0.004	6,150	689	5,230	585	4,305	448	4,000	384	4,000	320			
			12	0.070	15,200	2,128	12,920	1,809	10,640	1,341	9,880	1,107	9,880	968			
			16	0.070	15,200	2,128	12,920	1,809	10,640	1,341	9,880	1,107	9,880	968			
			20	0.049	12,160	1,532	10,340	1,302	8,512	1,072	7,900	886	7,900	775			
			25	0.040	9,880	1,107	8,400	941	6,916	678	6,420	629	6,420	540			
			30	0.038	9,880	1,107	8,400	941	6,916	678	6,420	629	6,420	540			
			35	0.038	9,880	1,107	8,400	941	6,916	678	6,420	629	6,420	540			
		1.4	40	0.030	9,880	1,107	8,400	941	6,916	678	6,420	629	6,420	540			
			50	0.017	8,510	954	7,240	810	5,958	620	5,530	531	5,530	442			
			60	0.009	7,240	810	6,150	689	5,065	526	4,700	451	4,700	376			
			70	0.005	6,150	689	5,230	585	4,305	448	4,000	384	4,000	320			
			75	0.005	6,150	689	5,230	585	4,305	448	4,000	384	4,000	320			
			10	0.077	15,200	2,128	12,920	1,809	10,640	1,341	9,880	1,107	9,880	968			
			16	0.077	15,200	2,128	12,920	1,809	10,640	1,341	9,880	1,107	9,880	968			
		2.9	20	0.064	12,160	1,532	10,340	1,302	8,512	1,072	7,900	886	7,900	775			
			22	0.064	12,160	1,532	10,340	1,302	8,512	1,072	7,900	886	7,900	775			
			25	0.053	9,880	1,107	8,400	941	6,916	678	6,420	629	6,420	540			
			30	0.043	9,880	1,107	8,400	941	6,916	678	6,420	629	6,420	540			
			40	0.031	9,880	1,107	8,400	941	6,916	678	6,420	629	6,420	540			
			50	0.019	8,510	954	7,240	810	5,958	620	5,530	531	5,530	442			
			75	0.006	6,150	689	5,230	585	4,305	448	4,000	384	4,000	320			
		4.9	12	0.084	15,200	2,128	12,920	1,809	10,640	1,341	9,880	1,107	9,880	968			
			15	0.084	15,200	2,128	12,920	1,809	10,640	1,341	9,880	1,107	9,880	968			
			20	0.056	12,160	1,532	10,340	1,302	8,512	1,072	7,900	886	7,900	775			
			41	0.040	9,880	1,265	8,400	1,075	6,916	774	6,420	719	6,420	617			
			20	0.061	12,160	1,532	10,340	1,302	8,512	1,072	7,900	886	7,900	775			
			1.5	3	0.4	8	0.224	12,720	2,671	10,810	2,271	8,904	1,683	8,270	1,389	8,270	1,215
						16	0.154	12,720	2,671	10,810	2,271	8,904	1,683	8,270	1,389	8,270	1,215
20	0.105	12,720				2,404	10,810	2,043	8,904	1,496	8,270	1,215	8,270	1,042			
30	0.056	10,176				1,924	8,650	1,635	7,123	1,047	6,610	972	6,610	834			
40	0.051	8,270				1,389	7,030	1,181	5,788	851	5,370	790	5,370	677			
50	0.037	8,270				1,389	7,030	1,181	5,788	851	5,370	790	5,370	677			
80	0.016	6,230				994	5,300	846	4,363	609	4,050	566	4,050	485			
0.9	15	0.175			12,720	2,671	10,810	2,271	8,904	1,683	8,270	1,389	8,270	1,215			
	20	0.119			12,720	2,404	10,810	2,043	8,904	1,496	8,270	1,215	8,270	1,042			
	30	0.063			10,180	1,924	8,650	1,635	7,123	1,047	6,610	972	6,610	834			
	35	0.060			10,180	1,924	8,650	1,635	7,123	1,047	6,610	972	6,610	834			
	40	0.060			8,270	1,389	7,030	1,181	5,788	851	5,370	790	5,370	677			
	50	0.043			8,270	1,389	7,030	1,181	5,788	851	5,370	790	5,370	677			
	60	0.026			7,120	1,197	6,060	1,017	4,986	733	4,630	680	4,630	583			
1.4	70	0.020			6,230	994	5,300	846	4,363	609	4,050	566	4,050	485			
	90	0.013			6,230	994	5,300	846	4,363	609	4,050	566	4,050	485			
	30	0.070			10,180	1,924	8,650	1,635	7,123	1,047	6,610	972	6,610	834			
	40	0.064			8,270	1,389	7,030	1,181	5,788	851	5,370	790	5,370	677			
	50	0.045			8,270	1,389	7,030	1,181	5,788	851	5,370	790	5,370	677			
	66	0.022			6,230	994	5,300	846	4,363	609	4,050	566	4,050	485			
	30	0.077			10,180	1,924	8,650	1,635	7,123	1,047	6,610	972	6,610	834			
2	4	0.4			60	0.051	7,800	1,113	6,600	945	5,800	784	5,000	644	5,000	609	
					100	0.030	6,230	997	5,300	847	4,350	695	3,920	563	3,920	506	
		0.9			20	0.224	11,900	2,002	10,100	1,694	9,000	1,435	7,800	1,176	7,800	1,113	
					30	0.161	11,900	1,799	10,100	1,526	9,000	1,295	7,800	1,064	7,800	1,001	
			35	0.140	11,900	1,799	10,100	1,526	9,000	1,295	7,800	1,064	7,800	1,001			
			40	0.098	9,500	1,358	8,100	1,155	7,200	980	6,200	798	6,200	756			
			50	0.094	7,800	1,113	6,600	945	5,800	784	5,000	644	5,000	609			
			60	0.060	7,800	1,113	6,600	945	5,800	784	5,000	644	5,000	609			
			120	0.025	6,230	997	5,300	847	4,350	695	3,920	563	3,920	506			

[注意] ご使用にあたっては、A96ページの表下の項目と注意を参照してください。 **[Note]** Upon usage, please refer to comments and notes below table on page A96.

EPDBPE-ATH

高能率切削条件

High efficiency cutting condition

高精度切削条件

High accuracy cutting condition

高能率切削条件はA89ページを参照してください。
Please refer to P.A89 about high efficiency cutting conditions

被削材 Work material					1		2		3		4		5			
					炭素鋼・合金鋼 Carbon steels, Alloy steels (180~250HB)		ステンレス鋼・工具鋼 Stainless steels, Tool steels (25~35HRC)		プリハードン鋼 Pre-hardened steels (35~45HRC)		焼入れ鋼 Hardened steels (45~55HRC)		焼入れ鋼 Hardened steels (55~65HRC)			
切り込み比率 Ratio to standard depth of cut					100%		90%		80%		65%		60%			
ボール半径RE Ball radius (mm)	外径DC Tool dia. (mm)	首部テーパ(半角) BHTA2 Neck angle (°)	首下長LU Under neck length (mm)	ap (mm)	回転数 n min ⁻¹	送り速度 Vf mm/min	回転数 n min ⁻¹	送り速度 Vf mm/min	回転数 n min ⁻¹	送り速度 Vf mm/min	回転数 n min ⁻¹	送り速度 Vf mm/min	回転数 n min ⁻¹	送り速度 Vf mm/min		
2	4	1.4	45	0.102	7,800	1,113	6,600	945	5,800	784	5,000	644	5,000	609		
			80	0.051	6,230	872	5,300	741	4,350	608	3,920	493	3,920	443		
		2.9	25	0.175	11,900	1,799	10,100	1,526	9,000	1,295	7,800	1,064	7,800	1,001		
2.5	5	0.4	100	0.047	4,050	595	3,440	505	2,820	414	2,540	335	2,540	302		
			30	0.238	9,500	1,498	8,100	1,274	7,200	1,078	6,200	882	6,200	833		
		0.9	40	0.175	9,500	1,498	8,100	1,274	7,200	1,078	6,200	882	6,200	833		
			60	0.128	6,200	924	5,300	791	4,700	665	4,000	539	4,000	504		
			90	0.068	4,050	595	3,440	505	2,820	414	2,540	335	2,540	302		
		1.4	60	0.140	6,200	924	5,300	791	4,700	665	4,000	539	4,000	504		
			74	0.136	6,200	924	5,300	791	4,700	665	4,000	539	4,000	504		
			2.9	40	0.210	9,500	1,498	8,100	1,274	7,200	1,078	6,200	882	6,200	833	
3	6	0.4	120	0.051	4,200	588	3,570	500	2,930	410	2,900	365	2,900	328		
			30	0.315	8,000	1,400	6,800	1,190	6,000	1,001	5,200	819	5,200	777		
		0.9	40	0.280	8,000	1,260	6,800	1,071	6,000	896	5,200	735	5,200	693		
			45	0.259	8,000	1,260	6,800	1,071	6,000	896	5,200	735	5,200	693		
			50	0.224	8,000	1,260	6,800	1,071	6,000	896	5,200	735	5,200	693		
			60	0.154	6,400	952	5,400	805	4,800	679	4,100	546	4,100	518		
			70	0.153	5,200	777	4,400	658	3,900	553	3,400	455	3,400	427		
			80	0.119	5,200	777	4,400	658	3,900	553	3,400	455	3,400	427		
		1.4	50	0.245	8,000	1,260	6,800	1,071	6,000	896	5,200	735	5,200	693		
			96	0.145	4,620	648	3,930	550	3,220	451	2,900	365	2,900	328		
		2.9	30	0.378	8,000	1,400	6,800	1,190	6,000	1,001	5,200	819	5,200	777		
		3.5	7	0.9	45	0.259	8,000	1,260	6,800	1,071	6,000	896	5,200	735	5,200	693
				1.4	60	0.245	6,400	952	5,400	805	4,800	679	4,100	546	4,100	518
				2.9	40	0.350	8,000	1,260	6,800	1,071	6,000	896	5,200	735	5,200	693
0.4	120			0.145	3,840	564	3,260	479	2,670	392	2,400	317	2,400	285		
4	8	0.4	50	0.350	6,000	1,022	5,100	868	4,500	728	3,900	595	3,900	567		
			55	0.329	6,000	1,022	5,100	868	4,500	728	3,900	595	3,900	567		
		0.9	60	0.301	6,000	1,022	5,100	868	4,500	728	3,900	595	3,900	567		
			70	0.231	6,000	1,022	5,100	868	4,500	728	3,900	595	3,900	567		
			80	0.175	4,800	770	4,080	655	3,350	537	3,020	435	3,020	391		
			120	0.162	3,840	564	3,260	479	2,670	392	2,400	317	2,400	285		
		1.4	50	0.385	6,000	1,022	5,100	868	4,500	728	3,900	595	3,900	567		
			98	0.213	3,840	564	3,260	479	2,670	392	2,400	317	2,400	285		
		2.9	35	0.490	6,000	1,022	5,100	868	4,500	728	3,900	595	3,900	567		
		5	10	0.4	120	0.213	3,120	546	2,650	464	2,170	379	1,950	307	1,950	276
60	0.490				4,800	910	4,100	777	3,600	644	3,100	525	3,100	497		
0.9	65			0.420	4,800	910	4,100	777	3,600	644	3,100	525	3,100	497		
	75			0.350	4,800	910	4,100	777	3,600	644	3,100	525	3,100	497		
	86			0.280	3,840	700	3,260	595	2,670	487	2,400	394	2,400	354		
1.4	55			0.560	4,800	910	4,100	777	3,600	644	3,100	525	3,100	497		
	120			0.230	3,120	546	2,650	464	2,170	379	1,950	307	1,950	276		
2.9	35			0.630	5,280	1,036	4,490	881	3,680	722	3,310	584	3,310	525		
6	12	0.4	120	0.266	2,500	525	2,130	446	1,810	379	1,630	307	1,630	276		
			75	0.504	3,840	875	3,260	743	2,770	631	2,490	510	2,490	459		
		0.9	120	0.280	2,500	525	2,130	446	1,810	379	1,630	307	1,630	276		
			80	0.553	3,840	875	3,260	743	2,770	631	2,490	510	2,490	459		
		1.4	106	0.315	2,500	525	2,130	446	1,810	379	1,630	307	1,630	276		
			2.9	60	0.630	3,840	875	3,260	743	2,770	631	2,490	510	2,490	459	

※(1) 基本切込みは被削材グループ1での目安を示しています。その他のグループの場合は、上表の切込み比率を目安に調整して下さい。

※(2) リブ加工や止まり溝など、切りくずがつまりやすい切削の場合、切込み設定は基本切込みに切込み比率をかけて算出した切込み量を、さらにその80%まで小さくして使用して下さい。

※(1) Standard cutting depth is shown as the criteria for Group 1 workpieces. For other groups, adjust the cutting depth according to the cutting depth factors in the above table.

※(2) When performing cutting where cutting chips may cause clogging, such as for rib cutting, blind grooves, etc., cutting depth setting should be set by multiplying a cutting depth factor to calculate the cutting depth amount, and this amount should then be reduced to 80% of the calculated value.

【切込み設定例】 EPDBPE2020-25-09-ATHの工具で焼き入れ鋼(50HRC)をリブ溝等高線切削する場合、
切込み=0.04(基本切込み)×0.65(焼き入れ鋼グループ4の切込み比率)×0.8(閉鎖域の切削)=0.020

Cutting depth setting example: When cutting rib groove contours in pre-hardened steel (50HRC) using an EPDBP2020-25-09-TH tool:

Cutting depth = 0.04 (standard cutting depth) × 0.65 (cutting depth factor for Group 4 pre-hardened steel) × 0.8 (for closed-area cutting) = 0.020mm

- 【注意】**
- ①被削材、加工形状に合わせて、適切なクーラントを使用してください。
 - ②この標準切削条件表は切削条件の目安を示すものです。実際の加工では加工形状、目的、使用機械等により条件を調整してください。
 - ③機械の回転数が足りない場合は、回転数と送り速度を同じ比率で下げてください。

- 【Note】**
- ① Use the appropriate coolant for the work material and machining shape.
 - ② These Recommended Cutting Conditions indicate only the rule of a thumb for the cutting conditions. In actual machining, the condition should be adjusted according to the machining shape, purpose and the machine type.
 - ③ If the rpm of the machine is low, lower the feed rate also to put the rpm and feed rate in the same ratio.

Epoch Super Hard Ball Evolution

エポックスーパーハードボール エボリューション

標準規格品

Standard rating product

高硬度材加工用。THコーティング採用。50HRC以上に適しています。
For machining of high-hardness materials. Ideal for materials with hardnesses of 50HRC and higher.



+0.003~-0.007



(mm)

2枚刃
2Flutes

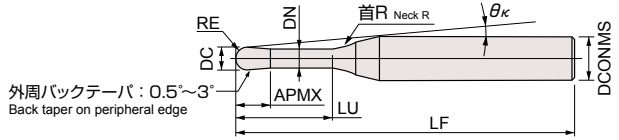

EPSBE2-TH

標準規格品
Standard rating product

RE精度公差 RE accuracy
+0.003~-0.007



商品コード Item code	在庫 Stock	ボール半径 Ball radius RE	外径 Tool dia. DC	寸法 Size (mm)						干渉角度 Interference angle (°) θ_K	勾配角に対する実有効首下長 Effective under neck length with respect to draft angle					希望小売 価格(円) Suggested retail price (¥)		
				刃長 Flute length APMX	首径 Neck dia. DN	首下長 Under neck length LU	全長L Overall length LF	シャンク径 Shank dia. DCONMS	首R Neck R		0.5°	1°	1.5°	2°	3°			
																	0.5°	1°
EPSBE2001-0.15-TH	●	0.05	0.1	0.08	0.08	0.15	45	4	1	11.82	0.30	0.32	0.33	0.35	0.38	18,110		
EPSBE2001-0.3-TH	●			0.08	0.08	0.3	45	4	1	11.64	0.46	0.48	0.50	0.52	0.57	18,110		
EPSBE2001-0.75-TH	●			0.08	0.08	0.75	45	4	1	11.12	0.93	0.97	1.01	1.04	1.10	19,070		
EPSBE2002-0.3-TH	●	0.1	0.2	0.15	0.17	0.3	45	4	1	11.66	0.49	0.50	0.52	0.54	0.58	15,650		
EPSBE2002-0.6-TH	●			0.15	0.17	0.6	45	4	1	11.30	0.80	0.83	0.86	0.88	0.93	15,650		
EPSBE2002-1-TH	●			0.15	0.17	1	45	4	1	10.86	1.22	1.26	1.30	1.33	1.39	15,650		
EPSBE2002-1.5-TH	●			0.15	0.17	1.5	45	4	1	10.35	1.74	1.79	1.84	1.88	2.05	16,290		
EPSBE2002-2-TH	●			0.15	0.17	2	45	4	1	9.88	2.25	2.32	2.37	2.45	2.71	16,290		
EPSBE2003-0.45-TH	●			0.15	0.3	0.25	0.27	0.45	45	4	2	11.53	0.73	0.77	0.80	0.84	0.91	14,790
EPSBE2003-0.9-TH	●	0.25	0.27			0.9	45	4	2	11.00	1.21	1.27	1.32	1.37	1.47	14,790		
EPSBE2003-1.5-TH	●	0.25	0.27			1.5	45	4	2	10.36	1.84	1.92	1.99	2.06	2.18	15,110		
EPSBE2003-2-TH	●	0.25	0.27			2	45	4	2	9.88	2.36	2.46	2.55	2.62	2.76	15,110		
EPSBE2003-3-TH	●	0.25	0.27			3	45	4	2	9.05	3.41	3.53	3.64	3.73	4.02	15,650		
EPSBE2004-0.6-TH	●	0.2	0.4			0.3	0.37	0.6	45	4	2	11.39	0.88	0.93	0.97	1.01	1.09	14,790
EPSBE2004-1.2-TH	●			0.3	0.37	1.2	45	4	2	10.69	1.52	1.59	1.65	1.71	1.82	14,790		
EPSBE2004-2-TH	●			0.3	0.37	2	45	4	2	9.88	2.36	2.46	2.54	2.62	2.75	14,790		
EPSBE2004-3-TH	●			0.3	0.37	3	45	4	2	9.03	3.41	3.53	3.63	3.73	4.01	15,110		
EPSBE2004-3.5-TH	●			0.3	0.37	3.5	45	4	2	8.65	3.93	4.06	4.18	4.27	4.67	15,110		
EPSBE2004-4-TH	●			0.3	0.37	4	45	4	2	8.30	4.45	4.59	4.71	4.83	5.33	15,650		
EPSBE2005-0.75-TH	●	0.25	0.5	0.35	0.47	0.75	45	4	2	11.25	1.04	1.09	1.13	1.18	1.27	14,040		
EPSBE2005-1.5-TH	●			0.35	0.47	1.5	45	4	2	10.39	1.83	1.91	1.98	2.05	2.17	14,040		
EPSBE2005-3-TH	●			0.35	0.47	3	45	4	2	9.00	3.41	3.53	3.63	3.72	3.99	14,790		
EPSBE2005-5-TH	●			0.35	0.47	5	45	4	2	7.64	5.48	5.65	5.78	6.01	6.65	15,000		
EPSBE2006-0.9-TH	●	0.3	0.6	0.4	0.57	0.9	45	4	4	11.10	1.33	1.42	1.51	1.59	1.75	14,040		
EPSBE2006-1.8-TH	●			0.4	0.57	1.8	45	4	4	10.08	2.30	2.44	2.56	2.68	2.88	14,040		
EPSBE2006-3-TH	●			0.4	0.57	3	45	4	4	8.98	3.58	3.77	3.93	4.07	4.32	14,790		
EPSBE2006-5-TH	●			0.4	0.57	5	45	4	4	7.59	5.70	5.94	6.14	6.32	6.63	15,110		
EPSBE2006-6-TH	●			0.4	0.57	6	45	4	4	7.04	6.75	7.02	7.23	7.42	7.96	15,110		
EPSBE2008-1.2-TH	●			0.4	0.8	0.5	0.77	1.2	45	4	4	10.79	1.65	1.75	1.84	1.93	2.11	13,290
EPSBE2008-2.4-TH	●	0.5	0.77			2.4	45	4	4	9.47	2.94	3.10	3.24	3.36	3.59	13,290		
EPSBE2010-1.5-TH	●	0.5	1	0.8	0.96	1.5	45	6	4	11.01	2.01	2.12	2.21	2.31	2.49	12,440		
EPSBE2010-3-TH	●			0.8	0.96	3	45	6	4	9.88	3.61	3.78	3.93	4.06	4.30	12,440		
EPSBE2010-6-TH	●			0.8	0.96	6	45	6	4	8.20	6.76	7.02	7.23	7.42	7.92	12,860		
EPSBE2010-8-TH	●			0.8	0.96	8	45	6	4	7.36	8.85	9.15	9.40	9.61	10.58	13,390		
EPSBE2010-10-TH	●	0.6	1.2	0.8	0.96	10	50	6	4	6.68	10.93	11.27	11.54	11.98	13.23	13,820		
EPSBE2012-1.8-TH	●			1.1	1.15	1.8	45	6	4	10.78	2.36	2.47	2.58	2.68	2.86	12,440		
EPSBE2012-3.6-TH	●			1.1	1.15	3.6	45	6	4	9.46	4.27	4.45	4.61	4.75	5.01	12,440		
EPSBE2015-2.25-TH	●			0.75	1.5	1.35	1.44	2.25	45	6	4	10.43	2.87	2.99	3.10	3.20	3.40	13,080
EPSBE2015-4.5-TH	●					1.35	1.44	4.5	45	6	4	8.84	5.24	5.43	5.61	5.76	6.03	13,080
EPSBE2015-8-TH	●					1.35	1.44	8	45	6	4	7.14	8.89	9.17	9.41	9.61	10.56	14,040
EPSBE2015-12-TH	●	1.35	1.44			12	50	6	4	5.85	13.03	13.39	13.74	14.38	15.87	14,580		
EPSBE2020-3-TH	●	1	2	1.7	1.92	3	45	6	4	9.79	3.71	3.84	3.96	4.07	4.29	13,080		
EPSBE2020-6-TH	●			1.7	1.92	6	45	6	4	7.81	6.84	7.07	7.26	7.43	7.89	13,080		
EPSBE2020-8-TH	●			1.7	1.92	8	45	6	4	6.88	8.92	9.19	9.42	9.61	10.54	14,040		
EPSBE2020-12-TH	●			1.7	1.92	12	50	6	4	5.55	13.06	13.41	13.76	14.39	15.85	14,580		
EPSBE2020-16-TH	●			1.7	1.92	16	50	6	4	4.65	17.19	17.59	18.32	19.17	21.16	14,890		
EPSBE2020-20-TH	●			1.7	1.92	20	55	6	4	4.01	21.30	21.90	22.88	23.96	26.47	15,000		

●印：標準在庫品です。 ●印：Stocked Items.

Epoch Super Hard Ball Evolution

エポックスーパーハードボール エボリューション

高精度規格品 High-accuracy rating product



RE公差 RE tolerance +0.001~-0.005 h4 I (mm)

高硬度材加工用。THコーティング採用。50HRC以上に適しています。高精度規格品。

For machining of high-hardness materials. Ideal for materials with hardnesses of 50HRC and higher. High-accuracy rating product.

2枚刃
2Flutes

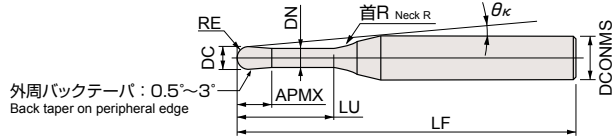

切削条件表 A99 Cutting Conditions

EPSBE2000-0.15-H-TH

高精度規格品 High-accuracy rating product RE精度公差 RE accuracy +0.001~-0.005

検査票付き Inspection certificate included

超硬 RTH 傾斜30° Carbide Helix angle

商品コード Item code	在庫 Stock	寸法 Size (mm)								干渉角度 Interference angle (°) θκ	勾配角に対する実有効首下長 Effective under neck length with respect to draft angle					希望小売価格 (円) Suggested retail price (¥)
		ボール半径 Ball radius RE	外径 Tool dia. DC	刃長 Flute length APMX	首径 Neck dia. DN	首下長 Under neck length LU	全長L Overall length LF	シャンク径 Shank dia. DCONMS	首R Neck R		0.5°	1°	1.5°	2°	3°	
											0.5°	1°	1.5°	2°	3°	
EPSBE2001-0.15-H-TH	●	0.05	0.1	0.08	0.08	0.15	45	4	1	11.82	0.30	0.32	0.33	0.35	0.38	21,000
EPSBE2002-0.3-H-TH	●	0.1	0.2	0.15	0.17	0.3	45	4	1	11.66	0.49	0.50	0.52	0.54	0.58	18,330
EPSBE2003-0.45-H-TH	●	0.15	0.3	0.25	0.27	0.45	45	4	2	11.53	0.73	0.77	0.80	0.84	0.91	17,360
EPSBE2004-0.6-H-TH	●	0.2	0.4	0.3	0.37	0.6	45	4	2	11.39	0.88	0.93	0.97	1.01	1.09	17,360
EPSBE2005-0.75-H-TH	●	0.25	0.5	0.35	0.47	0.75	45	4	2	11.25	1.04	1.09	1.13	1.18	1.27	16,610
EPSBE2006-0.9-H-TH	●	0.3	0.6	0.4	0.57	0.9	45	4	4	11.10	1.33	1.42	1.51	1.59	1.75	16,610
EPSBE2008-1.2-H-TH	●	0.4	0.8	0.5	0.77	1.2	45	4	4	10.79	1.65	1.75	1.84	1.93	2.11	15,750
EPSBE2010-1.5-H-TH	●	0.5	1	0.8	0.96	1.5	45	6	4	11.01	2.01	2.12	2.21	2.31	2.49	14,790
EPSBE2012-1.8-H-TH	●	0.6	1.2	1.1	1.15	1.8	45	6	4	10.78	2.36	2.47	2.58	2.68	2.86	14,790
EPSBE2015-2.25-H-TH	●	0.75	1.5	1.35	1.44	2.25	45	6	4	10.43	2.87	2.99	3.10	3.20	3.40	15,530
EPSBE2020-3-H-TH	●	1	2	1.7	1.92	3	45	6	4	9.79	3.71	3.84	3.96	4.07	4.29	15,530

首下詳細形状

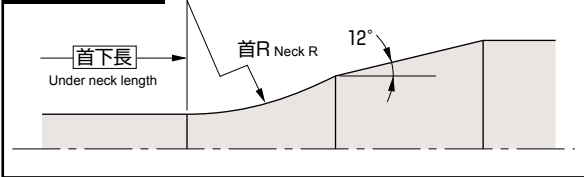

【注意】

加工物に勾配がついている場合、干渉領域は、首下長さよりも長くなります。それぞれの勾配角に対する実有効首下長をご参照ください。また、工具が加工物に干渉する角度を干渉角度θκで表示していますので合わせてご参照ください。

【Note】

If the workpiece has draft angle, the interference length will be longer than the under-neck length. Please refer to the effective under-neck length for the various draft angles. In addition, the angle at which the tool will interfere with the workpiece is shown as the "interference angle θκ", and should also be referred to.

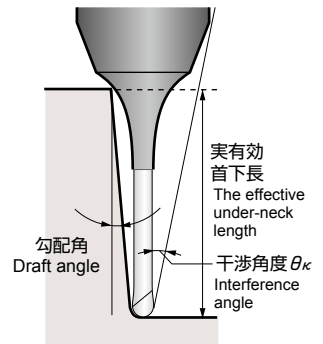

○ 対応被削材 Applicable work material

炭素鋼 合金鋼 Carbon steel Alloy steel	プリハードン鋼 Pre-hardened steel ≤ 45HRC	高硬度 Hardened steel			ステンレス鋼 Stainless steel	チタン合金 耐熱合金 Titanium alloy Heat-resistant alloy	銅合金 Copper alloy	アルミ合金 Aluminum alloy
		> 45HRC ≤ 55HRC	> 55HRC ≤ 65HRC	> 65HRC				
○	○	○	○	○	○	○	○	

○ 再研磨対応外径範囲 Re-grinding compatibility range

商品コード Item code	外周 Outer dia. (mm)	エンド End (mm)
EPSBE-TH	× (N/A)	× (N/A)
EPSBE-H-TH	× (N/A)	× (N/A)

標準切削条件表 Recommended cutting conditions

EPSBE-TH 標準規格品 Standard rating product
EPSBE-H-TH 高精度規格品 High accuracy rating product

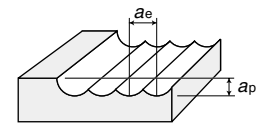

被削材 Work material					1		2		3		4		5		
					プリハードン鋼 Pre-hardened steels (35~45HRC)		焼入れ鋼 Hardened steels (45~55HRC)		焼入れ鋼 Hardened steels (55~65HRC)		焼入れ鋼 Hardened steels (65~68HRC)		焼入れ鋼 Hardened steels (68~72HRC)		
切り込み比率 Ratio to standard depth of cut					100%		85%		80%		65%		55%		
ボール半径RE Ball radius (mm)	外径DC Tool dia. (mm)	首下長LU Under neck length (mm)	基本切り込み量 Standard depth of cut		回転数 n min ⁻¹	送り速度 Vf mm/min	回転数 n min ⁻¹	送り速度 Vf mm/min	回転数 n min ⁻¹	送り速度 Vf mm/min	回転数 n min ⁻¹	送り速度 Vf mm/min	回転数 n min ⁻¹	送り速度 Vf mm/min	
			ap (mm)	ae (mm)											
0.05	0.1		0.15	0.006	0.018	59,500	360	54,100	320	51,400	280	46,000	250	43,300	190
			0.3	0.005	0.015	59,500	360	50,000	320	51,400	280	46,000	250	43,300	190
			0.75	0.003	0.009	35,700	210	32,500	200	30,800	170	27,600	150	26,000	120
0.1	0.2		0.3	0.016	0.048	55,400	660	50,400	600	47,900	520	42,800	460	40,300	360
			0.6	0.014	0.042	55,400	660	50,400	600	47,900	520	42,800	460	40,300	360
			1	0.012	0.036	41,600	500	37,800	450	35,900	390	32,100	350	30,200	270
			1.5	0.007	0.021	33,300	400	30,200	360	28,700	310	25,700	280	24,200	220
			2	0.006	0.018	33,300	350	30,200	310	28,700	270	25,700	240	24,200	190
0.15	0.3		0.45	0.017	0.051	50,600	910	46,000	830	43,700	710	39,100	630	36,800	500
			0.9	0.017	0.051	50,600	910	46,000	830	43,700	710	39,100	630	36,800	500
			1.5	0.013	0.039	37,900	610	34,500	560	32,800	480	29,300	430	27,600	340
			2	0.01	0.03	30,300	470	27,600	430	26,200	370	23,400	330	22,100	260
			3	0.007	0.021	30,300	440	27,600	400	26,200	340	23,400	300	22,100	240
0.2	0.4		0.6	0.035	0.105	43,800	1,050	39,800	960	37,800	820	33,800	730	31,800	570
			1.2	0.032	0.096	43,800	1,050	39,800	960	37,800	820	33,800	730	31,800	570
			2	0.022	0.066	35,000	840	31,800	760	30,200	650	27,100	590	25,500	460
			3	0.013	0.039	28,000	630	25,500	570	24,200	490	21,600	440	20,400	340
			3.5	0.01	0.03	28,000	630	25,500	570	24,200	490	21,600	440	20,400	340
			4	0.008	0.024	28,000	540	25,500	490	24,200	420	21,600	370	20,400	290
0.25	0.5		0.75	0.036	0.108	37,300	1,190	34,000	1,090	32,300	930	28,900	830	27,200	650
			1.5	0.036	0.108	37,300	1,190	34,000	1,090	32,300	930	28,900	830	27,200	650
			3	0.024	0.072	28,000	840	25,500	770	24,200	650	21,600	580	20,400	460
			5	0.016	0.048	23,100	650	21,000	590	20,000	500	17,900	450	16,800	350
0.3	0.6		0.9	0.04	0.12	35,000	1,430	31,800	1,300	30,200	1,110	27,100	1,000	25,500	780
			1.8	0.036	0.108	35,000	1,430	31,800	1,300	30,200	1,110	27,100	1,000	25,500	780
			3	0.028	0.084	27,000	1,100	24,500	1,000	23,300	860	20,900	770	19,600	600
			5	0.018	0.054	22,200	910	20,200	820	19,200	710	17,100	630	16,100	490
			6	0.013	0.039	22,200	830	20,200	750	19,200	640	17,100	570	16,100	450
0.4	0.8		1.2	0.065	0.195	29,200	1,680	26,500	1,530	25,200	1,310	22,500	1,170	21,200	920
			2.4	0.065	0.195	29,200	1,680	26,500	1,530	25,200	1,310	22,500	1,170	21,200	920
0.5	1		1.5	0.08	0.24	28,600	2,060	26,000	1,870	24,700	1,600	22,100	1,430	20,800	1,120
			3	0.08	0.24	28,600	2,060	26,000	1,870	24,700	1,600	22,100	1,430	20,800	1,120
			6	0.035	0.105	22,300	1,610	20,300	1,460	19,300	1,250	17,200	1,110	16,200	870
			8	0.035	0.105	19,300	1,350	17,500	1,230	16,600	1,050	14,900	940	14,000	740
			10	0.022	0.066	19,300	1,270	17,500	1,160	16,600	990	14,900	890	14,000	690
0.6	1.2		1.8	0.08	0.24	25,300	2,190	23,000	1,990	21,800	1,700	19,500	1,520	18,400	1,190
			3.6	0.08	0.24	25,300	2,190	23,000	1,990	21,800	1,700	19,500	1,520	18,400	1,190
0.75	1.5		2.25	0.085	0.255	21,400	2,310	19,500	2,110	18,500	1,800	16,500	1,600	15,600	1,260
			4.5	0.08	0.24	21,400	2,310	19,500	2,110	18,500	1,800	16,500	1,600	15,600	1,260
			8	0.05	0.15	18,300	1,870	16,700	1,700	15,800	1,450	14,200	1,300	13,300	1,020
			12	0.05	0.15	16,600	1,590	15,100	1,450	14,400	1,240	12,900	1,110	12,100	870
1	2		3	0.16	0.48	18,400	2,650	16,700	2,400	15,900	2,060	14,200	1,840	13,400	1,450
			6	0.16	0.48	18,400	2,650	16,700	2,400	15,900	2,060	14,200	1,840	13,400	1,450
			8	0.13	0.39	18,400	2,650	16,700	2,400	15,900	2,060	14,200	1,840	13,400	1,450
			12	0.07	0.21	15,300	1,960	13,900	1,780	13,200	1,520	11,800	1,360	11,100	1,070
			16	0.07	0.21	14,600	1,750	13,300	1,600	12,600	1,360	11,300	1,220	10,600	950
			20	0.045	0.135	13,500	1,620	12,300	1,480	11,600	1,250	10,400	1,120	9,800	880

※基本切り込みは被削材グループ1での目安を示しています。その他のグループの場合は、上表の切り込み比率を目安に調整してください。

※Standard cutting depth is shown as the criteria for Group 1 workpieces. For other groups, adjust the cutting depth according to the cutting depth factors in the above table.

[注意] ①被削材、加工形状に合わせて、適切なクーラントを使用してください。

②この標準切削条件表は切削条件の目安を示すものです。実際の加工では加工形状、目的、使用機械等により条件を調整してください。

[Note] ①Use the appropriate coolant for the work material and machining shape.

②These Recommended Cutting Conditions indicate only the rule of a thumb for the cutting conditions. In actual machining, the condition should be adjusted according to the machining shape, purpose and the machine type.

エポックTHハードボール ストロング

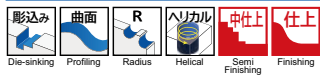

高硬度材加工用。THコーティング採用。50HRC以上に適しています。
For machining of high-hardness materials. Ideal for materials with hardnesses of 50HRC and higher.



±0.005



(mm)

2枚刃
2Flutes



Aタイプ
A type

Bタイプ
B type

※首ぬすみ無し Without neck escape

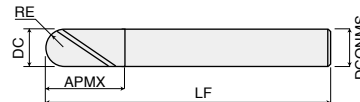
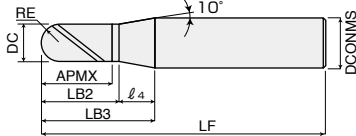

EPBTS2000-TH



商品コード Item code	在庫 Stock	寸法 Size (mm)							全長 Overall length	シャンク径 Shank dia.	形状 Shape	希望小売価格 (円) Suggested retail price (¥)
		ボール半径 Ball radius	外径 Tool dia.	刃長 Flute length	首下長 Under neck length							
		RE	DC	APMX	LB2	LB3	l ₄	LF	DCONMS			
EPBTS2030-TH	●	1.5	3	4.5	5.5	14.0	8.5	70	6	A	13,820	
EPBTS2040-TH	●	2	4	6	7.0	12.7	5.7	70	6	A	13,820	
EPBTS2050-TH	●	2.5	5	7.5	8.5	11.3	2.8	80	6	A	15,600	
EPBTS2060-TH	●	3	6	9	-	-	-	90	6	B	16,500	
EPBTS2080-TH	●	4	8	12	-	-	-	100	8	B	21,550	
EPBTS2100-TH	●	5	10	15	-	-	-	100	10	B	27,490	
EPBTS2120-TH	●	6	12	18	-	-	-	110	12	B	35,690	

○ 対応被削材 Applicable work material

炭素鋼 合金鋼 Carbon steel Alloy steel	プリハー ド鋼 Pre-hardened steel	高硬度 Hardened steel			ステン レス鋼 Stainless steel	チタン合金 耐熱合金 Titanium alloy Heat-resistant alloy	銅合金 Copper alloy	アルミ 合金 Aluminum alloy
		> 45HRC ≤ 55HRC	> 55HRC ≤ 65HRC	> 65HRC				
○	○	○	○	○	○	○	○	

○ 再研磨対応外径範囲 Re-grinding compatibility range

商品コード Item code	外周 Outer dia. (mm)	エンド End (mm)
EPBTS-TH	× (N/A)	3 ~ 12

○ : 標準在庫品です。 ● : Stocked items.

標準切削条件表 Recommended cutting conditions

EPBTS-TH

〈荒切削〉 Roughing

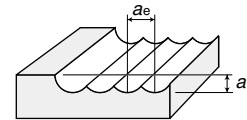

被削材 Work material	プリハードン鋼 Pre-hardened steels (35~45HRC) CENA1, NAK80		焼入れ鋼 Hardened steels (45~55HRC) SKD61, SKT4		焼入れ鋼 Hardened steels (55~65HRC) SKD11, SKH51		焼入れ鋼 Hardened steels (65~72HRC) SKH, HAP		
	切込み Depth of cut (mm)	$a_p=0.12DC$ $a_e=0.36DC$		$a_p=0.1DC$ $a_e=0.3DC$		$a_p=0.06DC$ $a_e=0.18DC$		$a_p=0.05DC$ $a_e=0.15DC$	
高速切削 High speed	ボール半径RE×外径DC RE×Tool dia.(mm)	回転数n (min ⁻¹)	送り速度vf (mm/min)	回転数n (min ⁻¹)	送り速度vf (mm/min)	回転数n (min ⁻¹)	送り速度vf (mm/min)	回転数n (min ⁻¹)	送り速度vf (mm/min)
	RE1.5×3	37,700	3,620	27,500	2,810	22,400	2,280	13,200	1,110
	RE2×4	28,300	3,620	20,600	2,800	16,800	2,280	9,900	1,110
	RE2.5×5	22,800	3,650	16,700	2,840	13,600	2,310	8,000	1,120
	RE3×6	19,200	3,690	14,000	2,860	11,400	2,330	6,800	1,140
	RE4×8	14,700	3,760	10,700	2,910	8,800	2,390	5,200	1,160
	RE5×10	11,800	3,780	8,600	2,920	7,000	2,380	4,100	1,150
RE6×12	9,800	3,650	7,200	2,850	5,800	2,300	3,400	1,110	
汎用切削 General	切込み Depth of cut (mm)	$a_p=0.12DC$ $a_e=0.36DC$		$a_p=0.1DC$ $a_e=0.3DC$		$a_p=0.08DC$ $a_e=0.24DC$		$a_p=0.07DC$ $a_e=0.21DC$	
	ボール半径RE×外径DC RE×Tool dia.(mm)	回転数n (min ⁻¹)	送り速度vf (mm/min)	回転数n (min ⁻¹)	送り速度vf (mm/min)	回転数n (min ⁻¹)	送り速度vf (mm/min)	回転数n (min ⁻¹)	送り速度vf (mm/min)
	RE1.5×3	17,300	1,560	14,300	1,030	12,200	730	7,100	340
	RE2×4	13,000	1,560	10,700	1,030	9,200	740	5,300	340
	RE2.5×5	10,500	1,580	8,600	1,030	7,400	740	4,300	340
	RE3×6	8,800	1,580	7,300	1,050	6,200	740	3,600	350
	RE4×8	6,800	1,630	5,600	1,080	4,800	770	2,800	360
RE5×10	5,400	1,620	4,500	1,080	3,800	760	2,200	350	
RE6×12	4,500	1,570	3,700	1,030	3,200	740	1,900	350	

〈仕上げ切削〉 Finishing

a_p : 仕上げ代 Finishing cut amount
 a_e : ピックフィード Pick feed

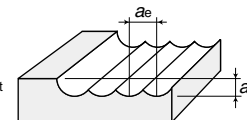

被削材 Work material	プリハードン鋼 Pre-hardened steels (35~45HRC) CENA1, NAK80		焼入れ鋼 Hardened steels (45~55HRC) SKD61, SKT4		焼入れ鋼 Hardened steels (55~65HRC) SKD11, SKH51		焼入れ鋼 Hardened steels (65~72HRC) SKH, HAP		
	切込み Depth of cut (mm)	$a_p=0.05\sim0.1$ $a_e=0.02DC$		$a_p=0.05\sim0.1$ $a_e=0.02DC$		$a_p=0.05\sim0.1$ $a_e=0.02DC$		$a_p=0.05\sim0.1$ $a_e=0.02DC$	
高速切削 High speed	ボール半径RE×外径DC RE×Tool dia.(mm)	回転数n (min ⁻¹)	送り速度vf (mm/min)	回転数n (min ⁻¹)	送り速度vf (mm/min)	回転数n (min ⁻¹)	送り速度vf (mm/min)	回転数n (min ⁻¹)	送り速度vf (mm/min)
	RE1.5×3	27,500	3,890	26,400	3,200	23,100	2,800	17,600	2,130
	RE2×4	24,200	4,150	22,000	3,550	17,600	2,660	13,200	2,000
	RE2.5×5	20,900	4,020	18,150	3,310	14,850	2,550	11,000	1,910
	RE3×6	17,600	3,910	14,300	3,030	12,100	2,440	8,800	1,780
	RE4×8	13,200	3,200	11,000	2,550	8,800	1,680	6,600	1,470
	RE5×10	11,000	2,890	8,800	2,220	7,040	1,640	5,280	1,280
RE6×12	8,800	2,400	7,260	1,910	5,830	1,490	4,400	1,110	
汎用切削 General	切込み Depth of cut (mm)	$a_p=0.05\sim0.1$ $a_e=0.02DC$		$a_p=0.05\sim0.1$ $a_e=0.02DC$		$a_p=0.05\sim0.1$ $a_e=0.02DC$		$a_p=0.05\sim0.1$ $a_e=0.02DC$	
	ボール半径RE×外径DC RE×Tool dia.(mm)	回転数n (min ⁻¹)	送り速度vf (mm/min)	回転数n (min ⁻¹)	送り速度vf (mm/min)	回転数n (min ⁻¹)	送り速度vf (mm/min)	回転数n (min ⁻¹)	送り速度vf (mm/min)
	RE1.5×3	17,000	2,620	15,400	1,850	14,300	1,720	11,000	1,320
	RE2×4	13,000	2,430	11,000	1,760	10,560	1,580	7,920	1,190
	RE2.5×5	10,500	2,260	9,130	1,670	7,040	1,440	6,490	1,100
	RE3×6	8,500	2,060	7,590	1,600	5,280	1,410	5,280	1,060
	RE4×8	6,400	1,690	5,720	1,320	4,180	1,170	3,960	870
RE5×10	5,100	1,460	4,510	1,130	3,520	1,000	3,190	770	
RE6×12	4,200	1,240	3,850	1,000	2,640	880	2,640	660	

【注意】 ①被削材、加工形状に合わせて、適切なクーラントを使用してください。
②この標準切削条件表は切削条件の目安を示すものです。実際の加工では加工形状、目的、使用機械等により条件を調整してください。

【Note】 ①Use the appropriate coolant for the work material and machining shape.
②These Recommended Cutting Conditions indicate only the rule of a thumb for the cutting conditions. In actual machining, the condition should be adjusted according to the machining shape, purpose and the machine type.

Epoch TH Hard Ball エポックTHハードボール

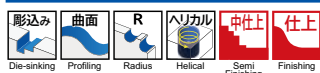

高硬度材用 (40HRC以上の被削材に適しています)。
For high-hardness materials (Ideal for materials with hardnesses of 40HRC or higher)



RE公差
RE0.5~RE6: ±0.005
RE8~RE10: ±0.01



(mm)

2枚刃
2Flutes



Aタイプ

A type

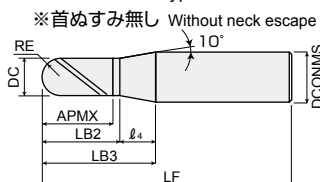

Bタイプ

B type

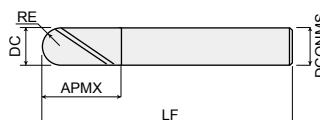

EPBT2○○○(-○)



商品コード Item code	在庫 Stock	寸法 Size(mm)								形状 Type	希望小売 価格(円) Suggested retail price(¥)
		ボール半径 Ball radius	外径 Tool dia.	刃長 Flute length				全長 Overall length	シャンク径 Shank dia.		
		RE	DC	APMX	LB2	LB3	ℓ ₄	LF	DCONMS		
EPBT2010	●	0.5	1	1.5	2.5	11	8.5	50	4	A	12,440
EPBT2015	●	0.75	1.5	2.5	3.5	10.6	7.1	50	4	A	13,080
EPBT2020	●	1	2	3	4	15.3	11.3	50	6	A	13,080
EPBT2025	●	1.25	2.5	4	5	14.9	9.9	50	6	A	13,820
EPBT2030	●	1.5	3	4.5	5.5	14	8.5	70	6	A	13,820
EPBT2040-4	●	2	4	6	-	-	-	70	4	B	13,820
EPBT2040	●	2	4	6	7	12.7	5.7	70	6	A	13,820
EPBT2050	●	2.5	5	7.5	8.5	11.3	2.8	80	6	A	15,600
EPBT2060	●	3	6	9	-	-	-	90	6	B	16,500
EPBT2080	●	4	8	12	-	-	-	100	8	B	21,550
EPBT2100	●	5	10	15	-	-	-	100	10	B	27,490
EPBT2120	●	6	12	18	-	-	-	110	12	B	35,690
EPBT2160	●	8	16	24	-	-	-	140	16	B	79,770
EPBT2200	●	10	20	30	-	-	-	160	20	B	124,340

○ 対応被削材 Applicable work material

炭素鋼 合金鋼 Carbon steel Alloy steel	プリハー ド鋼 Pre-hardened steel	高硬度 Hardened steel			ステン レス鋼 Stainless steel	チタン合金 耐熱合金 Titanium alloy Heat-resistant alloy	銅合金 Copper alloy	アルミ 合金 Aluminum alloy
		> 45HRC ≤ 45HRC	> 55HRC ≤ 55HRC	> 65HRC ≤ 65HRC				
○	○	○	○	○	○	○	○	

○ 再研磨対応外径範囲 Re-grinding compatibility range

商品コード Item code	外周 Outer dia. (mm)	エンド End (mm)
EPBT-TH	× (N/A)	1 ~ 20

○ : 標準在庫品です。 ● : Stocked items.

標準切削条件表 Recommended cutting conditions

EPBT

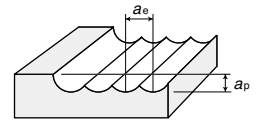

<荒加工> Roughing

被削材 Work material	工具鋼 Tool steels (25~35HRC) SKD				プリハードン鋼 Pre-hardened steels (35~45HRC) CENA1, NAK80				焼入れ鋼 Hardened steels (45~55HRC) SKD61, SKT4				焼入れ鋼 Hardened steels (55~65HRC) SKD11, SKH51				焼入れ鋼 Hardened steels (65~70HRC) SKH, HAP			
	高速条件 High speed		汎用条件 General		高速条件 High speed		汎用条件 General		高速条件 High speed		汎用条件 General		高速条件 High speed		汎用条件 General		高速条件 High speed		汎用条件 General	
切込み Depth of cut (mm)	$a_p=0.1DC$ $a_e=0.3DC$		$a_p=0.1DC$ $a_e=0.3DC$		$a_p=0.1DC$ $a_e=0.3DC$		$a_p=0.1DC$ $a_e=0.3DC$		$a_p=0.08DC$ $a_e=0.24DC$		$a_p=0.1DC$ $a_e=0.3DC$		$a_p=0.05DC$ $a_e=0.15DC$		$a_p=0.07DC$ $a_e=0.21DC$		$a_p=0.05DC$ $a_e=0.15DC$		$a_p=0.07DC$ $a_e=0.21DC$	
ボール半径RE ×外径DC Tool dia.(mm)	回転数 n (min^{-1})	送り速度 V_f (mm/min)	回転数 n (min^{-1})	送り速度 V_f (mm/min)	回転数 n (min^{-1})	送り速度 V_f (mm/min)	回転数 n (min^{-1})	送り速度 V_f (mm/min)	回転数 n (min^{-1})	送り速度 V_f (mm/min)	回転数 n (min^{-1})	送り速度 V_f (mm/min)	回転数 n (min^{-1})	送り速度 V_f (mm/min)	回転数 n (min^{-1})	送り速度 V_f (mm/min)	回転数 n (min^{-1})	送り速度 V_f (mm/min)	回転数 n (min^{-1})	送り速度 V_f (mm/min)
RE0.5×1	50,000	1,800	20,000	720	50,000	1,600	20,000	640	50,000	1,500	20,000	540	50,000	1,300	20,000	470	38,000	990	16,000	370
RE1×2	48,000	3,170	20,000	1,320	48,000	2,780	20,000	1,160	38,000	1,980	16,000	750	29,000	1,390	13,000	560	19,000	910	8,000	350
RE1.5×3	32,000	3,260	16,000	1,630	32,000	2,880	16,000	1,440	25,000	2,100	11,000	830	19,000	1,440	8,500	580	13,000	990	5,300	360
RE2×4	24,000	3,360	12,000	1,680	24,000	2,930	12,000	1,460	19,000	2,170	8,000	820	14,000	1,460	6,400	600	10,000	1,040	4,000	370
RE3×6	16,000	3,360	8,000	1,680	16,000	2,940	8,000	1,470	13,000	2,240	5,300	820	9,600	1,500	4,200	590	6,400	1,000	2,700	380
RE4×8	12,000	3,600	6,000	1,800	12,000	3,020	6,000	1,510	10,000	2,320	4,000	840	7,200	1,510	3,200	600	4,800	1,010	2,000	380
RE5×10	10,000	3,600	4,800	1,730	10,000	3,120	4,800	1,500	7,600	2,170	3,200	820	5,700	1,480	2,500	590	3,800	990	1,600	370
RE6×12	8,000	3,100	4,000	1,550	8,000	2,690	4,000	1,340	6,400	1,970	2,700	750	4,800	1,340	2,100	530	3,200	900	1,300	330
RE8×16	6,000	2,580	3,000	1,290	6,000	2,220	3,000	1,110	4,800	1,630	2,000	610	3,600	1,110	1,600	440	2,400	740	1,000	280
RE10×20	4,800	2,060	2,400	1,030	4,800	1,780	2,400	890	3,800	1,290	1,600	490	2,900	890	1,300	360	1,900	590	800	220

<仕上げ加工> Finishing

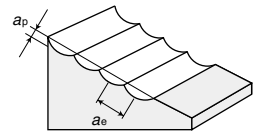

被削材 Work material	工具鋼 Tool steels (25~35HRC) SKD				プリハードン鋼 Pre-hardened steels (35~45HRC) CENA1, NAK80				焼入れ鋼 Hardened steels (45~55HRC) SKD61, SKT4				焼入れ鋼 Hardened steels (55~65HRC) SKD11, SKH51				焼入れ鋼 Hardened steels (65~70HRC) SKH, HAP			
	高速条件 High speed		汎用条件 General		高速条件 High speed		汎用条件 General		高速条件 High speed		汎用条件 General		高速条件 High speed		汎用条件 General		高速条件 High speed		汎用条件 General	
切込み Depth of cut (mm)	$a_p=0.05\sim0.1$ $a_e=0.02DC$		$a_p=0.05\sim0.1$ $a_e=0.02DC$		$a_p=0.05\sim0.1$ $a_e=0.02DC$		$a_p=0.05\sim0.1$ $a_e=0.02DC$		$a_p=0.05\sim0.1$ $a_e=0.02DC$		$a_p=0.05\sim0.1$ $a_e=0.02DC$		$a_p=0.05\sim0.1$ $a_e=0.02DC$		$a_p=0.05\sim0.1$ $a_e=0.02DC$		$a_p=0.05\sim0.1$ $a_e=0.02DC$		$a_p=0.05\sim0.1$ $a_e=0.02DC$	
ボール半径RE ×外径DC Tool dia.(mm)	回転数 n (min^{-1})	送り速度 V_f (mm/min)	回転数 n (min^{-1})	送り速度 V_f (mm/min)	回転数 n (min^{-1})	送り速度 V_f (mm/min)	回転数 n (min^{-1})	送り速度 V_f (mm/min)	回転数 n (min^{-1})	送り速度 V_f (mm/min)	回転数 n (min^{-1})	送り速度 V_f (mm/min)	回転数 n (min^{-1})	送り速度 V_f (mm/min)	回転数 n (min^{-1})	送り速度 V_f (mm/min)	回転数 n (min^{-1})	送り速度 V_f (mm/min)	回転数 n (min^{-1})	送り速度 V_f (mm/min)
RE0.5×1	50,000	5,000	20,000	2,000	50,000	5,000	20,000	2,000	50,000	4,000	20,000	1,600	50,000	2,500	15,000	750	48,000	2,400	15,000	750
RE1×2	32,000	3,840	20,000	2,400	32,000	3,840	20,000	2,400	32,000	3,200	20,000	2,000	32,000	2,880	15,000	1,350	24,000	2,160	14,000	1,260
RE1.5×3	25,000	3,500	17,000	2,380	25,000	3,500	17,000	2,380	24,000	2,880	14,000	1,680	21,000	2,520	13,000	1,560	16,000	1,920	10,000	1,200
RE2×4	22,000	3,740	13,000	2,210	22,000	3,740	13,000	2,210	20,000	3,200	10,000	1,600	16,000	2,400	9,600	1,440	12,000	1,800	7,200	1,080
RE3×6	16,000	3,520	8,500	1,870	16,000	3,520	8,500	1,870	13,000	2,730	6,900	1,450	11,000	2,200	6,400	1,280	8,000	1,600	4,800	960
RE4×8	12,000	2,880	6,400	1,540	12,000	2,880	6,400	1,540	10,000	2,300	5,200	1,200	8,000	1,760	4,800	1,060	6,000	1,320	3,600	790
RE5×10	10,000	2,600	5,100	1,330	10,000	2,600	5,100	1,330	8,000	2,000	4,100	1,030	6,400	1,540	3,800	910	4,800	1,150	2,900	700
RE6×12	8,000	2,160	4,200	1,130	8,000	2,160	4,200	1,130	6,600	1,720	3,500	910	5,300	1,330	3,200	800	4,000	1,000	2,400	600
RE8×16	6,000	1,680	3,200	900	6,000	1,680	3,200	900	5,000	1,350	2,600	700	4,000	1,040	2,400	620	3,000	780	1,800	470
RE10×20	4,800	1,340	2,500	700	4,800	1,340	2,500	700	4,000	1,080	2,100	570	3,200	830	1,900	490	2,400	620	1,400	360

- [注意]**
- ①できるだけ高剛性、高精度の機械をご使用ください。
 - ②上表の a_e (ピックフィード)は目安です。実際にはA131頁のカスプハイトを参考に選定してください。
 - ③被削材、加工形状に合わせて、適切なクーラントを使用してください。
 - ④この切削条件表は切削条件の目安を示すものです。実際の加工では加工形状、目的、使用機械等により条件を調整してください。
 - ⑤機械の回転数が足りない場合には、回転数と送り速度を同じ比率で下げてください。

- [Note]**
- ① Use a highly rigid and accurate machine as possible.
 - ② " a_e " (pick feed) figures in the above table are for general guidance. When making an actual selection, please refer to the cusp height table on A131.
 - ③ Use the appropriate coolant for the work material and machining shape.
 - ④ These conditions are for general guidance; in actual machining conditions adjust the parameters according to your actual machine and work-piece conditions.
 - ⑤ If the rpm available is lower than that recommended please reduce the feed rate to the same ratio.

Epoch Panacea Ball エポックパナシアボール

高切り込み荒加工～良好な仕上げ加工面。幅広い被削材の加工が可能。
Provides good machined surface finish for rough machining with high cutting depth.
Enables machining of a wide variety of subject materials.

レギュラー

Regular



RE公差 RE tolerance
RE0.15~RE6 : ±0.005
RE8~RE10 : ±0.01



(mm)

2枚刃
2Flutes



Aタイプ
A type

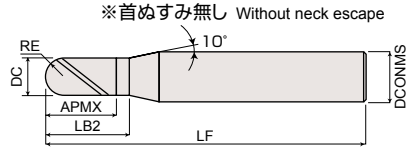

Bタイプ
B type

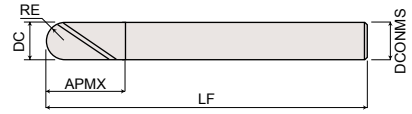

超硬 Carbide **PN** 切削条件表 A105 Cutting Conditions

HGOB2(○)(○)-PN

商品コード Item code	在庫 Stock	寸法 Size (mm)						刃数 No. of flutes	形状 Shape	希望小売価格 (円) Suggested retail price(¥)
		ボール半径 Ball radius RE	外径 Tool dia. DC	刃長 Flute length APMX	首下長 Under neck length LB2	全長 Overall length LF	シャンク径 Shank dia. DCONMS			
HGOB2003-PN	●	0.15	0.3	0.6	0.9	50	4	2	A	13,390
HGOB2004-PN	●	0.2	0.4	0.8	1.1	50	4	2	A	13,390
HGOB2005-PN	●	0.25	0.5	1	1.3	50	4	2	A	12,750
HGOB2006-PN	●	0.3	0.6	1.2	1.5	50	4	2	A	12,750
HGOB2008-PN	●	0.4	0.8	1.6	1.9	50	4	2	A	12,010
HGOB2010-PN	●	0.5	1	2.5	3.5	50	4	2	A	11,250
HGOB2015-PN	●	0.75	1.5	4	5	50	4	2	A	11,790
HGOB2020-PN	●	1	2	5	6	50	6	2	A	11,790
HGOB2025-PN	●	1.25	2.5	7	8	50	6	2	A	12,650
HGOB2030-PN	●	1.5	3	8	9	70	6	2	A	12,650
HGOB2040-4-PN	●	2	4	8	—	70	4	2	B	12,650
HGOB2040-PN	●			8	9	70	6	2	A	12,650
HGOB2050-PN	●	2.5	5	10	11	80	6	2	A	14,150
HGOB2060-PN	●	3	6	12	—	90	6	2	B	14,930
HGOB2080-PN	●	4	8	14	—	100	8	2	B	19,530
HGOB2100-PN	●	5	10	18	—	100	10	2	B	25,030
HGOB2120-PN	●	6	12	22	—	110	12	2	B	32,210
HGOB2160-PN	●	8	16	30	—	140	16	2	B	73,900
HGOB2200-PN	●	10	20	38	—	160	20	2	B	115,090

ロングシャンク

Long shank



RE公差 RE tolerance
RE3~RE6 : ±0.015
RE8~RE10 : ±0.02



(mm)

2枚刃
2Flutes



Aタイプ
A type

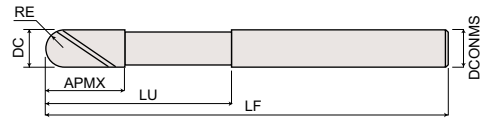

Bタイプ
B type

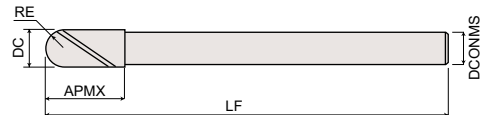

超硬 Carbide **PN** 切削条件表 A107 Cutting Conditions

HGOBLS2(○)(○)(○)-PN

商品コード Item code	在庫 Stock	寸法 Size (mm)						刃数 No. of flutes	形状 Shape	希望小売価格 (円) Suggested retail price(¥)
		ボール半径 Ball radius RE	外径 Tool dia. DC	刃長 Flute length APMX	首下長 Under neck length LU	全長 Overall length LF	シャンク径 Shank dia. DCONMS			
HGOBLS2060-45-PN	●	3	6	9	45	115	6	2	A	21,550
HGOBLS2060-75-PN	●			9	75	150	6	2	A	23,910
HGOBLS2080-55-PN	●	4	8	12	55	125	8	2	A	27,940
HGOBLS2080-105-PN	●			12	105	180	8	2	A	32,430
HGOBLS2100-PN	●	5	10	15	—	200	9	2	B	39,400
HGOBLS2120-PN	●	6	12	18	—	220	11	2	B	51,400
HGOBLS2160-PN	●	8	16	24	—	250	14	2	B	98,080
HGOBLS2200-PN	●	10	20	30	—	250	18	2	B	153,670

○ HGOB-PN、HGOBLS-PNの対応被削材

Applicable work material of HGOB-PN, HGOBLS-PN

炭素鋼 合金鋼 Carbon steel Alloy steel	プリハー ド鋼 Pre-hardened steel	高硬度 Hardened steel			ステン レス鋼 Stainless steel	チタン合金 耐熱合金 Titanium alloy Heat-resistant alloy	銅合金 Copper alloy	アルミ 合金 Aluminum alloy
		> 45HRC ≤ 45HRC	> 55HRC ≤ 55HRC	> 65HRC				
○	○	○	○	○	○	○	○	

○ 再研磨対応外径範囲

Re-grinding compatibility range

商品コード Item code	外周 Outer dia. (mm)	エンド End (mm)
HGOB-PN	× (N/A)	1 ~ 20
HGOBLS-PN	× (N/A)	6 ~ 20

[注意] 首下長/外径が10DCを超える工具の再研磨可否については、弊社営業にお問い合わせください。
[Note] Contact our sales office regarding whether or not re-grinding is possible for tools where under neck length/tool diameter more than 10DC

● : 標準在庫品です。● : Stocked items.

標準切削条件表 Recommended cutting conditions

エポックパナシアボール レギュラー
Epoch Panacea Ball Regular

※弊社従来品対比 Compared to conventional product.

切込み量2倍で高能率加工が可能!!

Twice the cutting depth enables high-efficiency cutting!

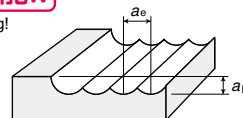

HGOB-PN

切削区分	ボール半径 RE Ball radius (mm)	外径 DC Tool dia. (mm)	刃長 APMX Flute length (mm)	銅合金・アルミ合金 Copper alloy, Aluminum alloy				鋳鉄・炭素鋼 Cast irons, Carbon steels(150~200HB) FC250,S50C,S55C				ステンレス鋼 Stainless steels(25~35HRC) SUS304,SUS316			
				回転数 min ⁻¹	送り速度 mm/min	ap mm	ae mm	回転数 min ⁻¹	送り速度 mm/min	ap mm	ae mm	回転数 min ⁻¹	送り速度 mm/min	ap mm	ae mm
荒加工 Roughing	0.15	0.3	0.6	35,032	2,102	0.039	0.117	31,847	1,911	0.039	0.117	28,662	1,720	0.038	0.112
	0.2	0.4	0.8	35,032	2,102	0.052	0.156	31,847	1,911	0.052	0.156	28,662	1,720	0.050	0.150
	0.25	0.5	1	35,032	2,102	0.065	0.195	31,847	1,911	0.065	0.195	28,662	1,720	0.063	0.187
	0.3	0.6	1.2	29,193	2,335	0.078	0.234	26,539	2,123	0.078	0.234	23,885	1,911	0.075	0.225
	0.4	0.8	1.6	26,274	2,102	0.104	0.312	23,885	1,911	0.104	0.312	21,497	1,720	0.100	0.300
	0.5	1	2.5	28,025	2,803	0.130	0.390	25,478	2,548	0.130	0.390	22,930	2,293	0.125	0.375
	0.75	1.5	4	25,690	3,083	0.195	0.585	23,355	2,803	0.195	0.585	21,019	2,522	0.188	0.562
	1	2	5	24,522	3,433	0.260	0.780	22,293	3,121	0.260	0.780	20,064	2,809	0.250	0.750
	1.25	2.5	7	22,420	3,587	0.325	0.975	20,382	3,261	0.325	0.975	18,344	2,935	0.313	0.937
	1.5	3	8	21,019	3,783	0.390	1.170	19,108	3,439	0.390	1.170	17,197	3,096	0.375	1.125
	2	4	8	20,143	4,029	0.520	1.560	18,312	3,662	0.520	1.560	16,481	3,296	0.500	1.500
			8	20,143	4,834	0.520	1.560	18,312	4,395	0.520	1.560	16,481	3,955	0.500	1.500
	2.5	5	10	18,217	5,101	0.650	1.950	16,561	4,637	0.650	1.950	14,904	4,173	0.625	1.875
	3	6	12	15,764	5,045	0.780	2.340	14,331	4,586	0.780	2.340	12,898	4,127	0.750	2.250
	4	8	14	12,699	4,572	1.040	3.120	11,545	4,156	1.040	3.120	10,390	3,740	1.000	3.000
5	10	18	10,860	4,344	1.300	3.900	9,873	3,949	1.300	3.900	8,885	3,554	1.250	3.750	
6	12	22	9,634	4,239	1.560	4.680	8,758	3,854	1.560	4.680	7,882	3,468	1.500	4.500	
8	16	30	7,444	3,573	2.080	6.240	6,768	3,248	2.080	6.240	6,091	2,924	2.000	6.000	
10	20	38	5,955	3,097	2.600	7.800	5,414	2,815	2.600	7.800	4,873	2,534	2.500	7.500	
仕上げ加工 Finishing	0.15	0.3	0.6	44,586	1,783	0.015	0.015	37,155	1,486	0.015	0.015	33,439	1,204	0.015	0.015
	0.2	0.4	0.8	42,994	1,720	0.020	0.020	35,828	1,433	0.020	0.020	32,245	1,161	0.020	0.020
	0.25	0.5	1	42,038	1,682	0.025	0.025	35,032	1,401	0.025	0.025	31,529	1,135	0.025	0.025
	0.3	0.6	1.2	35,032	2,102	0.030	0.030	29,193	1,752	0.030	0.030	26,274	1,419	0.030	0.030
	0.4	0.8	1.6	31,051	1,863	0.040	0.040	25,876	1,553	0.040	0.040	23,288	1,258	0.040	0.040
	0.5	1	2.5	30,573	1,834	0.050	0.050	25,478	1,529	0.050	0.050	22,930	1,238	0.050	0.050
	0.75	1.5	4	29,299	1,758	0.075	0.075	24,416	1,465	0.075	0.075	21,975	1,187	0.075	0.075
	1	2	5	29,618	2,369	0.100	0.100	24,682	1,975	0.100	0.100	22,213	1,599	0.100	0.100
	1.25	2.5	7	28,280	2,262	0.125	0.125	23,567	1,885	0.125	0.125	21,210	1,527	0.125	0.125
	1.5	3	8	26,115	2,089	0.150	0.150	21,762	1,741	0.150	0.150	19,586	1,410	0.150	0.150
	2	4	8	24,363	1,949	0.200	0.200	20,303	1,624	0.200	0.200	18,272	1,316	0.200	0.200
			8	24,363	2,436	0.200	0.200	20,303	2,030	0.200	0.200	18,272	1,645	0.200	0.200
	2.5	5	10	22,548	2,255	0.250	0.250	18,790	1,879	0.250	0.250	16,911	1,522	0.250	0.250
	3	6	12	19,427	2,331	0.300	0.300	16,189	1,943	0.300	0.300	14,570	1,574	0.300	0.300
	4	8	14	16,003	1,920	0.400	0.400	13,336	1,600	0.400	0.400	12,002	1,296	0.400	0.400
5	10	18	14,713	2,060	0.500	0.500	12,261	1,717	0.500	0.500	11,035	1,390	0.500	0.500	
6	12	22	13,535	2,436	0.600	0.600	11,279	2,030	0.600	0.600	10,151	1,645	0.600	0.600	
8	16	30	10,868	2,174	0.800	0.800	9,057	1,811	0.800	0.800	8,151	1,467	0.800	0.800	
10	20	38	7,739	1,548	1.000	1.000	6,449	1,290	1.000	1.000	5,804	1,045	1.000	1.000	

- [注意]** ①本工具のPNコーティングはその性質上、通電性が微小です。従って通電方式の工具長測定装置をご使用の際にはご注意ください。
 ②被削材、加工形状に合わせて、適切なクーラントを使用してください。
 ③できるだけ高剛性、高精度の機械をご使用ください。
 ④上表のピックフィード(ae)は目安です。実際にはA131頁のカスプハイト表を参考に選定してください。
 ⑤この切削条件表は切削条件の目安を示すものです。実際の加工では加工形状、目的、使用機械等により条件を調整してください。
 ⑥機械の回転数が足りない場合には、回転数と送り速度を同じ比率で下げてください。

- [Note]** ① PN coating is less electro conductive. Therefore, electric transmitted measuring systems may not work.
 ② Use the appropriate coolant for the work material and machining shape.
 ③ Use a highly rigid and accurate machine as possible.
 ④ The pick feed in the table is a general condition; please select the ae according to the cusp height requested (page A131).
 ⑤ These conditions are for general guidance; in actual machining conditions adjust the parameters according to your actual machine and work-piece conditions.
 ⑥ If the rpm available is lower than that recommended please reduce the feed rate to the same ratio.

Epoch Panacea Ball エポックパナシアボール

エポックパナシアボール レギュラー

Epoch Panacea Ball Regular

HGOB-PN

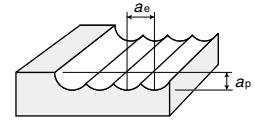

切削区分	ボール半径 RE Ball radius (mm)	外径 DC Tool dia. (mm)	刃長 APMX Flute length (mm)	合金鋼・工具鋼				プリハードン鋼				焼入れ鋼			
				Alloy steels(25~35HRC) HPM7,SKD61(A),SKT4				Pre-hardened steels(35~45HRC) HPM-MAGIC,CENA1,NAK80				Hardened steels(45~52HRC) SKD61(B),HPM38,DAC-MAGIC			
				回転数 min ⁻¹	送り速度 mm/min	ap mm	ae mm	回転数 min ⁻¹	送り速度 mm/min	ap mm	ae mm	回転数 min ⁻¹	送り速度 mm/min	ap mm	ae mm
荒加工 Roughing	0.15	0.3	0.6	28,662	1,634	0.036	0.108	25,796	1,393	0.035	0.103	22,930	1,176	0.033	0.099
	0.2	0.4	0.8	28,662	1,634	0.048	0.144	25,796	1,393	0.046	0.138	22,930	1,176	0.044	0.132
	0.25	0.5	1	28,662	1,634	0.060	0.180	25,796	1,393	0.058	0.172	22,930	1,176	0.055	0.165
	0.3	0.6	1.2	23,885	1,815	0.072	0.216	21,497	1,548	0.069	0.207	19,108	1,307	0.066	0.198
	0.4	0.8	1.6	21,497	1,634	0.096	0.288	19,347	1,393	0.092	0.276	17,197	1,176	0.088	0.264
	0.5	1	2.5	22,930	2,178	0.120	0.360	20,637	1,857	0.115	0.345	18,344	1,568	0.110	0.330
	0.75	1.5	4	21,019	2,396	0.180	0.540	18,917	2,043	0.173	0.517	16,815	1,725	0.165	0.495
	1	2	5	20,064	2,668	0.240	0.720	18,057	2,275	0.230	0.690	16,051	1,921	0.220	0.660
	1.25	2.5	7	18,344	2,788	0.300	0.900	16,510	2,377	0.288	0.862	14,675	2,008	0.275	0.825
	1.5	3	8	17,197	2,941	0.360	1.080	15,478	2,507	0.345	1.035	13,758	2,117	0.330	0.990
	2	4	8	16,481	3,131	0.480	1.440	14,833	2,670	0.460	1.380	13,185	2,255	0.440	1.320
			8	16,481	3,758	0.480	1.440	14,833	3,204	0.460	1.380	13,185	2,706	0.440	1.320
	2.5	5	10	14,904	3,965	0.600	1.800	13,414	3,380	0.575	1.725	11,924	2,855	0.550	1.650
	3	6	12	12,898	3,921	0.720	2.160	11,608	3,343	0.690	2.070	10,318	2,823	0.660	1.980
	4	8	14	10,390	3,553	0.960	2.880	9,351	3,030	0.920	2.760	8,312	2,558	0.880	2.640
	5	10	18	8,885	3,376	1.200	3.600	7,997	2,879	1.150	3.450	7,108	2,431	1.100	3.300
	6	12	22	7,882	3,295	1.440	4.320	7,094	2,809	1.380	4.140	6,306	2,372	1.320	3.960
	8	16	30	6,091	2,777	1.920	5.760	5,482	2,368	1.840	5.520	4,873	2,000	1.760	5.280
10	20	38	4,873	2,407	2.400	7.200	4,385	2,052	2.300	6.900	3,898	1,733	2.200	6.600	
仕上げ加工 Finishing	0.15	0.3	0.6	33,439	1,204	0.012	0.012	30,096	975	0.009	0.009	26,752	770	0.009	0.009
	0.2	0.4	0.8	32,245	1,161	0.016	0.016	29,021	940	0.012	0.012	25,796	743	0.012	0.012
	0.25	0.5	1	31,529	1,135	0.020	0.020	28,376	919	0.015	0.015	25,223	726	0.015	0.015
	0.3	0.6	1.2	26,274	1,419	0.024	0.024	23,646	1,149	0.018	0.018	21,019	908	0.018	0.018
	0.4	0.8	1.6	23,288	1,258	0.032	0.032	20,959	1,019	0.024	0.024	18,631	805	0.024	0.024
	0.5	1	2.5	22,930	1,238	0.040	0.040	20,637	1,003	0.030	0.030	18,344	792	0.030	0.030
	0.75	1.5	4	21,975	1,187	0.060	0.060	19,777	961	0.045	0.045	17,580	759	0.045	0.045
	1	2	5	22,213	1,599	0.080	0.080	19,992	1,295	0.060	0.060	17,771	1,024	0.060	0.060
	1.25	2.5	7	21,210	1,527	0.100	0.100	19,089	1,237	0.075	0.075	16,968	977	0.075	0.075
	1.5	3	8	19,586	1,410	0.120	0.120	17,627	1,142	0.090	0.090	15,669	903	0.090	0.090
			8	18,272	1,316	0.160	0.160	16,445	1,066	0.120	0.120	14,618	842	0.120	0.120
	2	4	8	18,272	1,645	0.160	0.160	16,445	1,332	0.120	0.120	14,618	1,052	0.120	0.120
			8	16,911	1,522	0.200	0.200	15,220	1,233	0.150	0.150	13,529	974	0.150	0.150
	2.5	5	10	16,911	1,522	0.200	0.200	15,220	1,233	0.150	0.150	13,529	974	0.150	0.150
	3	6	12	14,570	1,574	0.240	0.240	13,113	1,275	0.180	0.180	11,656	1,007	0.180	0.180
	4	8	14	12,002	1,296	0.320	0.320	10,802	1,050	0.240	0.240	9,602	830	0.240	0.240
	5	10	18	11,035	1,390	0.400	0.400	9,932	1,126	0.300	0.300	8,828	890	0.300	0.300
	6	12	22	10,151	1,645	0.480	0.480	9,136	1,332	0.360	0.360	8,121	1,052	0.360	0.360
8	16	30	8,151	1,467	0.640	0.640	7,336	1,188	0.480	0.480	6,521	939	0.480	0.480	
10	20	38	5,804	1,045	0.800	0.800	5,224	846	0.600	0.600	4,643	669	0.600	0.600	

超硬合金ボール

エポックパナシアボール ロングシャンク

Epoch Panacea Ball Long shank

HGOBLS-PN

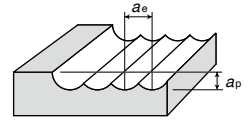

切削区分	ボール半径 RE Ball radius (mm)	外径 DC Tool dia. (mm)	刃長 APMX Flute length (mm)	首下長 LU Under neck length (mm)	被削材 Work material	銅合金 アルミ合金 Copper alloy Aluminum alloy		鋳鉄 炭素鋼 Cast irons Carbon steels (150~220HB) FC250 S50C,S55C		ステンレス鋼 Stainless steels (25~35HRC) SUS304 SUS316		合金鋼 工具鋼 Alloy steels (25~35HRC) HPM7 SKD61 (A),SKT4		プリハードン鋼 Pre-hardened steels (35~45HRC) HPM-MAGIC CENA1,NAK80		焼入れ鋼 Hardened steels (45~52HRC) SKD61 (A),HPM38 DAC-MAGIC			
						切込み比率 Ratio to standard depth of cut		100%		100%		90%		80%		70%		50%	
						基本切込み Standard depth of cut ap mm	回転数 min ⁻¹	送り速度 mm/min	回転数 min ⁻¹	送り速度 mm/min	回転数 min ⁻¹	送り速度 mm/min	回転数 min ⁻¹	送り速度 mm/min	回転数 min ⁻¹	送り速度 mm/min	回転数 min ⁻¹	送り速度 mm/min	回転数 min ⁻¹
荒加工 Roughing	3	6	9	45	0.42	9,550	2,670	7,960	2,230	6,630	1,860	6,630	1,860	6,630	1,190	5,300	950		
			9	75	0.25	8,350	2,320	6,960	1,940	5,630	1,570	5,630	1,570	5,630	1,010	4,300	770		
	4	8	12	55	0.64	7,160	2,290	5,970	1,910	4,980	1,590	4,980	1,590	4,980	1,100	3,980	880		
			12	105	0.35	5,960	1,900	4,970	1,590	3,980	1,270	3,980	1,270	3,980	880	2,980	650		
	5	10	15	-	1	5,720	2,060	4,770	1,720	3,980	1,430	3,980	1,430	3,980	1,030	3,180	830		
	6	12	18	-	1.2	4,770	1,900	3,980	1,590	3,320	1,330	3,320	1,330	3,320	1,000	2,650	800		
8	16	24	-	1.6	3,570	1,600	2,980	1,340	2,490	1,120	2,490	1,120	2,490	850	1,990	680			
10	20	30	-	2	2,860	1,280	2,390	1,070	1,990	900	1,990	900	1,990	680	1,590	540			
仕上げ加工 Finishing	3	6	9	45	0.05~0.1	9,550	1,865	7,960	1,554	7,960	1,102	7,960	1,102	7,960	638	6,630	504		
			9	75	0.05~0.1	8,350	1,678	6,960	1,398	6,960	991	6,960	991	6,960	574	5,630	453		
	4	8	12	55	0.05~0.1	7,160	1,536	5,970	1,280	5,970	907	5,970	907	5,970	563	4,980	415		
			12	105	0.05~0.1	5,960	1,382	4,970	1,152	4,970	816	4,970	816	4,970	507	3,980	374		
	5	10	15	-	0.05~0.15	5,720	1,648	4,770	1,374	4,770	973	4,770	973	4,770	563	3,980	445		
	6	12	18	-	0.05~0.15	4,770	1,900	3,980	1,590	3,980	1,152	3,980	1,152	3,980	666	3,320	526		
8	16	24	-	0.05~0.2	3,570	1,600	2,980	1,340	2,980	1,027	2,980	1,027	2,980	594	2,490	470			
10	20	30	-	0.05~0.2	2,860	1,238	2,390	1,032	2,390	732	2,390	732	2,390	423	1,990	335			

ボール・ロングシャンクの切込みについて Regarding cutting depth for ball nose, long-shank products

ap 【荒加工】 Roughing

工具突き出し比率 Over-hang ratio	
5DC 以下 or less	基本切込み × 切込み比率 Standard depth of cut × Ratio to standard depth of cut
6DC	0.9 × 基本切込み × 切込み比率 0.9 × Standard depth of cut × Ratio to standard depth of cut
7DC	0.8 × 基本切込み × 切込み比率 0.8 × Standard depth of cut × Ratio to standard depth of cut
8DC	0.7 × 基本切込み × 切込み比率 0.7 × Standard depth of cut × Ratio to standard depth of cut
9DC	0.6 × 基本切込み × 切込み比率 0.6 × Standard depth of cut × Ratio to standard depth of cut
10DC	0.5 × 基本切込み × 切込み比率 0.5 × Standard depth of cut × Ratio to standard depth of cut

ae 【荒加工】 Roughing

ap の3倍が目安です。
3 times the ap as general criteria

【仕上げ加工】 Finishing

理論カスプハイトより、ご希望の値を選定ください
Select the desired value according to the theoretical cusp height.

【仕上げ加工】 Finishing

表内の数値を参照ください Refer to the values in the table.

- 【注意】**
- ① 本工具のPNコーティングはその性質上、通電性が微小です。従って通電方式の工具長測定装置をご使用の際にはご注意ください。
 - ② 被削材、加工形状に合わせて、適切なクーラントを使用してください。
 - ③ できるだけ高剛性、高精度の機械をご使用ください。
 - ④ 上表のピックフィード (ae) は目安です。実際にはA131頁のカスプハイト表を参考に選定してください。
 - ⑤ この切削条件表は切削条件の目安を示すものです。実際の加工では加工形状、目的、使用機械等により条件を調整してください。
 - ⑥ 機械の回転数が足りない場合には、回転数と送り速度を同じ比率で下げてください。

- 【Note】**
- ① PN coating is less electro conductive. Therefore, electric transmitted measuring systems may not work.
 - ② Use the appropriate coolant for the work material and machining shape.
 - ③ Use a highly rigid and accurate machine as possible.
 - ④ The pick feed in the table is a general condition; please select the ae according to the cusp height requested (page A131).
 - ⑤ These conditions are for general guidance; in actual machining conditions adjust the parameters according to your actual machine and work-piece conditions.
 - ⑥ If the rpm available is lower than that recommended please reduce the feed rate to the same ratio.

Epoch Shrink Master Ball

エポックシュリンクマスターボール

高精度規格品 High accuracy rating product

焼きばめホルダーに適しています。高精度規格品。
Ideal for press-fit holders. High-accuracy rating product.

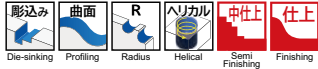

RE公差 RE tolerance $\pm 0.001 \sim -0.003$ (mm) h4

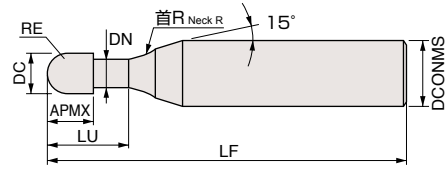

2枚刃
2Flutes



ESHB2-H-TH

高精度規格品 High-accuracy rating product

検査票付き Inspection certificate included

超硬 TH 刃先30° Helix angle Cutting Conditions A109

商品コード Item code	在庫 Stock	寸法 Size (mm)							全長 Overall length LF	シャンク径 Shank dia. DCONMS	干渉角度 Interference angle θ_K	有効長さ (ワーク傾斜角に対する有効長) Effective length (Effective length for work angle)						希望小売 価格(円) Suggested retail price(¥)
		ボール半径 Ball radius RE	外径 Tool dia. DC	刃長 Flute length APMX	首径 Neck dia. DN	首下長 Under neck length LU	首 R Neck R	0°				0.5°	1°	1.5°	2°	3°		
		ESHB2010-H-TH	●	0.5	1	1	0.95	2.5				4	40	4	11.04	2.94	3.11	
ESHB2015-H-TH	●	0.75	1.5	1.5	1.45	3.75	4	40	4	9.16	4.19	4.42	4.60	4.76	4.90	5.16	14,790	
ESHB2020-H-TH	●	1	2	2	1.95	5	4	45	6	9.82	5.44	5.72	5.93	6.11	6.27	6.56	14,790	
ESHB2025-H-TH	●	1.25	2.5	2.5	2.45	6.25	4	45	6	8.57	6.69	7.02	7.26	7.46	7.63	7.94	15,530	
ESHB2030-H-TH	●	1.5	3	3	2.9	7.5	4	45	6	7.26	8.13	8.43	8.67	8.87	9.05	9.37	15,530	
ESHB2035-H-TH	●	1.75	3.5	3.5	3.4	8.75	4	45	6	6.03	9.38	9.72	9.98	10.19	10.39	10.72	15,530	
ESHB2040-H-TH	●	2	4	4	3.9	10	4	45	6	4.80	10.63	11.00	11.28	11.51	11.72	12.18	15,530	
ESHB2050-H-TH	●	2.5	5	5	4.9	12.5	4	50	6	2.38	13.13	13.57	13.88	14.14	14.37	-	17,070	
ESHB2060-H-TH	●	3	6	6	5.9	15	-	50	6	-	15.00	-	-	-	-	-	17,850	
ESHB2080-H-TH	●	4	8	8	7.9	20	-	60	8	-	20.00	-	-	-	-	-	22,790	
ESHB2100-H-TH	●	5	10	10	9.9	25	-	70	10	-	25.00	-	-	-	-	-	28,400	
ESHB2120-H-TH	●	6	12	12	11.9	30	-	75	12	-	30.00	-	-	-	-	-	37,030	

標準規格品 Standard rating product

焼きばめホルダーに適しています。標準規格品。
Ideal for press-fit holders. Standard rating product

RE公差 RE tolerance ± 0.005 (mm) h4

ESHB2-N-TH

標準規格品 Standard rating product

超硬 TH 刃先30° Helix angle Cutting Conditions A109

商品コード Item code	在庫 Stock	寸法 Size (mm)							全長 Overall length LF	シャンク径 Shank dia. DCONMS	干渉角度 Interference angle θ_K	有効長さ (ワーク傾斜角に対する有効長) Effective length (Effective length for work angle)						希望小売 価格(円) Suggested retail price(¥)
		ボール半径 Ball radius RE	外径 Tool dia. DC	刃長 Flute length APMX	首径 Neck dia. DN	首下長 Under neck length LU	首 R Neck R	0°				0.5°	1°	1.5°	2°	3°		
		ESHB2010-N-TH	●	0.5	1	1	0.95	2.5				4	40	4	11.04	2.94	3.11	
ESHB2015-N-TH	●	0.75	1.5	1.5	1.45	3.75	4	40	4	9.16	4.19	4.42	4.60	4.76	4.90	5.16	12,440	
ESHB2020-N-TH	●	1	2	2	1.95	5	4	45	6	9.82	5.44	5.72	5.93	6.11	6.27	6.56	12,440	
ESHB2025-N-TH	●	1.25	2.5	2.5	2.45	6.25	4	45	6	8.57	6.69	7.02	7.26	7.46	7.63	7.94	13,180	
ESHB2030-N-TH	●	1.5	3	3	2.9	7.5	4	45	6	7.26	8.13	8.43	8.67	8.87	9.05	9.37	13,180	
ESHB2035-N-TH	●	1.75	3.5	3.5	3.4	8.75	4	45	6	6.03	9.38	9.72	9.98	10.19	10.39	10.72	13,180	
ESHB2040-N-TH	●	2	4	4	3.9	10	4	45	6	4.80	10.63	11.00	11.28	11.51	11.72	12.18	13,180	
ESHB2050-N-TH	●	2.5	5	5	4.9	12.5	4	50	6	2.38	13.13	13.57	13.88	14.14	14.37	-	14,480	
ESHB2060-N-TH	●	3	6	6	5.9	15	-	50	6	-	15.00	-	-	-	-	-	15,150	
ESHB2080-N-TH	●	4	8	8	7.9	20	-	60	8	-	20.00	-	-	-	-	-	19,640	
ESHB2100-N-TH	●	5	10	10	9.9	25	-	70	10	-	25.00	-	-	-	-	-	24,810	
ESHB2120-N-TH	●	6	12	12	11.9	30	-	75	12	-	30.00	-	-	-	-	-	32,660	

[注意]

加工物に勾配がついている場合、干渉領域は、首下長さよりも長くなります。それぞれの勾配角に対する実有効首下長さをご参照ください。また、工具が加工物に干渉する角度を干渉角度 θ_K で表示していますので合わせてご参照ください。

[Note]

If the workpiece has draft angle, the interference length will be longer than the under-neck length. Please refer to the effective under-neck length for the various draft angles. In addition, the angle at which the tool will interfere with the workpiece is shown as the "interference angle θ_K ", and should also be referred to.

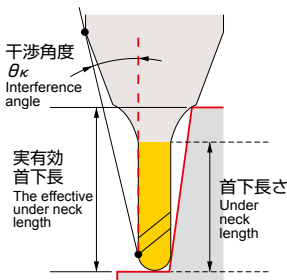

●印：標準在庫品です。●：Stocked items.

ESHB-H-TH、ESHB-N-TH の対応被削材

Applicable work material of ESHB-H-TH, ESHB-N-TH

炭素鋼 合金鋼 Carbon steel Alloy steel	プリハードン鋼 Pre-hardened steel	高硬度 Hardened steel > 45HRC ≤ 55HRC	ステンレス鋼 Stainless steel > 65HRC	チタン合金 耐熱合金 Titanium alloy Heat-resistant alloy	銅合金 Copper alloy	アルミ合金 Aluminum alloy
○	○	○	○	○	○	○

再研磨対応外径範囲 Re-grinding compatibility range

商品コード Item code	外周 Outer dia. (mm)	エンド End (mm)
ESHB-H-TH	× (N/A)	× (N/A)
ESHB-N-TH	× (N/A)	1 ~ 12

標準切削条件表 Recommended cutting conditions

ESHB-H-TH	ESHB-N-TH
高精度規格品	標準規格品
High accuracy rating product	Standard rating product

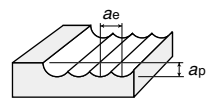

<荒加工> Roughing

被削材 Work material	工具鋼 Tool steels (25~35HRC) SKD				プリハードン鋼 Pre-hardened steels (35~45HRC) CENA1, NAK80				焼入れ鋼 Hardened steels (45~55HRC) SKD61, SKT4				焼入れ鋼 Hardened steels (55~65HRC) SKD11, SKH51				焼入れ鋼 Hardened steels (65~70HRC) SKH, HAP			
	高速条件 High speed		汎用条件 General		高速条件 High speed		汎用条件 General		高速条件 High speed		汎用条件 General		高速条件 High speed		汎用条件 General		高速条件 High speed		汎用条件 General	
切込み Depth of cut (mm)	$a_p=0.1DC$ $a_e=0.3DC$		$a_p=0.1DC$ $a_e=0.3DC$		$a_p=0.1DC$ $a_e=0.3DC$		$a_p=0.1DC$ $a_e=0.3DC$		$a_p=0.08DC$ $a_e=0.24DC$		$a_p=0.1DC$ $a_e=0.3DC$		$a_p=0.05DC$ $a_e=0.15DC$		$a_p=0.07DC$ $a_e=0.21DC$		$a_p=0.05DC$ $a_e=0.15DC$		$a_p=0.07DC$ $a_e=0.21DC$	
ボール半径RE ×外径DC Tool dia.(mm)	回転数 n (min ⁻¹)	送り速度 Vf (mm/min)	回転数 n (min ⁻¹)	送り速度 Vf (mm/min)	回転数 n (min ⁻¹)	送り速度 Vf (mm/min)	回転数 n (min ⁻¹)	送り速度 Vf (mm/min)	回転数 n (min ⁻¹)	送り速度 Vf (mm/min)	回転数 n (min ⁻¹)	送り速度 Vf (mm/min)	回転数 n (min ⁻¹)	送り速度 Vf (mm/min)	回転数 n (min ⁻¹)	送り速度 Vf (mm/min)	回転数 n (min ⁻¹)	送り速度 Vf (mm/min)	回転数 n (min ⁻¹)	送り速度 Vf (mm/min)
RE0.5×1	50,000	1,800	20,000	720	50,000	1,600	20,000	640	50,000	1,500	20,000	540	50,000	1,300	20,000	470	38,000	990	16,000	370
RE1×2	48,000	3,170	20,000	1,320	48,000	2,780	20,000	1,160	38,000	1,980	16,000	750	29,000	1,390	13,000	560	19,000	910	8,000	350
RE1.5×3	32,000	3,260	16,000	1,630	32,000	2,880	16,000	1,440	25,000	2,100	11,000	830	19,000	1,440	8,500	580	13,000	990	5,300	360
RE2×4	24,000	3,360	12,000	1,680	24,000	2,930	12,000	1,460	19,000	2,170	8,000	820	14,000	1,460	6,400	600	10,000	1,040	4,000	370
RE3×6	16,000	3,360	8,000	1,680	16,000	2,940	8,000	1,470	13,000	2,240	5,300	820	9,600	1,500	4,200	590	6,400	1,000	2,700	380
RE4×8	12,000	3,600	6,000	1,800	12,000	3,020	6,000	1,510	10,000	2,320	4,000	840	7,200	1,510	3,200	600	4,800	1,010	2,000	380
RE5×10	10,000	3,600	4,800	1,730	10,000	3,120	4,800	1,500	7,600	2,170	3,200	820	5,700	1,480	2,500	590	3,800	990	1,600	370
RE6×12	8,000	3,100	4,000	1,550	8,000	2,690	4,000	1,340	6,400	1,970	2,700	750	4,800	1,340	2,100	530	3,200	900	1,300	330

<仕上げ加工> Finishing

a_p : 仕上げ代 Finishing cut amount
 a_e : ピックフィード Pick feed

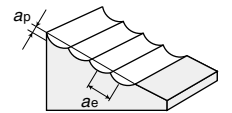

被削材 Work material	工具鋼 Tool steels (25~35HRC) SKD				プリハードン鋼 Pre-hardened steels (35~45HRC) CENA1, NAK80				焼入れ鋼 Hardened steels (45~55HRC) SKD61, SKT4				焼入れ鋼 Hardened steels (55~65HRC) SKD11, SKH51				焼入れ鋼 Hardened steels (65~70HRC) SKH, HAP			
	高速条件 High speed		汎用条件 General		高速条件 High speed		汎用条件 General		高速条件 High speed		汎用条件 General		高速条件 High speed		汎用条件 General		高速条件 High speed		汎用条件 General	
切込み Depth of cut (mm)	$a_p=0.05\sim0.1$ $a_e=0.02DC$		$a_p=0.05\sim0.1$ $a_e=0.02DC$		$a_p=0.05\sim0.1$ $a_e=0.02DC$		$a_p=0.05\sim0.1$ $a_e=0.02DC$		$a_p=0.05\sim0.1$ $a_e=0.02DC$		$a_p=0.05\sim0.1$ $a_e=0.02DC$		$a_p=0.05\sim0.1$ $a_e=0.02DC$		$a_p=0.05\sim0.1$ $a_e=0.02DC$		$a_p=0.05\sim0.1$ $a_e=0.02DC$		$a_p=0.05\sim0.1$ $a_e=0.02DC$	
ボール半径RE ×外径DC Tool dia.(mm)	回転数 n (min ⁻¹)	送り速度 Vf (mm/min)	回転数 n (min ⁻¹)	送り速度 Vf (mm/min)	回転数 n (min ⁻¹)	送り速度 Vf (mm/min)	回転数 n (min ⁻¹)	送り速度 Vf (mm/min)	回転数 n (min ⁻¹)	送り速度 Vf (mm/min)	回転数 n (min ⁻¹)	送り速度 Vf (mm/min)	回転数 n (min ⁻¹)	送り速度 Vf (mm/min)	回転数 n (min ⁻¹)	送り速度 Vf (mm/min)	回転数 n (min ⁻¹)	送り速度 Vf (mm/min)	回転数 n (min ⁻¹)	送り速度 Vf (mm/min)
RE0.5×1	50,000	5,000	20,000	2,000	50,000	5,000	20,000	2,000	50,000	4,000	20,000	1,600	50,000	2,500	15,000	750	48,000	2,400	15,000	750
RE1×2	32,000	3,840	20,000	2,400	32,000	3,840	20,000	2,400	32,000	3,200	20,000	2,000	32,000	2,880	15,000	1,350	24,000	2,160	14,000	1,260
RE1.5×3	25,000	3,500	17,000	2,380	25,000	3,500	17,000	2,380	24,000	2,880	14,000	1,680	21,000	2,520	13,000	1,560	16,000	1,920	10,000	1,200
RE2×4	22,000	3,740	13,000	2,210	22,000	3,740	13,000	2,210	20,000	3,200	10,000	1,600	16,000	2,400	9,600	1,440	12,000	1,800	7,200	1,080
RE3×6	16,000	3,520	8,500	1,870	16,000	3,520	8,500	1,870	13,000	2,730	6,900	1,450	11,000	2,200	6,400	1,280	8,000	1,600	4,800	960
RE4×8	12,000	2,880	6,400	1,540	12,000	2,880	6,400	1,540	10,000	2,300	5,200	1,200	8,000	1,760	4,800	1,060	6,000	1,320	3,600	790
RE5×10	10,000	2,600	5,100	1,330	10,000	2,600	5,100	1,330	8,000	2,000	4,100	1,030	6,400	1,540	3,800	910	4,800	1,150	2,900	700
RE6×12	8,000	2,160	4,200	1,130	8,000	2,160	4,200	1,130	6,600	1,720	3,500	910	5,300	1,330	3,200	800	4,000	1,000	2,400	600

- [注意]**
- ①できるだけ高剛性、高精度の機械をご使用ください。
 - ②上表の a_e (ピックフィード)は目安です。実際にはA131頁のカスプハイト表を参考に選定してください。
 - ③被削材、加工形状に合わせて、適切なクーラントを使用してください。
 - ④この切削条件表は切削条件の目安を示すものです。実際の加工では加工形状、目的、使用機械等により条件を調整してください。
 - ⑤機械の回転数が足りない場合には、回転数と送り速度を同じ比率で下げてください。

- [Note]**
- ① Use a highly rigid and accurate machine as possible.
 - ② "a_e" (pick feed) figures in the above table are for general guidance. When making an actual selection, please refer to the cusp height table on A131.
 - ③ Use the appropriate coolant for the work material and machining shape.
 - ④ These conditions are for general guidance; in actual machining conditions adjust the parameters according to your actual machine and work-piece conditions.
 - ⑤ If the rpm available is lower than that recommended please reduce the feed rate to the same ratio.

Epoch Mega Feed Ball Evolution

エポックメガフィードボール エボリューション

ストレートタイプ

Straight Type

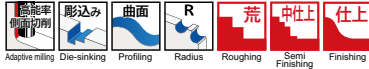

強ねじれボール刃形の採用により、
切削抵抗の低減と切りくず排出性向上を実現！
High helix ball flute shape that reduces cutting force and
improves chip removal.

RE公差 RE tolerance	RE0.5~RE1.75 : ±0.005 RE2~RE3 : ±0.007 RE4~RE6 : ±0.010 RE8~RE10 : ±0.015	外径公差 Dia. tolerance	RE0.5~RE1.75 : 0~-0.010 RE2~RE3 : 0~-0.014 RE4~RE6 : 0~-0.020 RE8~RE10 : 0~-0.030	h5
----------------------	--	------------------------	--	----



3枚刃
3Flutes

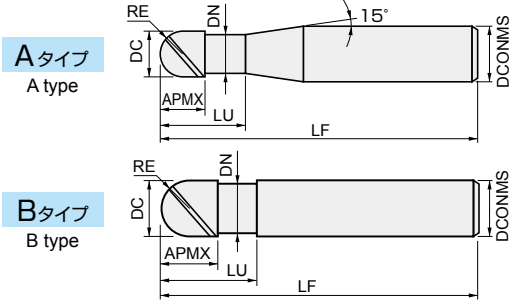

EMBE3○○○(-S○)-ATH

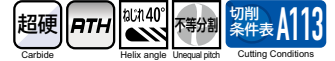

商品コード Item code	在庫 Stock	寸法 Size(mm)							形状 Shape	希望小売 価格(円) Suggested retail price (¥)
		ボール半径 Ball radius RE	外径 Tool dia. DC	刃長 Flute length APMX	首下長 Under neck length LU	首径 Neck dia. DN	全長 Overall length LF	シャンク径 Shank dia. DCONMS		
EMBE3010-S4-ATH	●	0.5	1	1.5	3	0.95	50	4	A	15,650
EMBE3010-S6-ATH	●			1.5	3	0.95	50	6	A	15,650
EMBE3015-S4-ATH	●	0.75	1.5	2.5	4.5	1.43	50	4	A	15,650
EMBE3015-S6-ATH	●			2.5	4.5	1.43	50	6	A	15,650
EMBE3020-S4-ATH	●	1	2	3	6	1.9	50	4	A	15,650
EMBE3020-S6-ATH	●			3	6	1.9	50	6	A	15,650
EMBE3025-S4-ATH	●	1.25	2.5	4	7.5	2.38	50	4	A	16,610
EMBE3025-S6-ATH	●			4	7.5	2.38	50	6	A	16,610
EMBE3030-S4-ATH	●	1.5	3	4.5	9	2.9	70	4	A	16,610
EMBE3030-S6-ATH	●			4.5	9	2.9	70	6	A	16,610
EMBE3035-S4-ATH	●	1.75	3.5	5.5	10.5	3.4	70	4	A	16,610
EMBE3035-S6-ATH	●			5.5	10.5	3.4	70	6	A	16,610
EMBE3040-S4-ATH	●	2	4	6	12	3.9	70	4	B	16,610
EMBE3040-S6-ATH	●			6	12	3.9	70	6	A	16,610
EMBE3050-ATH	●	2.5	5	7.5	15	4.7	80	6	A	18,640
EMBE3060-ATH	●	3	6	9	18	5.7	90	6	B	19,760
EMBE3080-ATH	●	4	8	12	24	7.6	100	8	B	25,930
EMBE3100-ATH	●	5	10	15	30	9.5	100	10	B	32,990
EMBE3120-ATH	●	6	12	18	36	11.5	110	12	B	42,870
EMBE3160-ATH	●	8	16	24	48	15	140	16	B	87,750
EMBE3200-ATH	●	10	20	30	60	19	160	20	B	137,250

○ 対応被削材 Applicable work material

炭素鋼 合金鋼 Carbon steel Alloy steel	プリハードン鋼 Pre-hardened steel	高硬度 Hardened steel			ステンレス鋼 Stainless steel	チタン合金 耐熱合金 Titanium alloy Heat-resistant alloy	銅合金 Copper alloy	アルミ合金 Aluminum alloy
○	○	> 45HRC ≤ 45HRC	> 55HRC ≤ 55HRC	> 65HRC	○	○	○	○

○：標準在庫品です。●：Stocked items. 干渉なし：No interference

○ 再研磨対応外径範囲 Re-grinding compatibility range

商品コード Item code	外周 Outer dia. (mm)	エンド End (mm)
EMBE-ATH	6 ~ 20	4 ~ 20

ペンシルネック Pencil Neck

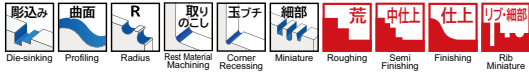

RE公差 RE tolerance
 RE0.5~RE1.75 : ±0.005
 RE2~RE3 : ±0.007
 RE4~RE6 : ±0.010



強ねじれボール刃形の採用により、
 切削抵抗の低減と切りくず排出性向上を実現!
 High helix ball flute shape that reduces cutting
 force and improves chip removal.

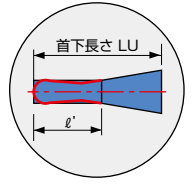

3枚刃
 3Flutes

【注意】 RE 2mm以上はバックドラフト形状ではありません。
 [Note] RE 2mm or higher does not have backdraft shape.



外周バックテーパ : 3~5°
 Back taper on peripheral edge

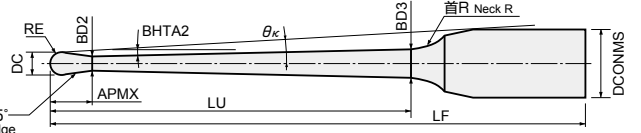

EMBPE3-ATH



商品コード Item code	在庫 Stock	寸法 Size(mm)											干渉角度 Interference angle (°)	勾配角に対する実有効首下長 Effective under neck length with respect to draft angle					希望小売 価格 (円) Suggested retail price (¥)	
		ボール半径 Ball radius RE	外径 Tool dia. DC	首部 テーパ(半角) Neck angle BHTA2	首下長 Under neck length LU	刃長 Flute length APMX	首径 Neck dia. BD2	首元径 Under neck dia. BD3	全長 Overall length LF	シャンク径 Shank dia. DC ONMS	首形状 Neck shape	仮想首長 Approx neck length ℓ'		θκ	0.75° 1° 1.5° 2° 3°					
															0.75°	1°	1.5°	2°		3°
EMBPE3010-6-09-ATH	●	0.9	6	0.8	0.94	1.103	50	6	A	2.70	8.36	6.45	6.66	6.96	7.19	7.56	10,690			
EMBPE3010-8-09-ATH	●	0.9	8	0.8	0.94	1.166	55	6	A	2.70	7.55	8.4	8.68	9.05	9.32	9.93	10,830			
EMBPE3010-10-09-ATH	●	0.9	10	0.8	0.94	1.229	55	6	A	2.70	6.88	10.33	10.71	11.13	11.43	12.39	10,830			
EMBPE3010-12-09-ATH	●	0.9	12	0.8	0.94	1.291	60	6	A	2.70	6.32	12.25	12.73	13.2	13.54	14.85	10,940			
EMBPE3010-14-09-ATH	●	0.9	14	0.8	0.94	1.354	60	6	A	2.70	5.85	13.77	14.75	15.27	15.65	17.31	10,940			
EMBPE3010-16-09-ATH	●	0.9	16	0.8	0.94	1.417	60	6	A	2.70	5.44	13.77	16.77	17.34	17.77	19.77	10,940			
EMBPE3010-18-09-ATH	●	0.9	18	0.8	0.94	1.480	65	6	A	2.70	5.08	13.77	18.79	19.4	20.08	22.23	11,370			
EMBPE3010-20-09-ATH	●	0.9	20	0.8	0.94	1.543	65	6	A	2.70	4.77	13.77	20.81	21.46	22.3	24.68	11,370			
EMBPE3010-22-09-ATH	●	0.9	22	0.8	0.94	1.606	70	6	A	2.70	4.5	13.77	22.82	23.51	24.52	27.14	11,580			
EMBPE3010-24-09-ATH	●	0.9	24	0.8	0.94	1.668	70	6	A	2.70	4.25	13.77	24.84	25.57	26.73	29.6	12,010			
EMBPE3010-26-09-ATH	●	0.9	26	0.8	0.94	1.731	70	6	A	2.70	4.03	13.77	26.86	27.62	28.95	32.06	12,110			
EMBPE3010-28-09-ATH	●	0.9	28	0.8	0.94	1.794	75	6	A	2.70	3.83	13.77	28.88	29.73	31.17	34.52	12,320			
EMBPE3010-30-09-ATH	●	0.9	30	0.8	0.94	1.857	75	6	A	2.70	3.65	13.77	30.89	31.84	33.38	36.98	12,320			
EMBPE3010-32-09-ATH	●	0.9	32	0.8	0.94	1.920	80	6	A	2.70	3.49	13.77	32.91	33.95	35.6	39.43	13,080			
EMBPE3010-34-09-ATH	●	0.9	34	0.8	0.94	1.983	80	6	A	2.70	3.34	13.77	34.92	36.07	37.82	41.89	13,080			
EMBPE3010-36-09-ATH	●	0.9	36	0.8	0.94	2.045	80	6	A	2.70	3.2	13.77	36.94	38.18	40.03	44.35	13,080			
EMBPE3015-8-09-ATH	●	0.9	8	1.35	1.42	1.628	55	6	A	3.89	7.32	8.54	8.77	9.1	9.35	9.97	10,830			
EMBPE3015-10-09-ATH	●	0.9	10	1.35	1.42	1.691	55	6	A	3.89	6.63	10.5	10.79	11.17	11.46	12.43	10,830			
EMBPE3015-14-09-ATH	●	0.9	14	1.35	1.42	1.817	60	6	A	3.89	5.57	14.39	14.83	15.31	15.71	17.35	10,940			
EMBPE3015-16-09-ATH	●	0.9	16	1.35	1.42	1.880	60	6	A	3.89	5.16	16.33	16.84	17.37	17.93	19.8	10,940			
EMBPE3015-18-09-ATH	●	0.9	18	1.35	1.42	1.943	65	6	A	3.89	4.81	18.24	18.86	19.43	20.14	22.26	10,940			
EMBPE3015-20-09-ATH	●	0.9	20	1.35	1.42	2.005	65	6	A	3.89	4.5	19.64	20.88	21.49	22.36	24.72	11,370			
EMBPE3015-22-09-ATH	●	0.9	22	1.35	1.42	2.068	70	6	A	3.89	4.22	19.64	22.89	23.55	24.57	27.18	12,110			
EMBPE3015-24-09-ATH	●	0.9	24	1.35	1.42	2.131	70	6	A	3.89	3.98	19.64	24.91	25.6	26.79	29.64	12,220			
EMBPE3015-26-09-ATH	●	0.9	26	1.35	1.42	2.194	70	6	A	3.89	3.77	19.64	26.93	27.68	29.01	32.1	13,390			
EMBPE3015-28-09-ATH	●	0.9	28	1.35	1.42	2.257	75	6	A	3.89	3.58	19.64	28.94	29.79	31.22	34.55	13,610			
EMBPE3015-30-09-ATH	●	0.9	30	1.35	1.42	2.320	75	6	A	3.89	3.4	19.64	30.96	31.91	33.44	37.01	14,250			
EMBPE3015-32-09-ATH	●	0.9	32	1.35	1.42	2.382	80	6	A	3.89	3.24	19.64	32.97	34.02	35.66	39.47	14,680			
EMBPE3015-34-09-ATH	●	0.9	34	1.35	1.42	2.445	80	6	A	3.89	3.1	19.64	34.99	36.13	37.87	41.93	14,790			
EMBPE3015-36-09-ATH	●	0.9	36	1.35	1.42	2.508	80	6	A	3.89	2.97	19.64	37	38.24	40.09	干渉なし	14,890			
EMBPE3015-38-09-ATH	●	0.9	38	1.35	1.42	2.571	85	6	A	3.89	2.85	19.64	39.02	40.36	42.3	干渉なし	15,110			
EMBPE3015-40-09-ATH	●	0.9	40	1.35	1.42	2.634	85	6	A	3.89	2.74	19.64	41.03	42.47	44.52	干渉なし	15,320			
EMBPE3020-10-09-ATH	●	0.9	10	1.7	1.92	2.180	55	6	A	4.24	6.35	10.52	10.8	11.17	11.45	12.38	10,830			
EMBPE3020-16-09-ATH	●	0.9	16	1.7	1.92	2.369	60	6	A	4.24	4.86	16.36	16.85	17.37	17.91	19.76	10,940			
EMBPE3020-20-09-ATH	●	0.9	20	1.7	1.92	2.494	65	6	A	4.24	4.2	20.16	20.88	21.49	22.34	24.68	11,040			
EMBPE3020-24-09-ATH	●	0.9	24	1.7	1.92	2.620	65	6	A	4.24	3.7	20.5	24.92	25.6	26.77	29.59	11,680			
EMBPE3020-30-09-ATH	●	0.9	30	1.7	1.92	2.809	70	6	A	4.24	3.14	20.5	30.96	31.9	33.42	36.97	12,440			
EMBPE3020-36-09-ATH	●	0.9	36	1.7	1.92	2.997	80	6	A	4.24	2.73	20.5	37.01	38.24	40.07	干渉なし	16,070			
EMBPE3020-40-09-ATH	●	0.9	40	1.7	1.92	3.123	80	6	A	4.24	2.51	20.5	41.03	42.46	44.5	干渉なし	16,500			
EMBPE3020-46-09-ATH	●	0.9	46	1.7	1.92	3.311	90	6	A	4.24	2.24	20.5	47.08	48.8	51.15	干渉なし	18,640			
EMBPE3020-60-09-ATH	●	0.9	60	1.7	1.92	3.751	100	6	A	4.24	1.79	20.5	61.16	63.59	干渉なし	干渉なし	19,500			
EMBPE3025-16-09-ATH	●	0.9	16	2	2.4	2.839	60	6	A	5.18	4.52	16.48	16.9	17.4	17.94	19.77	11,370			
EMBPE3025-24-09-ATH	●	0.9	24	2	2.4	3.091	65	6	A	5.18	3.39	24.19	24.96	25.62	26.81	29.6	12,750			
EMBPE3025-30-09-ATH	●	0.9	30	2	2.4	3.279	70	6	A	5.18	2.86	24.88	31.01	31.94	33.46	干渉なし	14,040			
EMBPE3025-40-09-ATH	●	0.9	40	2	2.4	3.593	80	6	A	5.18	2.26	24.88	41.07	42.51	44.54	干渉なし	15,530			
EMBPE3025-50-09-ATH	●	0.9	50	2	2.4	3.908	90	6	A	5.18	1.87	24.88	51.14	53.07	干渉なし	干渉なし	18,000			
EMBPE3030-16-09-ATH	●	0.9	16	2.5	2.86	3.284	55	6	A	6.95	4.11	16.67	17	17.46	18.05	19.87	11,370			
EMBPE3030-20-09-ATH	●	0.9	20	2.5	2.86	3.409	60	6	A	6.95	3.5	20.59	21.03	21.57	22.48	24.78	13,390			
EMBPE3030-24-09-ATH	●	0.9	24	2.5	2.86	3.535	65	6	A	6.95	3.04	24.51	25.06	25.72	26.92	29.7	13,510			
EMBPE3030-30-09-ATH	●	0.9	30	2.5	2.86	3.724	70	6	A	6.95	2.54	30.35	31.1	32.06	33.56	干渉なし	14,040			
EMBPE3030-40-09-ATH	●	0.9	40	2.5	2.86	4.038	80	6	A	6.95	2	34.28	41.16	42.62	干渉なし	干渉なし	15,530			
EMBPE3030-50-09-ATH	●	0.9	50	2.5	2.86	4.352	90	6	A	6.95	1.65	34.28	51.22	53.18	干渉なし	干渉なし	18,000			
EMBPE3030-60-09-ATH	●	0.9	60	2.5	2.86	4.666	100	6	A	6.95	1.4	34.28	61.28	干渉なし	干渉なし	干渉なし	19,820			

Carbide End Mills
 Ball End Mills

■首形状詳細 Detail of neck shape

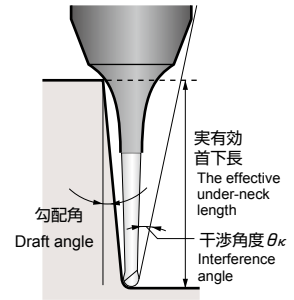
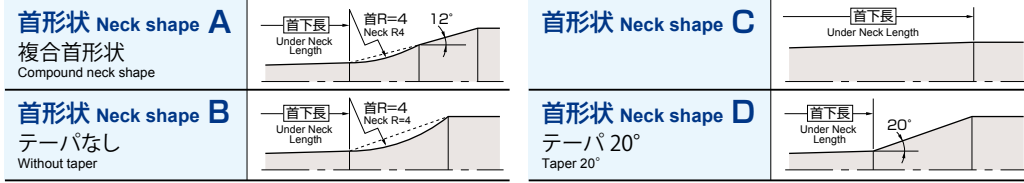

EMBPE3-ATH

商品コード Item code	在庫 Stock	寸法 Size(mm)											干渉角度 Interference angle (°)		勾配角に対する実有効首下長 Effective under neck length with respect to draft angle					希望小売 価格 (円) Suggested retail price (¥)
		ボール半径 Ball radius	外径 Tool dia.	首部 テーパー角 Neck angle	首下長 Under neck length	刃長 Flute length	首径 Neck dia.	首元径 Under neck dia.	全長 Overall length	シャンク径 Shank dia.	首形状 Neck shape	仮想首長 Approx neck length	θ'	θ_k	0.75°	1°	1.5°	2°	3°	
		RE	DC	BHTA2	LU	APMX	BD2	BD3	LF	DCONMS		\varnothing'								
EMBPE3035-20-09-ATH	●	1.75	3.5	0.9	20	2.75	3.36	3.901	60	6	A	7.20	3.09	20.6	21.03	21.56	22.46	24.73	13,610	
EMBPE3035-30-09-ATH	●			0.9	30	2.75	3.36	4.216	70	6	A	7.20	2.21	30.36	31.1	32.05	33.54	干涉なし	13,610	
EMBPE3035-40-09-ATH	●			0.9	40	2.75	3.36	4.530	80	6	A	7.20	1.72	34.53	41.16	42.61	干涉なし	干涉なし	17,360	
EMBPE3035-50-09-ATH	●			0.9	50	2.75	3.36	4.844	90	6	A	7.20	1.41	34.53	51.22	干涉なし	干涉なし	干涉なし	20,470	
EMBPE3035-60-09-ATH	●			0.9	60	2.75	3.36	5.158	100	6	B	7.20	1.19	34.53	61.27	干涉なし	干涉なし	干涉なし	22,390	
EMBPE3040-20-09-ATH	●	2	4	0.9	20	6	3.9	4.339	70	6	A	—	2.62	20.77	21.13	21.62	22.58	干涉なし	13,610	
EMBPE3040-30-09-ATH	●			0.9	30	6	3.9	4.654	80	6	A	—	1.84	30.61	31.19	32.18	干涉なし	干涉なし	13,720	
EMBPE3040-40-09-ATH	●			0.9	40	6	3.9	4.968	90	6	B	—	1.42	40.38	41.25	干涉なし	干涉なし	干涉なし	17,360	
EMBPE3040-50-09-ATH	●			0.9	50	6	3.9	5.282	100	6	B	—	1.16	45.15	51.3	干涉なし	干涉なし	干涉なし	19,820	
EMBPE3040-60-09-ATH	●			0.9	60	6	3.9	5.596	110	6	B	—	0.97	45.15	干涉なし	干涉なし	干涉なし	干涉なし	19,820	
EMBPE3040-70-09-ATH	●			0.9	70	6	3.9	5.910	120	8	A	—	1.58	45.15	71.4	74.43	干涉なし	干涉なし	干涉なし	24,860
EMBPE3040-80-09-ATH	●			0.9	80	6	3.9	6.224	130	8	A	—	1.4	45.15	81.45	干涉なし	干涉なし	干涉なし	24,860	
EMBPE3050-30-09-ATH	●			2.5	5	0.9	30	7.5	4.9	5.606	80	8	A	—	2.6	30.72	31.24	32.24	33.7	干涉なし
EMBPE3050-40-09-ATH	●	0.9	40			7.5	4.9	5.921	90	8	A	—	2.03	40.54	41.29	42.8	44.78	干涉なし	22,000	
EMBPE3050-50-09-ATH	●	0.9	50			7.5	4.9	6.235	100	8	A	—	1.67	50.24	51.35	53.36	干涉なし	干涉なし	23,570	
EMBPE3050-60-09-ATH	●	0.9	60			7.5	4.9	6.549	110	8	A	—	1.42	51.67	61.4	干涉なし	干涉なし	干涉なし	23,800	
EMBPE3050-70-09-ATH	●	0.9	70			7.5	4.9	6.863	120	8	A	—	1.23	51.67	71.45	干涉なし	干涉なし	干涉なし	27,270	
EMBPE3050-80-09-ATH	●	0.9	80	7.5	4.9	7.177	130	8	B	—	1.09	51.67	81.49	干涉なし	干涉なし	干涉なし	30,300			
EMBPE3060-30-09-ATH	●	3	6	0.9	30	9	5.9	6.559	80	8	A	—	1.89	30.81	31.29	32.29	干涉なし	干涉なし	21,440	
EMBPE3060-40-09-ATH	●			0.9	40	9	5.9	6.873	90	8	B	—	1.45	40.66	41.34	干涉なし	干涉なし	干涉なし	22,900	
EMBPE3060-50-09-ATH	●			0.9	50	9	5.9	7.188	100	8	B	—	1.18	50.46	51.39	干涉なし	干涉なし	干涉なし	25,030	
EMBPE3060-60-09-ATH	●			0.9	60	9	5.9	7.502	110	8	B	—	0.99	58.18	干涉なし	干涉なし	干涉なし	干涉なし	28,510	
EMBPE3060-70-09-ATH	●			0.9	70	9	5.9	7.816	120	10	A	—	1.59	58.18	71.48	74.54	干涉なし	干涉なし	干涉なし	36,590
EMBPE3060-80-09-ATH	●			0.9	80	9	5.9	8.130	130	10	A	—	1.41	58.18	81.53	干涉なし	干涉なし	干涉なし	38,040	
EMBPE3060-100-09-ATH	●			0.9	100	9	5.9	8.759	150	10	A	—	1.15	58.18	101.61	干涉なし	干涉なし	干涉なし	44,320	
EMBPE3060-120-09-ATH	●			0.9	120	9	5.9	9.387	200	10	B	—	0.97	58.18	干涉なし	干涉なし	干涉なし	干涉なし	52,520	
EMBPE3080-40-09-ATH	●	4	8	0.9	40	12	7.9	8.779	100	10	A	—	1.48	40.85	41.42	干涉なし	干涉なし	干涉なし	28,400	
EMBPE3080-50-09-ATH	●			0.9	50	12	7.9	9.093	110	10	B	—	1.2	50.71	51.47	干涉なし	干涉なし	干涉なし	30,190	
EMBPE3080-60-09-ATH	●			0.9	60	12	7.9	9.408	120	10	B	—	1	60.53	干涉なし	干涉なし	干涉なし	干涉なし	32,100	
EMBPE3080-70-09-ATH	●			0.9	70	12	7.9	9.722	130	10	B	—	0.86	70.22	干涉なし	干涉なし	干涉なし	干涉なし	33,900	
EMBPE3080-80-09-ATH	●			0.9	80	12	7.9	10.036	140	12	A	—	1.43	71.21	81.6	干涉なし	干涉なし	干涉なし	41,860	
EMBPE3080-100-09-ATH	●			0.9	100	12	7.9	10.664	160	12	A	—	1.16	71.21	101.76	干涉なし	干涉なし	干涉なし	48,930	
EMBPE3080-120-09-ATH	●			0.9	120	12	7.9	11.293	200	12	B	—	0.98	71.21	干涉なし	干涉なし	干涉なし	干涉なし	48,930	
EMBPE3100-50-09-ATH	●			5	10	0.9	50	15	9.9	10.999	120	12	B	—	1.21	50.89	51.55	干涉なし	干涉なし	干涉なし
EMBPE3100-60-09-ATH	●	0.9	60			15	9.9	11.313	130	12	B	—	1.02	60.76	61.59	干涉なし	干涉なし	干涉なし	39,620	
EMBPE3100-75-09-ATH	●	0.9	75			15	9.9	11.785	140	12	B	—	0.81	75.49	干涉なし	干涉なし	干涉なし	干涉なし	41,860	
EMBPE3100-81-09-ATH	●	0.9	81			15	9.9	12.000	150	12	C	—	0.76	81.04	干涉なし	干涉なし	干涉なし	干涉なし	51,180	
EMBPE3100-100-09-ATH	●	0.9	100			15	9.9	12.570	170	16	D	—	1.73	84.25	101.07	103.56	干涉なし	干涉なし	干涉なし	65,760
EMBPE3100-120-09-ATH	●	0.9	120	15	9.9	13.198	200	16	D	—	1.45	84.25	121.17	干涉なし	干涉なし	干涉なし	干涉なし	71,480		
EMBPE3120-60-09-ATH	●	6	12	0.9	60	18	11.9	13.219	140	16	D	—	1.99	60.27	60.96	62.38	干涉なし	干涉なし	57,010	
EMBPE3120-80-09-ATH	●			0.9	80	18	11.9	13.847	160	16	D	—	1.49	80.12	81.06	干涉なし	干涉なし	干涉なし	62,620	
EMBPE3120-100-09-ATH	●			0.9	100	18	11.9	14.476	180	16	D	—	1.2	97.28	101.16	干涉なし	干涉なし	干涉なし	68,230	
EMBPE3120-120-09-ATH	●			0.9	120	18	11.9	15.104	200	16	D	—	1	97.28	干涉なし	干涉なし	干涉なし	干涉なし	73,620	

○ 対応被削材 Applicable work material

炭素鋼 合金鋼 Carbon steel Alloy steel	プリハー ド鋼 Pre-hardened steel	高硬度 Hardened steel			ステン レス鋼 Stainless steel	チタン合金 耐熱合金 Titanium alloy Heat-resistant alloy	銅合金 Copper alloy	アルミ 合金 Aluminum alloy
○	○	> 45HRC ≤ 55HRC	> 55HRC ≤ 65HRC	> 65HRC	○	○	○	○

● : 標準在庫品です。 ● : Stocked items. 干涉なし : No interference

○ 再研磨対応外径範囲 Re-grinding compatibility range

商品コード Item code	外周 Outer dia. (mm)	エンド End (mm)
EMBPE-ATH	× (N/A)	4 ~ 12

[注意] EMBPE-ATH は特殊刃型のため首下長さが10DC以上の工具の再研磨はできませんのでご了承ください。

[Note] EMBPE-ATH has a special flute shape. Because of this, regrinding is not possible for tools with an under neck length of more than 10DC

標準切削条件表 Recommended cutting conditions

EMBE-ATH

ストレートタイプ
Straight type

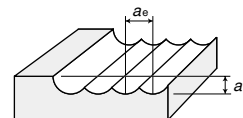

〈荒加工〉 Roughing

被削材 Work material		炭素鋼・合金鋼 Carbon steels, Alloy steels (180~250HB) S50C, S55C				工具鋼 Tool steels (25~40HRC) HPM7, SCM440, SKD61, SKT4				プリハードン鋼・焼入れ鋼 Pre-hardened steels, Hardened steels (40~50HRC)							
		快削材料 Free-cutting materials SKD61, CENAI, HPM-MAGIC, NAK80				高靱性材料 High-toughness materials DAC-MAGIC, DAC55, DH31											
ボール半径 RE Ball radius (mm)	外径 DC Tool dia. (mm)	回転数 n min ⁻¹	送り速度 vf mm/min	ap mm	ae mm	回転数 n min ⁻¹	送り速度 vf mm/min	ap mm	ae mm	回転数 n min ⁻¹	送り速度 vf mm/min	ap mm	ae mm	回転数 n min ⁻¹	送り速度 vf mm/min	ap mm	ae mm
0.5	1	50,000	2,360	0.100	0.300	50,000	2,360	0.100	0.300	50,000	2,230	0.100	0.300	28,700	1,160	0.060	0.180
0.75	1.5	46,700	3,530	0.150	0.450	42,500	3,210	0.150	0.450	38,200	2,720	0.150	0.450	19,100	1,240	0.090	0.270
1	2	35,000	3,750	0.200	0.600	31,800	3,410	0.200	0.600	28,700	2,900	0.200	0.600	14,300	1,310	0.120	0.360
1.25	2.5	28,000	3,810	0.250	0.750	25,500	3,470	0.250	0.750	22,900	2,940	0.250	0.750	11,500	1,340	0.150	0.450
1.5	3	23,400	3,890	0.300	0.900	21,200	3,530	0.300	0.900	19,100	3,000	0.300	0.900	9,600	1,370	0.180	0.540
1.75	3.5	20,000	4,010	0.350	1.050	18,200	3,650	0.350	1.050	16,400	3,100	0.350	1.050	8,200	1,410	0.210	0.630
2	4	17,500	4,100	0.400	1.200	15,900	3,730	0.400	1.200	14,300	3,160	0.400	1.200	7,200	1,450	0.240	0.720
2.5	5	14,000	4,280	0.500	1.500	12,700	3,880	0.500	1.500	11,500	3,310	0.500	1.500	5,700	1,490	0.300	0.900
3	6	11,700	4,420	0.600	1.800	10,600	4,010	0.600	1.800	9,600	3,420	0.600	1.800	4,800	1,560	0.360	1.080
4	8	8,800	4,660	0.800	2.400	8,000	4,230	0.800	2.400	7,200	3,590	0.800	2.400	3,600	1,630	0.480	1.440
5	10	7,000	4,850	1.000	3.000	6,400	4,440	1.000	3.000	5,700	3,720	1.000	3.000	2,900	1,720	0.600	1.800
6	12	5,800	4,600	1.200	3.600	5,300	4,210	1.200	3.600	4,800	3,590	1.200	3.600	2,400	1,630	0.720	2.160
8	16	4,400	4,440	1.600	4.800	4,000	4,030	1.600	4.800	3,600	3,420	1.600	4.800	1,800	1,560	0.960	2.880
10	20	3,500	3,880	2.000	6.000	3,200	3,550	2.000	6.000	2,900	3,030	2.000	6.000	1,400	1,330	1.200	3.600

被削材 Work material		焼入れ鋼 Hardened steels (50~55HRC) HPM38, SKD61				焼入れ鋼 Hardened steels (55~65HRC) SKD11, YXR3, YXR33			
		回転数 n min ⁻¹	送り速度 vf mm/min	ap mm	ae mm	回転数 n min ⁻¹	送り速度 vf mm/min	ap mm	ae mm
ボール半径 RE Ball radius (mm)	外径 DC Tool dia. (mm)								
0.5	1	50,000	1,870	0.070	0.210	44,600	1,250	0.050	0.150
0.75	1.5	34,000	2,030	0.105	0.315	29,700	1,340	0.075	0.225
1	2	25,500	2,160	0.140	0.420	22,300	1,420	0.100	0.300
1.25	2.5	20,400	2,200	0.175	0.525	17,800	1,440	0.125	0.375
1.5	3	17,000	2,240	0.210	0.630	14,900	1,480	0.150	0.450
1.75	3.5	14,600	2,320	0.245	0.735	12,700	1,520	0.175	0.525
2	4	12,700	2,350	0.280	0.840	11,100	1,550	0.200	0.600
2.5	5	10,200	2,460	0.350	1.050	8,900	1,620	0.250	0.750
3	6	8,500	2,540	0.420	1.260	7,400	1,670	0.300	0.900
4	8	6,400	2,680	0.560	1.680	5,600	1,760	0.400	1.200
5	10	5,100	2,790	0.700	2.100	4,500	1,860	0.500	1.500
6	12	4,200	2,640	0.840	2.520	3,700	1,750	0.600	1.800
8	16	3,200	2,550	1.120	3.360	2,800	1,680	0.800	2.400
10	20	2,500	2,190	1.400	4.200	2,200	1,450	1.000	3.000

- 【注意】**
- ①被削材、加工形状に合わせて、適切なクーラントを使用してください。
 - ②できるだけ高剛性、高精度の機械をご使用ください。
 - ③この切削条件表は切削条件の目安を示すものです。実際の加工では加工形状、目的、使用機械等により条件を調整してください。
 - ④機械の回転数が足りない場合には、回転数と送り速度を同じ比率で下げてください。

- 【Note】**
- ① Use the appropriate coolant for the work material and machining shape.
 - ② Use as highly rigid and accurate machine as possible.
 - ③ These conditions are for general guidance; in actual machining conditions adjust the parameters according to your actual machine and work-piece conditions.
 - ④ If the rpm available is lower than that recommended please reduce the feed rate to the same ratio.

EMBE-ATH

ストレートタイプ
Straight type

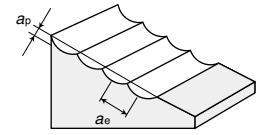

〈仕上げ加工〉 Finishing

被削材 Work material		炭素鋼・合金鋼 Carbon steels, Alloy steels (180~250HB) S50C, S55C				工具鋼 Tool steels (25~40HRC) HPM7, SCM440, SKD61, SKT4				プリハードン鋼・焼入れ鋼 Pre-hardened steels, Hardened steels (40~50HRC) SKD61, CENA1, HPM-MAGIC, NAK80 DAC-MAGIC, DAC55, DH31			
ボール半径 RE Ball radius (mm)	外径 DC Tool dia. (mm)	回転数 n min ⁻¹	送り速度 vf mm/min	ap mm	ae mm	回転数 n min ⁻¹	送り速度 vf mm/min	ap mm	ae mm	回転数 n min ⁻¹	送り速度 vf mm/min	ap mm	ae mm
0.5	1	50,000	1,640	0.02~0.05	0.02	50,000	1,640	0.02~0.05	0.02	50,000	1,550	0.02~0.05	0.02
0.75	1.5	50,000	2,630	0.02~0.07	0.03	50,000	2,630	0.02~0.07	0.03	50,000	2,480	0.02~0.07	0.03
1	2	47,800	3,560	0.02~0.10	0.04	44,600	3,320	0.02~0.10	0.04	41,400	2,910	0.02~0.10	0.04
1.25	2.5	38,200	3,680	0.05~0.12	0.05	35,700	3,440	0.05~0.12	0.05	33,100	3,010	0.05~0.12	0.05
1.5	3	31,800	3,840	0.05~0.15	0.06	29,700	3,590	0.05~0.15	0.06	27,600	3,150	0.05~0.15	0.06
1.75	3.5	27,300	3,890	0.05~0.15	0.07	25,500	3,640	0.05~0.15	0.07	23,700	3,190	0.05~0.15	0.07
2	4	23,900	3,940	0.05~0.20	0.08	22,300	3,670	0.05~0.20	0.08	20,700	3,220	0.05~0.20	0.08
2.5	5	19,100	4,060	0.05~0.25	0.1	17,800	3,780	0.05~0.25	0.1	16,600	3,330	0.05~0.25	0.1
3	6	15,900	4,180	0.05~0.3	0.12	14,900	3,920	0.05~0.3	0.12	13,800	3,430	0.05~0.3	0.12
4	8	11,900	4,380	0.05~0.4	0.16	11,100	4,080	0.05~0.4	0.16	10,400	3,620	0.05~0.4	0.16
5	10	9,600	4,330	0.05~0.5	0.2	8,900	4,020	0.05~0.5	0.2	8,300	3,540	0.05~0.5	0.2
6	12	8,000	4,290	0.05~0.6	0.24	7,400	3,970	0.05~0.6	0.24	6,900	3,500	0.05~0.6	0.24
8	16	6,000	3,990	0.05~0.8	0.32	5,600	3,730	0.05~0.8	0.32	5,200	3,270	0.05~0.8	0.32
10	20	4,800	3,700	0.05~1.0	0.4	4,500	3,470	0.05~1.0	0.4	4,100	2,990	0.05~1.0	0.4

被削材 Work material		焼入れ鋼 Hardened steels (50~55HRC) HPM38, SKD61				焼入れ鋼 Hardened steels (55~65HRC) SKD11, YXR3, YXR33			
ボール半径 RE Ball radius (mm)	外径 DC Tool dia. (mm)	回転数 n min ⁻¹	送り速度 vf mm/min	ap mm	ae mm	回転数 n min ⁻¹	送り速度 vf mm/min	ap mm	ae mm
0.5	1	50,000	1,320	0.02~0.05	0.02	50,000	990	0.02~0.05	0.02
0.75	1.5	44,600	1,880	0.02~0.07	0.03	38,200	1,210	0.02~0.07	0.03
1	2	33,400	1,990	0.02~0.10	0.04	28,700	1,290	0.02~0.10	0.04
1.25	2.5	26,800	2,070	0.05~0.12	0.05	22,900	1,330	0.05~0.12	0.05
1.5	3	22,300	2,160	0.05~0.15	0.06	19,100	1,390	0.05~0.15	0.06
1.75	3.5	19,100	2,180	0.05~0.15	0.07	16,400	1,410	0.05~0.15	0.07
2	4	16,700	2,200	0.05~0.20	0.08	14,300	1,420	0.05~0.20	0.08
2.5	5	13,400	2,280	0.05~0.25	0.1	11,500	1,470	0.05~0.25	0.1
3	6	11,100	2,340	0.05~0.3	0.12	9,600	1,520	0.05~0.3	0.12
4	8	8,400	2,480	0.05~0.4	0.16	7,200	1,600	0.05~0.4	0.16
5	10	6,700	2,420	0.05~0.5	0.2	5,700	1,550	0.05~0.5	0.2
6	12	5,600	2,410	0.05~0.6	0.24	4,800	1,550	0.05~0.6	0.24
8	16	4,200	2,240	0.05~0.8	0.32	3,600	1,440	0.05~0.8	0.32
10	20	3,300	2,040	0.05~1.0	0.4	2,900	1,350	0.05~1.0	0.4

超硬ボールエンドミル
ボールエンドミル

EMBE-ATH

ストレートタイプ
Straight type

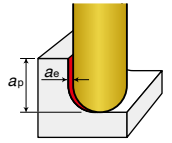

Carbide End Mills
Ball End Mills

〈側面加工〉 Side cutting

被削材 Work material		炭素鋼・合金鋼 Carbon steels, Alloy steels (180~250HB) S50C, S55C				工具鋼 Tool steels (25~40HRC) HPM7, SCM440, SKD61, SKT4				プリハードン鋼・焼入れ鋼 Pre-hardened steels, Hardened steels (40~50HRC)							
		快削材料 Free-cutting materials SKD61, CENA1, HPM-MAGIC, NAK80				高靱性材料 High-toughness materials DAC-MAGIC, DAC55, DH31											
ボール半径 RE Ball radius (mm)	外径 DC Tool dia. (mm)	回転数 n min ⁻¹	送り速度 vf mm/min	ap mm	ae mm	回転数 n min ⁻¹	送り速度 vf mm/min	ap mm	ae mm	回転数 n min ⁻¹	送り速度 vf mm/min	ap mm	ae mm	回転数 n min ⁻¹	送り速度 vf mm/min	ap mm	ae mm
0.5	1	50,000	2,700	1.0	0.100	50,000	2,480	1.0	0.075	50,000	2,230	1.0	0.050	28,700	1,160	1.0	0.050
0.75	1.5	38,200	3,300	1.5	0.150	38,200	3,030	1.5	0.113	38,200	2,720	1.5	0.075	19,100	1,240	1.5	0.075
1	2	28,700	3,510	2.0	0.200	28,700	3,220	2.0	0.150	28,700	2,900	2.0	0.100	14,300	1,310	2.0	0.100
1.25	2.5	22,900	3,570	2.5	0.250	22,900	3,270	2.5	0.188	22,900	2,940	2.5	0.125	11,500	1,340	2.5	0.125
1.5	3	19,100	3,630	3.0	0.300	19,100	3,330	3.0	0.225	19,100	3,000	3.0	0.150	9,600	1,370	3.0	0.150
1.75	3.5	16,400	3,760	3.5	0.350	16,400	3,450	3.5	0.263	16,400	3,100	3.5	0.175	8,200	1,410	3.5	0.175
2	4	14,300	3,830	4.0	0.400	14,300	3,510	4.0	0.300	14,300	3,160	4.0	0.200	7,200	1,450	4.0	0.200
2.5	5	11,500	4,020	5.0	0.500	11,500	3,680	5.0	0.375	11,500	3,310	5.0	0.250	5,700	1,490	5.0	0.250
3	6	9,600	4,150	6.0	0.600	9,600	3,800	6.0	0.450	9,600	3,420	6.0	0.300	4,800	1,560	6.0	0.300
4	8	7,200	4,350	8.0	0.800	7,200	3,990	8.0	0.600	7,200	3,590	8.0	0.400	3,600	1,630	8.0	0.400
5	10	5,700	4,510	10.0	1.000	5,700	4,140	10.0	0.750	5,700	3,720	10.0	0.500	2,900	1,720	10.0	0.500
6	12	4,800	4,350	12.0	1.200	4,800	3,990	12.0	0.900	4,800	3,590	12.0	0.600	2,400	1,630	12.0	0.600
8	16	3,600	4,150	16.0	1.600	3,600	3,800	16.0	1.200	3,600	3,420	16.0	0.800	1,800	1,560	16.0	0.800
10	20	2,900	3,670	20.0	2.000	2,900	3,370	20.0	1.500	2,900	3,030	20.0	1.000	1,400	1,330	20.0	1.000

被削材 Work material		焼入れ鋼 Hardened steels (50~55HRC) HPM38, SKD61				焼入れ鋼 Hardened steels (55~65HRC) SKD11, YXR3, YXR33			
		回転数 n min ⁻¹	送り速度 vf mm/min	ap mm	ae mm	回転数 n min ⁻¹	送り速度 vf mm/min	ap mm	ae mm
0.5	1	50,000	1,870	1.0	0.050	44,600	1,210	1.0	0.02
0.75	1.5	34,000	2,030	1.5	0.075	29,700	1,290	1.5	0.03
1	2	25,500	2,160	2.0	0.100	22,300	1,380	2.0	0.04
1.25	2.5	20,400	2,200	2.5	0.125	17,800	1,400	2.5	0.05
1.5	3	17,000	2,240	3.0	0.150	14,900	1,430	3.0	0.06
1.75	3.5	14,600	2,320	3.5	0.175	12,700	1,470	3.5	0.07
2	4	12,700	2,350	4.0	0.200	11,100	1,500	4.0	0.08
2.5	5	10,200	2,460	5.0	0.250	8,900	1,570	5.0	0.10
3	6	8,500	2,540	6.0	0.300	7,400	1,610	6.0	0.12
4	8	6,400	2,680	8.0	0.400	5,600	1,710	8.0	0.16
5	10	5,100	2,790	10.0	0.500	4,500	1,800	10.0	0.20
6	12	4,200	2,640	12.0	0.600	3,700	1,690	12.0	0.24
8	16	3,200	2,550	16.0	0.800	2,800	1,630	16.0	0.32
10	20	2,500	2,190	20.0	1.000	2,200	1,410	20.0	0.40

	~62HRC	62~65HRC
ヘリカル穴加工時の傾斜角 Slant angle for helical boring	1°	0.5°
ヘリカル穴加工時の送り速度 Feed rate for helical boring	側面加工条件の 70% 70% of side cutting conditions	

※ヘリカル穴加工時の穴径は、工具径の1.6倍以上2.0倍未満に設定ください。
※ヘリカル穴加工時の最大深さは工具径以下(1DC以下)に設定ください。
※Set the hole diameter for helical boring to between 1.6 and 2.0 times the tool diameter.
※Set the maximum depth for helical boring to the tool diameter or smaller (≤ 1DC).

- 【注意】**
- ①被削材、加工形状に合わせて、適切なクーラントを使用してください。
 - ②できるだけ高剛性、高精度の機械をご使用ください。
 - ③この切削条件表は切削条件の目安を示すものです。実際の加工では加工形状、目的、使用機械等により条件を調整してください。
 - ④機械の回転数が足りない場合には、回転数と送り速度を同じ比率で下げてください。
- 【Note】**
- ① Use the appropriate coolant for the work material and machining shape.
 - ② Use as highly rigid and accurate machine as possible.
 - ③ These conditions are for general guidance; in actual machining conditions adjust the parameters according to your actual machine and work-piece conditions.
 - ④ If the rpm available is lower than that recommended please reduce the feed rate to the same ratio.

EMBPE-ATH

ペンシルタイプ
Pencil type

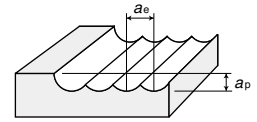

〈荒加工〉 Roughing

被削材 Work material			炭素鋼・合金鋼 Carbon steels, Alloy steels (180~250HB) S50C, S55C				工具鋼 Tool steels (25~40HRC) HPM7, SCM440, SKD61, SKT4				プリハードン鋼・焼入れ鋼 Pre-hardened steels, Hardened steels (40~50HRC)							
			快削材料 Free-cutting materials SKD61, CEN1, HPM-MAGIC, NAK80				高靱性材料 High-toughness materials DAC-MAGIC, DAC55, DH31											
ボール半径 RE Ball radius (mm)	外径 DC Tool dia. (mm)	首下長 LU Under neck length (mm)	回転数 n min ⁻¹	送り速度 vf mm/min	ap mm	ae mm	回転数 n min ⁻¹	送り速度 vf mm/min	ap mm	ae mm	回転数 n min ⁻¹	送り速度 vf mm/min	ap mm	ae mm	回転数 n min ⁻¹	送り速度 vf mm/min	ap mm	ae mm
0.5	1	6	50,000	2,160	0.090	0.270	50,000	2,160	0.090	0.270	48,000	1,940	0.090	0.270	26,700	1,080	0.081	0.243
		8	50,000	2,160	0.090	0.270	50,000	2,160	0.090	0.270	48,000	1,940	0.090	0.270	26,700	1,080	0.081	0.243
		10	50,000	2,160	0.080	0.240	48,700	2,100	0.080	0.240	43,900	1,780	0.080	0.240	24,400	990	0.072	0.216
		12	49,700	1,910	0.070	0.210	44,700	1,720	0.070	0.210	40,200	1,450	0.070	0.210	22,400	810	0.063	0.189
		14	44,600	1,710	0.060	0.180	40,100	1,540	0.060	0.180	36,100	1,300	0.060	0.180	20,100	720	0.054	0.162
		16	44,600	1,710	0.060	0.180	40,100	1,540	0.060	0.180	36,100	1,300	0.060	0.180	20,100	720	0.054	0.162
		18	40,100	1,540	0.050	0.150	36,100	1,390	0.050	0.150	32,500	1,170	0.050	0.150	18,100	650	0.045	0.135
		20	40,100	1,540	0.050	0.150	36,100	1,390	0.050	0.150	32,500	1,170	0.050	0.150	18,100	650	0.045	0.135
		22	35,000	1,340	0.040	0.120	31,500	1,210	0.040	0.120	28,400	1,020	0.040	0.120	15,800	570	0.036	0.108
		24	30,600	1,180	0.030	0.090	27,500	1,060	0.030	0.090	24,800	890	0.030	0.090	13,800	500	0.027	0.081
		26	30,600	1,180	0.030	0.090	27,500	1,060	0.030	0.090	24,800	890	0.030	0.090	13,800	500	0.027	0.081
		28	25,500	860	0.020	0.060	22,900	770	0.020	0.060	20,600	650	0.020	0.060	11,500	360	0.018	0.054
		30	25,500	860	0.020	0.060	22,900	770	0.020	0.060	20,600	650	0.020	0.060	11,500	360	0.018	0.054
		32	21,000	710	0.010	0.030	18,900	640	0.010	0.030	17,000	540	0.010	0.030	9,500	300	0.009	0.027
34	15,900	530	0.005	0.015	14,300	480	0.005	0.015	12,900	410	0.005	0.015	7,200	230	0.005	0.014		
36	15,900	530	0.005	0.015	14,300	480	0.005	0.015	12,900	410	0.005	0.015	7,200	230	0.005	0.014		
0.75	1.5	8	39,500	2,670	0.135	0.405	35,500	2,400	0.135	0.405	32,000	2,070	0.135	0.405	17,800	1,150	0.122	0.365
		10	39,500	2,670	0.135	0.405	35,500	2,400	0.135	0.405	32,000	2,070	0.135	0.405	17,800	1,150	0.122	0.365
		14	36,100	2,440	0.120	0.360	32,500	2,190	0.120	0.360	29,200	1,890	0.120	0.360	16,200	1,050	0.108	0.324
		16	33,100	1,990	0.105	0.315	29,800	1,790	0.105	0.315	26,800	1,540	0.105	0.315	14,900	860	0.095	0.284
		18	33,100	1,990	0.105	0.315	29,800	1,790	0.105	0.315	26,800	1,540	0.105	0.315	14,900	860	0.095	0.284
		20	29,700	1,780	0.090	0.270	26,800	1,610	0.090	0.270	24,100	1,390	0.090	0.270	13,400	770	0.081	0.243
		22	29,700	1,780	0.090	0.270	26,800	1,610	0.090	0.270	24,100	1,390	0.090	0.270	13,400	770	0.081	0.243
		24	29,700	1,780	0.090	0.270	26,800	1,610	0.090	0.270	24,100	1,390	0.090	0.270	13,400	770	0.081	0.243
		26	26,800	1,610	0.075	0.225	24,100	1,450	0.075	0.225	21,700	1,250	0.075	0.225	12,000	690	0.068	0.203
		28	26,800	1,610	0.075	0.225	24,100	1,450	0.075	0.225	21,700	1,250	0.075	0.225	12,000	690	0.068	0.203
		30	26,800	1,610	0.075	0.225	24,100	1,450	0.075	0.225	21,700	1,250	0.075	0.225	12,000	690	0.068	0.203
		32	23,400	1,400	0.060	0.180	21,000	1,260	0.060	0.180	18,900	1,090	0.060	0.180	10,500	600	0.054	0.162
		34	23,400	1,400	0.060	0.180	21,000	1,260	0.060	0.180	18,900	1,090	0.060	0.180	10,500	600	0.054	0.162
		36	20,400	1,220	0.045	0.135	18,300	1,100	0.045	0.135	16,500	950	0.045	0.135	9,200	530	0.041	0.122
38	20,400	1,220	0.045	0.135	18,300	1,100	0.045	0.135	16,500	950	0.045	0.135	9,200	530	0.041	0.122		
40	17,000	890	0.030	0.090	15,300	800	0.030	0.090	13,800	700	0.030	0.090	7,600	380	0.027	0.081		
1	2	10	31,800	3,430	0.200	0.600	28,700	3,100	0.200	0.600	25,800	2,630	0.200	0.600	14,300	1,460	0.180	0.540
		16	29,600	2,880	0.180	0.540	26,700	2,600	0.180	0.540	24,000	2,200	0.180	0.540	13,300	1,220	0.162	0.486
		20	27,100	2,630	0.120	0.360	24,400	2,370	0.120	0.360	21,900	2,010	0.120	0.360	12,200	1,120	0.108	0.324
		24	24,800	2,140	0.110	0.330	22,400	1,940	0.110	0.330	20,100	1,640	0.110	0.330	11,200	910	0.099	0.297
		30	22,300	1,930	0.100	0.300	20,100	1,740	0.100	0.300	18,100	1,480	0.100	0.300	10,000	820	0.090	0.270
		36	20,100	1,740	0.080	0.240	18,100	1,560	0.080	0.240	16,300	1,330	0.080	0.240	9,000	730	0.072	0.216
		40	20,100	1,740	0.080	0.240	18,100	1,560	0.080	0.240	16,300	1,330	0.080	0.240	9,000	730	0.072	0.216
		46	17,500	1,510	0.060	0.180	15,800	1,370	0.060	0.180	14,200	1,160	0.060	0.180	7,900	640	0.054	0.162
		60	12,700	960	0.044	0.132	11,500	870	0.044	0.132	10,300	740	0.044	0.132	5,700	410	0.040	0.119
		1.25	2.5	16	23,700	2,880	0.225	0.675	21,300	2,590	0.225	0.675	19,200	2,230	0.225	0.675	10,700	1,240
24	21,700			2,640	0.150	0.450	19,500	2,370	0.150	0.450	17,500	2,030	0.150	0.450	9,700	1,130	0.135	0.405
30	19,900			2,150	0.138	0.413	17,900	1,930	0.138	0.413	16,100	1,660	0.138	0.413	8,900	920	0.124	0.371
40	17,800			1,920	0.125	0.375	16,100	1,740	0.125	0.375	14,400	1,490	0.125	0.375	8,000	830	0.113	0.338
50	16,100			1,740	0.100	0.300	14,400	1,560	0.100	0.300	13,000	1,340	0.100	0.300	7,200	740	0.090	0.270
1.5	3	16	19,700	2,930	0.270	0.810	17,800	2,640	0.270	0.810	16,000	2,250	0.270	0.810	8,900	1,250	0.243	0.729
		20	19,700	2,930	0.270	0.810	17,800	2,640	0.270	0.810	16,000	2,250	0.270	0.810	8,900	1,250	0.243	0.729
		24	19,700	2,930	0.270	0.810	17,800	2,640	0.270	0.810	16,000	2,250	0.270	0.810	8,900	1,250	0.243	0.729
		30	18,000	2,670	0.180	0.540	16,200	2,410	0.180	0.540	14,600	2,050	0.180	0.540	8,100	1,140	0.162	0.486
		40	14,900	1,970	0.150	0.450	13,400	1,770	0.150	0.450	12,000	1,500	0.150	0.450	6,700	840	0.135	0.405
		50	13,400	1,770	0.120	0.360	12,000	1,580	0.120	0.360	10,800	1,350	0.120	0.360	6,000	750	0.108	0.324
		60	13,400	1,770	0.120	0.360	12,000	1,580	0.120	0.360	10,800	1,350	0.120	0.360	6,000	750	0.108	0.324

焼入れ鋼 Hardened steels (50~55HRC) HPM38, SKD61				焼入れ鋼 Hardened steels (55~65HRC) SKD11, YXR3, YXR33				被削材 Work material		
回転数 n min ⁻¹	送り速度 v_f mm/min	a_p mm	a_e mm	回転数 n min ⁻¹	送り速度 v_f mm/min	a_p mm	a_e mm	首下長 LU Under neck length (mm)	外径 DC Tool dia. (mm)	ボール半径 RE Ball radius (mm)
42,600	1,380	0.063	0.189	37,300	910	0.045	0.135	6	1	0.5
42,600	1,380	0.063	0.189	37,300	910	0.045	0.135	8		
39,000	1,260	0.056	0.168	34,100	830	0.040	0.120	10		
35,800	1,030	0.049	0.147	31,300	680	0.035	0.105	12		
32,100	920	0.042	0.126	28,100	610	0.030	0.090	14		
32,100	920	0.042	0.126	28,100	610	0.030	0.090	16		
28,900	830	0.035	0.105	25,300	550	0.025	0.075	18		
28,900	830	0.035	0.105	25,300	550	0.025	0.075	20		
25,200	730	0.028	0.084	22,100	480	0.020	0.060	22		
22,000	630	0.021	0.063	19,300	420	0.015	0.045	24		
22,000	630	0.021	0.063	19,300	420	0.015	0.045	26		
18,300	460	0.014	0.042	16,100	300	0.010	0.030	28		
18,300	460	0.014	0.042	16,100	300	0.010	0.030	30		
15,100	380	0.007	0.021	13,200	250	0.005	0.015	32		
11,500	290	0.004	0.011	10,000	190	0.003	0.008	34		
11,500	290	0.004	0.011	10,000	190	0.003	0.008	36		
28,400	1,530	0.095	0.284	24,900	1,010	0.068	0.203	8	1.5	0.75
28,400	1,530	0.095	0.284	24,900	1,010	0.068	0.203	10		
26,000	1,400	0.084	0.252	22,700	920	0.060	0.180	14		
23,800	1,140	0.074	0.221	20,900	750	0.053	0.158	16		
23,800	1,140	0.074	0.221	20,900	750	0.053	0.158	18		
21,400	1,030	0.063	0.189	18,700	670	0.045	0.135	20		
21,400	1,030	0.063	0.189	18,700	670	0.045	0.135	22		
21,400	1,030	0.063	0.189	18,700	670	0.045	0.135	24		
19,300	930	0.053	0.158	16,900	610	0.038	0.113	26		
19,300	930	0.053	0.158	16,900	610	0.038	0.113	28		
19,300	930	0.053	0.158	16,900	610	0.038	0.113	30		
16,800	810	0.042	0.126	14,700	530	0.030	0.090	32		
16,800	810	0.042	0.126	14,700	530	0.030	0.090	34		
14,700	710	0.032	0.095	12,800	460	0.023	0.068	36		
14,700	710	0.032	0.095	12,800	460	0.023	0.068	38		
12,200	510	0.021	0.063	10,700	340	0.015	0.045	40		
22,900	1,920	0.140	0.420	20,100	1,270	0.100	0.300	10	2	1
21,300	1,610	0.126	0.378	18,700	1,060	0.090	0.270	16		
19,500	1,470	0.084	0.252	17,100	970	0.060	0.180	20		
17,900	1,200	0.077	0.231	15,600	790	0.055	0.165	24		
16,100	1,080	0.070	0.210	14,000	710	0.050	0.150	30		
14,400	970	0.056	0.168	12,600	640	0.040	0.120	36		
14,400	970	0.056	0.168	12,600	640	0.040	0.120	40		
12,600	850	0.042	0.126	11,000	550	0.030	0.090	46		
9,200	540	0.031	0.092	8,000	350	0.022	0.066	60		
17,100	1,660	0.158	0.473	14,900	1,090	0.113	0.338	16	2.5	1.25
15,600	1,520	0.105	0.315	13,600	990	0.075	0.225	24		
14,300	1,240	0.096	0.289	12,500	810	0.069	0.206	30		
12,800	1,110	0.088	0.263	11,200	730	0.063	0.188	40		
11,600	1,000	0.070	0.210	10,100	650	0.050	0.150	50		
14,200	1,690	0.189	0.567	12,400	1,100	0.135	0.405	16	3	1.5
14,200	1,690	0.189	0.567	12,400	1,100	0.135	0.405	20		
14,200	1,690	0.189	0.567	12,400	1,100	0.135	0.405	24		
13,000	1,540	0.126	0.378	11,400	1,020	0.090	0.270	30		
10,700	1,130	0.105	0.315	9,400	740	0.075	0.225	40		
9,600	1,010	0.084	0.252	8,400	670	0.060	0.180	50		
9,600	1,010	0.084	0.252	8,400	670	0.060	0.180	60		

【注意】

ご使用にあたっては、A118ページの表下の項目と注意を参照してください。

【Note】

Upon usage, please refer to comments and notes below table on page A118.

EMBPE-ATH

ペンシルタイプ
Pencil type

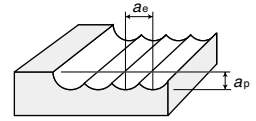

〈荒加工〉 Roughing

被削材 Work material			炭素鋼・合金鋼 Carbon steels, Alloy steels (180~250HB) S50C, S55C				工具鋼 Tool steels (25~40HRC) HPM7, SCM440, SKD61, SKT4				プリハードン鋼・焼入れ鋼 Pre-hardened steels, Hardened steels (40~50HRC)							
			快削材料 Free-cutting materials SKD61, CENA1, HPM-MAGIC, NAK80				高靱性材料 High-toughness materials DAC-MAGIC, DAC55, DH31											
ボール半径 RE Ball radius (mm)	外径 DC Tool dia. (mm)	首下長 LU Under neck length (mm)	回転数 n min ⁻¹	送り速度 Vf mm/min	ap mm	ae mm	回転数 n min ⁻¹	送り速度 Vf mm/min	ap mm	ae mm	回転数 n min ⁻¹	送り速度 Vf mm/min	ap mm	ae mm	回転数 n min ⁻¹	送り速度 Vf mm/min	ap mm	ae mm
1.75	3.5	20	16,900	3,060	0.315	0.945	15,200	2,750	0.315	0.945	13,700	2,330	0.315	0.945	7,600	1,290	0.284	0.851
		30	15,500	2,800	0.210	0.630	13,900	2,510	0.210	0.630	12,500	2,130	0.210	0.630	7,000	1,190	0.189	0.567
		40	14,200	2,280	0.193	0.578	12,800	2,060	0.193	0.578	11,500	1,740	0.193	0.578	6,400	970	0.173	0.520
		50	12,700	2,040	0.175	0.525	11,500	1,850	0.175	0.525	10,300	1,560	0.175	0.525	5,700	860	0.158	0.473
2	4	20	15,900	3,720	0.400	1.200	14,300	3,350	0.400	1.200	12,900	2,860	0.400	1.200	7,200	1,600	0.360	1.080
		30	14,800	3,120	0.300	0.900	13,300	2,800	0.300	0.900	12,000	2,400	0.300	0.900	6,700	1,340	0.270	0.810
		40	13,500	2,840	0.260	0.780	12,200	2,570	0.260	0.780	11,000	2,200	0.260	0.780	6,100	1,220	0.234	0.702
		50	12,400	2,320	0.180	0.540	11,200	2,100	0.180	0.540	10,100	1,790	0.180	0.540	5,600	990	0.162	0.486
		60	11,100	2,080	0.120	0.360	10,000	1,870	0.120	0.360	9,000	1,600	0.120	0.360	5,000	890	0.108	0.324
		70	10,000	1,870	0.100	0.300	9,000	1,680	0.100	0.300	8,100	1,440	0.100	0.300	4,500	800	0.090	0.270
2.5	5	30	11,800	3,250	0.375	1.125	10,700	2,950	0.375	1.125	9,600	2,490	0.375	1.125	5,300	1,370	0.338	1.013
		40	11,800	3,250	0.375	1.125	10,700	2,950	0.375	1.125	9,600	2,490	0.375	1.125	5,300	1,370	0.338	1.013
		50	10,800	2,970	0.325	0.975	9,700	2,670	0.325	0.975	8,800	2,280	0.325	0.975	4,900	1,270	0.293	0.878
		60	9,900	2,420	0.225	0.675	8,900	2,180	0.225	0.675	8,000	1,840	0.225	0.675	4,500	1,040	0.203	0.608
		70	8,900	2,180	0.150	0.450	8,000	1,960	0.150	0.450	7,200	1,660	0.150	0.450	4,000	920	0.135	0.405
		80	8,900	2,180	0.150	0.450	8,000	1,960	0.150	0.450	7,200	1,660	0.150	0.450	4,000	920	0.135	0.405
3	6	30	10,600	4,010	0.600	1.800	9,600	3,630	0.600	1.800	8,600	3,070	0.600	1.800	4,800	1,710	0.540	1.620
		40	9,900	3,370	0.420	1.260	8,900	3,030	0.420	1.260	8,000	2,570	0.420	1.260	4,400	1,410	0.378	1.134
		50	9,000	3,060	0.300	0.900	8,100	2,760	0.300	0.900	7,300	2,350	0.300	0.900	4,100	1,320	0.270	0.810
		60	9,000	3,060	0.300	0.900	8,100	2,760	0.300	0.900	7,300	2,350	0.300	0.900	4,100	1,320	0.270	0.810
		70	8,300	2,510	0.240	0.720	7,500	2,270	0.240	0.720	6,700	1,910	0.240	0.720	3,700	1,060	0.216	0.648
		80	7,400	2,240	0.180	0.540	6,700	2,030	0.180	0.540	6,000	1,710	0.180	0.540	3,300	940	0.162	0.486
		100	6,700	2,030	0.120	0.360	6,000	1,810	0.120	0.360	5,400	1,540	0.120	0.360	3,000	860	0.108	0.324
		120	6,700	2,030	0.120	0.360	6,000	1,810	0.120	0.360	5,400	1,540	0.120	0.360	3,000	860	0.108	0.324
4	8	40	8,000	4,220	0.800	2.400	7,200	3,800	0.800	2.400	6,400	3,190	0.800	2.400	3,600	1,790	0.720	2.160
		50	7,400	3,520	0.560	1.680	6,700	3,180	0.560	1.680	6,000	2,690	0.560	1.680	3,300	1,480	0.504	1.512
		60	7,400	3,520	0.560	1.680	6,700	3,180	0.560	1.680	6,000	2,690	0.560	1.680	3,300	1,480	0.504	1.512
		70	6,800	3,230	0.400	1.200	6,100	2,900	0.400	1.200	5,500	2,470	0.400	1.200	3,000	1,340	0.360	1.080
		80	6,800	3,230	0.400	1.200	6,100	2,900	0.400	1.200	5,500	2,470	0.400	1.200	3,000	1,340	0.360	1.080
		100	6,200	2,620	0.320	0.960	5,600	2,370	0.320	0.960	5,000	1,990	0.320	0.960	2,800	1,120	0.288	0.864
5	10	120	5,600	2,370	0.240	0.720	5,000	2,110	0.240	0.720	4,500	1,790	0.240	0.720	2,500	1,000	0.216	0.648
		50	6,400	4,440	1.000	3.000	5,700	3,950	1.000	3.000	5,200	3,400	1.000	3.000	3,200	2,090	0.900	2.700
		60	5,900	3,680	0.700	2.100	5,300	3,310	0.700	2.100	4,800	2,830	0.700	2.100	3,000	1,770	0.630	1.890
		75	5,900	3,680	0.700	2.100	5,300	3,310	0.700	2.100	4,800	2,830	0.700	2.100	3,000	1,770	0.630	1.890
		80	5,400	3,370	0.500	1.500	4,900	3,060	0.500	1.500	4,400	2,590	0.500	1.500	2,700	1,590	0.450	1.350
		100	5,400	3,370	0.500	1.500	4,900	3,060	0.500	1.500	4,400	2,590	0.500	1.500	2,700	1,590	0.450	1.350
6	12	120	5,000	2,770	0.400	1.200	4,500	2,490	0.400	1.200	4,000	2,090	0.400	1.200	2,500	1,310	0.360	1.080
		60	5,300	4,210	1.200	3.600	4,800	3,820	1.200	3.600	4,300	3,210	1.200	3.600	2,700	2,020	1.080	3.240
		80	4,900	3,510	0.840	2.520	4,400	3,150	0.840	2.520	4,000	2,690	0.840	2.520	2,500	1,680	0.756	2.268
		100	4,500	3,220	0.600	1.800	4,100	2,930	0.600	1.800	3,700	2,490	0.600	1.800	2,300	1,550	0.540	1.620
120	4,500	3,220	0.600	1.800	4,100	2,930	0.600	1.800	3,700	2,490	0.600	1.800	2,300	1,550	0.540	1.620		

- 【注意】**
- ①被削材、加工形状に合わせて、適切なクーラントを使用してください。
 - ②できるだけ高剛性、高精度の機械をご使用ください。
 - ③この切削条件表は切削条件の目安を示すものです。実際の加工では加工形状、目的、使用機械等により条件を調整してください。
 - ④機械の回転数が足りない場合には、回転数と送り速度を同じ比率で下げてください。
- 【Note】**
- ① Use the appropriate coolant for the work material and machining shape.
 - ② Use as highly rigid and accurate machine as possible.
 - ③ These conditions are for general guidance; in actual machining conditions adjust the parameters according to your actual machine and work-piece conditions.
 - ④ If the rpm available is lower than that recommended please reduce the feed rate to the same ratio.

焼入れ鋼 Hardened steels (50~55HRC) HPM38, SKD61				焼入れ鋼 Hardened steels (55~65HRC) SKD11, YXR3, YXR33				被削材 Work material		
回転数 n min ⁻¹	送り速度 v_f mm/min	a_p mm	a_e mm	回転数 n min ⁻¹	送り速度 v_f mm/min	a_p mm	a_e mm	首下長 LU Under neck length (mm)	外径 DC Tool dia. (mm)	ボール半径 RE Ball radius (mm)
12,200	1,750	0.221	0.662	10,700	1,160	0.158	0.473	20	3.5	1.75
11,100	1,590	0.147	0.441	9,700	1,050	0.105	0.315	30		
10,200	1,300	0.135	0.404	8,900	850	0.096	0.289	40		
9,200	1,170	0.123	0.368	8,000	770	0.088	0.263	50		
8,300	1,060	0.098	0.294	7,200	690	0.070	0.210	60		
11,500	2,140	0.280	0.840	10,000	1,410	0.200	0.600	20	4	2
10,700	1,790	0.210	0.630	9,300	1,180	0.150	0.450	30		
9,700	1,620	0.182	0.546	8,500	1,080	0.130	0.390	40		
8,900	1,320	0.126	0.378	7,800	880	0.090	0.270	50		
8,000	1,190	0.084	0.252	7,000	790	0.060	0.180	60		
7,200	1,070	0.070	0.210	6,300	710	0.050	0.150	70		
7,200	1,070	0.070	0.210	6,300	710	0.050	0.150	80		
8,500	1,860	0.263	0.788	7,500	1,240	0.188	0.563	30	5	2.5
8,500	1,860	0.263	0.788	7,500	1,240	0.188	0.563	40		
7,800	1,710	0.228	0.683	6,800	1,120	0.163	0.488	50		
7,200	1,400	0.158	0.473	6,300	920	0.113	0.338	60		
6,400	1,240	0.105	0.315	5,600	820	0.075	0.225	70		
6,400	1,240	0.105	0.315	5,600	820	0.075	0.225	80		
7,600	2,280	0.420	1.260	6,700	1,510	0.300	0.900	30	6	3
7,100	1,920	0.294	0.882	6,200	1,260	0.210	0.630	40		
6,500	1,760	0.210	0.630	5,700	1,150	0.150	0.450	50		
6,500	1,760	0.210	0.630	5,700	1,150	0.150	0.450	60		
6,000	1,440	0.168	0.504	5,200	940	0.120	0.360	70		
5,400	1,300	0.126	0.378	4,700	850	0.090	0.270	80		
4,800	1,150	0.084	0.252	4,200	760	0.060	0.180	100		
4,800	1,150	0.084	0.252	4,200	760	0.060	0.180	120		
5,700	2,380	0.560	1.680	5,000	1,580	0.400	1.200	40	8	4
5,300	1,990	0.392	1.176	4,700	1,330	0.280	0.840	50		
5,300	1,990	0.392	1.176	4,700	1,330	0.280	0.840	60		
4,900	1,840	0.280	0.840	4,300	1,220	0.200	0.600	70		
4,900	1,840	0.280	0.840	4,300	1,220	0.200	0.600	80		
4,500	1,500	0.224	0.672	3,900	980	0.160	0.480	100		
4,000	1,330	0.168	0.504	3,500	880	0.120	0.360	120		
4,600	2,530	0.700	2.100	4,000	1,660	0.500	1.500	50	10	5
4,300	2,120	0.490	1.470	3,700	1,380	0.350	1.050	60		
4,300	2,120	0.490	1.470	3,700	1,380	0.350	1.050	75		
3,900	1,930	0.350	1.050	3,400	1,270	0.250	0.750	80		
3,900	1,930	0.350	1.050	3,400	1,270	0.250	0.750	100		
3,600	1,580	0.280	0.840	3,100	1,030	0.200	0.600	120		
3,800	2,380	0.840	2.520	3,300	1,560	0.600	1.800	60	12	6
3,600	2,030	0.588	1.764	3,100	1,320	0.420	1.260	80		
3,200	1,810	0.420	1.260	2,800	1,190	0.300	0.900	100		
3,200	1,810	0.420	1.260	2,800	1,190	0.300	0.900	120		

EMBPE-ATH

ペンシルタイプ
Pencil type

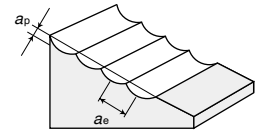

〈仕上げ加工〉 Finishing

被削材 Work material			炭素鋼・合金鋼 Carbon steels, Alloy steels (180~250HB) S50C, S55C				工具鋼 Tool steels (25~40HRC) HPM7, SCM440, SKD61, SKT4				プリハードン鋼・焼入れ鋼 Pre-hardened steels, Hardened steels (40~50HRC) SKD61, CENA1, HPM-MAGIC, NAK80, DAC-MAGIC, DAC55, DH31			
ボール半径 RE Ball radius (mm)	外径 DC Tool dia. (mm)	首下長 LU Under neck length (mm)	回転数 n min ⁻¹	送り速度 vf mm/min	ap mm	ae mm	回転数 n min ⁻¹	送り速度 vf mm/min	ap mm	ae mm	回転数 n min ⁻¹	送り速度 vf mm/min	ap mm	ae mm
0.5	1	6	50,000	1,760	0.02~0.05	0.02	50,000	1,760	0.02~0.05	0.02	50,000	1,620	0.02~0.05	0.02
		8	50,000	1,760	0.02~0.05	0.02	50,000	1,760	0.02~0.05	0.02	50,000	1,620	0.02~0.05	0.02
		10	50,000	1,760	0.02~0.05	0.02	50,000	1,760	0.02~0.05	0.02	48,700	1,580	0.02~0.05	0.02
		12	50,000	1,560	0.02~0.05	0.02	49,700	1,550	0.02~0.05	0.02	44,700	1,290	0.02~0.05	0.02
		14	49,000	1,530	0.02~0.05	0.02	44,600	1,390	0.02~0.05	0.02	40,100	1,150	0.02~0.05	0.02
		16	49,000	1,530	0.02~0.05	0.02	44,600	1,390	0.02~0.05	0.02	40,100	1,150	0.02~0.05	0.02
		18	44,100	1,380	0.02~0.05	0.02	40,100	1,250	0.02~0.05	0.02	36,100	1,040	0.02~0.05	0.02
		20	44,100	1,380	0.02~0.05	0.02	40,100	1,250	0.02~0.05	0.02	36,100	1,040	0.02~0.05	0.02
		22	38,500	1,200	0.02~0.05	0.02	35,000	1,090	0.02~0.05	0.02	31,500	910	0.02~0.05	0.02
		24	33,600	1,050	0.02~0.05	0.02	30,600	950	0.02~0.05	0.02	27,500	790	0.02~0.05	0.02
		26	33,600	1,050	0.02~0.05	0.02	30,600	950	0.02~0.05	0.02	27,500	790	0.02~0.05	0.02
		28	28,000	760	0.02~0.05	0.02	25,500	700	0.02~0.05	0.02	22,900	580	0.02~0.05	0.02
		30	28,000	760	0.02~0.05	0.02	25,500	700	0.02~0.05	0.02	22,900	580	0.02~0.05	0.02
		32	23,100	630	0.02~0.05	0.02	21,000	570	0.02~0.05	0.02	18,900	480	0.02~0.05	0.02
34	17,500	480	0.02~0.05	0.02	15,900	430	0.02~0.05	0.02	14,300	360	0.02~0.05	0.02		
36	17,500	480	0.02~0.05	0.02	15,900	430	0.02~0.05	0.02	14,300	360	0.02~0.05	0.02		
0.75	1.5	8	43,400	2,340	0.02~0.07	0.03	39,500	2,130	0.02~0.07	0.03	35,500	1,820	0.02~0.07	0.03
		10	43,400	2,340	0.02~0.07	0.03	39,500	2,130	0.02~0.07	0.03	35,500	1,820	0.02~0.07	0.03
		14	39,700	2,140	0.02~0.07	0.03	36,100	1,950	0.02~0.07	0.03	32,500	1,670	0.02~0.07	0.03
		16	36,400	1,750	0.02~0.07	0.03	33,100	1,590	0.02~0.07	0.03	29,800	1,360	0.02~0.07	0.03
		18	36,400	1,750	0.02~0.07	0.03	33,100	1,590	0.02~0.07	0.03	29,800	1,360	0.02~0.07	0.03
		20	32,700	1,570	0.02~0.07	0.03	29,700	1,430	0.02~0.07	0.03	26,800	1,220	0.02~0.07	0.03
		22	32,700	1,570	0.02~0.07	0.03	29,700	1,430	0.02~0.07	0.03	26,800	1,220	0.02~0.07	0.03
		24	32,700	1,570	0.02~0.07	0.03	29,700	1,430	0.02~0.07	0.03	26,800	1,220	0.02~0.07	0.03
		26	29,400	1,410	0.02~0.07	0.03	26,800	1,290	0.02~0.07	0.03	24,100	1,100	0.02~0.07	0.03
		28	29,400	1,410	0.02~0.07	0.03	26,800	1,290	0.02~0.07	0.03	24,100	1,100	0.02~0.07	0.03
		30	29,400	1,410	0.02~0.07	0.03	26,800	1,290	0.02~0.07	0.03	24,100	1,100	0.02~0.07	0.03
		32	25,700	1,230	0.02~0.07	0.03	23,400	1,120	0.02~0.07	0.03	21,000	960	0.02~0.07	0.03
		34	25,700	1,230	0.02~0.07	0.03	23,400	1,120	0.02~0.07	0.03	21,000	960	0.02~0.07	0.03
		36	22,400	1,080	0.02~0.07	0.03	20,400	980	0.02~0.07	0.03	18,300	830	0.02~0.07	0.03
38	22,400	1,080	0.02~0.07	0.03	20,400	980	0.02~0.07	0.03	18,300	830	0.02~0.07	0.03		
40	18,700	790	0.02~0.07	0.03	17,000	710	0.02~0.07	0.03	15,300	610	0.02~0.07	0.03		
1	2	10	35,000	3,050	0.02~0.10	0.04	31,800	2,770	0.02~0.10	0.04	28,700	2,320	0.02~0.10	0.04
		16	32,600	2,550	0.02~0.10	0.04	29,600	2,320	0.02~0.10	0.04	26,700	1,950	0.02~0.10	0.04
		20	29,800	2,330	0.02~0.10	0.04	27,100	2,120	0.02~0.10	0.04	24,400	1,780	0.02~0.10	0.04
		24	27,300	1,900	0.02~0.10	0.04	24,800	1,730	0.02~0.10	0.04	22,400	1,450	0.02~0.10	0.04
		30	24,500	1,710	0.02~0.10	0.04	22,300	1,550	0.02~0.10	0.04	20,100	1,300	0.02~0.10	0.04
		36	22,100	1,540	0.02~0.10	0.04	20,100	1,400	0.02~0.10	0.04	18,100	1,170	0.02~0.10	0.04
		40	22,100	1,540	0.02~0.10	0.04	20,100	1,400	0.02~0.10	0.04	18,100	1,170	0.02~0.10	0.04
		46	19,300	1,340	0.02~0.10	0.04	17,500	1,220	0.02~0.10	0.04	15,800	1,020	0.02~0.10	0.04
60	14,000	850	0.02~0.10	0.04	12,700	770	0.02~0.10	0.04	11,500	650	0.02~0.10	0.04		
1.25	2.5	16	26,100	2,540	0.05~0.12	0.05	23,700	2,300	0.05~0.12	0.05	21,300	1,960	0.05~0.12	0.05
		24	23,800	2,310	0.05~0.12	0.05	21,700	2,110	0.05~0.12	0.05	19,500	1,790	0.05~0.12	0.05
		30	21,900	1,890	0.05~0.12	0.05	19,900	1,720	0.05~0.12	0.05	17,900	1,460	0.05~0.12	0.05
		40	19,600	1,690	0.05~0.12	0.05	17,800	1,540	0.05~0.12	0.05	16,100	1,310	0.05~0.12	0.05
		50	17,700	1,530	0.05~0.12	0.05	16,100	1,390	0.05~0.12	0.05	14,400	1,180	0.05~0.12	0.05
1.5	3	16	21,700	2,580	0.05~0.15	0.06	19,700	2,340	0.05~0.15	0.06	17,800	2,020	0.05~0.15	0.06
		20	21,700	2,580	0.05~0.15	0.06	19,700	2,340	0.05~0.15	0.06	17,800	2,020	0.05~0.15	0.06
		24	21,700	2,580	0.05~0.15	0.06	19,700	2,340	0.05~0.15	0.06	17,800	2,020	0.05~0.15	0.06
		30	19,900	2,360	0.05~0.15	0.06	18,000	2,140	0.05~0.15	0.06	16,200	1,840	0.05~0.15	0.06
		40	16,300	1,720	0.05~0.15	0.06	14,900	1,570	0.05~0.15	0.06	13,400	1,350	0.05~0.15	0.06
		50	14,700	1,550	0.05~0.15	0.06	13,400	1,420	0.05~0.15	0.06	12,000	1,210	0.05~0.15	0.06
60	14,700	1,550	0.05~0.15	0.06	13,400	1,420	0.05~0.15	0.06	12,000	1,210	0.05~0.15	0.06		

焼入れ鋼 Hardened steels (50~55HRC) HPM38, SKD61				焼入れ鋼 Hardened steels (55~65HRC) SKD11, YXR3, YXR33				被削材 Work material		
回転数 <i>n</i> min ⁻¹	送り速度 <i>v_f</i> mm/min	<i>a_p</i> mm	<i>a_e</i> mm	回転数 <i>n</i> min ⁻¹	送り速度 <i>v_f</i> mm/min	<i>a_p</i> mm	<i>a_e</i> mm	首下長 LU Under neck length (mm)	外径 DC Tool dia. (mm)	ボール半径 RE Ball radius (mm)
47,400	1,280	0.02~0.05	0.02	41,500	810	0.02~0.05	0.02	6	1	0.5
47,400	1,280	0.02~0.05	0.02	41,500	810	0.02~0.05	0.02	8		
43,300	1,170	0.02~0.05	0.02	37,900	740	0.02~0.05	0.02	10		
39,700	950	0.02~0.05	0.02	34,800	600	0.02~0.05	0.02	12		
35,700	860	0.02~0.05	0.02	31,200	540	0.02~0.05	0.02	14		
35,700	860	0.02~0.05	0.02	31,200	540	0.02~0.05	0.02	16		
32,100	770	0.02~0.05	0.02	28,100	490	0.02~0.05	0.02	18		
32,100	770	0.02~0.05	0.02	28,100	490	0.02~0.05	0.02	20		
28,000	670	0.02~0.05	0.02	24,500	420	0.02~0.05	0.02	22		
24,500	590	0.02~0.05	0.02	21,400	370	0.02~0.05	0.02	24		
24,500	590	0.02~0.05	0.02	21,400	370	0.02~0.05	0.02	26		
20,400	430	0.02~0.05	0.02	17,800	270	0.02~0.05	0.02	28		
20,400	430	0.02~0.05	0.02	17,800	270	0.02~0.05	0.02	30		
16,800	350	0.02~0.05	0.02	14,700	220	0.02~0.05	0.02	32		
12,700	270	0.02~0.05	0.02	11,100	170	0.02~0.05	0.02	34		
12,700	270	0.02~0.05	0.02	11,100	170	0.02~0.05	0.02	36		
31,600	1,370	0.02~0.07	0.03	27,600	890	0.02~0.07	0.03	8	1.5	0.75
31,600	1,370	0.02~0.07	0.03	27,600	890	0.02~0.07	0.03	10		
28,900	1,250	0.02~0.07	0.03	25,300	820	0.02~0.07	0.03	14		
26,500	1,020	0.02~0.07	0.03	23,200	670	0.02~0.07	0.03	16		
26,500	1,020	0.02~0.07	0.03	23,200	670	0.02~0.07	0.03	18		
23,800	910	0.02~0.07	0.03	20,800	600	0.02~0.07	0.03	20		
23,800	910	0.02~0.07	0.03	20,800	600	0.02~0.07	0.03	22		
23,800	910	0.02~0.07	0.03	20,800	600	0.02~0.07	0.03	24		
21,400	820	0.02~0.07	0.03	18,700	540	0.02~0.07	0.03	26		
21,400	820	0.02~0.07	0.03	18,700	540	0.02~0.07	0.03	28		
21,400	820	0.02~0.07	0.03	18,700	540	0.02~0.07	0.03	30		
18,700	720	0.02~0.07	0.03	16,300	470	0.02~0.07	0.03	32		
18,700	720	0.02~0.07	0.03	16,300	470	0.02~0.07	0.03	34		
16,300	630	0.02~0.07	0.03	14,300	410	0.02~0.07	0.03	36		
16,300	630	0.02~0.07	0.03	14,300	410	0.02~0.07	0.03	38		
13,600	460	0.02~0.07	0.03	11,900	300	0.02~0.07	0.03	40		
25,500	1,680	0.02~0.10	0.04	22,300	1,140	0.02~0.10	0.04	10	2	1
23,700	1,410	0.02~0.10	0.04	20,700	950	0.02~0.10	0.04	16		
21,700	1,290	0.02~0.10	0.04	18,900	870	0.02~0.10	0.04	20		
19,900	1,050	0.02~0.10	0.04	17,400	710	0.02~0.10	0.04	24		
17,800	940	0.02~0.10	0.04	15,600	640	0.02~0.10	0.04	30		
16,100	850	0.02~0.10	0.04	14,000	570	0.02~0.10	0.04	36		
16,100	850	0.02~0.10	0.04	14,000	570	0.02~0.10	0.04	40		
14,000	740	0.02~0.10	0.04	12,300	500	0.02~0.10	0.04	46		
10,200	470	0.02~0.10	0.04	8,900	320	0.02~0.10	0.04	60		
19,000	1,490	0.05~0.12	0.05	16,600	990	0.05~0.12	0.05	16	2.5	1.25
17,300	1,350	0.05~0.12	0.05	15,200	900	0.05~0.12	0.05	24		
15,900	1,110	0.05~0.12	0.05	13,900	730	0.05~0.12	0.05	30		
14,300	1,000	0.05~0.12	0.05	12,500	660	0.05~0.12	0.05	40		
12,800	890	0.05~0.12	0.05	11,200	590	0.05~0.12	0.05	50		
15,800	1,490	0.05~0.15	0.06	13,800	970	0.05~0.15	0.06	16	3	1.5
15,800	1,490	0.05~0.15	0.06	13,800	970	0.05~0.15	0.06	20		
15,800	1,490	0.05~0.15	0.06	13,800	970	0.05~0.15	0.06	24		
14,400	1,360	0.05~0.15	0.06	12,600	880	0.05~0.15	0.06	30		
11,900	1,000	0.05~0.15	0.06	10,400	650	0.05~0.15	0.06	40		
10,700	900	0.05~0.15	0.06	9,400	590	0.05~0.15	0.06	50		
10,700	900	0.05~0.15	0.06	9,400	590	0.05~0.15	0.06	60		

【注意】

ご使用にあたっては、A122ページの表下の項目と注意を参照してください。

【Note】

Upon usage, please refer to comments and notes below table on page A122.

EMBPE-ATH

ペンシルタイプ
Pencil type

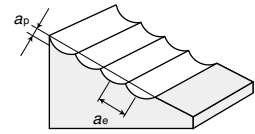

〈仕上げ加工〉 Finishing

被削材 Work material			炭素鋼・合金鋼 Carbon steels, Alloy steels (180~250HB) S50C, S55C				工具鋼 Tool steels (25~40HRC) HPM7, SCM440, SKD61, SKT4				プリハードン鋼・焼入れ鋼 Pre-hardened steels, Hardened steels (40~50HRC) SKD61, CENA1, HPM-MAGIC, NAK80, DAC-MAGIC, DAC55, DH31			
ボール半径 RE Ball radius (mm)	外径 DC Tool dia. (mm)	首下長 LU Under neck length (mm)	回転数 n min ⁻¹	送り速度 vf mm/min	ap mm	ae mm	回転数 n min ⁻¹	送り速度 vf mm/min	ap mm	ae mm	回転数 n min ⁻¹	送り速度 vf mm/min	ap mm	ae mm
1.75	3.5	20	18,600	2,710	0.05~0.15	0.07	16,900	2,460	0.05~0.15	0.07	15,200	2,050	0.05~0.15	0.07
		30	17,000	2,480	0.05~0.15	0.07	15,500	2,260	0.05~0.15	0.07	13,900	1,880	0.05~0.15	0.07
		40	15,600	2,020	0.05~0.15	0.07	14,200	1,840	0.05~0.15	0.07	12,800	1,540	0.05~0.15	0.07
		50	14,000	1,810	0.05~0.15	0.07	12,700	1,650	0.05~0.15	0.07	11,500	1,380	0.05~0.15	0.07
		60	12,600	1,630	0.05~0.15	0.07	11,500	1,490	0.05~0.15	0.07	10,300	1,240	0.05~0.15	0.07
2	4	20	17,500	3,260	0.05~0.20	0.08	15,900	2,960	0.05~0.20	0.08	14,300	2,530	0.05~0.20	0.08
		30	16,300	2,730	0.05~0.20	0.08	14,800	2,480	0.05~0.20	0.08	13,300	2,120	0.05~0.20	0.08
		40	14,900	2,490	0.05~0.20	0.08	13,500	2,260	0.05~0.20	0.08	12,200	1,940	0.05~0.20	0.08
		50	13,700	2,040	0.05~0.20	0.08	12,400	1,850	0.05~0.20	0.08	11,200	1,590	0.05~0.20	0.08
		60	12,300	1,830	0.05~0.20	0.08	11,100	1,650	0.05~0.20	0.08	10,000	1,420	0.05~0.20	0.08
		70	11,000	1,640	0.05~0.20	0.08	10,000	1,490	0.05~0.20	0.08	9,000	1,270	0.05~0.20	0.08
2.5	5	30	13,000	2,880	0.05~0.25	0.1	11,800	2,610	0.05~0.25	0.1	10,700	2,220	0.05~0.25	0.1
		40	13,000	2,880	0.05~0.25	0.1	11,800	2,610	0.05~0.25	0.1	10,700	2,220	0.05~0.25	0.1
		50	11,900	2,630	0.05~0.25	0.1	10,800	2,390	0.05~0.25	0.1	9,700	2,020	0.05~0.25	0.1
		60	10,900	2,150	0.05~0.25	0.1	9,900	1,950	0.05~0.25	0.1	8,900	1,640	0.05~0.25	0.1
		70	9,800	1,930	0.05~0.25	0.1	8,900	1,750	0.05~0.25	0.1	8,000	1,480	0.05~0.25	0.1
3	6	30	11,700	3,550	0.05~0.3	0.12	10,600	3,210	0.05~0.3	0.12	9,600	2,740	0.05~0.3	0.12
		40	10,900	2,970	0.05~0.3	0.12	9,900	2,700	0.05~0.3	0.12	8,900	2,280	0.05~0.3	0.12
		50	9,900	2,700	0.05~0.3	0.12	9,000	2,450	0.05~0.3	0.12	8,100	2,080	0.05~0.3	0.12
		60	9,900	2,700	0.05~0.3	0.12	9,000	2,450	0.05~0.3	0.12	8,100	2,080	0.05~0.3	0.12
		70	9,100	2,210	0.05~0.3	0.12	8,300	2,010	0.05~0.3	0.12	7,500	1,710	0.05~0.3	0.12
		80	8,200	1,990	0.05~0.3	0.12	7,400	1,790	0.05~0.3	0.12	6,700	1,530	0.05~0.3	0.12
		100	7,400	1,790	0.05~0.3	0.12	6,700	1,620	0.05~0.3	0.12	6,000	1,370	0.05~0.3	0.12
		120	7,400	1,790	0.05~0.3	0.12	6,700	1,620	0.05~0.3	0.12	6,000	1,370	0.05~0.3	0.12
4	8	40	8,800	3,720	0.05~0.4	0.16	8,000	3,380	0.05~0.4	0.16	7,200	2,870	0.05~0.4	0.16
		50	8,100	3,080	0.05~0.4	0.16	7,400	2,820	0.05~0.4	0.16	6,700	2,410	0.05~0.4	0.16
		60	8,100	3,080	0.05~0.4	0.16	7,400	2,820	0.05~0.4	0.16	6,700	2,410	0.05~0.4	0.16
		70	7,400	2,820	0.05~0.4	0.16	6,800	2,590	0.05~0.4	0.16	6,100	2,190	0.05~0.4	0.16
		80	7,400	2,820	0.05~0.4	0.16	6,800	2,590	0.05~0.4	0.16	6,100	2,190	0.05~0.4	0.16
		100	6,800	2,300	0.05~0.4	0.16	6,200	2,100	0.05~0.4	0.16	5,600	1,790	0.05~0.4	0.16
5	10	50	7,000	3,890	0.05~0.5	0.2	6,400	3,550	0.05~0.5	0.2	5,700	2,980	0.05~0.5	0.2
		60	6,500	3,250	0.05~0.5	0.2	5,900	2,950	0.05~0.5	0.2	5,300	2,490	0.05~0.5	0.2
		75	6,500	3,250	0.05~0.5	0.2	5,900	2,950	0.05~0.5	0.2	5,300	2,490	0.05~0.5	0.2
		80	6,000	3,000	0.05~0.5	0.2	5,400	2,700	0.05~0.5	0.2	4,900	2,300	0.05~0.5	0.2
		100	6,000	3,000	0.05~0.5	0.2	5,400	2,700	0.05~0.5	0.2	4,900	2,300	0.05~0.5	0.2
		120	5,500	2,440	0.05~0.5	0.2	5,000	2,220	0.05~0.5	0.2	4,500	1,880	0.05~0.5	0.2
6	12	60	5,800	3,690	0.05~0.6	0.24	5,300	3,370	0.05~0.6	0.24	4,800	2,870	0.05~0.6	0.24
		80	5,400	3,090	0.05~0.6	0.24	4,900	2,800	0.05~0.6	0.24	4,400	2,360	0.05~0.6	0.24
		100	5,000	2,860	0.05~0.6	0.24	4,500	2,580	0.05~0.6	0.24	4,100	2,200	0.05~0.6	0.24
		120	5,000	2,860	0.05~0.6	0.24	4,500	2,580	0.05~0.6	0.24	4,100	2,200	0.05~0.6	0.24

- 【注意】** ①被削材、加工形状に合わせて、適切なクーラントを使用してください。
 ②できるだけ高剛性、高精度の機械をご使用ください。
 ③この切削条件表は切削条件の目安を示すものです。実際の加工では加工形状、目的、使用機械等により条件を調整してください。
 ④機械の回転数が足りない場合には、回転数と送り速度を同じ比率で下げてください。

- 【Note】** ① Use the appropriate coolant for the work material and machining shape.
 ② Use as highly rigid and accurate machine as possible.
 ③ These conditions are for general guidance; in actual machining conditions adjust the parameters according to your actual machine and work-piece conditions.
 ④ If the rpm available is lower than that recommended please reduce the feed rate to the same ratio.

焼入れ鋼 Hardened steels (50~55HRC) HPM38, SKD61				焼入れ鋼 Hardened steels (55~65HRC) SKD11, YXR3, YXR33				被削材 Work material		
回転数 n min ⁻¹	送り速度 v_f mm/min	a_p mm	a_e mm	回転数 n min ⁻¹	送り速度 v_f mm/min	a_p mm	a_e mm	首下長 LU Under neck length (mm)	外径 DC Tool dia. (mm)	ボール半径 RE Ball radius (mm)
13,500	1,530	0.05~0.15	0.07	11,800	1,020	0.05~0.15	0.07	20	3.5	1.75
12,400	1,410	0.05~0.15	0.07	10,800	930	0.05~0.15	0.07	30		
11,400	1,150	0.05~0.15	0.07	9,900	760	0.05~0.15	0.07	40		
10,200	1,030	0.05~0.15	0.07	8,900	680	0.05~0.15	0.07	50		
9,200	930	0.05~0.15	0.07	8,000	610	0.05~0.15	0.07	60		
12,700	1,910	0.05~0.20	0.08	11,100	1,270	0.05~0.20	0.08	20	4	2
11,800	1,590	0.05~0.20	0.08	10,400	1,070	0.05~0.20	0.08	30		
10,800	1,460	0.05~0.20	0.08	9,500	970	0.05~0.20	0.08	40		
9,900	1,190	0.05~0.20	0.08	8,700	790	0.05~0.20	0.08	50		
8,900	1,070	0.05~0.20	0.08	7,800	710	0.05~0.20	0.08	60		
8,000	960	0.05~0.20	0.08	7,000	640	0.05~0.20	0.08	70	5	2.5
8,000	960	0.05~0.20	0.08	7,000	640	0.05~0.20	0.08	80		
9,500	1,670	0.05~0.25	0.1	8,300	1,100	0.05~0.25	0.1	30		
9,500	1,670	0.05~0.25	0.1	8,300	1,100	0.05~0.25	0.1	40		
8,700	1,530	0.05~0.25	0.1	7,600	1,010	0.05~0.25	0.1	50		
7,900	1,230	0.05~0.25	0.1	7,000	820	0.05~0.25	0.1	60	6	3
7,100	1,110	0.05~0.25	0.1	6,200	730	0.05~0.25	0.1	70		
7,100	1,110	0.05~0.25	0.1	6,200	730	0.05~0.25	0.1	80		
8,500	2,040	0.05~0.3	0.12	7,400	1,330	0.05~0.3	0.12	30		
7,900	1,710	0.05~0.3	0.12	6,900	1,120	0.05~0.3	0.12	40		
7,200	1,560	0.05~0.3	0.12	6,300	1,020	0.05~0.3	0.12	50	8	4
7,200	1,560	0.05~0.3	0.12	6,300	1,020	0.05~0.3	0.12	60		
6,600	1,270	0.05~0.3	0.12	5,800	840	0.05~0.3	0.12	70		
5,900	1,130	0.05~0.3	0.12	5,200	750	0.05~0.3	0.12	80		
5,400	1,040	0.05~0.3	0.12	4,700	680	0.05~0.3	0.12	100		
5,400	1,040	0.05~0.3	0.12	4,700	680	0.05~0.3	0.12	120	10	5
6,400	2,130	0.05~0.4	0.16	5,600	1,410	0.05~0.4	0.16	40		
5,900	1,770	0.05~0.4	0.16	5,200	1,180	0.05~0.4	0.16	50		
5,900	1,770	0.05~0.4	0.16	5,200	1,180	0.05~0.4	0.16	60		
5,400	1,620	0.05~0.4	0.16	4,700	1,070	0.05~0.4	0.16	70		
5,400	1,620	0.05~0.4	0.16	4,700	1,070	0.05~0.4	0.16	80	12	6
5,000	1,330	0.05~0.4	0.16	4,300	870	0.05~0.4	0.16	100		
4,500	1,200	0.05~0.4	0.16	3,900	790	0.05~0.4	0.16	120		
5,100	2,230	0.05~0.5	0.2	4,500	1,490	0.05~0.5	0.2	50		
4,700	1,850	0.05~0.5	0.2	4,100	1,220	0.05~0.5	0.2	60		
4,700	1,850	0.05~0.5	0.2	4,100	1,220	0.05~0.5	0.2	75	12	6
4,300	1,700	0.05~0.5	0.2	3,800	1,130	0.05~0.5	0.2	80		
4,300	1,700	0.05~0.5	0.2	3,800	1,130	0.05~0.5	0.2	100		
4,000	1,400	0.05~0.5	0.2	3,500	920	0.05~0.5	0.2	120		
4,200	2,100	0.05~0.6	0.24	3,700	1,400	0.05~0.6	0.24	60		
3,900	1,760	0.05~0.6	0.24	3,500	1,190	0.05~0.6	0.24	80	12	6
3,600	1,620	0.05~0.6	0.24	3,200	1,090	0.05~0.6	0.24	100		
3,600	1,620	0.05~0.6	0.24	3,200	1,090	0.05~0.6	0.24	120		

Epoch High Hard Ball-TH3

エポック ハイハードボール -TH3

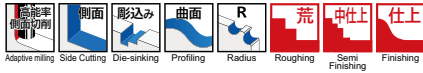

高硬度鋼加工用4枚刃ボールエンドミルに
TH3コーティングを適用し進化

高硬度鋼の加工で更なる長寿命な加工を実現

Evolved by adopting a TH3 coating on 4-flute ball end mill for high hardened steel processing. On high-hardened steel processing, to achieve even longer tool life.

RE公差 RE tolerance	RE0.5~RE1.5 : ±0.005 RE2~RE3 : ±0.007 RE4~RE6 : ±0.010	外径公差 Dia. tolerance	RE0.5~RE1.5 : 0~-0.010 RE2~RE3 : 0~-0.014 RE4~RE6 : 0~-0.020	h5
----------------------	--	------------------------	--	----

4枚刃
4Flutes

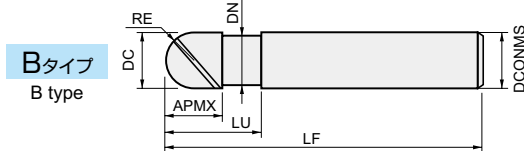
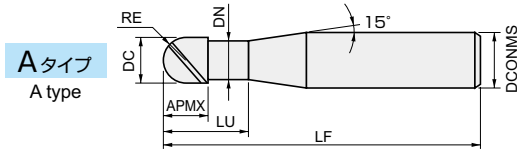

EHHBE4○○○(-S○)-TH3

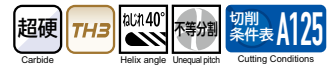

商品コード Item code	在庫 Stock	寸法 Size (mm)							刃数 No. of flutes	タイプ Type	希望小売価格 (円) Suggested retail price (¥)
		ボール半径 Ball radius	外径 Tool dia.	刃長 Flute length	首下長 Under neck length	首径 Neck dia.	全長 Overall length	シャンク径 Shank dia.			
		RE	DC	APMX	LU	DN	LF	DCONMS			
EHHBE4010-S4-TH3	●	0.5	1	1.5	3	0.95	50	4	4	A	11,250
EHHBE4010-S6-TH3	●			1.5	3	0.95	50	6	4	A	12,440
EHHBE4015-S4-TH3	●	0.75	1.5	2.5	4.5	1.43	50	4	4	A	11,900
EHHBE4015-S6-TH3	●			2.5	4.5	1.43	50	6	4	A	13,080
EHHBE4020-S4-TH3	●	1	2	3	6	1.9	50	4	4	A	11,900
EHHBE4020-S6-TH3	●			3	6	1.9	50	6	4	A	13,080
EHHBE4025-S4-TH3	●	1.25	2.5	4	7.5	2.38	50	4	4	A	12,540
EHHBE4025-S6-TH3	●			4	7.5	2.38	50	6	4	A	13,820
EHHBE4030-S4-TH3	●	1.5	3	4.5	9	2.9	70	4	4	A	12,540
EHHBE4030-S6-TH3	●			4.5	9	2.9	70	6	4	A	13,820
EHHBE4040-S4-TH3	●	2	4	6	12	3.9	70	4	4	B	12,540
EHHBE4040-S6-TH3	●			6	12	3.9	70	6	4	A	13,820
EHHBE4050-TH3	●	2.5	5	7.5	15	4.7	80	6	4	A	15,600
EHHBE4060-TH3	●	3	6	9	18	5.7	90	6	4	B	16,500
EHHBE4080-TH3	●	4	8	12	24	7.6	100	8	4	B	21,550
EHHBE4100-TH3	●	5	10	15	30	9.5	100	10	4	B	27,490
EHHBE4120-TH3	●	6	12	18	36	11.5	110	12	4	B	35,690

対応被削材 Applicable work material

炭素鋼 合金鋼 Carbon steel Alloy steel	プリハー ド鋼 Pre-hardened steel ≤ 45HRC	高硬度 Hardened steel			ステン レス鋼 Stainless steel	チタン合金 耐熱合金 Titanium alloy Heat-resistant alloy	銅合金 Copper alloy	アルミ 合金 Aluminum alloy
○	○	> 45HRC ≤ 55HRC	> 55HRC ≤ 65HRC	> 65HRC	○	○	○	

○ : 標準在庫品です。 ● : Stocked items.

再研磨対応外径範囲 Re-grinding compatibility range

商品コード Item code	外周 Outer dia. (mm)	エンド End (mm)
EHHBE-TH3	4 ~ 12	4 ~ 12

標準切削条件表 Recommended cutting conditions **EHHBE-TH3**

荒加工

Roughing

55HRC未満の被削材に関しましては、弊社2枚刃、3枚刃シリーズを推奨致します。
For work materials with hardnesses up to 55HRC, we recommend our company's 2-flute or 3-flute tool series.

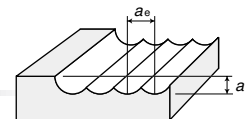

被削材 Work material		焼入れ鋼 Hardened steels (55~62HRC) SKD11, YXR3				焼入れ鋼 Hardened steels (62~66HRC) HAP40, YXR7, SKH51				焼入れ鋼 Hardened steels (66~72HRC) HAP72			
ボール半径 RE Ball radius (mm)	外径 DC Tool dia. (mm)	切削速度 $v_c=110\text{m/min}$				切削速度 $v_c=90\text{m/min}$				切削速度 $v_c=70\text{m/min}$			
		回転数 n min^{-1}	送り速度 v_f mm/min	a_p mm	a_e mm	回転数 n min^{-1}	送り速度 v_f mm/min	a_p mm	a_e mm	回転数 n min^{-1}	送り速度 v_f mm/min	a_p mm	a_e mm
0.5	1	35,000	1,930	0.08	0.23	28,700	1,340	0.06	0.18	22,300	860	0.05	0.14
0.75	1.5	23,400	1,760	0.11	0.34	19,100	1,220	0.09	0.27	14,900	780	0.07	0.20
1	2	17,500	1,750	0.15	0.45	14,300	1,220	0.12	0.36	11,100	780	0.09	0.27
1.25	2.5	14,000	1,650	0.19	0.56	11,500	1,150	0.15	0.45	8,900	730	0.11	0.34
1.5	3	11,700	1,650	0.23	0.68	9,600	1,150	0.18	0.54	7,400	730	0.14	0.41
2	4	8,800	1,670	0.30	0.90	7,200	1,160	0.24	0.72	5,600	740	0.18	0.54
2.5	5	7,000	1,700	0.38	1.13	5,700	1,170	0.30	0.90	4,500	760	0.23	0.68
3	6	5,800	1,690	0.45	1.35	4,800	1,190	0.36	1.08	3,700	750	0.27	0.81
4	8	4,400	1,760	0.60	1.80	3,600	1,220	0.48	1.44	2,800	780	0.36	1.08
5	10	3,500	1,750	0.75	2.25	2,900	1,230	0.60	1.80	2,200	770	0.45	1.35
6	12	2,900	1,650	0.90	2.70	2,400	1,160	0.72	2.16	1,900	760	0.54	1.62

側面加工

Side Cutting

55HRC未満の被削材に関しましては、弊社2枚刃、3枚刃シリーズを推奨致します。
For work materials with hardnesses up to 55HRC, we recommend our company's 2-flute or 3-flute tool series.

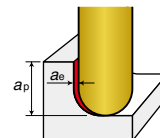

被削材 Work material		焼入れ鋼 Hardened steels (55~62HRC) SKD11, YXR3				焼入れ鋼 Hardened steels (62~66HRC) HAP40, YXR7, SKH51				焼入れ鋼 Hardened steels (66~72HRC) HAP72			
ボール半径 RE Ball radius (mm)	外径 DC Tool dia. (mm)	切削速度 $v_c=150\text{m/min}$				切削速度 $v_c=125\text{m/min}$				切削速度 $v_c=100\text{m/min}$			
		回転数 n min^{-1}	送り速度 v_f mm/min	a_p mm	a_e mm	回転数 n min^{-1}	送り速度 v_f mm/min	a_p mm	a_e mm	回転数 n min^{-1}	送り速度 v_f mm/min	a_p mm	a_e mm
0.5	1	47,800	2,630	1.00	0.02	39,800	1,750	1.00	0.02	31,800	1,050	1.00	0.01
0.75	1.5	31,800	2,390	1.50	0.03	26,500	1,590	1.50	0.02	21,200	950	1.50	0.02
1	2	23,900	2,390	2.00	0.04	19,900	1,590	2.00	0.03	15,900	950	2.00	0.02
1.25	2.5	19,100	2,240	2.50	0.05	15,900	1,490	2.50	0.04	12,700	900	2.50	0.03
1.5	3	15,900	2,240	3.00	0.06	13,300	1,500	3.00	0.05	10,600	900	3.00	0.03
2	4	11,900	2,260	4.00	0.08	10,000	1,520	4.00	0.06	8,000	910	4.00	0.04
2.5	5	9,600	2,330	5.00	0.10	8,000	1,550	5.00	0.08	6,400	930	5.00	0.05
3	6	8,000	2,330	6.00	0.12	6,600	1,540	6.00	0.09	5,300	930	6.00	0.06
4	8	6,000	2,400	8.00	0.16	5,000	1,600	8.00	0.12	4,000	960	8.00	0.08
5	10	4,800	2,400	10.00	0.20	4,000	1,600	10.00	0.15	3,200	960	10.00	0.10
6	12	4,000	2,280	12.00	0.24	3,300	1,500	12.00	0.18	2,700	920	12.00	0.12

	55~62HRC	62~66HRC	66~72HRC
ヘリカル穴加工時の傾斜角 Slant angle for helical boring	1°	0.5°	0.2°
ヘリカル穴加工時の送り速度 Feed rate for helical boring	側面加工条件の70% 70% of side cutting conditions		

※ヘリカル穴加工時の穴径は、工具径の1.6倍以上2.0倍未満に設定ください。
※ヘリカル穴加工時の最大深さは工具径以下(1DC以下)に設定ください。
※Set the hole diameter for helical boring to between 1.6 and 2.0 times the tool diameter.
※Set the maximum depth for helical boring to the tool diameter or smaller ($\leq 1DC$).

- [注意]** ①被削材、加工形状に合わせて、適切なクーラントを使用してください。
②できるだけ高剛性、高精度の機械をご使用ください。
③この切削条件表は切削条件の目安を示すものです。実際の加工では加工形状、目的、使用機械等により条件を調整してください。
④機械の回転数が足りない場合には、回転数と送り速度を同じ比率で下げてください。
- [Note]** ① Use the appropriate coolant for the work material and machining shape.
② Use as highly rigid and accurate machine as possible.
③ These conditions are for general guidance; in actual machining conditions adjust the parameters according to your actual machine and work-piece conditions.
④ If the rpm available is lower than that recommended please reduce the feed rate to the same ratio.

エポックハイハードボール-TH3

超硬ボールエンドミル

仕上げ加工 Finishing

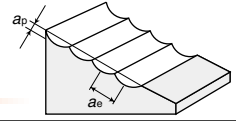

被削材 Work material		工具鋼 Tool steels (25~35HRC) HPM7, SCM440				プリハードン鋼 Pre-hardened steels (35~45HRC) HPM-MAGIC, CENA1				焼入れ鋼 Hardened steels (45~55HRC) SKD61, HPM38, DAC-MAGIC			
ボール半径 RE Ball radius (mm)	外径 DC Tool dia. (mm)	切削速度 $v_c=280\text{m/min}$				切削速度 $v_c=250\text{m/min}$				切削速度 $v_c=210\text{m/min}$			
		回転数 n min ⁻¹	送り速度 v_f mm/min	a_p mm	a_e mm	回転数 n min ⁻¹	送り速度 v_f mm/min	a_p mm	a_e mm	回転数 n min ⁻¹	送り速度 v_f mm/min	a_p mm	a_e mm
0.5	1	60,000	3,240	0.02~0.05	0.02	60,000	2,970	0.02~0.05	0.02	60,000	2,700	0.02~0.05	0.02
0.75	1.5	60,000	4,860	0.02~0.07	0.03	53,100	3,940	0.02~0.07	0.03	44,600	3,010	0.02~0.07	0.03
1	2	44,600	4,820	0.02~0.10	0.04	39,800	3,940	0.02~0.10	0.04	33,400	3,010	0.02~0.10	0.04
1.25	2.5	35,700	5,030	0.05~0.12	0.05	31,800	4,110	0.05~0.12	0.05	26,800	3,150	0.05~0.12	0.05
1.5	3	29,700	5,030	0.05~0.15	0.06	26,500	4,110	0.05~0.15	0.06	22,300	3,140	0.05~0.15	0.06
2	4	22,300	5,080	0.05~0.20	0.08	19,900	4,160	0.05~0.20	0.08	16,700	3,170	0.05~0.20	0.08
2.5	5	17,800	5,180	0.05~0.25	0.1	15,900	4,240	0.05~0.25	0.1	13,400	3,250	0.05~0.25	0.10
3	6	14,900	5,200	0.05~0.3	0.12	13,300	4,260	0.05~0.3	0.12	11,100	3,230	0.05~0.3	0.12
4	8	11,100	5,330	0.05~0.4	0.16	10,000	4,400	0.05~0.4	0.16	8,400	3,360	0.05~0.4	0.16
5	10	8,900	5,340	0.05~0.5	0.2	8,000	4,400	0.05~0.5	0.2	6,700	3,350	0.05~0.5	0.20
6	12	7,400	5,060	0.05~0.6	0.24	6,600	4,140	0.05~0.6	0.24	5,600	3,190	0.05~0.6	0.24

被削材 Work material		焼入れ鋼 Hardened steels (55~62HRC) SKD11, YXR3				焼入れ鋼 Hardened steels (62~66HRC) HAP40, YXR7, SKH51				焼入れ鋼 Hardened steels (66~72HRC) HAP72			
ボール半径 RE Ball radius (mm)	外径 DC Tool dia. (mm)	切削速度 $v_c=160\text{m/min}$				切削速度 $v_c=140\text{m/min}$				切削速度 $v_c=120\text{m/min}$			
		回転数 n min ⁻¹	送り速度 v_f mm/min	a_p mm	a_e mm	回転数 n min ⁻¹	送り速度 v_f mm/min	a_p mm	a_e mm	回転数 n min ⁻¹	送り速度 v_f mm/min	a_p mm	a_e mm
0.5	1	51,000	1,840	0.02~0.05	0.02	44,600	1,300	0.02~0.05	0.02	38,200	950	0.02~0.05	0.02
0.75	1.5	34,000	1,840	0.02~0.07	0.03	29,700	1,300	0.02~0.07	0.03	25,500	950	0.02~0.07	0.03
1	2	25,500	1,840	0.02~0.10	0.04	22,300	1,300	0.02~0.10	0.04	19,100	950	0.02~0.10	0.04
1.25	2.5	20,400	1,920	0.05~0.12	0.05	17,800	1,360	0.05~0.12	0.05	15,300	990	0.05~0.12	0.05
1.5	3	17,000	1,920	0.05~0.15	0.06	14,900	1,370	0.05~0.15	0.06	12,700	980	0.05~0.15	0.06
2	4	12,700	1,930	0.05~0.20	0.08	11,100	1,370	0.05~0.20	0.08	9,600	1,000	0.05~0.20	0.08
2.5	5	10,200	1,980	0.05~0.25	0.10	8,900	1,400	0.05~0.25	0.10	7,600	1,010	0.05~0.25	0.10
3	6	8,500	1,980	0.05~0.3	0.12	7,400	1,400	0.05~0.3	0.12	6,400	1,020	0.05~0.3	0.12
4	8	6,400	2,050	0.05~0.4	0.16	5,600	1,460	0.05~0.4	0.16	4,800	1,060	0.05~0.4	0.16
5	10	5,100	2,040	0.05~0.5	0.20	4,500	1,460	0.05~0.5	0.20	3,800	1,050	0.05~0.5	0.20
6	12	4,200	1,920	0.05~0.6	0.24	3,700	1,370	0.05~0.6	0.24	3,200	1,000	0.05~0.6	0.24

- 【注意】** ①被削材、加工形状に合わせて、適切なクーラントを使用してください。 **【Note】** ① Use the appropriate coolant for the work material and machining shape.
 ②できるだけ高剛性、高精度の機械をご使用ください。 ② Use as highly rigid and accurate machine as possible.
 ③この切削条件表は切削条件の目安を示すものです。実際の加工では加工形状、目的、使用機械等により条件を調整してください。 ③ These conditions are for general guidance; in actual machining conditions adjust the parameters according to your actual machine and work-piece conditions.
 ④機械の回転数が足りない場合には、回転数と送り速度を同じ比率で下げてください。 ④ If the rpm available is lower than that recommended please reduce the feed rate to the same ratio.

性能・位置づけ Performance and positioning

EHHBE-TH3は高硬度鋼(55HRC~)の荒加工~中仕上げ加工領域で性能を発揮

EHHBE-TH3 exhibits the performance during roughing to semi-finishing of high hardened steel (55HRC~).

高硬度鋼 Hardened steel (HRC)



Epoch High Hard Ball エポック ハイハードボール

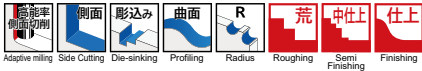

RE公差 RE tolerance	RE0.5~RE1.5 : ±0.005 RE2~RE3 : ±0.007 RE4~RE6 : ±0.010
----------------------	--

外径公差 Dia tolerance	RE0.5~RE1.5 : 0~-0.010 RE2~RE3 : 0~-0.014 RE4~RE6 : 0~-0.020
-----------------------	--



(mm)

4枚刃でさらなる高効率加工を!
新刃形の採用により、高硬度鋼で威力を発揮!
4 flutes provide cutting with even higher performance.
New flute shape shows its power on hardened steels.

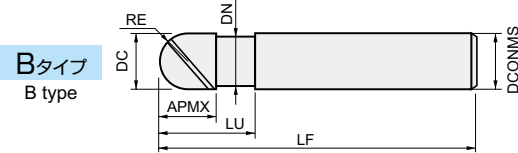
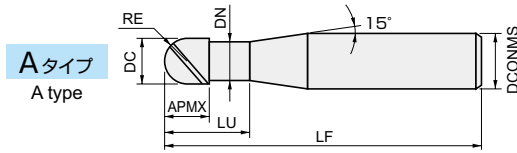

EHHB4000(-S)-ATH



商品コード Item code	在庫 Stock	寸法 Size (mm)							刃数 No. of flutes	タイプ Type	希望小売価格(円) Suggested retail price(¥)
		ボール半径 Ball radius RE	外径 Tool dia. DC	刃長 Flute length APMX	首下長 Under neck length LU	首径 Neck dia. DN	全長 Overall length LF	シャンク径 Shank dia. DCONMS			
EHHB4010-S4-ATH	●	0.5	1	1.5	3	0.95	50	4	4	A	11,250
EHHB4010-S6-ATH	●			1.5	3	0.95	50	6	4	A	12,440
EHHB4015-S4-ATH	●	0.75	1.5	2.5	4.5	1.43	50	4	4	A	11,900
EHHB4015-S6-ATH	●			2.5	4.5	1.43	50	6	4	A	13,080
EHHB4020-S4-ATH	●	1	2	3	6	1.9	50	4	4	A	11,900
EHHB4020-S6-ATH	●			3	6	1.9	50	6	4	A	13,080
EHHB4025-S4-ATH	●	1.25	2.5	4	7.5	2.38	50	4	4	A	12,540
EHHB4025-S6-ATH	●			4	7.5	2.38	50	6	4	A	13,820
EHHB4030-S4-ATH	●	1.5	3	4.5	9	2.9	70	4	4	A	12,540
EHHB4030-S6-ATH	●			4.5	9	2.9	70	6	4	A	13,820
EHHB4040-S4-ATH	●	2	4	6	12	3.9	70	4	4	B	12,540
EHHB4040-S6-ATH	●			6	12	3.9	70	6	4	A	13,820
EHHB4050-ATH	●	2.5	5	7.5	15	4.7	80	6	4	A	15,600
EHHB4060-ATH	●	3	6	9	18	5.7	90	6	4	B	16,500
EHHB4080-ATH	●	4	8	12	24	7.6	100	8	4	B	21,550
EHHB4100-ATH	●	5	10	15	30	9.5	100	10	4	B	27,490
EHHB4120-ATH	●	6	12	18	36	11.5	110	12	4	B	35,690

○ 対応被削材 Applicable work material

炭素鋼 合金鋼 Alloy steel	プリハードン鋼 Pre-hardened steel	高硬度 Hardened steel			ステンレス鋼 Stainless steel	チタン合金 耐熱合金 Titanium alloy Heat-resistant alloy	銅合金 Copper alloy	アルミ合金 Aluminum alloy
○	○	> 45HRC ≤ 55HRC	> 55HRC ≤ 65HRC	> 65HRC	○	○	○	

● : 標準在庫品です。 ● : Stocked items.

○ 再研磨対応外径範囲 Re-grinding compatibility range

商品コード Item code	外周 Outer dia. (mm)	エンド End (mm)
EHHB-ATH	4 ~ 12	4 ~ 12

Epoch High Hard Ball エポック ハイハードボール

標準切削条件表 Recommended cutting conditions EHHB-ATH

超硬合金ドリル
ボールエンドドリル

荒加工 Roughing

55HRC未満の被削材につきましては、弊社2枚刃、3枚刃シリーズを推奨致します。
For work materials with hardnesses up to 55HRC, we recommend our company's 2-flute or 3-flute tool series.

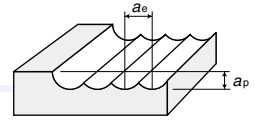

被削材 Work material		焼入れ鋼 Hardened steels (55~62HRC) SKD11, YXR3				焼入れ鋼 Hardened steels (62~66HRC) HAP40, YXR7, SKH51				焼入れ鋼 Hardened steels (66~72HRC) HAP72			
ボール半径 RE Ball radius (mm)	外径 DC Tool dia. (mm)	切削速度 $v_c=110\text{m/min}$				切削速度 $v_c=90\text{m/min}$				切削速度 $v_c=70\text{m/min}$			
		回転数 n min ⁻¹	送り速度 v_f mm/min	a_p mm	a_e mm	回転数 n min ⁻¹	送り速度 v_f mm/min	a_p mm	a_e mm	回転数 n min ⁻¹	送り速度 v_f mm/min	a_p mm	a_e mm
0.5	1	35,000	1,930	0.08	0.23	28,700	1,340	0.06	0.18	22,300	860	0.05	0.14
0.75	1.5	23,400	1,760	0.11	0.34	19,100	1,220	0.09	0.27	14,900	780	0.07	0.20
1	2	17,500	1,750	0.15	0.45	14,300	1,220	0.12	0.36	11,100	780	0.09	0.27
1.25	2.5	14,000	1,650	0.19	0.56	11,500	1,150	0.15	0.45	8,900	730	0.11	0.34
1.5	3	11,700	1,650	0.23	0.68	9,600	1,150	0.18	0.54	7,400	730	0.14	0.41
2	4	8,800	1,670	0.30	0.90	7,200	1,160	0.24	0.72	5,600	740	0.18	0.54
2.5	5	7,000	1,700	0.38	1.13	5,700	1,170	0.30	0.90	4,500	760	0.23	0.68
3	6	5,800	1,690	0.45	1.35	4,800	1,190	0.36	1.08	3,700	750	0.27	0.81
4	8	4,400	1,760	0.60	1.80	3,600	1,220	0.48	1.44	2,800	780	0.36	1.08
5	10	3,500	1,750	0.75	2.25	2,900	1,230	0.60	1.80	2,200	770	0.45	1.35
6	12	2,900	1,650	0.90	2.70	2,400	1,160	0.72	2.16	1,900	760	0.54	1.62

側面加工 Side Cutting

55HRC未満の被削材につきましては、弊社2枚刃、3枚刃シリーズを推奨致します。
For work materials with hardnesses up to 55HRC, we recommend our company's 2-flute or 3-flute tool series.

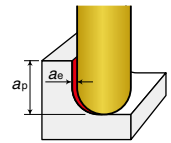

被削材 Work material		焼入れ鋼 Hardened steels (55~62HRC) SKD11, YXR3				焼入れ鋼 Hardened steels (62~66HRC) HAP40, YXR7, SKH51				焼入れ鋼 Hardened steels (66~72HRC) HAP72			
ボール半径 RE Ball radius (mm)	外径 DC Tool dia. (mm)	切削速度 $v_c=150\text{m/min}$				切削速度 $v_c=125\text{m/min}$				切削速度 $v_c=100\text{m/min}$			
		回転数 n min ⁻¹	送り速度 v_f mm/min	a_p mm	a_e mm	回転数 n min ⁻¹	送り速度 v_f mm/min	a_p mm	a_e mm	回転数 n min ⁻¹	送り速度 v_f mm/min	a_p mm	a_e mm
0.5	1	47,800	2,630	1.00	0.02	39,800	1,750	1.00	0.02	31,800	1,050	1.00	0.01
0.75	1.5	31,800	2,390	1.50	0.03	26,500	1,590	1.50	0.02	21,200	950	1.50	0.02
1	2	23,900	2,390	2.00	0.04	19,900	1,590	2.00	0.03	15,900	950	2.00	0.02
1.25	2.5	19,100	2,240	2.50	0.05	15,900	1,490	2.50	0.04	12,700	900	2.50	0.03
1.5	3	15,900	2,240	3.00	0.06	13,300	1,500	3.00	0.05	10,600	900	3.00	0.03
2	4	11,900	2,260	4.00	0.08	10,000	1,520	4.00	0.06	8,000	910	4.00	0.04
2.5	5	9,600	2,330	5.00	0.10	8,000	1,550	5.00	0.08	6,400	930	5.00	0.05
3	6	8,000	2,330	6.00	0.12	6,600	1,540	6.00	0.09	5,300	930	6.00	0.06
4	8	6,000	2,400	8.00	0.16	5,000	1,600	8.00	0.12	4,000	960	8.00	0.08
5	10	4,800	2,400	10.00	0.20	4,000	1,600	10.00	0.15	3,200	960	10.00	0.10
6	12	4,000	2,280	12.00	0.24	3,300	1,500	12.00	0.18	2,700	920	12.00	0.12

	55~62HRC	62~66HRC	66~72HRC
ヘリカル穴加工時の傾斜角 Slant angle for helical boring	1°	0.5°	0.2°
ヘリカル穴加工時の送り速度 Feed rate for helical boring	側面加工条件の70% 70% of side cutting conditions		

※ヘリカル穴加工時の穴径は、工具径の1.6倍以上2.0倍未満に設定ください。
※ヘリカル穴加工時の最大深さは工具径以下(1DC以下)に設定ください。
※Set the hole diameter for helical boring to between 1.6 and 2.0 times the tool diameter.
※Set the maximum depth for helical boring to the tool diameter or smaller ($\leq 1DC$).

- [注意]** ①被削材、加工形状に合わせて、適切なクーラントを使用してください。
②できるだけ高剛性、高精度の機械をご使用ください。
③この切削条件表は切削条件の目安を示すものです。実際の加工では加工形状、目的、使用機械等により条件を調整してください。
④機械の回転数が足りない場合には、回転数と送り速度を同じ比率で下げてください。
- [Note]** ① Use the appropriate coolant for the work material and machining shape.
② Use as highly rigid and accurate machine as possible.
③ These conditions are for general guidance; in actual machining conditions adjust the parameters according to your actual machine and work-piece conditions.
④ If the rpm available is lower than that recommended please reduce the feed rate to the same ratio.

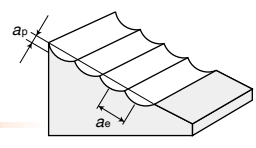

仕上げ加工 Finishing

被削材 Work material		工具鋼 Tool steels (25~35HRC) HPM7, SCM440				プリハードン鋼 Pre-hardened steels (35~45HRC) HPM-MAGIC, CENA1				焼入れ鋼 Hardened steels (45~55HRC) SKD61, HPM38, DAC-MAGIC			
ボール半径 RE Ball radius (mm)	外径 DC Tool dia. (mm)	切削速度 $v_c=280\text{m/min}$				切削速度 $v_c=250\text{m/min}$				切削速度 $v_c=210\text{m/min}$			
		回転数 n min^{-1}	送り速度 v_f mm/min	a_p mm	a_e mm	回転数 n min^{-1}	送り速度 v_f mm/min	a_p mm	a_e mm	回転数 n min^{-1}	送り速度 v_f mm/min	a_p mm	a_e mm
0.5	1	60,000	3,240	0.02~0.05	0.02	60,000	2,970	0.02~0.05	0.02	60,000	2,700	0.02~0.05	0.02
0.75	1.5	60,000	4,860	0.02~0.07	0.03	53,100	3,940	0.02~0.07	0.03	44,600	3,010	0.02~0.07	0.03
1	2	44,600	4,820	0.02~0.10	0.04	39,800	3,940	0.02~0.10	0.04	33,400	3,010	0.02~0.10	0.04
1.25	2.5	35,700	5,030	0.05~0.12	0.05	31,800	4,110	0.05~0.12	0.05	26,800	3,150	0.05~0.12	0.05
1.5	3	29,700	5,030	0.05~0.15	0.06	26,500	4,110	0.05~0.15	0.06	22,300	3,140	0.05~0.15	0.06
2	4	22,300	5,080	0.05~0.20	0.08	19,900	4,160	0.05~0.20	0.08	16,700	3,170	0.05~0.20	0.08
2.5	5	17,800	5,180	0.05~0.25	0.1	15,900	4,240	0.05~0.25	0.1	13,400	3,250	0.05~0.25	0.10
3	6	14,900	5,200	0.05~0.3	0.12	13,300	4,260	0.05~0.3	0.12	11,100	3,230	0.05~0.3	0.12
4	8	11,100	5,330	0.05~0.4	0.16	10,000	4,400	0.05~0.4	0.16	8,400	3,360	0.05~0.4	0.16
5	10	8,900	5,340	0.05~0.5	0.2	8,000	4,400	0.05~0.5	0.2	6,700	3,350	0.05~0.5	0.20
6	12	7,400	5,060	0.05~0.6	0.24	6,600	4,140	0.05~0.6	0.24	5,600	3,190	0.05~0.6	0.24

被削材 Work material		焼入れ鋼 Hardened steels (55~62HRC) SKD11, YXR3				焼入れ鋼 Hardened steels (62~66HRC) HAP40, YXR7, SKH51				焼入れ鋼 Hardened steels (66~72HRC) HAP72			
ボール半径 RE Ball radius (mm)	外径 DC Tool dia. (mm)	切削速度 $v_c=160\text{m/min}$				切削速度 $v_c=140\text{m/min}$				切削速度 $v_c=120\text{m/min}$			
		回転数 n min^{-1}	送り速度 v_f mm/min	a_p mm	a_e mm	回転数 n min^{-1}	送り速度 v_f mm/min	a_p mm	a_e mm	回転数 n min^{-1}	送り速度 v_f mm/min	a_p mm	a_e mm
0.5	1	51,000	1,840	0.02~0.05	0.02	44,600	1,300	0.02~0.05	0.02	38,200	950	0.02~0.05	0.02
0.75	1.5	34,000	1,840	0.02~0.07	0.03	29,700	1,300	0.02~0.07	0.03	25,500	950	0.02~0.07	0.03
1	2	25,500	1,840	0.02~0.10	0.04	22,300	1,300	0.02~0.10	0.04	19,100	950	0.02~0.10	0.04
1.25	2.5	20,400	1,920	0.05~0.12	0.05	17,800	1,360	0.05~0.12	0.05	15,300	990	0.05~0.12	0.05
1.5	3	17,000	1,920	0.05~0.15	0.06	14,900	1,370	0.05~0.15	0.06	12,700	980	0.05~0.15	0.06
2	4	12,700	1,930	0.05~0.20	0.08	11,100	1,370	0.05~0.20	0.08	9,600	1,000	0.05~0.20	0.08
2.5	5	10,200	1,980	0.05~0.25	0.10	8,900	1,400	0.05~0.25	0.10	7,600	1,010	0.05~0.25	0.10
3	6	8,500	1,980	0.05~0.3	0.12	7,400	1,400	0.05~0.3	0.12	6,400	1,020	0.05~0.3	0.12
4	8	6,400	2,050	0.05~0.4	0.16	5,600	1,460	0.05~0.4	0.16	4,800	1,060	0.05~0.4	0.16
5	10	5,100	2,040	0.05~0.5	0.20	4,500	1,460	0.05~0.5	0.20	3,800	1,050	0.05~0.5	0.20
6	12	4,200	1,920	0.05~0.6	0.24	3,700	1,370	0.05~0.6	0.24	3,200	1,000	0.05~0.6	0.24

- 【注意】** ①被削材、加工形状に合わせて、適切なクーラントを使用してください。 **【Note】** ① Use the appropriate coolant for the work material and machining shape.
 ②できるだけ高剛性、高精度の機械をご使用ください。 ② Use as highly rigid and accurate machine as possible.
 ③この切削条件表は切削条件の目安を示すものです。実際の加工では加工形状、目的、使用機械等により条件を調整してください。 ③ These conditions are for general guidance; in actual machining conditions adjust the parameters according to your actual machine and work-piece conditions.
 ④機械の回転数が足りない場合には、回転数と送り速度を同じ比率で下げてください。 ④ If the rpm available is lower than that recommended please reduce the feed rate to the same ratio.

6 Flutes Ball End Mill for High-efficiency Finishing 高能率仕上げ用6枚刃ボールエンドミル



6枚刃仕様で送り速度20m/min以上の仕上げ加工に対応!!
6 flutes specification enables finishing at feed rate of 20m/min.



±0.01



(mm)

6枚刃
6 flutes

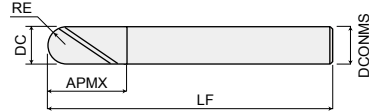

EPHB6-PP-PP



商品コード Item code	在庫 Stock	寸法 Size (mm)					刃数 No. of flutes	希望小売価格 (円) Suggested retail price (¥)
		ボール半径 Ball radius RE	外径 Tool dia. DC	刃長 Flute length APMX	全長 Overall Length LF	シャンク径 Shank dia. DCONMS		
EPHB6060-PN	●	3	6	6	90	6	19,760	
EPHB6080-PN	●	4	8	8	100	6	25,810	
EPHB6100-PN	●	5	10	10	100	6	32,990	
EPHB6120-PN	●	6	12	12	110	6	42,870	

○ ボール半径別の6枚刃使用可能範囲 6 flutes usable range by ball radius

ボール刃中心は2枚刃となりますが切れ刃は設けていますので3軸機でもご使用できます。5軸機等を用いて下記の6枚刃の範囲をご使用いただくことでEPHB-PNのポテンシャルが発揮されます。

It is usable with 3-axis MC since tool center has cutting edges even 2 flutes.
EPHB-PN could perform at its true potential by using the following 6 flutes range with 5-axis machine, etc..

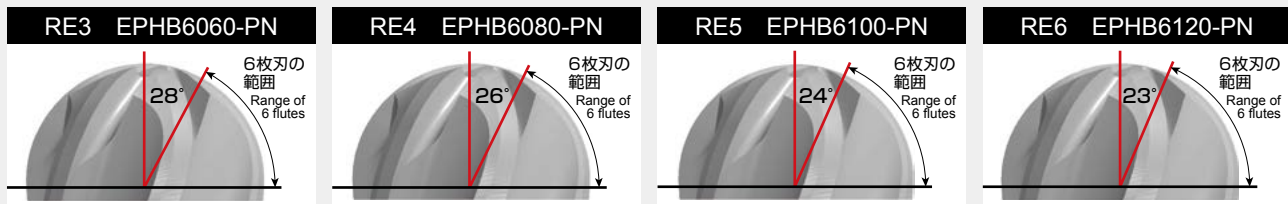

※表記角度は6枚刃ではない範囲を示します。主轴を傾けて使用される場合は、切り込み量等を考慮して角度設定を行ってください。
Angle represents non-6 flutes part. When machining with spindle tilted, please set the angle of spindle considering a_p etc.

○ 対応被削材 Applicable work material

炭素鋼 合金鋼 Carbon steel Alloy steel	プリハードン鋼 Pre-hardened steel	高硬度 Hardened steel			ステンレス鋼 Stainless steel	チタン合金 耐熱合金 Titanium alloy Heat-resistant alloy	銅合金 Copper alloy	アルミ合金 Aluminum alloy
○	○	> 45HRC ≤ 55HRC	> 55HRC ≤ 65HRC	> 65HRC	○			

○ 再研磨対応外径範囲 Re-grinding compatibility range

商品コード Item code	外周 Outer dia. (mm)	エンド End (mm)
EPHB6-PN	× (N/A)	6 ~ 12

○ : 標準在庫品です。 ● : Stocked items.

標準切削条件表 Recommended cutting conditions

EPHB-PN

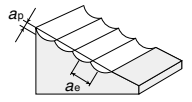

標準切削条件 (仕上げ加工) Standard cutting conditions (Finishing)

被削材 Work material		炭素鋼・合金鋼 Carbon steels, Alloy steels (180~250HB)				ステンレス鋼・工具鋼 Stainless steels, Tool steels (25~35HRC)				プリハードン鋼 Pre-hardened steels (35~45HRC)			
ボール半径 Ball radius (mm) RE	外径 Tool dia. (mm) DC	切削速度 Cutting speed $v_c=200\text{m/min}$				切削速度 Cutting speed $v_c=180\text{m/min}$				切削速度 Cutting speed $v_c=160\text{m/min}$			
		回転数 n min ⁻¹	送り速度 v_f mm/min	a_p (mm)	a_e (mm)	回転数 n min ⁻¹	送り速度 v_f mm/min	a_p (mm)	a_e (mm)	回転数 n min ⁻¹	送り速度 v_f mm/min	a_p (mm)	a_e (mm)
RE3	6	10,600	5,720	≤0.2	≤0.2	9,500	5,130	≤0.2	≤0.2	8,500	4,590	≤0.2	≤0.2
RE4	8	8,000	5,760	≤0.3	≤0.3	7,200	5,180	≤0.2	≤0.2	6,400	4,610	≤0.2	≤0.2
RE5	10	6,400	5,760	≤0.3	≤0.3	5,700	5,130	≤0.3	≤0.3	5,100	4,590	≤0.2	≤0.2
RE6	12	5,300	5,720	≤0.3	≤0.3	4,800	5,180	≤0.3	≤0.3	4,200	4,540	≤0.3	≤0.3

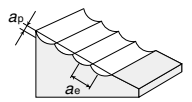

高速条件 (仕上げ加工) High speed cutting conditions (Finishing)

被削材 Work material		炭素鋼・合金鋼 Carbon steels, Alloy steels (180~250HB)				ステンレス鋼・工具鋼 Stainless steels, Tool steels (25~35HRC)				プリハードン鋼 Pre-hardened steels (35~45HRC)			
ボール半径 Ball radius (mm) RE	外径 Tool dia. (mm) DC	切削速度 Cutting speed $v_c=375\text{m/min}$				切削速度 Cutting speed $v_c=340\text{m/min}$				切削速度 Cutting speed $v_c=300\text{m/min}$			
		回転数 n min ⁻¹	送り速度 v_f mm/min	a_p (mm)	a_e (mm)	回転数 n min ⁻¹	送り速度 v_f mm/min	a_p (mm)	a_e (mm)	回転数 n min ⁻¹	送り速度 v_f mm/min	a_p (mm)	a_e (mm)
RE3	6	19,900	21,490	≤0.1	≤0.1	17,900	19,330	≤0.1	≤0.1	15,900	15,450	≤0.1	≤0.1
RE4	8	14,900	21,460	≤0.1	≤0.1	13,400	19,300	≤0.1	≤0.1	11,900	15,420	≤0.1	≤0.1
RE5	10	11,900	21,420	≤0.2	≤0.2	10,700	19,260	≤0.2	≤0.2	9,500	15,390	≤0.1	≤0.1
RE6	12	9,900	21,380	≤0.2	≤0.2	9,000	19,440	≤0.2	≤0.2	8,000	15,550	≤0.2	≤0.2

- [注意]**
- ① 3DC以下の突き出し長で、高性能マシニングセンターにより高送りに追従できる加工形状であれば高速条件が適用可能です。
 - ② 先端まで切れ刃は設計しているため3軸加工でも使用可能ですが、6枚刃を機能させるためには30°以上傾けてご使用ください。
 - ③ ボール刃中心部付近(2枚刃の範囲)で加工する場合は、送り速度を1/3程度にしてください。
 - ④ a_e (切り込み)は参考値となります。カスプハイト等を参考に決定ください。
 - ⑤ 被削材、加工形状に合わせて、適切なクーラントを使用してください。
 - ⑥ できるだけ高剛性、高精度の機械をご使用ください。
 - ⑦ この切削条件表は切削条件の目安を示すものです。実際の加工では加工形状、目的、使用機械等により条件を調整してください。
 - ⑧ 機械の回転数が足りない場合は、回転数と送り速度を同じ比率で下げてください。

- [Note]**
- ① High speed cutting conditions are applicable as long as projection length of 3DC or less and work shape that can be followed by high performance MC.
 - ② Since cutting edge is designed even to the tip, it can be used for 3-axis machining. However, in order to allow the 6 flutes to function, please use it by tilting more than 30°.
 - ③ When machining near the center of the ball-nosed end cutting edge, please adjust the feed speed to about one third.
 - ④ a_e is a reference value. Please refer to cusp height etc. and set it.
 - ⑤ Use the appropriate coolant for the work material and machining shape.
 - ⑥ Use a highly rigid and accurate machine as possible.
 - ⑦ These Recommended Cutting Conditions indicate only the rule of a thumb for the cutting conditions. In actual machining, the condition should be adjusted according to the machining shape, purpose and the machine type.
 - ⑧ If the rpm available is lower than that recommended please reduce the feed rate to the same ratio.

ボールエンドミルのピックフィードと理論カスプハイト表 (μm) Ball end mill pick feed and theoretical cusp height table (μm)

		ピックフィード量: p_f (mm) Pick Feed							
		0.05	0.075	0.1	0.15	0.2	0.3	0.4	0.5
ボール半径RE Ball Radius (mm)	0.5	0.63	1.41	2.51	5.66	10.10	23.03	41.74	66.99
	1.0	0.31	0.70	1.25	2.82	5.01	11.31	20.20	31.75
	2.0	0.16	0.35	0.63	1.41	2.50	5.63	10.03	15.69
	3.0	0.10	0.23	0.42	0.94	1.67	3.75	6.67	10.43
	4.0	0.08	0.18	0.31	0.70	1.25	2.81	5.00	7.82
	5.0	0.06	0.14	0.25	0.56	1.00	2.25	4.00	6.25
	6.0	0.05	0.12	0.21	0.47	0.83	1.88	3.33	5.21
	8.0	0.04	0.09	0.16	0.35	0.63	1.41	2.50	3.91
	10.0	0.03	0.07	0.13	0.28	0.50	1.13	2.00	3.13

ピックフィードとカスプハイト
Pick Feed and Cusp Height

$$H = RE - \sqrt{RE^2 - p_f^2/4} \approx p_f^2/8RE$$

Taper Ball End Mill for High Accuracy Rib Slotting

エポックリブ溝加工用テーパボールエンドミル



リブ溝加工の新提案、放電加工から直彫加工へ
 New proposal for machining rib groove. From electric discharge machining to direct milling.



(mm)

先端2枚刃
 外周4枚刃
 Tip : 2 flutes
 Periphery : 4 flutes

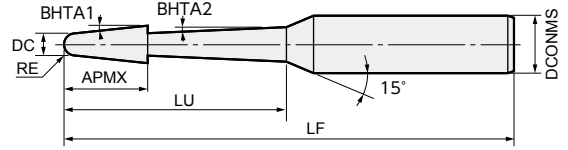

EB4HR ○○○○ TN-○○-○○-ATH



商品コード Item code	在庫 Stock	寸法 Size(mm)							首形状 Neck shape	首部テーパ半角 Neck angle (°)	希望小売 価格(円) Suggested retail price (¥)
		ボール半径 Ball radius RE	外径 Tool dia. DC	刃部テーパ半角 Taper angle on side BHTA1	首下長 Under Neck length LU	刃長 Flute length APMX	全長 Overall length LF	シャンク径 Shank dia. DCONMS			
EB4HR0060TN-4-05-ATH	●	0.3	0.6	0.5	4	3.2	50	4	A	-	18,210
EB4HR0060TN-5-05-ATH	●	0.3	0.6	0.5	5	3.2	50	4	A	-	18,210
EB4HR0060TN-6-05-ATH	●	0.3	0.6	0.5	6	3.2	50	4	A	-	18,330
EB4HR0060TN-7-05-ATH	●	0.3	0.6	0.5	7	3.2	50	4	B	0.5	18,330
EB4HR0060TN-8-05-ATH	●	0.3	0.6	0.5	8	3.2	50	4	B	0.5	18,330
EB4HR0060TN-9-05-ATH	●	0.3	0.6	0.5	9	3.2	50	4	B	0.5	18,430
EB4HR0060TN-10-05-ATH	●	0.3	0.6	0.5	10	3.2	50	4	B	0.5	18,430
EB4HR0060TN-4-10-ATH	●	0.3	0.6	1	4	3.2	50	4	A	-	18,210
EB4HR0060TN-5-10-ATH	●	0.3	0.6	1	5	3.2	50	4	A	-	18,210
EB4HR0060TN-6-10-ATH	●	0.3	0.6	1	6	3.2	50	4	A	-	18,330
EB4HR0060TN-7-10-ATH	●	0.3	0.6	1	7	3.2	50	4	B	1	18,330
EB4HR0060TN-8-10-ATH	●	0.3	0.6	1	8	3.2	50	4	B	1	18,330
EB4HR0060TN-9-10-ATH	●	0.3	0.6	1	9	3.2	50	4	B	1	18,430
EB4HR0060TN-10-10-ATH	●	0.3	0.6	1	10	3.2	50	4	B	1	18,430
EB4HR0070TN-4-05-ATH	●	0.35	0.7	0.5	4	3.2	50	4	A	-	17,140
EB4HR0070TN-5-05-ATH	●	0.35	0.7	0.5	5	3.2	50	4	A	-	17,140
EB4HR0070TN-6-05-ATH	●	0.35	0.7	0.5	6	3.2	50	4	A	-	17,260
EB4HR0070TN-7-05-ATH	●	0.35	0.7	0.5	7	3.2	50	4	B	0.5	17,260
EB4HR0070TN-8-05-ATH	●	0.35	0.7	0.5	8	3.2	50	4	B	0.5	17,360
EB4HR0070TN-9-05-ATH	●	0.35	0.7	0.5	9	3.2	50	4	B	0.5	17,360
EB4HR0070TN-10-05-ATH	●	0.35	0.7	0.5	10	3.2	50	4	B	0.5	17,360
EB4HR0070TN-4-10-ATH	●	0.35	0.7	1	4	3.2	50	4	A	-	17,140
EB4HR0070TN-5-10-ATH	●	0.35	0.7	1	5	3.2	50	4	A	-	17,140
EB4HR0070TN-6-10-ATH	●	0.35	0.7	1	6	3.2	50	4	A	-	17,260
EB4HR0070TN-7-10-ATH	●	0.35	0.7	1	7	3.2	50	4	B	1	17,260
EB4HR0070TN-8-10-ATH	●	0.35	0.7	1	8	3.2	50	4	B	1	17,360
EB4HR0070TN-9-10-ATH	●	0.35	0.7	1	9	3.2	50	4	B	1	17,360
EB4HR0070TN-10-10-ATH	●	0.35	0.7	1	10	3.2	50	4	B	1	17,360
EB4HR0080TN-4-05-ATH	●	0.4	0.8	0.5	4	3.2	50	4	A	-	16,190
EB4HR0080TN-6-05-ATH	●	0.4	0.8	0.5	6	3.2	50	4	A	-	16,290
EB4HR0080TN-8-05-ATH	●	0.4	0.8	0.5	8	3.2	50	4	B	0.5	16,290
EB4HR0080TN-10-05-ATH	●	0.4	0.8	0.5	10	3.2	50	4	B	0.5	16,400
EB4HR0080TN-12-05-ATH	●	0.4	0.8	0.5	12	3.2	55	4	B	0.5	16,500
EB4HR0080TN-14-05-ATH	●	0.4	0.8	0.5	14	3.2	55	4	B	0.5	16,610
EB4HR0080TN-4-10-ATH	●	0.4	0.8	1	4	3.2	50	4	A	-	16,190
EB4HR0080TN-6-10-ATH	●	0.4	0.8	1	6	3.2	50	4	A	-	16,290
EB4HR0080TN-8-10-ATH	●	0.4	0.8	1	8	3.2	50	4	B	1	16,290
EB4HR0080TN-10-10-ATH	●	0.4	0.8	1	10	3.2	50	4	B	1	16,400
EB4HR0080TN-12-10-ATH	●	0.4	0.8	1	12	3.2	55	4	B	1	16,500
EB4HR0080TN-14-10-ATH	●	0.4	0.8	1	14	3.2	55	4	B	1	16,610
EB4HR0090TN-4-05-ATH	●	0.45	0.9	0.5	4	3.2	50	4	A	-	16,070
EB4HR0090TN-6-05-ATH	●	0.45	0.9	0.5	6	3.2	50	4	A	-	16,190
EB4HR0090TN-8-05-ATH	●	0.45	0.9	0.5	8	3.2	50	4	B	0.5	16,290
EB4HR0090TN-10-05-ATH	●	0.45	0.9	0.5	10	3.2	50	4	B	0.5	16,400
EB4HR0090TN-12-05-ATH	●	0.45	0.9	0.5	12	3.2	55	4	B	0.5	16,500
EB4HR0090TN-14-05-ATH	●	0.45	0.9	0.5	14	3.2	55	4	B	0.5	16,500
EB4HR0090TN-4-10-ATH	●	0.45	0.9	1	4	3.2	50	4	A	-	16,070
EB4HR0090TN-6-10-ATH	●	0.45	0.9	1	6	3.2	50	4	A	-	16,190
EB4HR0090TN-8-10-ATH	●	0.45	0.9	1	8	3.2	50	4	B	1	16,290
EB4HR0090TN-10-10-ATH	●	0.45	0.9	1	10	3.2	50	4	B	1	16,400
EB4HR0090TN-12-10-ATH	●	0.45	0.9	1	12	3.2	55	4	B	1	16,500
EB4HR0090TN-14-10-ATH	●	0.45	0.9	1	14	3.2	55	4	B	1	16,500

● : 標準在庫品です。 ● : Stocked items.

超硬ボールエンドミル

■首形状詳細 Detail of neck shape

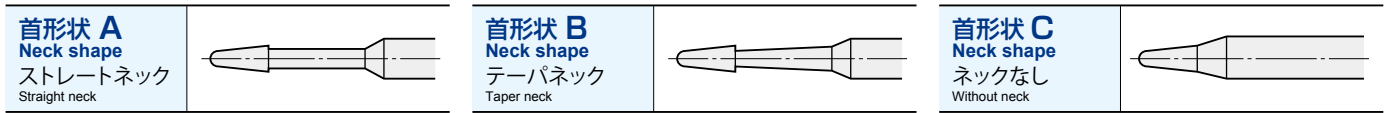

EB4HR-○○○○TN-○○-○○-ATH

商品コード Item code	在庫 Stock	寸法 Size(mm)							首形状 Neck shape	首テーパー半角 Neck angle (°)	希望小売 価格(円) Suggested retail price (¥)
		ボール半径 Ball radius	外径 Tool dia.	刃部テーパー半角 Taper angle on side	首下長 Under Neck length	刃長 Flute length	全長 Overall length	シャンク径 Shank dia.			
		RE	DC	BHTA1	LU	APMX	LF	DCONMS			
EB4HR0100TN-4-05-ATH	●	0.5	1	0.5	4	4	50	4	C	-	13,930
EB4HR0100TN-6-05-ATH	●	0.5	1	0.5	6	4	50	4	A	-	13,930
EB4HR0100TN-8-05-ATH	●	0.5	1	0.5	8	4	50	4	B	0.5	14,040
EB4HR0100TN-10-05-ATH	●	0.5	1	0.5	10	4	50	4	B	0.5	14,150
EB4HR0100TN-12-05-ATH	●	0.5	1	0.5	12	4	55	4	B	0.5	14,250
EB4HR0100TN-14-05-ATH	●	0.5	1	0.5	14	4	55	4	B	0.5	14,250
EB4HR0100TN-16-05-ATH	●	0.5	1	0.5	16	4	55	4	B	0.5	14,360
EB4HR0100TN-18-05-ATH	●	0.5	1	0.5	18	4	60	4	B	0.5	14,580
EB4HR0100TN-20-05-ATH	●	0.5	1	0.5	20	4	60	4	B	0.5	14,580
EB4HR0100TN-4-10-ATH	●	0.5	1	1	4	4	50	4	C	-	13,930
EB4HR0100TN-6-10-ATH	●	0.5	1	1	6	4	50	4	A	-	13,930
EB4HR0100TN-8-10-ATH	●	0.5	1	1	8	4	50	4	B	1	14,040
EB4HR0100TN-10-10-ATH	●	0.5	1	1	10	4	50	4	B	1	14,150
EB4HR0100TN-12-10-ATH	●	0.5	1	1	12	4	55	4	B	1	14,250
EB4HR0100TN-14-10-ATH	●	0.5	1	1	14	4	55	4	B	1	14,250
EB4HR0100TN-16-10-ATH	●	0.5	1	1	16	4	55	4	B	1	14,360
EB4HR0100TN-18-10-ATH	●	0.5	1	1	18	4	60	4	B	1	14,580
EB4HR0100TN-20-10-ATH	●	0.5	1	1	20	4	60	4	B	1	14,580
EB4HR0110TN-4-05-ATH	●	0.55	1.1	0.5	4	4	50	4	C	-	13,720
EB4HR0110TN-6-05-ATH	●	0.55	1.1	0.5	6	4	50	4	A	-	13,820
EB4HR0110TN-8-05-ATH	●	0.55	1.1	0.5	8	4	50	4	B	0.5	13,930
EB4HR0110TN-10-05-ATH	●	0.55	1.1	0.5	10	4	50	4	B	0.5	14,040
EB4HR0110TN-12-05-ATH	●	0.55	1.1	0.5	12	4	55	4	B	0.5	14,150
EB4HR0110TN-14-05-ATH	●	0.55	1.1	0.5	14	4	55	4	B	0.5	14,150
EB4HR0110TN-16-05-ATH	●	0.55	1.1	0.5	16	4	55	4	B	0.5	14,250
EB4HR0110TN-18-05-ATH	●	0.55	1.1	0.5	18	4	60	4	B	0.5	14,360
EB4HR0110TN-20-05-ATH	●	0.55	1.1	0.5	20	4	60	4	B	0.5	14,460
EB4HR0110TN-4-10-ATH	●	0.55	1.1	1	4	4	50	4	C	-	13,720
EB4HR0110TN-6-10-ATH	●	0.55	1.1	1	6	4	50	4	A	-	13,820
EB4HR0110TN-8-10-ATH	●	0.55	1.1	1	8	4	50	4	B	1	13,930
EB4HR0110TN-10-10-ATH	●	0.55	1.1	1	10	4	50	4	B	1	14,040
EB4HR0110TN-12-10-ATH	●	0.55	1.1	1	12	4	55	4	B	1	14,150
EB4HR0110TN-14-10-ATH	●	0.55	1.1	1	14	4	55	4	B	1	14,150
EB4HR0110TN-16-10-ATH	●	0.55	1.1	1	16	4	55	4	B	1	14,250
EB4HR0110TN-18-10-ATH	●	0.55	1.1	1	18	4	60	4	B	1	14,360
EB4HR0110TN-20-10-ATH	●	0.55	1.1	1	20	4	60	4	B	1	14,460
EB4HR0120TN-6-05-ATH	●	0.6	1.2	0.5	6	4.8	50	4	A	-	13,720
EB4HR0120TN-8-05-ATH	●	0.6	1.2	0.5	8	4.8	50	4	B	0.5	13,820
EB4HR0120TN-10-05-ATH	●	0.6	1.2	0.5	10	4.8	50	4	B	0.5	13,820
EB4HR0120TN-12-05-ATH	●	0.6	1.2	0.5	12	4.8	55	4	B	0.5	14,040
EB4HR0120TN-14-05-ATH	●	0.6	1.2	0.5	14	4.8	55	4	B	0.5	14,040
EB4HR0120TN-16-05-ATH	●	0.6	1.2	0.5	16	4.8	55	4	B	0.5	14,150
EB4HR0120TN-18-05-ATH	●	0.6	1.2	0.5	18	4.8	60	4	B	0.5	14,250
EB4HR0120TN-20-05-ATH	●	0.6	1.2	0.5	20	4.8	60	4	B	0.5	14,360
EB4HR0120TN-22-05-ATH	●	0.6	1.2	0.5	22	4.8	60	4	B	0.5	14,360
EB4HR0120TN-24-05-ATH	●	0.6	1.2	0.5	24	4.8	60	4	B	0.5	14,460
EB4HR0120TN-6-10-ATH	●	0.6	1.2	1	6	4.8	50	4	A	-	13,720
EB4HR0120TN-8-10-ATH	●	0.6	1.2	1	8	4.8	50	4	B	1	13,820
EB4HR0120TN-10-10-ATH	●	0.6	1.2	1	10	4.8	50	4	B	1	13,820
EB4HR0120TN-12-10-ATH	●	0.6	1.2	1	12	4.8	55	4	B	1	14,040
EB4HR0120TN-14-10-ATH	●	0.6	1.2	1	14	4.8	55	4	B	1	14,040
EB4HR0120TN-16-10-ATH	●	0.6	1.2	1	16	4.8	55	4	B	1	14,150
EB4HR0120TN-18-10-ATH	●	0.6	1.2	1	18	4.8	60	4	B	1	14,250
EB4HR0120TN-20-10-ATH	●	0.6	1.2	1	20	4.8	60	4	B	1	14,360
EB4HR0120TN-22-10-ATH	●	0.6	1.2	1	22	4.8	60	4	B	1	14,360
EB4HR0120TN-24-10-ATH	●	0.6	1.2	1	24	4.8	60	4	B	1	14,460

○ 対応被削材 Applicable work material

炭素鋼 合金鋼 Carbon steel Alloy steel	プリハー ド鋼 Pre-hardened steel	高硬度 Hardened steel			ステン レス鋼 Stainless steel	チタン合金 耐熱合金 Titanium alloy Heat-resistant alloy	銅合金 Copper alloy	アルミ 合金 Aluminum alloy
○	○	> 45HRC ≤ 55HRC	> 55HRC ≤ 65HRC	> 65HRC	○	○	○	

○ 再研磨対応外径範囲 Re-grinding compatibility range

商品コード Item code	外周 Outer dia. (mm)	エンド End (mm)
EB4HR-ATH	× (N/A)	× (N/A)

Carbide End Mills Ball End Mills

Taper Ball End Mill for High Accuracy Rib Slotting

エポックリブ溝加工用テーパボールエンドミル

標準切削条件表 [荒加工条件]

Recommended cutting condistions [Roughing conditions]

被削材 Work material				1		2		3		4	
				炭素鋼・合金鋼 Carbon steels, Alloy steels (180~250HB)		工具鋼 Tool steels (25~35HRC)		プリハードン鋼 Pre-hardened steels (35~45HRC)		焼入れ鋼 Hardened steels (45~55HRC)	
切り込み比率 Ratio to standard depth of cut				100%		90%		80%		65%	
ボール半径RE Ball radius (mm)	外径DC Tool dia. (mm)	首下長LU Under neck length (mm)	ap (mm)	回転数 n min ⁻¹	送り速度 vf mm/min	回転数 n min ⁻¹	送り速度 vf mm/min	回転数 n min ⁻¹	送り速度 vf mm/min	回転数 n min ⁻¹	送り速度 vf mm/min
0.3	0.6	4	0.024	36,000	1,030	32,400	920	30,600	760	27,000	610
	0.6	5	0.020	36,000	970	32,400	880	30,600	720	27,000	580
	0.6	6	0.015	36,000	970	32,400	880	30,600	720	27,000	580
	0.6	7	0.008	32,000	820	28,800	730	27,200	600	24,000	490
	0.6	8	0.008	32,000	820	28,800	730	27,200	600	24,000	490
	0.6	9	0.006	32,000	820	28,800	730	27,200	600	24,000	490
0.6	10	0.005	28,000	710	25,200	640	23,800	530	21,000	430	
0.35	0.7	4	0.034	36,000	1,130	32,400	1,020	30,600	840	27,000	690
	0.7	5	0.030	36,000	1,130	32,400	1,020	30,600	840	27,000	690
	0.7	6	0.027	36,000	1,070	32,400	960	30,600	800	27,000	650
	0.7	7	0.020	32,000	840	28,800	760	27,200	630	24,000	520
	0.7	8	0.010	32,000	840	28,800	760	27,200	630	24,000	520
	0.7	9	0.008	32,000	840	28,800	760	27,200	630	24,000	520
0.7	10	0.005	28,000	740	25,200	670	23,800	550	21,000	460	
0.4	0.8	4	0.035	40,000	1,440	36,000	1,300	34,000	1,090	30,000	900
	0.8	6	0.032	36,000	1,170	32,400	1,050	30,600	880	27,000	730
	0.8	8	0.020	32,000	1,040	28,800	930	27,200	780	24,000	650
	0.8	10	0.010	32,000	980	28,800	880	27,200	740	24,000	610
	0.8	12	0.008	32,000	980	28,800	880	27,200	740	24,000	610
0.8	14	0.005	28,000	860	25,200	770	23,816	650	21,000	530	
0.45	0.9	4	0.045	38,000	1,620	34,200	1,460	32,300	1,200	28,500	1,000
	0.9	6	0.042	34,200	1,310	30,800	1,180	29,100	980	25,700	810
	0.9	8	0.030	30,400	1,170	27,400	1,050	25,800	880	22,800	720
	0.9	10	0.020	30,400	1,170	27,400	1,050	25,800	880	22,800	720
	0.9	12	0.010	30,400	1,170	27,400	1,050	25,800	880	22,800	720
0.9	14	0.008	26,000	1,000	23,500	900	22,100	750	19,500	620	
0.5	1	4	0.040	32,400	1,460	29,200	1,310	27,500	1,120	24,300	920
	1	6	0.040	32,400	1,460	29,200	1,310	27,500	1,120	24,300	920
	1	8	0.040	32,400	1,460	29,200	1,310	27,500	1,120	24,300	920
	1	10	0.025	32,400	1,460	29,200	1,310	27,500	1,120	24,300	920
	1	12	0.013	28,800	1,220	25,900	1,100	24,500	940	21,600	770
	1	14	0.010	28,800	1,220	25,900	1,100	24,500	940	21,600	770
	1	16	0.008	28,800	1,220	25,900	1,100	24,500	940	21,600	770
	1	18	0.006	25,200	1,010	22,700	910	21,400	770	18,900	640
1	20	0.005	21,600	860	19,400	780	18,400	660	16,200	540	
0.55	1.1	4	0.040	30,600	1,480	27,500	1,330	26,000	1,090	23,000	920
	1.1	6	0.040	30,600	1,480	27,500	1,330	26,000	1,090	23,000	920
	1.1	8	0.040	30,600	1,480	27,500	1,330	26,000	1,090	23,000	920
	1.1	10	0.025	30,600	1,480	27,500	1,330	26,000	1,090	23,000	920
	1.1	12	0.020	27,200	1,240	24,500	1,110	23,100	920	20,400	770
	1.1	14	0.015	27,200	1,240	24,500	1,110	23,100	920	20,400	770
	1.1	16	0.010	27,200	1,240	24,500	1,110	23,100	920	20,400	770
	1.1	18	0.008	23,800	1,020	21,400	910	20,200	750	17,800	630
1.1	20	0.005	20,400	870	18,300	780	17,300	640	15,200	540	
0.6	1.2	6	0.060	28,800	1,500	25,900	1,350	24,500	1,100	21,600	950
	1.2	8	0.040	28,800	1,500	25,900	1,350	24,500	1,100	21,600	950
	1.2	10	0.035	28,800	1,420	25,900	1,210	24,500	1,100	21,600	860
	1.2	12	0.030	28,800	1,350	25,900	1,210	24,500	1,100	21,600	860
	1.2	14	0.025	24,600	1,150	22,200	1,040	21,000	940	18,500	730
	1.2	16	0.020	24,600	1,150	22,200	1,040	21,000	940	18,500	730
	1.2	18	0.015	24,600	1,150	22,200	1,040	21,000	940	18,500	730
	1.2	20	0.010	21,000	990	19,000	890	18,000	810	15,900	630
	1.2	22	0.010	21,000	990	19,000	890	18,000	810	15,900	630
1.2	24	0.008	21,000	990	19,000	890	18,000	810	15,900	630	

- 【注意】**
- ① apは被削材グループ1での目安を示しています。その他のグループの場合は、上表の切込み比率を目安に調整してください。
 - ② aeの設定はap×切込み比率×3~5倍を目安に調整してください。仕上げ加工を行う場合、理論カスプハイトを計算し設定してください。
- 【切り込み設定例】 EB4HRO100TN-10-05-ATHの仕上げ加工条件でプリハードン鋼を切削する場合
 切り込み = 0.032 (ap) × 0.8 (プリハードン鋼グループ3の切り込み比率) = 0.0256mm
- ③ 被削材、加工形状に合わせて、水溶性および油性のクーラントを使用してください。
 - ④ この標準切削条件表は切削条件の目安を示すものです。実際の加工では加工形状、目的、使用機械等により条件を調整してください。
 - ⑤ 機械の回転数が合わない場合は、回転数と送り速度を同じ比率で調整してください。

標準切削条件表 [仕上げ加工条件]

Recommended cutting condistions [Finishing conditions]

被削材 Work material				1		2		3		4	
				炭素鋼・合金鋼 Carbon steels, Alloy steels (180~250HB)		工具鋼 Tool steels (25~35HRC)		プリハードン鋼 Pre-hardened steels (35~45HRC)		焼入れ鋼 Hardened steels (45~55HRC)	
切り込み比率 Ratio to standard depth of cut				100%		90%		80%		65%	
ボール半径RE Ball radius (mm)	外径DC Tool dia. (mm)	首下長LU Under neck length (mm)	ap (mm)	回転数 n min ⁻¹	送り速度 Vf mm/min	回転数 n min ⁻¹	送り速度 Vf mm/min	回転数 n min ⁻¹	送り速度 Vf mm/min	回転数 n min ⁻¹	送り速度 Vf mm/min
0.3	0.6	4	0.023	18,000	1,030	16,200	920	15,300	760	13,500	620
	0.6	5	0.023	18,000	970	16,200	880	15,300	720	13,500	580
	0.6	6	0.020	18,000	970	16,200	880	15,300	720	13,500	580
	0.6	7	0.020	16,000	820	14,400	730	13,600	600	12,000	490
	0.6	8	0.020	16,000	820	14,400	730	13,600	600	12,000	490
	0.6	9	0.020	16,000	820	14,400	730	13,600	600	12,000	490
0.35	0.6	10	0.020	14,000	710	12,600	640	11,900	530	10,500	430
	0.7	4	0.023	18,000	1,130	16,200	1,020	15,300	840	13,500	690
	0.7	5	0.023	18,000	1,130	16,200	1,020	15,300	840	13,500	690
	0.7	6	0.020	18,000	1,070	16,200	960	15,300	790	13,500	650
	0.7	7	0.020	16,000	840	14,400	760	13,600	630	12,000	520
	0.7	8	0.020	16,000	840	14,400	760	13,600	630	12,000	520
0.4	0.7	9	0.020	16,000	840	14,400	760	13,600	630	12,000	520
	0.7	10	0.020	14,000	740	12,600	670	11,900	550	10,500	460
	0.8	4	0.028	20,000	1,440	18,000	1,300	17,000	1,090	15,000	900
	0.8	6	0.028	18,000	1,170	16,200	1,050	15,300	880	13,500	730
	0.8	8	0.025	16,000	1,040	14,400	930	13,600	780	12,000	650
	0.8	10	0.025	16,000	980	14,400	880	13,600	740	12,000	610
0.45	0.8	12	0.025	16,000	980	14,400	880	13,600	740	12,000	610
	0.8	14	0.025	14,000	860	12,600	770	11,900	650	10,500	530
	0.9	4	0.028	19,000	1,620	17,100	1,460	16,200	1,220	14,300	1,000
	0.9	6	0.028	17,100	1,310	15,400	1,180	14,600	980	12,900	810
	0.9	8	0.025	15,200	1,170	13,700	1,050	12,900	880	11,400	720
	0.9	10	0.025	15,200	1,170	13,700	1,050	12,900	880	11,400	720
0.5	0.9	12	0.025	15,200	1,170	13,700	1,050	12,900	880	11,400	720
	0.9	14	0.025	13,000	1,000	11,800	900	11,100	750	9,800	620
	1	4	0.035	16,200	1,460	14,600	1,310	13,800	1,120	12,200	920
	1	6	0.035	16,200	1,460	14,600	1,310	13,800	1,120	12,200	920
	1	8	0.035	16,200	1,460	14,600	1,310	13,800	1,120	12,200	920
	1	10	0.032	16,200	1,460	14,600	1,310	13,800	1,120	12,200	920
	1	12	0.032	14,400	1,220	13,000	1,100	12,300	940	10,800	770
	1	14	0.032	14,400	1,220	13,000	1,100	12,300	940	10,800	770
	1	16	0.032	14,400	1,220	13,000	1,100	12,300	940	10,800	770
0.55	1	18	0.030	12,600	1,010	11,400	900	10,700	770	9,500	640
	1	20	0.030	10,800	860	9,700	780	9,200	660	8,100	540
	1.1	4	0.035	15,300	1,480	13,800	1,330	13,000	1,090	11,500	920
	1.1	6	0.035	15,300	1,480	13,800	1,330	13,000	1,090	11,500	920
	1.1	8	0.035	15,300	1,480	13,800	1,330	13,000	1,090	11,500	920
	1.1	10	0.032	15,300	1,480	13,800	1,330	13,000	1,090	11,500	920
	1.1	12	0.032	13,600	1,240	12,300	1,110	11,600	920	10,200	770
	1.1	14	0.032	13,600	1,240	12,300	1,110	11,600	920	10,200	770
	1.1	16	0.032	13,600	1,240	12,300	1,110	11,600	920	10,200	770
0.6	1.1	18	0.030	11,900	1,020	10,700	910	10,100	750	8,900	630
	1.1	20	0.030	10,200	870	9,200	780	8,700	640	7,600	540
	1.2	6	0.043	14,400	1,500	13,000	1,350	12,300	1,100	10,800	950
	1.2	8	0.043	14,400	1,500	13,000	1,350	12,300	1,100	10,800	950
	1.2	10	0.043	14,400	1,400	13,000	1,210	12,300	1,100	10,800	860
	1.2	12	0.040	14,400	1,350	13,000	1,210	12,300	1,100	10,800	860
	1.2	14	0.040	12,300	1,150	11,100	1,040	10,500	940	9,300	730
	1.2	16	0.040	12,300	1,150	11,100	1,040	10,500	940	9,300	730
	1.2	18	0.040	12,300	1,150	11,100	1,040	10,500	940	9,300	730
0.6	1.2	20	0.037	10,500	990	9,500	890	9,000	810	8,000	630
	1.2	22	0.037	10,500	990	9,500	890	9,000	810	8,000	630
	1.2	24	0.037	10,500	990	9,500	890	9,000	810	8,000	630

[Note] ①ap is shown as the criteria for Group 1 workpieces. For other groups, adjust the cutting depth according to the cutting depth factors in the above table.
 ②Adjust by setting ae to (3 to 5)×(ap)×(cutting depth ratio). When performing finishing processing, calculate the theoretical cusp height and set accordingly.

Cutting depth setting example : When finishing in pre-hardened steel with EB4HR0100TN-10-05-ATH.
 Cutting depth = 0.032(ap)×0.8(Cutting depth factor for group 3 pre-hardened steel) = 0.0256mm

- ③Use the water or oil based coolant for the work material and machining shape.
- ④These Recommended Cutting Conditions indicate only the rule of a thumb for the cutting conditions. In actual machining, the condition should be adjusted according to the machining shape, purpose and the machine type.
- ⑤If the rpm available is lower than that recommended please reduce the feed rate to the same ratio.

Taper Ball End Mill for High Accuracy Rib Slotting エポックリブ溝加工用テーパボールエンドミル

1 ご使用方法 Method of use

1 工具の選定

リブ溝の勾配角と同じテーパ半角と、リブ溝の底幅に対し0.8～0.9倍程度の工具径を選定してください。
等高線加工でご使用いただくことで、外周刃がリブ溝の勾配面に作用します。また、切りくず排出性を向上させるため、水溶性の切削液を推奨します。

Tool Selection

Select a tool with the same taper angle as the draft angle of the rib groove and a tool diameter corresponding to approximately 0.8 to 0.9 times the bottom width of the rib groove.
When used for contouring, the peripheral cutting edge acts on the inclined face of the rib groove.
We recommend water-soluble cutting fluid to improve chip discharge.

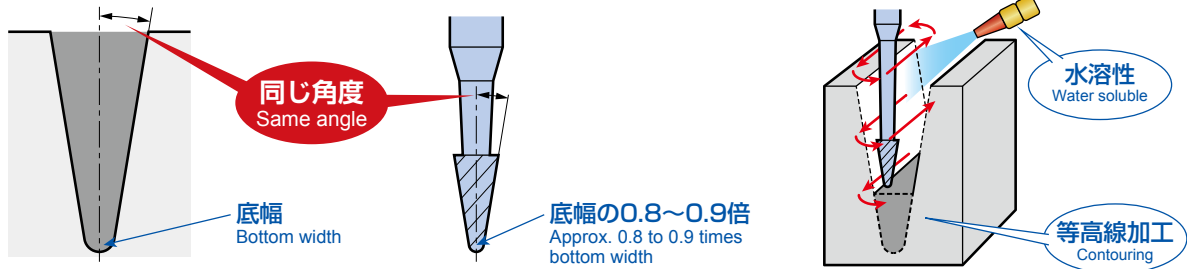

2 荒工程の例

指定加工深さまでの最短首下長のアイテムを選定し、最終加工深さまで工具交換を行いながら等高線加工を行ってください。
※L/D：工具の首下長Lと工具径DCの比率

Roughing example

Select a tool with a minimum under neck length not exceeding the specified cutting depth. Perform contouring down to the final cutting depth while swapping tools.
* L/D: The ratio between the tool under neck length L and tool diameter DC

リブ溝形状 Rib groove profile

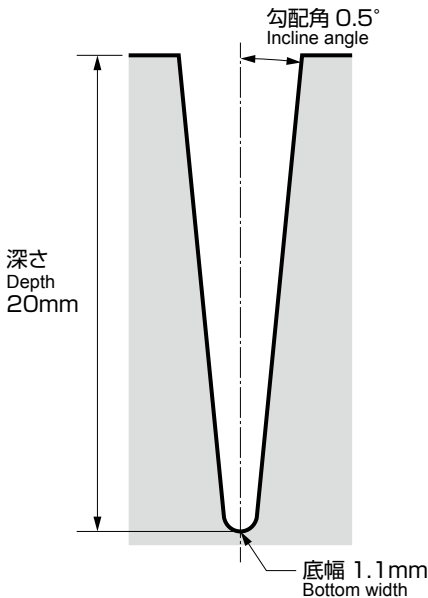

等高線荒加工の工程表例 Example contour roughing process chart

L/D	商品コード Item code	工具径 Tool dia.	首下長 Under neck length (mm)
6	EB4HR0100TN-6-05-ATH	1	6
12	EB4HR0100TN-12-05-ATH	1	12
16	EB4HR0100TN-16-05-ATH	1	16
20	EB4HR0100TN-20-05-ATH	1	20

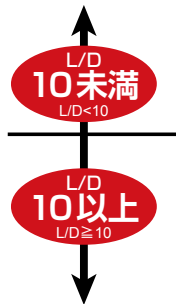

- ・L/D=10未満は、加工時間を考慮しながら加工深さに対して最短首下長のアイテムを選定してください。
- ・L/D=10以上は、剛性が低くたわみ易いため、出来る限り細かく分割して工程を組んでください。
- ・If L/D is less than 10, select a tool with the minimum under neck length for the cutting depth, taking cutting time into account.
- ・If L/D is 10 or greater, rigidity will be lower and there will be a greater tendency for deflection. Try to machine in the smallest possible steps.

3 仕上げ工程の例

仕上げ工程にEB4HRを使用することで、加工面や精度が更に向上いたします。

Finishing example

Using the EB4HR for finishing further improves the finished surface and accuracy.

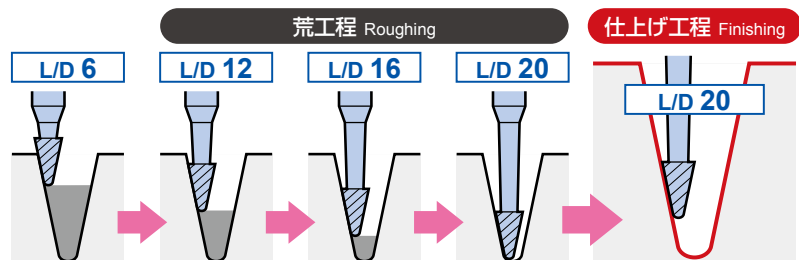

※荒工程のみでも、加工面や精度を満たしている場合がございます。
※荒工程でロングネックエンドミルを使用後に、仕上げ工程でEB4HRを使用しても、段差を除去できる場合がございます。

*Satisfactory machined surface and accuracy may be achieved with roughing alone.
*In some cases, using the EB4HR for finishing after using a long-necked end mill for roughing also removes level differences.

Epoch Combination Rib Ball エポックコンビネーションリブボール



外径公差 ±0.02



(mm)

先端2枚刃
外周4枚刃
Tip 2 flutes
Peripheral 4 flutes

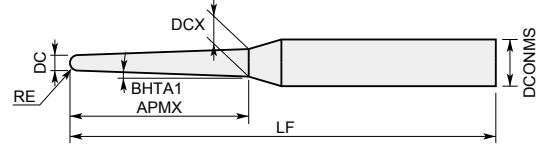
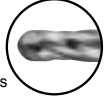

ECRB○○○○-○○-PN



商品コード Item code	在庫 Stock	寸法 Size (mm)						刃部テーパ半角 Taper angle on side BHTA1	希望小売価格 (円) Suggested retail price(¥)
		ボール半径 Ball radius RE	外径 Tool dia. DC	大端径 Large edge dia. DCX	刃長 Flute length APMX	シャンク径 Shank dia. DCONMS	全長 Overall length LF		
ECRB0809-6-PN	●	0.4	0.8	0.9	6	4	60	(0.51)	13,390
ECRB0809-8-PN	●	0.4	0.8	0.9	8	4	60	(0.38)	14,250
ECRB0809-10-PN	●	0.4	0.8	0.9	10	4	60	(0.30)	15,110
ECRB0809-12-PN	●	0.4	0.8	0.9	12	4	60	(0.25)	15,960
ECRB0810-6-PN	●	0.4	0.8	1.0	6	4	60	(1.02)	13,390
ECRB0810-8-PN	●	0.4	0.8	1.0	8	4	60	(0.75)	14,250
ECRB0810-10-PN	●	0.4	0.8	1.0	10	4	60	(0.60)	15,110
ECRB0810-12-PN	●	0.4	0.8	1.0	12	4	60	(0.49)	15,960
ECRB1012-6-PN	●	0.5	1	1.2	6	4	60	(1.04)	12,650
ECRB1012-8-PN	●	0.5	1	1.2	8	4	60	(0.76)	13,610
ECRB1012-10-PN	●	0.5	1	1.2	10	4	60	(0.60)	14,580
ECRB1012-12-PN	●	0.5	1	1.2	12	4	60	(0.50)	15,430
ECRB1012-14-PN	●	0.5	1	1.2	14	4	60	(0.42)	16,610
ECRB1012-16-PN	●	0.5	1	1.2	16	4	60	(0.37)	17,570

○ 対応被削材 Applicable work material

炭素鋼 合金鋼 Carbon steel Alloy steel	プリハードン鋼 Pre-hardened steel	高硬度 Hardened steel			ステンレス鋼 Stainless steel	チタン合金 耐熱合金 Titanium alloy Heat-resistant alloy	銅合金 Copper alloy	アルミ合金 Aluminum alloy
		> 45HRC ≤ 55HRC	> 55HRC ≤ 65HRC	> 65HRC				
◎	◎	○						

◎：標準在庫品です。●：Stocked items.

○ 再研磨対応外径範囲 Re-grinding compatibility range

商品コード Item code	外周 Outer dia. (mm)	エンド End (mm)
ECRB-PN	× (N/A)	× (N/A)

標準切削条件表 Recommended cutting conditions

ECRB-PN

- ・増速スピンドル等で回転数が固定される場合は、下記の回転数より近い回転数の条件をご使用ください。
- ・マシニングセンタ等で回転数が自由に選択可能な場合は、 $20,000\text{min}^{-1}$ を基準条件としてご使用ください。
- ・When using a multi-speed spindle, etc. with fixed rotation speeds, select the condition which is closer to the rotation speeds listed below.
- ・When using a machining center, etc. where the rotation speed can be freely set, use 20,000 rpm as the standard condition.

回転数 Revolution (min^{-1})		切り込み比率 Depth of cut ratio	炭素鋼 Carbon steels (180~250HB)	合金鋼 Alloy steels (25~35HRC)	プリハードン Pre-hardened steels (35~45HRC)	
			送り速度 Feed rate (mm/min)	送り速度 Feed rate (mm/min)	送り速度 Feed rate (mm/min)	
15,000		100%	1,200	960	770	
基準条件 20,000 Standard condition		100%	1,600	1,280	1,020	
25,000		80%	2,000	1,600	1,280	
30,000		60%	2,400	1,920	1,540	
ボール半径 RE Ball radius (mm)	外径 DC Tool dia. (mm)	大端径 Large edge dia. (mm)	刃長 Flute length (mm)	切り込み Depth of cut (mm)	切り込み Depth of cut (mm)	切り込み Depth of cut (mm)
0.4	0.8	0.9	6	0.024	0.02	0.016
0.4	0.8	0.9	8	0.018	0.015	0.012
0.4	0.8	0.9	10	0.014	0.012	0.01
0.4	0.8	0.9	12	0.012	0.01	0.008
0.4	0.8	1	6	0.024	0.02	0.016
0.4	0.8	1	8	0.018	0.015	0.012
0.4	0.8	1	10	0.014	0.012	0.01
0.4	0.8	1	12	0.012	0.01	0.008
0.5	1	1.2	6	0.03	0.025	0.02
0.5	1	1.2	8	0.023	0.019	0.015
0.5	1	1.2	10	0.018	0.015	0.012
0.5	1	1.2	12	0.015	0.013	0.01
0.5	1	1.2	14	0.013	0.011	0.009
0.5	1	1.2	16	0.011	0.009	0.007

【注意】

- ①切り込みは、切り込み比率を参考に調整してください。
- ②被削材、加工形状に合わせて、適切なクーラントを使用してください。
- ③この標準切削条件表は切削条件の目安を示すものです。実際の加工では加工形状、目的、使用機械等により条件を調整してください。
- ④機械の回転数が合わない場合は、回転数と送り速度を同じ比率で調整してください。
- ⑤ 5° を超える傾斜面を加工する場合は、切り込みを下げる等の調整を行ってください。

【Note】

- ①Adjust the cutting depth referring to the depth of cut ratio.
- ②Use the appropriate coolant for the work material and machining shape.
- ③These Recommended Cutting Conditions indicate only the rule of a thumb for the cutting conditions. In actual machining, the condition should be adjusted according to the machining shape, purpose and the machine type.
- ④If the rotation speed of the machine does not match the values in the table, adjust the rotation speed and feed rate using the same ratio.
- ⑤When machining a tapered surface of greater than 5° , make adjustments such as reducing the cutting depth, etc.

○ ご使用方法 Method of use

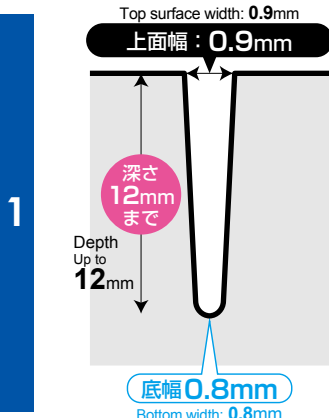

リブ溝の上面幅とエンドミルの大端径・リブ溝の底幅とエンドミルの外径が同じものを刃長別に短いものから順にご使用ください。

左記の **上面幅 0.9mm・底幅 0.8mm** のリブ溝は下記4アイテムをご使用ください。

Use end mills having the same large edge diameter as the rib groove's top surface width and the same tool diameter as the rib groove's bottom in sequence starting with the shortest flute length. For making the rib groove shown at right with a **top surface width of 0.9 mm and bottom width of 0.8 mm**, the following four items should be used.

商品コード Item code	在庫 Stock	寸法 Size (mm)							刃部テーパ半角 Taper angle on side
		ボール半径 Ball radius	外径 Tool dia.	大端径 Large edge dia.	刃長 Flute length	シャンク径 Shank dia.	全長 Overall length		
		RE	DC	DCX	APMX	DCONMS	LF	BHTA1	
ECRB0809-6-PN	●	0.4	0.8	0.9	6	4	60	(0.51)	
ECRB0809-8-PN	●	0.4	0.8	0.9	8	4	60	(0.38)	
ECRB0809-10-PN	●	0.4	0.8	0.9	10	4	60	(0.30)	
ECRB0809-12-PN	●	0.4	0.8	0.9	12	4	60	(0.25)	

上面幅を加工する工程と底幅を加工する工程を組み合わせるコンビネーションリブ加工!!

Combination rib machining can combine the process for machining the top surface width and the process for machining the bottom width.

【例】加工形状

[Ex.] Shape to be machined

上面幅 Top surface width : 0.9mm

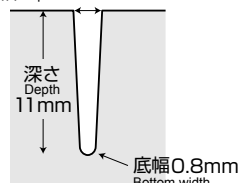

上面幅 0.9mm・底幅 0.8mm・深さ 11mm のリブ溝の場合。

For a rib groove with an top surface width of 0.9 mm, a bottom width of 0.8 mm, and a depth of 11 mm

工程 Process 1

上面幅 Top surface width : 0.9mm

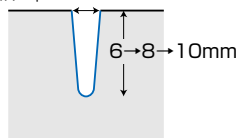

上記アイテムの刃長の短い順に 6mm → 8mm → 10mm を用いて往復切削にて加工を行う。加工深さ=刃長としてください。大端径は全て 0.9 mm のため、リブ溝の上面幅の 0.9 mm が加工できます。

Perform machining by reciprocating cutting using the above items in order starting with the shortest flute length: 6 mm => 8 mm => 10 mm. Set machining depth = Flute length. Since all of the items have a large edge diameter of 0.9 mm, the 0.9 mm width of the top surface of the rib groove can be machined.

工程 Process 2

上面幅 Top surface width : 0.9mm

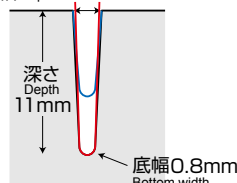

上記アイテムの刃長 12 mm を用いて、深さ 11 mm まで往復切削を行う。ボール半径が 0.4 mm のため、底幅 0.8 mm が加工できます。

Using the item above with a flute length of 12 mm, perform reciprocating cutting to the depth of 11 mm. Since the ball radius is 0.4 mm, the bottom width of 0.8 mm can be machined.

完成! Completed

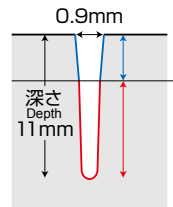

上面幅・底幅・深さが高精度に加工できているため、ヒケやショートショットも生じにくいリブ溝が完成。抜け方向の勾配もしっかりついています。

Since it is possible to machine the top surface width, bottom width, and depth with high accuracy, rib grooves with sinks or short shots are unlikely to occur can be completed. The taper in the release direction is also firmly maintained.

※完成したリブ溝の勾配面には、わずかな角度差が生じます。事前に問題ないかご確認をお願いします。 ※Slight differences in the angle of the taper surface of completed rib grooves may occur. Whether or not they will be a problem should be checked beforehand.

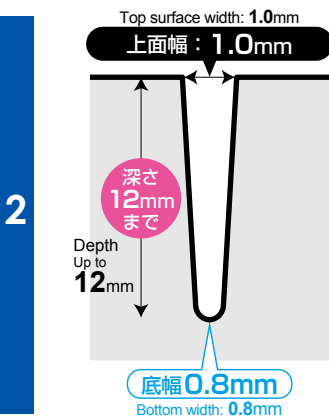

左記の **上面幅 1.0mm・底幅 0.8mm** のリブ溝は下記4アイテムをご使用ください。

For making the rib groove shown at right with a **top surface width of 1.0 mm and bottom width of 0.8 mm**, the following four items should be used.

商品コード Item code	在庫 Stock	寸法 Size (mm)							刃部テーパ半角 Taper angle on side
		ボール半径 Ball radius	外径 Tool dia.	大端径 Large edge dia.	刃長 Flute length	シャンク径 Shank dia.	全長 Overall length		
		RE	DC	DCX	APMX	DCONMS	LF	BHTA1	
ECRB0810-6-PN	●	0.4	0.8	1.0	6	4	60	(1.02)	
ECRB0810-8-PN	●	0.4	0.8	1.0	8	4	60	(0.75)	
ECRB0810-10-PN	●	0.4	0.8	1.0	10	4	60	(0.60)	
ECRB0810-12-PN	●	0.4	0.8	1.0	12	4	60	(0.49)	

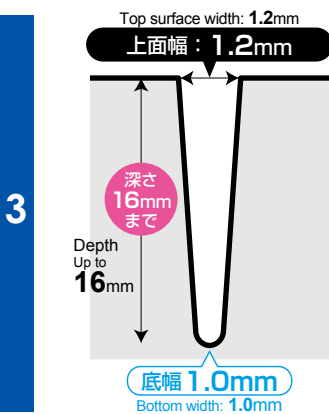

左記の **上面幅 1.2mm・底幅 1.0mm** のリブ溝は下記6アイテムをご使用ください。

For making the rib groove shown at right with a **top surface width of 1.2 mm and bottom width of 1.0 mm**, the following 6 items should be used.

商品コード Item code	在庫 Stock	寸法 Size (mm)							刃部テーパ半角 Taper angle on side
		ボール半径 Ball radius	外径 Tool dia.	大端径 Large edge dia.	刃長 Flute length	シャンク径 Shank dia.	全長 Overall length		
		RE	DC	DCX	APMX	DCONMS	LF	BHTA1	
ECRB1012-6-PN	●	0.5	1	1.2	6	4	60	(1.04)	
ECRB1012-8-PN	●	0.5	1	1.2	8	4	60	(0.76)	
ECRB1012-10-PN	●	0.5	1	1.2	10	4	60	(0.60)	
ECRB1012-12-PN	●	0.5	1	1.2	12	4	60	(0.50)	
ECRB1012-14-PN	●	0.5	1	1.2	14	4	60	(0.42)	
ECRB1012-16-PN	●	0.5	1	1.2	16	4	60	(0.37)	

Epoch SD(S-DLC) Deep Ball

エポック SD(S-DLC) ディープボール



高い耐溶着性、アルミ合金・銅の加工に適しています。DLCコーティング。
High welding resistance makes it ideal for machining aluminum alloys and copper.
DLC Coating.

RE公差 RE ≤ 0.25 : ±0.003
0.25 < RE : ±0.005



2枚刃
2Flutes

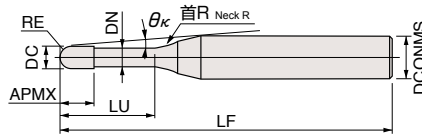

EPDB2000-SD

商品コード Item code	在庫 Stock	寸法 Size (mm)										干渉角度 Interference angle (°)					希望小売 価格 (円) Suggested retail price (¥)			
		ボール半径 Ball radius RE	外径 Tool dia. DC	首下長 Under neck length LU	刃長 Flute length APMX	首径 Neck dia. DN	全長 Overall length LF	シャンク径 Shank dia. DCONMS	首R Neck R	勾配角に対する実有効首下長 Effective under neck length with respect to draft angle										
										0.5°	1°	1.5°	2°	3°						
												θκ								
EPDB2002-0.4-SD	●	0.1	0.2	0.4	0.15	0.17	50	4	1	11.54	0.59	0.61	0.63	0.66	0.7	19,820				
EPDB2002-0.6-SD	●			0.6	0.15	0.17	50	4	1	11.3	0.8	0.83	0.86	0.88	0.93	19,820				
EPDB2002-1-SD	●			1	0.15	0.17	50	4	1	10.86	1.22	1.26	1.3	1.33	1.39	19,820				
EPDB2003-0.5-SD	●	0.15	0.3	0.5	0.25	0.27	50	4	2	11.47	0.78	0.82	0.86	0.9	0.98	19,820				
EPDB2003-1-SD	●			1	0.25	0.27	50	4	2	10.89	1.31	1.38	1.43	1.49	1.59	19,820				
EPDB2003-1.5-SD	●			1.5	0.25	0.27	50	4	2	10.36	1.84	1.92	1.99	2.06	2.18	21,420				
EPDB2004-1-SD	●	0.2	0.4	1	0.3	0.37	50	4	2	10.91	1.31	1.37	1.43	1.48	1.58	13,510				
EPDB2004-1.5-SD	●			1.5	0.3	0.37	50	4	2	10.37	1.84	1.92	1.99	2.06	2.17	13,720				
EPDB2004-2-SD	●			2	0.3	0.37	50	4	2	9.88	2.36	2.46	2.54	2.62	2.75	14,250				
EPDB2005-2-SD	●	0.25	0.5	2	0.35	0.47	50	4	10	9.88	2.86	3.14	3.39	3.62	4.06	13,510				
EPDB2005-4-SD	●			4	0.35	0.47	50	4	10	8.27	5.06	5.45	5.78	6.08	6.61	13,510				
EPDB2005-6-SD	●			6	0.35	0.47	50	4	10	7.1	7.23	7.69	8.08	8.43	9.05	14,250				
EPDB2006-2-SD	●	0.3	0.6	2	0.4	0.57	50	4	10	9.88	2.86	3.13	3.38	3.61	4.04	10,320				
EPDB2006-4-SD	●			4	0.4	0.57	50	4	10	8.22	5.06	5.44	5.77	6.07	6.6	11,150				
EPDB2006-6-SD	●			6	0.4	0.57	50	4	10	7.04	7.22	7.69	8.08	8.42	9.04	11,150				
EPDB2008-4-SD	●	0.4	0.8	4	0.5	0.77	50	4	10	8.14	5.05	5.43	5.75	6.05	6.58	11,150				
EPDB2008-6-SD	●			6	0.5	0.77	50	4	10	6.92	7.21	7.68	8.06	8.41	9.02	11,150				
EPDB2008-8-SD	●			8	0.5	0.77	50	4	10	6.01	9.36	9.89	10.33	10.71	11.38	11,150				
EPDB2010-4-SD	●	0.5	1	4	0.8	0.96	50	4	10	8.02	5.09	5.45	5.77	6.06	6.58	9,830				
EPDB2010-8-SD	●			8	0.8	0.96	50	4	10	5.85	9.39	9.91	10.34	10.72	11.38	10,640				
EPDB2010-12-SD	●			12	0.8	0.96	55	4	10	4.6	13.63	14.26	14.78	15.22	15.99	10,640				
EPDB2015-6-SD	●	0.75	1.5	6	1.35	1.44	50	4	10	6.33	7.31	7.73	8.09	8.42	9.01	10,120				
EPDB2015-12-SD	●			12	1.35	1.44	55	4	10	4.14	13.68	14.29	14.79	15.23	15.98	12,650				
EPDB2015-18-SD	●			18	1.35	1.44	60	4	10	3.08	19.97	20.72	21.32	21.84	23.83	12,650				
EPDB2020-8-SD	●	1	2	8	1.7	1.92	50	4	10	4.81	9.5	9.97	10.37	10.73	11.37	10,640				
EPDB2020-16-SD	●			16	1.7	1.92	55	4	10	2.88	17.92	18.61	19.17	19.65	干渉なし	10,640				
EPDB2020-24-SD	●			24	1.7	1.92	60	4	10	2.06	26.26	27.11	27.77	28.75	干渉なし	14,250				
EPDB2030-12-SD	●	1.5	3	12	2.5	2.88	55	6	10	4.81	13.82	14.36	14.83	15.24	15.96	13,820				
EPDB2030-24-SD	●			24	2.5	2.88	65	6	10	2.88	26.33	27.14	27.79	28.76	干渉なし	13,820				
EPDB2030-36-SD	●			36	2.5	2.88	80	6	10	2.06	38.74	39.74	41.17	43.12	干渉なし	17,570				
EPDB2040-16-SD	●	2	4	16	3	3.9	60	6	10	3.03	17.93	18.58	19.11	19.58	20.91	12,220				
EPDB2040-32-SD	●			32	3	3.9	75	6	10	1.64	34.56	35.5	36.48	干渉なし	干渉なし	15,860				
EPDB2040-48-SD	●			48	3	3.9	90	6	10	1.13	51.05	52.37	干渉なし	干渉なし	干渉なし	20,680				
EPDB2050-20-SD	●	2.5	5	20	3.5	4.9	65	6	10	1.38	22.09	22.81	干渉なし	干渉なし	干渉なし	20,760				
EPDB2050-40-SD	●			40	3.5	4.9	80	6	10	0.71	42.8	干渉なし	干渉なし	干渉なし	干渉なし	22,330				

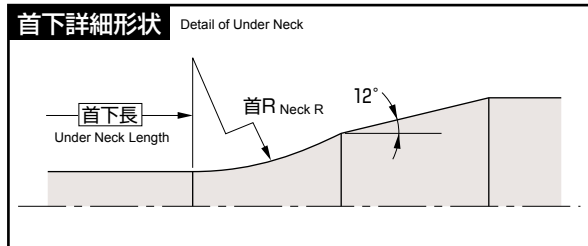

【注意】 加工物に勾配がついている場合、干渉領域は、首下長よりも長くなります。それぞれの勾配角に対する実有効首下長をご参照ください。また、工具が加工物に干渉する角度を干渉角度 θ_{κ} で表示していますので合わせてご参照ください。

【Note】 If the workpiece has draft angle, the interference length will be longer than the under-neck length. Please refer to the effective under-neck length for the various draft angles. In addition, the angle at which the tool will interfere with the workpiece is shown as the "interference angle θ_{κ} ", and should also be referred to.

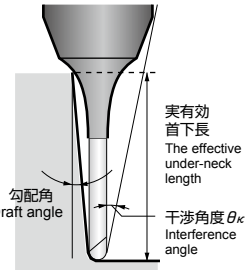

○ 対応被削材 Applicable work material

炭素鋼 合金鋼 Carbon steel Alloy steel	プリハー ド鋼 Pre-hardened steel	高硬度 Hardened steel			ステン レス鋼 Stainless steel	チタン合金 耐熱合金 Titanium alloy Heat-resistant alloy	銅合金 Copper alloy	アルミ 合金 Aluminum alloy
	≤ 45HRC	> 45HRC ≤ 55HRC	> 55HRC ≤ 65HRC	> 65HRC			◎	◎

○ 再研磨対応外径範囲 Re-grinding compatibility range

商品コード	Item code	外周	Outer dia. (mm)	エンド	End (mm)
EPDB-SD		×	(N/A)	1 ~ 5	

【注意】 首下長 / 外径が10DCを超える工具の再研磨可否については、弊社営業にお問い合わせください。
【Note】 Contact our sales office regarding whether or not regrinding is possible for tools where under neck length/tool diameter more than 10DC

● : 標準在庫品です。● : Stocked items. 干渉なし : No interference

EPDB-SD

<溝切削> Slotting

商品コード Item code	ボール半径RE Ball radius (mm)	外径DC Tool dia. (mm)	首下長LU Under neck length (mm)	軸方向切り込み量 Axial direction cutting depth (mm)	1		2		3		4	
					回転数 n min ⁻¹	送り速度 v_f mm/min	回転数 n min ⁻¹	送り速度 v_f mm/min	回転数 n min ⁻¹	送り速度 v_f mm/min	回転数 n min ⁻¹	送り速度 v_f mm/min
					アルミニウム合金展伸材 A5052,A7075等, etc. Expanded aluminum alloy material		アルミニウム合金鋳物 AC4A,ADC12等, etc. Cast aluminum alloy material		銅合金 C1100等, etc. Pure copper		樹脂 アクリル等 Resin, Acrylic, etc.	
EPDB2002-0.4-SD	0.1	0.2	0.4	0.03	50,000	500	50,000	500	50,000	500	50,000	750
EPDB2002-0.6-SD	0.1	0.2	0.6	0.025	50,000	450	50,000	450	50,000	450	50,000	680
EPDB2002-1-SD	0.1	0.2	1	0.017	50,000	450	50,000	450	50,000	450	50,000	680
EPDB2003-0.5-SD	0.15	0.3	0.5	0.033	50,000	800	50,000	800	50,000	800	50,000	1,200
EPDB2003-1-SD	0.15	0.3	1	0.026	50,000	700	50,000	700	50,000	700	50,000	1,050
EPDB2003-1.5-SD	0.15	0.3	1.5	0.02	50,000	600	50,000	600	50,000	600	50,000	900
EPDB2004-1-SD	0.2	0.4	1	0.05	50,000	980	50,000	980	50,000	980	47,800	1,470
EPDB2004-1.5-SD	0.2	0.4	1.5	0.04	50,000	840	50,000	840	50,000	840	43,000	1,260
EPDB2004-2-SD	0.2	0.4	2	0.034	50,000	700	50,000	700	47,700	700	38,200	1,050
EPDB2005-2-SD	0.25	0.5	2	0.1	50,000	1,000	50,000	1,000	48,000	960	38,400	1,280
EPDB2005-4-SD	0.25	0.5	4	0.06	50,000	900	50,000	900	43,200	780	34,560	1,050
EPDB2005-6-SD	0.25	0.5	6	0.03	50,000	850	50,000	850	38,400	650	30,720	810
EPDB2006-2-SD	0.3	0.6	2	0.12	50,000	1,500	50,000	1,500	48,000	1,440	38,400	1,820
EPDB2006-4-SD	0.3	0.6	4	0.07	50,000	1,420	50,000	1,420	43,200	1,230	34,560	1,490
EPDB2006-6-SD	0.3	0.6	6	0.04	50,000	1,350	50,000	1,350	43,200	1,170	34,560	1,490
EPDB2008-4-SD	0.4	0.8	4	0.16	50,000	1,800	50,000	1,800	48,000	1,730	38,400	1,820
EPDB2008-6-SD	0.4	0.8	6	0.1	50,000	1,620	50,000	1,620	43,200	1,400	34,560	1,490
EPDB2008-8-SD	0.4	0.8	8	0.05	50,000	1,610	50,000	1,610	38,400	1,240	34,560	1,490
EPDB2010-4-SD	0.5	1	4	0.2	50,000	2,500	50,000	2,500	43,200	2,160	34,560	2,440
EPDB2010-8-SD	0.5	1	8	0.12	50,000	2,250	50,000	2,250	38,880	1,750	31,100	2,010
EPDB2010-12-SD	0.5	1	12	0.06	50,000	2,130	46,660	1,980	34,560	1,470	27,650	1,570
EPDB2015-6-SD	0.75	1.5	6	0.3	50,000	3,300	45,360	3,000	33,600	2,220	26,880	1,910
EPDB2015-12-SD	0.75	1.5	12	0.18	45,360	2,700	40,820	2,430	30,240	1,800	24,190	1,570
EPDB2015-18-SD	0.75	1.5	18	0.09	40,320	2,270	36,290	2,040	26,880	1,510	21,500	1,220
EPDB2020-8-SD	1	2	8	0.4	37,800	3,410	34,020	3,060	25,200	2,270	20,160	1,910
EPDB2020-16-SD	1	2	16	0.24	34,020	2,450	30,620	2,200	22,680	1,630	18,100	1,570
EPDB2020-24-SD	1	2	24	0.12	30,240	2,060	27,220	1,850	20,160	1,370	16,130	1,220
EPDB2030-12-SD	1.5	3	12	0.6	28,800	4,320	25,920	3,890	19,200	2,880	15,360	1,820
EPDB2030-24-SD	1.5	3	24	0.36	25,920	3,500	23,330	3,150	17,280	2,330	13,820	1,490
EPDB2030-36-SD	1.5	3	36	0.18	23,040	2,940	20,740	2,650	15,360	1,960	12,300	1,320
EPDB2040-16-SD	2	4	16	0.8	20,700	4,140	18,630	3,730	13,800	2,760	11,500	2,300
EPDB2040-32-SD	2	4	32	0.48	18,630	3,360	16,770	3,020	12,420	2,240	10,350	1,860
EPDB2040-48-SD	2	4	48	0.24	16,560	2,820	14,900	2,540	11,040	1,880	9,100	1,640
EPDB2050-20-SD	2.5	5	20	1	16,200	3,890	14,580	3,500	10,800	2,590	8,640	1,560
EPDB2050-40-SD	2.5	5	40	0.6	14,580	3,150	13,120	2,840	9,720	2,100	7,780	1,400

【備考】 ①樹脂の材質によってはエアブローを推奨致します。
 ②この標準切削条件表は切削条件の目安を示したものです。実際の加工形状・使用機械・加工目的により条件を調整してください。
 ③機械の回転数が足りない場合は、回転数と送り速度を同じ比率で下げてください。

【Note】 ① An air blower is recommended for some resin materials.
 ② The cutting conditions shown in the table above are reference cutting conditions, and should be adjusted according to the actual shape to be machined, the machine used, and purpose for machining.
 ③ If the machine rotation speed is insufficient, reduce the rotation speed and feed rate by the same ratio.

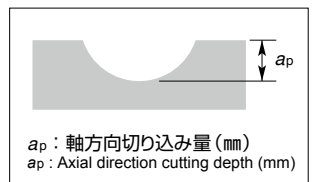

<仕上げ切削> Finishing

被削材 Work material	1		2	
	回転数 n min ⁻¹	送り速度 v_f mm/min	回転数 n min ⁻¹	送り速度 v_f mm/min
ボール半径RE×外径DC Ball radius×Tool dia. (mm)				
アルミニウム合金展伸材 A5052,A7075等, etc. Expanded aluminum alloy material			樹脂 アクリル等 Resin, Acrylic, etc.	
RE0.1×0.2	50,000	1,000	50,000	1,000
RE0.15×0.3	50,000	1,200	50,000	1,200
RE0.2×0.4	50,000	1,500	50,000	1,500
RE0.25×0.5	50,000	2,000	50,000	2,000
RE0.3×0.6	48,000	1,920	48,000	1,920
RE0.4×0.8	44,000	2,200	44,000	2,200
RE0.5×1	40,000	2,400	40,000	2,400
RE0.75×1.5	34,000	2,400	34,000	2,400
RE1×2	30,000	2,400	30,000	2,400
RE1.5×3	26,000	2,080	26,000	2,080
RE2×4	24,000	1,920	24,000	1,920
RE2.5×5	22,000	1,760	22,000	1,760

切り込み量 Depth of Cut (mm)

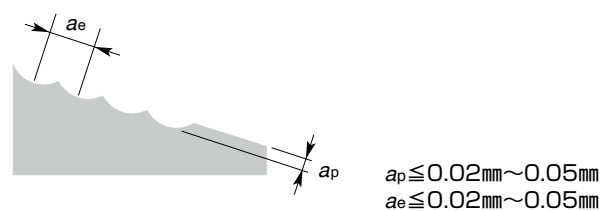

【備考】 ①樹脂の材質によってはエアブローを推奨致します。
 ②この標準切削条件表は切削条件の目安を示したものです。実際の加工形状・使用機械・加工目的により条件を調整してください。

【Note】 ① An air blower is recommended for some resin materials.
 ② The cutting conditions shown in the table above are reference cutting conditions, and should be adjusted according to the actual shape to be machined, the machine used, and purpose for machining.

エポック SD(S-DLC) ボール

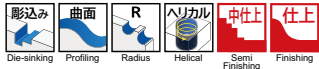

高い耐溶着性、アルミ合金・銅の加工に適しています。DLCコーティング。
High welding resistance makes it ideal for machining aluminum alloys and copper.
DLC Coating.

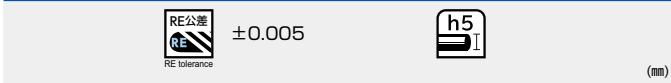

2枚刃
2flutes

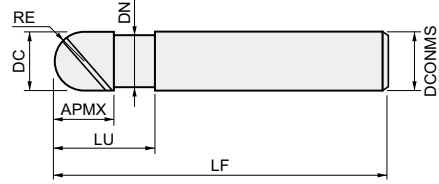

EPAB2000-SD



商品コード Item code	在庫 Stock	寸法 Size (mm)							希望小売価格 (円) Suggested retail price(¥)
		ボール半径 Ball radius RE	外径 Tool dia. DC	首下長 l_2 Under neck length LU	刃長 Flute length APMX	首径 Neck dia. DN	全長 Overall length LF	シャンク径 Shank dia. DCONMS	
EPAB2060-SD	●	3	6	15	6	5.9	90	6	19,760
EPAB2080-SD	●	4	8	20	8	7.9	100	8	25,810
EPAB2100-SD	●	5	10	25	10	9.9	100	10	32,990
EPAB2120-SD	●	6	12	30	12	11.9	110	12	42,870

標準切削条件表 Recommended cutting conditions

EPAB-SD

被削材 Work material	1		2		3		4		
	回転数 n min ⁻¹	送り速度 v_f mm/min	回転数 n min ⁻¹	送り速度 v_f mm/min	回転数 n min ⁻¹	送り速度 v_f mm/min	回転数 n min ⁻¹	送り速度 v_f mm/min	
アルミニウム合金展伸材 A5052, A7075等, etc. Expanded aluminum alloy material									
アルミニウム合金鋳物 ダイキャスト Si 10%未満 Cast aluminum alloy material Die-casting, Si less than 10%									
銅合金 C1100等, etc. Pure copper									
樹脂 アクリル等 Resin, Acrylic, etc.									
ボール半径RE×外径DC Ball radius×Tool dia. (mm)	RE3×6	27,000	3,300	21,600	2,310	13,300	1,600	10,600	1,280
	RE4×8	20,000	3,200	16,000	2,240	10,000	1,400	8,000	1,120
	RE5×10	16,000	3,000	12,800	2,100	8,000	1,280	6,400	1,030
	RE6×12	13,300	2,660	10,640	1,860	6,600	1,190	5,300	950

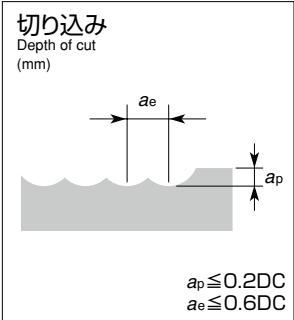

- 【注意】**
- 樹脂の材質によってはエアブローを推奨致します。
 - この標準切削条件表は切削条件の目安を示したものです。実際の加工形状・使用機械・加工目的により条件を調整して下さい。
 - 機械の回転数が足りない場合は、回転数と送り速度を同じ比率で下げてください。

- 【Note】**
- An air blower is recommended for some resin materials.
 - The cutting conditions shown in the table above are reference cutting conditions, and should be adjusted according to the actual shape to be machined, the machine used, and purpose for machining.
 - If the machine rotation speed is insufficient, reduce the rotation speed and feed rate by the same ratio.

<仕上げ切削> Finishing

被削材 Work material	1		2	
	回転数 n min ⁻¹	送り速度 v_f mm/min	回転数 n min ⁻¹	送り速度 v_f mm/min
アルミニウム合金展伸材 A5052, A7075等, etc. Expanded aluminum alloy material				
樹脂 アクリル等 Resin, Acrylic, etc.				
ボール半径RE×外径DC Ball radius×Tool dia. (mm)	RE3×6	20,000	1,600	20,000
	RE4×8	15,000	1,200	15,000
	RE5×10	12,000	1,200	12,000
	RE6×12	10,000	1,000	10,000

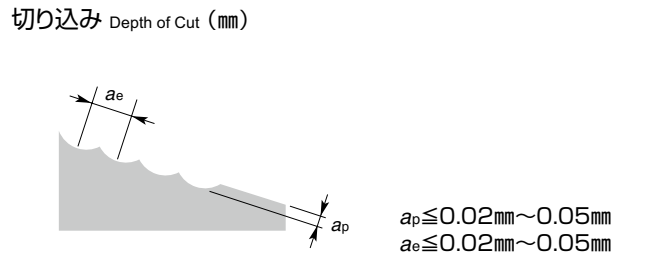

- 【注意】**
- 樹脂の材質によってはエアブローを推奨致します。
 - この標準切削条件表は切削条件の目安を示したものです。実際の加工形状・使用機械・加工目的により条件を調整して下さい。

- 【Note】**
- An air blower is recommended for some resin materials.
 - The cutting conditions shown in the table above are reference cutting conditions, and should be adjusted according to the actual shape to be machined, the machine used, and purpose for machining.

対応被削材 Applicable work material

炭素鋼 合金鋼 Carbon steel Alloy steel	プリハードン鋼 Pre-hardened steel ≤ 45HRC	高硬度 Hardened steel			ステンレス鋼 Stainless steel	チタン合金 耐熱合金 Titanium alloy Heat-resistant alloy	銅合金 Copper alloy	アルミ合金 Aluminum alloy
		> 45HRC ≤ 55HRC	> 55HRC ≤ 65HRC	> 65HRC				
							◎	◎

● : 標準在庫品です。 ● : Stocked items.

再研磨対応外径範囲 Re-grinding compatibility range

商品コード Item code	外周 Outer dia. (mm)	エンド End (mm)
EPAB-SD	× (N/A)	6 ~ 12

Epoch HD Coating Deep Ball End Mill エポックHDコーティングディープボールエンドミル

ダイヤモンドコーティング Diamond Coating



グラファイト・高Siアルミ合金・FRP加工に適しています。
ダイヤモンドコーティング。

Ideal for machining of graphite, high-Si aluminum alloys, and FRP. Diamond Coating.



2枚刃
2Flutes

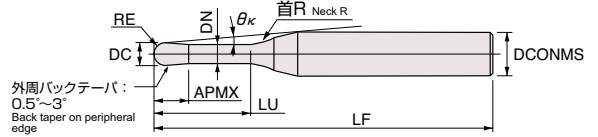

EGDB2000-000-HD

商品コード Item code	在庫 Stock	寸法 Size (mm)								干渉角度 Interference angle (°)	勾配角に対する実有効首下長 The effective under-neck length for the various draft angles					希望小売 価格(円) Suggested retail price (¥)
		ボール半径 Ball radius	外径 Tool dia.	首下長 Under neck length	首径 Neck dia.	刃長 Flute length	全長 Overall length	シャンク径 Shank dia.	首R Neck R							
		RE	DC	LU	DN	APMX	LF	DCONMS	θκ		0.5°	1°	1.5°	2°	3°	
EGDB2004-4-HD	●	0.2	0.4	4	0.37	0.6	60	4	10	8.3	5.07	5.45	5.78	6.08	6.63	40,280
EGDB2004-8-HD	●			8	0.37	0.6	60	4	10	6.29	9.37	9.91	10.35	10.74	11.42	42,420
EGDB2004-12-HD	●			12	0.37	0.6	60	4	10	5.06	13.62	14.26	14.79	15.24	16.02	44,570
EGDB2006-5-HD	●	0.3	0.6	5	0.57	0.9	60	4	10	7.59	6.14	6.57	6.93	7.25	7.83	33,530
EGDB2006-10-HD	●			10	0.57	0.9	60	4	10	5.47	11.49	12.08	12.57	12.99	13.72	33,530
EGDB2006-15-HD	●			15	0.57	0.9	60	4	10	4.28	16.77	17.49	18.06	18.55	19.9	35,670
EGDB2006-20-HD	●			20	0.57	0.9	60	4	10	3.51	22.01	22.82	23.47	24.01	26.54	37,820
EGDB2010-10-HD	●	0.5	1	10	0.96	1.5	60	4	10	5.15	11.51	12.09	12.57	12.98	13.7	33,530
EGDB2010-20-HD	●			20	0.96	1.5	60	4	10	3.23	22.02	22.83	23.47	24.01	26.51	33,530
EGDB2010-30-HD	●			30	0.96	1.5	80	4	10	2.35	32.42	33.39	34.25	35.91	干渉なし	35,670
EGDB2010-40-HD	●			40	0.96	1.5	80	4	10	1.85	42.76	43.86	45.65	干渉なし	干渉なし	37,820
EGDB2015-20-HD	●	0.75	1.5	20	1.44	2.25	60	4	10	2.84	22.06	22.85	23.48	24.01	干渉なし	33,530
EGDB2015-40-HD	●			40	1.44	2.25	80	4	10	1.59	42.78	43.87	45.67	干渉なし	干渉なし	35,670
EGDB2020-20-HD	●	1	2	20	1.92	3	60	4	10	2.4	22.1	22.87	23.49	24.02	干渉なし	33,530
EGDB2020-40-HD	●			40	1.92	3	80	4	10	1.31	42.81	43.89	干渉なし	干渉なし	干渉なし	35,670
EGDB2020-60-HD	●			60	1.92	3	100	4	10	0.9	63.36	干渉なし	干渉なし	干渉なし	干渉なし	37,820
EGDB2030-20-HD	●	1.5	3	20	2.88	4.5	60	4	10	1.32	22.18	22.91	干渉なし	干渉なし	干渉なし	33,530
EGDB2030-40-HD	●			40	2.88	4.5	80	4	10	0.69	42.87	干渉なし	干渉なし	干渉なし	干渉なし	33,530
EGDB2030-60-HD	●			60	2.88	4.5	100	4	10	0.47	干渉なし	干渉なし	干渉なし	干渉なし	干渉なし	35,670

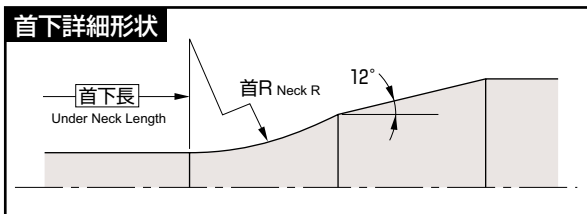

【注意】
加工物に勾配がついている場合、干渉領域は、首下長さよりも長くなります。それぞれの勾配角に対する実有効首下長をご参照ください。
また、工具が加工物に干渉する角度を干渉角度 θ_{κ} で表示していますので合わせてご参照ください。

【Note】
If the workpiece has draft angle, the interference length will be longer than the under-neck length. Please refer to the effective under-neck length for the various draft angles.
In addition, the angle at which the tool will interfere with the workpiece is shown as the "interference angle θ_{κ} ", and should also be referred to.

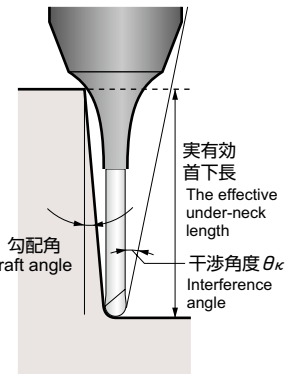

○ 対応被削材 Applicable work material

炭素鋼 合金鋼 Carbon steel Alloy steel	プリハードン鋼 Pre-hardened steel	高硬度 Hardened steel			ステンレス鋼 Stainless steel	チタン合金 耐熱合金 Titanium alloy Heat-resistant alloy	銅合金 Copper alloy	アルミ 合金 Aluminum alloy
	≤ 45HRC	> 45HRC ≤ 55HRC	> 55HRC ≤ 65HRC	> 65HRC				

グラファイト・FRP・高Siアルミニウム合金など for Graphite, FRP, High Si aluminum alloy etc.

○ 再研磨対応外径範囲 Re-grinding compatibility range

商品コード Item code	外周 Outer dia. (mm)	エンド End (mm)
EGDB-HD	× (N/A)	× (N/A)

● : 標準在庫品です。 ● : Stocked items. 干渉なし : No interference

Epoch HD Coating Deep Ball End Mill エポックHDコーティングディープボールエンドミル

超硬ボールエンドミル

標準切削条件表 Recommended cutting conditions

EGDB-HD

被削材 Work material						グラファイト Graphite		アルミニウム合金鋳物 Cast aluminum alloy AC4A, ADC12等 (エアブローorウエット:水溶性) (Air-blow or wet: water-soluble agent)	
商品コード Item code	ボール半径 RE Ball radius (mm)	外径 DC Tool dia. (mm)	首下長LU Under neck length (mm)	L/D	切込み Depth of cut (mm) $a_p \times a_e$	回転数 n min^{-1}	送り速度 v_f mm/min	回転数 n min^{-1}	送り速度 v_f mm/min
EGDB2004-4-HD	0.2	0.4	4	10	0.05×0.15	18,000~21,000	400~550	13,000~18,000	350~500
EGDB2004-8-HD			8	20	0.04×0.12	17,000~20,000	350~500	12,000~17,000	300~450
EGDB2004-12-HD			12	30	0.03×0.10	15,000~18,000	300~400	11,000~16,000	250~350
EGDB2006-5-HD	0.3	0.6	5	8	0.07×0.21	15,000~18,000	350~500	13,000~18,000	300~450
EGDB2006-10-HD			10	17	0.06×0.18	15,000~18,000	300~450	13,000~18,000	250~400
EGDB2006-15-HD			15	25	0.04×0.12	13,000~16,000	270~350	11,000~16,000	200~350
EGDB2006-20-HD			20	33	0.03×0.09	12,000~14,000	240~300	9,000~14,000	200~300
EGDB2010-10-HD	0.5	1	10	10	0.1×0.3	15,000~18,000	350~450	10,000~15,000	300~400
EGDB2010-20-HD			20	20	0.08×0.24	13,000~16,000	300~400	8,000~13,000	300~400
EGDB2010-30-HD			30	30	0.06×0.18	12,000~14,000	270~350	6,000~11,000	250~350
EGDB2010-40-HD			40	40	0.04×0.12	10,000~12,000	240~300	5,000~10,000	250~350
EGDB2015-20-HD	0.75	1.5	20	13	0.1×0.3	15,000~18,000	450~480	10,000~15,000	350~450
EGDB2015-40-HD			40	27	0.08×0.24	12,000~15,000	300~400	7,000~12,000	300~400
EGDB2020-20-HD	1	2	20	10	0.2×0.6	15,000~18,000	450~550	10,000~15,000	350~450
EGDB2020-40-HD			40	20	0.16×0.48	13,000~16,000	350~450	7,000~12,000	300~450
EGDB2020-60-HD			60	30	0.12×0.36	12,000~14,000	250~350	5,000~10,000	250~400
EGDB2030-20-HD	1.5	3	20	7	0.33×1.0	15,000~18,000	800~1,000	10,000~15,000	350~450
EGDB2030-40-HD			40	13	0.2×0.6	15,000~18,000	500~700	7,000~12,000	300~450
EGDB2030-60-HD			60	20	0.18×0.54	13,000~15,000	300~500	5,000~10,000	250~400

- 【注意】** ①被削材、加工形状に合わせて、適切なクーラントを使用してください。
②この標準切削条件表は切削条件の目安を示したものです。実際の加工形状・使用機械・加工目的により条件を調整してください。

- 【Note】** ① Use the appropriate coolant for the work material and machining shape.
② These Recommended Cutting Conditions indicate only the rule of a thumb for the cutting conditions. In actual machining, the condition should be adjusted according to the machining shape, purpose and the machine type.

Epoch HD Coating Ball End Mill

エポックHDコーティングボールエンドミル

ダイヤモンドコーティング

Diamond Coating



グラファイト・高Siアルミ合金・FRP加工に適しています。
ダイヤモンドコーティング。
Ideal for machining of graphite, high-Si aluminum alloys, and FRP.
Diamond Coating.



2枚刃
2Flutes

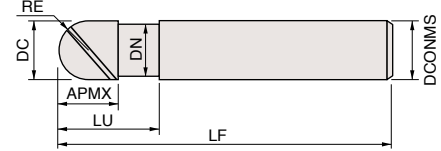

EGB2-HD



商品コード Item code	在庫 Stock	寸法 Size (mm)							希望小売価格 (円) Suggested retail price (¥)
		ボール半径 Ball radius	外径 Tool dia.	首下長 Under neck length	首径 Neck dia.	刃長 Flute length	全長 Overall length	シャンク径 Shank dia.	
		RE	DC	LU	DN	APMX	LF	DCONMS	
EGB2040-HD	●	2	4	40	3.9	8	100	4	41,350
EGB2060-HD	●	3	6	60	5.9	12	120	6	53,080
EGB2080-HD	●	4	8	80	7.9	16	140	8	65,200
EGB2100-HD	●	5	10	100	9.9	20	150	10	84,840

標準切削条件表 Recommended cutting conditions

EGB-HD

被削材 Work material	グラファイト Graphite		アルミニウム合金鋳物 Cast aluminum alloy AC4A, ADC12等 (エアブローorウエット水溶性) (Air-brow or wet-water-soluble agent)	
	ボール半径×外径DC Ball radius × Tool dia. (mm)	回転数 n min^{-1}	送り速度 V_f mm/min	回転数 n min^{-1}
RE2×4	8,000~10,000	1,200~1,500	6,000~9,000	800~1,200
RE3×6	7,000~9,000	1,000~1,300	5,000~8,000	700~1,100
RE4×8	6,000~8,000	900~1,100	4,000~7,000	600~1,000
RE5×10	5,000~7,000	800~1,000	3,000~6,000	500~900

切込み量 Depth of cut (mm)		$a_p \leq 0.1DC$ $a_e \leq 0.3DC$
------------------------------	--	--------------------------------------

[注意] ①被削材、加工形状に合わせて、適切なクーラントを使用してください。
②この標準切削条件表は切削条件の目安を示すものです。実際の加工では加工形状、目的、使用機械等により条件を調整してください。

[Note] ①Use the appropriate coolant for the work material and machining shape.
②These Recommended Cutting Conditions indicate only the rule of a thumb for the cutting conditions. In actual machining, the condition should be adjusted according to the machining shape, purpose and the machine type.

対応被削材 Applicable work material

炭素鋼 合金鋼 Carbon steel Alloy steel	プリハー ド鋼 Pre-hardened steel	高硬度 Hardened steel			ステン レス鋼 Stainless steel	チタン合金 耐熱合金 Titanium alloy Heat-resistant alloy	銅合金 Copper alloy	アルミ 合金 Aluminum alloy
	≤ 45HRC	> 45HRC ≤ 55HRC	> 55HRC ≤ 65HRC	> 65HRC				

グラファイト・FRP・高Siアルミニウム合金など for Graphite, FRP, High Si aluminum alloy etc.

●：標準在庫品です。●：Stocked items.

再研磨対応外径範囲 Re-grinding compatibility range

商品コード Item code	外周 Outer dia. (mm)	エンド End (mm)
EGB-HD	× (N/A)	× (N/A)

Poly Crystalline Diamond Ball End Mill

多結晶焼結ダイヤモンドボールエンドミル

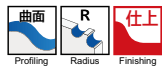

金型の仕上げ加工に!!

Original poly crystalline diamond miniature ball end mill for mold finishing !!

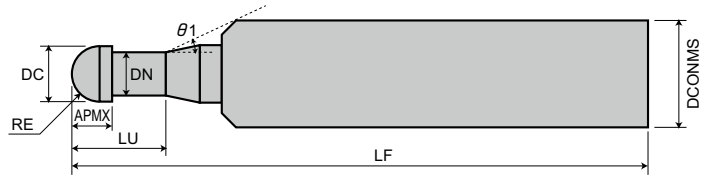

PCDB00



注文コード Order code	在庫 Stock	寸法 Size (mm)							
		ボール半径 Ball radius	外径 Tool dia.	刃長 Flute length	首下長 Under neck length	首径 Under neck dia.	擬似テーパ半角 Interference angle	全長 Overall length	シャンク径 Shank dia.
		RE	DC	APMX	LU	DN	θ_1	LF	DCONMS
PCDB0004		0.2	0.4	0.35	1.4	0.375	19°	40	4
PCDB0006		0.3	0.6	0.45	2.1	0.57	21°	40	4
PCDB0008		0.4	0.8	0.55	2.4	0.77	21°	40	4
PCDB0010		0.5	1	0.65	3	0.96	23°	40	4

※株式会社牧野フライス製作所殿の微細精密加工機iQ300鏡面加工システムに対応した寸法でご提供します。

This tool's specification fits Makino Milling Machine's iQ300 mirror surface finish solution.

対応被削材 Applicable work materia

炭素鋼 合金鋼 Carbon steel Alloy steel	プリハードン鋼 Pre-hardened steel ≤ 45HRC	高硬度 Hardened steel			ステンレス鋼 Stainless steel	チタン合金 耐熱合金 Titanium alloy Heat-resistant alloy	銅合金 Copper alloy	アルミ合金 Aluminum alloy
		> 45HRC ≤ 55HRC	> 55HRC ≤ 65HRC	> 65HRC				
○	○	○	○	○				

再研磨対応外径範囲 Re-grinding compatibility range

商品コード Item code	外周 Outer dia. (mm)	エンド End (mm)
PCDB	× (N/A)	× (N/A)

無印：受注生産品です。 No Mark : Manufactured upon request only.

Epoch CBN High Precision Ball End Mill

エポックCBNハイプレジジョンボールエンドミル



高精度な加工を実現する高品質CBNボールエンドミル
High-quality CBN ball end mill to provide high-accuracy cutting.

RE公差
RE tolerance

RE ≤ 0.3 : ±0.003
0.3 < RE : ±0.005



(mm)



外径実測値付き Includes actual measured mill diameter value.

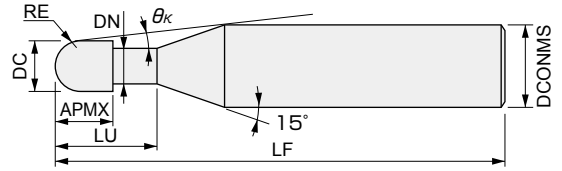

CBN-EHB2

※外径実測値をケースに表示しています
Actual measured mill diameter value is shown on case.

RE0.3以上は再研磨可能です。(必要全長40mm以上)
詳細はお問い合わせください。
Regrinding of tools with RE0.3 or larger is possible. (Necessary total length is at least 40mm). Please contact us for details.



商品コード Item code	在庫 Stock	寸法 Size (mm) Display of actual measured tool dia. for all tools							干渉角度 Interference angle (°)	勾配角に対する実有効首下長 Effective under neck length with respect to draft angle					希望小売 価格(¥) Suggested retail price(¥)
		ボール半径 Ball radius	外径 Tool dia.	首下長 Under neck length	溝長 Flute length	首径 Neck dia.	全長 Overall length	シャンク径 Shank dia.		0.5°	1°	1.5°	2°	3°	
		RE	DC	LU	APMX	DN	LF	DCONMS		θκ					
CBN-EHB2002-0.5	●	0.1	0.2	0.5	0.12	0.18	50	4	14.15	0.55	0.56	0.58	0.60	0.64	30,750
CBN-EHB2002-0.75	●			0.75	0.12	0.18	50	4	13.71	0.81	0.83	0.86	0.89	0.95	30,750
CBN-EHB2002-1	●			1	0.12	0.18	50	4	13.30	1.06	1.10	1.13	1.17	1.26	32,250
CBN-EHB2002-1.5	●			1.5	0.12	0.18	50	4	12.55	1.58	1.63	1.69	1.75	1.88	32,250
CBN-EHB2002-2	●			2	0.12	0.18	50	4	11.88	2.10	2.17	2.24	2.32	2.50	32,250
CBN-EHB2003-0.5	●	0.15	0.3	0.5	0.18	0.27	50	4	14.17	0.56	0.58	0.60	0.61	0.65	30,750
CBN-EHB2003-0.75	●			0.75	0.18	0.27	50	4	13.72	0.82	0.85	0.87	0.90	0.96	30,750
CBN-EHB2003-1	●			1	0.18	0.27	50	4	13.30	1.08	1.11	1.15	1.19	1.27	30,750
CBN-EHB2003-1.5	●			1.5	0.18	0.27	50	4	12.53	1.60	1.65	1.70	1.76	1.89	32,250
CBN-EHB2003-2	●			2	0.18	0.27	50	4	11.84	2.12	2.18	2.26	2.34	2.52	32,250
CBN-EHB2003-3	●			3	0.18	0.27	50	4	10.67	3.15	3.25	3.37	3.49	3.76	32,250
CBN-EHB2004-0.75	●	0.2	0.4	0.75	0.4	0.37	50	4	13.77	0.82	0.84	0.87	0.89	0.95	27,850
CBN-EHB2004-1	●			1	0.4	0.37	50	4	13.33	1.08	1.11	1.14	1.18	1.26	27,850
CBN-EHB2004-1.5	●			1.5	0.4	0.37	50	4	12.54	1.60	1.65	1.70	1.75	1.88	27,850
CBN-EHB2004-2	●			2	0.4	0.37	50	4	11.83	2.11	2.18	2.25	2.33	2.50	29,570
CBN-EHB2004-3	●			3	0.4	0.37	50	4	10.63	3.15	3.25	3.36	3.48	3.75	29,570
CBN-EHB2005-1	●	0.25	0.5	1	0.5	0.47	50	4	13.37	1.08	1.11	1.14	1.17	1.25	27,850
CBN-EHB2005-1.5	●			1.5	0.5	0.47	50	4	12.55	1.60	1.64	1.69	1.75	1.87	27,850
CBN-EHB2005-2.5	●			2.5	0.5	0.47	50	4	11.18	2.63	2.71	2.80	2.90	3.11	29,570
CBN-EHB2005-3	●			3	0.5	0.47	50	4	10.59	3.15	3.25	3.36	3.47	3.73	29,570
CBN-EHB2006-1	●	0.3	0.6	1	0.55	0.57	50	4	13.40	1.08	1.10	1.13	1.17	1.24	25,820
CBN-EHB2006-1.5	●			1.5	0.55	0.57	50	4	12.56	1.59	1.64	1.69	1.74	1.86	25,820
CBN-EHB2006-3	●			3	0.55	0.57	50	4	10.55	3.14	3.24	3.35	3.46	3.72	27,540
CBN-EHB2008-1.5	●	0.4	0.8	1.5	0.7	0.77	50	4	12.58	1.59	1.63	1.68	1.73	1.83	25,820
CBN-EHB2008-2.5	●			2.5	0.7	0.77	50	4	11.09	2.62	2.70	2.79	2.88	3.08	25,820
CBN-EHB2008-4	●			4	0.7	0.77	50	4	9.41	4.17	4.31	4.45	4.60	4.94	27,540
CBN-EHB2010-1.5	●	0.5	1	1.5	1	0.96	50	4	12.57	1.61	1.64	1.69	1.73	1.83	25,820
CBN-EHB2010-2.5	●			2.5	1	0.96	50	4	11.00	2.64	2.71	2.80	2.88	3.08	25,820
CBN-EHB2010-4	●			4	1	0.96	50	4	9.25	4.19	4.32	4.46	4.61	4.94	27,540
CBN-EHB2010-5	●			5	1	0.96	50	4	8.36	5.22	5.39	5.57	5.76	6.19	27,540
CBN-EHB2015-2.5	●	0.75	1.5	2.5	1.35	1.45	50	4	10.76	2.65	2.72	2.79	2.87	3.04	25,820
CBN-EHB2015-5	●			5	1.35	1.45	50	4	7.86	5.23	5.39	5.56	5.74	6.15	26,780
CBN-EHB2015-7.5	●			7.5	1.35	1.45	50	4	6.18	7.82	8.07	8.33	8.62	9.26	29,570
CBN-EHB2020-2.5	●	1	2	2.5	1.65	1.94	50	4	10.43	2.66	2.72	2.78	2.85	3.01	25,820
CBN-EHB2020-5	●			5	1.65	1.94	50	4	7.21	5.25	5.39	5.55	5.73	6.11	26,780
CBN-EHB2020-7.5	●			7.5	1.65	1.94	50	4	5.50	7.83	8.07	8.32	8.60	9.22	29,570
CBN-EHB2020-10	●			10	1.65	1.94	50	4	4.44	10.41	10.74	11.10	11.48	12.33	29,570

○ 対応被削材 Applicable work materia

炭素鋼 合金鋼 Carbon steel Alloy steel	プリハードン 鋼 Pre-hardened steel	高硬度 Hardened steel			ステンレス 鋼 Stainless steel	チタン合金 耐熱合金 Titanium alloy Heat-resistant alloy	銅合金 Copper alloy	アルミ 合金 Aluminum alloy
	≤ 45HRC	> 45HRC ≤ 55HRC	> 55HRC ≤ 65HRC	> 65HRC				
	○	○	○					

○ 再研磨対応外径範囲 Re-grinding compatibility range

商品コード Item code	外周 Outer dia. (mm)	エンド End (mm)
CBN-EHB	× (N/A)	0.6 ~ 2

● : 標準在庫品です。 ● : Stocked items.

標準切削条件表 Recommended cutting conditions

CBN-EHB

<高効率加工条件> High efficiency condition

被削材 Work material			焼入れ鋼 Hardened steels (50~55HRC) HPM38				焼入れ鋼 Hardened steels (55~62HRC) SKD11,YXR3				焼入れ鋼 Hardened steels (62~64HRC) SKH51,HAP10				焼入れ鋼 Hardened steels (64~70HRC) HAP40,HAP72				
ボール半径 Ball radius RE (mm)	外径 Tool dia. DC (mm)	首下長 Under neck length LU (mm)	回転数 n min ⁻¹	送り速度 V _f mm/min	切込み量(mm) Depth of cut		回転数 n min ⁻¹	送り速度 V _f mm/min	切込み量(mm) Depth of cut		回転数 n min ⁻¹	送り速度 V _f mm/min	切込み量(mm) Depth of cut		回転数 n min ⁻¹	送り速度 V _f mm/min	切込み量(mm) Depth of cut		
					a _p	a _e			a _p	a _e			a _p	a _e			a _p	a _e	
0.1	0.2	0.5	50,000	480	0.006	0.018	50,000	420	0.006	0.018	50,000	350	0.004	0.012	50,000	290	0.004	0.012	
		0.75	50,000	480	0.004	0.012	50,000	420	0.004	0.012	50,000	350	0.003	0.009	50,000	290	0.003	0.009	
		1	50,000	480	0.003	0.009	50,000	420	0.003	0.009	50,000	350	0.002	0.006	50,000	290	0.002	0.006	
		1.5	-	-	-	-	-	-	-	-	-	-	-	-	-	-	-	-	-
		2	-	-	-	-	-	-	-	-	-	-	-	-	-	-	-	-	-
0.15	0.3	0.5	50,000	720	0.009	0.027	50,000	620	0.009	0.027	50,000	530	0.007	0.021	50,000	430	0.006	0.018	
		0.75	50,000	720	0.009	0.027	50,000	620	0.009	0.027	50,000	530	0.007	0.021	50,000	430	0.006	0.018	
		1	50,000	720	0.008	0.024	50,000	620	0.008	0.024	50,000	530	0.006	0.018	50,000	430	0.005	0.015	
		1.5	50,000	720	0.005	0.015	50,000	620	0.005	0.015	50,000	530	0.004	0.012	50,000	430	0.003	0.009	
		2	-	-	-	-	-	-	-	-	-	-	-	-	-	-	-	-	-
0.2	0.4	0.75	50,000	1,020	0.012	0.036	50,000	880	0.012	0.036	50,000	750	0.01	0.03	50,000	610	0.008	0.024	
		1	50,000	1,020	0.012	0.036	50,000	880	0.012	0.036	50,000	750	0.01	0.03	50,000	610	0.008	0.024	
		1.5	50,000	1,020	0.008	0.024	50,000	880	0.008	0.024	50,000	750	0.007	0.021	50,000	610	0.005	0.015	
		2	50,000	1,020	0.006	0.018	50,000	880	0.006	0.018	50,000	750	0.005	0.015	50,000	610	0.004	0.012	
		3	-	-	-	-	-	-	-	-	-	-	-	-	-	-	-	-	-
0.25	0.5	1	50,000	1,280	0.015	0.045	50,000	1,110	0.015	0.045	50,000	940	0.012	0.036	50,000	770	0.01	0.03	
		1.5	50,000	1,280	0.015	0.045	50,000	1,110	0.015	0.045	50,000	940	0.012	0.036	50,000	770	0.01	0.03	
		2.5	50,000	1,280	0.008	0.024	50,000	1,110	0.008	0.024	50,000	940	0.006	0.018	50,000	770	0.005	0.015	
		3	-	-	-	-	-	-	-	-	-	-	-	-	-	-	-	-	-
0.3	0.6	1	50,000	1,620	0.018	0.054	50,000	1,400	0.018	0.054	50,000	1,190	0.015	0.045	50,000	970	0.012	0.036	
		1.5	50,000	1,620	0.018	0.054	50,000	1,400	0.018	0.054	50,000	1,190	0.015	0.045	50,000	970	0.012	0.036	
		3	50,000	1,620	0.009	0.027	50,000	1,400	0.009	0.027	50,000	1,190	0.007	0.021	50,000	970	0.006	0.018	
0.4	0.8	1.5	50,000	2,160	0.024	0.072	50,000	1,870	0.024	0.072	50,000	1,580	0.02	0.06	50,000	1,300	0.016	0.048	
		2.5	50,000	2,160	0.024	0.072	50,000	1,870	0.024	0.072	50,000	1,580	0.02	0.06	50,000	1,300	0.016	0.048	
		4	40,000	1,730	0.012	0.036	40,000	1,500	0.012	0.036	40,000	1,270	0.01	0.03	40,000	1,040	0.008	0.024	
0.5	1	1.5	40,000	2,400	0.03	0.09	40,000	2,080	0.03	0.09	40,000	1,760	0.024	0.072	40,000	1,440	0.02	0.06	
		2.5	40,000	2,400	0.03	0.09	40,000	2,080	0.03	0.09	40,000	1,760	0.024	0.072	40,000	1,440	0.02	0.06	
		4	36,000	2,160	0.02	0.06	36,000	1,870	0.02	0.06	36,000	1,580	0.016	0.048	36,000	1,300	0.013	0.039	
		5	32,000	1,920	0.015	0.045	32,000	1,660	0.015	0.045	32,000	1,410	0.012	0.036	32,000	1,150	0.01	0.03	
0.75	1.5	2.5	27,000	2,430	0.045	0.135	27,000	2,110	0.045	0.135	27,000	1,780	0.036	0.108	27,000	1,460	0.03	0.09	
		5	27,000	2,430	0.045	0.135	27,000	2,110	0.045	0.135	27,000	1,780	0.036	0.108	27,000	1,460	0.03	0.09	
		7.5	21,000	1,890	0.03	0.09	21,000	1,640	0.03	0.09	21,000	1,390	0.024	0.072	21,000	1,130	0.02	0.06	
1	2	2.5	20,000	2,400	0.06	0.18	20,000	2,080	0.06	0.18	20,000	1,760	0.048	0.144	20,000	1,440	0.04	0.12	
		5	20,000	2,400	0.06	0.18	20,000	2,080	0.06	0.18	20,000	1,760	0.048	0.144	20,000	1,440	0.04	0.12	
		7.5	18,000	2,160	0.04	0.12	18,000	1,870	0.04	0.12	18,000	1,580	0.032	0.096	18,000	1,300	0.027	0.081	
		10	16,000	1,920	0.03	0.09	16,000	1,660	0.03	0.09	16,000	1,410	0.024	0.072	16,000	1,150	0.02	0.06	

- [注意]** ①被削材、加工形状に合わせて、適切なクーラントを使用してください。
 ②この標準切削条件表は切削条件の目安を示すものです。実際の加工では加工形状、目的、使用機械等により条件を調整してください。
 ③機械の回転数が足りない場合は、回転数と送り速度を同じ比率で下げてください。

[Note] 1) Use the appropriate coolant for the work material and machining shape.
 2) This standard cutting condition table is intended as reference cutting conditions. The conditions should be adjusted as necessary according to the actual conditions of machined shape, purpose, machine used, etc.
 3) If the machine rotation speed is insufficient, reduce the rotation speed and feed rate by the same ratio.

<仕上げ加工条件> Finishing condition

被削材 Work material			焼入れ鋼 Hardened steels (50~55HRC) HPM38				焼入れ鋼 Hardened steels (55~62HRC) SKD11, YXR3				焼入れ鋼 Hardened steels (62~64HRC) SKH51, HAP10				焼入れ鋼 Hardened steels (64~70HRC) HAP40, HAP72			
ボール半径 RE (mm)	外径 DC (mm)	首下長 LU (mm)	回転数 n min ⁻¹	送り速度 Vf mm/min	切込み量(mm) Depth of cut		回転数 n min ⁻¹	送り速度 Vf mm/min	切込み量(mm) Depth of cut		回転数 n min ⁻¹	送り速度 Vf mm/min	切込み量(mm) Depth of cut		回転数 n min ⁻¹	送り速度 Vf mm/min	切込み量(mm) Depth of cut	
					ap	ae			ap	ae			ap	ae			ap	ae
0.1	0.2	0.5	50,000	420	0.004	0.004	50,000	350	0.004	0.004	50,000	290	0.004	0.004	50,000	220	0.004	0.004
		0.75	50,000	420	0.003	0.003	50,000	350	0.003	0.003	50,000	290	0.003	0.003	50,000	220	0.003	0.003
		1	50,000	420	0.002	0.002	50,000	350	0.002	0.002	50,000	290	0.002	0.002	50,000	220	0.002	0.002
		1.5	50,000	420	0.001	0.001	50,000	350	0.001	0.001	50,000	290	0.001	0.001	50,000	220	0.001	0.001
		2	50,000	420	0.001	0.001	50,000	350	0.001	0.001	50,000	290	0.001	0.001	50,000	220	0.001	0.001
0.15	0.3	0.5	50,000	620	0.006	0.006	50,000	530	0.006	0.006	50,000	430	0.006	0.006	50,000	340	0.006	0.006
		0.75	50,000	620	0.006	0.006	50,000	530	0.006	0.006	50,000	430	0.006	0.006	50,000	340	0.006	0.006
		1	50,000	620	0.005	0.005	50,000	530	0.005	0.005	50,000	430	0.005	0.005	50,000	340	0.005	0.005
		1.5	50,000	620	0.003	0.003	50,000	530	0.003	0.003	50,000	430	0.003	0.003	50,000	340	0.003	0.003
		2	50,000	620	0.003	0.003	50,000	530	0.003	0.003	50,000	430	0.003	0.003	50,000	340	0.003	0.003
0.2	0.4	0.75	50,000	880	0.008	0.008	50,000	750	0.008	0.008	50,000	610	0.008	0.008	50,000	480	0.008	0.008
		1	50,000	880	0.008	0.008	50,000	750	0.008	0.008	50,000	610	0.008	0.008	50,000	480	0.008	0.008
		1.5	50,000	880	0.005	0.005	50,000	750	0.005	0.005	50,000	610	0.005	0.005	50,000	480	0.005	0.005
		2	50,000	880	0.004	0.004	50,000	750	0.004	0.004	50,000	610	0.004	0.004	50,000	480	0.004	0.004
		3	50,000	880	0.003	0.003	50,000	750	0.003	0.003	50,000	610	0.003	0.003	50,000	480	0.003	0.003
0.25	0.5	1	50,000	1,110	0.01	0.01	50,000	940	0.01	0.01	50,000	770	0.01	0.01	50,000	600	0.01	0.01
		1.5	50,000	1,110	0.01	0.01	50,000	940	0.01	0.01	50,000	770	0.01	0.01	50,000	600	0.01	0.01
		2.5	50,000	1,110	0.005	0.005	50,000	940	0.005	0.005	50,000	770	0.005	0.005	50,000	600	0.005	0.005
		3	48,000	1,060	0.005	0.005	48,000	900	0.005	0.005	48,000	730	0.005	0.005	48,000	570	0.005	0.005
0.3	0.6	1	50,000	1,400	0.012	0.012	50,000	1,190	0.012	0.012	50,000	970	0.012	0.012	50,000	760	0.012	0.012
		1.5	50,000	1,400	0.012	0.012	50,000	1,190	0.012	0.012	50,000	970	0.012	0.012	50,000	760	0.012	0.012
		3	50,000	1,400	0.006	0.006	50,000	1,190	0.006	0.006	50,000	970	0.006	0.006	50,000	760	0.006	0.006
0.4	0.8	1.5	50,000	1,870	0.016	0.016	50,000	1,580	0.016	0.016	50,000	1,300	0.016	0.016	50,000	1,010	0.016	0.016
		2.5	50,000	1,870	0.016	0.016	50,000	1,580	0.016	0.016	50,000	1,300	0.016	0.016	50,000	1,010	0.016	0.016
		4	40,000	1,500	0.008	0.008	40,000	1,270	0.008	0.008	40,000	1,040	0.008	0.008	40,000	810	0.008	0.008
0.5	1	1.5	40,000	2,080	0.02	0.02	40,000	1,760	0.02	0.02	40,000	1,440	0.02	0.02	40,000	1,120	0.02	0.02
		2.5	40,000	2,080	0.02	0.02	40,000	1,760	0.02	0.02	40,000	1,440	0.02	0.02	40,000	1,120	0.02	0.02
		4	36,000	1,870	0.013	0.013	36,000	1,580	0.013	0.013	36,000	1,300	0.013	0.013	36,000	1,010	0.013	0.013
		5	32,000	1,660	0.01	0.01	32,000	1,410	0.01	0.01	32,000	1,150	0.01	0.01	32,000	900	0.01	0.01
0.75	1.5	2.5	27,000	2,110	0.03	0.03	27,000	1,780	0.03	0.03	27,000	1,460	0.03	0.03	27,000	1,130	0.03	0.03
		5	27,000	2,110	0.03	0.03	27,000	1,780	0.03	0.03	27,000	1,460	0.03	0.03	27,000	1,130	0.03	0.03
		7.5	21,000	1,640	0.02	0.02	21,000	1,390	0.02	0.02	21,000	1,130	0.02	0.02	21,000	880	0.02	0.02
1	2	2.5	20,000	2,080	0.04	0.04	20,000	1,760	0.04	0.04	20,000	1,440	0.04	0.04	20,000	1,120	0.04	0.04
		5	20,000	2,080	0.04	0.04	20,000	1,760	0.04	0.04	20,000	1,440	0.04	0.04	20,000	1,120	0.04	0.04
		7.5	18,000	1,870	0.027	0.027	18,000	1,580	0.027	0.027	18,000	1,300	0.027	0.027	18,000	1,010	0.027	0.027
		10	16,000	1,660	0.02	0.02	16,000	1,410	0.02	0.02	16,000	1,150	0.02	0.02	16,000	900	0.02	0.02

- [注意]** ①被削材、加工形状に合わせて、適切なクーラントを使用してください。
 ②この標準切削条件表は切削条件の目安を示すものです。実際の加工では加工形状、目的、使用機械等により条件を調整してください。
 ③機械の回転数が足りない場合は、回転数と送り速度を同じ比率で下げてください。

- [Note]** 1) Use the appropriate coolant for the work material and machining shape.
 2) This standard cutting condition table is intended as reference cutting conditions. The conditions should be adjusted as necessary according to the actual conditions of machined shape, purpose, machine used, etc.
 3) If the machine rotation speed is insufficient, reduce the rotation speed and feed rate by the same ratio.

○ 使用上の注意点 Cautions regarding use

<中仕上げ加工に関して> About semi-finishing

安定した加工を行うために、中仕上げ加工にてコーナ部の削り残り加工を行ってください。(仕上げ加工における加工量を均一にする)

この時、カスプハイト量が一定になるプログラムにて加工することを推奨します。また、中仕上げ加工はCBNエンドミルで行うことを推奨します。

For stable machining, perform semi finishing to remove remaining stock in the corners. (This will make the machining amount for finishing uniform.)

At this time, it is recommended that the program should be set so that the cusp height will be a constant amount. In addition, it is recommended that semi finishing should be performed with CBN end mill.

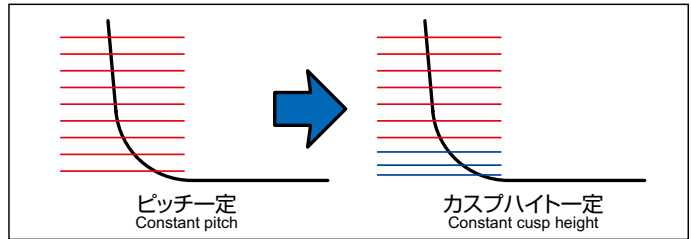
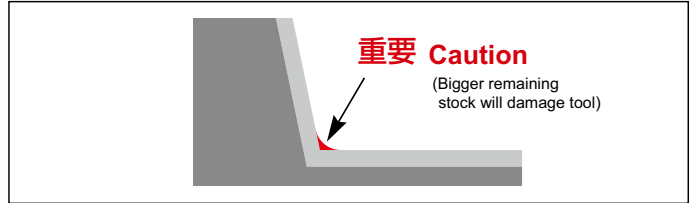

<径補正值の入力> Input of diameter correction value

エポックCBNハイプレジジョンボールエンドミルはケースに外径実測値を記載しています。

荒加工～仕上げ加工までの工具径の実測値をCAMに入力する事で、最終的な加工精度を向上することが可能です。

【入力例】 ボールエンドミル: 工具径 $\phi 0.498 \rightarrow R0.249$

For Epoch CBN High Precision Ball End Mill, the measured outside diameter value is shown on the case.

Inputting the actual measured value for the tool diameter in CAM from roughing to finishing will enable improved final machining accuracy.

【Input example】 Ball end mill: Tool diameter $\phi 0.498 \rightarrow R0.249$

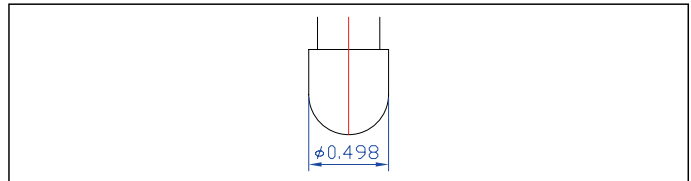
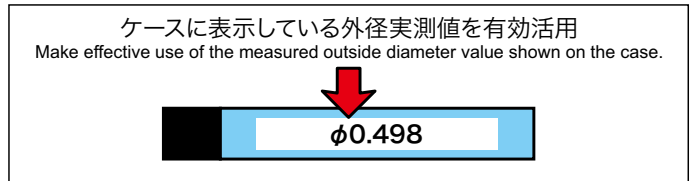

<送り速度に関して> Regarding feed rate

機械実送り速度が入力値に達していないような場合、(ワーク寸法が小さくて送りが上がらない場合など)は、送り速度の加減速が急激に生じるため、欠損などの原因になります。このような時は機械が追従する送り速度を入力してください。

If the actual feed rate of the machine does not reach the set value (such as when workpiece is small and speed cannot be increased, etc.), sudden increases/decreases in feed rate may occur, which can cause chipping, etc.

In such cases, input the feed rate that the machine can support.

エポックCBNスーパーボールエンドミル



RE公差 ±0.005

h4

(mm)

切れ味と刃先強度を両立した新発想CBNエンドミル。

New-concept CBN end mill providing both good cutting performance and strong flute edges.

Includes actual measured mill diameter value.

外径実測値付き

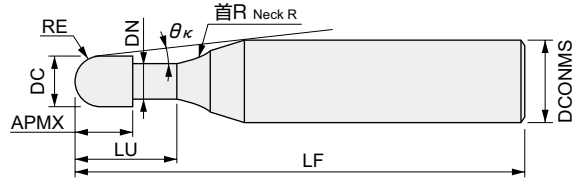

CBN-EPSB2-0.1-0.5-S/F

※外径実測値をケースに表示しています

Actual measured mill diameter value is shown on case.

CBN

ストロング(S)刃形 Strong (S) type		ファイン(F)刃形 Fine (F) type		寸法 Size (mm)								干渉角度 Interference angle (°)		勾配角に対する 実有効首下長 Effective under neck length with respect to draft angle					希望小売 価格(¥) Suggested retail price(¥)
商品コード Item code	在庫 Stock	商品コード Item code	在庫 Stock	ボール半径	外径	首下長	刃長	首径	全長	シャンク径	首R	θ _k	0.5°	1°	1.5°	2°	3°		
				RE	DC	LU	APMX	DN	LF	DCONMS	Neck R								
CBN-EPSB2002-0.5-S	●	CBN-EPSB2002-0.5-F	●	0.1	0.2	0.5	0.12	0.18	50	4	1	11.45	0.67	0.7	0.72	0.75	0.8	32,670	
CBN-EPSB2002-1-S	●	CBN-EPSB2002-1-F	●			1	0.12	0.18	50	4	1	10.88	1.19	1.24	1.28	1.32	1.38	34,280	
CBN-EPSB2003-0.75-S	●	CBN-EPSB2003-0.75-F	●	0.15	0.3	0.75	0.18	0.27	50	4	1	11.17	0.95	0.99	1.02	1.05	1.1	32,670	
CBN-EPSB2003-1.5-S	●	CBN-EPSB2003-1.5-F	●			1.5	0.18	0.27	50	4	1	10.36	1.73	1.79	1.83	1.88	2.03	34,280	
CBN-EPSB2004-1-S	●	CBN-EPSB2004-1-F	●	0.2	0.4	1	0.24	0.37	50	4	1	10.91	1.21	1.25	1.29	1.32	1.38	29,680	
CBN-EPSB2004-2-S	●	CBN-EPSB2004-2-F	●			2	0.24	0.37	50	4	1	9.88	2.25	2.31	2.37	2.43	2.68	31,490	
CBN-EPSB2005-1.5-S	●	CBN-EPSB2005-1.5-F	●	0.25	0.5	1.5	0.3	0.47	50	4	1	10.39	1.73	1.78	1.83	1.87	2	29,680	
CBN-EPSB2005-3-S	●	CBN-EPSB2005-3-F	●			3	0.3	0.47	50	4	1	9	3.28	3.36	3.46	3.62	3.99	31,490	
CBN-EPSB2006-1.5-S	●	CBN-EPSB2006-1.5-F	●	0.3	0.6	1.5	0.36	0.57	50	4	1	10.4	1.73	1.78	1.82	1.86	1.98	27,430	
CBN-EPSB2006-3-S	●	CBN-EPSB2006-3-F	●			3	0.36	0.57	50	4	1	8.98	3.28	3.36	3.46	3.61	3.97	29,250	
CBN-EPSB2008-2.5-S	●	CBN-EPSB2008-2.5-F	●	0.4	0.8	2.5	0.48	0.77	50	4	1	9.37	2.76	2.83	2.89	2.99	3.28	27,430	
CBN-EPSB2008-5-S	●	CBN-EPSB2008-5-F	●			5	0.48	0.77	50	4	1	7.48	5.33	5.48	5.72	5.99	6.6	29,680	
CBN-EPSB2010-2.5-S	●	CBN-EPSB2010-2.5-F	●	0.5	1	2.5	0.6	0.96	50	4	1	9.31	2.77	2.84	2.89	3	3.28	27,430	
CBN-EPSB2010-5-S	●	CBN-EPSB2010-5-F	●			5	0.6	0.96	50	4	1	7.34	5.34	5.5	5.74	5.99	6.6	29,250	
CBN-EPSB2010-10-S	●	CBN-EPSB2010-10-F	●			10	0.6	0.96	50	4	1	5.15	10.5	10.95	11.44	11.98	13.23	30,320	
CBN-EPSB2015-5-S	●	CBN-EPSB2015-5-F	●	0.75	1.5	5	0.9	1.44	50	4	1	6.94	5.36	5.53	5.75	6	6.58	28,500	
CBN-EPSB2015-10-S	●	CBN-EPSB2015-10-F	●			10	0.9	1.44	50	4	1	4.68	10.54	10.98	11.46	11.98	13.22	31,490	
CBN-EPSB2020-5-S	●	CBN-EPSB2020-5-F	●	1	2	5	1.2	1.92	50	4	1	6.42	5.38	5.56	5.77	6.01	6.56	28,500	
CBN-EPSB2020-10-S	●	CBN-EPSB2020-10-F	●			10	1.2	1.92	50	4	1	4.12	10.58	11.01	11.48	11.99	13.2	31,490	
CBN-EPSB2020-20-S	●	CBN-EPSB2020-20-F	●			20	1.2	1.92	55	4	1	2.4	21	21.9	22.88	23.96	干渉なし	38,460	

【基本推奨】 F刃型:L/D(首下長/外径)≤5、 S刃型:L/D(首下長/外径)>5

【Basic recommendation】 F type : L/D(under neck length/mill dia)≤5, S type : L/D(under neck length/mill dia)>5

首下詳細形状 Detailed shape below neck

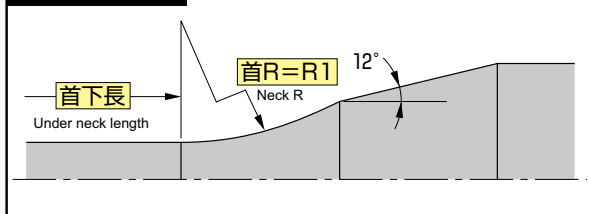

【注意】

加工物に勾配がついている場合、干渉領域は、首下長さよりも長くなります。それぞれの勾配角に対する実有効首下長をご参照ください。
また、工具が加工物に干渉する角度を、干渉角度θ_kで表示していますので合わせてご参照ください。

【Note】

If the workpiece has draft angle, the interference length will be longer than the under-neck length. Please refer to the effective under-neck length for the various draft angles.
In addition, the angle at which the tool will interfere with the workpiece is shown as the "interference angle θ_k", and should also be referred to.

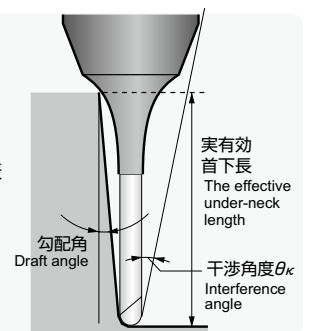

○ 対応被削材 Applicable work materia

炭素鋼 合金鋼 Carbon steel Alloy steel	プリハードン鋼 Pre-hardened steel ≤ 55HRC	高硬度 Hardened steel			ステンレス鋼 Stainless steel	チタン合金 耐熱合金 Titanium alloy Heat-resistant alloy	銅合金 Copper alloy	アルミ合金 Aluminum alloy
		> 45HRC ≤ 55HRC	> 55HRC ≤ 65HRC	> 65HRC				
	○	○	○					

○ : 標準在庫品です。 ● : Stocked items. 干渉なし : No interference

○ 再研磨対応外径範囲 Re-grinding compatibility range

商品コード Item code	外周 Outer dia. (mm)	エンド End (mm)
CBN-EPSB	× (N/A)	× (N/A)

Carbide End Mills
Ball End Mills

標準切削条件表 Recommended cutting conditions **CBN-EP SB-S** **CBN-EP SB-F**

<中仕上げ加工条件> Semi-finishing condition

被削材 Work material					1		2		3		4	
					焼入れ鋼 Hardened steels (~55HRC) HPM1,SKD61,SKT4		焼入れ鋼 Hardened steels (55~65HRC) SKD11,SKH51		焼入れ鋼 Hardened steels (65~68HRC) SKH,溶製ハイス		焼入れ鋼 Hardened steels (68~72HRC) HAP,粉末ハイス	
切込み比率 Ratio to standard depth of cut					100%		90%		80%		70%	
ボール半径RE Ball radius (mm)	外径DC Tool dia. (mm)	首下長LU Under neck length (mm)	切込み量 Depth of cut (mm)		回転数 n min ⁻¹	送り速度 v _f mm/min	回転数 n min ⁻¹	送り速度 v _f mm/min	回転数 n min ⁻¹	送り速度 v _f mm/min	回転数 n min ⁻¹	送り速度 v _f mm/min
			a _p	a _e								
0.1	0.2	0.5	0.005	0.015	50,000	600	48,000	500	45,000	410	43,000	320
		1	0.005	0.015	46,000	460	44,000	390	42,000	320	39,000	240
0.15	0.3	0.75	0.006	0.018	50,000	900	47,000	740	45,000	610	42,000	470
		1.5	0.006	0.018	45,000	680	42,000	550	40,000	450	38,000	360
0.2	0.4	1	0.008	0.024	46,000	1,100	44,000	920	42,000	760	39,000	590
		2	0.008	0.024	41,000	820	39,000	680	37,000	560	35,000	440
0.25	0.5	1.5	0.013	0.039	46,000	1,380	44,000	1,160	41,000	920	39,000	730
		3	0.01	0.03	41,000	1,030	39,000	850	37,000	690	35,000	550
0.3	0.6	1.5	0.015	0.045	42,000	1,760	40,000	1,470	38,000	1,200	36,000	950
		3	0.012	0.036	38,000	1,370	36,000	1,130	34,000	920	32,000	720
0.4	0.8	2.5	0.02	0.06	42,000	2,350	40,000	1,960	38,000	1,600	36,000	1,260
		5	0.016	0.048	38,000	2,130	36,000	1,760	34,000	1,430	32,000	1,120
0.5	1	2.5	0.035	0.105	38,000	2,660	36,000	2,210	34,000	1,790	32,000	1,400
		5	0.02	0.06	34,000	2,380	33,000	2,020	31,000	1,630	29,000	1,270
0.75	1.5	10	0.015	0.045	27,000	1,620	25,000	1,310	24,000	1,080	23,000	860
		5	0.03	0.09	32,000	2,400	30,000	1,970	29,000	1,630	27,000	1,270
1	2	10	0.02	0.06	22,000	1,320	21,000	1,100	20,000	900	19,000	710
		5	0.05	0.15	28,000	2,800	27,000	2,360	25,000	1,880	24,000	1,500
		10	0.03	0.09	25,000	2,500	24,000	2,100	23,000	1,730	21,000	1,310
		20	0.02	0.06	20,000	1,600	19,000	1,330	18,000	1,080	17,000	850

<仕上げ加工条件> Finishing condition

被削材 Work material					1		2		3		4	
					焼入れ鋼 Hardened steels (~55HRC) HPM1,SKD61,SKT4		焼入れ鋼 Hardened steels (55~65HRC) SKD11,SKH51		焼入れ鋼 Hardened steels (65~68HRC) SKH,溶製ハイス		焼入れ鋼 Hardened steels (68~72HRC) HAP,粉末ハイス	
切込み比率 Ratio to standard depth of cut					100%		90%		80%		70%	
ボール半径RE Ball radius (mm)	外径DC Tool dia. (mm)	首下長LU Under neck length (mm)	切込み量 Depth of cut (mm)		回転数 n min ⁻¹	送り速度 v _f mm/min	回転数 n min ⁻¹	送り速度 v _f mm/min	回転数 n min ⁻¹	送り速度 v _f mm/min	回転数 n min ⁻¹	送り速度 v _f mm/min
			a _p	a _e								
0.1	0.2	0.5	0.005	0.015	50,000	480	48,000	410	45,000	350	43,000	290
		1	0.005	0.015	46,000	370	44,000	320	42,000	270	39,000	220
0.15	0.3	0.75	0.005	0.015	50,000	720	47,000	610	45,000	520	42,000	420
		1.5	0.005	0.015	45,000	540	42,000	450	40,000	380	38,000	320
0.2	0.4	1	0.006	0.018	46,000	880	44,000	760	42,000	650	39,000	520
		2	0.006	0.018	41,000	660	39,000	560	37,000	470	35,000	390
0.25	0.5	1.5	0.008	0.024	46,000	1,100	44,000	950	41,000	790	39,000	660
		3	0.008	0.024	41,000	820	39,000	700	37,000	590	35,000	490
0.3	0.6	1.5	0.01	0.03	42,000	1,410	40,000	1,210	38,000	1,020	36,000	850
		3	0.008	0.024	38,000	1,090	36,000	930	34,000	780	32,000	650
0.4	0.8	2.5	0.015	0.045	42,000	1,880	40,000	1,610	38,000	1,360	36,000	1,130
		5	0.012	0.036	38,000	1,700	36,000	1,450	34,000	1,220	32,000	1,000
0.5	1	2.5	0.02	0.06	38,000	2,130	36,000	1,810	34,000	1,520	32,000	1,250
		5	0.018	0.054	34,000	1,900	33,000	1,660	31,000	1,390	29,000	1,140
0.75	1.5	10	0.01	0.03	27,000	1,300	25,000	1,080	24,000	920	23,000	770
		5	0.023	0.069	32,000	1,920	30,000	1,620	29,000	1,390	27,000	1,130
1	2	10	0.018	0.054	22,000	1,060	21,000	910	20,000	770	19,000	640
		5	0.025	0.075	28,000	2,240	27,000	1,940	25,000	1,600	24,000	1,340
		10	0.02	0.06	25,000	2,000	24,000	1,730	23,000	1,470	21,000	1,180
		20	0.012	0.036	20,000	1,280	19,000	1,090	18,000	920	17,000	760

(※)基本切込みは被削材グループ1での目安を示しています。その他のグループの場合は、上表の切込み比率を目安に調整してください。

The indicated standard cutting depth is a reference value for Group 1 work materials.

For materials in other groups, the cutting depth should be adjusted using the reference ratio shown in the above table.

- [注意]** ①被削材、加工形状に合わせて、適切なクーラントを使用してください。
 ②この標準切削条件表は切削条件の目安を示すものです。実際の加工では加工形状、目的、使用機械等により条件を調整してください。
 ③機械の回転数が足りない場合は、回転数と送り速度を同じ比率で下げてください。

- [Note]** 1) Use the appropriate coolant for the work material and machining shape.
 2) This standard cutting condition table is intended as reference cutting conditions. The conditions should be adjusted as necessary according to the actual conditions of machined shape, purpose, machine used, etc.
 3) If the machine rotation speed is insufficient, reduce the rotation speed and feed rate by the same ratio.

エポックファインボール -磨きレス-



仕上げ加工に適しています。
Ideal for finish machining

RE公差 ±0.005

h5

2枚刃
2Flutes

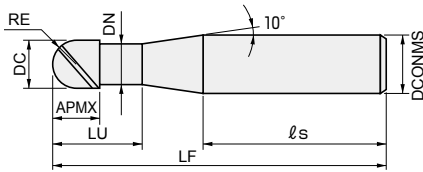

Aタイプ A type

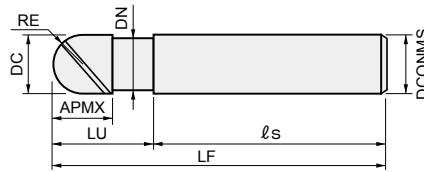

Bタイプ B type

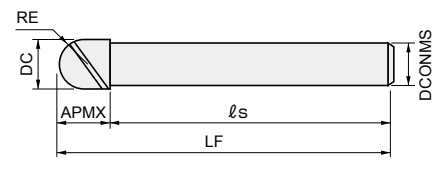

Cタイプ C type

EFB2

超硬 Carbide 傾斜角 Helix angle 30° 切削条件表 Cutting Conditions A153

商品コード Item code	在庫 Stock	寸法 Size (mm)								形状 Shape	希望小売価格 (円) Suggested retail price(¥)
		ボール半径 Ball radius RE	外径 Tool dia. DC	刃長 Flute length APMX	首径 Neck dia. DN	首下長 Under neck length LU	シャンク長 Shank length ls	全長 Overall length LF	シャンク径 Shank dia. DCONMS		
EFB2010	●	0.5	1	1	0.95	2.2	39.2	50	4	A	11,250
EFB2015	●	0.75	1.5	1.5	1.4	3	39.6	50	4	A	11,790
EFB2020	●	1	2	2	1.9	4	34.4	50	6	A	11,790
EFB2025	●	1.25	2.5	2.5	2.4	5	34.8	50	6	A	12,650
EFB2030	●	1.5	3	3	2.9	6	55.2	70	6	A	12,650
EFB2040	●	2	4	4	3.9	8	56	70	6	A	12,650
EFB2050	●	2.5	5	5	4.9	10	66.9	80	6	A	14,150
EFB2060	●	3	6	6	5.9	12	78	90	6	B	14,930
EFB2070	●	3.5	7	7	-	-	83	90	6	C	17,290
EFB2080	●	4	8	8	7.9	16	84	100	8	B	19,530
EFB2100	●	5	10	10	9.9	20	80	100	10	B	25,030
EFB2120	●	6	12	12	11.9	24	86	110	12	B	32,210

標準切削条件表 Recommended cutting conditions

EFB

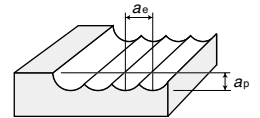

<仕上げ加工> Finishing

被削材 Work material	合金鋼・プリハードン鋼 Alloy steels, Pre-hardened steels (30~45HRC) SCM440, HPM1, CENA1, HPM50, NAK55, NAK80				調質鋼 Hardened steels (45~53HRC) HPM38, STAVAX			
	高速条件 High speed		汎用条件 General		高速条件 High speed		汎用条件 General	
条件域 Cutting range	高速条件 High speed		汎用条件 General		高速条件 High speed		汎用条件 General	
切込み Depth of cut (mm)	ap=0.01DC, ae=0.02DC		ap=0.02DC, ae=0.03DC		ap=0.01DC, ae=0.02DC		ap=0.02DC, ae=0.03DC	
ボール半径RE×外径DC Ball radius × Tool dia.(mm)	回転数 n (min ⁻¹)	送り速度 vf (mm/min)	回転数 n (min ⁻¹)	送り速度 vf (mm/min)	回転数 n (min ⁻¹)	送り速度 vf (mm/min)	回転数 n (min ⁻¹)	送り速度 vf (mm/min)
RE0.5×1	30,000	1,800	16,000	960	24,000	1,400	12,800	770
RE1×2	25,000	2,500	16,000	1,600	25,000	2,500	16,000	1,600
RE2×4	20,000	3,200	12,500	2,000	16,000	2,550	10,000	1,600
RE3×6	16,000	3,200	8,500	1,700	12,800	2,500	6,800	1,350
RE4×8	12,000	2,600	6,400	1,400	9,600	2,000	5,100	1,100
RE5×10	9,500	2,300	5,100	1,200	7,600	1,800	4,000	960
RE6×12	8,000	2,000	4,200	1,050	6,400	1,600	3,400	840

- [注意]**
- ①できるだけ高剛性、高精度の機械をご使用ください。
 - ②上表の切り込みは目安です。実際にはボールエンドミルのカスプハイト量を参考にピックフィード量を選定ください。(A131頁参照)
 - ③被削材、加工形状に合わせて、適切なクーラントを使用してください。
 - ④この標準切削条件表は切削条件の目安を示すものです。実際の加工では加工形状、目的、使用機械等により条件を調整してください。

- [Note]**
- ① Use as highly rigid and highly accurate machine as possible.
 - ② The cutting depth shown in the above table is just for your guidance. For your actual use, select the most suitable pick feed rate referring to the cusp height of a ball end mill. (Refer p.A131)
 - ③ Use the appropriate coolant for the work material and machining shape.
 - ④ These Recommended Cutting Conditions indicate only the rule of a thumb for the cutting conditions. In actual machining, the condition should be adjusted according to the machining shape, purpose and the machine type.

対応被削材 Applicable work material

炭素鋼 合金鋼 Carbon steel Alloy steel	プリハードン鋼 Pre-hardened steel	高硬度 Hardened steel			ステンレス鋼 Stainless steel	チタン合金 耐熱合金 Titanium alloy Heat-resistant alloy	銅合金 Copper alloy	アルミ合金 Aluminum alloy
○	○	> 45HRC ≤ 55HRC	> 55HRC ≤ 65HRC	> 65HRC	○	○	○	○

再研磨対応外径範囲 Re-grinding compatibility range

商品コード Item code	外周 Outer dia. (mm)	エンド End (mm)
EFB	× (N/A)	1 ~ 12

● : 標準在庫品です。 ● : Stocked items.

Epoch Super Hard Ball エポックスーパーハードボール

首下長 1.5DC タイプ Under neck length 1.5DC type

小径高硬度用ボールエンドミル。
Ball end mill for small-diameter high-hardness machining.



RE公差 RE tolerance +0.001~-0.005



2枚刃
2Flutes

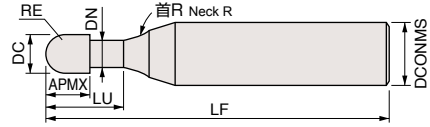

EPSB2-H-TH

高精度規格品 High-accuracy rating product

検査票付き Inspection certificate included



商品コード Item code	在庫 Stock	寸法 Size(mm)								干渉角度 (°) Incline angle θ_K	勾配角に対する実有効首下長(mm) The effective under-neck length for the various draft angles				希望小売 価格(円) Suggested retail price (¥)
		ボール半径 Ball radius RE	外径 Tool dia. DC	刃長 Flute length APMX	首径 Neck dia. DN	首下長 Under neck length LU	全長 Overall length LF	シャンク径 Shank dia. DCONMS	首R Neck R		0.5°	1°	2°	3°	
											0.5°	1°	2°	3°	
EPSB2001-H-TH	●	0.05	0.1	0.08	0.08	0.15	45	4	1	11.82	0.30	0.32	0.35	0.38	21,000
EPSB2002-H-TH	●	0.1	0.2	0.15	0.17	0.3	45	4	1	11.66	0.49	0.50	0.54	0.58	18,330
EPSB2003-H-TH	●	0.15	0.3	0.25	0.27	0.45	45	4	2	11.53	0.73	0.77	0.84	0.91	17,360
EPSB2004-H-TH	●	0.2	0.4	0.3	0.37	0.6	45	4	2	11.39	0.88	0.93	1.01	1.09	17,360
EPSB2005-H-TH	●	0.25	0.5	0.35	0.47	0.75	45	4	2	11.25	1.04	1.09	1.18	1.27	16,610
EPSB2006-H-TH	●	0.3	0.6	0.4	0.57	0.9	45	4	4	11.10	1.33	1.42	1.59	1.75	16,610
EPSB2008-H-TH	●	0.4	0.8	0.5	0.77	1.2	45	4	4	10.79	1.65	1.75	1.93	2.11	15,750
EPSB2010-H-TH	●	0.5	1	0.8	0.96	1.5	45	6	4	11.01	2.01	2.12	2.31	2.49	14,790
EPSB2012-H-TH	●	0.6	1.2	1.1	1.15	1.8	45	6	4	10.78	2.36	2.47	2.68	2.86	14,790
EPSB2015-H-TH	●	0.75	1.5	1.35	1.44	2.25	45	6	4	10.43	2.87	2.99	3.20	3.40	15,530
EPSB2020-H-TH	●	1	2	1.7	1.92	3	45	6	4	9.79	3.71	3.84	4.07	4.29	15,530

RE公差 RE tolerance +0.003~-0.007



EPSB2-N-TH

標準規格品 Standard rating product



商品コード Item code	在庫 Stock	寸法 Size(mm)								干渉角度 (°) Incline angle θ_K	勾配角に対する実有効首下長(mm) The effective under-neck length for the various draft angles				希望小売 価格(円) Suggested retail price (¥)
		ボール半径 Ball radius RE	外径 Tool dia. DC	刃長 Flute length APMX	首径 Neck dia. DN	首下長 Under neck length LU	全長 Overall length LF	シャンク径 Shank dia. DCONMS	首R Neck R		0.5°	1°	2°	3°	
											0.5°	1°	2°	3°	
EPSB2001-N-TH	●	0.05	0.1	0.08	0.08	0.15	45	4	1	11.82	0.30	0.32	0.35	0.38	18,110
EPSB2002-N-TH	●	0.1	0.2	0.15	0.17	0.3	45	4	1	11.66	0.49	0.50	0.54	0.58	15,650
EPSB2003-N-TH	●	0.15	0.3	0.25	0.27	0.45	45	4	2	11.53	0.73	0.77	0.84	0.91	14,790
EPSB2004-N-TH	●	0.2	0.4	0.3	0.37	0.6	45	4	2	11.39	0.88	0.93	1.01	1.09	14,790
EPSB2005-N-TH	●	0.25	0.5	0.35	0.47	0.75	45	4	2	11.25	1.04	1.09	1.18	1.27	14,040
EPSB2006-N-TH	●	0.3	0.6	0.4	0.57	0.9	45	4	4	11.10	1.33	1.42	1.59	1.75	14,040
EPSB2008-N-TH	●	0.4	0.8	0.5	0.77	1.2	45	4	4	10.79	1.65	1.75	1.93	2.11	13,290
EPSB2010-N-TH	●	0.5	1	0.8	0.96	1.5	45	6	4	11.01	2.01	2.12	2.31	2.49	12,440
EPSB2012-N-TH	●	0.6	1.2	1.1	1.15	1.8	45	6	4	10.78	2.36	2.47	2.68	2.86	12,440
EPSB2015-N-TH	●	0.75	1.5	1.35	1.44	2.25	45	6	4	10.43	2.87	2.99	3.20	3.40	13,080
EPSB2020-N-TH	●	1	2	1.7	1.92	3	45	6	4	9.79	3.71	3.84	4.07	4.29	13,080

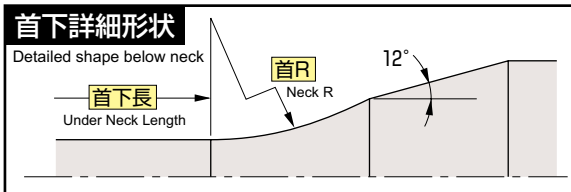

【注意】

加工物に勾配がついている場合、干渉領域は、首下長さよりも長くなります。それぞれの勾配角に対する実有効首下長をご参照ください。
また、工具が加工物に干渉する角度を干渉角度 θ_K で表示していますので合わせてご参照ください。

【Note】

If the workpiece has draft angle, the interference length will be longer than the under-neck length. Please refer to the effective under-neck length for the various draft angles.
In addition, the angle at which the tool will interfere with the workpiece is shown as the "interference angle θ_K ", and should also be referred to.

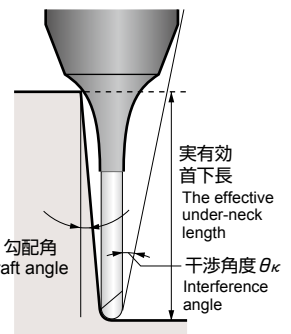

●：標準在庫品です。●：Stocked items.

首下長 3DC タイプ Under neck length 3DC type



RE公差 RE tolerance +0.003~-0.007



(mm)

2枚刃
2Flutes

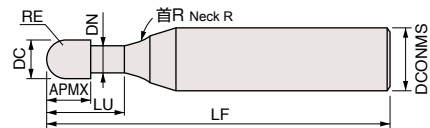

EPSB2○○○-○.○-N-TH

標準規格品 Standard rating product



商品コード Item code	在庫 Stock	寸法 Size(mm)								干渉角度 (°) Incline angle $\theta\kappa$	勾配角に対する実有効首下長(mm) The effective under-neck length for the various draft angles				希望小売 価格(円) Suggested retail price (¥)
		ボール半径 Ball radius RE	外径 Tool dia. DC	刃長 Flute length APMX	首径 Neck dia. DN	首下長 Under neck length LU	全長 Overall length LF	シャンク径 Shank dia. DCONMS	首R Neck R		0.5°	1°	2°	3°	
		EPSB2001-0.3-N-TH	●	0.05	0.1	0.08	0.08	0.3	45		4	1	11.64	0.46	
EPSB2002-0.6-N-TH	●	0.1	0.2	0.15	0.17	0.6	45	4	1	11.30	0.80	0.83	0.88	0.93	15,650
EPSB2003-0.9-N-TH	●	0.15	0.3	0.25	0.27	0.9	45	4	2	11.00	1.21	1.27	1.37	1.47	14,790
EPSB2004-1.2-N-TH	●	0.2	0.4	0.3	0.37	1.2	45	4	2	10.69	1.52	1.59	1.71	1.82	14,790
EPSB2005-1.5-N-TH	●	0.25	0.5	0.35	0.47	1.5	45	4	2	10.39	1.83	1.91	2.05	2.17	14,040
EPSB2006-1.8-N-TH	●	0.3	0.6	0.4	0.57	1.8	45	4	4	10.08	2.30	2.44	2.68	2.88	14,040
EPSB2008-2.4-N-TH	●	0.4	0.8	0.5	0.77	2.4	45	4	4	9.47	2.94	3.10	3.36	3.59	13,290
EPSB2010-3-N-TH	●	0.5	1	0.8	0.96	3	45	6	4	9.88	3.61	3.78	4.06	4.30	12,440
EPSB2012-3.6-N-TH	●	0.6	1.2	1.1	1.15	3.6	45	6	4	9.46	4.27	4.45	4.75	5.01	12,440
EPSB2015-4.5-N-TH	●	0.75	1.5	1.35	1.44	4.5	45	6	4	8.84	5.24	5.44	5.76	6.04	13,080
EPSB2020-6-N-TH	●	1	2	1.7	1.92	6	45	6	4	7.81	6.84	7.07	7.43	7.89	13,080

標準切削条件表 Recommended cutting conditions EPSB-H-TH EPSB-N-TH EPSB-N-TH

被削材 Work material	1		2		3		4			
	焼入れ鋼 Hardened steels (45~55HRC) SKD61,SKT4		焼入れ鋼 Hardened steels (55~65HRC) SKD11,SKH51		焼入れ鋼 Hardened steels (65~68HRC) SKH,溶製ハイス Welded HSS		焼入れ鋼 Hardened steels (68~72HRC) HAP,粉末ハイス Powdered HSS			
	切込み比率 Ratio to depth of cut		100%		90%		70%		60%	
商品コード Item code	切込み量 Depth of cut		回転数n min ⁻¹	送り速度vf mm/min	回転数n min ⁻¹	送り速度vf mm/min	回転数n min ⁻¹	送り速度vf mm/min	回転数n min ⁻¹	送り速度vf mm/min
	ap	ae								
EPSB2001-TH	0.003	0.009	50,000	1,200	50,000	1,050	50,000	900	50,000	750
EPSB2002-TH	0.008	0.024	50,000	1,800	50,000	1,575	50,000	1,350	50,000	1,125
EPSB2003-TH	0.012	0.036	50,000	1,800	50,000	1,575	50,000	1,350	50,000	1,125
EPSB2004-TH	0.016	0.048	50,000	2,400	50,000	2,100	50,000	1,800	50,000	1,500
EPSB2005-TH	0.02	0.06	50,000	2,400	50,000	2,100	50,000	1,800	45,800	1,374
EPSB2006-TH	0.03	0.09	48,000	2,880	44,800	2,352	41,600	1,872	38,200	1,433
EPSB2008-TH	0.04	0.12	36,000	2,160	33,600	1,764	31,200	1,404	25,800	968
EPSB2010-TH	0.05	0.15	30,000	2,160	28,000	1,764	26,000	1,404	21,600	972
EPSB2012-TH	0.06	0.18	24,750	1,782	23,100	1,455	21,450	1,158	18,000	810
EPSB2015-TH	0.07	0.21	19,875	1,590	18,550	1,299	17,225	1,034	14,400	720
EPSB2020-TH	0.08	0.24	15,000	1,560	14,000	1,274	13,000	1,014	10,800	702

※基本切り込みは被削材グループ1での目安を示しています。その他のグループの場合は、上表の切り込み比率を目安に調整してください。
The figures in basic cutting depth column indicate only a rule of thumb for work group 1. For the other groups, see the figures in cutting ratio column and adjust your tools accordingly.

- [注意]** ①被削材、加工形状に合わせて、適切なクーラントを使用してください。
②この標準切削条件表は切削条件の目安を示すものです。実際の加工では加工形状、目的、使用機械等により条件を調整してください。
③機械の回転数が足りない場合は、回転数と送り速度を同じ比率で下げてください。

- [Note]** ① Use the appropriate coolant for the work material and machining shape.
② These Recommended Cutting Conditions indicate only the rule of a thumb for the cutting conditions. In actual machining, the condition should be adjusted according to the machining shape, purpose and the machine type.
③ If the rpm of the machine is low, lower the feed rate also to put the rpm and feed rate in the same ratio.

対応被削材 Applicable work material

炭素鋼 合金鋼 Carbon steel Alloy steel	プリハー ド鋼 Pre-hardened steel ≤ 45HRC	高硬度 Hardened steel			ステン レス鋼 Stainless steel	チタン合金 耐熱合金 Titanium alloy Heat-resistant alloy	銅合金 Copper alloy	アルミ 合金 Aluminum alloy
	○	> 45HRC ≤ 55HRC	> 55HRC ≤ 65HRC	> 65HRC	○	◎	○	○

再研磨対応外径範囲 Re-grinding compatibility range

商品コード Item code	外周 Outer dia. (mm)	エンド End (mm)
EPSB-H/N-TH	× (N/A)	× (N/A)

Epoch Precision Miniature Ball End Mill エポック精密小径ボールエンドミル

小径精密加工用ボールエンドミル
Ball end mill for small-diameter high-precision machining

ショートネック

Short Neck

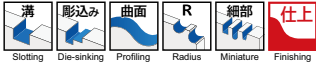

RE公差 ±0.007

シャープ公差 0~-0.005 (mm)

2枚刃
2Flutes



HPBS2-C

超硬 Carbide C ねじり角 30° Helix angle 切削条件表 A157 Cutting Conditions

商品コード Item code	在庫 Stock	寸法 Size (mm)						希望小売価格 (円) Suggested retail price(¥)
		ボール半径 Ball radius	外径 Tool dia.	刃長 Flute length	首径 Neck dia.	首下長 Under Neck length	全長 Overall length	
HPBS2010-C	●	0.5	1	1.3	首ぬすみ 無し Without neck escape	2	50	10,690
HPBS2020-C	●	1	2	2.5		3.5	50	11,250
HPBS2030-C	●	1.5	3	4		5	50	12,010
HPBS2040-C	●	2	4	5		6	50	12,010
HPBS2050-C	●	2.5	5	6		7	50	13,470
HPBS2060-C	●	3	6	7.5		-	50	14,260

レギュラーネック

Regular Neck

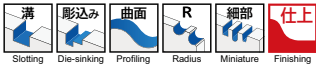

RE公差 ±0.007

シャープ公差 0~-0.005 (mm)

2枚刃
2Flutes



HYPB2-C

超硬 Carbide C ねじり角 30° Helix angle 切削条件表 A157 Cutting Conditions

商品コード Item code	在庫 Stock	寸法 Size (mm)						希望小売価格 (円) Suggested retail price(¥)
		ボール半径 Ball radius	外径 Tool dia.	刃長 Flute length	首径 Neck dia.	首下長 Under Neck length	全長 Overall length	
HYPB2002-C	●	0.1	0.2	0.3	首ぬすみ 無し Without neck escape	0.6	50	13,080
HYPB2003-C	●	0.15	0.3	0.4		0.7	50	12,440
HYPB2004-C	●	0.2	0.4	0.5		0.7	50	12,440
HYPB2005-C	●	0.25	0.5	0.6	0.45	1.6	50	11,790
HYPB2006-C	●	0.3	0.6	0.7	0.55	1.7	50	11,790
HYPB2008-C	●	0.4	0.8	1	0.75	2.5	50	11,040
HYPB2010-C	●	0.5	1	1.3	0.95	3.3	50	10,690
HYPB2012-C	●	0.6	1.2	1.5	1.15	3.5	50	10,690
HYPB2014-C	●	0.7	1.4	1.8	1.35	3.8	50	12,440
HYPB2015-C	●	0.75	1.5	1.9	1.45	4.9	50	11,250
HYPB2016-C	●	0.8	1.6	2	1.55	5	50	12,440
HYPB2018-C	●	0.9	1.8	2.3	1.75	5.3	50	12,440
HYPB2020-C	●	1	2	2.5	1.95	5.5	50	11,250
HYPB2025-C	●	1.25	2.5	3	2.4	6	50	12,010
HYPB2030-C	●	1.5	3	4	2.9	8	50	12,010
HYPB2035-C	●	1.75	3.5	4.5	3.4	8.5	50	13,290
HYPB2040-C	●	2	4	5	3.9	10	50	12,010
HYPB2050-C	●	2.5	5	6	4.9	11	50	13,470
HYPB2060-C	●	3	6	7.5	5.9	12.5	50	14,260

HPBS-C、HYPB-C、HPSLN-C の対応被削材

Applicable work material of HPBS-C, HYPB-C, HPSLN-C

炭素鋼 合金鋼 Carbon steel Alloy steel	プリハー ド鋼 Pre-hardened steel	高硬度 Hardened steel			ステン レス鋼 Stainless steel	チタン合金 耐熱合金 Titanium alloy Heat-resistant alloy	銅合金 Copper alloy	アルミ 合金 Aluminum alloy
		> 45HRC ≤ 45HRC	> 55HRC ≤ 55HRC	> 65HRC				
○	○	○	○	○	○	○	○	

再研磨対応外径範囲

Re-grinding compatibility range

商品コード Item code	外周 Outer dia. (mm)	エンド End (mm)
HPBS-C	× (N/A)	1 ~ 6
HYPB-C	× (N/A)	1 ~ 6
HPBLN-C	× (N/A)	1 ~ 6

○：標準在庫品です。●：Stocked items.

ロングネック Long Neck

溝 Sloting 彫込み Die-sinking 曲面 Profiling R Radius 細部 Miniature 仕上 Finishing

RE公差 ±0.007 形状公差 0~-0.005 (mm)

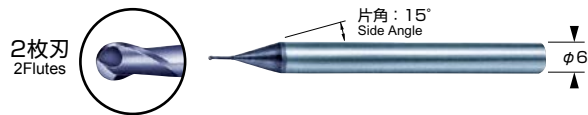

HPBLN2-C



商品コード Item code	在庫 Stock	寸法 Size (mm)						希望小売価格 (円) Suggested retail price(¥)
		ボール半径 Ball radius	外径 Tool dia.	刃長 Flute length	首径 Neck dia.	首下長 Under Neck length	全長 Overall length	
HPBLN2005-C	●	0.25	0.5	0.6	0.45	2.5	60	13,610
HPBLN2006-C	●	0.3	0.6	0.7	0.55	3	60	13,610
HPBLN2008-C	●	0.4	0.8	1	0.75	4	60	13,610
HPBLN2010-C	●	0.5	1	1.3	0.95	5	60	12,440
HPBLN2012-C	●	0.6	1.2	1.5	1.15	6	60	12,440
HPBLN2014-C	●	0.7	1.4	1.8	1.35	7	60	14,460
HPBLN2015-C	●	0.75	1.5	1.9	1.45	7.5	60	12,970
HPBLN2016-C	●	0.8	1.6	2	1.55	8	60	14,460
HPBLN2018-C	●	0.9	1.8	2.3	1.75	9	60	14,460
HPBLN2020-C	●	1	2	2.5	1.95	10	60	12,970
HPBLN2025-C	●	1.25	2.5	3	2.4	12.5	60	13,820
HPBLN2030-C	●	1.5	3	4	2.9	15	80	13,820
HPBLN2035-C	●	1.75	3.5	4.5	3.4	17.5	80	15,320
HPBLN2040-C	●	2	4	5	3.9	20	80	13,820
HPBLN2050-C	●	2.5	5	6	4.9	25	80	15,600
HPBLN2060-C	●	3	6	7.5	5.9	30	80	16,500

●印: 標準在庫品です。 ●: Stocked items.

標準切削条件表 Recommended cutting conditions

HPBS-C	HYPB-C	HPBLN-C
ショートネック・ボール Short Neck, Ball	レギュラーネック・ボール Regular Neck, Ball	ロングネック・ボール Long Neck, Ball

ボール半径RE×外径DC Ball radius RE × Tool dia. DC	回転数 (n) Revolution min ⁻¹	送り速度(v _f) mm/min Table speed Vf	被削材 (50HRC以下) Work material (Under 50HRC)
		ボール刃 (HYPB) Ball end (HYPB)	炭素鋼、合金鋼、工具鋼、プリハードン鋼 Carbon steels, Alloy steels, Tool steels, Pre-hardened steels S50C, SCM, SKD, HPM1, NAK55
(RE0.1×)0.2	20,000~50,000	100~1,500	切込み Depth of cut $a_p = (0.05 \sim 0.1) \times DC$
(RE0.2×)0.4			
(RE0.3×)0.6			
(RE0.5×)1.0	10,000~30,000	1,500~2,500	
(RE1.0×)2.0			
(RE1.5×)3.0			
(RE2.0×)4.0	5,000~15,000	2,000~3,000	
(RE3.0×)6.0			

使用方法と注意点

- 被削材、加工形状に合わせて、適切なクーラントを使用してください。
- この標準切削条件表は切削条件の目安を示すものです。実際の加工では加工形状、目的、使用機械等により条件を調整してください。
- 自動切込みが可能な、剛性のあるNC機の利用を推奨します。切込み回数が多いので手動機は適しません。
- 回転数が不足する場合は適当な増速装置を準備してください。増速装置は長時間耐える機種を推奨します。
- 能率を問わない場合(例、夜間無人加工など)は、2000 min⁻¹程度の低速でも使用できます。
- 工具径が小さいため、振れはできるだけ小さく押さえてください。
- ロングネックタイプをご使用の場合は、切込み量を少なくするか、送り速度を上表の低い数値でご使用ください。

Notes on Applications

- Use the appropriate coolant for the work material and machining shape.
- These Recommended Cutting Conditions indicate only the rule of a thumb for the cutting conditions. In actual machining, the condition should be adjusted according to the machining shape, purpose and the machine type.
- Rigid N/C with automatic depth feeder is recommended. Manual machines are not recommended for multi-feed applications.
- High-revolution spindle attachments are recommended.
- Lower revolutions of about 2,000 r/min are applicable, in case of operation in night without an operator, with efficiency not required.
- Set-up runout of end mills as small as possible, because of miniature end mills.

Epoch Pencil Neck Ball

エポックペンシルネックボール

ペンシルレギュラーネック

Pencil Regular Neck

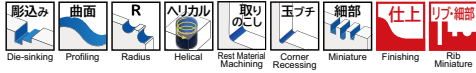

±0.01



(mm)

2枚刃
2Flutes

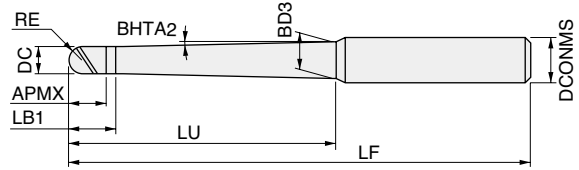

EPBPN2-○○○○-○○○



商品コード Item code	在庫 Stock	寸法 Size (mm)									希望小売価格 (円) Suggested retail price(¥)
		ボール半径 Ball radius RE	外径 Tool dia. DC	部首角度 Neck angle BHTA2	刃長 Flute length APMX	全長 Overall length LF	シャンク径 Shank dia. DCONMS	首下長 Under neck length LU	首下平行長 Under neck parallel length LB1	首元径 Neck dia. BD3	
EPBPN2010-15	●	0.5	1	1° 30'	2.5	60	6	20	4	1.8	15,430
EPBPN2010-30	●			3°	2.5	80	6	40	4	4.8	14,460
EPBPN2010-50	●			5°	2.5	60	6	20	4	3.8	13,610
EPBPN2020-15	●	1.0	2	1° 30'	5	60	6	20	7	2.7	15,430
EPBPN2020-30	●			3°	5	80	6	40	7	5.5	14,460
EPBPN2020-50	●			5°	5	60	6	20	7	4.3	13,610
EPBPN2030-15	●	1.5	3	1° 30'	8	90	6	50	10	5.1	15,000
EPBPN2030-30	●			3°	8	70	6	30	10	5.1	14,040
EPBPN2040-15	●			1° 30'	8	90	6	48.2	10	6	15,000
EPBPN2040-30	●	2	4	3°	8	70	6	29.1	10	6	14,040
EPBPN2050-15	●			1° 30'	10	110	8	60	12	7.5	19,870
EPBPN2050-30	●			3°	10	90	8	40.6	12	8	18,750
EPBPN2060-15	●	2.5	5	1° 30'	12	110	8	52.2	14	8	20,880
EPBPN2060-30	●			3°	12	90	8	33.1	14	8	19,640
EPBPN2070-15	●			3.5	7	1° 30'	14	120	10	60	16
EPBPN2070-30	●	3°	14			100	10	40	16	9.5	24,360
EPBPN2080-15	●	4	8			1° 30'	14	120	10	54.2	16
EPBPN2080-30	●			3°	14	100	10	35.1	16	10	25,590
EPBPN2100-15	●			5	10	1° 30'	18	130	12	58.2	20
EPBPN2100-30	●	3°	18			110	12	39.1	20	12	31,420
EPBPN2120-15	●	6	12			1° 30'	22	160	16	80	25
EPBPN2120-30	●			3°	22	140	16	63.2	25	16	47,130

対応被削材 Applicable work material

炭素鋼 合金鋼 Carbon steel Alloy steel	プリハー ド鋼 Pre-hardened steel	高硬度 Hardened steel			ステン レス鋼 Stainless steel	チタン合金 耐熱合金 Titanium alloy Heat-resistant alloy	銅合金 Copper alloy	アルミ 合金 Aluminum alloy
○	○	> 45HRC ≤ 45HRC	> 55HRC ≤ 65HRC	> 65HRC	○	○	○	○

再研磨対応外径範囲 Re-grinding compatibility range

商品コード Item code	外周 Outer dia. (mm)	エンド End (mm)
EPBPN	× (N/A)	1 ~ 12

【注意】首下長/外径が10DCを超える工具の再研磨可否については、弊社営業にお問い合わせください。
【Note】 Contact our sales office regarding whether or not regrinding is possible for tools where under neck length/tool diameter more than 10DC

●：標準在庫品です。●：Stocked items.

標準切削条件表 Recommended cutting conditions

EPBPN

<側面切削> Side milling

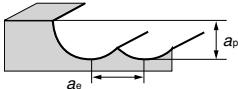
	RE : ボール半径	<table border="1"> <thead> <tr> <th></th> <th>a_p: Z切込み</th> <th>a_e</th> </tr> </thead> <tbody> <tr> <td>$RE \leq 1.0$</td> <td>$0.05 \times RE$以下</td> <td>$0.2 \times RE$以下</td> </tr> <tr> <td>$1.0 < RE$</td> <td>$0.1 \times RE$以下</td> <td>$0.2 \times RE$以下</td> </tr> </tbody> </table>		a_p : Z切込み	a_e	$RE \leq 1.0$	$0.05 \times RE$ 以下	$0.2 \times RE$ 以下	$1.0 < RE$	$0.1 \times RE$ 以下	$0.2 \times RE$ 以下	<table border="1"> <thead> <tr> <th colspan="2">工具の付出し長さとお径の比率 (L/D) Ratio between tool projection length and flute diameter</th> </tr> </thead> <tbody> <tr> <td>$L/D \leq 5$の時: 高い方の数値</td> <td></td> </tr> <tr> <td>$5 < L/D < 10$の時: 中間の数値</td> <td></td> </tr> <tr> <td>$L/D = 10$の時: 低い方の数値</td> <td></td> </tr> <tr> <td>$10 < L/D$の時: さらに30%下げる</td> <td></td> </tr> </tbody> </table>	工具の付出し長さとお径の比率 (L/D) Ratio between tool projection length and flute diameter		$L/D \leq 5$ の時: 高い方の数値		$5 < L/D < 10$ の時: 中間の数値		$L/D = 10$ の時: 低い方の数値		$10 < L/D$ の時: さらに30%下げる	
			a_p : Z切込み	a_e																		
	$RE \leq 1.0$		$0.05 \times RE$ 以下	$0.2 \times RE$ 以下																		
$1.0 < RE$	$0.1 \times RE$ 以下	$0.2 \times RE$ 以下																				
工具の付出し長さとお径の比率 (L/D) Ratio between tool projection length and flute diameter																						
$L/D \leq 5$ の時: 高い方の数値																						
$5 < L/D < 10$ の時: 中間の数値																						
$L/D = 10$ の時: 低い方の数値																						
$10 < L/D$ の時: さらに30%下げる																						
DC : 外径																						
L : コレットからの突き出し長さ Length of projection from collet																						

被削材 Work material	鋳鉄 Cast irons FC200, FCD		炭素鋼 Carbon steels (180~250HB) SS400, S55C		合金鋼 Alloy steels (25~35HRC) SCM, SNCM		工具鋼 Tool steels (25~35HRC) SKT, SKD61, ARK1		プリハードン鋼 Pre-hardened steels (35~45HRC) CENA1, NAK80		焼入れ鋼 Hardened steels (45~55HRC) SKT, SKD61	
	ボール半径RE ×外径DC Tool dia. (mm)	回転数 n (min^{-1})	送り速度 v_f (mm/min)	回転数 n (min^{-1})	送り速度 v_f (mm/min)	回転数 n (min^{-1})	送り速度 v_f (mm/min)	回転数 n (min^{-1})	送り速度 v_f (mm/min)	回転数 n (min^{-1})	送り速度 v_f (mm/min)	回転数 n (min^{-1})
RE1×2	11,100~15,000	1,550~2,100	11,100~13,000	1,550~1,820	8,000~11,100	1,100~1,500	8,000~11,100	1,100~1,500	6,400~11,100	900~1,500	4,800~8,000	380~640
RE2×4	5,600~7,600	1,230~1,670	5,600~7,200	1,230~1,600	4,000~7,200	880~1,600	4,000~7,200	880~1,600	3,200~7,200	700~1,600	2,400~4,700	480~940
RE3×6	3,700~5,800	925~1,450	3,700~5,800	890~1,400	2,600~5,800	620~1,400	2,600~5,800	620~1,400	2,100~5,800	500~1,400	1,600~5,800	300~1,300
RE4×8	2,800~4,800	950~1,600	2,800~4,800	840~1,440	2,000~4,800	680~1,440	2,000~4,800	680~1,440	1,600~4,800	480~1,440	1,200~4,800	340~1,350
RE5×10	2,230~4,800	890~1,920	2,230~4,800	800~1,730	1,600~4,800	580~1,730	1,600~4,800	580~1,730	1,600~4,800	480~1,440	950~4,800	290~1,450
RE6×12	1,900~4,000	950~2,000	1,900~4,000	800~1,680	1,330~4,000	560~1,680	1,330~4,000	560~1,680	1,060~4,000	450~1,680	800~4,000	260~1,300

【注意】

- ① 切削方法は、ダウンカットで使用ください。
- ② 一般材、とくに高速切削は、乾式（エアブロー）またはオイルミストクーラントにてご使用ください。
- ③ 安定した切削を行うため、剛性の高い機械とセットアップでご使用ください。
- ④ 機械の回転数が足りない場合は、主軸回転数とテーブル送り速度を同比率で下げてください。
- ⑤ 被削材、加工形状に合わせて、適切なクーラントを使用してください。
- ⑥ 加工形状、機械の剛性、工具突き出し量等、ご使用の状況により、主軸回転数とテーブル送り速度の調整を行ってください。

【Note】

- ① Down-cutting is recommended.
- ② Use generally dry (air-blow) or oil-mist coolant, especially at the high-speed machining.
- ③ Use a machine tool with rigidity and rigid set-up, to machine stably.
- ④ When the revolution speed is not enough, reduce the revolution speed and table speed at the same ratio.
- ⑤ Use the appropriate coolant for the work material and machining shape.
- ⑥ Adjust the revolution speed and table speed, according to cutting conditions such as machining shape, rigidity of machine tool, over-hang and so on.

Epoch Pencil Long Neck Ball

エポックペンシルロングネックボール

ペンシルロングネック

Pencil Long Neck



±0.02



(mm)

2枚刃
2 Flutes

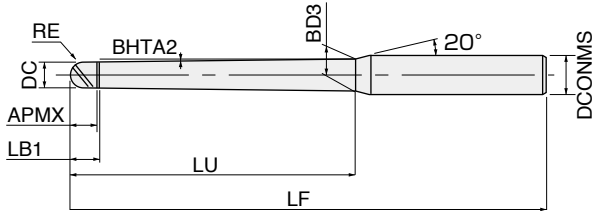

Aタイプ A type

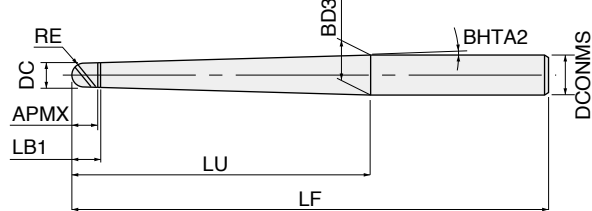

Bタイプ B type

EPBPX2-○○○-○○○



商品コード Item code	在庫 Stock	寸法 Size (mm)									形状 Shape	希望小売 価格(円) Suggested retail price (¥)
		ボール 半径 Ball radius	外径 Tool dia.	首部角度 Neck angle	刃長 Flute length	首平行長 Under neck parallel length	首下長 Under neck length	首元径 Neck dia.	全長 Overall length	シャンク径 Shank dia.		
		RE	DC	BHTA2	APMX	LB1	LU	BD3	LF	DCONMS		
EPBPX2010-05	●	0.5	1	30°	1.5	2	70	2.19	150	6	A	33,640
EPBPX2010-10	●			1°	1.5	2	70	3.37	150	6	A	33,640
EPBPX2010-15	●			1°30'	1.5	2	97.47	6	150	6	B	38,350
EPBPX2020-05	●	1	2	30°	2.5	3.5	80	3.34	150	6	A	35,240
EPBPX2020-10	●			1°	2.5	3.5	80	4.67	150	6	A	35,240
EPBPX2020-15	●			1°30'	2.5	3.5	79.88	6	150	6	B	35,240
EPBPX2030-05	●	1.5	3	30°	3.5	4.5	87	4.44	150	6	A	36,740
EPBPX2030-10	●			1°	3.5	4.5	90.43	6	150	6	B	36,740
EPBPX2030-15	●			1°30'	3.5	4.5	99.97	8	150	8	B	41,130
EPBPX2040-05	●	2	4	30°	4.5	5.5	100	5.65	180	8	A	42,100
EPBPX2040-10	●			1°	4.5	5.5	120.08	8	180	8	B	42,100
EPBPX2040-15	●			1°30'	4.5	5.5	81.88	8	180	8	B	42,100
EPBPX2050-05	●	2.5	5	30°	5.5	6.5	110	6.81	180	8	A	45,120
EPBPX2050-10	●			1°	5.5	6.5	92.43	8	180	8	B	45,120
EPBPX2050-15	●			1°30'	5.5	6.5	101.97	10	180	10	B	45,120
EPBPX2060-05	●	3	6	30°	6.5	7.5	122.09	8	200	8	B	42,080
EPBPX2060-10	●			1°	6.5	7.5	122.08	10	200	10	B	43,760
EPBPX2060-15	●			1°30'	6.5	7.5	122.07	12	200	12	B	43,760
EPBPX2080-05	●	4	8	30°	8.5	9.5	124.09	10	200	10	B	43,760
EPBPX2080-10	●			1°	8.5	9.5	124.08	12	200	12	B	47,130
EPBPX2080-15	●			1°30'	8.5	9.5	124.07	14	200	14	B	51,180
EPBPX2100-05	●	5	10	30°	10.5	11.5	126.09	12	200	12	B	51,180
EPBPX2100-10	●			1°	10.5	11.5	126.08	14	200	14	B	54,310
EPBPX2100-15	●			1°30'	10.5	11.5	126.07	16	200	16	B	58,240
EPBPX2120-05	●	6	12	30°	12.5	13.5	128.09	14	200	14	B	57,570
EPBPX2120-10	●			1°	12.5	13.5	128.08	16	200	16	B	61,380
EPBPX2120-15	●			1°30'	12.5	13.5	128.07	18	200	18	B	66,990

○ 対応被削材 Applicable work material

炭素鋼 合金鋼 Carbon steel Alloy steel	プリハー ド鋼 Pre-hardened steel	高硬度 Hardened steel			ステン レス鋼 Stainless steel	チタン合金 耐熱合金 Titanium alloy Heat-resistant alloy	銅合金 Copper alloy	アルミ 合金 Aluminum alloy
○	○	> 45HRC ≤ 55HRC	> 55HRC ≤ 65HRC	> 65HRC	○	○	○	○

○ 再研磨対応外径範囲 Re-grinding compatibility range

商品コード Item code	外周 Outer dia. (mm)	エンド End (mm)
EPBPX	× (N/A)	2 ~ 12

[注意] 首下長/外径が10DCを超える工具の再研磨可否については、弊社営業にお問い合わせください。
[Note] Contact our sales office regarding whether or not regrinding is possible for tools where under neck length/tool diameter more than 10DC.

● : 標準在庫品です。 ● : Stocked items.

標準切削条件表 Recommended cutting conditions

EPBPX

<側面切削> Side milling

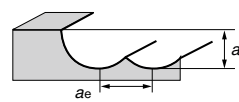

RE: ボール半径
DC: 外径
L: コレットからの突き出し長さ
Length of projection from collet

	ap: Z切込み	ae
RE ≤ 1.0	0.05 × RE 以下	0.2 × RE 以下
1.0 < RE	0.1 × RE 以下	0.2 × RE 以下

工具の付出し長さとの比率 (L/D)
Ratio between tool projection length and flute diameter

L/D ≤ 20 の時: 高い方の数値
20 < L/D < 50 の時: 中間の数値
50 < L/D の時: 低い方の数値

被削材 Work material	鋳鉄 Cast Irons FC200, FCD		炭素鋼 Carbon steels (180~250HB) SS400, S55C		合金鋼 Alloy steels (25~35HRC) SCM, SNCM		工具鋼 Tool steels (25~35HRC) SKT, SKD61, ARK1		プリハードン鋼 Pre-hardened steels (35~45HRC) CENA1, NAK80		焼入れ鋼 Hardened steels (45~55HRC) SKT, SKD61	
	ボール半径RE × 外径DC Tool dia. (mm)	回転数 n (min ⁻¹)	送り速度 Vf (mm/min)	回転数 n (min ⁻¹)	送り速度 Vf (mm/min)	回転数 n (min ⁻¹)	送り速度 Vf (mm/min)	回転数 n (min ⁻¹)	送り速度 Vf (mm/min)	回転数 n (min ⁻¹)	送り速度 Vf (mm/min)	回転数 n (min ⁻¹)
RE0.5×1	12,700~14,500	1,000~1,300	11,000~12,700	880~1,000	9,500~11,000	760~880	8,000~9,500	640~760	6,400~8,000	380~480	4,500~6,400	180~250
RE1×2	6,400~7,200	720~860	5,600~6,400	560~640	4,800~5,600	480~560	4,000~4,800	360~430	3,200~4,000	220~280	2,400~3,200	100~130
RE2×4	3,200~3,600	510~580	2,800~3,200	390~450	2,400~2,800	290~340	2,000~2,400	200~240	1,600~2,000	130~160	1,200~1,600	70~100
RE3×6	2,100~2,400	420~480	1,900~2,100	340~380	1,600~1,900	260~300	1,300~1,600	180~225	1,050~1,300	125~160	800~1,050	80~100
RE4×8	1,600~1,800	350~400	1,400~1,600	280~320	1,200~1,400	220~250	1,000~1,200	160~190	800~1,000	110~140	600~800	85~110
RE5×10	1,300~1,450	340~380	1,100~1,300	265~310	960~1,100	210~240	800~960	130~200	640~800	115~145	480~640	80~100
RE6×12	1,060~1,200	320~360	930~1,060	260~300	800~930	210~230	660~800	160~200	530~660	120~150	400~530	80~100

- [注意]**
- ① 切削方法は、ダウンカットで使用ください。
 - ② 被削材、加工形状に合わせて、適切なクーラントを使用してください。
 - ③ 一般材、とくに高速切削は、乾式（エアブロー）またはオイルミストクーラントにてご使用ください。
 - ④ 安定した切削を行うため、剛性の高い機械とセットアップでご使用ください。
 - ⑤ 機械の回転数が足りない場合は、主軸回転数とテーブル送り速度を同比率で下げてください。
 - ⑥ 加工形状、機械の剛性、工具突き出し量等、ご使用の状況により、主軸回転数とテーブル送り速度の調整を行ってください。

- [Note]**
- ① Down-cutting is recommended.
 - ② Use the appropriate coolant for the work material and machining shape.
 - ③ Use generally dry (air-blow) or oil-mist coolant, especially at the high-speed machining.
 - ④ Use a machine tool with rigidity and rigid set-up, to machine stably.
 - ⑤ When the revolution speed is not enough, reduce the revolution speed and table speed at the same ratio.
 - ⑥ Adjust the revolution speed and table speed, according to cutting conditions such as machining shape, rigidity of machine tool, over-hang and so on.

超硬ボールエンドミル

強力形・ショート刃長 Powerful type, Short

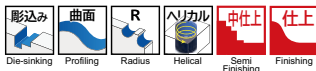

2枚刃
2 Flutes



RE公差
RE tolerance ±0.01

h6

(mm)

超硬 Helix 30°
Carbide Helix angle

BEK2

商品コード Item code	在庫 Stock	寸法 Size (mm)					希望小売 価格(円) Suggested retail price(¥)
		ボール半径 Ball radius	外径 Tool dia.	刃長 Flute length	全長 Overall length	シャンク径 Shank dia.	
BEK2003	●	0.15	0.3	0.6	50	3	11,250
BEK2004	●	0.2	0.4	0.8	50	3	11,250
BEK2005	●	0.25	0.5	1	50	3	10,690
BEK2006	●	0.3	0.6	1.2	50	3	10,690
BEK2008	●	0.4	0.8	1.6	50	3	9,980
BEK2010	●	0.5	1	2.5	50	4	9,180
BEK2015	●	0.75	1.5	4	50	4	9,740
BEK2020	●	1	2	5	50	6	9,740
BEK2025	●	1.25	2.5	7	50	6	10,450
BEK2030	●	1.5	3	8	70	6	10,450
BEK2040	●	2	4	8	70	6	10,450
BEK2050	●	2.5	5	10	80	6	11,790

商品コード Item code	在庫 Stock	寸法 Size (mm)					希望小売 価格(円) Suggested retail price(¥)
		ボール半径 Ball radius	外径 Tool dia.	刃長 Flute length	全長 Overall length	シャンク径 Shank dia.	
BEK2060	●	3	6	12	90	6	12,690
BEK2070	●	3.5	7	14	90	6	14,820
BEK2080	●	4	8	14	100	8	16,830
BEK2090	●	4.5	9	18	100	8	21,770
BEK2100	●	5	10	18	100	10	21,880
BEK2110	●	5.5	11	18	110	10	26,930
BEK2120	●	6	12	22	110	12	28,510
BEK2130	●	6.5	13	22	110	12	41,770
BEK2140	●	7	14	26	120	12	51,030
BEK2160	●	8	16	30	140	16	66,870
BEK2180	●	9	18	34	140	16	83,640
BEK2200	●	10	20	38	160	20	104,530

対応被削材 Applicable work material

炭素鋼 合金鋼 Carbon steel Alloy steel	プリハー ドン鋼 Pre-hardened steel ≤ 45HRC	高硬度 Hardened steel			ステン レス鋼 Stainless steel	チタン合金 耐熱合金 Titanium alloy Heat-resistant alloy	銅合金 Copper alloy	アルミ 合金 Aluminum alloy
○	○	> 45HRC ≤ 55HRC	> 55HRC ≤ 65HRC	> 65HRC	○	○	◎	◎

再研磨対応外径範囲 Re-grinding compatibility range

商品コード Item code	外周 Outer dia. (mm)	エンド End (mm)
BEK	× (N/A)	1 ~ 20

エポックペンシルディープボール

ペンシルネック

Pencil Regular Neck



THコーティング採用で高硬度材に適しています。高い耐折損性。
TH Coating makes it ideal for high-hardness materials. High breakage resistance.



RE公差
RE tolerance
RE ≤ 0.25 : ±0.003
0.25 < RE : ±0.005



(mm)

2枚刃
2Flutes



【注意】 RE 2mm以上はバックドラフト形状ではありません。
【Note】 RE 2mm or higher does not have backdraft shape.

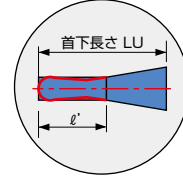
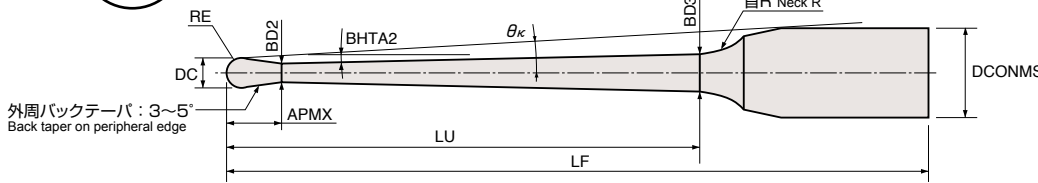

EPDBP2-TH



商品コード Item code	在庫 Stock	寸法 Size(mm)											干渉角度 Interference angle (°)	勾配角に対する実有効首下長 The effective under-neck length for the various draft angles.					希望小売 価格(円) Suggested retail price (¥)
		ボール半径 Ball radius	外径 Tool dia.	首下長 Under neck length	首部 テーパー(半角) Neck angle	刃長 Flute length	首径 Neck dia.	首元径 Under neck dia.	全長 Overall length	シャンク径 Shank dia.	首R Neck R	仮想首長 Approx neck length		0.5°	1°	1.5°	2°	3°	
		RE	DC	LU	BHTA2	APMX	BD2	BD3	LF	DCONMS	φ'	θκ							
EPDBP2002-1-04-TH	△	0.1	0.2	1	0.4	0.15	0.17	0.182	50	4	7	1.35	10.89	1.55	1.72	1.88	2.03	2.31	16,290
EPDBP2002-1.5-04-TH	△			1.5	0.4	0.15	0.17	0.189	50	4	7	1.77	10.39	2.06	2.28	2.47	2.64	2.97	17,570
EPDBP2002-2-09-TH	△			2	0.9	0.15	0.17	0.228	50	4	10	1.1	10.01	-	2.81	3.14	3.42	3.92	18,860
EPDBP2002-2.5-09-TH	△			2.5	0.9	0.15	0.17	0.244	50	4	10	1.1	9.6	-	3.32	3.7	4.01	4.54	20,140
EPDBP2003-2-04-TH	△	0.15	0.3	2	0.4	0.25	0.27	0.294	50	4	7	2.19	9.94	2.57	2.83	3.03	3.23	3.59	17,570
EPDBP2003-3-09-TH	△			3	0.9	0.25	0.27	0.356	50	4	10	1.2	9.21	-	3.85	4.25	4.58	5.15	18,210
EPDBP2003-4-09-TH	△			4	0.9	0.25	0.27	0.388	50	4	10	1.2	8.53	-	4.87	5.35	5.73	6.35	18,970
EPDBP2004-2-04-TH	△	0.2	0.4	2	0.4	0.3	0.37	0.394	50	4	7	2.2	9.93	2.57	2.82	3.03	3.23	3.57	11,680
EPDBP2004-3-04-TH	△			3	0.4	0.3	0.37	0.408	50	4	7	2.44	9.1	3.6	3.92	4.18	4.4	4.8	13,080
EPDBP2004-4-04-TH	△			4	0.4	0.3	0.37	0.422	50	4	10	2.44	8.39	4.76	5.24	5.61	5.93	6.51	13,720
EPDBP2004-4-09-TH	△			4	0.9	0.3	0.37	0.486	50	4	10	1.25	8.49	-	4.87	5.35	5.72	6.34	13,720
EPDBP2004-5-04-TH	△			5	0.4	0.3	0.37	0.436	50	4	10	2.44	7.78	5.78	6.33	6.74	7.1	7.71	14,360
EPDBP2004-5-09-TH	△			5	0.9	0.3	0.37	0.518	50	4	10	1.25	7.89	-	5.9	6.44	6.85	7.53	14,360
EPDBP2005-4-04-TH	△	0.25	0.5	4	0.4	0.35	0.47	0.521	50	4	7	2.49	8.35	4.62	5.00	5.3	5.55	5.99	11,040
EPDBP2005-8-09-TH	△			8	0.9	0.35	0.47	0.710	50	4	10	1.3	6.45	-	8.96	9.67	10.18	10.99	11,680
EPDBP2005-12-09-TH	△			12	0.9	0.35	0.47	0.836	50	4	10	1.3	5.21	-	13.05	13.94	14.55	15.49	13,290
EPDBP20054-2-04-TH	△	0.27	0.54	2	0.4	0.37	0.52	0.543	50	4	4	1.8	9.95	2.36	2.55	2.7	2.83	3.06	11,790
EPDBP20054-4-04-TH	△			4	0.4	0.37	0.52	0.571	50	4	7	1.8	8.35	4.55	4.96	5.26	5.52	5.97	11,790
EPDBP20054-5-04-TH	△			5	0.4	0.37	0.52	0.585	50	4	7	1.8	7.72	5.57	6.04	6.38	6.66	7.15	11,790
EPDBP20054-6-04-TH	△			6	0.4	0.37	0.52	0.599	50	4	10	1.8	7.19	6.73	7.37	7.82	8.21	8.87	12,970
EPDBP20054-6.5-04-TH	△			6.5	0.4	0.37	0.52	0.606	50	4	10	1.8	6.94	7.24	7.91	8.38	8.78	9.46	12,970
EPDBP20054-7-04-TH	△			7	0.4	0.37	0.52	0.613	50	4	10	1.8	6.72	7.76	8.45	8.94	9.35	10.05	12,970
EPDBP2006-2-04-TH	△	0.3	0.6	2	0.4	0.4	0.57	0.592	50	4	4	2.17	9.93	2.42	2.59	2.73	2.85	3.08	8,470
EPDBP2006-4-04-TH	△			4	0.4	0.4	0.57	0.620	50	4	7	2.54	8.31	4.62	5	5.29	5.54	5.98	9,140
EPDBP2006-6-04-TH	△			6	0.4	0.4	0.57	0.648	50	4	10	2.54	7.14	6.8	7.41	7.85	8.23	8.88	9,140
EPDBP2006-6-09-TH	△			6	0.9	0.4	0.57	0.746	50	4	10	1.35	7.26	-	6.92	7.52	7.96	8.68	9,140
EPDBP2006-8-09-TH	△			8	0.9	0.4	0.57	0.809	50	4	10	1.35	6.38	-	8.96	9.67	10.18	10.98	13,080
EPDBP2006-10-04-TH	△			10	0.4	0.4	0.57	0.704	50	4	10	2.54	5.57	10.89	11.70	12.27	12.73	13.52	13,610
EPDBP2006-10-09-TH	△			10	0.9	0.4	0.57	0.872	50	4	10	1.35	5.70	-	11.01	11.81	12.37	13.25	13,610
EPDBP2006-12-09-TH	△			12	0.9	0.4	0.57	0.934	55	4	10	1.35	5.14	-	13.05	13.94	14.54	15.49	14,250
EPDBP2006-15-04-TH	△			15	0.4	0.4	0.57	0.774	55	4	10	2.54	4.37	15.99	17.01	17.69	18.24	19.27	14,890
EPDBP2006-15-09-TH	△			15	0.9	0.4	0.57	1.029	55	4	10	1.35	4.49	-	16.1	17.11	17.78	18.81	14,890
EPDBP2008-4-04-TH	△	0.4	0.8	4	0.4	0.5	0.77	0.819	50	4	7	2.64	8.22	4.61	4.99	5.28	5.53	5.97	9,140
EPDBP2008-6-04-TH	△			6	0.4	0.5	0.77	0.847	50	4	7	2.64	7.01	6.66	7.14	7.5	7.79	8.3	9,140
EPDBP2008-8-09-TH	△			8	0.9	0.5	0.77	1.006	50	4	10	1.45	6.24	-	8.96	9.66	10.17	10.97	9,140
EPDBP2008-12-09-TH	△			12	0.9	0.5	0.77	1.131	55	4	10	1.45	4.99	-	13.04	13.93	14.54	15.48	13,080
EPDBP2008-16-09-TH	△			16	0.9	0.5	0.77	1.257	55	4	10	1.45	4.15	-	17.12	18.16	18.85	19.9	13,720

△印：在庫が無くなり次第受注生産品となるものです。△：When the Stock is out, will become to produce on request. 干渉なし：No interference

超硬エポックペンシル

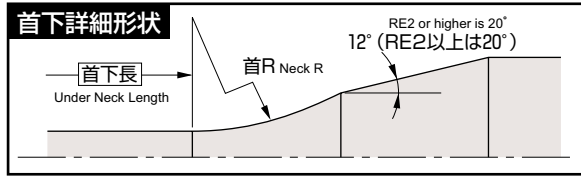

【注意】
加工物に勾配がついている場合、干渉領域は、首下長さよりも長くなります。それぞれの勾配角に対する実有効首下長をご参照ください。
また、工具が加工物に干渉する角度を干渉角度 θ_k で表示していますので合わせてご参照ください。

【Note】
If the workpiece has draft angle, the interference length will be longer than the under-neck length. Please refer to the effective under-neck length for the various draft angles.
In addition, the angle at which the tool will interfere with the workpiece is shown as the "interference angle θ_k ", and should also be referred to.

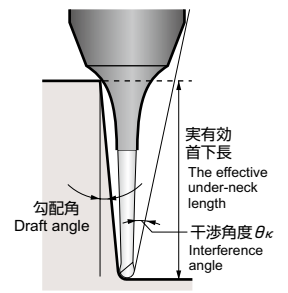

EPDBP2○○○-○○-○○-TH

商品コード Item code	在庫 Stock	寸法 Size(mm)											干渉角度 Interference angle (°)	勾配角に対する実有効首下長 The effective under-neck length for the various draft angles.					希望小売 価格(円) Suggested retail price (¥)
		ボール半径 Ball radius	外径 Tool dia.	首下長 Under neck length	首部 テー(半角) Neck angle	刃長 Flute length	首径 Neck dia.	首元径 Under neck dia.	全長 Overall length	シャン径 Shank dia.	首R Neck R	仮想首長 Approx neck length							
		RE	DC	LU	BHTA2	APMX	BD2	BD3	LF	DCONMS	ℓ'	θ_k		0.5°	1°	1.5°	2°	3°	
EPDBP2009-4-04-TH	△	0.45	0.9	4	0.4	0.6	0.86	0.907	50	4	4	3.46	8.15	4.5	4.75	4.94	5.11	5.41	9,520
EPDBP2009-8-04-TH	△			8	0.4	0.6	0.86	0.963	55	4	7	3.46	6.03	8.75	9.30	9.7	10.03	10.6	9,520
EPDBP2009-12-04-TH	△			12	0.4	0.6	0.86	1.019	55	4	10	3.46	4.78	12.99	13.86	14.46	14.95	15.78	9,850
EPDBP2009-16-04-TH	△			16	0.4	0.6	0.86	1.075	60	4	10	3.46	3.96	17.07	18.08	18.77	19.33	20.54	11,790
EPDBP2009-18-04-TH	△			18	0.4	0.6	0.86	1.103	65	4	10	3.46	3.65	19.1	20.19	20.91	21.50	23.11	13,720
EPDBP2009-20-04-TH	△			20	0.4	0.6	0.86	1.131	65	4	10	3.46	3.38	21.13	22.29	23.05	23.66	25.68	13,720
EPDBP2009-22-04-TH	△			22	0.4	0.6	0.86	1.159	65	4	10	3.46	3.15	23.17	24.38	25.17	25.81	28.24	13,720
EPDBP2009-24-04-TH	△			24	0.4	0.6	0.86	1.187	70	4	10	3.46	2.95	25.2	26.47	27.29	27.96	干渉なし	14,360
EPDBP2010-6-04-TH	△	0.5	1	6	0.4	0.8	0.94	1.013	50	6	7	5.09	8.26	6.82	7.24	7.57	7.85	8.34	8,740
EPDBP2010-8-04-TH	△			8	0.4	0.8	0.94	1.041	55	6	7	5.09	7.44	8.85	9.36	9.74	10.07	10.62	8,740
EPDBP2010-10-04-TH	△			10	0.4	0.8	0.94	1.068	55	6	10	5.09	6.76	11.07	11.79	12.33	12.78	13.54	8,740
EPDBP2010-10-09-TH	△			10	0.9	0.8	0.94	1.229	55	6	10	2.7	6.88	-	11.2	11.91	12.44	13.28	8,740
EPDBP2010-15-09-TH	△			15	0.9	0.8	0.94	1.386	60	6	10	2.7	5.64	-	16.28	17.19	17.84	18.84	11,680
EPDBP2010-20-04-TH	△			20	0.4	0.8	0.94	1.208	65	6	10	5.09	4.65	21.23	22.33	23.08	23.69	25.73	13,720
EPDBP2010-20-09-TH	△			20	0.9	0.8	0.94	1.543	65	6	10	2.7	4.77	-	21.35	22.44	23.18	24.68	13,720
EPDBP2010-25-09-TH	△			25	0.9	0.8	0.94	1.700	70	6	10	2.7	4.14	-	26.42	27.66	28.48	30.83	14,360
EPDBP2010-30-04-TH	△			30	0.4	0.8	0.94	1.348	75	6	10	5.09	3.54	31.37	32.76	33.66	34.82	38.57	15,000
EPDBP2010-30-09-TH	△			30	0.9	0.8	0.94	1.857	75	6	10	2.7	3.65	-	31.49	32.86	33.75	36.98	15,000
EPDBP2010-35-09-TH	△			35	0.9	0.8	0.94	2.015	80	6	10	2.7	3.27	-	36.55	38.04	39	43.12	15,650
EPDBP2010-40-09-TH	△			40	0.9	0.8	0.94	2.172	85	6	10	2.7	2.96	-	41.61	43.22	44.46	干渉なし	16,720
EPDBP2010-50-09-TH	△			50	0.9	0.8	0.94	2.486	95	6	10	2.7	2.48	-	51.73	53.53	55.55	干渉なし	17,570
EPDBP2010-60-09-TH	△			60	0.9	0.8	0.94	2.800	105	6	10	2.7	2.14	-	61.84	63.81	66.63	干渉なし	18,750
EPDBP2010-70-09-TH	△			70	0.9	0.8	0.94	3.114	115	6	10	2.7	1.88	-	71.94	74.09	干渉なし	干渉なし	19,500
EPDBP2015-8-04-TH	△			0.75	1.5	8	0.4	1.35	1.42	1.513	55	6	7	7.07	7.21	8.95	9.41	9.78	10.09
EPDBP2015-10-04-TH	△	10	0.4			1.35	1.42	1.541	55	6	7	7.07	6.51	10.97	11.52	11.93	12.28	12.9	8,740
EPDBP2015-12-04-TH	△	12	0.4			1.35	1.42	1.569	55	6	7	7.07	5.93	13	13.62	14.07	14.45	15.47	10,420
EPDBP2015-15-09-TH	△	15	0.9			1.35	1.42	1.849	60	6	10	3.89	5.36	-	16.4	17.25	17.88	18.86	10,420
EPDBP2015-20-09-TH	△	20	0.9			1.35	1.42	2.006	65	6	10	3.89	4.5	-	21.47	22.49	23.21	24.72	10,420
EPDBP2015-30-09-TH	△	30	0.9			1.35	1.42	2.320	75	6	10	3.89	3.4	-	31.59	32.9	33.78	37.01	14,360
EPDBP2018-4-04-TH	△	0.9	1.8	4	0.4	1.6	1.73	1.764	50	6	4	4.38	9.14	4.63	4.83	4.99	5.14	5.4	10,420
EPDBP2018-8-04-TH	△			8	0.4	1.6	1.73	1.819	50	6	4	6.61	7.07	8.68	9.02	9.27	9.49	10.27	10,420
EPDBP2018-12-04-TH	△			12	0.4	1.6	1.73	1.875	55	6	7	6.61	5.77	12.97	13.59	14.05	14.43	15.4	10,420
EPDBP2018-16-04-TH	△			16	0.4	1.6	1.73	1.931	60	6	7	6.61	4.87	17.02	17.77	18.3	18.73	20.54	10,420
EPDBP2018-20-04-TH	△			20	0.4	1.6	1.73	1.987	65	6	10	6.61	4.21	21.29	22.35	23.08	23.68	25.67	10,420
EPDBP2018-24-04-TH	△			24	0.4	1.6	1.73	2.043	65	6	10	6.61	3.71	25.35	26.53	27.33	27.97	30.8	11,900
EPDBP2018-28-04-TH	△			28	0.4	1.6	1.73	2.099	70	6	10	6.61	3.32	29.4	30.69	31.55	32.49	35.94	14,150
EPDBP2018-32-04-TH	△			32	0.4	1.6	1.73	2.154	70	6	10	6.61	3	33.45	34.85	35.76	37.11	干渉なし	14,150
EPDBP2018-36-04-TH	△			36	0.4	1.6	1.73	2.210	75	6	10	6.61	2.74	37.5	38.99	39.96	41.74	干渉なし	14,150
EPDBP2018-38-04-TH	△			38	0.4	1.6	1.73	2.238	80	6	10	6.61	2.62	39.53	41.06	42.05	44.06	干渉なし	15,110
EPDBP2018-40-04-TH	△			40	0.4	1.6	1.73	2.266	80	6	10	6.61	2.52	41.55	43.13	44.24	46.37	干渉なし	15,110

エポックペンシルディープボール

EPDBP2-TH

商品コード Item code	在庫 Stock	寸法 Size(mm)											干渉角度 Interference angle (°)	勾配角に対する実有効首下長 The effective under-neck length for the various draft angles.					希望小売 価格(円) Suggested retail price (¥)
		ボール半径 Ball radius	外径 Tool dia.	首下長 Under neck length	首部 テーパー角 Neck angle	刃長 Flute length	首径 Neck dia.	首元径 Under neck dia.	全長 Overall length	シャンク径 Shank dia.	首R	仮想首長 Approx neck length							
		RE	DC	LU	BHTA2	APMX	BD2	BD3	LF	DCONMS	Neck R	ℓ'		θκ	0.5°	1°	1.5°	2°	
EPDBP2020-8-04-TH	△	1	2	8	0.4	1.7	1.92	2.008	50	6	4	7.42	6.96	8.7	9.03	9.28	9.5	10.27	8,740
EPDBP2020-12-04-TH	△			12	0.4	1.7	1.92	2.064	55	6	7	7.42	5.64	13	13.61	14.06	14.43	15.4	8,740
EPDBP2020-16-04-TH	△			16	0.4	1.7	1.92	2.120	60	6	7	7.42	4.74	17.05	17.79	18.31	18.74	20.54	8,740
EPDBP2020-20-04-TH	△			20	0.4	1.7	1.92	2.176	65	6	10	7.42	4.09	21.33	22.37	23.09	23.68	25.67	8,740
EPDBP2020-20-09-TH	△			20	0.9	1.7	1.92	2.495	65	6	10	4.24	4.2	-	21.48	22.49	23.2	24.68	8,740
EPDBP2020-25-09-TH	△			25	0.9	1.7	1.92	2.652	65	6	10	4.24	3.6	-	26.54	27.7	28.5	30.82	11,680
EPDBP2020-30-04-TH	△			30	0.4	1.7	1.92	2.315	70	6	10	7.42	3.04	31.46	32.79	33.67	34.81	38.51	14,360
EPDBP2020-30-09-TH	△			30	0.9	1.7	1.92	2.809	70	6	10	4.24	3.14	-	31.6	32.9	33.77	36.97	14,360
EPDBP2020-35-09-TH	△			35	0.9	1.7	1.92	2.966	75	6	10	4.24	2.79	-	36.66	38.08	39.02	干涉なし	15,000
EPDBP2020-40-04-TH	△			40	0.4	1.7	1.92	2.455	80	6	10	7.42	2.42	41.58	43.14	44.26	46.39	干涉なし	15,650
EPDBP2020-40-09-TH	△			40	0.9	1.7	1.92	3.123	80	6	10	4.24	2.51	-	41.72	43.25	44.5	干涉なし	15,650
EPDBP2020-50-09-TH	△			50	0.9	1.7	1.92	3.438	90	6	10	4.24	2.09	-	51.82	53.56	55.58	干涉なし	17,570
EPDBP2020-60-09-TH	△			60	0.9	1.7	1.92	3.752	100	6	10	4.24	1.79	-	61.92	63.84	干涉なし	干涉なし	18,430
EPDBP2020-70-09-TH	△			70	0.9	1.7	1.92	4.066	110	6	10	4.24	1.56	-	72.02	74.15	干涉なし	干涉なし	19,930
EPDBP2030-8-04-TH	△	1.5	3	8	0.4	2.5	2.86	2.937	50	6	4	8.5	6.25	8.87	9.13	9.35	9.55	10.33	8,740
EPDBP2030-16-04-TH	△			16	0.4	2.5	2.86	3.048	55	6	7	12.52	4.01	17.25	17.89	18.38	18.79	20.6	11,370
EPDBP2030-20-04-TH	△			20	0.4	2.5	2.86	3.104	60	6	7	12.52	3.4	21.29	22.04	22.6	23.34	25.74	11,370
EPDBP2030-30-04-TH	△			30	0.4	2.5	2.86	3.244	70	6	10	12.52	2.46	31.67	32.88	33.73	34.92	干涉なし	13,080
EPDBP2030-30-09-TH	△			30	0.9	2.5	2.86	3.724	70	6	10	6.95	2.54	-	31.82	33	33.84	干涉なし	13,080
EPDBP2030-40-04-TH	△			40	0.4	2.5	2.86	3.384	80	6	10	12.52	1.93	41.78	43.23	44.38	干涉なし	干涉なし	15,000
EPDBP2030-40-09-TH	△			40	0.9	2.5	2.86	4.038	80	6	10	6.95	2	-	41.92	43.34	干涉なし	干涉なし	15,000
EPDBP2030-50-09-TH	△			50	0.9	2.5	2.86	4.352	90	6	10	6.95	1.64	-	52.01	53.65	干涉なし	干涉なし	16,290
EPDBP2030-60-09-TH	△			60	0.9	2.5	2.86	4.667	100	6	10	6.95	1.39	-	62.1	干涉なし	干涉なし	干涉なし	17,570
EPDBP2030-70-09-TH	△			70	0.9	2.5	2.86	4.981	110	6	10	6.95	1.2	-	72.19	干涉なし	干涉なし	干涉なし	20,040
EPDBP2040-20-10-TH	△	2	4	20	1	8	3.86	4.279	70	8	7	12.01	4.95	20.56	21.67	22.31	22.8	23.59	11,370
EPDBP2040-30-10-TH	△			30	1	8	3.86	4.628	80	8	7	12.01	3.51	22.02	31.67	32.56	33.2	34.16	11,370
EPDBP2040-40-10-TH	△			40	1	8	3.86	4.977	90	8	10	12.01	2.65	22.02	42.04	43.4	44.34	干涉なし	14,460
EPDBP2040-50-10-TH	△			50	1	8	3.86	5.326	100	8	10	12.01	2.17	22.02	52.04	53.65	54.71	干涉なし	17,040
EPDBP2040-60-10-TH	△			60	1	8	3.86	5.675	110	8	10	12.01	1.83	22.02	62.04	63.88	干涉なし	干涉なし	18,640
EPDBP2050-30-10-TH	△	2.5	5	30	1	10	4.86	5.558	80	8	7	14.01	2.74	25.52	31.78	32.62	33.24	干涉なし	17,850
EPDBP2050-40-10-TH	△			40	1	10	4.86	5.907	90	8	7	14.01	2.09	25.52	41.78	42.84	43.57	干涉なし	18,300
EPDBP2050-60-10-TH	△			60	1	10	4.86	6.606	110	8	10	14.01	1.41	25.52	62.17	干涉なし	干涉なし	干涉なし	20,540
EPDBP2060-30-10-TH	△	3	6	30	1	12	5.86	6.488	80	8	7	16.01	1.9	29.03	31.89	32.68	干涉なし	干涉なし	17,850
EPDBP2060-40-10-TH	△			40	1	12	5.86	6.837	90	8	7	16.01	1.44	29.03	41.89	干涉なし	干涉なし	干涉なし	19,080
EPDBP2060-50-10-TH	△			50	1	12	5.86	7.187	100	8	7	16.01	1.17	29.03	51.89	干涉なし	干涉なし	干涉なし	21,770
EPDBP2060-60-10-TH	△			60	1	12	5.86	7.536	110	10	10	16.01	1.86	29.03	62.29	63.98	干涉なし	干涉なし	29,630
EPDBP2060-70-10-TH	△			70	1	12	5.86	7.885	120	10	10	16.01	1.61	29.03	72.29	74.19	干涉なし	干涉なし	31,420
EPDBP2060-80-10-TH	△			80	1	12	5.86	8.234	130	10	10	16.01	1.42	29.03	82.29	干涉なし	干涉なし	干涉なし	33,220
EPDBP2080-50-10-TH	△	4	8	50	1	14	7.86	9.117	110	10	7	18.01	1.19	32.03	51.95	干涉なし	干涉なし	干涉なし	29,630
EPDBP2080-60-10-TH	△			60	1	14	7.86	9.466	120	10	7	18.01	0.99	32.03	干涉なし	干涉なし	干涉なし	干涉なし	31,420
EPDBP2080-70-10-TH	△			70	1	14	7.86	9.815	130	10	7	18.01	0.86	32.03	干涉なし	干涉なし	干涉なし	干涉なし	33,220
EPDBP2080-80-10-TH	△			80	1	14	7.86	10.164	140	12	10	18.01	1.43	32.03	82.37	干涉なし	干涉なし	干涉なし	41,080
EPDBP2100-60-10-TH	△	5	10	60	1	18	9.86	11.326	130	12	7	22.01	1.01	39.03	62.13	干涉なし	干涉なし	干涉なし	38,830
EPDBP2100-75-10-TH	△			75	1	18	9.86	11.850	140	12	7	22.01	0.81	39.03	干涉なし	干涉なし	干涉なし	干涉なし	41,080

● 対応被削材 Applicable work material

炭素鋼 合金鋼 Carbon steel Alloy steel	プリハードン 鋼 Pre-hardened steel	高硬度 Hardened steel			ステン レス鋼 Stainless steel	チタン合金 耐熱合金 Titanium alloy Heat-resistant alloy	銅合金 Copper alloy	アルミ 合金 Aluminum alloy
○	○	> 45HRC ≤ 55HRC	> 55HRC ≤ 65HRC	> 65HRC	○	○	○	○

● 再研磨対応外径範囲 Re-grinding compatibility range

商品コード Item code	外周 Outer dia. (mm)	エンド End (mm)
EPDBP-TH	× (N/A)	4 ~ 10

[注意] 首下長/外径が10DCを超える工具の再研磨可否については、弊社営業にお問い合わせください。
[Note] Contact our sales office regarding whether or not regrinding is possible for tools where under neck length/tool diameter more than 10DC.

△印：在庫が無くなり次第受注生産品となるものです。 △：When the Stock is out, will become to produce on request. 干涉なし：No interference

超硬ボール
ボールエンドミル

標準切削条件表 Recommended cutting conditions

EPDBP-TH

被削材 Work material					1		2		3		4		5	
					炭素鋼・合金鋼 Carbon steels, Alloy steels (180~250HB)		ステンレス鋼・工具鋼 Stainless steels, Tool steels (25~35HRC)		プリハードン鋼 Pre-hardened steels (35~45HRC)		焼入れ鋼 Hardened steels (45~55HRC)		焼入れ鋼 Hardened steels (55~65HRC)	
切込み比率 Ratio to standard depth of cut					100%		90%		80%		65%		60%	
ボール半径 Ball radius (mm)	外径 Tool dia. (mm)	首下長 Under neck length (mm)	首角度 Neck angle (°)	基本切込み Standard depth of cut (mm)	回転数 n min ⁻¹	送り速度 Vf mm/min	回転数 n min ⁻¹	送り速度 Vf mm/min	回転数 n min ⁻¹	送り速度 Vf mm/min	回転数 n min ⁻¹	送り速度 Vf mm/min	回転数 n min ⁻¹	送り速度 Vf mm/min
0.1	0.2	1	0.4	0.017	40,000	800	34,000	680	28,000	504	26,000	416	26,000	364
		1.5	0.4	0.009	40,000	800	34,000	680	28,000	504	26,000	416	26,000	364
		2	0.9	0.007	32,000	461	27,200	392	22,400	323	20,800	266	20,800	233
		2.5	0.9	0.004	26,000	333	22,100	283	18,200	204	16,900	189	16,900	162
0.15	0.3	2	0.4	0.025	40,000	1,200	34,000	1,020	28,000	756	26,000	624	26,000	546
		3	0.9	0.013	32,000	691	27,200	588	22,400	484	20,800	399	20,800	349
		4	0.9	0.010	26,000	499	22,100	424	18,200	306	16,900	284	16,900	243
0.2	0.4	2	0.4	0.035	40,000	1,600	34,000	1,360	28,000	1,008	26,000	832	26,000	728
		3	0.4	0.020	40,000	1,600	34,000	1,360	28,000	1,008	26,000	832	26,000	728
		4	0.4	0.007	32,000	922	27,200	783	22,400	645	20,800	532	20,800	466
		4	0.9	0.009	32,000	922	27,200	783	22,400	645	20,800	532	20,800	466
		5	0.4	0.006	26,000	666	22,100	566	18,200	408	16,900	379	16,900	324
		5	0.9	0.007	26,000	666	22,100	566	18,200	408	16,900	379	16,900	324
0.25	0.5	4	0.4	0.040	40,000	2,000	34,000	1,700	28,000	1,260	26,000	1,040	26,000	910
		8	0.9	0.010	26,000	728	22,100	619	18,200	446	16,900	414	16,900	355
		12	0.9	0.005	22,400	627	19,040	533	15,680	384	14,560	357	14,560	306
0.27	0.54	2	0.4	0.050	40,000	2,160	34,000	1,836	28,000	1,361	26,000	1,123	26,000	983
		4	0.4	0.037	40,000	2,160	34,000	1,836	28,000	1,361	26,000	1,123	26,000	983
		5	0.4	0.031	40,000	1,512	34,000	1,428	28,000	1,176	26,000	1,040	26,000	832
		6	0.4	0.025	26,000	1,244	22,100	1,058	18,200	871	16,900	676	16,900	629
		6.5	0.4	0.020	26,000	1,011	22,100	859	18,200	619	16,900	575	16,900	493
		7	0.4	0.015	26,000	899	22,100	812	18,200	585	16,900	543	16,900	465
0.3	0.6	2	0.4	0.055	40,000	2,400	34,000	2,040	28,000	1,512	26,000	1,248	26,000	1,092
		4	0.4	0.035	40,000	2,400	34,000	2,040	28,000	1,512	26,000	1,248	26,000	1,092
		6	0.4	0.018	32,000	1,382	27,200	1,175	22,400	968	20,800	799	20,800	699
		6	0.9	0.020	32,000	1,382	27,200	1,175	22,400	968	20,800	799	20,800	699
		8	0.9	0.020	26,000	998	22,100	849	18,200	612	16,900	568	16,900	487
		10	0.4	0.013	26,000	874	22,100	743	18,200	535	16,900	497	16,900	426
		10	0.9	0.015	26,000	874	22,100	743	18,200	535	16,900	497	16,900	426
		12	0.9	0.010	26,000	874	22,100	743	18,200	535	16,900	497	16,900	426
		15	0.4	0.005	22,400	753	19,040	640	15,680	461	14,560	367	14,560	367
		15	0.9	0.006	22,400	753	19,040	640	15,680	461	14,560	367	14,560	367
0.4	0.8	4	0.4	0.062	32,000	2,560	27,200	2,176	22,400	1,613	20,800	1,331	20,800	1,165
		6	0.4	0.045	32,000	2,560	27,200	2,176	22,400	1,613	20,800	1,331	20,800	1,165
		8	0.9	0.026	25,600	1,475	21,760	1,253	17,920	1,032	16,640	852	16,640	745
		12	0.9	0.020	20,800	1,065	17,680	905	14,560	699	13,520	606	13,520	519
		16	0.9	0.018	20,800	932	17,680	792	14,560	612	13,520	530	13,520	454
0.45	0.9	4	0.4	0.063	28,300	2,547	24,055	2,165	19,810	1,605	18,395	1,324	18,395	1,159
		8	0.4	0.050	28,300	2,547	24,055	2,165	19,810	1,605	18,395	1,324	18,395	1,159
		12	0.4	0.037	18,400	1,325	15,640	1,126	12,880	811	11,960	753	11,960	646
		16	0.4	0.024	18,400	1,325	15,640	1,126	12,880	811	11,960	753	11,960	646
		18	0.4	0.018	18,400	1,325	15,640	1,126	12,880	811	11,960	753	11,960	646
		20	0.4	0.015	15,850	1,141	13,473	970	11,095	699	10,303	649	10,303	556
		22	0.4	0.012	15,850	1,141	13,473	970	11,095	699	10,303	649	10,303	556
		24	0.4	0.009	14,150	1,019	12,028	866	9,905	624	9,198	579	9,198	497

【注意】 ご使用にあたっては、A167ページの表下の項目と注意を参照してください。 **【Note】** Upon usage, please refer to comments and notes below table on page A167.

エポックペンシルディープボール

超硬ボールエンドミル

EPDBP-TH

被削材 Work material					1		2		3		4		5	
					炭素鋼・合金鋼 Carbon steels, Alloy steels (180~250HB)		ステンレス鋼・工具鋼 Stainless steels, Tool steels (25~35HRC)		プリハードン鋼 Pre-hardened steels (35~45HRC)		焼入れ鋼 Hardened steels (45~55HRC)		焼入れ鋼 Hardened steels (55~65HRC)	
切込み比率 Ratio to standard depth of cut					100%		90%		80%		65%		60%	
ボール半径RE Ball radius (mm)	外径DC Tool dia. (mm)	首下長LU Under neck length (mm)	首角度 Neck angle (°)	基本切込み Standard depth of cut (mm)	回転数 n min ⁻¹	送り速度 vf mm/min	回転数 n min ⁻¹	送り速度 vf mm/min	回転数 n min ⁻¹	送り速度 vf mm/min	回転数 n min ⁻¹	送り速度 vf mm/min	回転数 n min ⁻¹	送り速度 vf mm/min
0.5	1	6	0.4	0.055	25,600	2,560	21,760	2,176	17,920	1,613	16,640	1,331	16,640	1,165
		8	0.4	0.055	25,600	2,560	21,760	2,176	17,920	1,613	16,640	1,331	16,640	1,165
		10	0.4	0.032	20,800	1,872	17,680	1,591	14,560	1,310	13,520	1,082	13,520	946
		10	0.9	0.035	20,800	1,872	17,680	1,591	14,560	1,310	13,520	1,082	13,520	946
		15	0.9	0.028	16,640	1,331	14,144	1,132	11,648	874	10,816	757	10,816	649
		20	0.4	0.018	16,640	1,331	14,144	1,132	11,648	874	10,816	757	10,816	649
		20	0.9	0.020	16,640	1,331	14,144	1,132	11,648	874	10,816	757	10,816	649
		25	0.9	0.017	14,560	1,165	12,376	990	10,192	764	9,464	662	9,464	568
		30	0.4	0.015	12,480	874	10,608	743	8,736	568	8,112	487	8,112	406
		30	0.9	0.017	12,480	874	10,608	743	8,736	568	8,112	487	8,112	406
		35	0.9	0.010	10,400	728	8,840	619	7,280	473	6,760	406	6,760	338
		40	0.9	0.009	10,000	700	8,500	595	7,000	455	6,500	390	6,500	325
		50	0.9	0.007	9,500	665	8,075	565	6,650	432	6,175	371	6,175	309
		60	0.9	0.005	9,000	630	7,650	536	6,300	410	5,850	351	5,850	293
70	0.9	0.003	8,500	595	7,225	506	5,950	387	5,525	332	5,525	276		
0.75	1.5	8	0.4	0.070	16,960	2,544	14,416	2,162	11,872	1,603	11,024	1,323	11,024	1,158
		10	0.4	0.070	16,960	2,544	14,416	2,162	11,872	1,603	11,024	1,323	11,024	1,158
		12	0.4	0.070	16,960	2,544	14,416	2,162	11,872	1,603	11,024	1,323	11,024	1,158
		15	0.9	0.045	13,568	1,832	11,533	1,557	9,498	1,282	8,819	1,058	8,819	926
		20	0.9	0.040	11,024	1,323	9,370	1,124	7,717	810	7,166	752	7,166	645
		30	0.9	0.028	11,024	1,323	9,370	1,124	7,717	810	7,166	752	7,166	645
0.9	1.8	4	0.4	0.120	14,200	2,556	12,070	2,173	9,940	1,610	9,230	1,329	9,230	1,163
		8	0.4	0.100	14,200	2,556	12,070	2,173	9,940	1,610	9,230	1,329	9,230	1,163
		12	0.4	0.080	14,200	2,556	12,070	2,173	9,940	1,610	9,230	1,329	9,230	1,163
		16	0.4	0.071	14,200	2,556	12,070	2,173	9,940	1,610	9,230	1,329	9,230	1,163
		20	0.4	0.062	9,230	1,329	7,846	1,130	6,461	814	6,000	756	6,000	648
		24	0.4	0.053	9,230	1,329	7,846	1,130	6,461	814	6,000	756	6,000	648
		28	0.4	0.044	9,230	1,329	7,846	1,130	6,461	814	6,000	756	6,000	648
		32	0.4	0.036	9,230	1,329	7,846	1,130	6,461	814	6,000	756	6,000	648
		36	0.4	0.028	9,230	1,329	7,846	1,130	6,461	814	6,000	756	6,000	648
		40	0.4	0.020	8,000	1,152	6,800	979	5,600	706	5,200	655	5,200	562
1	2	8	0.4	0.150	15,200	3,040	12,920	2,584	10,640	1,915	9,880	1,581	9,880	1,383
		12	0.4	0.090	15,200	3,040	12,920	2,584	10,640	1,915	9,880	1,581	9,880	1,383
		16	0.4	0.090	15,200	3,040	12,920	2,584	10,640	1,915	9,880	1,581	9,880	1,383
		20	0.4	0.060	12,160	2,189	10,336	1,860	8,512	1,532	7,904	1,265	7,904	1,107
		20	0.9	0.070	12,160	2,189	10,336	1,860	8,512	1,532	7,904	1,265	7,904	1,107
		25	0.9	0.070	9,880	1,581	8,398	1,344	6,916	968	6,422	899	6,422	771
		30	0.4	0.040	9,880	1,581	8,398	1,344	6,916	968	6,422	899	6,422	771
		30	0.9	0.045	9,880	1,581	8,398	1,344	6,916	968	6,422	899	6,422	771
		35	0.9	0.045	9,880	1,581	8,398	1,344	6,916	968	6,422	899	6,422	771
		40	0.4	0.030	9,880	1,581	8,398	1,344	6,916	968	6,422	899	6,422	771
40	0.9	0.035	9,880	1,581	8,398	1,344	6,916	968	6,422	899	6,422	771		

被削材 Work material		1		2		3		4		5				
		炭素鋼・合金鋼 Carbon steels, Alloy steels (180~250HB)		ステンレス鋼・工具鋼 Stainless steels, Tool steels (25~35HRC)		プリハードン鋼 Pre-hardened steels (35~45HRC)		焼入れ鋼 Hardened steels (45~55HRC)		焼入れ鋼 Hardened steels (55~65HRC)				
切込み比率 Ratio to standard depth of cut		100%		90%		80%		65%		60%				
ボール半径RE Ball radius (mm)	外径DC Tool dia. (mm)	首下長LU Under neck length (mm)	首角度 Neck angle (°)	基本切込み Standard depth of cut (mm)	回転数 n min ⁻¹	送り速度 Vf mm/min	回転数 n min ⁻¹	送り速度 Vf mm/min	回転数 n min ⁻¹	送り速度 Vf mm/min	回転数 n min ⁻¹	送り速度 Vf mm/min	回転数 n min ⁻¹	送り速度 Vf mm/min
1	2	50	0.9	0.017	8,512	1,192	7,235	1,013	5,958	775	5,533	664	5,533	553
		60	0.9	0.009	7,235	1,013	6,150	861	5,065	658	4,703	564	4,703	470
		70	0.9	0.005	6,150	861	5,227	732	4,305	560	3,997	480	3,997	400
1.5	3	8	0.4	0.320	12,720	3,816	10,812	3,244	8,904	2,404	8,268	1,984	8,268	1,736
		16	0.4	0.220	12,720	3,816	10,812	3,244	8,904	2,404	8,268	1,984	8,268	1,736
		20	0.4	0.150	12,720	3,434	10,812	2,919	8,904	2,137	8,268	1,736	8,268	1,488
		30	0.4	0.080	10,176	2,748	8,650	2,335	7,123	1,496	6,614	1,389	6,614	1,191
		30	0.9	0.090	10,176	2,748	8,650	2,335	7,123	1,496	6,614	1,389	6,614	1,191
		40	0.4	0.060	8,268	1,984	7,028	1,687	5,788	1,215	5,374	1,129	5,374	967
		40	0.9	0.070	8,268	1,984	7,028	1,687	5,788	1,215	5,374	1,129	5,374	967
		50	0.9	0.050	8,268	1,984	7,028	1,687	5,788	1,215	5,374	1,129	5,374	967
		60	0.9	0.030	7,123	1,710	6,055	1,453	4,986	1,047	4,630	972	4,630	833
70	0.9	0.020	6,233	1,496	5,298	1,271	4,363	916	4,051	851	4,051	729		
2	4	20	1	0.320	11,900	2,860	10,100	2,420	9,000	2,050	7,800	1,680	7,800	1,590
		30	1	0.230	11,900	2,570	10,100	2,180	9,000	1,850	7,800	1,520	7,800	1,430
		40	1	0.140	9,500	1,940	8,100	1,650	7,200	1,400	6,200	1,140	6,200	1,080
		50	1	0.110	7,800	1,590	6,600	1,350	5,800	1,120	5,000	920	5,000	870
		60	1	0.070	7,800	1,590	6,600	1,350	5,800	1,120	5,000	920	5,000	870
2.5	5	30	1	0.340	9,500	2,140	8,100	1,820	7,200	1,540	6,200	1,260	6,200	1,190
		40	1	0.250	9,500	2,140	8,100	1,820	7,200	1,540	6,200	1,260	6,200	1,190
		60	1	0.150	6,200	1,320	5,300	1,130	4,700	950	4,000	770	4,000	720
3	6	30	1	0.450	8,000	2,000	6,800	1,700	6,000	1,430	5,200	1,170	5,200	1,110
		40	1	0.400	8,000	1,800	6,800	1,530	6,000	1,280	5,200	1,050	5,200	990
		50	1	0.320	8,000	1,800	6,800	1,530	6,000	1,280	5,200	1,050	5,200	990
		60	1	0.220	6,400	1,360	5,400	1,150	4,800	970	4,100	780	4,100	740
		70	1	0.180	5,200	1,110	4,400	940	3,900	790	3,400	650	3,400	610
		80	1	0.140	5,200	1,110	4,400	940	3,900	790	3,400	650	3,400	610
4	8	50	1	0.500	6,000	1,460	5,100	1,240	4,500	1,040	3,900	850	3,900	810
		60	1	0.430	6,000	1,460	5,100	1,240	4,500	1,040	3,900	850	3,900	810
		70	1	0.330	6,000	1,460	5,100	1,240	4,500	1,040	3,900	850	3,900	810
		80	1	0.250	4,800	1,100	4,100	940	3,600	780	3,100	640	3,100	600
5	10	60	1	0.700	4,800	1,300	4,100	1,110	3,600	920	3,100	750	3,100	710
		75	1	0.500	4,800	1,300	4,100	1,110	3,600	920	3,100	750	3,100	710

※(1) 基本切込みは被削材グループ1での目安を示しています。その他のグループの場合は、上表の切込み比率を目安に調整して下さい。
 ※(2) リブ加工や止まり溝など、切りくずがつまりやすい切削の場合、切込み設定は基本切込みに切込み比率をかけて算出した切込み量を、さらにその80%まで小さくして使用してください。

※(1) Standard cutting depth is shown as the criteria for Group 1 workpieces. For other groups, adjust the cutting depth according to the cutting depth factors in the above table.
 ※(2) When performing cutting where cutting chips may cause clogging, such as for rib cutting, blind grooves, etc., cutting depth setting should be set by multiplying a cutting depth factor to calculate the cutting depth amount, and this amount should then be reduced to 80% of the calculated value.

【切込み設定例】 EPDBP2020-25-09-THの工具で焼き入れ鋼(50HRC)をリブ溝等高線切削する場合、
 切込み=0.07(基本切込み)×0.65(焼き入れ鋼グループ4の切込み比率)×0.8(閉鎖域の切削)=0.036mm
 Cutting depth setting example: When cutting rib groove contours in quenched steel (50HRC) using an EPDBP2020-25-09-TH tool:
 Cutting depth = 0.07 (standard cutting depth) × 0.65 (cutting depth factor for Group 4 quenched steel) × 0.8 (for closed-area cutting) = 0.036mm

- 【注意】**
- ① 被削材、加工形状に合わせて、適切なクーラントを使用してください。
 - ② この標準切削条件表は切削条件の目安を示すものです。実際の加工では加工形状、目的、使用機械等により条件を調整してください。
 - ③ 機械の回転数が足りない場合は、回転数と送り速度を同じ比率で下げてください。
- 【Note】**
- ① Use the appropriate coolant for the work material and machining shape.
 - ② These Recommended Cutting Conditions indicate only the rule of a thumb for the cutting conditions. In actual machining, the condition should be adjusted according to the machining shape, purpose and the machine type.
 - ③ If the rpm of the machine is low, lower the feed rate also to put the rpm and feed rate in the same ratio.

エポックメガフィードボール

首下ストレート

Straight Neck Type

3枚刃ボールエンドミル。不等分割でビビリ振動を抑制。
3-flute ball end mill. Uneven division suppresses chattering.



RE公差
RE1~RE6 : ±0.01
RE8~RE10 : ±0.015



(mm)

3枚刃
3Flutes

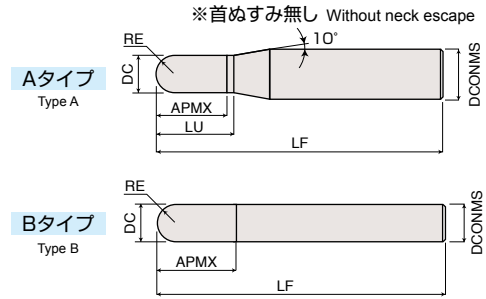

EMB3○○○-TH

商品コード Item code	在庫 Stock	寸法 Size(mm)						首形状 Neck shape	希望小売 価格(円) Suggested retail price (¥)
		ボール半径 Ball radius	外径 Tool dia.	刃長 Flute length	首下長 Under neck length	全長 Overall length	シャンク径 Shank dia.		
		RE	DC	APMX	LU	LF	DCONMS		
EMB3020-TH	△	1	2	3	4	50	6	A	15,650
EMB3030-TH	△	1.5	3	4.5	5.5	70	6	A	16,610
EMB3040-TH	△	2	4	6	7	70	6	A	16,610
EMB3050-TH	△	2.5	5	7.5	8.5	80	6	A	18,640
EMB3060-TH	△	3	6	9	—	90	6	B	19,760
EMB3080-TH	△	4	8	12	—	100	8	B	25,930
EMB3100-TH	△	5	10	15	—	100	10	B	32,990
EMB3120-TH	△	6	12	18	—	110	12	B	42,870
EMB3160-TH	△	8	16	24	—	140	16	B	87,750
EMB3200-TH	△	10	20	30	—	160	20	B	137,250

対応被削材 Applicable work material

炭素鋼 合金鋼 Carbon steel Alloy steel	プリハー ド鋼 Pre-hardened steel	高硬度 Hardened steel			ステン レス鋼 Stainless steel	チタン合金 耐熱合金 Titanium alloy Heat-resistant alloy	銅合金 Copper alloy	アルミ 合金 Aluminum alloy
○	○	> 45HRC ≤ 55HRC	> 55HRC ≤ 65HRC	> 65HRC	○	○	○	○

再研磨対応外径範囲 Re-grinding compatibility range

商品コード Item code	外周 Outer dia. (mm)	エンド End (mm)
EMB-TH	× (N/A)	2 ~ 20

△印：在庫が無くなり次第受注生産品となるものです。 △：When the Stock is out, will become to produce on request.

標準切削条件表 Recommended cutting conditions

EMB-TH 首下ストレートタイプ Straight Neck

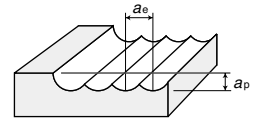

〈荒加工〉 Roughing

被削材 Work material	炭素鋼・合金鋼 Carbon steels, Alloy steels 180~250HB		工具鋼 Tool steels 25~35HRC		プリハードン鋼 Pre-hardened steels 35~45HRC		焼入れ鋼 Hardened steels 45~55HRC		焼入れ鋼 Hardened steels 55~65HRC	
	切り込み(mm) Depth of Cut	$a_p=0.1$ DC $a_e=0.3$ DC	$a_p=0.1$ DC $a_e=0.3$ DC	$a_p=0.1$ DC $a_e=0.3$ DC	$a_p=0.1$ DC $a_e=0.3$ DC	$a_p=0.07$ DC $a_e=0.21$ DC	$a_p=0.05$ DC $a_e=0.15$ DC			
ボール半径RE Ball radius	回転数n min ⁻¹	送り速度vf mm/min	回転数n min ⁻¹	送り速度vf mm/min	回転数n min ⁻¹	送り速度vf mm/min	回転数n min ⁻¹	送り速度vf mm/min	回転数n min ⁻¹	送り速度vf mm/min
RE1	35,000	3,680	31,800	3,340	28,600	2,850	25,500	2,140	22,300	1,400
RE1.5	23,300	3,840	21,200	3,500	19,100	2,990	17,000	2,240	14,900	1,480
RE2	17,500	3,940	15,900	3,580	14,300	3,060	12,700	2,290	11,100	1,500
RE2.5	14,000	4,200	12,700	3,810	11,500	3,280	10,200	2,450	8,900	1,600
RE3	11,700	4,390	10,600	3,980	9,500	3,380	8,500	2,550	7,400	1,670
RE4	8,800	4,620	8,000	4,200	7,200	3,590	6,400	2,690	5,600	1,760
RE5	7,000	4,620	6,400	4,220	5,700	3,570	5,100	2,690	4,500	1,780
RE6	5,800	4,520	5,300	4,130	4,800	3,560	4,200	2,620	3,700	1,730
RE8	4,400	4,220	4,000	3,840	3,600	3,280	3,200	2,460	2,800	1,610
RE10	3,500	3,780	3,200	3,460	2,900	2,980	2,500	2,160	2,200	1,430

- 【注意】**
- ① できるだけ高剛性、高精度の機械をご使用ください。
 - ② 被削材、加工形状に合わせて、適切なクーラントを使用してください。
 - ③ この切削条件表は切削条件の目安を示すものです。実際の加工では加工形状、目的、使用機械等により条件を調整してください。
 - ④ 機械の回転数が足りない場合には、回転数と送り速度を同じ比率で下げてください。

- 【Note】**
- ① Use a highly rigid and accurate machine as possible.
 - ② Use the appropriate coolant for the work material and machining shape.
 - ③ These conditions are for general guidance; in actual machining conditions adjust the parameters according to your actual machine and work-piece conditions.
 - ④ If the rpm available is lower than that recommended please reduce the feed rate to the same ratio.

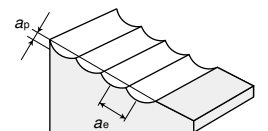

〈仕上げ加工〉 Finishing

被削材 Work material	炭素鋼・合金鋼 Carbon steels, Alloy steels 180~250HB		工具鋼 Tool steels 25~35HRC		プリハードン鋼 Pre-hardened steels 35~45HRC		焼入れ鋼 Hardened steels 45~55HRC		焼入れ鋼 Hardened steels 55~65HRC	
	切り込み(mm) Depth of Cut	$a_p=0.05\sim0.1$ $a_e=0.02$ DC	$a_p=0.05\sim0.1$ $a_e=0.02$ DC	$a_p=0.05\sim0.1$ $a_e=0.02$ DC	$a_p=0.05\sim0.1$ $a_e=0.02$ DC	$a_p=0.05\sim0.1$ $a_e=0.02$ DC	$a_p=0.05\sim0.1$ $a_e=0.02$ DC	$a_p=0.05\sim0.1$ $a_e=0.02$ DC		
ボール半径RE Ball radius	回転数n min ⁻¹	送り速度vf mm/min	回転数n min ⁻¹	送り速度vf mm/min	回転数n min ⁻¹	送り速度vf mm/min	回転数n min ⁻¹	送り速度vf mm/min	回転数n min ⁻¹	送り速度vf mm/min
RE1	47,700	3,580	44,600	3,350	41,400	2,950	33,400	2,000	28,600	1,290
RE1.5	31,800	3,820	29,700	3,560	27,600	3,150	22,300	2,140	19,100	1,380
RE2	23,900	3,940	22,300	3,680	20,700	3,240	16,700	2,200	14,300	1,420
RE2.5	19,100	4,010	17,800	3,740	16,600	3,310	13,400	2,250	11,500	1,450
RE3	15,900	4,170	14,900	3,910	13,800	3,440	11,100	2,330	9,500	1,500
RE4	11,900	4,280	11,100	4,000	10,300	3,520	8,400	2,420	7,200	1,560
RE5	9,500	4,280	8,900	4,010	8,300	3,550	6,700	2,410	5,700	1,540
RE6	8,000	4,320	7,400	4,000	6,900	3,540	5,600	2,420	4,800	1,560
RE8	6,000	3,960	5,600	3,700	5,200	3,260	4,200	2,220	3,600	1,430
RE10	4,800	3,740	4,500	3,510	4,100	3,040	3,300	2,060	2,900	1,360

- 【注意】**
- ① できるだけ高剛性、高精度の機械をご使用ください。
 - ② 上表の a_e (ピックフィード)は目安です。実際にはA131頁のカスプハイト表を参考に選定してください。
 - ③ 被削材、加工形状に合わせて、適切なクーラントを使用してください。
 - ④ この切削条件表は切削条件の目安を示すものです。実際の加工では加工形状、目的、使用機械等により条件を調整してください。
 - ⑤ 機械の回転数が足りない場合には、回転数と送り速度を同じ比率で下げてください。

- 【Note】**
- ① Use a highly rigid and accurate machine as possible.
 - ② The pick feed in the table is a general condition; please select the a_e according to the cusp height requested (page A131).
 - ③ Use the appropriate coolant for the work material and machining shape.
 - ④ These conditions are for general guidance; in actual machining conditions adjust the parameters according to your actual machine and work-piece conditions.
 - ⑤ If the rpm available is lower than that recommended please reduce the feed rate to the same ratio.

エポックメガフィードボール

ペンシルネックタイプ

Pencil Neck Type

3枚刃ボールエンドミル。不等分割でビビリ振動を抑制。
3-flute ball end mill. Uneven division suppresses chattering.



±0.01



(mm)

3枚刃
3Flutes

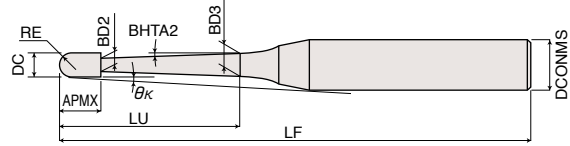

EMBP3○○○-10-TH



商品コード Item code	在庫 Stock	寸法 Size(mm)										干渉角度 Interference angle (°)	勾配角に対する実有効首下長 The effective under-neck length for the various draft angles.			希小売 価格 (円) Suggested retail price (¥)
		ボール半径 Ball radius	外径 Tool dia.	節径(半角) Neck angle	首下長 Under Neck length	刃長 Flute length	首径 Neck dia.	首元径 Neck dia.	全長 Overall length	シャンク径 Shank dia.	DCONMS		1°	2°	3°	
		RE	DC	BHTA2	LU	APMX	BD2	BD3	LF	DCONMS	θk					
EMBP3040-30-10-TH	△	2	4	1	30	6	3.9	4.738	80	6	1.85	31.41	干渉なし	干渉なし	18,540	
EMBP3040-40-10-TH	△			1	40	6	3.9	5.087	90	6	1.4	41.72	干渉なし	干渉なし	19,180	
EMBP3040-50-10-TH	△			1	50	6	3.9	5.436	100	6	1.14	51.72	干渉なし	干渉なし	19,820	
EMBP3040-60-10-TH	△			1	60	6	3.9	5.785	100	6	0.97	干渉なし	干渉なし	干渉なし	19,820	
EMBP3050-40-10-TH	△	2.5	5	1	40	7.5	4.9	6.035	90	8	2.04	41.5	44.46	干渉なし	24,810	
EMBP3050-60-10-TH	△			1	60	7.5	4.9	6.733	110	8	1.41	61.83	干渉なし	干渉なし	26,260	
EMBP3060-50-10-TH	△	3	6	1	50	9	5.9	7.331	100	8	1.17	51.58	干渉なし	干渉なし	27,610	
EMBP3060-60-10-TH	△			1	60	9	5.9	7.680	110	8	0.98	干渉なし	干渉なし	干渉なし	30,080	
EMBP3060-70-10-TH	△			1	70	9	5.9	8.030	120	10	1.6	71.93	干渉なし	干渉なし	36,590	
EMBP3060-80-10-TH	△			1	80	9	5.9	8.379	130	10	1.42	81.93	干渉なし	干渉なし	38,040	
EMBP3080-60-10-TH	△	4	8	1	60	12	7.9	9.576	120	10	1	干渉なし	干渉なし	干渉なし	35,800	
EMBP3080-70-10-TH	△			1	70	12	7.9	9.925	130	10	0.86	干渉なし	干渉なし	干渉なし	37,370	
EMBP3080-80-10-TH	△			1	80	12	7.9	10.274	140	12	1.44	82.11	干渉なし	干渉なし	43,320	
EMBP3100-60-10-TH	△	5	10	1	60	15	9.9	11.471	130	12	1.01	61.88	干渉なし	干渉なし	43,880	
EMBP3100-75-10-TH	△			1	75	15	9.9	11.995	140	12	0.82	干渉なし	干渉なし	干渉なし	46,130	

【注意】 加工物に勾配がついている場合、干渉領域は、首下長さよりも長くなります。それぞれの勾配角に対する実有効首下長をご参照ください。
また、工具が加工物に干渉する角度を干渉角度 θ_k で表示していますので合わせてご参照ください。
【Note】 If the workpiece has draft angle, the interference length will be longer than the under-neck length. Please refer to the effective under-neck length for the various draft angles. In addition, the angle at which the tool will interfere with the workpiece is shown as the "interference angle θ_k ", and should also be referred to.

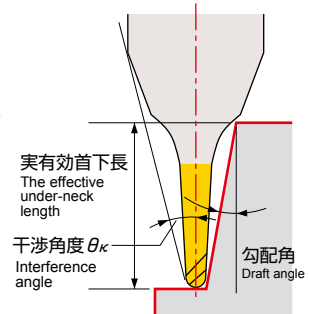

対応被削材 Applicable work material

炭素鋼 合金鋼 Carbon steel Alloy steel	プリハー ド鋼 Pre-hardened steel	高硬度 Hardened steel			ステン レス鋼 Stainless steel	チタン合金 耐熱合金 Titanium alloy Heat-resistant alloy	銅合金 Copper alloy	アルミ 合金 Aluminum alloy
○	○	> 45HRC ≤ 45HRC	> 55HRC ≤ 55HRC	> 65HRC	○	○	○	○

再研磨対応外径範囲 Re-grinding compatibility range

商品コード Item code	外周 Outer dia. (mm)	エンド End (mm)
EMBP-TH	× (N/A)	4 ~ 10

【注意】 首下長/外径が10DCを超える工具の再研磨可否については、弊社営業にお問い合わせください。
【Note】 Contact our sales office regarding whether or not regrinding is possible for tools where under neck length/tool diameter more than 10DC.

△印：在庫が無くなり次第受注生産品となるものです。 △：When the Stock is out, will become to produce on request. 干渉なし：No interference

標準切削条件表 Recommended cutting conditions

EMBP-TH

ペンシルネックタイプ
Pencil Neck

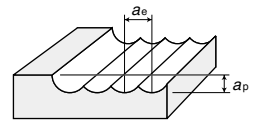

〈荒加工〉 Roughing

被削材 Work material		炭素鋼・合金鋼 Carbon steels, Alloy steels 180~250HB		工具鋼 Tool steels 25~35HRC		プリハードン鋼 Pre-hardened steels 35~45HRC		焼入れ鋼 Hardened steels 45~55HRC		焼入れ鋼 Hardened steels 55~65HRC	
切り込み (mm) Depth of Cut		$a_p=0.08DC$ $a_e=0.24DC$		$a_p=0.07DC$ $a_e=0.21DC$		$a_p=0.06DC$ $a_e=0.18DC$		$a_p=0.04DC$ $a_e=0.12DC$		$a_p=0.03DC$ $a_e=0.09DC$	
ボール半径RE Ball radius	首下長 Under neck length (mm)	回転数n min ⁻¹	送り速度vf mm/min	回転数n min ⁻¹	送り速度vf mm/min	回転数n min ⁻¹	送り速度vf mm/min	回転数n min ⁻¹	送り速度vf mm/min	回転数n min ⁻¹	送り速度vf mm/min
RE2	30	14,300	3,000	12,700	2,670	11,100	2,210	9,500	1,600	8,000	1,010
	40	12,900	2,710	11,500	2,420	10,000	2,000	8,600	1,440	7,200	910
	50	10,000	1,800	8,900	1,600	7,800	1,330	6,700	960	5,600	600
	60	7,200	1,080	6,400	960	5,600	800	4,800	580	4,000	360
RE2.5	40	11,500	3,110	10,200	2,750	8,900	2,280	7,600	1,640	6,400	1,040
	60	9,200	2,210	8,100	1,940	7,100	1,620	6,100	1,170	5,100	730
RE3	50	9,500	3,420	8,500	3,060	7,400	2,530	6,400	1,840	5,300	1,140
	60	8,600	3,100	7,600	2,740	6,700	2,290	5,700	1,640	4,800	1,040
	70	7,600	2,510	6,800	2,240	5,900	1,850	5,100	1,350	4,200	830
	80	6,700	2,010	5,900	1,770	5,200	1,480	4,500	1,150	3,700	670
RE4	60	7,200	3,460	6,400	3,070	5,600	2,550	4,800	1,840	4,000	1,150
	70	6,800	3,260	6,000	2,880	5,300	2,420	4,500	1,730	3,800	1,090
RE5	80	6,400	2,690	5,700	2,390	5,000	2,000	4,300	1,440	3,600	910
	60	6,300	3,780	5,600	3,360	4,900	2,790	4,200	2,020	3,500	1,260
RE5	75	5,700	3,420	5,100	3,060	4,500	2,570	3,800	1,820	3,200	1,150

- [注意]** ①できるだけ高剛性、高精度の機械をご使用ください。
 ②被削材、加工形状に合わせて、適切なクーラントを使用してください。
 ③この切削条件表は切削条件の目安を示すものです。実際の加工では加工形状、目的、使用機械等により条件を調整してください。
 ④機械の回転数が足りない場合には、回転数と送り速度を同じ比率で下げてください。

- [Note]** ① Use a highly rigid and accurate machine as possible.
 ② Use the appropriate coolant for the work material and machining shape.
 ③ These conditions are for general guidance; in actual machining conditions adjust the parameters according to your actual machine and work-piece conditions.
 ④ If the rpm available is lower than that recommended please reduce the feed rate to the same ratio.

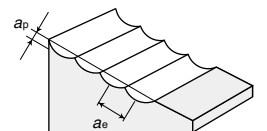

〈仕上げ加工〉 Finishing

被削材 Work material		炭素鋼・合金鋼 Carbon steels, Alloy steels 180~250HB		工具鋼 Tool steels 25~35HRC		プリハードン鋼 Pre-hardened steels 35~45HRC		焼入れ鋼 Hardened steels 45~55HRC		焼入れ鋼 Hardened steels 55~65HRC	
切り込み (mm) Depth of Cut		$a_p=0.05\sim0.1$ $a_e=0.02DC$		$a_p=0.05\sim0.1$ $a_e=0.02DC$		$a_p=0.05\sim0.1$ $a_e=0.02DC$		$a_p=0.05\sim0.1$ $a_e=0.02DC$		$a_p=0.05\sim0.1$ $a_e=0.02DC$	
ボール半径RE Ball radius	首下長 Under neck length (mm)	回転数n min ⁻¹	送り速度vf mm/min	回転数n min ⁻¹	送り速度vf mm/min	回転数n min ⁻¹	送り速度vf mm/min	回転数n min ⁻¹	送り速度vf mm/min	回転数n min ⁻¹	送り速度vf mm/min
RE2	30	17,500	2,630	15,900	2,390	14,300	2,040	12,700	1,520	11,100	1,000
	40	15,800	2,370	14,300	2,150	12,900	1,840	11,500	1,380	10,000	900
	50	12,300	1,850	11,100	1,670	10,000	1,430	8,900	1,070	7,800	700
	60	8,800	1,060	8,000	960	7,200	820	6,400	610	5,600	400
RE2.5	40	14,000	2,520	12,700	2,290	11,500	1,970	10,200	1,470	8,900	960
	60	11,200	1,680	10,200	1,530	9,200	1,310	8,100	970	7,100	640
RE3	50	11,700	2,460	10,600	2,230	9,500	1,900	8,500	1,430	7,400	930
	60	10,500	2,210	9,500	2,000	8,600	1,720	7,600	1,280	6,700	840
	70	9,300	1,670	8,500	1,530	7,600	1,300	6,800	980	5,900	640
	80	8,200	1,230	7,400	1,110	6,700	950	5,900	750	5,200	470
RE4	60	8,800	2,640	8,000	2,400	7,200	2,050	6,400	1,540	5,600	1,010
	70	8,300	2,490	7,600	2,280	6,800	1,940	6,000	1,440	5,300	950
RE5	80	7,900	2,130	7,200	1,940	6,400	1,640	5,700	1,230	5,000	810
	60	7,700	2,770	7,000	2,520	6,300	2,150	5,600	1,610	4,900	1,060
RE5	75	7,000	2,520	6,400	2,300	5,700	1,950	5,100	1,470	4,500	970

- [注意]** ①できるだけ高剛性、高精度の機械をご使用ください。
 ②上表の a_e (ピックフィード)は目安です。実際にはA131頁のカスパイト表を参考に選定してください。
 ③被削材、加工形状に合わせて、適切なクーラントを使用してください。
 ④この切削条件表は切削条件の目安を示すものです。実際の加工では加工形状、目的、使用機械等により条件を調整してください。
 ⑤機械の回転数が足りない場合には、回転数と送り速度を同じ比率で下げてください。

- [Note]** ① Use a highly rigid and accurate machine as possible.
 ② The pick feed in the table is a general condition; please select the a_e according to the cusp height requested (page A131).
 ③ Use the appropriate coolant for the work material and machining shape.
 ④ These conditions are for general guidance; in actual machining conditions adjust the parameters according to your actual machine and work-piece conditions.
 ⑤ If the rpm available is lower than that recommended please reduce the feed rate to the same ratio.

Epoch Deep Radius Evolution Hard-TH3

エポックディープラジラスエボリューションハード-TH3

2枚刃 2 Flutes

溝 Slotting 影込み Die-sinking 曲面 Profiling R Radius 細部 Miniature 取りのこし Rest Material Machining 中仕上げ Semi Finishing 仕上げ Finishing リブ細部 Rib Miniature

RE公差 ±0.005 (中心基準 central axis) h4 (mm)

高硬度鋼の加工において優れた耐摩耗性を発揮。
 金型の加工で優れた加工精度を実現。
 Performs excellent wear resistance when cutting hardened steel and contributes to high precision machining of molds & dies.

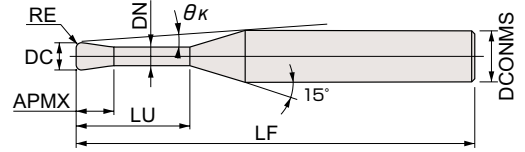

※2枚刃はバックドラフト形状(強バックテーパ)を採用しています。
 The 2-flute tool uses a backdraft profile (with strong back taper).

EPDREH2-TH3

超硬 TH3 成形30° 切削条件表 A180
 Carbide Helix angle Cutting Conditions

商品コード Item code	在庫 Stock	寸法 Size(mm)							干渉角度 Interference angle (°) θ_k	勾配角に対する実有効首下長 Effective under neck length with respect to draft angle					希望小売価格(円) Suggested retail price (¥)	
		外径 Tool dia. DC	コーナ半径 Corner radius RE	首下長 Under neck length LU	刃長 Flute length APMX	首径 Neck dia. DN	全長 Overall length LF	シャンク径 Shank dia. DCONMS		0.5°	1°	1.5°	2°	3°		
EPDREH2002-0.5-002-TH3	●	0.2	0.02	0.5	0.15	0.17	50	4	13.99	0.57	0.59	0.61	0.63	0.68	10,610	
EPDREH2002-1-002-TH3	●			1	0.15	0.17	50	4	13.16	1.09	1.12	1.16	1.21	1.3	10,610	
EPDREH2002-0.5-005-TH3	●		0.05	0.5	0.15	0.17	50	4	14.05	0.57	0.59	0.61	0.63	0.67	10,610	
EPDREH2002-1-005-TH3	●			1	0.15	0.17	50	4	13.21	1.08	1.12	1.16	1.2	1.3	10,610	
EPDREH2003-1-002-TH3	●	0.3	0.02	1	0.25	0.27	50	4	13.12	1.09	1.12	1.16	1.21	1.3	10,260	
EPDREH2003-2-002-TH3	●			2	0.25	0.27	50	4	11.7	2.12	2.19	2.27	2.36	2.55	10,260	
EPDREH2003-1-005-TH3	●		0.05	1	0.25	0.27	50	4	13.17	1.08	1.12	1.16	1.2	1.3	10,260	
EPDREH2003-2-005-TH3	●			2	0.25	0.27	50	4	11.73	2.12	2.19	2.27	2.35	2.54	10,260	
EPDREH2004-1-002-TH3	●	0.4	0.02	1	0.3	0.37	50	4	13.07	1.09	1.12	1.16	1.21	1.3	6,840	
EPDREH2004-2-002-TH3	●			2	0.3	0.37	50	4	11.62	2.12	2.19	2.27	2.36	2.55	6,840	
EPDREH2004-1-005-TH3	●		0.05	1	0.3	0.37	50	4	13.12	1.08	1.12	1.16	1.2	1.3	6,840	
EPDREH2004-2-005-TH3	●			2	0.3	0.37	50	4	11.66	2.12	2.19	2.27	2.35	2.54	6,840	
EPDREH2004-1-01-TH3	●		0.1	1	0.3	0.37	50	4	13.21	1.08	1.12	1.15	1.19	1.28	6,840	
EPDREH2004-2-01-TH3	●			2	0.3	0.37	50	4	11.73	2.12	2.19	2.26	2.34	2.53	6,840	
EPDREH2005-1-002-TH3	●	0.5	0.02	1	0.35	0.47	50	4	13.03	1.09	1.12	1.16	1.21	1.3	5,550	
EPDREH2005-2-002-TH3	●			2	0.35	0.47	50	4	11.55	2.12	2.19	2.27	2.36	2.55	5,550	
EPDREH2005-3-002-TH3	●			3	0.35	0.47	50	4	10.37	3.15	3.26	3.38	3.51	3.79	5,550	
EPDREH2005-1-005-TH3	●		0.05	1	0.35	0.47	50	4	13.08	1.08	1.12	1.16	1.2	1.3	5,550	
EPDREH2005-2-005-TH3	●			2	0.35	0.47	50	4	11.59	2.12	2.19	2.27	2.35	2.54	5,550	
EPDREH2005-3-005-TH3	●			3	0.35	0.47	50	4	10.4	3.15	3.26	3.38	3.5	3.78	5,550	
EPDREH2005-1-01-TH3	●		0.1	1	0.35	0.47	50	4	13.16	1.08	1.12	1.15	1.19	1.28	5,550	
EPDREH2005-2-01-TH3	●			2	0.35	0.47	50	4	11.66	2.12	2.19	2.26	2.34	2.53	5,550	
EPDREH2005-3-01-TH3	●			3	0.35	0.47	50	4	10.46	3.15	3.26	3.37	3.49	3.77	5,550	
EPDREH2006-2-002-TH3	●		0.6	0.02	2	0.4	0.57	50	4	11.47	2.12	2.19	2.27	2.36	2.55	5,550
EPDREH2006-4-002-TH3	●				4	0.4	0.57	50	4	9.31	4.19	4.33	4.49	4.66	5.03	5,550
EPDREH2006-2-005-TH3	●			0.05	2	0.4	0.57	50	4	11.51	2.12	2.19	2.27	2.35	2.54	5,550
EPDREH2006-4-005-TH3	●	4			0.4	0.57	50	4	9.33	4.19	4.33	4.48	4.65	5.03	5,550	
EPDREH2006-2-01-TH3	●	0.1		2	0.4	0.57	50	4	11.58	2.12	2.19	2.26	2.34	2.53	5,550	
EPDREH2006-4-01-TH3	●			4	0.4	0.57	50	4	9.38	4.18	4.33	4.48	4.64	5.01	5,550	
EPDREH2008-2-002-TH3	●	0.8	0.02	2	0.5	0.77	50	4	11.3	2.12	2.19	2.27	2.36	2.55	6,370	
EPDREH2008-4-002-TH3	●			4	0.5	0.77	50	4	9.09	4.19	4.33	4.49	4.66	5.03	6,370	
EPDREH2008-2-005-TH3	●		0.05	2	0.5	0.77	50	4	11.35	2.12	2.19	2.27	2.35	2.54	6,370	
EPDREH2008-4-005-TH3	●			4	0.5	0.77	50	4	9.12	4.19	4.33	4.48	4.65	5.03	6,370	
EPDREH2008-2-01-TH3	●		0.1	2	0.5	0.77	50	4	11.42	2.12	2.19	2.26	2.34	2.53	6,370	
EPDREH2008-4-01-TH3	●			4	0.5	0.77	50	4	9.16	4.18	4.33	4.48	4.64	5.01	6,370	
EPDREH2008-2-02-TH3	●		0.2	2	0.5	0.77	50	4	11.56	2.11	2.18	2.25	2.33	2.5	6,370	
EPDREH2008-4-02-TH3	●			4	0.5	0.77	50	4	9.25	4.18	4.32	4.47	4.63	4.99	6,370	

● : 標準在庫品です。 ● : Stocked items. 干渉なし : No interference

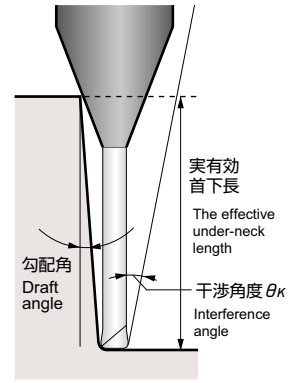

【注意】
 エポックディープラジオスエボリューション
 EPDRE-ATHとは勾配角に対する実有効首下長が異なります。
 再度ご確認くださいませ。

【Note】
 The actual effective length in incline angles is different from Epoch Deep Radius Evolution EPDRE-ATH.
 Please recheck the interference area.

EPDREH2 ϕ ϕ ϕ - ϕ . ϕ - ϕ ϕ ϕ -TH3

商品コード Item code	在庫 Stock	寸法 Size(mm)							干渉角度 Interference angle (°) $\theta\kappa$	勾配角に対する実有効首下長 Effective under neck length with respect to draft angle					希望小売価格(円) Suggested retail price (¥)	
		外径 Tool dia.	コーナ半径 Corner radius	首下長 Under neck length	刃長 Flute length	首径 Neck dia.	全長 Overall length	シャンク径 Shank dia.		0.5°	1°	1.5°	2°	3°		
		DC	RE	LU	APMX	DN	LF	DCONMS								
EPDREH2010-2-002-TH3	●	1	0.02	2	0.8	0.94	50	4	11.04	2.18	2.25	2.33	2.42	2.62	5,430	
EPDREH2010-4-002-TH3	●			4	0.8	0.94	50	4	8.8	4.24	4.39	4.55	4.72	5.1	5,430	
EPDREH2010-6-002-TH3	●			6	0.8	0.94	50	4	7.32	6.31	6.53	6.77	7.02	7.59	5,900	
EPDREH2010-8-002-TH3	●			8	0.8	0.94	50	4	6.26	8.38	8.67	8.98	9.32	10.07	5,900	
EPDREH2010-2-005-TH3	●			0.05	2	0.8	0.94	50	4	11.08	2.18	2.25	2.33	2.42	2.61	5,430
EPDREH2010-4-005-TH3	●				4	0.8	0.94	50	4	8.83	4.24	4.39	4.55	4.72	5.09	5,430
EPDREH2010-6-005-TH3	●				6	0.8	0.94	50	4	7.34	6.31	6.53	6.76	7.02	7.58	5,900
EPDREH2010-8-005-TH3	●				8	0.8	0.94	50	4	6.27	8.38	8.67	8.98	9.32	10.07	5,900
EPDREH2010-2-01-TH3	●			0.1	2	0.8	0.94	50	4	11.16	2.17	2.25	2.33	2.41	2.6	5,430
EPDREH2010-4-01-TH3	●				4	0.8	0.94	50	4	8.88	4.24	4.39	4.54	4.71	5.08	5,430
EPDREH2010-6-01-TH3	●				6	0.8	0.94	50	4	7.37	6.31	6.53	6.76	7.01	7.57	5,900
EPDREH2010-8-01-TH3	●				8	0.8	0.94	50	4	6.29	8.38	8.67	8.97	9.31	10.06	5,900
EPDREH2010-2-02-TH3	●		0.2	2	0.8	0.94	50	4	11.3	2.17	2.24	2.31	2.39	2.57	5,430	
EPDREH2010-4-02-TH3	●			4	0.8	0.94	50	4	8.97	4.24	4.38	4.53	4.69	5.06	5,430	
EPDREH2010-6-02-TH3	●			6	0.8	0.94	50	4	7.43	6.31	6.52	6.75	6.99	7.55	5,900	
EPDREH2010-8-02-TH3	●			8	0.8	0.94	50	4	6.34	8.37	8.66	8.96	9.29	10.03	5,900	

○ 対応被削材 Applicable work material

炭素鋼 合金鋼 Carbon steel Alloy steel	プリハードン鋼 Pre-hardened steel ≤ 45HRC	高硬度 Hardened steel			ステンレス鋼 Stainless steel	チタン合金 耐熱合金 Titanium alloy Heat-resistant alloy	銅合金 Copper alloy	アルミ合金 Aluminum alloy
		> 45HRC ≤ 55HRC	> 55HRC ≤ 65HRC	> 65HRC				
○	○	◎	◎	◎	○	◎	○	○

○ 再研磨対応外径範囲 Re-grinding compatibility range

商品コード Item code	外周 Outer dia. (mm)	エンド End (mm)
EPDREH2-TH3	× (N/A)	× (N/A)

Epoch Deep Radius Evolution Hard-TH3

エポックディープラジオスエボリューションハード-TH3



4枚刃 4 Flutes

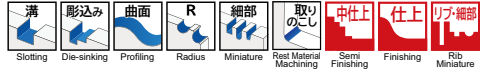

高硬度鋼の加工において優れた耐摩耗性を発揮。
金型の加工で優れた加工精度を実現。
Performs excellent wear resistance when cutting hardened steel and contributes to high precision machining of molds & dies.

RE公差 ±0.005 (中心基準 central axis)

h4 h5 DCONMS-4 DCONMS-6 (mm)

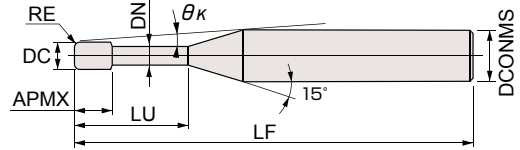

EPDREH4-0.02-0.05-0.1-0.2-0.3-TH3



商品コード Item code	在庫 Stock	寸法 Size(mm)							干渉角度 Interference angle (°) θ _K	勾配角に対する実有効首下長 Effective under neck length with respect to draft angle					希望小売 価格 (円) Suggested retail price (¥)
		外径 Tool dia. DC	コーナ半径 Corner radius RE	首下長 Under neck length LU	刃長 Flute length APMX	首径 Neck dia. DN	全長 Overall length LF	シャンク径 Shank dia. DCONMS		0.5°	1°	1.5°	2°	3°	
EPDREH4010-1.5-002-TH3	●	0.02	1	1.5	0.6	0.96	50	4	11.85	1.62	1.68	1.74	1.80	1.95	7,820
EPDREH4010-2-002-TH3	●			2	0.6	0.96	50	4	11.09	2.14	2.21	2.29	2.38	2.57	7,820
EPDREH4010-2.5-002-TH3	●			2.5	0.6	0.96	50	4	10.43	2.66	2.75	2.85	2.95	3.19	7,820
EPDREH4010-3-002-TH3	●			3	0.6	0.96	50	4	9.84	3.17	3.28	3.40	3.53	3.81	7,820
EPDREH4010-4-002-TH3	●			4	0.6	0.96	50	4	8.84	4.21	4.35	4.51	4.68	5.06	7,820
EPDREH4010-5-002-TH3	●			5	0.6	0.96	50	4	8.02	5.24	5.42	5.62	5.83	6.30	8,570
EPDREH4010-6-002-TH3	●			6	0.6	0.96	50	4	7.34	6.27	6.49	6.73	6.98	7.54	8,570
EPDREH4010-8-002-TH3	●			8	0.6	0.96	50	4	6.27	8.34	8.63	8.94	9.28	10.03	8,570
EPDREH4010-1.5-005-TH3	●	0.05	1	1.5	0.6	0.96	50	4	11.90	1.62	1.68	1.73	1.80	1.94	7,820
EPDREH4010-2-005-TH3	●			2	0.6	0.96	50	4	11.14	2.14	2.21	2.29	2.37	2.56	7,820
EPDREH4010-2.5-005-TH3	●			2.5	0.6	0.96	50	4	10.47	2.65	2.75	2.84	2.95	3.18	7,820
EPDREH4010-3-005-TH3	●			3	0.6	0.96	50	4	9.87	3.17	3.28	3.40	3.52	3.81	7,820
EPDREH4010-4-005-TH3	●			4	0.6	0.96	50	4	8.87	4.21	4.35	4.51	4.67	5.05	7,820
EPDREH4010-5-005-TH3	●			5	0.6	0.96	50	4	8.04	5.24	5.42	5.61	5.82	6.29	8,570
EPDREH4010-6-005-TH3	●			6	0.6	0.96	50	4	7.36	6.27	6.49	6.72	6.97	7.53	8,570
EPDREH4010-8-005-TH3	●			8	0.6	0.96	50	4	6.29	8.34	8.63	8.94	9.27	10.02	8,570
EPDREH4010-1.5-01-TH3	●	0.1	1	1.5	0.6	0.96	50	4	11.98	1.62	1.67	1.73	1.79	1.93	7,820
EPDREH4010-2-01-TH3	●			2	0.6	0.96	50	4	11.21	2.14	2.21	2.28	2.37	2.55	7,820
EPDREH4010-2.5-01-TH3	●			2.5	0.6	0.96	50	4	10.53	2.65	2.74	2.84	2.94	3.17	7,820
EPDREH4010-3-01-TH3	●			3	0.6	0.96	50	4	9.93	3.17	3.28	3.39	3.52	3.79	7,820
EPDREH4010-4-01-TH3	●			4	0.6	0.96	50	4	8.91	4.20	4.35	4.50	4.67	5.04	7,820
EPDREH4010-5-01-TH3	●			5	0.6	0.96	50	4	8.08	5.24	5.42	5.61	5.82	6.28	8,570
EPDREH4010-6-01-TH3	●			6	0.6	0.96	50	4	7.39	6.27	6.49	6.72	6.97	7.52	8,570
EPDREH4010-8-01-TH3	●			8	0.6	0.96	50	4	6.31	8.34	8.63	8.93	9.26	10.01	8,570
EPDREH4010-1.5-02-TH3	●	0.2	1	1.5	0.6	0.96	50	4	12.15	1.62	1.67	1.72	1.78	1.91	7,820
EPDREH4010-2-02-TH3	●			2	0.6	0.96	50	4	11.36	2.13	2.20	2.27	2.35	2.53	7,820
EPDREH4010-2.5-02-TH3	●			2.5	0.6	0.96	50	4	10.66	2.65	2.74	2.83	2.93	3.15	7,820
EPDREH4010-3-02-TH3	●			3	0.6	0.96	50	4	10.04	3.17	3.27	3.38	3.50	3.77	7,820
EPDREH4010-4-02-TH3	●			4	0.6	0.96	50	4	9.00	4.20	4.34	4.49	4.65	5.01	7,820
EPDREH4010-5-02-TH3	●			5	0.6	0.96	50	4	8.16	5.23	5.41	5.60	5.80	6.26	8,570
EPDREH4010-6-02-TH3	●			6	0.6	0.96	50	4	7.45	6.27	6.48	6.71	6.95	7.50	8,570
EPDREH4010-8-02-TH3	●			8	0.6	0.96	50	4	6.36	8.33	8.62	8.92	9.25	9.99	8,570
EPDREH4010-1.5-03-TH3	●	0.3	1	1.5	0.6	0.96	50	4	12.32	1.61	1.66	1.71	1.76	1.88	7,820
EPDREH4010-2-03-TH3	●			2	0.6	0.96	50	4	11.51	2.13	2.19	2.26	2.34	2.50	7,820
EPDREH4010-2.5-03-TH3	●			2.5	0.6	0.96	50	4	10.79	2.65	2.73	2.82	2.91	3.12	7,820
EPDREH4010-3-03-TH3	●			3	0.6	0.96	50	4	10.16	3.16	3.26	3.37	3.49	3.75	7,820
EPDREH4010-4-03-TH3	●			4	0.6	0.96	50	4	9.10	4.20	4.33	4.48	4.64	4.99	7,820
EPDREH4010-5-03-TH3	●			5	0.6	0.96	50	4	8.23	5.23	5.40	5.59	5.79	6.23	8,570
EPDREH4010-6-03-TH3	●			6	0.6	0.96	50	4	7.52	6.26	6.47	6.70	6.94	7.48	8,570
EPDREH4010-8-03-TH3	●			8	0.6	0.96	50	4	6.41	8.33	8.61	8.91	9.24	9.96	8,570

●印：標準在庫品です。 ●：Stocked items.

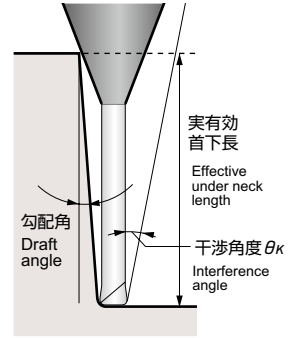

【注意】
エポックディープラジウスエボリューション
EPDRE-ATHとは勾配角に対する実有
有効首下長が異なります。
再度ご確認ください。
【Note】
The actual effective under neck length with
respect to the draft angle differs from the
Epoch Deep Radius Evolution EPDRE-ATH.
Please be sure to check this.

EPDREH4 ϕ - ϕ - TH3

商品コード Item code	在庫 Stock	寸法 Size(mm)							干渉角度 Interference angle (°) θ_K	勾配角に対する実有効首下長 Effective under neck length with respect to draft angle					希望小売 価格(円) Suggested retail price (¥)				
		外径 Tool dia.	コーナ半径 Corner radius	首下長 Under neck length	刃長 Flute length	首径 Neck dia.	全長 Overall length	シャンク径 Shank dia.		0.5°	1°	1.5°	2°	3°					
		DC	RE	LU	APMX	DN	LF	DCONMS											
EPDREH4015-2-002-TH3	●	0.02	1.5	0.02	2	0.9	1.44	50	4	10.49	2.18	2.25	2.33	2.42	2.62	8,320			
EPDREH4015-3-002-TH3	●				3	0.9	1.44	50	4	9.16	3.21	3.32	3.44	3.57	3.86	8,320			
EPDREH4015-4-002-TH3	●				4	0.9	1.44	50	4	8.13	4.24	4.39	4.55	4.72	5.10	8,320			
EPDREH4015-5-002-TH3	●				5	0.9	1.44	50	4	7.31	5.28	5.46	5.66	5.87	6.35	8,320			
EPDREH4015-6-002-TH3	●				6	0.9	1.44	50	4	6.63	6.31	6.53	6.77	7.02	7.59	8,320			
EPDREH4015-8-002-TH3	●				8	0.9	1.44	50	4	5.60	8.38	8.67	8.98	9.32	10.07	8,820			
EPDREH4015-10-002-TH3	●				10	0.9	1.44	50	4	4.85	10.45	10.81	11.20	11.62	12.56	8,820			
EPDREH4015-12-002-TH3	●				12	0.9	1.44	50	4	4.27	12.51	12.95	13.42	13.92	15.05	8,820			
EPDREH4015-2-005-TH3	●				0.05	1.5	0.05	2	0.9	1.44	50	4	10.53	2.18	2.25	2.33	2.42	2.61	8,320
EPDREH4015-3-005-TH3	●							3	0.9	1.44	50	4	9.19	3.21	3.32	3.44	3.57	3.85	8,320
EPDREH4015-4-005-TH3	●							4	0.9	1.44	50	4	8.16	4.24	4.39	4.55	4.72	5.09	8,320
EPDREH4015-5-005-TH3	●							5	0.9	1.44	50	4	7.33	5.28	5.46	5.66	5.87	6.34	8,320
EPDREH4015-6-005-TH3	●	6	0.9	1.44				50	4	6.65	6.31	6.53	6.76	7.02	7.58	8,320			
EPDREH4015-8-005-TH3	●	8	0.9	1.44				50	4	5.61	8.38	8.67	8.98	9.32	10.07	8,820			
EPDREH4015-10-005-TH3	●	10	0.9	1.44	50	4	4.86	10.45	10.81	11.20	11.61	12.55	8,820						
EPDREH4015-12-005-TH3	●	12	0.9	1.44	50	4	4.28	12.51	12.95	13.41	13.91	15.04	8,820						
EPDREH4015-2-01-TH3	●	0.1	1.5	0.1	2	0.9	1.44	50	4	10.61	2.17	2.25	2.33	2.41	2.60	8,320			
EPDREH4015-3-01-TH3	●				3	0.9	1.44	50	4	9.25	3.21	3.32	3.43	3.56	3.84	8,320			
EPDREH4015-4-01-TH3	●				4	0.9	1.44	50	4	8.20	4.24	4.39	4.54	4.71	5.08	8,320			
EPDREH4015-5-01-TH3	●				5	0.9	1.44	50	4	7.37	5.28	5.46	5.65	5.86	6.33	8,320			
EPDREH4015-6-01-TH3	●				6	0.9	1.44	50	4	6.68	6.31	6.53	6.76	7.01	7.57	8,320			
EPDREH4015-8-01-TH3	●				8	0.9	1.44	50	4	5.64	8.38	8.67	8.97	9.31	10.06	8,820			
EPDREH4015-10-01-TH3	●				10	0.9	1.44	50	4	4.87	10.44	10.80	11.19	11.61	12.54	8,820			
EPDREH4015-12-01-TH3	●				12	0.9	1.44	50	4	4.29	12.51	12.94	13.41	13.91	15.03	8,820			
EPDREH4015-2-02-TH3	●				0.2	1.5	0.2	2	0.9	1.44	50	4	10.77	2.17	2.24	2.31	2.39	2.57	8,320
EPDREH4015-3-02-TH3	●							3	0.9	1.44	50	4	9.37	3.21	3.31	3.42	3.54	3.82	8,320
EPDREH4015-4-02-TH3	●							4	0.9	1.44	50	4	8.30	4.24	4.38	4.53	4.69	5.06	8,320
EPDREH4015-5-02-TH3	●							5	0.9	1.44	50	4	7.44	5.27	5.45	5.64	5.84	6.30	8,320
EPDREH4015-6-02-TH3	●	6	0.9	1.44				50	4	6.74	6.31	6.52	6.75	6.99	7.55	8,320			
EPDREH4015-8-02-TH3	●	8	0.9	1.44				50	4	5.68	8.37	8.66	8.96	9.29	10.03	8,820			
EPDREH4015-10-02-TH3	●	10	0.9	1.44	50	4	4.91	10.44	10.80	11.18	11.59	12.52	8,820						
EPDREH4015-12-02-TH3	●	12	0.9	1.44	50	4	4.32	12.51	12.94	13.40	13.89	15.00	8,820						
EPDREH4015-2-03-TH3	●	0.3	1.5	0.3	2	0.9	1.44	50	4	10.93	2.17	2.23	2.30	2.38	2.55	8,320			
EPDREH4015-3-03-TH3	●				3	0.9	1.44	50	4	9.50	3.20	3.30	3.41	3.53	3.79	8,320			
EPDREH4015-4-03-TH3	●				4	0.9	1.44	50	4	8.39	4.24	4.37	4.52	4.68	5.04	8,320			
EPDREH4015-5-03-TH3	●				5	0.9	1.44	50	4	7.52	5.27	5.44	5.63	5.83	6.28	8,320			
EPDREH4015-6-03-TH3	●				6	0.9	1.44	50	4	6.81	6.30	6.51	6.74	6.98	7.52	8,320			
EPDREH4015-8-03-TH3	●				8	0.9	1.44	50	4	5.73	8.37	8.65	8.95	9.28	10.01	8,820			
EPDREH4015-10-03-TH3	●	10	0.9	1.44	50	4	4.94	10.44	10.79	11.17	11.58	12.49	8,820						
EPDREH4015-12-03-TH3	●	12	0.9	1.44	50	4	4.34	12.50	12.93	13.39	13.88	14.98	8,820						

EPDREH4 ϕ 1 ~ ϕ 1.5の切削条件はA184, A185, A189, A190ページをご確認ください。 For detailed information on the EPDREH4 ϕ 1 to ϕ 1.5 cutting conditions, refer to pages A184, A185, A189 and A190.

エポックディープラジラスエボリューションハード-TH3

EPDREH4○○○-○.○-○○○-TH3

超ミクロン加工

商品コード Item code	在庫 Stock	寸法 Size(mm)							干渉角度 Interference angle (°) θ_K	勾配角に対する実有効首下長 Effective under neck length with respect to draft angle					希望小売 価格(円) Suggested retail price (¥)	
		外径 Tool dia.	コーナ半径 Corner radius	首下長 Under neck length	刃長 Flute length	首径 Neck dia.	全長 Overall length	シャンク径 Shank dia.								
		DC	RE	LU	APMX	DN	LF	DCONMS		0.5°	1°	1.5°	2°	3°		
EPDREH4015-2-05-TH3	●	1.5	0.5	2	0.9	1.44	50	4	11.27	2.16	2.22	2.28	2.35	2.50	8,320	
EPDREH4015-3-05-TH3	●			3	0.9	1.44	50	4	9.75	3.19	3.29	3.39	3.50	3.75	8,320	
EPDREH4015-4-05-TH3	●			4	0.9	1.44	50	4	8.59	4.23	4.36	4.50	4.65	4.99	8,320	
EPDREH4015-5-05-TH3	●			5	0.9	1.44	50	4	7.68	5.26	5.43	5.61	5.80	6.23	8,320	
EPDREH4015-6-05-TH3	●			6	0.9	1.44	50	4	6.94	6.30	6.50	6.72	6.95	7.47	8,320	
EPDREH4015-8-05-TH3	●			8	0.9	1.44	50	4	5.82	8.36	8.64	8.93	9.25	9.96	8,820	
EPDREH4015-10-05-TH3	●			10	0.9	1.44	50	4	5.01	10.43	10.78	11.15	11.55	12.45	8,820	
EPDREH4015-12-05-TH3	●			12	0.9	1.44	50	4	4.40	12.50	12.92	13.37	13.85	14.93	8,820	
EPDREH4020-2.5-002-TH3	●	2	0.02	2.5	1.2	1.92	50	4	8.94	2.73	2.83	2.93	3.04	3.28	8,320	
EPDREH4020-3-002-TH3	●			3	1.2	1.92	50	4	8.30	3.25	3.36	3.48	3.61	3.91	8,320	
EPDREH4020-4-002-TH3	●			4	1.2	1.92	50	4	7.25	4.28	4.43	4.59	4.76	5.15	8,320	
EPDREH4020-5-002-TH3	●			5	1.2	1.92	50	4	6.44	5.32	5.50	5.70	5.91	6.39	8,320	
EPDREH4020-6-002-TH3	●			6	1.2	1.92	50	4	5.80	6.35	6.57	6.81	7.06	7.63	8,320	
EPDREH4020-8-002-TH3	●			8	1.2	1.92	50	4	4.82	8.42	8.71	9.02	9.36	10.12	8,820	
EPDREH4020-10-002-TH3	●			10	1.2	1.92	50	4	4.13	10.49	10.85	11.24	11.66	12.61	8,820	
EPDREH4020-12-002-TH3	●			12	1.2	1.92	50	4	3.61	12.55	12.99	13.46	13.96	15.09	8,820	
EPDREH4020-2.5-005-TH3	●			0.05	2.5	1.2	1.92	50	4	8.98	2.73	2.83	2.93	3.03	3.28	8,320
EPDREH4020-3-005-TH3	●				3	1.2	1.92	50	4	8.33	3.25	3.36	3.48	3.61	3.90	8,320
EPDREH4020-4-005-TH3	●				4	1.2	1.92	50	4	7.28	4.28	4.43	4.59	4.76	5.14	8,320
EPDREH4020-5-005-TH3	●				5	1.2	1.92	50	4	6.47	5.32	5.50	5.70	5.91	6.38	8,320
EPDREH4020-6-005-TH3	●		6		1.2	1.92	50	4	5.81	6.35	6.57	6.80	7.06	7.63	8,320	
EPDREH4020-8-005-TH3	●		8		1.2	1.92	50	4	4.84	8.42	8.71	9.02	9.36	10.11	8,820	
EPDREH4020-10-005-TH3	●		10		1.2	1.92	50	4	4.14	10.48	10.85	11.24	11.66	12.60	8,820	
EPDREH4020-12-005-TH3	●		12		1.2	1.92	50	4	3.62	12.55	12.99	13.45	13.96	15.09	8,820	
EPDREH4020-2.5-01-TH3	●		0.1		2.5	1.2	1.92	50	4	9.05	2.73	2.82	2.92	3.03	3.26	8,320
EPDREH4020-3-01-TH3	●				3	1.2	1.92	50	4	8.39	3.25	3.36	3.47	3.60	3.89	8,320
EPDREH4020-4-01-TH3	●				4	1.2	1.92	50	4	7.33	4.28	4.43	4.58	4.75	5.13	8,320
EPDREH4020-5-01-TH3	●				5	1.2	1.92	50	4	6.50	5.31	5.50	5.69	5.90	6.37	8,320
EPDREH4020-6-01-TH3	●			6	1.2	1.92	50	4	5.84	6.35	6.57	6.80	7.05	7.62	8,320	
EPDREH4020-8-01-TH3	●			8	1.2	1.92	50	4	4.86	8.42	8.71	9.02	9.35	10.10	8,820	
EPDREH4020-10-01-TH3	●			10	1.2	1.92	50	4	4.16	10.48	10.84	11.23	11.65	12.59	8,820	
EPDREH4020-12-01-TH3	●			12	1.2	1.92	50	4	3.63	12.55	12.98	13.45	13.95	15.07	8,820	
EPDREH4020-2.5-02-TH3	●			0.2	2.5	1.2	1.92	50	4	9.19	2.73	2.82	2.91	3.01	3.24	8,320
EPDREH4020-3-02-TH3	●				3	1.2	1.92	50	4	8.52	3.24	3.35	3.46	3.59	3.86	8,320
EPDREH4020-4-02-TH3	●				4	1.2	1.92	50	4	7.42	4.28	4.42	4.57	4.74	5.11	8,320
EPDREH4020-5-02-TH3	●				5	1.2	1.92	50	4	6.58	5.31	5.49	5.68	5.89	6.35	8,320
EPDREH4020-6-02-TH3	●		6		1.2	1.92	50	4	5.90	6.34	6.56	6.79	7.04	7.59	8,320	
EPDREH4020-8-02-TH3	●		8		1.2	1.92	50	4	4.90	8.41	8.70	9.01	9.34	10.08	8,820	
EPDREH4020-10-02-TH3	●		10		1.2	1.92	50	4	4.19	10.48	10.84	11.22	11.64	12.56	8,820	
EPDREH4020-12-02-TH3	●		12		1.2	1.92	50	4	3.65	12.55	12.98	13.44	13.94	15.05	8,820	
EPDREH4020-2.5-03-TH3	●		0.3		2.5	1.2	1.92	50	4	9.34	2.72	2.81	2.90	3.00	3.22	8,320
EPDREH4020-3-03-TH3	●				3	1.2	1.92	50	4	8.64	3.24	3.34	3.45	3.57	3.84	8,320
EPDREH4020-4-03-TH3	●				4	1.2	1.92	50	4	7.52	4.27	4.41	4.56	4.72	5.08	8,320
EPDREH4020-5-03-TH3	●				5	1.2	1.92	50	4	6.65	5.31	5.48	5.67	5.87	6.33	8,320
EPDREH4020-6-03-TH3	●			6	1.2	1.92	50	4	5.96	6.34	6.55	6.78	7.02	7.57	8,320	
EPDREH4020-8-03-TH3	●			8	1.2	1.92	50	4	4.94	8.41	8.69	8.99	9.32	10.05	8,820	
EPDREH4020-10-03-TH3	●			10	1.2	1.92	50	4	4.22	10.48	10.83	11.21	11.62	12.54	8,820	
EPDREH4020-12-03-TH3	●			12	1.2	1.92	50	4	3.68	12.54	12.97	13.43	13.92	15.03	8,820	
EPDREH4020-2.5-05-TH3	●			0.5	2.5	1.2	1.92	50	4	9.65	2.72	2.79	2.88	2.97	3.17	8,320
EPDREH4020-3-05-TH3	●				3	1.2	1.92	50	4	8.91	3.23	3.33	3.43	3.54	3.79	8,320
EPDREH4020-4-05-TH3	●				4	1.2	1.92	50	4	7.72	4.27	4.40	4.54	4.69	5.03	8,320

●印：標準在庫品です。 ●：Stocked items.

EPDREH4-TH3

商品コード Item code	在庫 Stock	寸法 Size(mm)							干渉角度 Interference angle (°) θ_K	勾配角に対する実有効首下長 Effective under neck length with respect to draft angle					希望小売 価格(円) Suggested retail price (¥)
		外径 Tool dia.	コーナ半径 Corner radius	首下長 Under neck length	刃長 Flute length	首径 Neck dia.	全長 Overall length	シャンク径 Shank dia.		0.5°	1°	1.5°	2°	3°	
		DC	RE	LU	APMX	DN	LF	DCONMS							
EPDREH4020-5-05-TH3	●	2	0.5	5	1.2	1.92	50	4	6.81	5.30	5.47	5.65	5.84	6.28	8,320
EPDREH4020-6-05-TH3	●			6	1.2	1.92	50	4	6.09	6.33	6.54	6.76	6.99	7.52	8,320
EPDREH4020-8-05-TH3	●			8	1.2	1.92	50	4	5.03	8.40	8.68	8.97	9.29	10.01	8,820
EPDREH4020-10-05-TH3	●			10	1.2	1.92	50	4	4.28	10.47	10.82	11.19	11.59	12.49	8,820
EPDREH4020-12-05-TH3	●			12	1.2	1.92	50	4	3.72	12.54	12.96	13.41	13.89	14.98	8,820
EPDREH4030-4-005-TH3	●	0.05	4	1.8	2.88	50	6	8.73	4.36	4.51	4.67	4.84	5.23	8,320	
EPDREH4030-6-005-TH3	●		6	1.8	2.88	50	6	7.27	6.43	6.65	6.89	7.14	7.72	8,320	
EPDREH4030-8-005-TH3	●		8	1.8	2.88	55	6	6.22	8.49	8.79	9.10	9.44	10.21	8,320	
EPDREH4030-10-005-TH3	●		10	1.8	2.88	55	6	5.44	10.56	10.93	11.32	11.74	12.69	9,080	
EPDREH4030-12-005-TH3	●		12	1.8	2.88	60	6	4.83	12.63	13.07	13.54	14.04	15.18	9,080	
EPDREH4030-14-005-TH3	●		14	1.8	2.88	60	6	4.34	14.70	15.21	15.75	16.34	17.67	10,210	
EPDREH4030-16-005-TH3	●		16	1.8	2.88	60	6	3.95	16.76	17.35	17.97	18.64	20.15	10,210	
EPDREH4030-18-005-TH3	●		18	1.8	2.88	65	6	3.62	18.83	19.49	20.19	20.94	22.64	10,210	
EPDREH4030-20-005-TH3	●		20	1.8	2.88	65	6	3.34	20.90	21.62	22.40	23.24	25.12	10,210	
EPDREH4030-4-01-TH3	●		0.1	4	1.8	2.88	50	6	8.78	4.36	4.51	4.67	4.84	5.22	8,320
EPDREH4030-6-01-TH3	●	6		1.8	2.88	50	6	7.30	6.43	6.65	6.88	7.14	7.71	8,320	
EPDREH4030-8-01-TH3	●	8		1.8	2.88	55	6	6.24	8.49	8.79	9.10	9.44	10.19	8,320	
EPDREH4030-10-01-TH3	●	10		1.8	2.88	55	6	5.45	10.56	10.92	11.32	11.74	12.68	9,080	
EPDREH4030-12-01-TH3	●	12		1.8	2.88	60	6	4.84	12.63	13.06	13.53	14.04	15.17	9,080	
EPDREH4030-14-01-TH3	●	14		1.8	2.88	60	6	4.35	14.69	15.20	15.75	16.34	17.65	10,210	
EPDREH4030-16-01-TH3	●	16		1.8	2.88	60	6	3.96	16.76	17.34	17.97	18.64	20.14	10,210	
EPDREH4030-18-01-TH3	●	18		1.8	2.88	65	6	3.62	18.83	19.48	20.18	20.94	22.63	10,210	
EPDREH4030-20-01-TH3	●	20		1.8	2.88	65	6	3.34	20.90	21.62	22.40	23.23	25.11	10,210	
EPDREH4030-4-02-TH3	●	0.2		4	1.8	2.88	50	6	8.87	4.35	4.50	4.66	4.82	5.20	8,320
EPDREH4030-6-02-TH3	●		6	1.8	2.88	50	6	7.36	6.42	6.64	6.87	7.12	7.68	8,320	
EPDREH4030-8-02-TH3	●		8	1.8	2.88	55	6	6.29	8.49	8.78	9.09	9.42	10.17	8,320	
EPDREH4030-10-02-TH3	●		10	1.8	2.88	55	6	5.49	10.56	10.92	11.30	11.72	12.66	9,080	
EPDREH4030-12-02-TH3	●		12	1.8	2.88	60	6	4.87	12.62	13.06	13.52	14.02	15.14	9,080	
EPDREH4030-14-02-TH3	●		14	1.8	2.88	60	6	4.38	14.69	15.20	15.74	16.32	17.63	10,210	
EPDREH4030-16-02-TH3	●		16	1.8	2.88	60	6	3.97	16.76	17.34	17.95	18.62	20.12	10,210	
EPDREH4030-18-02-TH3	●		18	1.8	2.88	65	6	3.64	18.83	19.47	20.17	20.92	22.60	10,210	
EPDREH4030-20-02-TH3	●		20	1.8	2.88	65	6	3.36	20.89	21.61	22.39	23.22	25.09	10,210	
EPDREH4030-4-03-TH3	●		0.3	4	1.8	2.88	50	6	8.96	4.35	4.49	4.64	4.81	5.17	8,320
EPDREH4030-6-03-TH3	●	6		1.8	2.88	50	6	7.42	6.42	6.63	6.86	7.11	7.66	8,320	
EPDREH4030-8-03-TH3	●	8		1.8	2.88	55	6	6.33	8.49	8.77	9.08	9.41	10.15	8,320	
EPDREH4030-10-03-TH3	●	10		1.8	2.88	55	6	5.52	10.55	10.91	11.29	11.71	12.63	9,080	
EPDREH4030-12-03-TH3	●	12		1.8	2.88	60	6	4.90	12.62	13.05	13.51	14.01	15.12	9,080	
EPDREH4030-14-03-TH3	●	14		1.8	2.88	60	6	4.40	14.69	15.19	15.73	16.31	17.61	10,210	
EPDREH4030-16-03-TH3	●	16		1.8	2.88	60	6	3.99	16.76	17.33	17.94	18.61	20.09	10,210	
EPDREH4030-18-03-TH3	●	18		1.8	2.88	65	6	3.65	18.82	19.47	20.16	20.91	22.58	10,210	
EPDREH4030-20-03-TH3	●	20		1.8	2.88	65	6	3.37	20.89	21.61	22.38	23.21	25.07	10,210	
EPDREH4030-4-05-TH3	●	0.5		4	1.8	2.88	50	6	9.15	4.34	4.48	4.62	4.78	5.13	8,320
EPDREH4030-6-05-TH3	●		6	1.8	2.88	50	6	7.55	6.41	6.62	6.84	7.08	7.61	8,320	
EPDREH4030-8-05-TH3	●		8	1.8	2.88	55	6	6.43	8.48	8.76	9.06	9.38	10.10	8,320	
EPDREH4030-10-05-TH3	●		10	1.8	2.88	55	6	5.60	10.55	10.90	11.27	11.68	12.59	9,080	
EPDREH4030-12-05-TH3	●		12	1.8	2.88	60	6	4.95	12.61	13.04	13.49	13.98	15.07	9,080	
EPDREH4030-14-05-TH3	●		14	1.8	2.88	60	6	4.44	14.68	15.18	15.71	16.28	17.56	10,210	
EPDREH4030-16-05-TH3	●		16	1.8	2.88	60	6	4.03	16.75	17.31	17.92	18.58	20.05	10,210	
EPDREH4030-18-05-TH3	●		18	1.8	2.88	65	6	3.69	18.82	19.45	20.14	20.88	22.53	10,210	
EPDREH4030-20-05-TH3	●		20	1.8	2.88	65	6	3.40	20.88	21.59	22.36	23.18	25.02	10,210	

EPDREH4 φ1.5~φ3の切削条件はA184~A186、A189~A191ページをご確認ください。For detailed information on the EPDREH4 φ1.5 to φ3 cutting conditions, refer to pages A184 to A186 and A189 to A191.

エポックディープライアスエボリューションハード-TH3

EPDREH4○○○-○○○-○○○-TH3

超ミクロン加工

商品コード Item code	在庫 Stock	寸法 Size(mm)							干渉角度 Interference angle (°)	勾配角に対する実有効首下長 Effective under neck length with respect to draft angle					希望小売 価格(円) Suggested retail price (¥)	
		外径 Tool dia.	コーナ半径 Corner radius	首下長 Under neck length	刃長 Flute length	首径 Neck dia.	全長 Overall length	シャンク径 Shank dia.		0.5°	1°	1.5°	2°	3°		
		DC	RE	LU	APMX	DN	LF	DCONMS								
EPDREH4040-8-01-TH3	●	4	0.1	8	3.5	3.85	55	6	4.80	8.55	8.84	9.16	9.50	10.26	11,340	
EPDREH4040-10-01-TH3	●			10	3.5	3.85	60	6	4.12	10.62	10.98	11.38	11.80	12.75	11,340	
EPDREH4040-12-01-TH3	●			12	3.5	3.85	60	6	3.60	12.68	13.12	13.59	14.10	15.24	11,340	
EPDREH4040-14-01-TH3	●			14	3.5	3.85	60	6	3.20	14.75	15.26	15.81	16.40	17.72	11,340	
EPDREH4040-16-01-TH3	●			16	3.5	3.85	60	6	2.88	16.82	17.40	18.03	18.70	干涉なし	11,340	
EPDREH4040-18-01-TH3	●			18	3.5	3.85	60	6	2.62	18.89	19.54	20.24	21.00	干涉なし	12,600	
EPDREH4040-20-01-TH3	●			20	3.5	3.85	65	6	2.40	20.95	21.68	22.46	23.30	干涉なし	12,600	
EPDREH4040-22-01-TH3	●			22	3.5	3.85	65	6	2.22	23.02	23.82	24.68	25.60	干涉なし	12,600	
EPDREH4040-24-01-TH3	●			24	3.5	3.85	70	6	2.06	25.09	25.96	26.89	27.90	干涉なし	12,600	
EPDREH4040-8-02-TH3	●			0.2	8	3.5	3.85	55	6	4.84	8.55	8.84	9.15	9.49	10.24	11,340
EPDREH4040-10-02-TH3	●				10	3.5	3.85	60	6	4.15	10.61	10.98	11.37	11.79	12.73	11,340
EPDREH4040-12-02-TH3	●				12	3.5	3.85	60	6	3.62	12.68	13.12	13.58	14.09	15.21	11,340
EPDREH4040-14-02-TH3	●		14		3.5	3.85	60	6	3.22	14.75	15.26	15.80	16.39	17.70	11,340	
EPDREH4040-16-02-TH3	●		16		3.5	3.85	60	6	2.89	16.82	17.40	18.02	18.69	干涉なし	11,340	
EPDREH4040-18-02-TH3	●		18		3.5	3.85	60	6	2.63	18.88	19.53	20.23	20.98	干涉なし	12,600	
EPDREH4040-20-02-TH3	●		20		3.5	3.85	65	6	2.41	20.95	21.67	22.45	23.28	干涉なし	12,600	
EPDREH4040-22-02-TH3	●		22		3.5	3.85	65	6	2.22	23.02	23.81	24.67	25.58	干涉なし	12,600	
EPDREH4040-24-02-TH3	●		24		3.5	3.85	70	6	2.06	25.09	25.95	26.88	27.88	干涉なし	12,600	
EPDREH4040-8-03-TH3	●		0.3		8	3.5	3.85	55	6	4.89	8.54	8.83	9.14	9.47	10.22	11,340
EPDREH4040-10-03-TH3	●				10	3.5	3.85	60	6	4.18	10.61	10.97	11.36	11.77	12.70	11,340
EPDREH4040-12-03-TH3	●				12	3.5	3.85	60	6	3.65	12.68	13.11	13.57	14.07	15.19	11,340
EPDREH4040-14-03-TH3	●			14	3.5	3.85	60	6	3.24	14.75	15.25	15.79	16.37	17.68	11,340	
EPDREH4040-16-03-TH3	●			16	3.5	3.85	60	6	2.91	16.81	17.39	18.01	18.67	干涉なし	11,340	
EPDREH4040-18-03-TH3	●			18	3.5	3.85	60	6	2.64	18.88	19.53	20.22	20.97	干涉なし	12,600	
EPDREH4040-20-03-TH3	●	20		3.5	3.85	65	6	2.42	20.95	21.67	22.44	23.27	干涉なし	12,600		
EPDREH4040-22-03-TH3	●	22		3.5	3.85	65	6	2.23	23.01	23.81	24.66	25.57	干涉なし	12,600		
EPDREH4040-24-03-TH3	●	24		3.5	3.85	70	6	2.07	25.08	25.95	26.87	27.87	干涉なし	12,600		
EPDREH4040-8-05-TH3	●	0.5		8	3.5	3.85	55	6	4.97	8.54	8.82	9.12	9.44	10.17	11,340	
EPDREH4040-10-05-TH3	●			10	3.5	3.85	60	6	4.24	10.60	10.96	11.33	11.74	12.66	11,340	
EPDREH4040-12-05-TH3	●			12	3.5	3.85	60	6	3.69	12.67	13.10	13.55	14.04	15.14	11,340	
EPDREH4040-14-05-TH3	●		14	3.5	3.85	60	6	3.27	14.74	15.24	15.77	16.34	17.63	11,340		
EPDREH4040-16-05-TH3	●		16	3.5	3.85	60	6	2.94	16.81	17.37	17.98	18.64	干涉なし	11,340		
EPDREH4040-18-05-TH3	●		18	3.5	3.85	60	6	2.67	18.87	19.51	20.20	20.94	干涉なし	12,600		
EPDREH4040-20-05-TH3	●		20	3.5	3.85	65	6	2.44	20.94	21.65	22.42	23.24	干涉なし	12,600		
EPDREH4040-22-05-TH3	●		22	3.5	3.85	65	6	2.25	23.01	23.79	24.63	25.54	干涉なし	12,600		
EPDREH4040-24-05-TH3	●		24	3.5	3.85	70	6	2.09	25.08	25.93	26.85	27.84	干涉なし	12,600		
EPDREH4040-8-10-TH3	●		1	8	3.5	3.85	55	6	5.19	8.52	8.78	9.06	9.37	10.05	11,340	
EPDREH4040-10-10-TH3	●			10	3.5	3.85	60	6	4.40	10.59	10.92	11.28	11.67	12.54	11,340	
EPDREH4040-12-10-TH3	●			12	3.5	3.85	60	6	3.82	12.65	13.06	13.50	13.97	15.02	11,340	
EPDREH4040-14-10-TH3	●	14		3.5	3.85	60	6	3.37	14.72	15.20	15.71	16.27	17.51	11,340		
EPDREH4040-16-10-TH3	●	16		3.5	3.85	60	6	3.02	16.79	17.34	17.93	18.57	20.00	11,340		
EPDREH4040-18-10-TH3	●	18		3.5	3.85	60	6	2.73	18.86	19.48	20.15	20.87	干涉なし	12,600		
EPDREH4040-20-10-TH3	●	20		3.5	3.85	65	6	2.49	20.92	21.62	22.36	23.17	干涉なし	12,600		
EPDREH4040-22-10-TH3	●	22		3.5	3.85	65	6	2.29	22.99	23.76	24.58	25.47	干涉なし	12,600		
EPDREH4040-24-10-TH3	●	24		3.5	3.85	70	6	2.13	25.06	25.90	26.80	27.77	干涉なし	12,600		
EPDREH4050-10-01-TH3	●	5		0.1	10	4	4.85	60	6	2.38	10.62	10.98	11.38	11.80	干涉なし	16,900
EPDREH4050-15-01-TH3	●				15	4	4.85	60	6	1.69	15.79	16.33	16.92	干涉なし	干涉なし	16,900
EPDREH4050-20-01-TH3	●				20	4	4.85	65	6	1.30	20.95	21.68	干涉なし	干涉なし	干涉なし	16,900
EPDREH4050-25-01-TH3	●		25	4	4.85	70	6	1.06	26.12	27.03	干涉なし	干涉なし	干涉なし	16,900		
EPDREH4050-10-02-TH3	●		0.2	10	4	4.85	60	6	2.40	10.61	10.98	11.37	11.79	干涉なし	16,900	
EPDREH4050-15-02-TH3	●			15	4	4.85	60	6	1.70	15.78	16.33	16.91	干涉なし	干涉なし	16,900	

●印：標準在庫品です。 ●：Stocked items. 干涉なし：No interference

EPDREH4-TH3

商品コード Item code	在庫 Stock	寸法 Size(mm)							干渉角度 Interference angle (°)	勾配角に対する実有効首下長 Effective under neck length with respect to draft angle					希望小売 価格(円) Suggested retail price (¥)
		外径 Tool dia.	コーナ半径 Corner radius	首下長 Under neck length	刃長 Flute length	首径 Neck dia.	全長 Overall length	シャンク径 Shank dia.		0.5°	1°	1.5°	2°	3°	
		DC	RE	LU	APMX	DN	LF	DCONMS							
EPDREH4050-20-02-TH3	●	5	0.2	20	4	4.85	65	6	1.31	20.95	21.67	干渉なし	干渉なし	干渉なし	16,900
EPDREH4050-25-02-TH3	●			25	4	4.85	70	6	1.07	26.12	27.02	干渉なし	干渉なし	干渉なし	16,900
EPDREH4050-10-03-TH3	●		0.3	10	4	4.85	60	6	2.42	10.61	10.97	11.36	11.77	干渉なし	16,900
EPDREH4050-15-03-TH3	●			15	4	4.85	60	6	1.71	15.78	16.32	16.90	干渉なし	干渉なし	16,900
EPDREH4050-20-03-TH3	●			20	4	4.85	65	6	1.32	20.95	21.67	干渉なし	干渉なし	干渉なし	16,900
EPDREH4050-25-03-TH3	●			25	4	4.85	70	6	1.07	26.12	27.02	干渉なし	干渉なし	干渉なし	16,900
EPDREH4050-10-05-TH3	●		0.5	10	4	4.85	60	6	2.46	10.60	10.96	11.33	11.74	干渉なし	16,900
EPDREH4050-15-05-TH3	●			15	4	4.85	60	6	1.73	15.77	16.31	16.88	干渉なし	干渉なし	16,900
EPDREH4050-20-05-TH3	●			20	4	4.85	65	6	1.33	20.94	21.65	干渉なし	干渉なし	干渉なし	16,900
EPDREH4050-25-05-TH3	●			25	4	4.85	70	6	1.08	26.11	27.00	干渉なし	干渉なし	干渉なし	16,900
EPDREH4050-10-10-TH3	●		1	10	4	4.85	60	6	2.57	10.59	10.92	11.28	11.67	干渉なし	16,900
EPDREH4050-15-10-TH3	●			15	4	4.85	60	6	1.78	15.76	16.27	16.82	干渉なし	干渉なし	16,900
EPDREH4050-20-10-TH3	●			20	4	4.85	65	6	1.36	20.92	21.62	干渉なし	干渉なし	干渉なし	16,900
EPDREH4050-25-10-TH3	●			25	4	4.85	70	6	1.10	26.09	26.97	干渉なし	干渉なし	干渉なし	16,900
EPDREH4060-12-01-TH3	●	6	0.1	12	5	5.85	60	6	0.00	干渉なし	干渉なし	干渉なし	干渉なし	干渉なし	12,360
EPDREH4060-18-01-TH3	●			18	5	5.85	60	6	0.00	干渉なし	干渉なし	干渉なし	干渉なし	干渉なし	15,690
EPDREH4060-24-01-TH3	●			24	5	5.85	70	6	0.00	干渉なし	干渉なし	干渉なし	干渉なし	干渉なし	15,690
EPDREH4060-30-01-TH3	●			30	5	5.85	80	6	0.00	干渉なし	干渉なし	干渉なし	干渉なし	干渉なし	15,690
EPDREH4060-12-02-TH3	●		0.2	12	5	5.85	60	6	0.00	干渉なし	干渉なし	干渉なし	干渉なし	干渉なし	12,360
EPDREH4060-18-02-TH3	●			18	5	5.85	60	6	0.00	干渉なし	干渉なし	干渉なし	干渉なし	干渉なし	15,690
EPDREH4060-24-02-TH3	●			24	5	5.85	70	6	0.00	干渉なし	干渉なし	干渉なし	干渉なし	干渉なし	15,690
EPDREH4060-30-02-TH3	●			30	5	5.85	80	6	0.00	干渉なし	干渉なし	干渉なし	干渉なし	干渉なし	15,690
EPDREH4060-12-03-TH3	●		0.3	12	5	5.85	60	6	0.00	干渉なし	干渉なし	干渉なし	干渉なし	干渉なし	12,360
EPDREH4060-18-03-TH3	●			18	5	5.85	60	6	0.00	干渉なし	干渉なし	干渉なし	干渉なし	干渉なし	15,690
EPDREH4060-24-03-TH3	●			24	5	5.85	70	6	0.00	干渉なし	干渉なし	干渉なし	干渉なし	干渉なし	15,690
EPDREH4060-30-03-TH3	●			30	5	5.85	80	6	0.00	干渉なし	干渉なし	干渉なし	干渉なし	干渉なし	15,690
EPDREH4060-12-05-TH3	●		0.5	12	5	5.85	60	6	0.00	干渉なし	干渉なし	干渉なし	干渉なし	干渉なし	12,360
EPDREH4060-18-05-TH3	●			18	5	5.85	60	6	0.00	干渉なし	干渉なし	干渉なし	干渉なし	干渉なし	15,690
EPDREH4060-24-05-TH3	●			24	5	5.85	70	6	0.00	干渉なし	干渉なし	干渉なし	干渉なし	干渉なし	15,690
EPDREH4060-30-05-TH3	●			30	5	5.85	80	6	0.00	干渉なし	干渉なし	干渉なし	干渉なし	干渉なし	15,690
EPDREH4060-12-10-TH3	●		1	12	5	5.85	60	6	0.00	干渉なし	干渉なし	干渉なし	干渉なし	干渉なし	12,360
EPDREH4060-18-10-TH3	●			18	5	5.85	60	6	0.00	干渉なし	干渉なし	干渉なし	干渉なし	干渉なし	15,690
EPDREH4060-24-10-TH3	●			24	5	5.85	70	6	0.00	干渉なし	干渉なし	干渉なし	干渉なし	干渉なし	15,690
EPDREH4060-30-10-TH3	●			30	5	5.85	80	6	0.00	干渉なし	干渉なし	干渉なし	干渉なし	干渉なし	15,690

EPDREH4 φ4,5,6の切削条件はA187, A188, A192, A193ページをご確認ください。For detailed information on the EPDREH4 φ5 and φ6 cutting conditions, refer to pages A187, A188, A192 and A193.

○ 対応被削材 Applicable work material

炭素鋼 合金鋼 Carbon steel Alloy steel	プリハー ド鋼 Pre-hardened steel ≤ 45HRC	高硬度 Hardened steel			ステン レス鋼 Stainless steel	チタン合金 耐熱合金 Titanium alloy Heat-resistant alloy	銅合金 Copper alloy	アルミ 合金 Aluminum alloy
		> 45HRC ≤ 55HRC	> 55HRC ≤ 65HRC	> 65HRC				
○	○	◎	◎	◎	○	◎	○	

○ 再研磨対応外径範囲 Re-grinding compatibility range

商品コード Item code	外周 Outer dia. (mm)	エンド End (mm)
EPDREH4-TH3	× (N/A)	4 ~ 6



標準切削条件表

Recommended cutting conditions

2枚刃
2 Flutes

高能率切削条件
High efficiency cutting conditions

高精度切削条件
High accuracy cutting conditions

EPDREH2-TH3

高精度切削条件はA182ページを参照してください。
Please refer to P.A182 about high accuracy cutting conditions

被削材 Work material				1		2		3		4		5	
				プリハードン鋼 Pre-hardened steels (35~45HRC)		焼入れ鋼 Hardened steels (45~55HRC)		焼入れ鋼 Hardened steels (55~65HRC)		焼入れ鋼 Hardened steels (65~68HRC)		焼入れ鋼 Hardened steels (68~72HRC)	
切り込み比率 Ratio to standard depth of cut				100%		85%		80%		65%		55%	
外径DC Tool dia. (mm)	コーナ半径RE Corner radius (mm)	首下長 Under neck length (mm)	ap (mm)	回転数 n min ⁻¹	送り速度 Vf mm/min	回転数 n min ⁻¹	送り速度 Vf mm/min	回転数 n min ⁻¹	送り速度 Vf mm/min	回転数 n min ⁻¹	送り速度 Vf mm/min	回転数 n min ⁻¹	送り速度 Vf mm/min
0.2	0.02	0.5	0.016	42,500	710	37,500	550	35,000	450	31,500	410	31,880	320
		1	0.011	42,500	710	37,500	550	35,000	450	31,500	410	31,880	320
	0.05	0.5	0.02	42,500	710	37,500	550	35,000	450	31,500	410	31,880	320
		1	0.014	42,500	710	37,500	550	35,000	450	31,500	410	31,880	320
0.3	0.02	1	0.016	40,800	730	36,000	550	33,600	440	30,240	400	30,600	310
		2	0.011	33,050	590	29,160	440	27,220	360	24,490	320	24,790	250
	0.05	1	0.021	40,800	730	36,000	550	33,600	440	30,240	400	30,600	310
		2	0.012	33,050	590	29,160	440	27,220	360	24,490	320	24,790	250
0.4	0.02	1	0.016	32,260	790	28,800	620	26,730	510	24,050	460	24,480	360
		2	0.013	32,260	710	28,800	560	26,730	460	24,050	410	24,480	320
	0.05	1	0.025	32,260	790	28,800	620	26,730	510	24,050	460	24,480	360
		2	0.016	32,260	710	28,800	560	26,730	460	24,050	410	24,480	320
	0.1	1	0.033	32,260	790	28,800	620	26,730	510	24,050	460	24,480	360
		2	0.028	32,260	710	28,800	560	26,730	460	24,050	410	24,480	320
0.5	0.02	1	0.016	32,260	790	28,800	620	26,730	510	24,050	460	24,480	360
		2	0.013	32,260	790	28,800	620	26,730	510	24,050	460	24,480	360
		3	0.01	26,440	630	23,330	470	21,770	380	19,600	340	19,830	270
	0.05	1	0.03	32,260	790	28,800	620	26,730	510	24,050	460	24,480	360
		2	0.023	32,260	790	28,800	620	26,730	510	24,050	460	24,480	360
		3	0.017	26,440	630	23,330	470	21,770	380	19,600	340	19,830	270
	0.1	1	0.035	32,260	790	28,800	620	26,730	510	24,050	460	24,480	360
		2	0.03	32,260	790	28,800	620	26,730	510	24,050	460	24,480	360
		3	0.02	26,440	630	23,330	470	21,770	380	19,600	340	19,830	270
0.6	0.02	2	0.016	32,260	990	28,800	770	26,730	640	24,050	570	24,480	440
		4	0.013	26,440	790	23,330	590	21,770	480	19,600	430	19,830	330
	0.05	2	0.028	32,260	990	28,800	770	26,730	640	24,050	570	24,480	440
		4	0.019	26,440	790	23,330	590	21,770	480	19,600	430	19,830	330
	0.1	2	0.035	32,260	990	28,800	770	26,730	640	24,050	570	24,480	440
		4	0.024	26,440	790	23,330	590	21,770	480	19,600	430	19,830	330
0.8	0.02	2	0.023	34,000	1,410	30,000	1,110	28,000	900	25,200	810	25,500	630
		4	0.016	34,000	1,130	30,000	890	28,000	720	25,200	650	25,500	510
	0.05	2	0.038	34,000	1,410	30,000	1,110	28,000	900	25,200	810	25,500	630
		4	0.026	34,000	1,130	30,000	890	28,000	720	25,200	650	25,500	510
	0.1	2	0.047	34,000	1,410	30,000	1,110	28,000	900	25,200	810	25,500	630
		4	0.032	34,000	1,130	30,000	890	28,000	720	25,200	650	25,500	510
	0.2	2	0.081	34,000	1,410	30,000	1,110	28,000	900	25,200	810	25,500	630
		4	0.056	34,000	1,130	30,000	890	28,000	720	25,200	650	25,500	510

超硬コーティング

リジッド

被削材 Work material				1		2		3		4		5	
				プリハードン鋼 Pre-hardened steels (35~45HRC)		焼入れ鋼 Hardened steels (45~55HRC)		焼入れ鋼 Hardened steels (55~65HRC)		焼入れ鋼 Hardened steels (65~68HRC)		焼入れ鋼 Hardened steels (68~72HRC)	
切り込み比率 Ratio to standard depth of cut				100%		85%		80%		65%		55%	
外径DC Tool dia. (mm)	コーナ半径RE Corner radius (mm)	首下長 Under neck length (mm)	a_p (mm)	回転数 n min ⁻¹	送り速度 V_f mm/min	回転数 n min ⁻¹	送り速度 V_f mm/min	回転数 n min ⁻¹	送り速度 V_f mm/min	回転数 n min ⁻¹	送り速度 V_f mm/min	回転数 n min ⁻¹	送り速度 V_f mm/min
1	0.02	2	0.016	33,440	1,810	29,620	1,420	27,710	1,160	24,940	1,050	25,170	810
		4	0.013	30,600	1,650	27,000	1,290	25,200	1,060	22,680	950	22,950	740
		6	0.01	24,790	1,340	21,870	1,050	20,410	860	18,370	770	18,590	600
		8	0.008	22,030	1,190	19,440	930	18,140	760	16,330	680	16,520	530
	0.05	2	0.046	33,440	1,810	29,620	1,420	27,710	1,160	24,940	1,050	25,170	810
		4	0.027	30,600	1,650	27,000	1,290	25,200	1,060	22,680	950	22,950	740
		6	0.017	24,790	1,340	21,870	1,050	20,410	860	18,370	770	18,590	600
		8	0.016	22,030	1,190	19,440	930	18,140	760	16,330	680	16,520	530
	0.1	2	0.065	33,440	1,810	29,620	1,420	27,710	1,160	24,940	1,050	25,170	810
		4	0.038	30,600	1,650	27,000	1,290	25,200	1,060	22,680	950	22,950	740
		6	0.024	24,790	1,340	21,870	1,050	20,410	860	18,370	770	18,590	600
		8	0.024	22,030	1,190	19,440	930	18,140	760	16,330	680	16,520	530
	0.2	2	0.11	33,440	1,810	29,620	1,420	27,710	1,160	24,940	1,050	25,170	810
		4	0.07	30,600	1,650	27,000	1,290	25,200	1,060	22,680	950	22,950	740
		6	0.04	24,790	1,340	21,870	1,050	20,410	860	18,370	770	18,590	600
		8	0.04	22,030	1,190	19,440	930	18,140	760	16,330	680	16,520	530

- (1) a_p は被削材グループ1での目安を示しています。その他のグループの場合は、上表の切り込み比率を目安に調整してください。
(2) リブ加工や止まり溝など、切りくずがつまりやすい切削の場合、切り込み設定は基本切り込み値に切り込み比率をかけて算出した切り込み量を、さらにその80%まで小さくして使用してください。
(3) a_e の設定は $a_p \times$ 切り込み比率 $\times 5$ 倍以下を目安に調整してください。仕上げ加工を行う場合、理論カスプハイトを計算し設定してください。
(4) 彫り込み時の傾斜進入角は 1° 以下を推奨いたします。また、送り速度は条件表の70%以下に調整してください。
(5) 文字彫り加工のような溝切削の際は、送り速度は50%以下・ a_p を30%以下を目安に調整してください。また往復切削による加工を推奨いたします。
- (1) a_p is shown as the criteria for Group 1 workpieces. For other groups, adjust the cutting depth according to the cutting depth factors in the above table.
(2) When performing cutting where cutting chips may cause clogging, such as for rib cutting, blind grooves, etc., cutting depth setting should be set by multiplying a cutting depth factor to calculate the cutting depth amount, and this amount should then be reduced to 80% of the calculated value.
(3) Adjust by setting a_e to $(5 \text{ or less}) \times (a_p) \times (\text{cutting depth ratio})$. When performing finishing cutting, calculate the theoretical cusp height and set accordingly.
(4) The recommended slope entrance angle when engraving is 1° or less. In addition, feed rate should be adjusted to 70% or less of the values in the cutting condition table.
(5) When slotting such engraving letters, adjust feed rate to 50% or less and a_p to 30% or less of the values shown. In addition, cutting by reciprocal cutting is recommended.

【切り込み設定例】

EPDREH2010-2-02-TH3の工具で焼入れ鋼(50HRC)をリブ溝等高線切削する場合、
切り込み $= 0.11(a_p) \times 0.85$ (焼入れ鋼グループ2の切り込み比率) $\times 0.8$ (閉鎖域の切削) $= 0.075\text{mm}$

Cutting depth setting example: When cutting rib groove contours in hardened steel (50HRC) using an EPDREH2010-2-02-TH3 tool:
Cutting depth = $0.11(a_p) \times 0.85$ (cutting depth factor for Group 2 hardened steel) $\times 0.8$ (for closed-area cutting) = 0.075mm

- 【注意】** ①被削材、加工形状に合わせて、適切なクーラントを使用してください。
②この標準切削条件表は切削条件の目安を示すものです。実際の加工では加工形状、目的、使用機械等により条件を調整してください。
③機械の回転数が足りない場合は、回転数と送り速度を同じ比率で下げてください。

- 【Note】** ① Use the appropriate coolant for the work material and machining shape.
② These Recommended Cutting Conditions indicate only the rule of a thumb for the cutting conditions. In actual machining, the condition should be adjusted according to the machining shape, purpose and the machine type.
③ If the rpm of the machine is low, lower the feed rate also to put the rpm and feed rate in the same ratio.



標準切削条件表

Recommended cutting conditions

2枚刃

2 Flutes

高能率切削条件

High efficiency cutting condition

高精度切削条件

High accuracy cutting condition

EPDREH2-TH3

高能率切削条件はA180ページを参照してください。
Please refer to P.A180 about high efficiency cutting conditions

被削材 Work material				1		2		3		4		5	
				プリハードン鋼 Pre-hardened steels (35~45HRC)		焼入れ鋼 Hardened steels (45~55HRC)		焼入れ鋼 Hardened steels (55~65HRC)		焼入れ鋼 Hardened steels (65~68HRC)		焼入れ鋼 Hardened steels (68~72HRC)	
切り込み比率 Ratio to standard depth of cut				100%		85%		80%		65%		55%	
外径DC Tool dia. (mm)	コーナ半径RE Corner radius (mm)	首下長 Under neck length (mm)	ap (mm)	回転数 n min ⁻¹	送り速度 Vf mm/min	回転数 n min ⁻¹	送り速度 Vf mm/min	回転数 n min ⁻¹	送り速度 Vf mm/min	回転数 n min ⁻¹	送り速度 Vf mm/min	回転数 n min ⁻¹	送り速度 Vf mm/min
0.2	0.02	0.5	0.016	50,000	210	50,000	180	50,000	160	45,000	140	42,500	110
		1	0.011	50,000	210	50,000	180	50,000	160	45,000	140	42,500	110
	0.05	0.5	0.02	50,000	210	50,000	180	50,000	160	45,000	140	42,500	110
		1	0.014	50,000	210	50,000	180	50,000	160	45,000	140	42,500	110
0.3	0.02	1	0.016	50,000	460	50,000	340	50,000	320	45,000	290	42,500	220
		2	0.011	45,000	420	45,000	300	45,000	290	40,500	260	38,250	200
	0.05	1	0.021	50,000	460	50,000	340	50,000	320	45,000	290	42,500	220
		2	0.012	45,000	420	45,000	300	45,000	290	40,500	260	38,250	200
0.4	0.02	1	0.016	50,000	460	40,000	320	36,000	270	32,400	240	30,600	190
		2	0.013	45,000	410	36,000	290	34,000	240	30,600	220	28,900	170
	0.05	1	0.025	50,000	460	40,000	320	36,000	270	32,400	240	30,600	190
		2	0.016	45,000	410	36,000	290	34,000	240	30,600	220	28,900	170
	0.1	1	0.033	50,000	460	40,000	320	36,000	270	32,400	240	30,600	190
		2	0.028	45,000	410	36,000	290	34,000	240	30,600	220	28,900	170
0.5	0.02	1	0.016	40,000	460	30,000	380	28,000	320	25,200	280	23,800	220
		2	0.013	40,000	460	30,000	380	28,000	320	25,200	280	23,800	220
		3	0.01	36,000	410	27,000	320	24,500	260	22,050	230	20,830	180
	0.05	1	0.03	40,000	460	30,000	380	28,000	320	25,200	280	23,800	220
		2	0.023	40,000	460	30,000	380	28,000	320	25,200	280	23,800	220
		3	0.017	36,000	410	27,000	320	24,500	260	22,050	230	20,830	180
	0.1	1	0.035	40,000	460	30,000	380	28,000	320	25,200	280	23,800	220
		2	0.03	40,000	460	30,000	380	28,000	320	25,200	280	23,800	220
		3	0.02	36,000	410	27,000	320	24,500	260	22,050	230	20,830	180
0.6	0.02	2	0.016	37,830	600	28,200	390	23,000	320	20,700	290	19,550	220
		4	0.013	27,800	440	23,600	280	21,000	230	18,900	210	17,850	160
	0.05	2	0.028	37,830	600	28,200	390	23,000	320	20,700	290	19,550	220
		4	0.019	27,800	440	23,600	280	21,000	230	18,900	210	17,850	160
	0.1	2	0.035	37,830	600	28,200	390	23,000	320	20,700	290	19,550	220
		4	0.024	27,800	440	23,600	280	21,000	230	18,900	210	17,850	160
0.8	0.02	2	0.023	28,000	650	20,000	400	20,000	360	18,000	320	17,000	250
		4	0.016	28,000	520	20,000	320	20,000	290	18,000	260	17,000	200
	0.05	2	0.038	28,000	650	20,000	400	20,000	360	18,000	320	17,000	250
		4	0.026	28,000	520	20,000	320	20,000	290	18,000	260	17,000	200
	0.1	2	0.047	28,000	650	20,000	400	20,000	360	18,000	320	17,000	250
		4	0.032	28,000	520	20,000	320	20,000	290	18,000	260	17,000	200
	0.2	2	0.081	28,000	650	20,000	400	20,000	360	18,000	320	17,000	250
		4	0.056	28,000	520	20,000	320	20,000	290	18,000	260	17,000	200

超硬コーティング

リニアガイド

被削材 Work material				1		2		3		4		5	
				プリハードン鋼 Pre-hardened steels (35~45HRC)		焼入れ鋼 Hardened steels (45~55HRC)		焼入れ鋼 Hardened steels (55~65HRC)		焼入れ鋼 Hardened steels (65~68HRC)		焼入れ鋼 Hardened steels (68~72HRC)	
切り込み比率 Ratio to standard depth of cut				100%		85%		80%		65%		55%	
外径DC Tool dia. (mm)	コーナ半径RE Corner radius (mm)	首下長 Under neck length (mm)	a_p (mm)	回転数 n min ⁻¹	送り速度 V_f mm/min	回転数 n min ⁻¹	送り速度 V_f mm/min	回転数 n min ⁻¹	送り速度 V_f mm/min	回転数 n min ⁻¹	送り速度 V_f mm/min	回転数 n min ⁻¹	送り速度 V_f mm/min
1	0.02	2	0.016	30,290	1,210	26,730	960	24,950	800	22,450	720	21,210	560
		4	0.013	27,540	1,040	24,300	820	22,680	670	20,410	600	19,280	470
		6	0.01	22,310	840	19,680	660	18,370	540	16,530	490	15,620	380
		8	0.008	19,830	750	17,500	590	16,330	480	14,700	430	13,880	340
	0.05	2	0.046	30,250	1,210	26,730	960	24,950	800	22,450	720	21,210	560
		4	0.027	28,920	1,130	24,300	820	22,680	670	20,410	600	19,280	470
		6	0.017	24,540	930	19,680	660	18,370	540	16,530	490	15,620	380
		8	0.016	19,830	750	17,500	590	16,330	480	14,700	430	13,880	340
	0.1	2	0.065	30,290	1,210	26,730	960	24,950	800	22,450	720	21,210	560
		4	0.038	27,540	1,040	24,300	820	22,680	670	20,410	600	19,280	470
		6	0.024	22,310	840	19,680	660	18,370	540	16,530	490	15,620	380
		8	0.024	19,830	750	17,500	590	16,330	480	14,700	430	13,880	340
	0.2	2	0.11	30,290	1,210	26,730	960	24,950	800	22,450	720	21,210	560
		4	0.07	27,540	1,040	24,300	820	22,680	670	20,410	600	19,280	470
		6	0.04	22,310	840	19,680	660	18,370	540	16,530	490	15,620	380
		8	0.04	19,830	750	17,500	590	16,330	480	14,700	430	13,880	340

- (1) a_p は被削材グループ1での目安を示しています。その他のグループの場合は、上表の切り込み比率を目安に調整してください。
(2) リブ加工や止まり溝など、切りくずがつまりやすい切削の場合、切り込み設定は基本切り込み値に切り込み比率をかけて算出した切り込み量を、さらにその80%まで小さくして使用してください。
(3) a_e の設定は $a_p \times$ 切り込み比率 $\times 5$ 倍以下を目安に調整してください。仕上げ加工を行う場合、理論カスプハイトを計算し設定してください。
(4) 彫り込み時の傾斜進入角は 1° 以下を推奨いたします。また、送り速度は条件表の70%以下に調整してください。
(5) 文字彫り加工のような溝切削の際は、送り速度は50%以下 $\cdot a_p$ を30%以下を目安に調整してください。また往復切削による加工を推奨いたします。
- (1) a_p is shown as the criteria for Group 1 workpieces. For other groups, adjust the cutting depth according to the cutting depth factors in the above table.
(2) When performing cutting where cutting chips may cause clogging, such as for rib cutting, blind grooves, etc., cutting depth setting should be set by multiplying a cutting depth factor to calculate the cutting depth amount, and this amount should then be reduced to 80% of the calculated value.
(3) Adjust by setting a_e to (5 or less) $\times (a_p) \times$ (cutting depth ratio). When performing finishing cutting, calculate the theoretical cusp height and set accordingly.
(4) The recommended slope entrance angle when engraving is 1° or less. In addition, feed rate should be adjusted to 70% or less of the values in the cutting condition table.
(5) When slotting such engraving letters, adjust feed rate to 50% or less and a_p to 30% or less of the values shown. In addition, cutting by reciprocal cutting is recommended.

【切り込み設定例】

EPDREH2010-2-02-TH3の工具で焼入れ鋼(50HRC)をリブ溝等高線切削する場合、
切り込み $=0.11(a_p) \times 0.85$ (焼入れ鋼グループ2の切り込み比率) $\times 0.8$ (閉鎖域の切削) $=0.075\text{mm}$

Cutting depth setting example: When cutting rib groove contours in hardened steel (50HRC) using an EPDREH2010-2-02-TH3 tool:
Cutting depth = $0.11 (a_p) \times 0.85$ (cutting depth factor for Group 2 hardened steel) $\times 0.8$ (for closed-area cutting) = 0.075mm

- 【注意】** ①被削材、加工形状に合わせて、適切なクーラントを使用してください。
②この標準切削条件表は切削条件の目安を示すものです。実際の加工では加工形状、目的、使用機械等により条件を調整してください。
③機械の回転数が足りない場合は、回転数と送り速度を同じ比率で下げてください。

- 【Note】** ① Use the appropriate coolant for the work material and machining shape.
② These Recommended Cutting Conditions indicate only the rule of a thumb for the cutting conditions. In actual machining, the condition should be adjusted according to the machining shape, purpose and the machine type.
③ If the rpm of the machine is low, lower the feed rate also to put the rpm and feed rate in the same ratio.

エポックディープラジラスエボリューションハード-TH3



標準切削条件表

Recommended cutting conditions

4枚刃

4 Flutes

高能率切削条件

High efficiency cutting conditions

高精度切削条件

High accuracy cutting conditions

EPDREH4-TH3

高精度切削条件はA189ページを参照してください。
Please refer to P.A189 about high accuracy cutting conditions

被削材 Work material				1		2		3		4		5		
				プリハードン鋼 Pre-hardened steels (35~45HRC)		焼入れ鋼 Hardened steels (45~55HRC)		焼入れ鋼 Hardened steels (55~60HRC)		焼入れ鋼 Hardened steels (60~65HRC)		焼入れ鋼 Hardened steels (65~72HRC)		
切り込み比率 Cutting depth ratio				120%		100%		70%		50%		25%		
外径DC Tool dia. (mm)	コーナ半径RE Corner radius (mm)	首下長 Under neck length (mm)	ap (mm)	回転数 n min ⁻¹	送り速度 Vf mm/min	回転数 n min ⁻¹	送り速度 Vf mm/min	回転数 n min ⁻¹	送り速度 Vf mm/min	回転数 n min ⁻¹	送り速度 Vf mm/min	回転数 n min ⁻¹	送り速度 Vf mm/min	
1	0.02	1.5	0.019	38,900	3,420	38,900	3,110	28,300	2,040	23,000	1,840	21,200	1,440	
		2	0.016	35,000	3,080	35,000	2,800	25,500	1,840	20,700	1,660	19,100	1,300	
		2.5	0.015	31,800	2,800	31,800	2,540	23,100	1,660	18,800	1,500	17,400	1,180	
		3	0.014	29,200	2,570	29,200	2,340	21,200	1,530	17,200	1,380	15,900	1,080	
		4	0.013	25,000	2,200	25,000	2,000	18,200	1,310	14,800	1,180	13,600	920	
		5	0.013	21,900	1,930	21,900	1,750	15,900	1,140	12,900	1,030	11,900	810	
		6	0.007	19,500	1,720	19,500	1,560	14,100	1,020	11,500	920	10,600	720	
		8	0.004	15,900	1,400	15,900	1,270	11,600	840	9,400	750	8,700	590	
	0.05	1.5	0.046	38,900	3,420	38,900	3,110	28,300	2,040	23,000	1,840	21,200	1,440	
		2	0.034	35,000	3,080	35,000	2,800	25,500	1,840	20,700	1,660	19,100	1,300	
		2.5	0.033	31,800	2,800	31,800	2,540	23,100	1,660	18,800	1,500	17,400	1,180	
		3	0.030	29,200	2,570	29,200	2,340	21,200	1,530	17,200	1,380	15,900	1,080	
		4	0.028	25,000	2,200	25,000	2,000	18,200	1,310	14,800	1,180	13,600	920	
		5	0.027	21,900	1,930	21,900	1,750	15,900	1,140	12,900	1,030	11,900	810	
		6	0.015	19,500	1,720	19,500	1,560	14,100	1,020	11,500	920	10,600	720	
		8	0.009	15,900	1,400	15,900	1,270	11,600	840	9,400	750	8,700	590	
	0.1	1.5	0.056	38,900	3,420	38,900	3,110	28,300	2,040	23,000	1,840	21,200	1,440	
		2	0.042	35,000	3,080	35,000	2,800	25,500	1,840	20,700	1,660	19,100	1,300	
		2.5	0.040	31,800	2,800	31,800	2,540	23,100	1,660	18,800	1,500	17,400	1,180	
		3	0.037	29,200	2,570	29,200	2,340	21,200	1,530	17,200	1,380	15,900	1,080	
		4	0.035	25,000	2,200	25,000	2,000	18,200	1,310	14,800	1,180	13,600	920	
		5	0.034	21,900	1,930	21,900	1,750	15,900	1,140	12,900	1,030	11,900	810	
		6	0.019	19,500	1,720	19,500	1,560	14,100	1,020	11,500	920	10,600	720	
		8	0.011	15,900	1,400	15,900	1,270	11,600	840	9,400	750	8,700	590	
	0.2	1.5	0.063	38,900	3,420	38,900	3,110	28,300	2,040	23,000	1,840	21,200	1,440	
		2	0.047	35,000	3,080	35,000	2,800	25,500	1,840	20,700	1,660	19,100	1,300	
		2.5	0.045	31,800	2,800	31,800	2,540	23,100	1,660	18,800	1,500	17,400	1,180	
		3	0.042	29,200	2,570	29,200	2,340	21,200	1,530	17,200	1,380	15,900	1,080	
		4	0.039	25,000	2,200	25,000	2,000	18,200	1,310	14,800	1,180	13,600	920	
		5	0.038	21,900	1,930	21,900	1,750	15,900	1,140	12,900	1,030	11,900	810	
		6	0.021	19,500	1,720	19,500	1,560	14,100	1,020	11,500	920	10,600	720	
		8	0.012	15,900	1,400	15,900	1,270	11,600	840	9,400	750	8,700	590	
	0.3	1.5	0.070	38,900	3,420	38,900	3,110	28,300	2,040	23,000	1,840	21,200	1,440	
		2	0.053	35,000	3,080	35,000	2,800	25,500	1,840	20,700	1,660	19,100	1,300	
		2.5	0.050	31,800	2,800	31,800	2,540	23,100	1,660	18,800	1,500	17,400	1,180	
		3	0.047	29,200	2,570	29,200	2,340	21,200	1,530	17,200	1,380	15,900	1,080	
		4	0.044	25,000	2,200	25,000	2,000	18,200	1,310	14,800	1,180	13,600	920	
		5	0.042	21,900	1,930	21,900	1,750	15,900	1,140	12,900	1,030	11,900	810	
		6	0.023	19,500	1,720	19,500	1,560	14,100	1,020	11,500	920	10,600	720	
		8	0.013	15,900	1,400	15,900	1,270	11,600	840	9,400	750	8,700	590	
	1.5	0.02	2	0.017	26,900	3,310	26,900	3,010	19,600	1,980	15,900	1,780	14,700	1,400
			3	0.016	23,300	2,870	23,300	2,610	17,000	1,710	13,800	1,550	12,700	1,210
			4	0.014	20,600	2,540	20,600	2,310	15,000	1,510	12,200	1,370	11,200	1,070
			5	0.013	18,400	2,270	18,400	2,060	13,400	1,350	10,900	1,220	10,100	960
			6	0.012	16,700	2,060	16,700	1,870	12,100	1,220	9,900	1,110	9,100	870
			8	0.011	15,200	1,870	15,200	1,700	11,100	1,120	9,000	1,010	8,300	790
			10	0.010	14,000	1,720	14,000	1,570	10,200	1,030	8,300	930	7,600	720
			12	0.008	12,100	1,490	12,100	1,360	8,800	890	7,100	800	6,600	630
0.05		2	0.048	26,900	3,310	26,900	3,010	19,600	1,980	15,900	1,780	14,700	1,400	
		3	0.043	23,300	2,870	23,300	2,610	17,000	1,710	13,800	1,550	12,700	1,210	
		4	0.039	20,600	2,540	20,600	2,310	15,000	1,510	12,200	1,370	11,200	1,070	
		5	0.035	18,400	2,270	18,400	2,060	13,400	1,350	10,900	1,220	10,100	960	
		6	0.032	16,700	2,060	16,700	1,870	12,100	1,220	9,900	1,110	9,100	870	
		8	0.030	15,200	1,870	15,200	1,700	11,100	1,120	9,000	1,010	8,300	790	
		10	0.027	14,000	1,720	14,000	1,570	10,200	1,030	8,300	930	7,600	720	
		12	0.022	12,100	1,490	12,100	1,360	8,800	890	7,100	800	6,600	630	
0.1		2	0.078	26,900	3,310	26,900	3,010	19,600	1,980	15,900	1,780	14,700	1,400	
		3	0.071	23,300	2,870	23,300	2,610	17,000	1,710	13,800	1,550	12,700	1,210	
		4	0.064	20,600	2,540	20,600	2,310	15,000	1,510	12,200	1,370	11,200	1,070	
		5	0.057	18,400	2,270	18,400	2,060	13,400	1,350	10,900	1,220	10,100	960	

被削材 Work material				1		2		3		4		5		
				プリハードン鋼 Pre-hardened steels (35~45HRC)		焼入れ鋼 Hardened steels (45~55HRC)		焼入れ鋼 Hardened steels (55~60HRC)		焼入れ鋼 Hardened steels (60~65HRC)		焼入れ鋼 Hardened steels (65~72HRC)		
切り込み比率 Cutting depth ratio				120%		100%		70%		50%		25%		
外径DC Tool dia. (mm)	コーナ半径RE Corner radius (mm)	首下長 Under neck length (mm)	ap (mm)	回転数 n min ⁻¹	送り速度 Vf mm/min	回転数 n min ⁻¹	送り速度 Vf mm/min	回転数 n min ⁻¹	送り速度 Vf mm/min	回転数 n min ⁻¹	送り速度 Vf mm/min	回転数 n min ⁻¹	送り速度 Vf mm/min	
1.5	0.1	6	0.052	16,700	2,060	16,700	1,870	12,100	1,220	9,900	1,110	9,100	870	
		8	0.049	15,200	1,870	15,200	1,700	11,100	1,120	9,000	1,010	8,300	790	
		10	0.044	14,000	1,720	14,000	1,570	10,200	1,030	8,300	930	7,600	720	
		12	0.035	12,100	1,490	12,100	1,360	8,800	890	7,100	800	6,600	630	
	0.2	2	0.082	26,900	3,310	26,900	3,010	19,600	1,980	15,900	1,780	14,700	1,400	
		3	0.075	23,300	2,870	23,300	2,610	17,000	1,710	13,800	1,550	12,700	1,210	
		4	0.067	20,600	2,540	20,600	2,310	15,000	1,510	12,200	1,370	11,200	1,070	
		5	0.060	18,400	2,270	18,400	2,060	13,400	1,350	10,900	1,220	10,100	960	
		6	0.055	16,700	2,060	16,700	1,870	12,100	1,220	9,900	1,110	9,100	870	
		8	0.051	15,200	1,870	15,200	1,700	11,100	1,120	9,000	1,010	8,300	790	
		10	0.047	14,000	1,720	14,000	1,570	10,200	1,030	8,300	930	7,600	720	
		12	0.037	12,100	1,490	12,100	1,360	8,800	890	7,100	800	6,600	630	
	0.3	2	0.085	26,900	3,310	26,900	3,010	19,600	1,980	15,900	1,780	14,700	1,400	
		3	0.077	23,300	2,870	23,300	2,610	17,000	1,710	13,800	1,550	12,700	1,210	
		4	0.069	20,600	2,540	20,600	2,310	15,000	1,510	12,200	1,370	11,200	1,070	
		5	0.062	18,400	2,270	18,400	2,060	13,400	1,350	10,900	1,220	10,100	960	
		6	0.057	16,700	2,060	16,700	1,870	12,100	1,220	9,900	1,110	9,100	870	
		8	0.053	15,200	1,870	15,200	1,700	11,100	1,120	9,000	1,010	8,300	790	
		10	0.048	14,000	1,720	14,000	1,570	10,200	1,030	8,300	930	7,600	720	
		12	0.039	12,100	1,490	12,100	1,360	8,800	890	7,100	800	6,600	630	
	0.5	2	0.087	26,900	3,310	26,900	3,010	19,600	1,980	15,900	1,780	14,700	1,400	
		3	0.079	23,300	2,870	23,300	2,610	17,000	1,710	13,800	1,550	12,700	1,210	
		4	0.071	20,600	2,540	20,600	2,310	15,000	1,510	12,200	1,370	11,200	1,070	
		5	0.063	18,400	2,270	18,400	2,060	13,400	1,350	10,900	1,220	10,100	960	
		6	0.058	16,700	2,060	16,700	1,870	12,100	1,220	9,900	1,110	9,100	870	
		8	0.054	15,200	1,870	15,200	1,700	11,100	1,120	9,000	1,010	8,300	790	
		10	0.049	14,000	1,720	14,000	1,570	10,200	1,030	8,300	930	7,600	720	
		12	0.039	12,100	1,490	12,100	1,360	8,800	890	7,100	800	6,600	630	
	2	0.02	2.5	0.018	20,600	3,630	20,600	3,300	15,000	2,160	12,200	1,950	11,200	1,520
			3	0.016	19,500	3,430	19,500	3,120	14,100	2,030	11,500	1,840	10,600	1,440
			4	0.014	17,500	3,080	17,500	2,800	12,700	1,830	10,300	1,650	9,500	1,290
			5	0.014	15,900	2,800	15,900	2,540	11,600	1,670	9,400	1,500	8,700	1,180
			6	0.013	14,600	2,570	14,600	2,340	10,600	1,530	8,600	1,380	8,000	1,090
			8	0.013	12,500	2,200	12,500	2,000	9,100	1,310	7,400	1,180	6,800	920
			10	0.012	10,900	1,920	10,900	1,740	8,000	1,150	6,500	1,040	6,000	820
			12	0.009	9,700	1,710	9,700	1,550	7,100	1,020	5,700	910	5,300	720
		0.05	2.5	0.048	20,600	3,630	20,600	3,300	15,000	2,160	12,200	1,950	11,200	1,520
			3	0.043	19,500	3,430	19,500	3,120	14,100	2,030	11,500	1,840	10,600	1,440
			4	0.037	17,500	3,080	17,500	2,800	12,700	1,830	10,300	1,650	9,500	1,290
			5	0.036	15,900	2,800	15,900	2,540	11,600	1,670	9,400	1,500	8,700	1,180
			6	0.035	14,600	2,570	14,600	2,340	10,600	1,530	8,600	1,380	8,000	1,090
			8	0.034	12,500	2,200	12,500	2,000	9,100	1,310	7,400	1,180	6,800	920
			10	0.032	10,900	1,920	10,900	1,740	8,000	1,150	6,500	1,040	6,000	820
			12	0.024	9,700	1,710	9,700	1,550	7,100	1,020	5,700	910	5,300	720
		0.1	2.5	0.082	20,600	3,630	20,600	3,300	15,000	2,160	12,200	1,950	11,200	1,520
			3	0.073	19,500	3,430	19,500	3,120	14,100	2,030	11,500	1,840	10,600	1,440
			4	0.063	17,500	3,080	17,500	2,800	12,700	1,830	10,300	1,650	9,500	1,290
			5	0.061	15,900	2,800	15,900	2,540	11,600	1,670	9,400	1,500	8,700	1,180
6			0.059	14,600	2,570	14,600	2,340	10,600	1,530	8,600	1,380	8,000	1,090	
8			0.058	12,500	2,200	12,500	2,000	9,100	1,310	7,400	1,180	6,800	920	
10			0.054	10,900	1,920	10,900	1,740	8,000	1,150	6,500	1,040	6,000	820	
12			0.041	9,700	1,710	9,700	1,550	7,100	1,020	5,700	910	5,300	720	
0.2		2.5	0.092	20,600	3,630	20,600	3,300	15,000	2,160	12,200	1,950	11,200	1,520	
		3	0.082	19,500	3,430	19,500	3,120	14,100	2,030	11,500	1,840	10,600	1,440	
		4	0.071	17,500	3,080	17,500	2,800	12,700	1,830	10,300	1,650	9,500	1,290	
		5	0.069	15,900	2,800	15,900	2,540	11,600	1,670	9,400	1,500	8,700	1,180	
		6	0.066	14,600	2,570	14,600	2,340	10,600	1,530	8,600	1,380	8,000	1,090	
		8	0.066	12,500	2,200	12,500	2,000	9,100	1,310	7,400	1,180	6,800	920	
		10	0.061	10,900	1,920	10,900	1,740	8,000	1,150	6,500	1,040	6,000	820	
		12	0.046	9,700	1,710	9,700	1,550	7,100	1,020	5,700	910	5,300	720	

【注意】 ご使用にあたっては、A188ページの表下の項目と注意を参照してください。 **【Note】** Refer to the comments and notes below the table on page A188 regarding usage.

EPDREH4-TH3

4枚刃
4 Flutes

高能率切削条件
High-efficiency cutting conditions

高精度切削条件
High-accuracy cutting conditions

高精度切削条件はA189ページを参照してください。
Please refer to P.A189 about high accuracy cutting conditions

被削材 Work material				1		2		3		4		5	
				プリハードン鋼 Pre-hardened steels (35~45HRC)		焼入れ鋼 Hardened steels (45~55HRC)		焼入れ鋼 Hardened steels (55~60HRC)		焼入れ鋼 Hardened steels (60~65HRC)		焼入れ鋼 Hardened steels (65~72HRC)	
切り込み比率 Cutting depth ratio				120%		100%		70%		50%		25%	
外径DC Tool dia. (mm)	コーナ半径RE Corner radius (mm)	首下長 Under neck length (mm)	ap (mm)	回転数 n min ⁻¹	送り速度 Vf mm/min	回転数 n min ⁻¹	送り速度 Vf mm/min	回転数 n min ⁻¹	送り速度 Vf mm/min	回転数 n min ⁻¹	送り速度 Vf mm/min	回転数 n min ⁻¹	送り速度 Vf mm/min
2	0.3	2.5	0.097	20,600	3,630	20,600	3,300	15,000	2,160	12,200	1,950	11,200	1,520
		3	0.087	19,500	3,430	19,500	3,120	14,100	2,030	11,500	1,840	10,600	1,440
		4	0.074	17,500	3,080	17,500	2,800	12,700	1,830	10,300	1,650	9,500	1,290
		5	0.073	15,900	2,800	15,900	2,540	11,600	1,670	9,400	1,500	8,700	1,180
		6	0.070	14,600	2,570	14,600	2,340	10,600	1,530	8,600	1,380	8,000	1,090
		8	0.069	12,500	2,200	12,500	2,000	9,100	1,310	7,400	1,180	6,800	920
		10	0.064	10,900	1,920	10,900	1,740	8,000	1,150	6,500	1,040	6,000	820
	0.5	2.5	0.102	20,600	3,630	20,600	3,300	15,000	2,160	12,200	1,950	11,200	1,520
		3	0.091	19,500	3,430	19,500	3,120	14,100	2,030	11,500	1,840	10,600	1,440
		4	0.078	17,500	3,080	17,500	2,800	12,700	1,830	10,300	1,650	9,500	1,290
		5	0.076	15,900	2,800	15,900	2,540	11,600	1,670	9,400	1,500	8,700	1,180
		6	0.074	14,600	2,570	14,600	2,340	10,600	1,530	8,600	1,380	8,000	1,090
		8	0.073	12,500	2,200	12,500	2,000	9,100	1,310	7,400	1,180	6,800	920
		10	0.068	10,900	1,920	10,900	1,740	8,000	1,150	6,500	1,040	6,000	820
3	0.05	4	0.045	18,600	2,950	18,600	2,680	13,500	1,750	11,000	1,580	10,200	1,250
		6	0.043	15,400	2,440	15,400	2,220	11,200	1,450	9,100	1,310	8,400	1,030
		8	0.042	13,100	2,080	13,100	1,890	9,500	1,230	7,700	1,110	7,100	870
		10	0.041	11,400	1,810	11,400	1,640	8,300	1,080	6,700	960	6,200	760
		12	0.038	10,100	1,600	10,100	1,450	7,300	950	5,900	850	5,500	670
		14	0.035	9,000	1,430	9,000	1,300	6,600	860	5,300	760	4,900	600
		16	0.034	8,200	1,300	8,200	1,180	5,900	760	4,800	690	4,500	550
		18	0.030	7,500	1,190	7,500	1,080	5,400	700	4,400	630	4,100	500
	0.1	4	0.090	18,600	2,950	18,600	2,680	13,500	1,750	11,000	1,580	10,200	1,250
		6	0.087	15,400	2,440	15,400	2,220	11,200	1,450	9,100	1,310	8,400	1,030
		8	0.085	13,100	2,080	13,100	1,890	9,500	1,230	7,700	1,110	7,100	870
		10	0.081	11,400	1,810	11,400	1,640	8,300	1,080	6,700	960	6,200	760
		12	0.075	10,100	1,600	10,100	1,450	7,300	950	5,900	850	5,500	670
		14	0.069	9,000	1,430	9,000	1,300	6,600	860	5,300	760	4,900	600
		16	0.067	8,200	1,300	8,200	1,180	5,900	760	4,800	690	4,500	550
		18	0.061	7,500	1,190	7,500	1,080	5,400	700	4,400	630	4,100	500
	0.2	4	0.102	18,600	2,950	18,600	2,680	13,500	1,750	11,000	1,580	10,200	1,250
		6	0.098	15,400	2,440	15,400	2,220	11,200	1,450	9,100	1,310	8,400	1,030
		8	0.095	13,100	2,080	13,100	1,890	9,500	1,230	7,700	1,110	7,100	870
		10	0.092	11,400	1,810	11,400	1,640	8,300	1,080	6,700	960	6,200	760
		12	0.085	10,100	1,600	10,100	1,450	7,300	950	5,900	850	5,500	670
		14	0.078	9,000	1,430	9,000	1,300	6,600	860	5,300	760	4,900	600
		16	0.076	8,200	1,300	8,200	1,180	5,900	760	4,800	690	4,500	550
		18	0.068	7,500	1,190	7,500	1,080	5,400	700	4,400	630	4,100	500
	0.3	4	0.107	18,600	2,950	18,600	2,680	13,500	1,750	11,000	1,580	10,200	1,250
		6	0.103	15,400	2,440	15,400	2,220	11,200	1,450	9,100	1,310	8,400	1,030
		8	0.101	13,100	2,080	13,100	1,890	9,500	1,230	7,700	1,110	7,100	870
		10	0.097	11,400	1,810	11,400	1,640	8,300	1,080	6,700	960	6,200	760
12		0.090	10,100	1,600	10,100	1,450	7,300	950	5,900	850	5,500	670	
14		0.082	9,000	1,430	9,000	1,300	6,600	860	5,300	760	4,900	600	
16		0.080	8,200	1,300	8,200	1,180	5,900	760	4,800	690	4,500	550	
18		0.072	7,500	1,190	7,500	1,080	5,400	700	4,400	630	4,100	500	
0.5	4	0.113	18,600	2,950	18,600	2,680	13,500	1,750	11,000	1,580	10,200	1,250	
	6	0.109	15,400	2,440	15,400	2,220	11,200	1,450	9,100	1,310	8,400	1,030	
	8	0.106	13,100	2,080	13,100	1,890	9,500	1,230	7,700	1,110	7,100	870	
	10	0.102	11,400	1,810	11,400	1,640	8,300	1,080	6,700	960	6,200	760	
	12	0.094	10,100	1,600	10,100	1,450	7,300	950	5,900	850	5,500	670	
	14	0.087	9,000	1,430	9,000	1,300	6,600	860	5,300	760	4,900	600	
	16	0.084	8,200	1,300	8,200	1,180	5,900	760	4,800	690	4,500	550	
	18	0.076	7,500	1,190	7,500	1,080	5,400	700	4,400	630	4,100	500	
0.5	20	0.056	6,900	1,090	6,900	990	5,000	650	4,100	590	3,800	470	

被削材 Work material				1		2		3		4		5			
				プリハードン鋼 Pre-hardened steels (35~45HRC)		焼入れ鋼 Hardened steels (45~55HRC)		焼入れ鋼 Hardened steels (55~60HRC)		焼入れ鋼 Hardened steels (60~65HRC)		焼入れ鋼 Hardened steels (65~72HRC)			
切り込み比率 Cutting depth ratio				120%		100%		70%		50%		25%			
外径DC Tool dia. (mm)	コーナ半径RE Corner radius (mm)	首下長 Under neck length (mm)	ap (mm)	回転数 n min ⁻¹		送り速度 Vf mm/min		回転数 n min ⁻¹		送り速度 Vf mm/min		回転数 n min ⁻¹		送り速度 Vf mm/min	
				4	0.1	8	0.091	10,400	2,750	10,400	2,500	7,600	1,640	6,200	1,490
10	0.089	9,300	2,460			9,300	2,230	6,800	1,470	5,500	1,320	5,100	1,040		
12	0.084	8,400	2,220			8,400	2,020	6,100	1,320	5,000	1,200	4,600	940		
14	0.079	7,700	2,030			7,700	1,850	5,600	1,210	4,500	1,080	4,200	860		
16	0.076	7,100	1,870			7,100	1,700	5,100	1,100	4,200	1,010	3,900	800		
18	0.074	6,500	1,720			6,500	1,560	4,800	1,040	3,900	940	3,600	730		
20	0.070	6,100	1,610			6,100	1,460	4,400	950	3,600	860	3,300	670		
22	0.059	5,700	1,500			5,700	1,370	4,100	890	3,400	820	3,100	630		
24	0.055	5,300	1,400		5,300	1,270	3,900	840	3,200	770	2,900	590			
0.2	8	0.126	10,400		2,750	10,400	2,500	7,600	1,640	6,200	1,490	5,700	1,160		
	10	0.123	9,300		2,460	9,300	2,230	6,800	1,470	5,500	1,320	5,100	1,040		
	12	0.117	8,400		2,220	8,400	2,020	6,100	1,320	5,000	1,200	4,600	940		
	14	0.109	7,700		2,030	7,700	1,850	5,600	1,210	4,500	1,080	4,200	860		
	16	0.105	7,100		1,870	7,100	1,700	5,100	1,100	4,200	1,010	3,900	800		
	18	0.102	6,500		1,720	6,500	1,560	4,800	1,040	3,900	940	3,600	730		
	20	0.097	6,100		1,610	6,100	1,460	4,400	950	3,600	860	3,300	670		
	22	0.081	5,700		1,500	5,700	1,370	4,100	890	3,400	820	3,100	630		
24	0.077	5,300	1,400		5,300	1,270	3,900	840	3,200	770	2,900	590			
0.3	8	0.133	10,400		2,750	10,400	2,500	7,600	1,640	6,200	1,490	5,700	1,160		
	10	0.129	9,300		2,460	9,300	2,230	6,800	1,470	5,500	1,320	5,100	1,040		
	12	0.123	8,400		2,220	8,400	2,020	6,100	1,320	5,000	1,200	4,600	940		
	14	0.115	7,700		2,030	7,700	1,850	5,600	1,210	4,500	1,080	4,200	860		
	16	0.111	7,100		1,870	7,100	1,700	5,100	1,100	4,200	1,010	3,900	800		
	18	0.108	6,500		1,720	6,500	1,560	4,800	1,040	3,900	940	3,600	730		
	20	0.102	6,100		1,610	6,100	1,460	4,400	950	3,600	860	3,300	670		
	22	0.086	5,700		1,500	5,700	1,370	4,100	890	3,400	820	3,100	630		
24	0.081	5,300	1,400		5,300	1,270	3,900	840	3,200	770	2,900	590			
0.5	8	0.137	10,400		2,750	10,400	2,500	7,600	1,640	6,200	1,490	5,700	1,160		
	10	0.133	9,300		2,460	9,300	2,230	6,800	1,470	5,500	1,320	5,100	1,040		
	12	0.127	8,400		2,220	8,400	2,020	6,100	1,320	5,000	1,200	4,600	940		
	14	0.118	7,700		2,030	7,700	1,850	5,600	1,210	4,500	1,080	4,200	860		
	16	0.114	7,100		1,870	7,100	1,700	5,100	1,100	4,200	1,010	3,900	800		
	18	0.111	6,500		1,720	6,500	1,560	4,800	1,040	3,900	940	3,600	730		
	20	0.106	6,100		1,610	6,100	1,460	4,400	950	3,600	860	3,300	670		
	22	0.088	5,700		1,500	5,700	1,370	4,100	890	3,400	820	3,100	630		
24	0.084	5,300	1,400		5,300	1,270	3,900	840	3,200	770	2,900	590			
1	8	0.140	10,400		2,750	10,400	2,500	7,600	1,640	6,200	1,490	5,700	1,160		
	10	0.136	9,300		2,460	9,300	2,230	6,800	1,470	5,500	1,320	5,100	1,040		
	12	0.130	8,400		2,220	8,400	2,020	6,100	1,320	5,000	1,200	4,600	940		
	14	0.121	7,700		2,030	7,700	1,850	5,600	1,210	4,500	1,080	4,200	860		
	16	0.117	7,100		1,870	7,100	1,700	5,100	1,100	4,200	1,010	3,900	800		
	18	0.114	6,500		1,720	6,500	1,560	4,800	1,040	3,900	940	3,600	730		
	20	0.108	6,100		1,610	6,100	1,460	4,400	950	3,600	860	3,300	670		
	22	0.090	5,700		1,500	5,700	1,370	4,100	890	3,400	820	3,100	630		
24	0.085	5,300	1,400		5,300	1,270	3,900	840	3,200	770	2,900	590			
5	0.1	10	0.096		9,300	3,270	9,300	2,980	6,800	1,960	5,500	1,760	5,100	1,390	
		15	0.081		7,400	2,600	7,400	2,370	5,400	1,560	4,400	1,410	4,000	1,090	
		20	0.077		6,100	2,150	6,100	1,950	4,400	1,270	3,600	1,150	3,300	900	
		25	0.075	5,200	1,830	5,200	1,660	3,800	1,090	3,100	990	2,800	760		
	0.2	10	0.123	9,300	3,270	9,300	2,980	6,800	1,960	5,500	1,760	5,100	1,390		
		15	0.103	7,400	2,600	7,400	2,370	5,400	1,560	4,400	1,410	4,000	1,090		
		20	0.098	6,100	2,150	6,100	1,950	4,400	1,270	3,600	1,150	3,300	900		
		25	0.095	5,200	1,830	5,200	1,660	3,800	1,090	3,100	990	2,800	760		
	0.3	10	0.166	9,300	3,270	9,300	2,980	6,800	1,960	5,500	1,760	5,100	1,390		
		15	0.140	7,400	2,600	7,400	2,370	5,400	1,560	4,400	1,410	4,000	1,090		
		20	0.133	6,100	2,150	6,100	1,950	4,400	1,270	3,600	1,150	3,300	900		
		25	0.129	5,200	1,830	5,200	1,660	3,800	1,090	3,100	990	2,800	760		
	0.5	10	0.172	9,300	3,270	9,300	2,980	6,800	1,960	5,500	1,760	5,100	1,390		
		15	0.144	7,400	2,600	7,400	2,370	5,400	1,560	4,400	1,410	4,000	1,090		
		20	0.137	6,100	2,150	6,100	1,950	4,400	1,270	3,600	1,150	3,300	900		
		25	0.133	5,200	1,830	5,200	1,660	3,800	1,090	3,100	990	2,800	760		

【注意】 ご使用にあたっては、A188ページの表下の項目と注意を参照してください。 **【Note】** Refer to the comments and notes below the table on page A188 regarding usage.

EPDREH4-TH3

4枚刃
4 Flutes

高能率切削条件
High-efficiency cutting conditions

高精度切削条件
High-accuracy cutting conditions

高精度切削条件はA189ページを参照してください。
Please refer to P.A189 about high accuracy cutting conditions

被削材 Work material				1		2		3		4		5	
				プリハードン鋼 Pre-hardened steels (35~45HRC)		焼入れ鋼 Hardened steels (45~55HRC)		焼入れ鋼 Hardened steels (55~60HRC)		焼入れ鋼 Hardened steels (60~65HRC)		焼入れ鋼 Hardened steels (65~72HRC)	
切り込み比率 Cutting depth ratio				120%		100%		70%		50%		25%	
外径DC Tool dia. (mm)	コーナ半径RE Corner radius (mm)	首下長 Under neck length (mm)	ap (mm)	回転数 n min ⁻¹	送り速度 Vf mm/min	回転数 n min ⁻¹	送り速度 Vf mm/min	回転数 n min ⁻¹	送り速度 Vf mm/min	回転数 n min ⁻¹	送り速度 Vf mm/min	回転数 n min ⁻¹	送り速度 Vf mm/min
5	1	10	0.175	9,300	3,270	9,300	2,980	6,800	1,960	5,500	1,760	5,100	1,390
		15	0.147	7,400	2,600	7,400	2,370	5,400	1,560	4,400	1,410	4,000	1,090
		20	0.140	6,100	2,150	6,100	1,950	4,400	1,270	3,600	1,150	3,300	900
		25	0.135	5,200	1,830	5,200	1,660	3,800	1,090	3,100	990	2,800	760
6	0.1	12	0.098	8,300	3,290	8,300	2,990	6,100	1,980	4,900	1,760	4,500	1,380
		18	0.088	6,500	2,570	6,500	2,340	4,700	1,520	3,800	1,370	3,500	1,070
		24	0.082	5,300	2,100	5,300	1,910	3,900	1,260	3,100	1,120	2,900	890
		30	0.079	4,500	1,780	4,500	1,620	3,300	1,070	2,700	970	2,400	730
	0.2	12	0.177	8,300	3,290	8,300	2,990	6,100	1,980	4,900	1,760	4,500	1,380
		18	0.158	6,500	2,570	6,500	2,340	4,700	1,520	3,800	1,370	3,500	1,070
		24	0.148	5,300	2,100	5,300	1,910	3,900	1,260	3,100	1,120	2,900	890
		30	0.142	4,500	1,780	4,500	1,620	3,300	1,070	2,700	970	2,400	730
	0.3	12	0.187	8,300	3,290	8,300	2,990	6,100	1,980	4,900	1,760	4,500	1,380
		18	0.166	6,500	2,570	6,500	2,340	4,700	1,520	3,800	1,370	3,500	1,070
		24	0.156	5,300	2,100	5,300	1,910	3,900	1,260	3,100	1,120	2,900	890
		30	0.150	4,500	1,780	4,500	1,620	3,300	1,070	2,700	970	2,400	730
	0.5	12	0.193	8,300	3,290	8,300	2,990	6,100	1,980	4,900	1,760	4,500	1,380
		18	0.172	6,500	2,570	6,500	2,340	4,700	1,520	3,800	1,370	3,500	1,070
		24	0.161	5,300	2,100	5,300	1,910	3,900	1,260	3,100	1,120	2,900	890
		30	0.154	4,500	1,780	4,500	1,620	3,300	1,070	2,700	970	2,400	730
	1	12	0.197	8,300	3,290	8,300	2,990	6,100	1,980	4,900	1,760	4,500	1,380
		18	0.175	6,500	2,570	6,500	2,340	4,700	1,520	3,800	1,370	3,500	1,070
		24	0.164	5,300	2,100	5,300	1,910	3,900	1,260	3,100	1,120	2,900	890
		30	0.158	4,500	1,780	4,500	1,620	3,300	1,070	2,700	970	2,400	730

- (1) apは被削材グループ2での目安を示しています。その他のグループの場合は、上表の切り込み比率を目安に調整してください。
- (2) リブ加工や止まり溝など、切りくずがつまりやすい切削の場合、切り込み設定は基本切り込みに切り込み比率をかけて算出した切り込み量、さらにその80%まで小さくして使用してください。
- (3) aeの設定はap×切り込み比率×5倍以下を目安に調整してください。仕上げ加工を行う場合、理論カスプハイトを計算し設定してください。
- (4) 彫り込み時の傾斜進入角は1°以下を推奨いたします。また、送り速度は条件表の70%以下に調整してください。
- (5) 文字彫り加工のような溝切削の際は、送り速度は50%以下・apを30%以下を目安に調整してください。また往復切削による加工を推奨いたします。

【切り込み設定例】

EPDREH4010-2-02-TH3の工具で焼入れ鋼(50HRC)をリブ溝等高線切削する場合、
切り込み=0.047(ap)×1(焼入れ鋼グループ2の切り込み比率)×0.8(閉鎖域の切削)=0.0376mm

Cutting depth setting example: When cutting rib groove contours in hardened steel (50HRC) using an EPDREH4010-2-02-TH3 tool:
Cutting depth = 0.047 (ap) × 1 (cutting depth factor for Group 2 Hardened steels) × 0.8 (for closed-area cutting) = 0.0376 mm

【注意】

- ① 被削材、加工形状に合わせて、適切なクーラントを使用してください。
- ② この標準切削条件表は切削条件の目安を示すものです。実際の加工では加工形状、目的、使用機械等により条件を調整してください。
- ③ 機械の回転数が足りない場合は、回転数と送り速度を同じ比率で下げてください。

【Note】

- ① Use the appropriate coolant for the work material and machining shape.
- ② These Recommended Cutting Conditions indicate only the rule of a thumb for the cutting conditions. In actual machining, the condition should be adjusted according to the machining shape, purpose and the machine type.
- ③ If the rpm of the machine is low, lower the feed rate also to put the rpm and feed rate in the same ratio.



標準切削条件表
Recommended cutting conditions

4枚刃
4 Flutes

高能率切削条件
High efficiency cutting condition

高精度切削条件
High accuracy cutting condition

Carbide End Mills
Radius End Mills

Radius End Mills

Radius End Mills

Radius End Mills

Radius End Mills

Radius End Mills

Radius End Mills

Radius End Mills

Radius End Mills

EPDREH4-TH3

高能率切削条件はA184ページを参照してください。
Please refer to P.A184 about high efficiency cutting conditions

被削材 Work material				1		2		3		4		5		
				プリハードン鋼 Pre-hardened steels (35~45HRC)		焼入れ鋼 Hardened steels (45~55HRC)		焼入れ鋼 Hardened steels (55~60HRC)		焼入れ鋼 Hardened steels (60~65HRC)		焼入れ鋼 Hardened steels (65~72HRC)		
切り込み比率 Cutting depth ratio				120%		100%		70%		50%		25%		
外径DC Tool dia. (mm)	コーナ半径RE Corner radius (mm)	首下長 Under neck length (mm)	ap (mm)	回転数 n min ⁻¹	送り速度 Vf mm/min	回転数 n min ⁻¹	送り速度 Vf mm/min	回転数 n min ⁻¹	送り速度 Vf mm/min	回転数 n min ⁻¹	送り速度 Vf mm/min	回転数 n min ⁻¹	送り速度 Vf mm/min	
1	0.02	1.5	0.016	32,300	2,840	32,300	2,580	23,500	1,690	19,100	1,530	17,600	1,200	
		2	0.013	29,100	2,560	29,100	2,320	21,200	1,530	17,200	1,380	15,900	1,080	
		2.5	0.013	26,400	2,320	26,400	2,110	19,200	1,380	15,600	1,250	14,400	980	
		3	0.012	24,200	2,130	24,200	1,940	17,600	1,270	14,300	1,150	13,200	900	
		4	0.011	20,800	1,830	20,800	1,660	15,100	1,090	12,300	980	11,300	760	
		5	0.010	18,200	1,600	18,200	1,450	13,200	950	10,700	850	9,900	670	
		6	0.006	16,200	1,430	16,200	1,290	11,700	850	9,500	760	8,800	600	
		8	0.003	13,200	1,160	13,200	1,060	9,600	700	7,800	620	7,200	490	
	0.05	1.5	0.038	32,300	2,840	32,300	2,580	23,500	1,690	19,100	1,530	17,600	1,200	
		2	0.028	29,100	2,560	29,100	2,320	21,200	1,530	17,200	1,380	15,900	1,080	
		2.5	0.027	26,400	2,320	26,400	2,110	19,200	1,380	15,600	1,250	14,400	980	
		3	0.025	24,200	2,130	24,200	1,940	17,600	1,270	14,300	1,150	13,200	900	
		4	0.024	20,800	1,830	20,800	1,660	15,100	1,090	12,300	980	11,300	760	
		5	0.023	18,200	1,600	18,200	1,450	13,200	950	10,700	850	9,900	670	
		6	0.013	16,200	1,430	16,200	1,290	11,700	850	9,500	760	8,800	600	
		8	0.007	13,200	1,160	13,200	1,060	9,600	700	7,800	620	7,200	490	
	0.1	1.5	0.046	32,300	2,840	32,300	2,580	23,500	1,690	19,100	1,530	17,600	1,200	
		2	0.035	29,100	2,560	29,100	2,320	21,200	1,530	17,200	1,380	15,900	1,080	
		2.5	0.033	26,400	2,320	26,400	2,110	19,200	1,380	15,600	1,250	14,400	980	
		3	0.031	24,200	2,130	24,200	1,940	17,600	1,270	14,300	1,150	13,200	900	
		4	0.029	20,800	1,830	20,800	1,660	15,100	1,090	12,300	980	11,300	760	
		5	0.028	18,200	1,600	18,200	1,450	13,200	950	10,700	850	9,900	670	
		6	0.015	16,200	1,430	16,200	1,290	11,700	850	9,500	760	8,800	600	
		8	0.009	13,200	1,160	13,200	1,060	9,600	700	7,800	620	7,200	490	
	0.2	1.5	0.052	32,300	2,840	32,300	2,580	23,500	1,690	19,100	1,530	17,600	1,200	
		2	0.039	29,100	2,560	29,100	2,320	21,200	1,530	17,200	1,380	15,900	1,080	
		2.5	0.038	26,400	2,320	26,400	2,110	19,200	1,380	15,600	1,250	14,400	980	
		3	0.035	24,200	2,130	24,200	1,940	17,600	1,270	14,300	1,150	13,200	900	
		4	0.033	20,800	1,830	20,800	1,660	15,100	1,090	12,300	980	11,300	760	
		5	0.031	18,200	1,600	18,200	1,450	13,200	950	10,700	850	9,900	670	
		6	0.017	16,200	1,430	16,200	1,290	11,700	850	9,500	760	8,800	600	
		8	0.010	13,200	1,160	13,200	1,060	9,600	700	7,800	620	7,200	490	
	0.3	1.5	0.058	32,300	2,840	32,300	2,580	23,500	1,690	19,100	1,530	17,600	1,200	
		2	0.044	29,100	2,560	29,100	2,320	21,200	1,530	17,200	1,380	15,900	1,080	
		2.5	0.042	26,400	2,320	26,400	2,110	19,200	1,380	15,600	1,250	14,400	980	
		3	0.039	24,200	2,130	24,200	1,940	17,600	1,270	14,300	1,150	13,200	900	
		4	0.036	20,800	1,830	20,800	1,660	15,100	1,090	12,300	980	11,300	760	
		5	0.035	18,200	1,600	18,200	1,450	13,200	950	10,700	850	9,900	670	
		6	0.019	16,200	1,430	16,200	1,290	11,700	850	9,500	760	8,800	600	
		8	0.011	13,200	1,160	13,200	1,060	9,600	700	7,800	620	7,200	490	
	1.5	0.02	2	0.014	22,300	2,750	22,300	2,500	16,300	1,640	13,200	1,480	12,200	1,160
			3	0.013	19,300	2,380	19,300	2,170	14,100	1,420	11,500	1,290	10,500	1,000
			4	0.012	17,100	2,110	17,100	1,920	12,500	1,250	10,100	1,140	9,300	890
			5	0.010	15,300	1,880	15,300	1,710	11,100	1,120	9,000	1,010	8,400	800
			6	0.010	13,900	1,710	13,900	1,550	10,000	1,010	8,200	920	7,600	720
			8	0.008	12,600	1,550	12,600	1,410	9,200	930	7,500	840	6,900	660
			10	0.007	11,600	1,430	11,600	1,300	8,500	850	6,900	770	6,300	600
			12	0.004	10,000	1,240	10,000	1,130	7,300	740	5,900	660	5,500	520
0.05		2	0.040	22,300	2,750	22,300	2,500	16,300	1,640	13,200	1,480	12,200	1,160	
		3	0.036	19,300	2,380	19,300	2,170	14,100	1,420	11,500	1,290	10,500	1,000	
		4	0.032	17,100	2,110	17,100	1,920	12,500	1,250	10,100	1,140	9,300	890	
		5	0.029	15,300	1,880	15,300	1,710	11,100	1,120	9,000	1,010	8,400	800	
		6	0.026	13,900	1,710	13,900	1,550	10,000	1,010	8,200	920	7,600	720	
		8	0.022	12,600	1,550	12,600	1,410	9,200	930	7,500	840	6,900	660	
		10	0.018	11,600	1,430	11,600	1,300	8,500	850	6,900	770	6,300	600	
		12	0.012	10,000	1,240	10,000	1,130	7,300	740	5,900	660	5,500	520	
0.1		2	0.065	22,300	2,750	22,300	2,500	16,300	1,640	13,200	1,480	12,200	1,160	
		3	0.059	19,300	2,380	19,300	2,170	14,100	1,420	11,500	1,290	10,500	1,000	
		4	0.053	17,100	2,110	17,100	1,920	12,500	1,250	10,100	1,140	9,300	890	
		5	0.047	15,300	1,880	15,300	1,710	11,100	1,120	9,000	1,010	8,400	800	

【注意】 ご使用にあたっては、A193ページの表下の項目と注意を参照してください。 **【Note】** Refer to the comments and notes below the table on page A193 regarding usage.

エポックディープラジラスエボリューションハード-TH3

EPDREH4-TH3

4枚刃
4 Flutes

高能率切削条件
High-efficiency cutting conditions

高精度切削条件
High-accuracy cutting conditions

高能率切削条件はA184ページを参照してください。
Please refer to P.A184 about high efficiency cutting conditions

被削材 Work material				1		2		3		4		5	
				プリハードン鋼 Pre-hardened steels (35~45HRC)		焼入れ鋼 Hardened steels (45~55HRC)		焼入れ鋼 Hardened steels (55~60HRC)		焼入れ鋼 Hardened steels (60~65HRC)		焼入れ鋼 Hardened steels (65~72HRC)	
切り込み比率 Cutting depth ratio				120%		100%		70%		50%		25%	
外径DC Tool dia. (mm)	コーナ半径RE Corner radius (mm)	首下長 Under neck length (mm)	ap (mm)	回転数 n min ⁻¹	送り速度 Vf mm/min	回転数 n min ⁻¹	送り速度 Vf mm/min	回転数 n min ⁻¹	送り速度 Vf mm/min	回転数 n min ⁻¹	送り速度 Vf mm/min	回転数 n min ⁻¹	送り速度 Vf mm/min
1.5	0.1	6	0.043	13,900	1,710	13,900	1,550	10,000	1,010	8,200	920	7,600	720
		8	0.037	12,600	1,550	12,600	1,410	9,200	930	7,500	840	6,900	660
		10	0.029	11,600	1,430	11,600	1,300	8,500	850	6,900	770	6,300	600
	0.2	12	0.020	10,000	1,240	10,000	1,130	7,300	740	5,900	660	5,500	520
		2	0.068	22,300	2,750	22,300	2,500	16,300	1,640	13,200	1,480	12,200	1,160
		3	0.062	19,300	2,380	19,300	2,170	14,100	1,420	11,500	1,290	10,500	1,000
		4	0.056	17,100	2,110	17,100	1,920	12,500	1,250	10,100	1,140	9,300	890
		5	0.050	15,300	1,880	15,300	1,710	11,100	1,120	9,000	1,010	8,400	800
		6	0.046	13,900	1,710	13,900	1,550	10,000	1,010	8,200	920	7,600	720
		8	0.039	12,600	1,550	12,600	1,410	9,200	930	7,500	840	6,900	660
	0.3	10	0.031	11,600	1,430	11,600	1,300	8,500	850	6,900	770	6,300	600
		12	0.021	10,000	1,240	10,000	1,130	7,300	740	5,900	660	5,500	520
		2	0.070	22,300	2,750	22,300	2,500	16,300	1,640	13,200	1,480	12,200	1,160
		3	0.064	19,300	2,380	19,300	2,170	14,100	1,420	11,500	1,290	10,500	1,000
		4	0.058	17,100	2,110	17,100	1,920	12,500	1,250	10,100	1,140	9,300	890
		5	0.051	15,300	1,880	15,300	1,710	11,100	1,120	9,000	1,010	8,400	800
		6	0.047	13,900	1,710	13,900	1,550	10,000	1,010	8,200	920	7,600	720
	0.5	8	0.040	12,600	1,550	12,600	1,410	9,200	930	7,500	840	6,900	660
		10	0.032	11,600	1,430	11,600	1,300	8,500	850	6,900	770	6,300	600
		12	0.021	10,000	1,240	10,000	1,130	7,300	740	5,900	660	5,500	520
		2	0.072	22,300	2,750	22,300	2,500	16,300	1,640	13,200	1,480	12,200	1,160
		3	0.065	19,300	2,380	19,300	2,170	14,100	1,420	11,500	1,290	10,500	1,000
		4	0.059	17,100	2,110	17,100	1,920	12,500	1,250	10,100	1,140	9,300	890
		5	0.052	15,300	1,880	15,300	1,710	11,100	1,120	9,000	1,010	8,400	800
2	0.02	6	0.048	13,900	1,710	13,900	1,550	10,000	1,010	8,200	920	7,600	720
		8	0.041	12,600	1,550	12,600	1,410	9,200	930	7,500	840	6,900	660
		10	0.033	11,600	1,430	11,600	1,300	8,500	850	6,900	770	6,300	600
		12	0.022	10,000	1,240	10,000	1,130	7,300	740	5,900	660	5,500	520
		2.5	0.015	17,100	3,010	17,100	2,740	12,500	1,790	10,100	1,620	9,300	1,260
		3	0.014	16,200	2,850	16,200	2,590	11,700	1,680	9,500	1,530	8,800	1,200
	0.05	4	0.012	14,500	2,560	14,500	2,320	10,500	1,520	8,500	1,370	7,900	1,070
		5	0.011	13,200	2,320	13,200	2,110	9,600	1,390	7,800	1,250	7,200	980
		6	0.011	12,100	2,130	12,100	1,940	8,800	1,270	7,100	1,150	6,600	900
		8	0.011	10,400	1,830	10,400	1,660	7,600	1,090	6,100	980	5,600	760
		10	0.010	9,000	1,590	9,000	1,440	6,600	950	5,400	860	5,000	680
		12	0.008	8,100	1,420	8,100	1,290	5,900	850	4,700	760	4,400	600
0.1	2.5	0.040	17,100	3,010	17,100	2,740	12,500	1,790	10,100	1,620	9,300	1,260	
	3	0.036	16,200	2,850	16,200	2,590	11,700	1,680	9,500	1,530	8,800	1,200	
	4	0.031	14,500	2,560	14,500	2,320	10,500	1,520	8,500	1,370	7,900	1,070	
	5	0.030	13,200	2,320	13,200	2,110	9,600	1,390	7,800	1,250	7,200	980	
	6	0.029	12,100	2,130	12,100	1,940	8,800	1,270	7,100	1,150	6,600	900	
	8	0.028	10,400	1,830	10,400	1,660	7,600	1,090	6,100	980	5,600	760	
	10	0.026	9,000	1,590	9,000	1,440	6,600	950	5,400	860	5,000	680	
	12	0.020	8,100	1,420	8,100	1,290	5,900	850	4,700	760	4,400	600	
0.2	2.5	0.068	17,100	3,010	17,100	2,740	12,500	1,790	10,100	1,620	9,300	1,260	
	3	0.061	16,200	2,850	16,200	2,590	11,700	1,680	9,500	1,530	8,800	1,200	
	4	0.052	14,500	2,560	14,500	2,320	10,500	1,520	8,500	1,370	7,900	1,070	
	5	0.051	13,200	2,320	13,200	2,110	9,600	1,390	7,800	1,250	7,200	980	
	6	0.049	12,100	2,130	12,100	1,940	8,800	1,270	7,100	1,150	6,600	900	
	8	0.048	10,400	1,830	10,400	1,660	7,600	1,090	6,100	980	5,600	760	
	10	0.045	9,000	1,590	9,000	1,440	6,600	950	5,400	860	5,000	680	
	12	0.034	8,100	1,420	8,100	1,290	5,900	850	4,700	760	4,400	600	
0.2	2.5	0.077	17,100	3,010	17,100	2,740	12,500	1,790	10,100	1,620	9,300	1,260	
	3	0.068	16,200	2,850	16,200	2,590	11,700	1,680	9,500	1,530	8,800	1,200	
	4	0.059	14,500	2,560	14,500	2,320	10,500	1,520	8,500	1,370	7,900	1,070	
	5	0.057	13,200	2,320	13,200	2,110	9,600	1,390	7,800	1,250	7,200	980	
	6	0.055	12,100	2,130	12,100	1,940	8,800	1,270	7,100	1,150	6,600	900	
	8	0.054	10,400	1,830	10,400	1,660	7,600	1,090	6,100	980	5,600	760	
	10	0.050	9,000	1,590	9,000	1,440	6,600	950	5,400	860	5,000	680	
	12	0.038	8,100	1,420	8,100	1,290	5,900	850	4,700	760	4,400	600	

超硬合金ドリル

EPDREH4-TH3

被削材 Work material				1		2		3		4		5	
				プリハードン鋼 Pre-hardened steels (35~45HRC)		焼入れ鋼 Hardened steels (45~55HRC)		焼入れ鋼 Hardened steels (55~60HRC)		焼入れ鋼 Hardened steels (60~65HRC)		焼入れ鋼 Hardened steels (65~72HRC)	
切り込み比率 Cutting depth ratio				120%		100%		70%		50%		25%	
外径DC Tool dia. (mm)	コーナ半径RE Corner radius (mm)	首下長 Under neck length (mm)	ap (mm)	回転数 n min ⁻¹	送り速度 Vf mm/min	回転数 n min ⁻¹	送り速度 Vf mm/min	回転数 n min ⁻¹	送り速度 Vf mm/min	回転数 n min ⁻¹	送り速度 Vf mm/min	回転数 n min ⁻¹	送り速度 Vf mm/min
2	0.3	2.5	0.081	17,100	3,010	17,100	2,740	12,500	1,790	10,100	1,620	9,300	1,260
		3	0.072	16,200	2,850	16,200	2,590	11,700	1,680	9,500	1,530	8,800	1,200
		4	0.062	14,500	2,560	14,500	2,320	10,500	1,520	8,500	1,370	7,900	1,070
		5	0.060	13,200	2,320	13,200	2,110	9,600	1,390	7,800	1,250	7,200	980
		6	0.058	12,100	2,130	12,100	1,940	8,800	1,270	7,100	1,150	6,600	900
		8	0.057	10,400	1,830	10,400	1,660	7,600	1,090	6,100	980	5,600	760
	0.5	10	0.053	9,000	1,590	9,000	1,440	6,600	950	5,400	860	5,000	680
		12	0.041	8,100	1,420	8,100	1,290	5,900	850	4,700	760	4,400	600
		2.5	0.085	17,100	3,010	17,100	2,740	12,500	1,790	10,100	1,620	9,300	1,260
		3	0.076	16,200	2,850	16,200	2,590	11,700	1,680	9,500	1,530	8,800	1,200
		4	0.065	14,500	2,560	14,500	2,320	10,500	1,520	8,500	1,370	7,900	1,070
		5	0.063	13,200	2,320	13,200	2,110	9,600	1,390	7,800	1,250	7,200	980
3	0.05	6	0.061	12,100	2,130	12,100	1,940	8,800	1,270	7,100	1,150	6,600	900
		8	0.061	10,400	1,830	10,400	1,660	7,600	1,090	6,100	980	5,600	760
		10	0.056	9,000	1,590	9,000	1,440	6,600	950	5,400	860	5,000	680
		12	0.043	8,100	1,420	8,100	1,290	5,900	850	4,700	760	4,400	600
		4	0.037	15,400	2,450	15,400	2,220	11,200	1,450	9,100	1,310	8,500	1,040
		6	0.036	12,800	2,030	12,800	1,840	9,300	1,200	7,600	1,090	7,000	850
		8	0.035	10,900	1,730	10,900	1,570	7,900	1,020	6,400	920	5,900	720
		10	0.034	9,500	1,500	9,500	1,360	6,900	900	5,600	800	5,100	630
	0.1	12	0.031	8,400	1,330	8,400	1,200	6,100	790	4,900	710	4,600	560
		14	0.029	7,500	1,190	7,500	1,080	5,500	710	4,400	630	4,100	500
		16	0.028	6,800	1,080	6,800	980	4,900	630	4,000	570	3,700	460
		18	0.025	6,200	990	6,200	900	4,500	580	3,700	520	3,400	420
		20	0.018	5,700	900	5,700	820	4,200	540	3,400	490	3,200	390
		4	0.075	15,400	2,450	15,400	2,220	11,200	1,450	9,100	1,310	8,500	1,040
		6	0.072	12,800	2,030	12,800	1,840	9,300	1,200	7,600	1,090	7,000	850
		8	0.070	10,900	1,730	10,900	1,570	7,900	1,020	6,400	920	5,900	720
	0.2	10	0.068	9,500	1,500	9,500	1,360	6,900	900	5,600	800	5,100	630
		12	0.063	8,400	1,330	8,400	1,200	6,100	790	4,900	710	4,600	560
		14	0.058	7,500	1,190	7,500	1,080	5,500	710	4,400	630	4,100	500
		16	0.056	6,800	1,080	6,800	980	4,900	630	4,000	570	3,700	460
		18	0.051	6,200	990	6,200	900	4,500	580	3,700	520	3,400	420
		20	0.037	5,700	900	5,700	820	4,200	540	3,400	490	3,200	390
		4	0.084	15,400	2,450	15,400	2,220	11,200	1,450	9,100	1,310	8,500	1,040
		6	0.081	12,800	2,030	12,800	1,840	9,300	1,200	7,600	1,090	7,000	850
0.3	8	0.079	10,900	1,730	10,900	1,570	7,900	1,020	6,400	920	5,900	720	
	10	0.076	9,500	1,500	9,500	1,360	6,900	900	5,600	800	5,100	630	
	12	0.070	8,400	1,330	8,400	1,200	6,100	790	4,900	710	4,600	560	
	14	0.065	7,500	1,190	7,500	1,080	5,500	710	4,400	630	4,100	500	
	16	0.063	6,800	1,080	6,800	980	4,900	630	4,000	570	3,700	460	
	18	0.057	6,200	990	6,200	900	4,500	580	3,700	520	3,400	420	
	20	0.041	5,700	900	5,700	820	4,200	540	3,400	490	3,200	390	
	4	0.089	15,400	2,450	15,400	2,220	11,200	1,450	9,100	1,310	8,500	1,040	
0.5	6	0.086	12,800	2,030	12,800	1,840	9,300	1,200	7,600	1,090	7,000	850	
	8	0.084	10,900	1,730	10,900	1,570	7,900	1,020	6,400	920	5,900	720	
	10	0.080	9,500	1,500	9,500	1,360	6,900	900	5,600	800	5,100	630	
	12	0.074	8,400	1,330	8,400	1,200	6,100	790	4,900	710	4,600	560	
	14	0.068	7,500	1,190	7,500	1,080	5,500	710	4,400	630	4,100	500	
	16	0.066	6,800	1,080	6,800	980	4,900	630	4,000	570	3,700	460	
	18	0.060	6,200	990	6,200	900	4,500	580	3,700	520	3,400	420	
	20	0.044	5,700	900	5,700	820	4,200	540	3,400	490	3,200	390	
0.5	4	0.094	15,400	2,450	15,400	2,220	11,200	1,450	9,100	1,310	8,500	1,040	
	6	0.090	12,800	2,030	12,800	1,840	9,300	1,200	7,600	1,090	7,000	850	
	8	0.088	10,900	1,730	10,900	1,570	7,900	1,020	6,400	920	5,900	720	
	10	0.084	9,500	1,500	9,500	1,360	6,900	900	5,600	800	5,100	630	
	12	0.078	8,400	1,330	8,400	1,200	6,100	790	4,900	710	4,600	560	
	14	0.072	7,500	1,190	7,500	1,080	5,500	710	4,400	630	4,100	500	
	16	0.070	6,800	1,080	6,800	980	4,900	630	4,000	570	3,700	460	
	18	0.063	6,200	990	6,200	900	4,500	580	3,700	520	3,400	420	
20	0.046	5,700	900	5,700	820	4,200	540	3,400	490	3,200	390		

【注意】 ご使用にあたっては、A193ページの表下の項目と注意を参照してください。 **【Note】** Refer to the comments and notes below the table on page A193 regarding usage.

エポックディープラジラスエボリューションハード-TH3

EPDREH4-TH3

4枚刃
4 Flutes

高能率切削条件
High-efficiency cutting conditions

高精度切削条件
High-accuracy cutting conditions

高能率切削条件はA184ページを参照してください。
Please refer to P.A184 about high efficiency cutting conditions

被削材 Work material				1		2		3		4		5		
				プリハードン鋼 Pre-hardened steels (35~45HRC)		焼入れ鋼 Hardened steels (45~55HRC)		焼入れ鋼 Hardened steels (55~60HRC)		焼入れ鋼 Hardened steels (60~65HRC)		焼入れ鋼 Hardened steels (65~72HRC)		
切り込み比率 Cutting depth ratio				120%		100%		70%		50%		25%		
外径DC Tool dia. (mm)	コーナ半径RE Corner radius (mm)	首下長 Under neck length (mm)	ap (mm)	回転数 n min ⁻¹	送り速度 Vf mm/min	回転数 n min ⁻¹	送り速度 Vf mm/min	回転数 n min ⁻¹	送り速度 Vf mm/min	回転数 n min ⁻¹	送り速度 Vf mm/min	回転数 n min ⁻¹	送り速度 Vf mm/min	
4	0.1	8	0.076	8,600	2,280	8,600	2,080	6,300	1,360	5,100	1,240	4,700	960	
		10	0.073	7,700	2,040	7,700	1,850	5,600	1,220	4,600	1,100	4,200	860	
		12	0.070	7,000	1,840	7,000	1,680	5,100	1,100	4,200	1,000	3,800	780	
		14	0.065	6,400	1,680	6,400	1,540	4,600	1,000	3,700	900	3,500	710	
		16	0.063	5,900	1,550	5,900	1,410	4,200	910	3,500	840	3,200	660	
		18	0.061	5,400	1,430	5,400	1,290	4,000	860	3,200	780	3,000	610	
		20	0.058	5,100	1,340	5,100	1,210	3,700	790	3,000	710	2,700	560	
		22	0.049	4,700	1,250	4,700	1,140	3,400	740	2,800	680	2,600	520	
	24	0.046	4,400	1,160	4,400	1,050	3,200	700	2,700	640	2,400	490		
	0.2	8	0.105	8,600	2,280	8,600	2,080	6,300	1,360	5,100	1,240	4,700	960	
		10	0.102	7,700	2,040	7,700	1,850	5,600	1,220	4,600	1,100	4,200	860	
		12	0.097	7,000	1,840	7,000	1,680	5,100	1,100	4,200	1,000	3,800	780	
		14	0.090	6,400	1,680	6,400	1,540	4,600	1,000	3,700	900	3,500	710	
		16	0.087	5,900	1,550	5,900	1,410	4,200	910	3,500	840	3,200	660	
		18	0.085	5,400	1,430	5,400	1,290	4,000	860	3,200	780	3,000	610	
		20	0.080	5,100	1,340	5,100	1,210	3,700	790	3,000	710	2,700	560	
		22	0.067	4,700	1,250	4,700	1,140	3,400	740	2,800	680	2,600	520	
	24	0.064	4,400	1,160	4,400	1,050	3,200	700	2,700	640	2,400	490		
	0.3	8	0.110	8,600	2,280	8,600	2,080	6,300	1,360	5,100	1,240	4,700	960	
		10	0.107	7,700	2,040	7,700	1,850	5,600	1,220	4,600	1,100	4,200	860	
		12	0.102	7,000	1,840	7,000	1,680	5,100	1,100	4,200	1,000	3,800	780	
		14	0.095	6,400	1,680	6,400	1,540	4,600	1,000	3,700	900	3,500	710	
		16	0.092	5,900	1,550	5,900	1,410	4,200	910	3,500	840	3,200	660	
		18	0.090	5,400	1,430	5,400	1,290	4,000	860	3,200	780	3,000	610	
		20	0.085	5,100	1,340	5,100	1,210	3,700	790	3,000	710	2,700	560	
		22	0.071	4,700	1,250	4,700	1,140	3,400	740	2,800	680	2,600	520	
	24	0.067	4,400	1,160	4,400	1,050	3,200	700	2,700	640	2,400	490		
	0.5	8	0.114	8,600	2,280	8,600	2,080	6,300	1,360	5,100	1,240	4,700	960	
		10	0.111	7,700	2,040	7,700	1,850	5,600	1,220	4,600	1,100	4,200	860	
		12	0.105	7,000	1,840	7,000	1,680	5,100	1,100	4,200	1,000	3,800	780	
		14	0.098	6,400	1,680	6,400	1,540	4,600	1,000	3,700	900	3,500	710	
		16	0.095	5,900	1,550	5,900	1,410	4,200	910	3,500	840	3,200	660	
		18	0.092	5,400	1,430	5,400	1,290	4,000	860	3,200	780	3,000	610	
		20	0.088	5,100	1,340	5,100	1,210	3,700	790	3,000	710	2,700	560	
		22	0.073	4,700	1,250	4,700	1,140	3,400	740	2,800	680	2,600	520	
	24	0.069	4,400	1,160	4,400	1,050	3,200	700	2,700	640	2,400	490		
	1	8	0.116	8,600	2,280	8,600	2,080	6,300	1,360	5,100	1,240	4,700	960	
		10	0.113	7,700	2,040	7,700	1,850	5,600	1,220	4,600	1,100	4,200	860	
		12	0.108	7,000	1,840	7,000	1,680	5,100	1,100	4,200	1,000	3,800	780	
		14	0.100	6,400	1,680	6,400	1,540	4,600	1,000	3,700	900	3,500	710	
		16	0.097	5,900	1,550	5,900	1,410	4,200	910	3,500	840	3,200	660	
		18	0.094	5,400	1,430	5,400	1,290	4,000	860	3,200	780	3,000	610	
		20	0.089	5,100	1,340	5,100	1,210	3,700	790	3,000	710	2,700	560	
		22	0.075	4,700	1,250	4,700	1,140	3,400	740	2,800	680	2,600	520	
	24	0.071	4,400	1,160	4,400	1,050	3,200	700	2,700	640	2,400	490		
	5	0.1	10	0.080	7,700	2,710	7,700	2,470	5,600	1,630	4,600	1,460	4,200	1,150
			15	0.067	6,100	2,160	6,100	1,970	4,500	1,290	3,700	1,170	3,300	900
			20	0.064	5,100	1,780	5,100	1,620	3,700	1,050	3,000	950	2,700	750
25			0.062	4,300	1,520	4,300	1,380	3,200	900	2,600	820	2,300	630	
0.2		10	0.102	7,700	2,710	7,700	2,470	5,600	1,630	4,600	1,460	4,200	1,150	
		15	0.086	6,100	2,160	6,100	1,970	4,500	1,290	3,700	1,170	3,300	900	
		20	0.081	5,100	1,780	5,100	1,620	3,700	1,050	3,000	950	2,700	750	
		25	0.079	4,300	1,520	4,300	1,380	3,200	900	2,600	820	2,300	630	
0.3		10	0.138	7,700	2,710	7,700	2,470	5,600	1,630	4,600	1,460	4,200	1,150	
		15	0.116	6,100	2,160	6,100	1,970	4,500	1,290	3,700	1,170	3,300	900	
		20	0.110	5,100	1,780	5,100	1,620	3,700	1,050	3,000	950	2,700	750	
		25	0.107	4,300	1,520	4,300	1,380	3,200	900	2,600	820	2,300	630	
0.5		10	0.142	7,700	2,710	7,700	2,470	5,600	1,630	4,600	1,460	4,200	1,150	
		15	0.120	6,100	2,160	6,100	1,970	4,500	1,290	3,700	1,170	3,300	900	
		20	0.114	5,100	1,780	5,100	1,620	3,700	1,050	3,000	950	2,700	750	
		25	0.110	4,300	1,520	4,300	1,380	3,200	900	2,600	820	2,300	630	

超硬合金ドリル

被削材 Work material				1		2		3		4		5	
				プリハードン鋼 Pre-hardened steels (35~45HRC)		焼入れ鋼 Hardened steels (45~55HRC)		焼入れ鋼 Hardened steels (55~60HRC)		焼入れ鋼 Hardened steels (60~65HRC)		焼入れ鋼 Hardened steels (65~72HRC)	
切り込み比率 Cutting depth ratio				120%		100%		70%		50%		25%	
外径DC Tool dia. (mm)	コーナ半径RE Corner radius (mm)	首下長 Under neck length (mm)	ap (mm)	回転数 n min ⁻¹	送り速度 Vf mm/min	回転数 n min ⁻¹	送り速度 Vf mm/min	回転数 n min ⁻¹	送り速度 Vf mm/min	回転数 n min ⁻¹	送り速度 Vf mm/min	回転数 n min ⁻¹	送り速度 Vf mm/min
5	1	10	0.145	7,700	2,710	7,700	2,470	5,600	1,630	4,600	1,460	4,200	1,150
		15	0.122	6,100	2,160	6,100	1,970	4,500	1,290	3,700	1,170	3,300	900
		20	0.116	5,100	1,780	5,100	1,620	3,700	1,050	3,000	950	2,700	750
		25	0.112	4,300	1,520	4,300	1,380	3,200	900	2,600	820	2,300	630
6	0.1	12	0.082	6,900	2,730	6,900	2,480	5,100	1,640	4,100	1,460	3,700	1,150
		18	0.073	5,400	2,130	5,400	1,940	3,900	1,260	3,200	1,140	2,900	890
		24	0.068	4,400	1,740	4,400	1,590	3,200	1,050	2,600	930	2,400	740
		30	0.065	3,700	1,480	3,700	1,340	2,700	890	2,200	810	2,000	610
	0.2	12	0.147	6,900	2,730	6,900	2,480	5,100	1,640	4,100	1,460	3,700	1,150
		18	0.131	5,400	2,130	5,400	1,940	3,900	1,260	3,200	1,140	2,900	890
		24	0.123	4,400	1,740	4,400	1,590	3,200	1,050	2,600	930	2,400	740
		30	0.118	3,700	1,480	3,700	1,340	2,700	890	2,200	810	2,000	610
	0.3	12	0.155	6,900	2,730	6,900	2,480	5,100	1,640	4,100	1,460	3,700	1,150
		18	0.138	5,400	2,130	5,400	1,940	3,900	1,260	3,200	1,140	2,900	890
		24	0.129	4,400	1,740	4,400	1,590	3,200	1,050	2,600	930	2,400	740
		30	0.124	3,700	1,480	3,700	1,340	2,700	890	2,200	810	2,000	610
	0.5	12	0.160	6,900	2,730	6,900	2,480	5,100	1,640	4,100	1,460	3,700	1,150
		18	0.142	5,400	2,130	5,400	1,940	3,900	1,260	3,200	1,140	2,900	890
		24	0.133	4,400	1,740	4,400	1,590	3,200	1,050	2,600	930	2,400	740
		30	0.128	3,700	1,480	3,700	1,340	2,700	890	2,200	810	2,000	610
	1	12	0.163	6,900	2,730	6,900	2,480	5,100	1,640	4,100	1,460	3,700	1,150
		18	0.145	5,400	2,130	5,400	1,940	3,900	1,260	3,200	1,140	2,900	890
		24	0.136	4,400	1,740	4,400	1,590	3,200	1,050	2,600	930	2,400	740
		30	0.131	3,700	1,480	3,700	1,340	2,700	890	2,200	810	2,000	610

- (1) a_p は被削材グループ2での目安を示しています。その他のグループの場合は、上表の切り込み比率を目安に調整してください。
(2) リブ加工や止まり溝など、切りくずがつまりやすい切削の場合、切り込み設定は基本切り込みで切り込み比率をかけて算出した切り込み量を、さらにその80%まで小さくして使用してください。
(3) a_e の設定は $a_p \times$ 切り込み比率 $\times 5$ 倍以下を目安に調整してください。仕上げ加工を行う場合、理論カスプハイトを計算し設定してください。
(4) 彫り込み時の傾斜進入角は 1° 以下を推奨いたします。また、送り速度は条件表の70%以下に調整してください。
(5) 文字彫り加工のような溝切削の際は、送り速度は50%以下・ a_p を30%以下を目安に調整してください。また往復切削による加工を推奨いたします。
- (1) a_p indicates guidelines for Group 2 workpieces. For other groups, adjust cutting depth based on the cutting depth factors in the above table.
(2) In cases in which cutting chips may cause clogging--for example, for rib cutting and blind grooves--set the cutting depth using a cutting depth factor to calculate the cutting depth amount. This amount should then be reduced to 80% of the calculated value.
(3) Adjust by setting a_e to (5 or less) \times (a_p) \times (cutting depth ratio). For finishing cutting, calculate the theoretical cusp height and set accordingly.
(4) The recommended slope entrance angle when engraving is 1° or less. Adjust the feed rate to 70% or less of values presented in the cutting condition table.
(5) When slotting such engraving letters, adjust the feed rate to 50% or less and a_p to 30% or less of the values shown. We recommend reciprocal cutting.

【切り込み設定例】

EPDREH4010-2-02-TH3の工具で焼入れ鋼(50HRC)をリブ溝等高線切削する場合、
切り込み=0.039(a_p) $\times 1$ (焼入れ鋼グループ2の切り込み比率) $\times 0.8$ (閉鎖域の切削)=0.0312mm

Cutting depth setting example: When cutting rib groove contours in hardened steel (50HRC) using an EPDREH4010-2-02-TH3 tool:
Cutting depth = 0.039 (a_p) $\times 1$ (cutting depth factor for Group 2 Hardened steels) $\times 0.8$ (for closed-area cutting) = 0.0312mm

- 【注意】** ①被削材、加工形状に合わせて、適切なクーラントを使用してください。
②この標準切削条件表は切削条件の目安を示すものです。実際の加工では加工形状、目的、使用機械等により条件を調整してください。
③機械の回転数が足りない場合は、回転数と送り速度を同じ比率で下げてください。

- 【Note】** ① Use the appropriate coolant for the work material and machining shape.
② These Recommended Cutting Conditions indicate only the rule of a thumb for the cutting conditions. In actual machining, the condition should be adjusted according to the machining shape, purpose and the machine type.
③ If the rpm of the machine is low, lower the feed rate also to put the rpm and feed rate in the same ratio.

エポックディープラジアスエボリューション

ストレートネック

Straight Neck

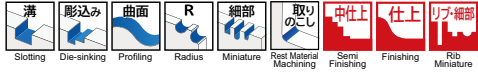

RE公差 ±0.005 (中心基準 central axis)



刃先と首形状の改良によりタオレを抑制し高精度加工を実現。
ATHコーティングの採用で更なる長寿命加工。
Improved flute tip shape and neck shape suppresses warping to enable high-accuracy cutting.
Use of ATH coating further extends tool life.

外径φ4以上はバックドラフト形状ではありません。
φ 4 or higher does not have backdraft shape.

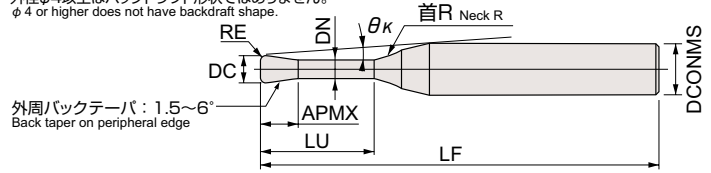

外周バックテーパ: 1.5~6°
Back taper on peripheral edge



EPDRE2-ATH

商品コード Item code	在庫 Stock	寸法 Size(mm)										干渉角度 Interference angle (°) θκ	勾配角に対する実有効首下長 Effective under neck length with respect to draft angle					希望小売 価格 (円) Suggested retail price (¥)
		外径 Tool dia. DC	コーナ半径 Corner radius RE	首下長 Under neck length LU	刃長 Flute length APMX	首径 Neck dia. DN	全長 Overall length LF	シャンク径 Shank dia. DCONMS	首R Neck R	0.5° 1° 1.5° 2° 3°								
										0.5°	1°		1.5°	2°	3°			
EPDRE2002-0.5-002-ATH	●	0.2	0.02	0.5	0.15	0.17	50	4	1	11.33	0.70	0.73	0.75	0.78	0.83	10,610		
EPDRE2002-1-002-ATH	●			1	0.15	0.17	50	4	1	10.77	1.22	1.26	1.30	1.34	1.41	10,610		
EPDRE2002-2-002-ATH	●			2	0.15	0.17	50	4	1	9.81	2.26	2.32	2.38	2.47	2.74	10,610		
EPDRE2002-0.5-005-ATH	●			0.5	0.15	0.17	50	4	1	11.36	0.70	0.73	0.75	0.78	0.82	10,610		
EPDRE2002-1-005-ATH	●			1	0.15	0.17	50	4	1	10.81	1.22	1.26	1.30	1.34	1.40	10,610		
EPDRE2002-1.5-005-ATH	●			1.5	0.15	0.17	50	4	1	10.30	1.74	1.79	1.84	1.89	2.06	10,610		
EPDRE2002-2-005-ATH	●	2	0.15	0.17	50	4	1	9.84	2.25	2.32	2.38	2.46	2.73	10,610				
EPDRE2003-1-002-ATH	●	0.3	0.02	1	0.25	0.27	50	4	2	10.74	1.32	1.39	1.45	1.51	1.62	10,260		
EPDRE2003-2-002-ATH	●			2	0.25	0.27	50	4	2	9.77	2.37	2.47	2.56	2.64	2.78	10,260		
EPDRE2003-3-002-ATH	●			3	0.25	0.27	50	4	2	8.95	3.42	3.54	3.65	3.74	4.06	11,370		
EPDRE2003-1-005-ATH	●			1	0.25	0.27	50	4	2	10.78	1.32	1.39	1.45	1.50	1.61	10,260		
EPDRE2003-1.5-005-ATH	●			1.5	0.25	0.27	50	4	2	10.26	1.84	1.93	2.01	2.07	2.20	10,260		
EPDRE2003-2-005-ATH	●			2	0.25	0.27	50	4	2	9.79	2.37	2.47	2.56	2.64	2.77	10,260		
EPDRE2003-2.5-005-ATH	●	2.5	0.25	0.27	50	4	2	9.36	2.89	3.01	3.10	3.19	3.39	11,370				
EPDRE2003-3-005-ATH	●	3	0.25	0.27	50	4	2	8.97	3.41	3.54	3.65	3.74	4.05	11,370				
EPDRE2004-1-002-ATH	●	0.4	0.02	1	0.3	0.37	50	4	2	10.71	1.32	1.39	1.45	1.51	1.62	6,840		
EPDRE2004-2-002-ATH	●			2	0.3	0.37	50	4	2	9.72	2.37	2.47	2.56	2.64	2.78	6,840		
EPDRE2004-3-002-ATH	●			3	0.3	0.37	50	4	2	8.89	3.42	3.54	3.65	3.74	4.06	6,840		
EPDRE2004-4-002-ATH	●			4	0.3	0.37	50	4	2	8.19	4.46	4.60	4.73	4.86	5.39	6,840		
EPDRE2004-1-005-ATH	●			1	0.3	0.37	50	4	2	10.75	1.32	1.39	1.45	1.50	1.61	6,840		
EPDRE2004-1.5-005-ATH	●			1.5	0.3	0.37	50	4	2	10.22	1.84	1.93	2.01	2.07	2.20	6,840		
EPDRE2004-2-005-ATH	●	2	0.3	0.37	50	4	2	9.74	2.37	2.47	2.56	2.64	2.77	6,840				
EPDRE2004-2.5-005-ATH	●	2.5	0.3	0.37	50	4	2	9.31	2.89	3.01	3.10	3.19	3.39	6,840				
EPDRE2004-3-005-ATH	●	3	0.3	0.37	50	4	2	8.91	3.41	3.54	3.65	3.74	4.05	6,840				
EPDRE2004-3.5-005-ATH	●	3.5	0.3	0.37	50	4	2	8.54	3.93	4.07	4.19	4.29	4.72	6,840				
EPDRE2004-4-005-ATH	●	4	0.3	0.37	50	4	2	8.21	4.45	4.60	4.72	4.86	5.38	6,840				
EPDRE2004-1-01-ATH	●	0.1	0.01	1	0.3	0.37	50	4	2	10.80	1.31	1.38	1.44	1.50	1.60	6,840		
EPDRE2004-2-01-ATH	●			2	0.3	0.37	50	4	2	9.79	2.37	2.47	2.55	2.63	2.77	6,840		
EPDRE2004-3-01-ATH	●			3	0.3	0.37	50	4	2	8.95	3.41	3.54	3.64	3.74	4.04	6,840		
EPDRE2004-4-01-ATH	●			4	0.3	0.37	50	4	2	8.24	4.45	4.60	4.72	4.85	5.37	6,840		
EPDRE2005-1-002-ATH	●	0.5	0.02	1	0.35	0.47	50	4	2	10.68	1.32	1.39	1.45	1.51	1.62	5,550		
EPDRE2005-2-002-ATH	●			2	0.35	0.47	50	4	2	9.66	2.37	2.47	2.56	2.64	2.78	5,550		
EPDRE2005-3-002-ATH	●			3	0.35	0.47	50	4	2	8.82	3.42	3.54	3.65	3.74	4.06	5,550		
EPDRE2005-4-002-ATH	●			4	0.35	0.47	50	4	2	8.11	4.46	4.60	4.73	4.86	5.39	5,550		
EPDRE2005-6-002-ATH	●			6	0.35	0.47	50	4	2	6.99	6.53	6.71	6.92	7.26	8.05	5,550		
EPDRE2005-1-005-ATH	●			1	0.35	0.47	50	4	2	10.71	1.32	1.39	1.45	1.50	1.61	5,550		
EPDRE2005-2-005-ATH	●	2	0.35	0.47	50	4	2	9.69	2.37	2.47	2.56	2.64	2.77	5,550				
EPDRE2005-3-005-ATH	●	3	0.35	0.47	50	4	2	8.84	3.41	3.54	3.65	3.74	4.05	5,550				
EPDRE2005-4-005-ATH	●	4	0.35	0.47	50	4	2	8.13	4.45	4.60	4.72	4.86	5.38	5,550				
EPDRE2005-5-005-ATH	●	5	0.35	0.47	50	4	2	7.53	5.49	5.66	5.79	6.05	6.71	5,550				
EPDRE2005-6-005-ATH	●	6	0.35	0.47	50	4	2	7.00	6.53	6.71	6.91	7.25	8.04	5,550				
EPDRE2005-1-01-ATH	●	0.1	0.01	1	0.35	0.47	50	4	2	10.77	1.31	1.38	1.44	1.50	1.60	5,550		
EPDRE2005-2-01-ATH	●			2	0.35	0.47	50	4	2	9.74	2.37	2.47	2.55	2.63	2.77	5,550		
EPDRE2005-3-01-ATH	●			3	0.35	0.47	50	4	2	8.88	3.41	3.54	3.64	3.74	4.04	5,550		
EPDRE2005-4-01-ATH	●			4	0.35	0.47	50	4	2	8.17	4.45	4.60	4.72	4.85	5.37	5,550		
EPDRE2005-5-01-ATH	●			5	0.35	0.47	50	4	2	7.55	5.49	5.66	5.79	6.04	6.69	5,550		
EPDRE2005-6-01-ATH	●			6	0.35	0.47	50	4	2	7.03	6.52	6.71	6.90	7.24	8.02	5,550		
EPDRE2006-2-002-ATH	●	0.6	0.02	2	0.4	0.57	50	4	4	9.61	2.54	2.70	2.83	2.96	3.19	5,550		
EPDRE2006-4-002-ATH	●			4	0.4	0.57	50	4	4	8.04	4.66	4.88	5.07	5.24	5.52	5,550		
EPDRE2006-6-002-ATH	●			6	0.4	0.57	50	4	4	6.90	6.76	7.03	7.26	7.45	8.05	5,550		
EPDRE2006-2-005-ATH	●			2	0.4	0.57	50	4	4	9.64	2.54	2.69	2.83	2.95	3.18	5,550		
EPDRE2006-4-005-ATH	●			4	0.4	0.57	50	4	4	8.06	4.66	4.88	5.07	5.23	5.52	5,550		
EPDRE2006-6-005-ATH	●			6	0.4	0.57	50	4	4	6.92	6.76	7.03	7.26	7.45	8.04	5,550		
EPDRE2006-8-005-ATH	●	8	0.4	0.57	50	4	4	6.06	8.85	9.16	9.41	9.64	10.69	5,550				
EPDRE2006-10-005-ATH	●	10	0.4	0.57	50	4	4	5.39	10.93	11.28	11.55	12.04	13.35	5,550				
EPDRE2006-2-01-ATH	●	0.1	0.01	2	0.4	0.57	50	4	4	9.68	2.53	2.69	2.82	2.95	3.17	5,550		
EPDRE2006-4-01-ATH	●			4	0.4	0.57	50	4	4	8.09	4.65	4.88	5.06	5.23	5.51	5,550		
EPDRE2006-6-01-ATH	●			6	0.4	0.57	50	4	4	6.94	6.76	7.03	7.25	7.44	8.02	5,550		
EPDRE2006-8-01-ATH	●			8	0.4	0.57	50	4	4	6.08	8.85	9.16	9.41	9.63	10.67	5,550		
EPDRE2006-10-01-ATH	●	10	0.4	0.57	50	4	4	5.41	10.92	11.27	11.55	12.03	13.33	5,550				

● : 標準在庫品です。● : Stocked items.

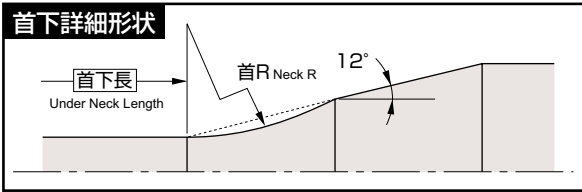

【注意】
 エポックディーブラジスEPDRとは有効首下長が異なります。再度ご確認ください。

【Note】
 The effective under-neck length is different from Epoch Deep Radius EPDR. Please recheck the interference region.

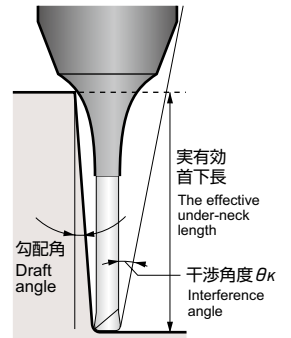

EPDRE2○○○○-○○.○-○○○-ATH

商品コード Item code	在庫 Stock	寸法 Size(mm)								干渉角度 Interference angle (°) θ _k	勾配角に対する実有効首下長 Effective under neck length with respect to draft angle					希望小売価格(円) Suggested retail price (¥)	
		外径 Tool dia. DC	コーナ半径 Corner radius RE	首下長 Under neck length LU	刃長 Flute length APMX	首径 Neck dia. DN	全長 Overall length LF	シャン径 Shank dia. DCONMS	首R Neck R		0.5°	1°	1.5°	2°	3°		
											0.5°	1°	1.5°	2°	3°		
EPDRE2007-2-005-ATH	●	0.7	0.05	2	0.45	0.67	50	4	4	9.58	2.54	2.69	2.83	2.95	3.18	5,900	
EPDRE2007-4-005-ATH	●			4	0.45	0.67	50	4	4	7.98	4.66	4.88	5.07	5.23	5.52	5,900	
EPDRE2007-6-005-ATH	●			6	0.45	0.67	50	4	4	6.83	6.76	7.03	7.26	7.45	8.04	5,900	
EPDRE2007-2-01-ATH	●		0.1	2	0.45	0.67	50	4	4	9.63	2.53	2.69	2.82	2.95	3.17	5,900	
EPDRE2007-4-01-ATH	●			4	0.45	0.67	50	4	4	8.01	4.65	4.88	5.06	5.23	5.51	5,900	
EPDRE2007-6-01-ATH	●			6	0.45	0.67	50	4	4	6.86	6.76	7.03	7.25	7.44	8.02	5,900	
EPDRE2008-2-002-ATH	●	0.8	0.02	2	0.5	0.77	50	4	4	9.49	2.54	2.70	2.83	2.96	3.19	6,370	
EPDRE2008-4-002-ATH	●			4	0.5	0.77	50	4	4	7.87	4.66	4.88	5.07	5.24	5.52	6,370	
EPDRE2008-6-002-ATH	●			6	0.5	0.77	50	4	4	6.73	6.76	7.03	7.26	7.45	8.05	6,370	
EPDRE2008-2-005-ATH	●		0.05	2	0.5	0.77	50	4	4	9.52	2.54	2.69	2.83	2.95	3.18	6,370	
EPDRE2008-4-005-ATH	●			4	0.5	0.77	50	4	4	7.89	4.66	4.88	5.07	5.23	5.52	6,370	
EPDRE2008-6-005-ATH	●			6	0.5	0.77	50	4	4	6.74	6.76	7.03	7.26	7.45	8.04	6,370	
EPDRE2008-8-005-ATH	●		0.1	8	0.5	0.77	50	4	4	5.88	8.85	9.16	9.41	9.64	10.69	6,370	
EPDRE2008-12-005-ATH	●			12	0.5	0.77	55	4	4	4.68	13.00	13.38	13.75	14.43	16.00	6,370	
EPDRE2008-2-01-ATH	●			0.2	2	0.5	0.77	50	4	4	9.57	2.53	2.69	2.82	2.95	3.17	6,370
EPDRE2008-4-01-ATH	●		4		0.5	0.77	50	4	4	7.93	4.65	4.88	5.06	5.23	5.51	6,370	
EPDRE2008-6-01-ATH	●		6		0.5	0.77	50	4	4	6.77	6.76	7.03	7.25	7.44	8.02	6,370	
EPDRE2008-8-01-ATH	●		0.1	8	0.5	0.77	50	4	4	5.90	8.85	9.16	9.41	9.63	10.67	6,370	
EPDRE2008-12-01-ATH	●			12	0.5	0.77	55	4	4	4.70	13.00	13.38	13.75	14.42	15.98	6,370	
EPDRE2008-2-02-ATH	●			0.2	2	0.5	0.77	50	4	4	9.67	2.53	2.68	2.81	2.93	3.15	6,370
EPDRE2008-4-02-ATH	●		4		0.5	0.77	50	4	4	8.00	4.65	4.87	5.05	5.21	5.50	6,370	
EPDRE2008-6-02-ATH	●		6		0.5	0.77	50	4	4	6.82	6.75	7.02	7.24	7.43	7.99	6,370	
EPDRE2008-8-02-ATH	●		0.1	8	0.5	0.77	50	4	4	5.94	8.84	9.15	9.40	9.62	10.64	6,370	
EPDRE2008-12-02-ATH	●			12	0.5	0.77	55	4	4	4.72	12.99	13.37	13.73	14.40	15.95	6,370	
EPDRE2010-2-002-ATH	●	1		0.02	2	0.8	0.94	50	4	4	9.29	2.64	2.78	2.91	3.03	3.24	5,430
EPDRE2010-4-002-ATH	●		4		0.8	0.94	50	4	4	7.65	4.75	4.95	5.13	5.29	5.56	5,430	
EPDRE2010-6-002-ATH	●		6		0.8	0.94	50	4	4	6.50	6.84	7.09	7.31	7.49	8.14	5,900	
EPDRE2010-8-002-ATH	●		0.05	8	0.8	0.94	50	4	4	5.65	8.92	9.21	9.46	9.73	10.79	5,900	
EPDRE2010-10-002-ATH	●			10	0.8	0.94	50	4	4	5.00	10.99	11.32	11.59	12.13	13.45	5,900	
EPDRE2010-12-002-ATH	●			12	0.8	0.94	55	4	4	4.48	13.06	13.42	13.84	14.52	16.10	5,900	
EPDRE2010-2-005-ATH	●		0.05	2	0.8	0.94	50	4	4	9.32	2.64	2.78	2.91	3.02	3.24	5,430	
EPDRE2010-3-005-ATH	●			3	0.8	0.94	50	4	4	8.41	3.70	3.87	4.02	4.16	4.41	5,430	
EPDRE2010-4-005-ATH	●			4	0.8	0.94	50	4	4	7.67	4.75	4.95	5.13	5.28	5.56	5,430	
EPDRE2010-5-005-ATH	●			5	0.8	0.94	50	4	4	7.04	5.79	6.02	6.22	6.39	6.80	5,430	
EPDRE2010-6-005-ATH	●			6	0.8	0.94	50	4	4	6.51	6.84	7.09	7.30	7.49	8.13	5,900	
EPDRE2010-8-005-ATH	●			8	0.8	0.94	50	4	4	5.66	8.92	9.21	9.46	9.73	10.78	5,900	
EPDRE2010-10-005-ATH	●			10	0.8	0.94	50	4	4	5.00	10.99	11.32	11.59	12.12	13.44	5,900	
EPDRE2010-12-005-ATH	●			12	0.8	0.94	55	4	4	4.48	13.06	13.42	13.84	14.51	16.09	5,900	
EPDRE2010-16-005-ATH	●			16	0.8	0.94	60	4	4	3.71	17.18	17.60	18.40	19.30	21.40	7,790	
EPDRE2010-20-005-ATH	●			20	0.8	0.94	60	4	4	3.17	21.29	21.93	22.96	24.09	26.71	8,610	
EPDRE2010-2-01-ATH	●			0.1	2	0.8	0.94	50	4	4	9.37	2.64	2.78	2.90	3.01	3.23	5,430
EPDRE2010-3-01-ATH	●				3	0.8	0.94	50	4	4	8.45	3.69	3.87	4.02	4.15	4.40	5,430
EPDRE2010-4-01-ATH	●	4	0.8		0.94	50	4	4	7.70	4.74	4.95	5.12	5.28	5.55	5,430		
EPDRE2010-5-01-ATH	●	5	0.8		0.94	50	4	4	7.07	5.79	6.02	6.21	6.39	6.79	5,430		
EPDRE2010-6-01-ATH	●	6	0.8		0.94	50	4	4	6.54	6.83	7.09	7.30	7.49	8.11	5,900		
EPDRE2010-8-01-ATH	●	8	0.8		0.94	50	4	4	5.68	8.91	9.21	9.45	9.72	10.77	5,900		
EPDRE2010-10-01-ATH	●	10	0.8		0.94	50	4	4	5.02	10.99	11.32	11.59	12.11	13.42	5,900		
EPDRE2010-12-01-ATH	●	12	0.8		0.94	55	4	4	4.50	13.06	13.42	13.83	14.50	16.08	5,900		
EPDRE2010-16-01-ATH	●	16	0.8		0.94	60	4	4	3.72	17.18	17.60	18.39	19.29	21.39	7,790		
EPDRE2010-20-01-ATH	●	20	0.8		0.94	60	4	4	3.17	21.29	21.93	22.95	24.08	26.70	8,610		
EPDRE2010-2-02-ATH	●	0.2	2		0.8	0.94	50	4	4	9.47	2.63	2.77	2.89	3.00	3.21	5,430	
EPDRE2010-3-02-ATH	●		3		0.8	0.94	50	4	4	8.54	3.69	3.86	4.01	4.14	4.39	5,430	
EPDRE2010-4-02-ATH	●		4	0.8	0.94	50	4	4	7.77	4.74	4.94	5.11	5.27	5.54	5,430		
EPDRE2010-5-02-ATH	●		5	0.8	0.94	50	4	4	7.13	5.79	6.01	6.21	6.38	6.75	5,430		
EPDRE2010-6-02-ATH	●		6	0.8	0.94	50	4	4	6.59	6.83	7.08	7.29	7.48	8.08	5,900		
EPDRE2010-8-02-ATH	●		8	0.8	0.94	50	4	4	5.72	8.91	9.20	9.45	9.70	10.74	5,900		
EPDRE2010-10-02-ATH	●		10	0.8	0.94	50	4	4	5.05	10.98	11.32	11.58	12.09	13.39	5,900		
EPDRE2010-12-02-ATH	●		12	0.8	0.94	55	4	4	4.52	13.05	13.42	13.81	14.48	16.05	5,900		
EPDRE2010-16-02-ATH	●		16	0.8	0.94	60	4	4	3.74	17.18	17.59	18.38	19.27	21.35	7,790		
EPDRE2010-20-02-ATH	●		20	0.8	0.94	60	4	4	3.19	21.29	21.92	22.94	24.06	26.66	8,610		

Carbide End Mills
 Radius End Mills

エポックディープラジアスエボリューション

超幅径エポックディープラジアスエボリューション

EPDRE2○○○○-○○.○-○○○-ATH

商品コード Item code	在庫 Stock	寸法 Size(mm)									干渉角度 Interference angle (°)	勾配角に対する実有効首下長 Effective under neck length with respect to draft angle					希望小売 価格 (円) Suggested retail price (¥)
		外径 Tool dia.	コーナ半径 Corner radius	首下長 Under neck length	刃長 Flute length	首径 Neck dia.	全長 Overall length	シャンク径 Shank dia.	首R	θκ		0.5°	1°	1.5°	2°	3°	
		DC	RE	LU	APMX	DN	LF	DCONMS	Neck R								
EPDRE2010-2-03-ATH	●	1	0.3	2	0.8	0.94	50	4	4	9.57	2.63	2.76	2.87	2.98	3.19	5,430	
EPDRE2010-3-03-ATH	●			3	0.8	0.94	50	4	4	8.62	3.68	3.85	3.99	4.13	4.37	5,430	
EPDRE2010-4-03-ATH	●			4	0.8	0.94	50	4	4	7.84	4.73	4.93	5.10	5.25	5.53	5,430	
EPDRE2010-5-03-ATH	●			5	0.8	0.94	50	4	4	7.19	5.78	6.01	6.20	6.37	6.72	5,430	
EPDRE2010-6-03-ATH	●			6	0.8	0.94	50	4	4	6.64	6.82	7.07	7.28	7.47	8.05	5,900	
EPDRE2010-8-03-ATH	●			8	0.8	0.94	50	4	4	5.75	8.91	9.20	9.44	9.68	10.70	5,900	
EPDRE2010-10-03-ATH	●			10	0.8	0.94	50	4	4	5.08	10.98	11.31	11.58	12.07	13.36	5,900	
EPDRE2010-12-03-ATH	●			12	0.8	0.94	55	4	4	4.54	13.05	13.41	13.80	14.46	16.01	5,900	
EPDRE2010-16-03-ATH	●			16	0.8	0.94	60	4	4	3.75	17.17	17.59	18.36	19.25	21.32	7,790	
EPDRE2010-20-03-ATH	●			20	0.8	0.94	60	4	4	3.20	21.28	21.91	22.92	24.04	26.63	8,610	
EPDRE20125-5-01-ATH	●	1.25	0.1	5	1.15	1.18	50	4	4	6.80	5.81	6.04	6.23	6.40	6.82	6,020	
EPDRE20125-10-01-ATH	●			10	1.15	1.18	50	4	4	4.76	11.01	11.34	11.60	12.14	13.45	6,020	
EPDRE20125-15-01-ATH	●			15	1.15	1.18	55	4	4	3.66	16.17	16.57	17.28	18.12	20.09	6,020	
EPDRE20125-20-01-ATH	●		20	1.15	1.18	60	4	4	2.97	21.30	21.95	22.98	24.10	干涉なし	9,200		
EPDRE20125-5-02-ATH	●		0.2	5	1.15	1.18	50	4	4	6.86	5.81	6.03	6.22	6.39	6.79	6,020	
EPDRE20125-10-02-ATH	●			10	1.15	1.18	50	4	4	4.79	11.00	11.33	11.59	12.12	13.42	6,020	
EPDRE20125-15-02-ATH	●			15	1.15	1.18	55	4	4	3.68	16.16	16.56	17.26	18.10	20.06	6,020	
EPDRE20125-20-02-ATH	●		20	1.15	1.18	60	4	4	2.98	21.30	21.95	22.97	24.09	干涉なし	9,200		
EPDRE20125-5-03-ATH	●		0.3	5	1.15	1.18	50	4	4	6.92	5.81	6.03	6.21	6.38	6.75	6,020	
EPDRE20125-10-03-ATH	●			10	1.15	1.18	50	4	4	4.82	11.00	11.32	11.59	12.10	13.39	6,020	
EPDRE20125-15-03-ATH	●			15	1.15	1.18	55	4	4	3.69	16.16	16.56	17.25	18.08	20.03	6,020	
EPDRE20125-20-03-ATH	●		20	1.15	1.18	60	4	4	2.99	21.30	21.94	22.95	24.07	干涉なし	9,200		
EPDRE2015-4-01-ATH	●		1.5	0.1	4	1.35	1.42	50	4	4	7.15	4.80	4.99	5.16	5.31	5.58	5,780
EPDRE2015-6-01-ATH	●				6	1.35	1.42	50	4	4	5.97	6.88	7.12	7.33	7.51	8.18	5,780
EPDRE2015-8-01-ATH	●				8	1.35	1.42	50	4	4	5.12	8.96	9.24	9.48	9.77	10.83	6,020
EPDRE2015-12-01-ATH	●	12			1.35	1.42	55	4	4	3.98	13.09	13.45	13.88	14.56	16.14	6,020	
EPDRE2015-15-01-ATH	●	15			1.35	1.42	55	4	4	3.42	16.18	16.58	17.30	18.15	20.12	6,020	
EPDRE2015-20-01-ATH	●	20		1.35	1.42	60	4	4	2.76	21.32	21.98	23.01	24.13	干涉なし	6,020		
EPDRE2015-4-02-ATH	●	0.2		4	1.35	1.42	50	4	4	7.22	4.79	4.98	5.15	5.30	5.57	5,780	
EPDRE2015-6-02-ATH	●			6	1.35	1.42	50	4	4	6.02	6.88	7.12	7.32	7.50	8.14	5,780	
EPDRE2015-8-02-ATH	●			8	1.35	1.42	50	4	4	5.16	8.95	9.24	9.47	9.75	10.80	6,020	
EPDRE2015-12-02-ATH	●			12	1.35	1.42	55	4	4	4.01	13.09	13.44	13.87	14.54	16.11	6,020	
EPDRE2015-15-02-ATH	●			15	1.35	1.42	55	4	4	3.43	16.18	16.58	17.29	18.13	20.09	6,020	
EPDRE2015-20-02-ATH	●	20		1.35	1.42	60	4	4	2.77	21.32	21.97	22.99	24.11	干涉なし	6,020		
EPDRE2015-4-03-ATH	●	0.3		4	1.35	1.42	50	4	4	7.30	4.79	4.97	5.14	5.29	5.55	5,780	
EPDRE2015-6-03-ATH	●			6	1.35	1.42	50	4	4	6.07	6.87	7.11	7.31	7.49	8.11	5,780	
EPDRE2015-8-03-ATH	●			8	1.35	1.42	50	4	4	5.19	8.95	9.23	9.47	9.73	10.77	6,020	
EPDRE2015-12-03-ATH	●			12	1.35	1.42	55	4	4	4.03	13.09	13.44	13.85	14.52	16.08	6,020	
EPDRE2015-15-03-ATH	●			15	1.35	1.42	55	4	4	3.45	16.18	16.57	17.28	18.11	20.06	6,020	
EPDRE2015-20-03-ATH	●	20		1.35	1.42	60	4	4	2.78	21.31	21.96	22.98	24.09	干涉なし	6,020		
EPDRE2015-4-05-ATH	●	0.5		4	1.35	1.42	50	4	4	7.45	4.78	4.96	5.12	5.26	5.53	5,780	
EPDRE2015-6-05-ATH	●			6	1.35	1.42	50	4	4	6.17	6.86	7.10	7.30	7.48	8.05	5,780	
EPDRE2015-8-05-ATH	●		8	1.35	1.42	50	4	4	5.27	8.94	9.22	9.45	9.70	10.70	6,020		
EPDRE2015-12-05-ATH	●		12	1.35	1.42	55	4	4	4.07	13.08	13.43	13.83	14.48	16.01	6,020		
EPDRE2015-15-05-ATH	●		15	1.35	1.42	55	4	4	3.48	16.17	16.56	17.25	18.07	19.99	6,020		
EPDRE2015-20-05-ATH	●	20	1.35	1.42	60	4	4	2.80	21.31	21.95	22.95	24.06	干涉なし	6,020			
EPDRE20175-5-01-ATH	●	1.75	0.1	5	1.55	1.67	50	4	4	6.19	5.84	6.06	6.25	6.42	6.85	5,780	
EPDRE20175-10-01-ATH	●			10	1.55	1.67	50	4	4	4.19	11.03	11.35	11.61	12.17	13.49	6,020	
EPDRE20175-15-01-ATH	●			15	1.55	1.67	55	4	4	3.16	16.18	16.58	17.30	18.15	20.12	6,020	
EPDRE20175-20-01-ATH	●		20	1.55	1.67	60	4	4	2.54	21.32	21.98	23.01	24.13	干涉なし	6,020		
EPDRE20175-5-02-ATH	●		0.2	5	1.55	1.67	50	4	4	6.25	5.84	6.05	6.24	6.41	6.82	5,780	
EPDRE20175-10-02-ATH	●			10	1.55	1.67	50	4	4	4.22	11.02	11.34	11.61	12.15	13.45	6,020	
EPDRE20175-15-02-ATH	●			15	1.55	1.67	55	4	4	3.18	16.18	16.58	17.29	18.13	20.09	6,020	
EPDRE20175-20-02-ATH	●		20	1.55	1.67	60	4	4	2.55	21.32	21.97	22.99	24.11	干涉なし	6,020		
EPDRE20175-5-03-ATH	●		0.3	5	1.55	1.67	50	4	4	6.31	5.83	6.05	6.23	6.40	6.79	5,780	
EPDRE20175-10-03-ATH	●			10	1.55	1.67	50	4	4	4.24	11.02	11.34	11.60	12.13	13.42	6,020	
EPDRE20175-15-03-ATH	●	15		1.55	1.67	55	4	4	3.20	16.18	16.57	17.28	18.11	20.06	6,020		
EPDRE20175-20-03-ATH	●	20	1.55	1.67	60	4	4	2.56	21.31	21.96	22.98	24.09	干涉なし	6,020			

● : 標準在庫品です。● : Stocked items. 干涉なし : No interference

EPDRE2○○○○-○○.○-○○○-ATH

商品コード Item code	在庫 Stock	寸法 Size(mm)									干渉角度 Interference angle (°) θκ	勾配角に対する実有効首下長 Effective under neck length with respect to draft angle					希望小売価格 (円) Suggested retail price (¥)
		外径 Tool dia.	コーナ半径 Corner radius	首下長 Under neck length	刃長 Flute length	首径 Neck dia.	全長 Overall length	シャンク径 Shank dia.	首R Neck R								
		DC	RE	LU	APMX	DN	LF	DCONMS	0.5°	1°		1.5°	2°	3°			
EPDRE2020-4-01-ATH	●			4	1.7	1.92	50	4	4	6.49	4.80	4.99	5.16	5.31	5.58	5,780	
EPDRE2020-6-01-ATH	●			6	1.7	1.92	50	4	4	5.30	6.88	7.12	7.33	7.51	8.18	5,780	
EPDRE2020-8-01-ATH	●			8	1.7	1.92	50	4	4	4.47	8.96	9.24	9.48	9.77	10.83	6,020	
EPDRE2020-12-01-ATH	●		0.1	12	1.7	1.92	55	4	4	3.41	13.09	13.45	13.88	14.56	16.14	6,020	
EPDRE2020-16-01-ATH	●			16	1.7	1.92	55	4	4	2.76	17.21	17.62	18.44	19.35	干渉なし	6,020	
EPDRE2020-20-01-ATH	●			20	1.7	1.92	60	4	4	2.31	21.32	21.98	23.01	24.13	干渉なし	6,020	
EPDRE2020-25-01-ATH	●			25	1.7	1.92	65	4	4	1.93	26.44	27.43	28.71	干渉なし	干渉なし	6,020	
EPDRE2020-30-01-ATH	●			30	1.7	1.92	70	4	4	1.65	31.55	32.88	34.41	干渉なし	干渉なし	6,020	
EPDRE2020-4-02-ATH	●			4	1.7	1.92	50	4	4	6.57	4.79	4.98	5.15	5.30	5.57	5,780	
EPDRE2020-6-02-ATH	●			6	1.7	1.92	50	4	4	5.35	6.88	7.12	7.32	7.50	8.14	5,780	
EPDRE2020-8-02-ATH	●			8	1.7	1.92	50	4	4	4.51	8.95	9.24	9.47	9.75	10.80	6,020	
EPDRE2020-12-02-ATH	●		0.2	12	1.7	1.92	55	4	4	3.43	13.09	13.44	13.87	14.54	16.11	6,020	
EPDRE2020-16-02-ATH	●			16	1.7	1.92	55	4	4	2.77	17.21	17.62	18.43	19.33	干渉なし	6,020	
EPDRE2020-20-02-ATH	●			20	1.7	1.92	60	4	4	2.32	21.32	21.97	22.99	24.11	干渉なし	6,020	
EPDRE2020-25-02-ATH	●			25	1.7	1.92	65	4	4	1.93	26.44	27.42	28.69	干渉なし	干渉なし	6,020	
EPDRE2020-30-02-ATH	●			30	1.7	1.92	70	4	4	1.66	31.55	32.87	34.40	干渉なし	干渉なし	6,020	
EPDRE2020-4-03-ATH	●			4	1.7	1.92	50	4	4	6.64	4.79	4.97	5.14	5.29	5.55	5,780	
EPDRE2020-6-03-ATH	●			6	1.7	1.92	50	4	4	5.40	6.87	7.11	7.31	7.49	8.11	5,780	
EPDRE2020-8-03-ATH	●			8	1.7	1.92	50	4	4	4.55	8.95	9.23	9.47	9.73	10.77	6,020	
EPDRE2020-12-03-ATH	●		0.3	12	1.7	1.92	55	4	4	3.45	13.09	13.44	13.85	14.52	16.08	6,020	
EPDRE2020-16-03-ATH	●			16	1.7	1.92	55	4	4	2.79	17.21	17.61	18.42	19.31	干渉なし	6,020	
EPDRE2020-20-03-ATH	●			20	1.7	1.92	60	4	4	2.33	21.31	21.96	22.98	24.09	干渉なし	6,020	
EPDRE2020-25-03-ATH	●			25	1.7	1.92	65	4	4	1.94	26.43	27.41	28.68	干渉なし	干渉なし	6,020	
EPDRE2020-30-03-ATH	●			30	1.7	1.92	70	4	4	1.66	31.55	32.86	34.38	干渉なし	干渉なし	6,020	
EPDRE2020-6-05-ATH	●			6	1.7	1.92	50	4	4	5.50	6.86	7.10	7.30	7.48	8.05	5,780	
EPDRE2020-8-05-ATH	●			8	1.7	1.92	50	4	4	4.62	8.94	9.22	9.45	9.70	10.70	6,020	
EPDRE2020-12-05-ATH	●			12	1.7	1.92	55	4	4	3.50	13.08	13.43	13.83	14.48	16.01	6,020	
EPDRE2020-16-05-ATH	●			16	1.7	1.92	55	4	4	2.81	17.20	17.61	18.39	19.27	干渉なし	6,020	
EPDRE2020-20-05-ATH	●			20	1.7	1.92	60	4	4	2.35	21.31	21.95	22.95	24.06	干渉なし	6,020	
EPDRE2020-25-05-ATH	●			25	1.7	1.92	65	4	4	1.95	26.43	27.39	28.65	干渉なし	干渉なし	6,020	
EPDRE2020-30-05-ATH	●			30	1.7	1.92	70	4	4	1.67	31.54	32.84	34.36	干渉なし	干渉なし	6,020	
EPDRE2020-6-08-ATH	●			6	1.7	1.92	50	4	4	5.66	6.85	7.08	7.27	7.45	7.95	5,780	
EPDRE2020-8-08-ATH	●			8	1.7	1.92	50	4	4	4.73	8.93	9.20	9.43	9.64	10.61	6,020	
EPDRE2020-12-08-ATH	●			12	1.7	1.92	55	4	4	3.56	13.07	13.41	13.78	14.42	15.92	6,020	
EPDRE2020-16-08-ATH	●		0.8	16	1.7	1.92	55	4	4	2.85	17.19	17.59	18.35	19.21	干渉なし	6,020	
EPDRE2020-20-08-ATH	●			20	1.7	1.92	60	4	4	2.38	21.30	21.92	22.91	24.00	干渉なし	6,020	
EPDRE2020-25-08-ATH	●			25	1.7	1.92	65	4	4	1.97	26.42	27.37	28.61	干渉なし	干渉なし	6,020	
EPDRE2020-30-08-ATH	●			30	1.7	1.92	70	4	4	1.69	31.53	32.81	34.31	干渉なし	干渉なし	6,020	
EPDRE2025-10-01-ATH	●			10	2	2.39	50	4	4	3.14	11.08	11.39	11.68	12.25	13.58	6,370	
EPDRE2025-20-01-ATH	●		0.1	20	2	2.39	60	4	4	1.82	21.36	22.06	23.09	干渉なし	干渉なし	6,490	
EPDRE2025-30-01-ATH	●			30	2	2.39	70	4	4	1.28	31.59	32.95	干渉なし	干渉なし	干渉なし	6,720	
EPDRE2025-10-02-ATH	●			10	2	2.39	50	4	4	3.16	11.08	11.39	11.67	12.23	13.55	6,370	
EPDRE2025-20-02-ATH	●		0.2	20	2	2.39	60	4	4	1.83	21.36	22.05	23.07	干渉なし	干渉なし	6,490	
EPDRE2025-30-02-ATH	●			30	2	2.39	70	4	4	1.28	31.58	32.94	干渉なし	干渉なし	干渉なし	6,720	
EPDRE2025-10-03-ATH	●			10	2	2.39	50	4	4	3.19	11.08	11.38	11.65	12.21	13.52	6,370	
EPDRE2025-20-03-ATH	●		0.3	20	2	2.39	60	4	4	1.83	21.36	22.04	23.06	干渉なし	干渉なし	6,490	
EPDRE2025-30-03-ATH	●			30	2	2.39	70	4	4	1.29	31.58	32.93	干渉なし	干渉なし	干渉なし	6,720	
EPDRE2025-10-05-ATH	●			10	2	2.39	50	4	4	3.24	11.07	11.37	11.63	12.17	13.45	6,370	
EPDRE2025-20-05-ATH	●		0.5	20	2	2.39	60	4	4	1.85	21.35	22.02	23.03	干渉なし	干渉なし	6,490	
EPDRE2025-30-05-ATH	●			30	2	2.39	70	4	4	1.30	31.58	32.92	干渉なし	干渉なし	干渉なし	6,720	
EPDRE2030-6-01-ATH	●			6	2.5	2.86	50	6	4	6.45	7.01	7.23	7.42	7.59	8.36	9,220	
EPDRE2030-8-01-ATH	●			8	2.5	2.86	55	6	4	5.61	9.07	9.34	9.56	9.94	11.02	9,220	
EPDRE2030-12-01-ATH	●			12	2.5	2.86	60	6	4	4.45	13.20	13.53	14.04	14.73	16.33	9,220	
EPDRE2030-16-01-ATH	●		0.1	16	2.5	2.86	60	6	4	3.69	17.30	17.78	18.60	19.52	21.64	9,430	
EPDRE2030-18-01-ATH	●			18	2.5	2.86	65	6	4	3.40	19.35	19.96	20.89	21.91	24.29	9,430	
EPDRE2030-20-01-ATH	●			20	2.5	2.86	65	6	4	3.15	21.40	22.13	23.17	24.30	26.95	9,760	
EPDRE2030-30-01-ATH	●			30	2.5	2.86	75	6	4	2.31	31.62	33.03	34.57	36.27	干渉なし	10,180	
EPDRE2030-35-01-ATH	●			35	2.5	2.86	80	6	4	2.04	36.83	38.48	40.27	42.25	干渉なし	10,180	

エポックディープラジアスエボリューション

超幅径エポックディープラジアスエボリューション

EPDRE2○○○○-○○.○-○○○-ATH

商品コード Item code	在庫 Stock	寸法 Size(mm)									干渉角度 Interference angle (°)	勾配角に対する実有効首下長 Effective under neck length with respect to draft angle					希望小売価格 (円) Suggested retail price (¥)
		外径 Tool dia.	コーナ半径 Corner radius	首下長 Under neck length	刃長 Flute length	首径 Neck dia.	全長 Overall length	シャン径 Shank dia.	首R	θ _K		0.5°	1°	1.5°	2°	3°	
		DC	RE	LU	APMX	DN	LF	DCONMS	Neck R								
EPDRE2030-6-02-ATH	●			6	2.5	2.86	50	6	4	6.49	7.00	7.22	7.41	7.58	8.33	9,220	
EPDRE2030-8-02-ATH	●			8	2.5	2.86	55	6	4	5.65	9.07	9.33	9.55	9.92	10.99	9,220	
EPDRE2030-12-02-ATH	●			12	2.5	2.86	60	6	4	4.48	13.19	13.52	14.03	14.71	16.30	9,220	
EPDRE2030-16-02-ATH	●		0.2	16	2.5	2.86	60	6	4	3.71	17.30	17.77	18.59	19.50	21.60	9,430	
EPDRE2030-18-02-ATH	●			18	2.5	2.86	65	6	4	3.41	19.35	19.95	20.87	21.89	24.26	9,430	
EPDRE2030-20-02-ATH	●			20	2.5	2.86	65	6	4	3.16	21.40	22.13	23.15	24.28	26.91	9,760	
EPDRE2030-30-02-ATH	●			30	2.5	2.86	75	6	4	2.31	31.62	33.02	34.56	36.25	干涉なし	10,180	
EPDRE2030-35-02-ATH	●			35	2.5	2.86	80	6	4	2.04	36.83	38.47	40.26	42.23	干涉なし	10,180	
EPDRE2030-6-03-ATH	●			6	2.5	2.86	50	6	4	6.54	7.00	7.22	7.40	7.57	8.30	9,220	
EPDRE2030-8-03-ATH	●			8	2.5	2.86	55	6	4	5.68	9.07	9.33	9.54	9.90	10.95	9,220	
EPDRE2030-12-03-ATH	●			12	2.5	2.86	60	6	4	4.50	13.19	13.52	14.02	14.69	16.26	9,220	
EPDRE2030-16-03-ATH	●		0.3	16	2.5	2.86	60	6	4	3.72	17.30	17.76	18.58	19.48	21.57	9,430	
EPDRE2030-18-03-ATH	●			18	2.5	2.86	65	6	4	3.43	19.35	19.94	20.86	21.87	24.23	9,430	
EPDRE2030-20-03-ATH	●			20	2.5	2.86	65	6	4	3.17	21.40	22.12	23.14	24.26	26.88	9,760	
EPDRE2030-30-03-ATH	●			30	2.5	2.86	75	6	4	2.32	31.62	33.01	34.54	36.23	干涉なし	10,180	
EPDRE2030-35-03-ATH	●			35	2.5	2.86	80	6	4	2.05	36.82	38.46	40.25	42.21	干涉なし	10,180	
EPDRE2030-8-05-ATH	●			8	2.5	2.86	55	6	4	5.76	9.06	9.31	9.53	9.87	10.89	9,220	
EPDRE2030-12-05-ATH	●			12	2.5	2.86	60	6	4	4.55	13.18	13.51	13.99	14.65	16.20	9,220	
EPDRE2030-16-05-ATH	●		0.5	16	2.5	2.86	60	6	4	3.75	17.29	17.74	18.55	19.44	21.51	9,430	
EPDRE2030-18-05-ATH	●			18	2.5	2.86	65	6	4	3.45	19.34	19.92	20.83	21.83	24.16	9,430	
EPDRE2030-20-05-ATH	●			20	2.5	2.86	65	6	4	3.20	21.39	22.10	23.11	24.22	26.82	9,760	
EPDRE2030-30-05-ATH	●			30	2.5	2.86	75	6	4	2.33	31.61	32.99	34.52	36.19	干涉なし	10,180	
EPDRE2030-35-05-ATH	●			35	2.5	2.86	80	6	4	2.06	36.82	38.44	40.22	42.17	干涉なし	10,180	
EPDRE2030-8-1-ATH	●			8	2.5	2.86	55	6	4	5.96	9.05	9.29	9.50	9.77	10.73	9,220	
EPDRE2030-12-1-ATH	●			12	2.5	2.86	60	6	4	4.67	13.17	13.49	13.92	14.55	16.04	9,220	
EPDRE2030-16-1-ATH	●		1	16	2.5	2.86	60	6	4	3.84	17.28	17.70	18.48	19.33	21.35	9,430	
EPDRE2030-18-1-ATH	●			18	2.5	2.86	65	6	4	3.52	19.33	19.88	20.76	21.73	24.00	9,430	
EPDRE2030-20-1-ATH	●			20	2.5	2.86	65	6	4	3.26	21.38	22.05	23.04	24.13	26.66	9,760	
EPDRE2030-30-1-ATH	●			30	2.5	2.86	75	6	4	2.37	31.60	32.95	34.45	36.09	干涉なし	10,180	
EPDRE2030-35-1-ATH	●			35	2.5	2.86	80	6	4	2.08	36.79	38.40	40.15	42.08	干涉なし	10,180	
EPDRE2040-8-01-ATH	●			8	3.5	3.8	55	6	4	4.38	9.18	9.42	9.64	10.11	11.21	9,220	
EPDRE2040-12-01-ATH	●			12	3.5	3.8	60	6	4	3.36	13.29	13.60	14.20	14.90	16.51	9,220	
EPDRE2040-16-01-ATH	●		0.1	16	3.5	3.8	60	6	4	2.72	17.39	17.93	18.77	19.68	干涉なし	9,220	
EPDRE2040-20-01-ATH	●			20	3.5	3.8	65	6	4	2.29	21.48	22.29	23.33	24.47	干涉なし	9,220	
EPDRE2040-30-01-ATH	●			30	3.5	3.8	75	6	4	1.64	31.77	33.18	34.73	干涉なし	干涉なし	9,220	
EPDRE2040-35-01-ATH	●			35	3.5	3.8	80	6	4	1.43	36.98	38.63	干涉なし	干涉なし	干涉なし	9,220	
EPDRE2040-45-01-ATH	●			45	3.5	3.8	90	6	4	1.15	47.41	49.52	干涉なし	干涉なし	干涉なし	14,680	
EPDRE2040-8-02-ATH	●			8	3.5	3.8	55	6	4	4.41	9.18	9.42	9.63	10.09	11.17	9,220	
EPDRE2040-12-02-ATH	●			12	3.5	3.8	60	6	4	3.38	13.29	13.59	14.19	14.88	16.48	9,220	
EPDRE2040-16-02-ATH	●		0.2	16	3.5	3.8	60	6	4	2.73	17.39	17.92	18.75	19.66	干涉なし	9,220	
EPDRE2040-20-02-ATH	●			20	3.5	3.8	65	6	4	2.30	21.48	22.28	23.31	24.45	干涉なし	9,220	
EPDRE2040-30-02-ATH	●			30	3.5	3.8	75	6	4	1.64	31.76	33.17	34.72	干涉なし	干涉なし	9,220	
EPDRE2040-35-02-ATH	●			35	3.5	3.8	80	6	4	1.44	36.98	38.62	干涉なし	干涉なし	干涉なし	9,220	
EPDRE2040-45-02-ATH	●			45	3.5	3.8	90	6	4	1.15	47.40	49.51	干涉なし	干涉なし	干涉なし	14,680	
EPDRE2040-8-03-ATH	●			8	3.5	3.8	55	6	4	4.45	9.17	9.41	9.62	10.07	11.14	9,220	
EPDRE2040-12-03-ATH	●			12	3.5	3.8	60	6	4	3.40	13.28	13.59	14.18	14.86	16.45	9,220	
EPDRE2040-16-03-ATH	●		0.3	16	3.5	3.8	60	6	4	2.75	17.38	17.91	18.74	19.65	干涉なし	9,220	
EPDRE2040-20-03-ATH	●			20	3.5	3.8	65	6	4	2.31	21.48	22.27	23.30	24.43	干涉なし	9,220	
EPDRE2040-30-03-ATH	●			30	3.5	3.8	75	6	4	1.65	31.76	33.16	34.71	干涉なし	干涉なし	9,220	
EPDRE2040-35-03-ATH	●			35	3.5	3.8	80	6	4	1.44	36.97	38.61	干涉なし	干涉なし	干涉なし	9,220	
EPDRE2040-45-03-ATH	●			45	3.5	3.8	90	6	4	1.15	47.40	49.51	干涉なし	干涉なし	干涉なし	14,680	
EPDRE2040-12-05-ATH	●			12	3.5	3.8	60	6	4	3.44	13.28	13.58	14.15	14.82	16.39	9,220	
EPDRE2040-16-05-ATH	●		0.5	16	3.5	3.8	60	6	4	2.77	17.38	17.89	18.71	19.61	干涉なし	9,220	
EPDRE2040-20-05-ATH	●			20	3.5	3.8	65	6	4	2.33	21.47	22.25	23.27	24.39	干涉なし	9,220	
EPDRE2040-30-05-ATH	●			30	3.5	3.8	75	6	4	1.66	31.75	33.15	34.68	干涉なし	干涉なし	9,220	
EPDRE2040-35-05-ATH	●			35	3.5	3.8	80	6	4	1.45	36.96	38.59	干涉なし	干涉なし	干涉なし	9,220	
EPDRE2040-45-05-ATH	●			45	3.5	3.8	90	6	4	1.16	47.39	49.49	干涉なし	干涉なし	干涉なし	14,680	

● : 標準在庫品です。 ● : Stocked items. 干涉なし : No interference

EPDRE2 ϕ ϕ ϕ ϕ - ϕ ϕ . ϕ - ϕ ϕ ϕ -ATH

商品コード Item code	在庫 Stock	寸法 Size(mm)									干渉角度 Interference angle (°) θ_K	勾配角に対する実有効首下長 Effective under neck length with respect to draft angle					希望小売 価格(円) Suggested retail price (¥)
		外径 Tool dia.	コーナ半径 Corner radius	首下長 Under neck length	刃長 Flute length	首径 Neck dia.	全長 Overall length	シャンク径 Shank dia.	首R Neck R	0.5°		1°	1.5°	2°	3°		
		DC	RE	LU	APMX	DN	LF	DCONMS									
EPDRE2040-12-1-ATH	●	4	1	12	3.5	3.8	60	6	4	3.54	13.27	13.56	14.08	14.72	16.23	9,220	
EPDRE2040-16-1-ATH	●			16	3.5	3.8	60	6	4	2.84	17.37	17.85	18.64	19.51	干渉なし	9,220	
EPDRE2040-20-1-ATH	●			20	3.5	3.8	65	6	4	2.37	21.46	22.21	23.20	24.30	干渉なし	9,220	
EPDRE2040-30-1-ATH	●			30	3.5	3.8	75	6	4	1.68	31.73	33.10	34.61	干渉なし	9,220		
EPDRE2040-35-1-ATH	●			35	3.5	3.8	80	6	4	1.47	36.94	38.55	干渉なし	干渉なし	干渉なし	9,220	
EPDRE2040-45-1-ATH	●			45	3.5	3.8	90	6	4	1.17	47.37	49.44	干渉なし	干渉なし	干渉なし	14,680	
EPDRE2050-20-01-ATH	●	5	0.1	20	4	4.75	65	6	4	1.26	21.54	22.42	干渉なし	干渉なし	干渉なし	12,240	
EPDRE2050-40-01-ATH	●			40	4	4.75	85	6	4	0.67	42.32	干渉なし	干渉なし	干渉なし	干渉なし	15,380	
EPDRE2050-20-02-ATH	●		0.2	20	4	4.75	65	6	4	1.26	21.54	22.41	干渉なし	干渉なし	干渉なし	12,240	
EPDRE2050-40-02-ATH	●			40	4	4.75	85	6	4	0.68	42.31	干渉なし	干渉なし	干渉なし	干渉なし	15,380	
EPDRE2050-20-03-ATH	●		0.3	20	4	4.75	65	6	4	1.27	21.54	22.40	干渉なし	干渉なし	干渉なし	12,240	
EPDRE2050-40-03-ATH	●			40	4	4.75	85	6	4	0.68	42.31	干渉なし	干渉なし	干渉なし	干渉なし	15,380	
EPDRE2050-20-05-ATH	●		0.5	20	4	4.75	65	6	4	1.28	21.54	22.38	干渉なし	干渉なし	干渉なし	12,240	
EPDRE2050-40-05-ATH	●			40	4	4.75	85	6	4	0.68	42.30	干渉なし	干渉なし	干渉なし	干渉なし	15,380	
EPDRE2050-20-1-ATH	●		1	20	4	4.75	65	6	4	1.31	21.53	22.34	干渉なし	干渉なし	干渉なし	12,240	
EPDRE2050-40-1-ATH	●			40	4	4.75	85	6	4	0.69	42.28	干渉なし	干渉なし	干渉なし	干渉なし	15,380	
EPDRE2060-12-01-ATH	●		6	0.1	12	5	5.7	50	6	-	0.01	干渉なし	干渉なし	干渉なし	干渉なし	干渉なし	12,240
EPDRE2060-18-01-ATH	●				18	5	5.7	60	6	-	0.01	干渉なし	干渉なし	干渉なし	干渉なし	干渉なし	干渉なし
EPDRE2060-24-01-ATH	●	24			5	5.7	70	6	-	0.01	干渉なし	干渉なし	干渉なし	干渉なし	干渉なし	干渉なし	12,240
EPDRE2060-35-01-ATH	●	35			5	5.7	80	6	-	0.01	干渉なし	干渉なし	干渉なし	干渉なし	干渉なし	干渉なし	15,380
EPDRE2060-55-01-ATH	●	55			5	5.7	100	6	-	0.01	干渉なし	干渉なし	干渉なし	干渉なし	干渉なし	干渉なし	19,200
EPDRE2060-12-02-ATH	●	12			5	5.7	50	6	-	0.01	干渉なし	干渉なし	干渉なし	干渉なし	干渉なし	干渉なし	12,240
EPDRE2060-18-02-ATH	●	18		5	5.7	60	6	-	0.01	干渉なし	干渉なし	干渉なし	干渉なし	干渉なし	干渉なし	12,240	
EPDRE2060-24-02-ATH	●	24		5	5.7	70	6	-	0.01	干渉なし	干渉なし	干渉なし	干渉なし	干渉なし	干渉なし	12,240	
EPDRE2060-35-02-ATH	●	35		5	5.7	80	6	-	0.01	干渉なし	干渉なし	干渉なし	干渉なし	干渉なし	干渉なし	15,380	
EPDRE2060-55-02-ATH	●	55		5	5.7	100	6	-	0.01	干渉なし	干渉なし	干渉なし	干渉なし	干渉なし	干渉なし	19,200	
EPDRE2060-12-03-ATH	●	0.2		12	5	5.7	50	6	-	0.01	干渉なし	干渉なし	干渉なし	干渉なし	干渉なし	12,240	
EPDRE2060-18-03-ATH	●			18	5	5.7	60	6	-	0.01	干渉なし	干渉なし	干渉なし	干渉なし	干渉なし	干渉なし	12,240
EPDRE2060-24-03-ATH	●			24	5	5.7	70	6	-	0.01	干渉なし	干渉なし	干渉なし	干渉なし	干渉なし	干渉なし	12,240
EPDRE2060-35-03-ATH	●			35	5	5.7	80	6	-	0.01	干渉なし	干渉なし	干渉なし	干渉なし	干渉なし	干渉なし	15,380
EPDRE2060-55-03-ATH	●			55	5	5.7	100	6	-	0.01	干渉なし	干渉なし	干渉なし	干渉なし	干渉なし	干渉なし	19,200
EPDRE2060-12-05-ATH	●			0.3	12	5	5.7	50	6	-	0.01	干渉なし	干渉なし	干渉なし	干渉なし	干渉なし	12,240
EPDRE2060-18-05-ATH	●	18			5	5.7	60	6	-	0.01	干渉なし	干渉なし	干渉なし	干渉なし	干渉なし	干渉なし	12,240
EPDRE2060-24-05-ATH	●	24			5	5.7	70	6	-	0.01	干渉なし	干渉なし	干渉なし	干渉なし	干渉なし	干渉なし	12,240
EPDRE2060-35-05-ATH	●	35			5	5.7	80	6	-	0.01	干渉なし	干渉なし	干渉なし	干渉なし	干渉なし	干渉なし	15,380
EPDRE2060-55-05-ATH	●	55			5	5.7	100	6	-	0.01	干渉なし	干渉なし	干渉なし	干渉なし	干渉なし	干渉なし	19,200
EPDRE2060-12-1-ATH	●	0.5			12	5	5.7	50	6	-	0.01	干渉なし	干渉なし	干渉なし	干渉なし	干渉なし	12,240
EPDRE2060-18-1-ATH	●			18	5	5.7	60	6	-	0.01	干渉なし	干渉なし	干渉なし	干渉なし	干渉なし	干渉なし	12,240
EPDRE2060-24-1-ATH	●			24	5	5.7	70	6	-	0.01	干渉なし	干渉なし	干渉なし	干渉なし	干渉なし	干渉なし	12,240
EPDRE2060-35-1-ATH	●			35	5	5.7	80	6	-	0.01	干渉なし	干渉なし	干渉なし	干渉なし	干渉なし	干渉なし	15,380
EPDRE2060-55-1-ATH	●		55	5	5.7	100	6	-	0.01	干渉なし	干渉なし	干渉なし	干渉なし	干渉なし	干渉なし	19,200	
EPDRE2060-12-01-ATH	●		1	12	5	5.7	50	6	-	0.01	干渉なし	干渉なし	干渉なし	干渉なし	干渉なし	12,240	
EPDRE2060-18-01-ATH	●	18		5	5.7	60	6	-	0.01	干渉なし	干渉なし	干渉なし	干渉なし	干渉なし	干渉なし	12,240	
EPDRE2060-24-01-ATH	●	24		5	5.7	70	6	-	0.01	干渉なし	干渉なし	干渉なし	干渉なし	干渉なし	干渉なし	12,240	
EPDRE2060-35-01-ATH	●	35		5	5.7	80	6	-	0.01	干渉なし	干渉なし	干渉なし	干渉なし	干渉なし	干渉なし	15,380	
EPDRE2060-55-01-ATH	●	55		5	5.7	100	6	-	0.01	干渉なし	干渉なし	干渉なし	干渉なし	干渉なし	干渉なし	19,200	
EPDRE2060-12-01-ATH	●	12		5	5.7	50	6	-	0.01	干渉なし	干渉なし	干渉なし	干渉なし	干渉なし	干渉なし	12,240	

対応被削材 Applicable work material

炭素鋼 合金鋼 Carbon steel Alloy steel	プリハー ド鋼 Pre-hardened steel	高硬度 Hardened steel			ステン レス鋼 Stainless steel	チタン合金 耐熱合金 Titanium alloy Heat-resistant alloy	銅合金 Copper alloy	アルミ 合金 Aluminum alloy
○	◎	> 45HRC ≤ 55HRC	> 55HRC ≤ 65HRC	> 65HRC	○	◎	○	○

再研磨対応外径範囲 Re-grinding compatibility range

商品コード Item code	外周 Outer dia. (mm)	エンド End (mm)
EPDRE-ATH	× (N/A)	4 ~ 6

【注意】首下長/外径が10DCを超える工具の再研磨可否については、弊社営業にお問い合わせください。
【Note】Contact our sales office regarding whether or not regrinding is possible for tools where under neck length/tool diameter more than 10DC



標準切削条件表
Recommended cutting conditions



高能率切削条件
High efficiency cutting conditions

高精度切削条件
High accuracy cutting conditions

EPDRE-ATH

高精度切削条件はA205 ページを参照してください。
Please refer to P.A205 about high accuracy cutting conditions

被削材 Work material				1		2		3		4		5		6	
				銅 Copper		炭素鋼・合金鋼 Carbon steels, Alloy steels (180~250HB)		ステンレス鋼・工具鋼 Stainless steels, Tool steels (25~35HRC)		プリハードン鋼 Pre-hardened steels (35~45HRC)		焼き入れ鋼 Hardened steels (45~55HRC)		焼き入れ鋼 Hardened steels (55~65HRC)	
切り込み比率 Ratio to standard depth of cut				120%		100%		90%		80%		65%		60%	
外径 Tool dia. (mm)	コーナ半径 RE Corner radius (mm)	首下長 Under neck length (mm)	ap (mm)	回転数 n min ⁻¹		送り速度 Vf mm/min		回転数 n min ⁻¹		送り速度 Vf mm/min		回転数 n min ⁻¹		送り速度 Vf mm/min	

超硬工具用

リジッドエポックディープラジラス

被削材 Work material				1		2		3		4		5		6													
				銅 Copper		炭素鋼・合金鋼 Carbon steels, Alloy steels (180~250HB)		ステンレス鋼・工具鋼 Stainless steels, Tool steels (25~35HRC)		プリハードン鋼 Pre-hardened steels (35~45HRC)		焼き入れ鋼 Hardened steels (45~55HRC)		焼き入れ鋼 Hardened steels (55~65HRC)													
切り込み比率 Ratio to standard depth of cut				120%				100%				90%				80%				65%				60%			
外径 Tool dia. (mm)	コーナ半径 RE Corner radius (mm)	首下長 Under neck length (mm)	ap (mm)	回転数 n min ⁻¹		送り速度 Vf mm/min		回転数 n min ⁻¹		送り速度 Vf mm/min		回転数 n min ⁻¹		送り速度 Vf mm/min		回転数 n min ⁻¹		送り速度 Vf mm/min		回転数 n min ⁻¹		送り速度 Vf mm/min					
				Detailed data rows for various materials and conditions, following the table structure																							

[注意] ご使用にあたっては、A204ページの表下の項目と注意を参照してください。 **[Note]** Upon usage, please refer to comments and notes below table on page A204.

エポックディープラジラスエボリューション

EPDRE-ATH

高能率切削条件
High efficiency cutting condition

高精度切削条件
High accuracy cutting condition

高精度切削条件はA205ページを参照してください。
Please refer to P.A205 about high accuracy cutting conditions

被削材 Work material				1		2		3		4		5		6													
				銅 Copper		炭素鋼・合金鋼 Carbon steels, Alloy steels (180~250HB)		ステンレス鋼・工具鋼 Stainless steels, Tool steels (25~35HRC)		プリハードン鋼 Pre-hardened steels (35~45HRC)		焼入れ鋼 Hardened steels (45~55HRC)		焼入れ鋼 Hardened steels (55~65HRC)													
切り込み比率 Ratio to standard depth of cut				120%				100%				90%				80%				65%				60%			
外径 Tool dia. (mm)	コーナ半径 RE Corner radius (mm)	首下長 Under neck length (mm)	ap (mm)	回転数 n min ⁻¹	送り速度 Vf mm/min	回転数 n min ⁻¹	送り速度 Vf mm/min	回転数 n min ⁻¹	送り速度 Vf mm/min	回転数 n min ⁻¹	送り速度 Vf mm/min	回転数 n min ⁻¹	送り速度 Vf mm/min	回転数 n min ⁻¹	送り速度 Vf mm/min	回転数 n min ⁻¹	送り速度 Vf mm/min										
1.5	0.2	4	0.07	33,264	2,153	27,700	1,793	24,948	1,614	23,285	1,378	20,790	1,076	19,293	883												
		6	0.065	31,847	2,057	26,539	1,714	23,779	1,536	22,505	1,332	19,957	1,033	18,471	845												
		8	0.06	30,240	1,956	25,200	1,630	22,680	1,467	21,420	1,268	18,900	979	17,640	807												
		12	0.06	24,192	1,565	20,160	1,304	18,144	1,174	17,136	1,014	15,120	783	14,112	646												
		15	0.038	18,816	1,082	15,680	902	14,112	812	13,328	671	11,760	592	10,976	473												
	0.3	4	0.07	33,264	2,153	27,700	1,793	24,948	1,614	23,285	1,378	20,790	1,076	19,293	883												
		6	0.065	31,847	2,057	26,539	1,714	23,779	1,536	22,505	1,332	19,957	1,033	18,471	845												
		8	0.06	30,240	1,956	25,200	1,630	22,680	1,467	21,420	1,268	18,900	979	17,640	807												
		12	0.06	24,192	1,565	20,160	1,304	18,144	1,174	17,136	1,014	15,120	783	14,112	646												
		15	0.038	18,816	1,082	15,680	902	14,112	812	13,328	671	11,760	592	10,976	473												
	0.5	4	0.085	33,264	2,153	27,700	1,793	24,948	1,614	23,285	1,378	20,790	1,076	19,293	883												
		6	0.08	31,847	2,057	26,539	1,714	23,779	1,536	22,505	1,332	19,957	1,033	18,471	845												
		8	0.07	30,240	1,956	25,200	1,630	22,680	1,467	21,420	1,268	18,900	979	17,640	807												
		12	0.065	24,192	1,565	20,160	1,304	18,144	1,174	17,136	1,014	15,120	783	14,112	646												
		15	0.045	18,816	1,082	15,680	902	14,112	812	13,328	671	11,760	592	10,976	473												
	1.75	0.1	5	0.04	31,847	2,057	26,539	1,714	23,779	1,536	22,505	1,332	19,957	1,033	18,471	845											
			10	0.036	24,192	1,565	20,160	1,304	18,144	1,174	17,136	1,014	15,120	783	14,112	646											
			15	0.023	18,816	1,082	15,680	902	14,112	812	13,328	671	11,760	592	10,976	473											
			20	0.018	18,816	978	15,680	815	14,112	733	13,328	613	11,760	540	10,976	428											
			5	0.065	31,847	2,057	26,539	1,714	23,779	1,536	22,505	1,332	19,957	1,033	18,471	845											
0.2		10	0.06	24,192	1,565	20,160	1,304	18,144	1,174	17,136	1,014	15,120	783	14,112	646												
		15	0.038	18,816	1,082	15,680	902	14,112	812	13,328	671	11,760	592	10,976	473												
		20	0.03	18,816	978	15,680	815	14,112	733	13,328	613	11,760	540	10,976	428												
		5	0.065	31,847	2,057	26,539	1,714	23,779	1,536	22,505	1,332	19,957	1,033	18,471	845												
		10	0.06	24,192	1,565	20,160	1,304	18,144	1,174	17,136	1,014	15,120	783	14,112	646												
0.3		15	0.038	18,816	1,082	15,680	902	14,112	812	13,328	671	11,760	592	10,976	473												
		20	0.03	18,816	978	15,680	815	14,112	733	13,328	613	11,760	540	10,976	428												
		5	0.065	31,847	2,057	26,539	1,714	23,779	1,536	22,505	1,332	19,957	1,033	18,471	845												
		10	0.06	24,192	1,565	20,160	1,304	18,144	1,174	17,136	1,014	15,120	783	14,112	646												
		15	0.038	18,816	1,082	15,680	902	14,112	812	13,328	671	11,760	592	10,976	473												
2		0.1	4	0.08	28,662	3,221	24,203	2,720	21,815	2,452	20,541	2,308	18,152	1,630	17,038	1,339											
			6	0.07	27,720	3,114	23,100	2,595	20,790	2,335	19,635	2,205	17,325	1,557	16,170	1,271											
			8	0.055	25,200	2,830	21,000	2,359	18,900	2,123	17,850	2,005	15,750	1,415	14,700	1,156											
			12	0.03	20,412	2,063	17,010	1,720	15,309	1,548	14,459	1,462	12,758	1,146	11,907	936											
			16	0.03	18,144	1,834	15,120	1,528	13,608	1,376	12,852	1,299	11,340	1,019	10,584	832											
	0.2	20	0.025	15,876	1,605	13,230	1,337	11,907	1,204	11,246	1,137	9,923	801	9,261	653												
		25	0.015	15,876	1,605	13,230	1,337	11,907	1,204	11,246	1,137	9,923	801	9,261	653												
		30	0.01	15,082	1,525	12,569	1,271	11,312	1,143	10,683	1,080	9,426	761	8,798	621												
		4	0.1	28,662	3,221	24,203	2,720	21,815	2,452	20,541	2,308	18,152	1,630	17,038	1,339												
		6	0.08	27,720	3,114	23,100	2,595	20,790	2,335	19,635	2,205	17,325	1,557	16,170	1,271												
	0.3	8	0.07	25,200	2,830	21,000	2,359	18,900	2,123	17,850	2,005	15,750	1,415	14,700	1,156												
		12	0.04	20,412	2,063	17,010	1,720	15,309	1,548	14,459	1,462	12,758	1,146	11,907	936												
		16	0.04	18,144	1,834	15,120	1,528	13,608	1,376	12,852	1,299	11,340	1,019	10,584	832												
		20	0.035	15,876	1,605	13,230	1,337	11,907	1,204	11,246	1,137	9,923	801	9,261	653												
		25	0.025	15,876	1,605	13,230	1,337	11,907	1,204	11,246	1,137	9,923	801	9,261	653												
	0.5	30	0.017	15,082	1,525	12,569	1,271	11,312	1,143	10,683	1,080	9,426	761	8,798	621												
		4	0.13	28,662	3,221	24,203	2,720	21,815	2,452	20,541	2,308	18,152	1,630	17,038	1,339												
		6	0.11	27,720	3,114	23,100	2,595	20,790	2,335	19,635	2,205	17,325	1,557	16,170	1,271												
		8	0.09	25,200	2,830	21,000	2,359	18,900	2,123	17,850	2,005	15,750	1,415	14,700	1,156												
		12	0.06	20,412	2,063	17,010	1,720	15,309	1,548	14,459	1,462	12,758	1,146	11,907	936												
0.8	16	0.06	18,144	1,834	15,120	1,528	13,608	1,376	12,852	1,299	11,340	1,019	10,584	832													
	20	0.037	15,876	1,605	13,230	1,337	11,907	1,204	11,246	1,137	9,923	801	9,261	653													
	25	0.03	15,876	1,605	13,230	1,337	11,907	1,204	11,246	1,137	9,923	801	9,261	653													
	30	0.021	15,082	1,525	12,569	1,271	11,312	1,143	10,683	1,080	9,426	761	8,798	621													
	6	0.17	27,720	3,114	23,100	2,595	20,790	2,335	19,635	2,205	17,325	1,557	16,170	1,271													

超硬合金工具

被削材 Work material				1		2		3		4		5		6		
				銅 Copper		炭素鋼・合金鋼 Carbon steels, Alloy steels (180~250HB)		ステンレス鋼・工具鋼 Stainless steels, Tool steels (25~35HRC)		プリハードン鋼 Pre-hardened steels (35~45HRC)		焼入れ鋼 Hardened steels (45~55HRC)		焼入れ鋼 Hardened steels (55~65HRC)		
切り込み比率 Ratio to standard depth of cut				120%		100%		90%		80%		65%		60%		
外径 Tool dia. (mm)	コーナ半径 RE Corner radius (mm)	首下長 Under neck length (mm)	ap (mm)	回転数	送り速度	回転数	送り速度	回転数	送り速度	回転数	送り速度	回転数	送り速度	回転数	送り速度	
				n min ⁻¹	V _f mm/min	n min ⁻¹	V _f mm/min	n min ⁻¹	V _f mm/min	n min ⁻¹	V _f mm/min	n min ⁻¹	V _f mm/min	n min ⁻¹	V _f mm/min	n min ⁻¹
2.5	0.1	10	0.05	20,412	2,293	17,010	1,720	15,309	1,548	14,459	1,462	12,758	1,146	11,907	936	
		20	0.03	15,876	1,783	13,230	1,337	11,907	1,204	11,246	1,137	9,923	801	9,261	653	
		30	0.015	15,082	1,525	12,569	1,271	11,312	1,143	10,683	1,080	9,426	761	8,798	621	
	0.2	10	0.07	20,412	2,293	17,010	1,720	15,309	1,548	14,459	1,462	12,758	1,146	11,907	936	
		20	0.04	15,876	1,783	13,230	1,337	11,907	1,204	11,246	1,137	9,923	801	9,261	653	
		30	0.025	15,082	1,525	12,569	1,271	11,312	1,143	10,683	1,080	9,426	761	8,798	621	
	0.3	10	0.09	20,412	2,293	17,010	1,720	15,309	1,548	14,459	1,462	12,758	1,146	11,907	936	
		20	0.06	15,876	1,783	13,230	1,337	11,907	1,204	11,246	1,137	9,923	801	9,261	653	
		30	0.03	15,082	1,525	12,569	1,271	11,312	1,143	10,683	1,080	9,426	761	8,798	621	
	0.5	10	0.12	20,412	2,293	17,010	1,720	15,309	1,548	14,459	1,462	12,758	1,146	11,907	936	
		20	0.08	15,876	1,783	13,230	1,337	11,907	1,204	11,246	1,137	9,923	801	9,261	653	
		30	0.05	15,082	1,525	12,569	1,271	11,312	1,143	10,683	1,080	9,426	761	8,798	621	
3	0.1	6	0.08	19,200	2,696	16,000	2,246	14,400	2,022	13,600	1,909	12,000	1,348	11,200	1,101	
		8	0.07	19,200	2,696	16,000	2,246	14,400	2,022	13,600	1,909	12,000	1,348	11,200	1,101	
		12	0.05	19,200	2,696	16,000	2,246	14,400	2,022	13,600	1,909	12,000	1,348	11,200	1,101	
		16	0.035	19,200	2,696	16,000	2,246	14,400	2,022	13,600	1,909	12,000	1,348	11,200	1,101	
		18	0.035	16,985	2,384	14,331	2,012	12,738	1,788	12,208	1,714	10,615	1,193	10,084	992	
		20	0.035	15,552	2,184	12,960	1,820	11,664	1,638	11,016	1,547	9,720	1,092	9,072	892	
	0.2	30	0.027	12,096	1,524	10,080	1,270	9,072	1,143	8,568	1,079	7,560	771	7,056	621	
		35	0.02	12,096	1,524	10,080	1,270	9,072	1,143	8,568	1,079	7,560	771	7,056	621	
		6	0.1	19,200	2,696	16,000	2,246	14,400	2,022	13,600	1,909	12,000	1,348	11,200	1,101	
		8	0.09	19,200	2,696	16,000	2,246	14,400	2,022	13,600	1,909	12,000	1,348	11,200	1,101	
		12	0.07	19,200	2,696	16,000	2,246	14,400	2,022	13,600	1,909	12,000	1,348	11,200	1,101	
		16	0.05	19,200	2,696	16,000	2,246	14,400	2,022	13,600	1,909	12,000	1,348	11,200	1,101	
	0.3	18	0.05	16,985	2,384	14,331	2,012	12,738	1,788	12,208	1,714	10,615	1,193	10,084	992	
		20	0.05	15,552	2,184	12,960	1,820	11,664	1,638	11,016	1,547	9,720	1,092	9,072	892	
		30	0.04	12,096	1,524	10,080	1,270	9,072	1,143	8,568	1,079	7,560	771	7,056	621	
		35	0.035	12,096	1,524	10,080	1,270	9,072	1,143	8,568	1,079	7,560	771	7,056	621	
		6	0.145	19,200	2,696	16,000	2,246	14,400	2,022	13,600	1,909	12,000	1,348	11,200	1,101	
		8	0.13	19,200	2,696	16,000	2,246	14,400	2,022	13,600	1,909	12,000	1,348	11,200	1,101	
	0.5	12	0.1	19,200	2,696	16,000	2,246	14,400	2,022	13,600	1,909	12,000	1,348	11,200	1,101	
		16	0.075	19,200	2,696	16,000	2,246	14,400	2,022	13,600	1,909	12,000	1,348	11,200	1,101	
		18	0.075	16,985	2,384	14,331	2,012	12,738	1,788	12,208	1,714	10,615	1,193	10,084	992	
		20	0.075	15,552	2,184	12,960	1,820	11,664	1,638	11,016	1,547	9,720	1,092	9,072	892	
		30	0.06	12,096	1,524	10,080	1,270	9,072	1,143	8,568	1,079	7,560	771	7,056	621	
		35	0.05	12,096	1,524	10,080	1,270	9,072	1,143	8,568	1,079	7,560	771	7,056	621	
	1	8	0.18	19,200	2,696	16,000	2,246	14,400	2,022	13,600	1,909	12,000	1,348	11,200	1,101	
		12	0.13	19,200	2,696	16,000	2,246	14,400	2,022	13,600	1,909	12,000	1,348	11,200	1,101	
		16	0.1	19,200	2,696	16,000	2,246	14,400	2,022	13,600	1,909	12,000	1,348	11,200	1,101	
		18	0.1	16,985	2,384	14,331	2,012	12,738	1,788	13,600	1,909	10,615	1,193	10,084	992	
		20	0.1	15,552	2,184	12,960	1,820	11,664	1,638	11,016	1,547	9,720	1,092	9,072	892	
		30	0.08	12,096	1,524	10,080	1,270	9,072	1,143	8,568	1,079	7,560	771	7,056	621	
	4	0.1	35	0.065	12,096	1,524	10,080	1,270	9,072	1,143	8,568	1,079	7,560	771	7,056	621
			8	0.08	16,560	2,880	13,800	2,400	12,420	2,160	11,730	2,040	10,350	1,440	9,660	1,176
			12	0.065	16,560	2,880	13,800	2,400	12,420	2,160	11,730	2,040	10,350	1,440	9,660	1,176
			16	0.06	13,733	2,388	11,445	1,990	10,071	1,751	9,613	1,671	8,240	1,146	7,782	947
			20	0.055	13,733	2,388	11,445	1,990	10,071	1,751	9,613	1,671	8,240	1,146	7,782	947
			30	0.045	10,985	1,719	9,154	1,433	8,239	1,290	7,781	1,218	6,866	860	6,408	702
0.2		35	0.04	10,985	1,719	9,154	1,433	8,239	1,290	7,781	1,218	6,866	860	6,408	702	
		45	0.03	8,789	1,100	7,324	917	6,592	825	6,226	780	5,494	554	5,127	446	
		8	0.16	16,560	2,880	13,800	2,400	12,420	2,160	11,730	2,040	10,350	1,440	9,660	1,176	
		12	0.14	16,560	2,880	13,800	2,400	12,420	2,160	11,730	2,040	10,350	1,440	9,660	1,176	
		16	0.13	13,733	2,388	11,445	1,990	10,071	1,751	9,613	1,671	8,240	1,146	7,782	947	
		20	0.11	13,733	2,388	11,445	1,990	10,071	1,751	9,613	1,671	8,240	1,146	7,782	947	
0.3		30	0.1	10,985	1,719	9,154	1,433	8,239	1,290	7,781	1,218	6,866	860	6,408	702	
		35	0.08	10,985	1,719	9,154	1,433	8,239	1,290	7,781	1,218	6,866	860	6,408	702	
		45	0.06	8,789	1,100	7,324	917	6,592	825	6,226	780	5,494	554	5,127	446	
		8	0.24	16,560	2,880	13,800	2,400	12,420	2,160	11,730	2,040	10,350	1,440	9,660	1,176	
		12	0.22	16,560	2,880	13,800	2,400	12,420	2,160	11,730	2,040	10,350	1,440	9,660	1,176	
		16	0.2	13,733	2,388	11,445	1,990	10,071	1,751	9,613	1,671	8,240	1,146	7,782	947	

【注意】 ご使用にあたっては、A204ページの表下の項目と注意を参照してください。 **【Note】** Upon usage, please refer to comments and notes below table on page A204.

エポックディープラジラスエボリューション

EPDRE-ATH

高能率切削条件
High efficiency cutting condition

高精度切削条件
High accuracy cutting condition

高精度切削条件はA205ページを参照してください。
Please refer to P.A205 about high accuracy cutting conditions

被削材 Work material				1 銅 Copper		2 炭素鋼・合金鋼 Carbon steels, Alloy steels (180~250HB)		3 ステンレス鋼・工具鋼 Stainless steels, Tool steels (25~35HRC)		4 プリハードン鋼 Pre-hardened steels (35~45HRC)		5 焼入れ鋼 Hardened steels (45~55HRC)		6 焼入れ鋼 Hardened steels (55~65HRC)		
切り込み比率 Ratio to standard depth of cut				120%		100%		90%		80%		65%		60%		
外径 Tool dia. (mm)	コーナ半径 RE Corner radius (mm)	首下長 Under neck length (mm)	ap (mm)	回転数 n min ⁻¹	送り速度 Vf mm/min	回転数 n min ⁻¹	送り速度 Vf mm/min	回転数 n min ⁻¹	送り速度 Vf mm/min	回転数 n min ⁻¹	送り速度 Vf mm/min	回転数 n min ⁻¹	送り速度 Vf mm/min	回転数 n min ⁻¹	送り速度 Vf mm/min	
4	0.5	12	0.35	16,560	2,880	13,800	2,400	12,420	2,160	11,730	2,040	10,350	1,440	9,660	1,176	
		16	0.25	13,733	2,388	11,445	1,990	10,071	1,751	9,613	1,671	8,240	1,146	7,782	947	
		20	0.2	13,733	2,388	11,445	1,990	10,071	1,751	9,613	1,671	8,240	1,146	7,782	947	
		30	0.15	10,985	1,719	9,154	1,433	8,239	1,290	7,781	1,218	6,866	860	6,408	702	
		35	0.1	10,985	1,719	9,154	1,433	8,239	1,290	7,781	1,218	6,866	860	6,408	702	
		45	0.05	8,789	1,100	7,324	917	6,592	825	6,226	780	5,494	554	5,127	446	
		12	0.4	16,560	2,880	13,800	2,400	12,420	2,160	11,730	2,040	10,350	1,440	9,660	1,176	
	1	16	0.29	13,733	2,388	11,445	1,990	10,071	1,751	9,613	1,671	8,240	1,146	7,782	947	
		20	0.23	13,733	2,388	11,445	1,990	10,071	1,751	9,613	1,671	8,240	1,146	7,782	947	
		30	0.17	10,985	1,719	9,154	1,433	8,239	1,290	7,781	1,218	6,866	860	6,408	702	
		35	0.12	10,985	1,719	9,154	1,433	8,239	1,290	7,781	1,218	6,866	860	6,408	702	
		45	0.06	8,789	1,100	7,324	917	6,592	825	6,226	780	5,494	554	5,127	446	
		20	0.08	13,179	2,865	10,983	2,388	9,884	2,149	9,336	2,029	8,237	1,433	7,688	1,170	
		40	0.06	11,868	2,312	9,890	1,926	8,901	1,734	8,407	1,637	7,418	1,156	6,923	944	
5	0.2	20	0.16	13,179	2,865	10,983	2,388	9,884	2,149	9,336	2,029	8,237	1,433	7,688	1,170	
		40	0.13	11,868	2,312	9,890	1,926	8,901	1,734	8,407	1,637	7,418	1,156	6,923	944	
	0.3	20	0.24	13,179	2,865	10,983	2,388	9,884	2,149	9,336	2,029	8,237	1,433	7,688	1,170	
		40	0.2	11,868	2,312	9,890	1,926	8,901	1,734	8,407	1,637	7,418	1,156	6,923	944	
	0.5	20	0.35	13,179	2,865	10,983	2,388	9,884	2,149	9,336	2,029	8,237	1,433	7,688	1,170	
		40	0.135	11,868	2,312	9,890	1,926	8,901	1,734	8,407	1,637	7,418	1,156	6,923	944	
	1	20	0.4	13,179	2,865	10,983	2,388	9,884	2,149	9,336	2,029	8,237	1,433	7,688	1,170	
		40	0.15	11,868	2,312	9,890	1,926	8,901	1,734	8,407	1,637	7,418	1,156	6,923	944	
	6	0.1	12	0.08	10,985	2,866	9,154	2,388	8,239	2,149	7,781	2,030	6,866	1,433	6,408	1,170
			18	0.065	10,985	2,866	9,154	2,388	8,239	2,149	7,781	2,030	6,866	1,433	6,408	1,170
24			0.06	10,985	2,866	9,154	2,388	8,239	2,149	7,781	2,030	6,866	1,433	6,408	1,170	
35			0.05	9,881	2,320	8,234	1,933	7,411	1,740	6,999	1,643	6,176	1,160	5,764	947	
55			0.04	7,687	1,805	6,406	1,504	5,765	1,354	5,445	1,278	4,805	902	4,484	737	
12			0.16	10,985	2,866	9,154	2,388	8,239	2,149	7,781	2,030	6,866	1,433	6,408	1,170	
0.2		18	0.14	10,985	2,866	9,154	2,388	8,239	2,149	7,781	2,030	6,866	1,433	6,408	1,170	
		24	0.13	10,985	2,866	9,154	2,388	8,239	2,149	7,781	2,030	6,866	1,433	6,408	1,170	
		35	0.11	9,881	2,320	8,234	1,933	7,411	1,740	6,999	1,643	6,176	1,160	5,764	947	
		55	0.08	7,687	1,805	6,406	1,504	5,765	1,354	5,445	1,278	4,805	902	4,484	737	
		12	0.24	10,985	2,866	9,154	2,388	8,239	2,149	7,781	2,030	6,866	1,433	6,408	1,170	
		18	0.22	10,985	2,866	9,154	2,388	8,239	2,149	7,781	2,030	6,866	1,433	6,408	1,170	
0.3		24	0.2	10,985	2,866	9,154	2,388	8,239	2,149	7,781	2,030	6,866	1,433	6,408	1,170	
		35	0.18	9,881	2,320	8,234	1,933	7,411	1,740	6,999	1,643	6,176	1,160	5,764	947	
		55	0.14	7,687	1,805	6,406	1,504	5,765	1,354	5,445	1,278	4,805	902	4,484	737	
		18	0.35	10,985	2,866	9,154	2,388	8,239	2,149	7,781	2,030	6,866	1,433	6,408	1,170	
		24	0.29	10,985	2,866	9,154	2,388	8,239	2,149	7,781	2,030	6,866	1,433	6,408	1,170	
		35	0.24	9,881	2,320	8,234	1,933	7,411	1,740	6,999	1,643	6,176	1,160	5,764	947	
0.5		55	0.165	7,687	1,805	6,406	1,504	5,765	1,354	5,445	1,278	4,805	902	4,484	737	
		18	0.4	10,985	2,866	9,154	2,388	8,239	2,149	7,781	2,030	6,866	1,433	6,408	1,170	
		24	0.35	10,985	2,866	9,154	2,388	8,239	2,149	7,781	2,030	6,866	1,433	6,408	1,170	
		35	0.24	9,881	2,320	8,234	1,933	7,411	1,740	6,999	1,643	6,176	1,160	5,764	947	
		55	0.165	7,687	1,805	6,406	1,504	5,765	1,354	5,445	1,278	4,805	902	4,484	737	
		18	0.4	10,985	2,866	9,154	2,388	8,239	2,149	7,781	2,030	6,866	1,433	6,408	1,170	
1		24	0.35	10,985	2,866	9,154	2,388	8,239	2,149	7,781	2,030	6,866	1,433	6,408	1,170	
		35	0.28	9,881	2,320	8,234	1,933	7,411	1,740	6,999	1,643	6,176	1,160	5,764	947	
		55	0.2	7,687	1,805	6,406	1,504	5,765	1,354	5,445	1,278	4,805	902	4,484	737	

- ※(1) apは被削材グループ2での目安を示しています。その他のグループの場合は、上表の切り込み比率を目安に調整してください。
- ※(2) リブ加工や止まり溝など、切りくずがつまりやすい切削の場合、切り込み設定は基本切り込み値に切り込み比率をかけて算出した切り込み量を、さらにその80%まで小さくして使用してください。
- ※(3) aeの設定はap×切り込み比率×5倍以下を目安に調整してください。仕上げ加工を行う場合、理論カスプハイトを計算し設定してください。
- ※(4) 掘り込み時のアプローチ方法は、ヘリカルが傾斜での加工を推奨いたします。
- ※(5) L/Dが5以上の場合、
 - ① 彫り込み時の傾斜進入角は1°以下を推奨いたします。また、送り速度は条件表の70%以下に調整してください。
 - ② 文字彫り加工のような溝切削の際は、送り速度は50%以下・apを30%以下を目安に調整してください。また往復切削による加工を推奨いたします。

- ※(1) ap is shown as the criteria for Group 2 workpieces. For other groups, adjust the cutting depth according to the cutting depth factors in the above table.
- ※(2) When performing cutting where cutting chips may cause clogging, such as for rib cutting, blind grooves, etc., cutting depth setting should be set by multiplying a cutting depth factor to calculate the cutting depth amount, and this amount should then be reduced to 80% of the calculated value.
- ※(3) Adjust by setting ae to (5 or less) × (ap) × (cutting depth ratio). When performing finishing cutting, calculate the theoretical cusp height and set accordingly.
- ※(4) Helical or sloped cutting is recommended for the approach method when engraving.
- ※(5) When L/D is 5 or greater:
 - ① The recommended slope entrance angle when engraving is 1° or less. In addition, feed rate should be adjusted to 70% or less of the values in the cutting condition table.
 - ② When slotting such engraving letters, adjust feed rate to 50% or less and ap to 30% or less of the values shown. In addition, cutting by reciprocal cutting is recommended.

【切り込み設定例】 EPDRE2030-6-02-ATHの工具でプリハードン鋼(40HRC)をリブ溝等高線切削する場合、
切り込み=0.1(ap)×0.8(プリハードン鋼グループ4の切り込み比率)×0.8(閉鎖域の切削)=0.064mm

Cutting depth setting example: When cutting rib groove contours in pre-hardened steel (40HRC) using an EPDRE2030-6-02-ATH tool:
Cutting depth = 0.1 (ap) × 0.8 (cutting depth factor for Group 4 pre-hardened steel) × 0.8 (for closed-area cutting) = 0.064mm

- 【注意】**
- ① 被削材、加工形状に合わせて、適切なクーラントを使用してください。
 - ② この標準切削条件表は切削条件の目安を示すものです。実際の加工では加工形状、目的、使用機械等により条件を調整してください。
 - ③ 機械の回転数が足りない場合は、回転数と送り速度を同じ比率で下げてください。

- 【Note】**
- ① Use the appropriate coolant for the work material and machining shape.
 - ② These Recommended Cutting Conditions indicate only the rule of a thumb for the cutting conditions. In actual machining, the condition should be adjusted according to the machining shape, purpose and the machine type.
 - ③ If the rpm of the machine is low, lower the feed rate also to put the rpm and feed rate in the same ratio.



標準切削条件表

Recommended cutting conditions

高能率切削条件

High efficiency cutting condition

高精度切削条件

High accuracy cutting condition

EPDRE-ATH

高能率切削条件はA200ページを参照してください。
Please refer to P.A200 about high efficiency cutting conditions

被削材 Work material				1		2		3		4		5		6		
				銅 Copper		炭素鋼・合金鋼 Carbon steels, Alloy steels (180~250HB)		ステンレス鋼・工具鋼 Stainless steels, Tool steels (25~35HRC)		プリハードン鋼 Pre-hardened steels (35~45HRC)		焼き入れ鋼 Hardened steels (45~55HRC)		焼き入れ鋼 Hardened steels (55~65HRC)		
切り込み比率 Ratio to standard depth of cut				120%		100%		90%		80%		65%		60%		
外径 Tool dia. (mm)	コーナ半径 RE Corner radius (mm)	首下長 Under neck length (mm)	ap (mm)	回転数 n min ⁻¹	送り速度 Vi mm/min	回転数 n min ⁻¹	送り速度 Vi mm/min	回転数 n min ⁻¹	送り速度 Vi mm/min	回転数 n min ⁻¹	送り速度 Vi mm/min	回転数 n min ⁻¹	送り速度 Vi mm/min	回転数 n min ⁻¹	送り速度 Vi mm/min	
0.2	0.02	0.5	0.016	50,000	307	50,000	258	50,000	230	50,000	205	50,000	180	50,000	160	
		1	0.011	50,000	307	50,000	258	50,000	230	50,000	205	50,000	180	50,000	160	
		2	0.007	50,000	246	42,000	202	37,800	181	36,700	176	36,700	162	36,700	147	
	0.05	0.5	0.02	50,000	307	50,000	258	50,000	230	50,000	205	50,000	180	50,000	160	
		1	0.014	50,000	307	50,000	258	50,000	230	50,000	205	50,000	180	50,000	160	
		1.5	0.008	50,000	276	50,000	240	48,600	223	45,900	202	45,900	170	45,900	153	
0.3	0.02	2	0.008	50,000	246	42,000	202	37,800	181	36,700	176	36,700	162	36,700	147	
		1	0.016	50,000	696	50,000	585	50,000	516	50,000	456	50,000	336	50,000	320	
		2	0.011	45,000	620	45,000	530	45,000	460	45,000	420	45,000	300	45,000	290	
	0.05	3	0.007	40,000	504	35,000	412	35,000	358	35,000	326	30,000	200	30,000	194	
		1	0.021	50,000	696	50,000	585	50,000	516	50,000	456	50,000	336	50,000	320	
		1.5	0.016	50,000	696	50,000	585	45,000	516	45,000	456	45,000	336	45,000	320	
	0.4	0.02	2	0.012	45,000	620	45,000	530	45,000	460	45,000	420	45,000	300	45,000	290
			3	0.008	40,000	504	35,000	412	35,000	358	35,000	326	30,000	200	30,000	194
			1	0.021	50,000	696	50,000	585	50,000	516	50,000	456	50,000	336	50,000	320
		0.05	2.5	0.01	40,000	551	40,000	471	40,000	409	40,000	373	40,000	267	40,000	258
			3	0.008	40,000	504	35,000	412	35,000	358	35,000	326	30,000	200	30,000	194
			1	0.016	50,000	691	50,000	580	50,000	518	50,000	461	40,000	320	36,000	270
0.5	0.02	2	0.013	45,000	620	45,000	520	45,000	470	45,000	410	36,000	290	34,000	240	
		3	0.01	40,000	480	40,000	410	40,000	370	40,000	330	32,800	240	25,600	200	
		4	0.007	30,000	370	30,000	320	30,000	280	30,000	250	21,600	160	19,200	150	
	0.05	1	0.025	50,000	691	50,000	580	50,000	518	50,000	461	40,000	320	36,000	270	
		1.5	0.02	50,000	691	50,000	580	50,000	518	50,000	461	40,000	320	36,000	270	
		2	0.016	45,000	620	45,000	520	45,000	470	45,000	410	36,000	290	34,000	240	
		2.5	0.015	40,500	560	40,500	480	40,500	400	40,500	370	33,400	270	30,600	220	
		3	0.014	40,000	480	40,000	410	40,000	370	40,000	330	32,800	240	25,600	200	
		3.5	0.012	36,000	420	36,000	380	36,000	320	36,000	300	29,400	200	22,920	180	
	0.1	4	0.008	30,000	370	30,000	320	30,000	280	30,000	250	21,600	160	19,200	150	
		1	0.033	50,000	691	50,000	580	50,000	518	50,000	461	40,000	320	36,000	270	
		2	0.028	45,000	620	45,000	520	45,000	470	45,000	410	36,000	290	34,000	240	
3		0.016	40,000	480	40,000	410	40,000	370	40,000	330	32,800	240	25,600	200		
4		0.01	30,000	370	30,000	320	30,000	280	30,000	250	21,600	160	19,200	150		
1		0.016	50,000	1,070	50,000	898	50,000	756	40,000	464	30,000	378	28,000	315		
0.6	0.02	2	0.013	50,000	1,070	50,000	898	50,000	756	40,000	464	30,000	378	28,000	315	
		3	0.01	45,000	960	45,000	810	45,000	684	36,000	414	27,000	315	24,500	261	
		4	0.008	40,000	850	40,000	720	40,000	603	32,000	378	24,000	279	20,000	234	
	0.05	6	0.006	30,000	570	28,800	480	24,000	380	19,400	260	18,000	250	15,000	200	
		1	0.03	50,000	1,070	50,000	898	50,000	756	40,000	464	30,000	378	28,000	315	
		2	0.023	50,000	1,070	50,000	898	50,000	756	40,000	464	30,000	378	28,000	315	
		3	0.017	45,000	960	45,000	810	45,000	684	36,000	414	27,000	315	24,500	261	
		4	0.017	40,000	850	40,000	720	40,000	603	32,000	378	24,000	279	20,000	234	
		5	0.011	30,000	640	28,800	540	24,000	380	19,400	280	18,000	250	15,000	200	
	0.1	6	0.008	30,000	570	28,800	480	24,000	380	19,400	260	18,000	250	15,000	200	
		1	0.035	50,000	1,070	50,000	898	50,000	756	40,000	464	30,000	378	28,000	315	
		2	0.03	50,000	1,070	50,000	898	50,000	756	40,000	464	30,000	378	28,000	315	
3		0.02	45,000	960	45,000	810	45,000	684	36,000	414	27,000	315	24,500	261		
4		0.02	40,000	850	40,000	720	40,000	603	32,000	378	24,000	279	20,000	234		
5		0.013	30,000	640	28,800	540	24,000	380	19,400	280	18,000	250	15,000	200		
0.7	0.02	6	0.013	30,000	570	28,800	480	24,000	380	19,400	260	18,000	250	15,000	200	
		2	0.016	50,000	1,380	50,000	1,159	46,800	920	37,830	600	28,200	390	23,000	320	
		4	0.013	40,000	980	40,000	830	34,500	620	27,800	440	23,600	280	21,000	230	
	0.05	6	0.01	30,000	580	24,000	490	20,000	360	18,000	300	17,800	240	15,000	210	
		2	0.028	50,000	1,380	50,000	1,159	46,800	920	37,830	600	28,200	390	23,000	320	
		4	0.019	40,000	980	40,000	830	34,500	620	27,800	440	23,600	280	21,000	230	
		6	0.012	30,000	580	24,000	490	20,000	360	18,000	300	17,800	240	15,000	210	
		8	0.01	30,000	551	24,000	466	20,000	342	18,000	285	17,800	228	15,000	200	
		10	0.007	30,000	534	24,000	451	20,000	331	18,000	276	17,800	221	15,000	193	
	0.1	2	0.035	50,000	1,380	50,000	1,159	46,800	920	37,830	600	28,200	390	23,000	320	
		4	0.024	40,000	980	40,000	830	34,500	620	27,800	440	23,600	280	21,000	230	
		6	0.015	30,000	580	24,000	490	20,000	360	18,000	300	17,800	240	15,000	210	
8		0.013	30,000	551	24,000	466	20,000	342	18,000	285	17,800	228	15,000	200		
10		0.009	30,000	534	24,000	451	20,000	331	18,000	276	17,800	221	15,000	193		
2		0.035	49,200	1,244	49,200	1,054	42,430	787	34,190	558	29,030	355	25,830	292		
0.8	0.02	4	0.024	40,000	980	40,000	830	34,500	620	27,800	440	23,600	280	21,000	230	
		6	0.015	30,000	580	24,000	490	20,000	360	18,000	300	17,800	240	15,000	210	
		2	0.042	49,200	1,244	49,200	1,054	42,430	787	34,190	558	29,030	355	25,830	292	
	0.05	4	0.029	40,000	980	40,000	830	34,500	620	27,800	440	23,600	280	21,000	230	
		6	0.018	30,000	580	24,000	490	20,000	360	18,000	300	17,800	240	15,000	210	
		2	0.016	50,000	1,640	48,000	1,378	36,000	937	28,000	647	20,000	400	20,000	360	
0.05	4	0.016	50,000	1,312	48,000	1,102	36,000	750	28,000	518	20,000	320	20,000	288		
	6	0.013	40,000	950	38,700	800	26,000	530	25,000	461	18,000	288	18,000	256		
	2	0.038	50,000	1,640	48,000	1,378	36,000	937	28,000	647	20,000	400	20,000	360		
	4	0.026	50,000	1,312	48,000	1,102	36,000	750	28,000							

エポックディープラジラスエボリューション

EPDRE-ATH

高能率切削条件
High efficiency cutting condition

高精度切削条件
High accuracy cutting condition

高能率切削条件はA200ページを参照してください。
Please refer to P.A200 about high efficiency cutting conditions

被削材 Work material				1		2		3		4		5		6		
				銅 Copper		炭素鋼・合金鋼 Carbon steels, Alloy steels (180~250HB)		ステンレス鋼・工具鋼 Stainless steels, Tool steels (25~35HRC)		プリハードン鋼 Pre-hardened steels (35~45HRC)		焼き入れ鋼 Hardened steels (45~55HRC)		焼き入れ鋼 Hardened steels (55~65HRC)		
切り込み比率 Ratio to standard depth of cut				120%		100%		90%		80%		65%		60%		
外径 Tool dia. (mm)	コーナ半径 RE Corner radius (mm)	首下長 Under neck length (mm)	ap (mm)	回転数 n min ⁻¹	送り速度 Vf mm/min	回転数 n min ⁻¹	送り速度 Vf mm/min	回転数 n min ⁻¹	送り速度 Vf mm/min	回転数 n min ⁻¹	送り速度 Vf mm/min	回転数 n min ⁻¹	送り速度 Vf mm/min	回転数 n min ⁻¹	送り速度 Vf mm/min	
0.8	0.1	2	0.047	50,000	1,640	48,000	1,378	36,000	937	28,000	647	20,000	400	20,000	360	
		4	0.032	50,000	1,312	48,000	1,102	36,000	750	28,000	518	20,000	320	20,000	288	
		6	0.019	40,000	950	38,700	800	26,000	530	25,000	461	18,000	288	18,000	256	
		8	0.015	30,000	713	29,025	600	20,800	424	20,000	369	16,200	259	16,200	230	
		12	0.012	30,000	677	29,025	570	20,800	403	20,000	350	16,200	246	16,200	219	
		2	0.081	50,000	1,640	48,000	1,378	36,000	937	28,000	647	20,000	400	20,000	360	
	0.2	4	0.056	50,000	1,312	48,000	1,102	36,000	750	28,000	518	20,000	320	20,000	288	
		6	0.032	40,000	950	38,700	800	26,000	530	25,000	461	18,000	288	18,000	256	
		8	0.018	30,000	713	29,025	600	20,800	424	20,000	369	16,200	259	16,200	230	
		12	0.015	30,000	677	29,025	570	20,800	403	20,000	350	16,200	246	16,200	219	
		2	0.016	42,675	1,877	35,668	1,569	32,076	1,411	30,294	1,212	26,730	962	24,948	798	
		4	0.013	38,880	1,630	32,400	1,359	29,160	1,223	27,540	1,039	24,300	815	22,680	666	
1	0.02	6	0.01	31,493	1,189	26,244	990	23,620	891	22,307	842	19,683	660	18,371	539	
		8	0.008	27,994	1,056	23,328	880	20,995	792	19,829	748	17,496	587	16,330	479	
		10	0.006	21,773	924	20,412	770	18,371	693	17,350	655	15,309	514	14,288	419	
		12	0.005	21,773	730	18,144	609	16,330	548	15,422	453	13,608	399	12,701	320	
		2	0.046	42,675	1,877	35,668	1,569	32,076	1,411	30,254	1,210	26,730	962	24,948	798	
		3	0.035	40,796	1,754	34,020	1,462	30,618	1,317	30,294	1,212	25,515	867	23,814	714	
	0.05	4	0.027	38,880	1,630	32,400	1,359	29,160	1,223	28,917	1,128	24,300	815	22,680	666	
		5	0.021	34,713	1,388	28,868	1,154	25,982	1,039	27,540	1,039	21,651	727	20,208	594	
		6	0.017	31,493	1,189	26,244	990	23,620	891	24,538	928	19,683	660	18,371	539	
		8	0.016	27,994	1,056	23,328	880	20,995	792	19,829	748	17,496	587	16,330	479	
		10	0.011	24,494	924	20,412	770	18,371	693	17,350	655	15,309	514	14,288	419	
		12	0.01	21,773	730	18,144	609	16,330	548	15,422	453	13,608	399	12,701	320	
16		0.006	21,773	639	18,144	533	16,330	479	15,422	420	13,608	342	12,701	266		
20		0.004	16,330	479	13,608	399	12,247	359	11,567	315	10,206	257	9,526	200		
0.1		2	0.065	42,675	1,877	35,668	1,569	32,076	1,411	30,294	1,212	26,730	962	24,948	798	
		3	0.05	40,796	1,754	34,020	1,462	30,618	1,317	28,917	1,128	25,515	867	23,814	714	
		4	0.038	38,880	1,630	32,400	1,359	29,160	1,223	27,540	1,039	24,300	815	22,680	666	
		5	0.03	34,713	1,388	28,868	1,154	25,982	1,039	24,538	928	21,651	727	20,208	594	
	6	0.024	31,493	1,189	26,244	990	23,620	891	22,307	842	19,683	660	18,371	539		
	8	0.024	27,994	1,056	23,328	880	20,995	792	19,829	748	17,496	587	16,330	479		
	10	0.015	24,494	924	20,412	770	18,371	693	17,350	655	15,309	514	14,288	419		
	12	0.015	21,773	730	18,144	609	16,330	548	15,422	453	13,608	399	12,701	320		
	16	0.009	21,773	639	18,144	533	16,330	479	15,422	420	13,608	342	12,701	266		
	20	0.006	16,330	479	13,608	399	12,247	359	11,567	315	10,206	257	9,526	200		
	0.2	2	0.11	42,675	1,877	35,668	1,569	32,076	1,411	30,294	1,212	26,730	962	24,948	798	
		3	0.09	40,796	1,754	34,020	1,462	30,618	1,317	28,917	1,128	25,515	867	23,814	714	
4		0.07	38,880	1,630	32,400	1,359	29,160	1,223	27,540	1,039	24,300	815	22,680	666		
5		0.05	34,713	1,388	28,868	1,154	25,982	1,039	24,538	928	21,651	727	20,208	594		
6		0.04	31,493	1,189	26,244	990	23,620	891	22,307	842	19,683	660	18,371	539		
8		0.04	27,994	1,056	23,328	880	20,995	792	19,829	748	17,496	587	16,330	479		
10		0.025	24,494	924	20,412	770	18,371	693	17,350	655	15,309	514	14,288	419		
12		0.025	21,773	730	18,144	609	16,330	548	15,422	453	13,608	399	12,701	320		
16		0.015	21,773	639	18,144	533	16,330	479	15,422	420	13,608	342	12,701	266		
20		0.01	16,330	479	13,608	399	12,247	359	11,567	315	10,206	257	9,526	200		
0.3		2	0.11	42,675	1,877	35,668	1,569	32,076	1,411	30,294	1,212	26,730	962	24,948	798	
		3	0.09	40,796	1,754	34,020	1,462	30,618	1,317	28,917	1,128	25,515	867	23,814	714	
	4	0.07	38,880	1,630	32,400	1,359	29,160	1,223	27,540	1,039	24,300	815	22,680	666		
	5	0.05	34,713	1,388	28,868	1,154	25,982	1,039	24,538	928	21,651	727	20,208	594		
	6	0.04	31,493	1,189	26,244	990	23,620	891	22,307	842	19,683	660	18,371	539		
	8	0.04	27,994	1,056	23,328	880	20,995	792	19,829	748	17,496	587	16,330	479		
	10	0.025	24,494	924	20,412	770	18,371	693	17,350	655	15,309	514	14,288	419		
	12	0.025	21,773	730	18,144	609	16,330	548	15,422	453	13,608	399	12,701	320		
	16	0.015	21,773	639	18,144	533	16,330	479	15,422	420	13,608	342	12,701	266		
	20	0.01	16,330	479	13,608	399	12,247	359	11,567	315	10,206	257	9,526	200		
	1.25	0.1	5	0.03	34,713	1,388	28,868	1,154	25,982	1,039	24,538	928	21,651	727	20,208	594
			10	0.015	24,494	924	20,412	770	18,371	693	17,350	655	15,309	514	14,288	419
15			0.01	21,773	639	18,144	533	16,330	479	15,422	453	13,608	342	12,701	266	
20			0.006	16,330	479	13,608	399	12,247	359	11,567	315	10,206	257	9,526	200	
5			0.05	34,713	1,388	28,868	1,154	25,982	1,039	24,538	928	21,651	727	20,208	594	
10			0.025	24,494	924	20,412	770	18,371	693	17,350	655	15,309	514	14,288	419	
0.3		15	0.016	21,773	639	18,144	533	16,330	479	15,422	453	13,608	342	12,701	266	
		20	0.01	16,330	479	13,608	399	12,247	359	11,567	315	10,206	257	9,526	200	
		5	0.05	34,713	1,388	28,868	1,154	25,982	1,039	24,538	928	21,651	727	20,208	594	
		10	0.025	24,494	924	20,412	770	18,371	693	17,350	655	15,309	514	14,288	419	
		15	0.016	21,773	639	18,144	533	16,330	479	15,422	453	13,608	342	12,701	266	
		20	0.01	16,330	479	13,608	399	12,247	359	11,567	315	10,206	257	9,526	200	
1.5	0.1	4	0.042	29,938	1,356	24,930	1,130	22,453	1,017	20,956	947	18,711	752	17,364	611	
		6	0.04	28,450	1,285	23,779	1,074	21,443	969	20,382	921	17,834	716	16,560	582	
		8	0.036	27,216	1,233	22,680	1,027	20,412	924	19,278	873	17,010	685	15,876	559	
		12	0.036	21,773	986	18,144	822	16,330	740	15,422	698	13,608	548	12,701	447	
		15	0.023	16,934	682	14,112	568	12,701	511	11,995	423	10,584	373	9,878	298	

被削材 Work material				1		2		3		4		5		6		
				銅 Copper		炭素鋼・合金鋼 Carbon steels, Alloy steels (180~250HB)		ステンレス鋼・工具鋼 Stainless steels, Tool steels (25~35HRC)		プリハードン鋼 Pre-hardened steels (35~45HRC)		焼入れ鋼 Hardened steels (45~55HRC)		焼入れ鋼 Hardened steels (55~65HRC)		
切り込み比率 Ratio to standard depth of cut				120%		100%		90%		80%		65%		60%		
外径 Tool dia. (mm)	コーナ半径 RE Corner radius (mm)	首下長 Under neck length (mm)	ap (mm)	回転数 n min ⁻¹	送り速度 Vf mm/min	回転数 n min ⁻¹	送り速度 Vf mm/min	回転数 n min ⁻¹	送り速度 Vf mm/min	回転数 n min ⁻¹	送り速度 Vf mm/min	回転数 n min ⁻¹	送り速度 Vf mm/min	回転数 n min ⁻¹	送り速度 Vf mm/min	
1.5	0.2	4	0.07	29,938	1,356	24,930	1,130	22,453	1,017	20,956	868	18,711	678	17,364	556	
		6	0.065	28,450	1,285	23,779	1,074	21,443	969	20,382	921	17,834	716	16,560	582	
		8	0.06	27,216	1,233	22,680	1,027	20,412	924	19,278	873	17,010	685	15,876	559	
		12	0.06	21,773	986	18,144	822	16,330	740	15,422	698	13,608	548	12,701	447	
		15	0.038	16,934	682	14,112	568	12,701	511	11,995	423	10,584	373	9,878	298	
	0.3	4	0.07	29,938	1,356	24,930	1,130	22,453	1,017	20,956	868	18,711	678	17,364	556	
		6	0.065	28,450	1,285	23,779	1,074	21,443	969	20,382	921	17,834	716	16,560	582	
		8	0.06	27,216	1,233	22,680	1,027	20,412	924	19,278	873	17,010	685	15,876	559	
		12	0.06	21,773	986	18,144	822	16,330	740	15,422	698	13,608	548	12,701	447	
		15	0.038	16,934	682	14,112	568	12,701	511	11,995	423	10,584	373	9,878	298	
	0.5	4	0.085	29,938	1,356	24,930	1,130	22,453	1,017	20,956	868	18,711	678	17,364	556	
		6	0.08	28,450	1,285	23,779	1,074	21,443	969	20,382	921	17,834	716	16,560	582	
		8	0.07	27,216	1,233	22,680	1,027	20,412	924	19,278	873	17,010	685	15,876	559	
		12	0.065	21,773	986	18,144	822	16,330	740	15,422	698	13,608	548	12,701	447	
		15	0.045	16,934	682	14,112	568	12,701	511	11,995	423	10,584	373	9,878	298	
	1.75	0.1	5	0.04	29,938	1,356	24,930	1,130	22,453	1,017	20,956	868	18,711	678	17,364	556
			10	0.036	27,216	1,233	22,680	1,027	20,412	924	19,278	873	17,010	685	15,876	559
			15	0.023	16,934	682	14,112	568	12,701	511	11,995	423	10,584	373	9,878	298
			20	0.018	16,934	682	14,112	568	12,701	511	11,995	423	10,584	373	9,878	298
			5	0.065	29,938	1,356	24,930	1,130	22,453	1,017	20,956	868	18,711	678	17,364	556
		0.2	10	0.06	27,216	1,233	22,680	1,027	20,412	924	19,278	873	17,010	685	15,876	559
			15	0.038	16,934	682	14,112	568	12,701	511	11,995	423	10,584	373	9,878	298
			20	0.03	16,934	682	14,112	568	12,701	511	11,995	423	10,584	373	9,878	298
			5	0.065	29,938	1,356	24,930	1,130	22,453	1,017	20,956	868	18,711	678	17,364	556
10			0.06	27,216	1,233	22,680	1,027	20,412	924	19,278	873	17,010	685	15,876	559	
0.3		15	0.038	16,934	682	14,112	568	12,701	511	11,995	423	10,584	373	9,878	298	
		20	0.03	16,934	682	14,112	568	12,701	511	11,995	423	10,584	373	9,878	298	
		5	0.08	29,938	1,356	24,930	1,130	22,453	1,017	20,956	868	18,711	678	17,364	556	
		10	0.06	27,216	1,233	22,680	1,027	20,412	924	19,278	873	17,010	685	15,876	559	
		15	0.038	16,934	682	14,112	568	12,701	511	11,995	423	10,584	373	9,878	298	
2		0.1	4	0.08	26,114	2,052	21,974	1,727	19,745	1,551	18,471	1,451	16,401	1,033	15,286	840
			6	0.07	24,948	1,962	20,790	1,635	18,711	1,471	17,672	1,389	15,593	981	14,553	801
			8	0.055	22,680	1,783	18,900	1,486	17,010	1,337	16,065	1,263	14,175	892	13,230	728
			12	0.03	18,371	1,300	15,309	1,083	13,778	975	13,013	921	11,482	722	10,716	590
			16	0.03	16,330	1,156	13,608	963	12,247	867	11,567	818	10,206	642	9,526	524
			20	0.025	14,288	1,011	11,907	843	10,716	758	10,121	716	8,930	562	8,335	459
			25	0.015	14,288	908	11,907	757	10,716	681	10,121	643	8,930	505	8,335	411
		0.2	30	0.01	13,574	863	11,312	719	10,180	647	9,615	611	8,484	480	7,918	391
			4	0.1	26,114	2,052	21,974	1,727	19,745	1,551	18,471	1,451	16,401	1,033	15,286	840
	6		0.08	24,948	1,962	20,790	1,635	18,711	1,471	17,672	1,389	15,593	981	14,553	801	
	8		0.07	22,680	1,783	18,900	1,486	17,010	1,337	16,065	1,263	14,175	892	13,230	728	
	12		0.04	18,371	1,300	15,309	1,083	13,778	975	13,013	921	11,482	722	10,716	590	
	16		0.04	16,330	1,156	13,608	963	12,247	867	11,567	818	10,206	642	9,526	524	
	20		0.035	14,288	1,011	11,907	843	10,716	758	10,121	716	8,930	562	8,335	459	
	0.3	25	0.025	14,288	908	11,907	757	10,716	681	10,121	643	8,930	505	8,335	411	
		30	0.017	13,574	863	11,312	719	10,180	647	9,615	611	8,484	480	7,918	391	
		4	0.13	26,114	2,052	21,974	1,727	19,745	1,551	18,471	1,451	16,401	1,033	15,286	840	
		6	0.11	24,948	1,962	20,790	1,635	18,711	1,471	17,672	1,389	15,593	981	14,553	801	
		8	0.09	22,680	1,783	18,900	1,486	17,010	1,337	16,065	1,263	14,175	892	13,230	728	
		12	0.06	18,371	1,444	15,309	1,083	13,778	975	13,013	921	11,482	722	10,716	590	
		16	0.06	16,330	1,284	13,608	963	12,247	867	11,567	818	10,206	642	9,526	524	
	0.5	20	0.037	14,288	1,123	11,907	843	10,716	758	10,121	716	8,930	562	8,335	459	
		25	0.03	14,288	908	11,907	757	10,716	681	10,121	643	8,930	505	8,335	411	
		30	0.021	13,574	863	11,312	719	10,180	647	9,615	611	8,484	480	7,918	391	
6		0.17	24,948	1,962	20,790	1,635	18,711	1,471	17,672	1,389	15,593	981	14,553	801		
8		0.14	22,680	1,783	18,900	1,486	17,010	1,337	16,065	1,263	14,175	892	13,230	728		
12		0.08	18,371	1,444	15,309	1,083	13,778	975	13,013	1,023	11,482	722	10,716	590		
16		0.08	16,330	1,284	13,608	963	12,247	867	11,567	818	10,206	642	9,526	524		
0.8	20	0.05	14,288	1,123	11,907	843	10,716	758	10,121	716	8,930	562	8,335	459		
	25	0.05	14,288	908	11,907	757	10,716	681	10,121	643	8,930	505	8,335	411		
	30	0.03	13,574	863	11,312	719	10,180	647	9,615	611	8,484	480	7,918	391		
	6	0.22	24,948	1,962	20,790	1,635	18,711	1,471	17,672	1,389	15,593	981	14,553	801		
	8	0.2	22,680	1,783	18,900	1,486	17,010	1,337	16,065	1,263	14,175	892	13,230	728		
	12	0.13	18,371	1,444	15,309	1,083	13,778	975	13,013	921	11,482	722	10,716	590		
	16	0.1	16,330	1,284	13,608	963	12,247	867	11,567	818	10,206	642	9,526	524		
0.8	20	0.06	14,288	1,123	11,907	843	10,716	758	10,121	716	8,930	562	8,335	459		
	25	0.057	14,288	908	11,907	757	10,716	681	10,121	643	8,930	505	8,335	411		
	30	0.045	13,574	863	11,312	719	10,180	647	9,615	611	8,484	480	7,918	391		

[注意] ご使用にあたっては、A209ページの表下の項目と注意を参照してください。 **[Note]** Upon usage, please refer to comments and notes below table on page A209.

エポックディープラジアスエボリューション

EPDRE-ATH

高能率切削条件
High efficiency cutting condition

高精度切削条件
High accuracy cutting condition

高能率切削条件はA200ページを参照してください。
Please refer to P.A200 about high efficiency cutting conditions

被削材 Work material				1		2		3		4		5		6													
				銅 Copper		炭素鋼・合金鋼 Carbon steels, Alloy steels (180~250HB)		ステンレス鋼・工具鋼 Stainless steels, Tool steels (25~35HRC)		プリハードン鋼 Pre-hardened steels (35~45HRC)		焼入れ鋼 Hardened steels (45~55HRC)		焼入れ鋼 Hardened steels (55~65HRC)													
切り込み比率 Ratio to standard depth of cut				120%				100%				90%				80%				65%				60%			
外径 Tool dia. (mm)	コーナ半径 RE Corner radius (mm)	首下長 Under neck length (mm)	ap (mm)	回転数 n min ⁻¹	送り速度 Vf mm/min	回転数 n min ⁻¹	送り速度 Vf mm/min	回転数 n min ⁻¹	送り速度 Vf mm/min	回転数 n min ⁻¹	送り速度 Vf mm/min	回転数 n min ⁻¹	送り速度 Vf mm/min	回転数 n min ⁻¹	送り速度 Vf mm/min	回転数 n min ⁻¹	送り速度 Vf mm/min										
2.5	0.1	10	0.055	22,680	1,783	18,900	1,486	17,010	1,337	16,065	1,263	14,175	892	13,230	728												
		20	0.03	16,330	1,284	13,608	963	12,247	867	11,567	818	10,206	642	9,526	524												
		30	0.015	14,288	1,008	11,907	757	10,716	681	10,121	643	8,930	505	8,335	411												
	0.2	10	0.07	22,680	1,783	18,900	1,486	17,010	1,337	16,065	1,263	14,175	892	13,230	728												
		20	0.04	16,330	1,284	13,608	963	12,247	867	11,567	818	10,206	642	9,526	524												
		30	0.025	14,288	1,008	11,907	757	10,716	681	10,121	643	8,930	505	8,335	411												
	0.3	10	0.09	22,680	1,783	18,900	1,486	17,010	1,337	16,065	1,263	14,175	892	13,230	728												
		20	0.06	16,330	1,284	13,608	963	12,247	867	11,567	818	10,206	642	9,526	524												
		30	0.03	14,288	1,008	11,907	757	10,716	681	10,121	643	8,930	505	8,335	411												
	0.5	10	0.14	22,680	1,783	18,900	1,486	17,010	1,337	16,065	1,263	14,175	892	13,230	728												
		20	0.08	16,330	1,284	13,608	963	12,247	867	11,567	818	10,206	642	9,526	524												
		30	0.05	14,288	1,008	11,907	757	10,716	681	10,121	643	8,930	505	8,335	411												
3	0.1	6	0.08	17,280	1,698	14,400	1,415	12,960	1,274	12,240	1,203	10,800	849	10,080	693												
		8	0.07	17,280	1,698	14,400	1,415	12,960	1,274	12,240	1,203	10,800	849	10,080	693												
		12	0.05	17,280	1,698	14,400	1,415	12,960	1,274	12,240	1,203	10,800	849	10,080	693												
		16	0.035	17,280	1,698	14,400	1,415	12,960	1,274	12,240	1,203	10,800	849	10,080	693												
		18	0.035	15,498	1,521	12,951	1,271	11,677	1,149	10,934	1,073	9,766	767	9,023	620												
		20	0.035	13,997	1,376	11,664	1,146	10,498	1,032	9,914	974	8,748	687	8,165	561												
	0.2	6	0.1	17,280	1,698	14,400	1,415	12,960	1,274	12,240	1,203	10,800	849	10,080	693												
		8	0.09	17,280	1,698	14,400	1,415	12,960	1,274	12,240	1,203	10,800	849	10,080	693												
		12	0.07	17,280	1,698	14,400	1,415	12,960	1,274	12,240	1,203	10,800	849	10,080	693												
		16	0.05	17,280	1,698	14,400	1,415	12,960	1,274	12,240	1,203	10,800	849	10,080	693												
		18	0.05	15,498	1,521	12,951	1,271	11,677	1,149	10,934	1,073	9,766	767	9,023	620												
		20	0.05	13,997	1,376	11,664	1,146	10,498	1,032	9,914	974	8,748	687	8,165	561												
	0.3	6	0.145	17,280	1,698	14,400	1,415	12,960	1,274	12,240	1,203	10,800	849	10,080	693												
		8	0.13	17,280	1,698	14,400	1,415	12,960	1,274	12,240	1,203	10,800	849	10,080	693												
		12	0.1	17,280	1,698	14,400	1,415	12,960	1,274	12,240	1,203	10,800	849	10,080	693												
		16	0.075	17,280	1,698	14,400	1,415	12,960	1,274	12,240	1,203	10,800	849	10,080	693												
		18	0.075	15,498	1,521	12,951	1,271	11,677	1,149	10,934	1,073	9,766	767	9,023	620												
		20	0.075	13,997	1,376	11,664	1,146	10,498	1,032	9,914	974	8,748	687	8,165	561												
	0.5	6	0.18	17,280	1,698	14,400	1,415	12,960	1,274	12,240	1,203	10,800	849	10,080	693												
		12	0.13	17,280	1,698	14,400	1,415	12,960	1,274	12,240	1,203	10,800	849	10,080	693												
		16	0.1	17,280	1,698	14,400	1,415	12,960	1,274	12,240	1,203	10,800	849	10,080	693												
		18	0.1	15,498	1,521	12,951	1,271	11,677	1,149	10,934	1,073	9,766	767	9,023	620												
		20	0.1	13,997	1,376	11,664	1,146	10,498	1,032	9,914	974	8,748	687	8,165	561												
		30	0.08	10,886	962	9,072	801	8,165	721	7,711	681	6,804	480	6,350	393												
4	0.1	8	0.2	17,280	1,698	14,400	1,415	12,960	1,274	12,240	1,203	10,800	849	10,080	693												
		12	0.15	17,280	1,698	14,400	1,415	12,960	1,274	12,240	1,203	10,800	849	10,080	693												
		16	0.12	17,280	1,698	14,400	1,415	12,960	1,274	12,240	1,203	10,800	849	10,080	693												
		18	0.11	15,498	1,521	12,951	1,271	11,677	1,149	10,934	1,073	9,766	767	9,023	620												
		20	0.11	13,997	1,376	11,664	1,146	10,498	1,032	9,914	974	8,748	687	8,165	561												
		30	0.09	10,886	962	9,072	801	8,165	721	7,711	681	6,804	480	6,350	393												
	0.2	8	0.075	10,886	962	9,072	801	8,165	721	7,711	681	6,804	480	6,350	393												
		12	0.08	13,455	2,340	11,213	1,950	10,091	1,755	9,531	1,658	8,410	1,170	7,849	956												
		16	0.065	13,455	2,340	11,213	1,950	10,091	1,755	9,531	1,658	8,410	1,170	7,849	956												
		20	0.06	12,360	2,149	10,255	1,783	9,155	1,592	8,697	1,512	7,599	1,057	6,684	814												
		30	0.055	12,360	2,149	10,255	1,783	9,155	1,592	8,697	1,512	7,599	1,057	6,684	814												
		35	0.045	12,360	2,149	10,255	1,783	9,155	1,592	8,697	1,512	7,599	1,057	6,684	814												
0.3	8	0.04	12,360	2,149	10,255	1,783	9,155	1,592	8,697	1,512	7,599	1,057	6,684	814													
	45	0.03	9,888	1,289	8,240	1,075	7,324	955	5,584	728	4,944	516	4,119	358													
	8	0.16	13,455	2,340	11,213	1,950	10,091	1,755	9,531	1,658	8,410	1,170	7,849	956													
	12	0.14	13,455	2,340	11,213	1,950	10,091	1,755	9,531	1,658	8,410	1,170	7,849	956													
	16	0.13	12,360	2,149	10,255	1,783	9,155	1,592	8,697	1,512	7,599	1,057	6,684	814													
	20	0.11	12,360	2,149	10,255	1,783	9,155	1,592	8,697	1,512	7,599	1,057	6,684	814													

超硬加工用ドリル

リニアドリル

被削材 Work material				1		2		3		4		5		6	
				銅 Copper		炭素鋼・合金鋼 Carbon steels, Alloy steels (180~250HB)		ステンレス鋼・工具鋼 Stainless steels, Tool steels (25~35HRC)		プリハードン鋼 Pre-hardened steels (35~45HRC)		焼入れ鋼 Hardened steels (45~55HRC)		焼入れ鋼 Hardened steels (55~65HRC)	
切り込み比率 Ratio to standard depth of cut				120%		100%		90%		80%		65%		60%	
外径 Tool dia. (mm)	コーナ半径 RE Corner radius (mm)	首下長 Under neck length (mm)	ap (mm)	回転数	送り速度	回転数	送り速度	回転数	送り速度	回転数	送り速度	回転数	送り速度	回転数	送り速度
				n min ⁻¹	Vf mm/min	n min ⁻¹	Vf mm/min	n min ⁻¹	Vf mm/min	n min ⁻¹	Vf mm/min	n min ⁻¹	Vf mm/min	n min ⁻¹	Vf mm/min
4	0.5	12	0.35	13,455	2,340	11,213	1,950	10,091	1,755	9,531	1,658	8,410	1,170	7,849	956
			0.25	12,360	2,149	10,255	1,783	9,155	1,592	8,697	1,512	7,599	1,057	6,684	814
			0.2	12,360	2,149	10,255	1,783	9,155	1,592	8,697	1,512	7,599	1,057	6,684	814
			0.15	12,360	2,149	10,255	1,783	9,155	1,592	8,697	1,512	7,599	1,057	6,684	814
			0.1	12,360	2,149	10,255	1,783	9,155	1,592	8,697	1,512	7,599	1,057	6,684	814
	1	12	0.4	13,455	2,340	11,213	1,950	10,091	1,755	9,531	1,658	8,410	1,170	7,849	956
			0.29	12,360	2,149	10,255	1,783	9,155	1,592	8,697	1,512	7,599	1,057	6,684	814
			0.23	12,360	2,149	10,255	1,783	9,155	1,592	8,697	1,512	7,599	1,057	6,684	814
			0.17	12,360	2,149	10,255	1,783	9,155	1,592	8,697	1,512	7,599	1,057	6,684	814
			0.12	12,360	2,149	10,255	1,783	9,155	1,592	8,697	1,512	7,599	1,057	6,684	814
5	0.1	20	0.08	10,985	2,388	9,154	1,990	8,239	1,791	7,781	1,692	6,866	1,194	6,408	975
			0.06	7,907	1,540	6,590	1,284	5,931	1,155	5,602	1,091	4,943	770	4,613	629
	0.2	20	0.16	10,985	2,388	9,154	1,990	8,239	1,791	7,781	1,692	6,866	1,194	6,408	975
			0.13	7,907	1,540	6,590	1,284	5,931	1,155	5,602	1,091	4,943	770	4,613	629
	0.3	20	0.24	10,985	2,388	9,154	1,990	8,239	1,791	7,781	1,692	6,866	1,194	6,408	975
			0.2	7,907	1,540	6,590	1,284	5,931	1,155	5,602	1,091	4,943	770	4,613	629
	0.5	20	0.35	10,985	2,388	9,154	1,990	8,239	1,791	7,781	1,692	6,866	1,194	6,408	975
			0.135	7,907	1,540	6,590	1,284	5,931	1,155	5,602	1,091	4,943	770	4,613	629
	1	20	0.4	10,985	2,388	9,154	1,990	8,239	1,791	7,781	1,692	6,866	1,194	6,408	975
			0.15	7,907	1,540	6,590	1,284	5,931	1,155	5,602	1,091	4,943	770	4,613	629
6	0.1	12	0.08	9,156	2,389	7,630	1,991	6,868	1,791	6,486	1,692	5,722	1,194	5,342	975
			0.065	9,156	2,389	7,630	1,991	6,868	1,791	6,486	1,692	5,722	1,194	5,342	975
			0.06	9,156	2,389	7,630	1,991	6,868	1,791	6,486	1,692	5,722	1,194	5,342	975
			0.05	7,783	1,827	6,486	1,523	5,837	1,371	5,513	1,294	4,865	914	4,540	746
			0.04	6,590	1,260	5,491	1,050	4,943	945	4,668	892	4,118	623	3,844	508
	0.2	12	0.16	9,156	2,389	7,630	1,991	6,868	1,791	6,486	1,692	5,722	1,194	5,342	975
			0.14	9,156	2,389	7,630	1,991	6,868	1,791	6,486	1,692	5,722	1,194	5,342	975
			0.13	9,156	2,389	7,630	1,991	6,868	1,791	6,486	1,692	5,722	1,194	5,342	975
			0.11	7,783	1,827	6,486	1,523	5,837	1,371	5,513	1,294	4,865	914	4,540	746
			0.08	6,590	1,260	5,491	1,050	4,943	945	4,668	892	4,118	623	3,844	508
	0.3	12	0.24	9,156	2,389	7,630	1,991	6,868	1,791	6,486	1,692	5,722	1,194	5,342	975
			0.22	9,156	2,389	7,630	1,991	6,868	1,791	6,486	1,692	5,722	1,194	5,342	975
			0.2	9,156	2,389	7,630	1,991	6,868	1,791	6,486	1,692	5,722	1,194	5,342	975
			0.18	7,783	1,827	6,486	1,523	5,837	1,371	5,513	1,294	4,865	914	4,540	746
			0.14	6,590	1,260	5,491	1,050	4,943	945	4,668	892	4,118	623	3,844	508
	0.5	18	0.35	9,156	2,389	7,630	1,991	6,868	1,791	6,486	1,692	5,722	1,194	5,342	975
			0.29	9,156	2,389	7,630	1,991	6,868	1,791	6,486	1,692	5,722	1,194	5,342	975
			0.24	7,783	1,827	6,486	1,523	5,837	1,371	5,513	1,294	4,865	914	4,540	746
			0.2	7,783	1,827	6,486	1,523	5,837	1,371	5,513	1,294	4,865	914	4,540	746
			0.165	6,590	1,260	5,491	1,050	4,943	945	4,668	892	4,118	623	3,844	508
1	18	0.4	9,156	2,389	7,630	1,991	6,868	1,791	6,486	1,692	5,722	1,194	5,342	975	
		0.35	9,156	2,389	7,630	1,991	6,868	1,791	6,486	1,692	5,722	1,194	5,342	975	
		0.28	7,783	1,827	6,486	1,523	5,837	1,371	5,513	1,294	4,865	914	4,540	746	
		0.2	6,590	1,260	5,491	1,050	4,943	945	4,668	892	4,118	623	3,844	508	
		0.2	6,590	1,260	5,491	1,050	4,943	945	4,668	892	4,118	623	3,844	508	

- ※(1) apは被削材グループ2での目安を示しています。その他のグループの場合は、上表の切込み比率を目安に調整してください。
- ※(2) リブ加工や止まり溝など、切りくずがつまりやすい切削の場合、切込み設定は基本切込みに切込み比率をかけて算出した切込み量を、さらにその80%まで小さくして使用してください。
- ※(3) aeの設定はap×切込み比率×5倍以下を目安に調整してください。仕上げ加工を行う場合、理論カスプハイトを計算し設定してください。
- ※(4) Z切り込み時のアプローチ方法は、ヘリカルか傾斜での加工を推奨いたします。
- ※(5) L/Dが5以上の場合、
 - ① 彫り込み時の傾斜進入角は1°以下を推奨いたします。また、送り速度は条件表の70%以下に調整してください。
 - ② 文字彫り加工のような溝切削の際は、送り速度は50%以下・apを30%以下を目安に調整してください。また往復切削による加工を推奨いたします。
- ※(1) ap is shown as the criteria for Group 2 workpieces. For other groups, adjust the cutting depth according to the cutting depth factors in the above table.
- ※(2) When performing cutting where cutting chips may cause clogging, such as for rib cutting, blind grooves, etc., cutting depth setting should be set by multiplying a cutting depth factor to calculate the cutting depth amount, and this amount should then be reduced to 80% of the calculated value.
- ※(3) Adjust by setting ae to (5 or less) × (ap) × (cutting depth ratio). When performing finishing cutting, calculate the theoretical cusp height and set accordingly.
- ※(4) Helical or sloped cutting is recommended for the approach method when engraving.
- ※(5) When L/D is 5 or greater:
 - ① The recommended slope entrance angle when engraving is 1° or less. In addition, feed rate should be adjusted to 70% or less of the values in the cutting condition table.
 - ② When slotting such engraving letters, adjust feed rate to 50% or less and ap to 30% or less of the values shown. In addition, cutting by reciprocal cutting is recommended.

【切込み設定例】 EPDRE2030-6-02-ATHの工具でプリハードン鋼(40HRC)をリブ溝等高線切削する場合、
切込み=0.1 (ap) × 0.8 (プリハードン鋼グループ4の切込み比率) × 0.8 (閉鎖域の切削) = 0.064mm

Cutting depth setting example: When cutting rib groove contours in pre-hardened steel (40HRC) using an EPDRE2030-6-02-ATH tool:
Cutting depth = 0.1 (ap) × 0.8 (cutting depth factor for Group 4 pre-hardened steel) × 0.8 (for closed-area cutting) = 0.064mm

- 【注意】**
- ① 被削材、加工形状に合わせて、適切なクーラントを使用してください。
 - ② この標準切削条件表は切削条件の目安を示すものです。実際の加工では加工形状、目的、使用機械等により条件を調整してください。
 - ③ 機械の回転数が足りない場合は、回転数と送り速度を同じ比率で下げてください。

- 【Note】**
- ① Use the appropriate coolant for the work material and machining shape.
 - ② These Recommended Cutting Conditions indicate only the rule of a thumb for the cutting conditions. In actual machining, the condition should be adjusted according to the machining shape, purpose and the machine type.
 - ③ If the rpm of the machine is low, lower the feed rate also to put the rpm and feed rate in the same ratio.

エポックペンシルディープラジラス

ペンシルネック

Pencil Neck

THコーティング採用で高硬度材に適しています。高い耐折損性。

TH Coating makes it ideal for high-hardness materials. High breakage resistance.



外径公差 Dia. tolerance	0~-0.015	RE公差 RE tolerance	±0.005	h5	(mm)
------------------------	----------	----------------------	--------	----	------

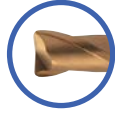

2枚刃
2Flutes

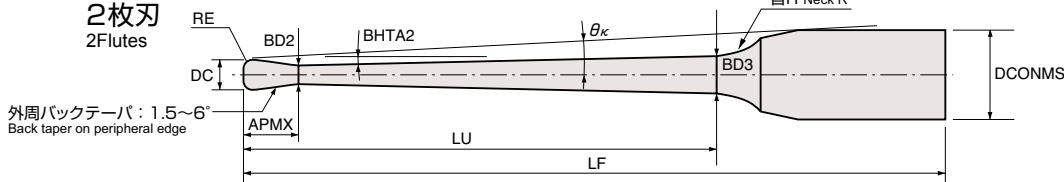

外周バックテーパー: 1.5~6°
Back taper on peripheral edge

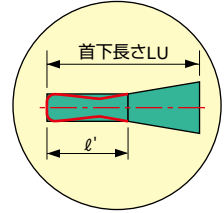

EPDRP2-TH



商品コード Item code	在庫 Stock	寸法 Size(mm)											干渉角度 Interference angle (°)	勾配角に対する実有効首下長 Actual effective length in incline angles					希望小売 価格(円) Suggested retail price (¥)	
		外径 Tool dia.	コーナ半径 Corner radius	首下長 Under neck length	首下角 Neck angle	刃長 Flute length	首径 Neck dia.	首元径 Under Neck dia.	全長 Overall length	シャンク径 Shank dia.	首R Neck R	仮首長 Approx neck length		0.5°	1°	1.5°	2°	3°		
		DC	RE	LU	BHTA2	APMX	BD2	BD3	LF	DCONMS	ℓ'	θ _k								
EPDRP2002-2-09005-TH	●	0.2	0.05	2	0.9	0.15	0.17	0.228	50	4	10	1.1	9.96	-	2.82	3.15	3.44	3.93	18,860	
EPDRP2004-4-09005-TH	●	0.4	0.05	4	0.9	0.3	0.37	0.486	50	4	10	1.25	8.39	-	4.91	5.38	5.76	6.38	13,720	
EPDRP2004-5-09005-TH	●			5	0.9	0.3	0.37	0.518	50	4	10	1.25	7.8	-	5.93	6.47	6.88	7.56	14,360	
EPDRP2004-4-0901-TH	●		0.1	4	0.9	0.3	0.37	0.486	50	4	10	1.25	8.42	-	4.9	5.37	5.74	6.37	13,720	
EPDRP2004-5-0901-TH	●			5	0.9	0.3	0.37	0.518	50	4	10	1.25	7.83	-	5.92	6.46	6.87	7.55	14,360	
EPDRP2005-5-0901-TH	●	0.5	0.1	5	0.9	0.35	0.47	0.616	50	4	10	1.3	7.75	-	5.93	6.47	6.88	7.55	14,360	
EPDRP2005-8-0901-TH	●			8	0.9	0.35	0.47	0.710	50	4	10	1.3	6.39	-	9	9.7	10.21	11.02	14,360	
EPDRP2005-10-0901-TH	●			10	0.9	0.35	0.47	0.773	55	4	10	1.3	5.72	-	11.04	11.84	12.4	13.28	14,360	
EPDRP2006-12-0901-TH	●	0.6	0.1	12	0.9	0.4	0.57	0.934	55	4	10	1.35	5.09	-	13.08	13.97	14.57	15.52	14,250	
EPDRP2006-15-0901-TH	●			15	0.9	0.4	0.57	1.029	55	4	10	1.35	4.45	-	16.14	17.14	17.81	18.84	14,890	
EPDRP2008-6-0402-TH	●	0.8	0.2	6	0.4	0.5	0.77	0.847	50	4	7	2.64	6.91	6.68	7.16	7.52	7.82	8.34	9,140	
EPDRP2008-12-0902-TH	●			12	0.9	0.5	0.77	1.131	55	4	10	1.45	4.94	-	13.08	13.96	14.57	15.51	13,080	
EPDRP2010-8-0402-TH	●	1	0.2	8	0.4	0.8	0.94	1.041	55	6	7	5.09	7.32	8.87	9.39	9.78	10.11	10.66	8,740	
EPDRP2010-10-0902-TH	●			10	0.9	0.8	0.94	1.229	55	6	10	2.7	6.79	-	11.24	11.95	12.48	13.34	8,740	
EPDRP2010-15-0902-TH	●			15	0.9	0.8	0.94	1.386	60	6	10	2.7	5.57	-	16.32	17.23	17.88	18.88	11,680	
EPDRP2010-20-0902-TH	●			20	0.9	0.8	0.94	1.543	65	6	10	2.7	4.72	-	21.39	22.47	23.21	24.78	13,720	
EPDRP2010-25-0902-TH	●			25	0.9	0.8	0.94	1.700	70	6	10	2.7	4.1	-	26.46	27.69	28.51	30.93	14,360	
EPDRP2010-30-0902-TH	●			30	0.9	0.8	0.94	1.857	75	6	10	2.7	3.62	-	31.53	32.89	33.78	37.07	15,000	
EPDRP2010-35-0902-TH	●			35	0.9	0.8	0.94	2.015	80	6	10	2.7	3.24	-	36.59	38.07	39.03	43.22	15,650	
EPDRP2010-8-0403-TH	●			0.3	8	0.4	0.8	0.94	1.041	55	6	7	5.09	7.36	8.87	9.38	9.77	10.09	10.65	8,740
EPDRP2010-15-0903-TH	●				15	0.9	0.8	0.94	1.386	60	6	10	2.7	5.59	-	16.31	17.22	17.86	18.87	11,680
EPDRP2010-25-0903-TH	●				25	0.9	0.8	0.94	1.700	70	6	10	2.7	4.11	-	26.45	27.68	28.5	30.89	14,360
EPDRP2010-30-0903-TH	●	30	0.9		0.8	0.94	1.857	75	6	10	2.7	3.63	-	31.52	32.88	33.77	37.04	15,000		
EPDRP2015-10-0402-TH	●	1.5	0.2	10	0.4	1.35	1.42	1.541	55	6	7	7.07	6.33	11.01	11.56	11.98	12.34	13.08	8,740	
EPDRP2015-15-0902-TH	●			15	0.9	1.35	1.42	1.849	60	6	10	3.89	5.24	-	16.47	17.32	17.95	18.93	10,420	
EPDRP2015-20-0902-TH	●			20	0.9	1.35	1.42	2.006	65	6	10	3.89	4.41	-	21.54	22.55	23.27	24.9	10,420	
EPDRP2015-25-0902-TH	●			25	0.9	1.35	1.42	2.163	70	6	10	3.89	3.81	-	26.6	27.76	28.57	31.04	14,360	
EPDRP2015-30-0902-TH	●			30	0.9	1.35	1.42	2.320	75	6	10	3.89	3.35	-	31.66	32.95	33.83	37.19	14,360	
EPDRP2015-10-0403-TH	●		0.3	10	0.4	1.35	1.42	1.541	55	6	7	7.07	6.36	11	11.56	11.97	12.33	13.04	8,740	
EPDRP2015-20-0903-TH	●			20	0.9	1.35	1.42	2.006	65	6	10	3.89	4.43	-	21.52	22.54	23.26	24.86	10,420	
EPDRP2015-25-0903-TH	●			25	0.9	1.35	1.42	2.163	70	6	10	3.89	3.82	-	26.59	27.75	28.56	31.01	14,360	
EPDRP2015-30-0903-TH	●			30	0.9	1.35	1.42	2.320	75	6	10	3.89	3.36	-	31.65	32.95	33.82	37.16	14,360	

● : 標準在庫品です。● : Stocked items.

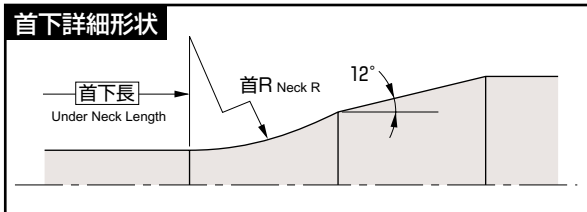

【注意】

加工物に勾配がついている場合、干渉領域は、首下長さよりも長くなります。それぞれの勾配角に対する実有効首下長をご参照ください。
また、工具が加工物に干渉する角度を干渉角度 θ_k で表示していますので合わせてご参照ください。

【Note】

If the workpiece has draft angle, the interference length will be longer than the under-neck length. Please refer to the effective under-neck length for the various draft angles.
In addition, the angle at which the tool will interfere with the workpiece is shown as the "interference angle θ_k ", and should also be referred to.

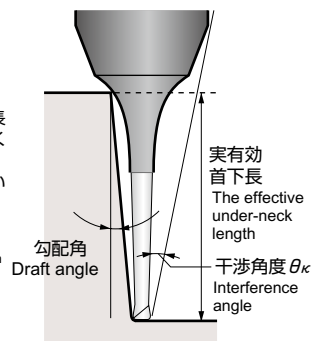

EPDRP2-TH

商品コード Item code	在庫 Stock	寸法 Size(mm)											干渉角度 Interference angle (°)	勾配角に対する実有効首下長 Actual effective length in incline angles					希望小売 価格(円) Suggested retail price (¥)	
		外径 Tool dia.	コーナー半径 Corner radius	首下長 Under neck length	頸角 Neck angle	刃長 Flute length	首径 Neck dia.	首元径 Under Neck dia.	全長 Overall length	シャンク径 Shank dia.	首R Neck R	仮想首長 Approx neck length		0.5°	1°	1.5°	2°	3°		
		DC	RE	LU	BHTA2	APMX	BD2	BD3	LF	DCONMS	ℓ'	ℓ								
EPDRP2020-30-0902-TH	●	2	0.2	30	0.9	1.7	1.92	2.809	70	6	10	4.24	3.07	-	31.69	32.97	33.84	37.22	14,360	
EPDRP2020-40-0902-TH	●			40	0.9	1.7	1.92	3.123	80	6	10	4.24	2.46	-	41.8	43.32	44.66	干涉なし	15,650	
EPDRP2020-50-0902-TH	●			50	0.9	1.7	1.92	3.438	90	6	10	4.24	2.06	-	51.9	53.62	55.74	干涉なし	17,570	
EPDRP2020-12-0403-TH	●		0.3	0.2	12	0.4	1.7	1.92	2.064	55	6	7	7.42	5.46	13.05	13.66	14.12	14.5	15.63	8,740
EPDRP2020-20-0903-TH	●				20	0.9	1.7	1.92	2.495	65	6	10	4.24	4.1	-	21.56	22.57	23.28	24.9	8,740
EPDRP2020-30-0903-TH	●				30	0.9	1.7	1.92	2.809	70	6	10	4.24	3.08	-	31.68	32.96	33.84	37.19	14,360
EPDRP2020-40-0903-TH	●		0.5	0.2	40	0.9	1.7	1.92	3.123	80	6	10	4.24	2.47	-	41.79	43.31	44.64	干涉なし	15,650
EPDRP2020-50-0903-TH	●				50	0.9	1.7	1.92	3.438	90	6	10	4.24	2.06	-	51.89	53.61	55.72	干涉なし	17,570
EPDRP2020-8-0405-TH	●				8	0.4	1.7	1.92	2.008	50	6	4	7.42	6.76	8.73	9.06	9.32	9.54	10.43	8,740
EPDRP2020-12-0405-TH	●		0.5	0.2	12	0.4	1.7	1.92	2.064	55	6	7	7.42	5.51	13.03	13.65	14.1	14.48	15.56	8,740
EPDRP2020-16-0405-TH	●				16	0.4	1.7	1.92	2.120	60	6	7	7.42	4.65	17.08	17.82	18.35	18.78	20.7	8,740
EPDRP2020-20-0905-TH	●				20	0.9	1.7	1.92	2.495	65	6	10	4.24	4.13	-	21.54	22.54	23.26	24.84	8,740
EPDRP2020-25-0905-TH	●				25	0.9	1.7	1.92	2.652	65	6	10	4.24	3.54	-	26.6	27.75	28.55	30.98	11,680
EPDRP2020-30-0905-TH	●				30	0.9	1.7	1.92	2.809	70	6	10	4.24	3.1	-	31.66	32.95	33.82	37.13	14,360
EPDRP2020-40-0905-TH	●				40	0.9	1.7	1.92	3.123	80	6	10	4.24	2.48	-	41.77	43.29	44.6	干涉なし	15,650
EPDRP2020-50-0905-TH	●		50	0.9	1.7	1.92	3.438	90	6	10	4.24	2.07	-	51.87	53.6	55.68	干涉なし	17,570		
EPDRP2030-40-0902-TH	●	3	0.2	40	0.9	2.5	2.86	4.038	80	6	10	6.95	1.94	-	42.04	43.44	干涉なし	干涉なし	15,000	
EPDRP2030-50-0902-TH	●			50	0.9	2.5	2.86	4.352	90	6	10	6.95	1.6	-	52.13	53.74	干涉なし	干涉なし	16,290	
EPDRP2030-60-0902-TH	●			60	0.9	2.5	2.86	4.667	100	6	10	6.95	1.36	-	62.21	干涉なし	干涉なし	干涉なし	17,570	
EPDRP2030-40-0903-TH	●		0.3	0.2	40	0.9	2.5	2.86	4.038	80	6	10	6.95	1.94	-	42.03	43.44	干涉なし	干涉なし	15,000
EPDRP2030-50-0903-TH	●				50	0.9	2.5	2.86	4.352	90	6	10	6.95	1.61	-	52.12	53.73	干涉なし	干涉なし	16,290
EPDRP2030-60-0903-TH	●				60	0.9	2.5	2.86	4.667	100	6	10	6.95	1.36	-	62.21	干涉なし	干涉なし	干涉なし	17,570
EPDRP2030-40-0905-TH	●		0.5	0.2	40	0.9	2.5	2.86	4.038	80	6	10	6.95	1.95	-	42.01	43.42	干涉なし	干涉なし	15,000
EPDRP2030-50-0905-TH	●				50	0.9	2.5	2.86	4.352	90	6	10	6.95	1.61	-	52.1	53.71	干涉なし	干涉なし	16,290
EPDRP2030-60-0905-TH	●				60	0.9	2.5	2.86	4.667	100	6	10	6.95	1.37	-	62.19	干涉なし	干涉なし	干涉なし	17,570

○ 対応被削材 Applicable work material

炭素鋼 合金鋼 Carbon steel Alloy steel	プリハー ド鋼 Pre-hardened steel	高硬度 Hardened steel			ステン レス鋼 Stainless steel	チタン合金 耐熱合金 Titanium alloy Heat-resistant alloy	銅合金 Copper alloy	アルミ 合金 Aluminum alloy
○	◎	> 45HRC ≤ 55HRC	> 55HRC ≤ 65HRC	> 65HRC	○	◎	○	○

○ 再研磨対応外径範囲 Re-grinding compatibility range

商品コード Item code	外周 Outer dia. (mm)	エンド End (mm)
EPDRP-TH	× (N/A)	× (N/A)

● : 標準在庫品です。 ◎ : Stocked items. 干涉なし : No interference

標準切削条件表 Recommended cutting conditions

EPDRP-TH

標準切削条件 Standard cutting condition

被削材 Work material				1		2		3		4		5		6	
				銅 Coppers		炭素鋼・合金鋼 Carbon steels, Alloy steels (180~250HB)		ステンレス鋼・工具鋼 Stainless steels, Tool steels (25~35HRC)		プリハードン鋼 Pre-hardened steels (35~45HRC)		焼入れ鋼 Hardened steels (45~55HRC)		焼入れ鋼 Hardened steels (55~65HRC)	
切り込み比率 Ratio to standard depth of cut				120%		100%		90%		80%		65%		60%	
外径DC Tool dia. (mm)	コーナー半径 Corner radius (mm)	首下長LU Under neck length (mm)	基本切り込み Standard depth of cut (mm)	回転数 n min ⁻¹	送り速度 v _f mm/min	回転数 n min ⁻¹	送り速度 v _f mm/min	回転数 n min ⁻¹	送り速度 v _f mm/min	回転数 n min ⁻¹	送り速度 v _f mm/min	回転数 n min ⁻¹	送り速度 v _f mm/min	回転数 n min ⁻¹	送り速度 v _f mm/min
0.2	0.05	2	0.007	40,000	896	39,600	887	35,640	798	33,660	754	29,700	591	27,720	483
0.4	0.05	4	0.009	36,115	1,078	30,096	899	27,086	809	25,582	764	22,572	599	21,067	489
		5	0.007	32,102	852	26,752	710	24,077	639	22,739	528	20,064	466	18,726	373
	0.1	4	0.009	38,016	1,135	31,680	946	28,512	851	26,928	804	23,760	631	22,176	515
		5	0.007	33,792	897	28,160	747	25,344	673	23,936	556	21,120	490	19,712	392
0.5	0.1	5	0.013	36,495	1,308	30,413	1,090	27,372	981	25,851	753	22,810	562	21,289	453
		8	0.008	29,196	814	24,330	678	21,897	610	20,681	468	18,248	350	17,031	282
		10	0.007	21,897	610	18,248	509	16,423	458	15,511	351	13,686	262	12,773	211
0.6	0.1	12	0.01	24,452	949	20,377	791	18,339	712	17,320	546	15,282	408	14,264	329
		15	0.006	20,072	779	16,727	649	15,054	584	14,218	448	12,545	335	11,709	270
0.8	0.2	6	0.045	38,016	1,301	31,680	1,084	28,512	976	26,928	921	23,760	723	22,176	590
		12	0.02	33,792	1,121	28,160	934	25,344	841	23,936	695	21,120	613	19,712	490
1	0.2	8	0.04	34,214	1,756	28,512	1,463	25,661	1,317	24,235	1,244	21,384	976	19,958	797
		10	0.035	34,214	1,916	28,512	1,596	25,661	1,437	24,235	1,357	21,384	1,064	19,958	869
		15	0.028	30,413	1,514	25,344	1,261	22,810	1,135	21,542	938	19,008	828	17,741	662
		20	0.02	22,810	993	19,008	828	17,107	745	16,157	653	14,256	532	13,306	414
		25	0.017	19,008	828	15,840	690	14,256	621	13,464	544	11,880	443	11,088	345
		30	0.017	19,008	828	15,840	690	14,256	621	13,464	544	11,880	443	11,088	345
	0.3	8	0.04	34,214	1,756	28,512	1,463	25,661	1,317	24,235	1,244	21,384	976	19,958	797
		15	0.028	30,413	1,514	25,344	1,261	22,810	1,135	21,542	938	19,008	828	17,741	662
		25	0.017	19,008	828	15,840	690	14,256	621	13,464	544	11,880	443	11,088	345
		30	0.017	19,008	828	15,840	690	14,256	621	13,464	544	11,880	443	11,088	345
1.5	0.2	10	0.05	26,020	1,295	21,683	1,079	19,515	971	18,431	803	16,262	708	15,178	567
		15	0.045	23,654	1,177	19,712	981	17,741	883	16,755	730	14,784	644	13,798	515
		20	0.042	20,816	1,036	17,347	863	15,612	777	14,745	642	13,010	567	12,143	453
		25	0.032	17,741	773	14,784	644	13,306	579	12,566	508	11,088	414	10,349	322
	0.3	10	0.05	26,020	1,295	21,683	1,079	19,515	971	18,431	803	16,262	708	15,178	567
		20	0.042	20,816	1,036	17,347	863	15,612	777	14,745	642	13,010	567	12,143	453
		25	0.032	17,741	773	14,784	644	13,306	579	12,566	508	11,088	414	10,349	322
		30	0.028	14,784	644	12,320	536	11,088	483	10,472	423	9,240	345	8,624	268

被削材 Work material				1		2		3		4		5		6		
				銅 Coppers		炭素鋼・合金鋼 Carbon steels, Alloy steels (180~250HB)		ステンレス鋼・工具鋼 Stainless steels, Tool steels (25~35HRC)		プリハードン鋼 Pre-hardened steels (35~45HRC)		焼入れ鋼 Hardened steels (45~55HRC)		焼入れ鋼 Hardened steels (55~65HRC)		
切り込み比率 Ratio to standard depth of cut				120%		100%		90%		80%		65%		60%		
外径DC Tool dia. (mm)	コーナ半径R Corner radius (mm)	首下長LU Under neck length (mm)	基本切り込み Standard depth of cut (mm)	回転数 n min ⁻¹	送り速度 V _f mm/min	回転数 n min ⁻¹	送り速度 V _f mm/min	回転数 n min ⁻¹	送り速度 V _f mm/min	回転数 n min ⁻¹	送り速度 V _f mm/min	回転数 n min ⁻¹	送り速度 V _f mm/min	回転数 n min ⁻¹	送り速度 V _f mm/min	
2	0.2	30	0.045	16,128	1,505	13,440	1,254	12,096	1,129	11,424	933	10,080	823	9,408	658	
		40	0.035	12,096	988	10,080	823	9,072	741	8,568	650	7,560	529	7,056	412	
		50	0.017	10,080	823	8,400	686	7,560	617	7,140	541	6,300	441	5,880	343	
	0.3	12	0.088	27,216	2,177	22,680	1,814	20,412	1,633	19,278	1,427	17,010	1,191	15,876	1,048	
		20	0.054	21,773	1,742	18,144	1,452	16,330	1,306	15,422	1,141	13,608	953	12,701	838	
		30	0.045	16,128	1,672	13,440	1,393	12,096	1,254	11,424	1,036	10,080	914	9,408	732	
		40	0.035	12,096	1,097	10,080	914	9,072	823	8,568	722	7,560	588	7,056	457	
		50	0.017	10,080	914	8,400	762	7,560	686	7,140	601	6,300	490	5,880	381	
	0.5	8	0.17	27,216	2,177	22,680	1,814	20,412	1,633	19,278	1,427	17,010	1,191	15,876	1,048	
		12	0.088	27,216	2,177	22,680	1,814	20,412	1,633	19,278	1,427	17,010	1,191	15,876	1,048	
		16	0.088	23,134	1,851	19,278	1,542	17,350	1,388	16,386	1,213	14,459	1,012	13,495	891	
		20	0.054	21,773	1,742	18,144	1,452	16,330	1,306	15,422	1,141	13,608	953	12,701	838	
		25	0.054	19,051	1,524	15,876	1,270	14,288	1,143	13,495	999	11,907	833	11,113	733	
		30	0.045	16,128	1,672	13,440	1,393	12,096	1,254	11,424	1,036	10,080	914	9,408	732	
		40	0.035	12,096	1,097	10,080	914	9,072	823	8,568	722	7,560	588	7,056	457	
	50	0.017	10,080	914	8,400	762	7,560	686	7,140	601	6,300	490	5,880	381		
	3	0.2	40	0.07	12,288	1,147	10,240	956	9,216	860	8,704	711	7,680	627	7,168	502
			50	0.05	9,216	752	7,680	627	6,912	564	6,528	495	5,760	403	5,376	314
			60	0.03	7,680	627	6,400	523	5,760	470	5,440	412	4,800	336	4,480	261
		0.3	40	0.07	12,288	1,274	10,240	1,062	9,216	956	8,704	790	7,680	697	7,168	557
			50	0.05	9,216	836	7,680	697	6,912	627	6,528	550	5,760	448	5,376	348
60			0.03	7,680	697	6,400	581	5,760	523	5,440	458	4,800	373	4,480	290	
0.5		40	0.07	12,288	1,274	10,240	1,062	9,216	956	8,704	790	7,680	697	7,168	557	
		50	0.05	9,216	836	7,680	697	6,912	627	6,528	550	5,760	448	5,376	348	
		60	0.03	7,680	697	6,400	581	5,760	523	5,440	458	4,800	373	4,480	290	

※基本切り込みは被削材グループ2での目安を示しています。その他のグループの場合は、上表の切り込み比率を目安に調整して下さい。
 ※Standard cutting depth is shown as the criteria for Group 2 workpieces. For other groups, adjust the cutting depth according to the cutting depth factors in the above table.

- 【注意】**
- ①被削材、加工形状に合わせて、適切なクーラントを使用してください。
 - ②この標準切削条件表は切削条件の目安を示すものです。実際の加工では加工形状、目的、使用機械等により条件を調整してください。
 - ③機械の回転数が足りない場合は、回転数と送り速度を同じ比率で下げてください。

- 【Note】**
- ① Use the appropriate coolant for the work material and machining shape.
 - ② These Recommended Cutting Conditions indicate only the rule of a thumb for the cutting conditions. In actual machining, the condition should be adjusted according to the machining shape, purpose and the machine type.
 - ③ If the rpm of the machine is low, lower the feed rate also to put the rpm and feed rate in the same ratio.

エポックペンシルディープラジラス

EPDRP-TH

高能率切削条件 High efficiency cutting condition

被削材 Work material				1		2		3		4		5		6	
				銅 Coppers		炭素鋼・合金鋼 Carbon steels, Alloy steels (180~250HB)		ステンレス鋼・工具鋼 Stainless steels, Tool steels (25~35HRC)		プリハードン鋼 Pre-hardened steels (35~45HRC)		焼入れ鋼 Hardened steels (45~55HRC)		焼入れ鋼 Hardened steels (55~65HRC)	
切り込み比率 Ratio to standard depth of cut				120%		100%		90%		80%		65%		60%	
外径DC Tool dia. (mm)	コーナ半径RE Corner radius (mm)	首下長LU Under neck length (mm)	基本切り込み Standard depth of cut (mm)	回転数 n min ⁻¹	送り速度 Vf mm/min	回転数 n min ⁻¹	送り速度 Vf mm/min	回転数 n min ⁻¹	送り速度 Vf mm/min	回転数 n min ⁻¹	送り速度 Vf mm/min	回転数 n min ⁻¹	送り速度 Vf mm/min	回転数 n min ⁻¹	送り速度 Vf mm/min
0.2	0.05	2	0.007	50,000	1,244	49,500	1,232	44,550	1,109	42,075	1,047	37,125	821	34,650	671
0.4	0.05	4	0.009	45,144	1,498	37,620	1,248	33,858	1,123	31,977	1,061	28,215	832	26,334	680
		5	0.007	40,128	1,183	33,440	986	30,096	888	28,424	733	25,080	647	23,408	518
	0.1	4	0.009	47,520	1,577	39,600	1,314	35,640	1,182	33,660	1,117	29,700	876	27,720	715
		5	0.007	42,240	1,246	35,200	1,038	31,680	934	29,920	772	26,400	681	24,640	545
0.5	0.1	5	0.013	45,619	1,816	38,016	1,514	34,214	1,362	32,314	1,045	28,512	780	26,611	629
		8	0.008	36,495	1,130	30,413	942	27,372	848	25,851	650	22,810	486	21,289	391
		10	0.007	27,372	848	22,810	706	20,529	636	19,388	488	17,107	364	15,967	294
0.6	0.1	12	0.01	30,565	1,318	25,471	1,099	22,924	989	21,650	759	19,103	566	17,830	457
		15	0.006	25,091	1,082	20,909	902	18,818	812	17,772	623	15,682	465	14,636	375
0.8	0.2	6	0.045	47,520	1,807	39,600	1,505	35,640	1,355	33,660	1,280	29,700	1,004	27,720	820
		12	0.02	42,240	1,557	35,200	1,298	31,680	1,168	29,920	965	26,400	852	24,640	681
1	0.2	8	0.04	42,768	2,439	35,640	2,032	32,076	1,829	30,294	1,727	26,730	1,355	24,948	1,106
		10	0.035	42,768	2,661	35,640	2,217	32,076	1,995	30,294	1,885	26,730	1,478	24,948	1,207
		15	0.028	38,016	2,102	31,680	1,752	28,512	1,577	26,928	1,303	23,760	1,150	22,176	920
		20	0.02	28,512	1,380	23,760	1,150	21,384	1,035	20,196	907	17,820	739	16,632	575
		25	0.017	23,760	1,150	19,800	958	17,820	862	16,830	756	14,850	616	13,860	479
		30	0.017	23,760	1,150	19,800	958	17,820	862	16,830	756	14,850	616	13,860	479
	0.3	8	0.04	42,768	2,439	35,640	2,032	32,076	1,829	30,294	1,727	26,730	1,355	24,948	1,106
		15	0.028	38,016	2,102	31,680	1,752	28,512	1,577	26,928	1,303	23,760	1,150	22,176	920
		25	0.017	23,760	1,150	19,800	958	17,820	862	16,830	756	14,850	616	13,860	479
		30	0.017	23,760	1,150	19,800	958	17,820	862	16,830	756	14,850	616	13,860	479
1.5	0.2	10	0.05	32,525	1,798	27,104	1,499	24,394	1,349	23,038	1,115	20,328	984	18,973	787
		15	0.045	29,568	1,635	24,640	1,362	22,176	1,226	20,944	1,013	18,480	894	17,248	715
		20	0.042	26,020	1,439	21,683	1,199	19,515	1,079	18,431	892	16,262	787	15,178	629
		25	0.032	22,176	1,073	18,480	894	16,632	805	15,708	706	13,860	575	12,936	447
		30	0.028	18,480	894	15,400	745	13,860	671	13,090	588	11,550	479	10,780	373
	0.3	10	0.05	32,525	1,798	27,104	1,499	24,394	1,349	23,038	1,115	20,328	984	18,973	787
		20	0.042	26,020	1,439	21,683	1,199	19,515	1,079	18,431	892	16,262	787	15,178	629
		25	0.032	22,176	1,073	18,480	894	16,632	805	15,708	706	13,860	575	12,936	447
		30	0.028	18,480	894	15,400	745	13,860	671	13,090	588	11,550	479	10,780	373

超硬合金ペンシル

被削材 Work material				1		2		3		4		5		6		
				銅 Coppers		炭素鋼・合金鋼 Carbon steels, Alloy steels (180~250HB)		ステンレス鋼・工具鋼 Stainless steels, Tool steels (25~35HRC)		プリハードン鋼 Pre-hardened steels (35~45HRC)		焼入れ鋼 Hardened steels (45~55HRC)		焼入れ鋼 Hardened steels (55~65HRC)		
切り込み比率 Ratio to standard depth of cut				120%		100%		90%		80%		65%		60%		
外径DC Tool dia. (mm)	コーナ半径R Corner radius (mm)	首下長LU Under neck length (mm)	基本切り込み Standard depth of cut (mm)	回転数	送り速度	回転数	送り速度	回転数	送り速度	回転数	送り速度	回転数	送り速度	回転数	送り速度	
				n min ⁻¹	V_f mm/min	n min ⁻¹	V_f mm/min	n min ⁻¹	V_f mm/min	n min ⁻¹	V_f mm/min	n min ⁻¹	V_f mm/min	n min ⁻¹	V_f mm/min	n min ⁻¹
2	0.2	30	0.045	20,160	2,090	16,800	1,742	15,120	1,568	14,280	1,295	12,600	1,143	11,760	914	
			0.035	15,120	1,372	12,600	1,143	11,340	1,029	10,710	902	9,450	735	8,820	572	
			0.017	12,600	1,143	10,500	953	9,450	857	8,925	752	7,875	612	7,350	476	
	0.3	12	0.088	31,298	3,130	26,082	2,608	23,474	2,347	22,170	1,951	19,562	1,643	18,257	1,461	
			0.054	25,039	2,504	20,866	2,087	18,779	1,878	17,736	1,561	15,649	1,315	14,606	1,168	
			0.045	20,160	2,322	16,800	1,935	15,120	1,742	14,280	1,439	12,600	1,270	11,760	1,016	
			0.035	15,120	1,524	12,600	1,270	11,340	1,143	10,710	1,002	9,450	816	8,820	635	
	0.5	8	0.17	31,298	3,130	26,082	2,608	23,474	2,347	22,170	1,951	19,562	1,643	18,257	1,461	
			0.088	31,298	3,130	26,082	2,608	23,474	2,347	22,170	1,951	19,562	1,643	18,257	1,461	
			0.088	26,604	2,660	22,170	2,217	19,953	1,995	18,844	1,658	16,627	1,397	15,519	1,242	
			0.054	25,039	2,504	20,866	2,087	18,779	1,878	17,736	1,561	15,650	1,315	14,606	1,168	
			0.054	21,909	2,191	18,257	1,826	16,432	1,643	15,519	1,366	13,693	1,150	12,780	1,022	
			0.045	20,160	2,322	16,800	1,935	15,120	1,742	14,280	1,439	12,600	1,270	11,760	1,016	
			0.035	15,120	1,524	12,600	1,270	11,340	1,143	10,710	1,002	9,450	816	8,820	635	
	3	0.2	40	0.07	15,360	1,593	12,800	1,327	11,520	1,194	10,880	987	9,600	871	8,960	697
				0.05	11,520	1,045	9,600	871	8,640	784	8,160	687	7,200	560	6,720	435
0.03				9,600	871	8,000	726	7,200	653	6,800	573	6,000	467	5,600	363	
0.3		40	0.07	15,360	1,769	12,800	1,475	11,520	1,327	10,880	1,097	9,600	968	8,960	774	
			0.05	11,520	1,161	9,600	968	8,640	871	8,160	764	7,200	622	6,720	484	
			0.03	9,600	968	8,000	806	7,200	726	6,800	636	6,000	518	5,600	403	
0.5		40	0.07	15,360	1,769	12,800	1,475	11,520	1,327	10,880	1,097	9,600	968	8,960	774	
			0.05	11,520	1,161	9,600	968	8,640	871	8,160	764	7,200	622	6,720	484	
			0.03	9,600	968	8,000	806	7,200	726	6,800	636	6,000	518	5,600	403	

※基本切り込みは被削材グループ2での目安を示しています。その他のグループの場合は、上表の切り込み比率を目安に調整して下さい。
 ※Standard cutting depth is shown as the criteria for Group 2 workpieces. For other groups, adjust the cutting depth according to the cutting depth factors in the above table.

- [注意]**
- ①被削材、加工形状に合わせて、適切なクーラントを使用してください。
 - ②この標準切削条件表は切削条件の目安を示すものです。実際の加工では加工形状、目的、使用機械等により条件を調整してください。
 - ③機械の回転数が足りない場合は、回転数と送り速度を同じ比率で下げてください。

- [Note]**
- ① Use the appropriate coolant for the work material and machining shape.
 - ② These Recommended Cutting Conditions indicate only the rule of a thumb for the cutting conditions. In actual machining, the condition should be adjusted according to the machining shape, purpose and the machine type.
 - ③ If the rpm of the machine is low, lower the feed rate also to put the rpm and feed rate in the same ratio.

Epoch Deep Radius F エポックディープラジアスF

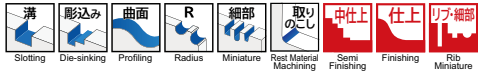

高精度ディープラジアス。
High-accuracy deep radius mill

RE公差 ±0.005
(中心基準 central axis)

h5

(mm)

4枚刃
4Flutes

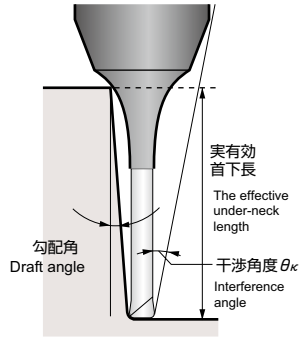
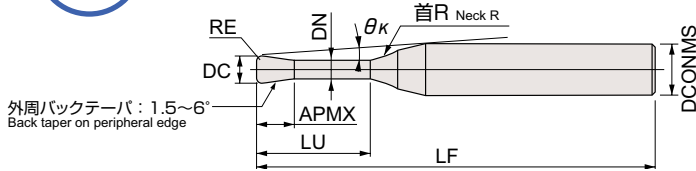

EPDRF4-TH

外径φ4以上はバックドラフト形状ではありません。
φ4 or larger does not have backdraft shape.



商品コード Item code	在庫 Stock	寸法 Size(mm)										干渉角度 Interference angle (°)					希望小売 価格 (円) Suggested retail price (¥)
		外径 Tool dia. DC	コーナ半径 Corner radius RE	首下長 Under neck length LU	刃長 Flute length APMX	首径 Neck dia. DN	全長 Overall length LF	シャンク径 Shank dia. DCONMS	首R Neck R	勾配角に対する実有効首下長 Effective under neck length with respect to draft angle							
										0.5°	1°	1.5°	2°	3°			
EPDRF4010-4-005-TH	●	1	0.05	4	0.8	0.94	50	4	4	7.67	4.75	4.95	5.13	5.28	5.56	8,430	
EPDRF4010-6-005-TH	●			6	0.8	0.94	50	4	4	6.51	6.84	7.09	7.3	7.49	8.13	9,130	
EPDRF4010-8-005-TH	●			8	0.8	0.94	50	4	4	5.66	8.92	9.21	9.46	9.73	10.78	9,130	
EPDRF4010-10-005-TH	●			10	0.8	0.94	50	4	4	5	10.99	11.32	11.59	12.12	13.44	9,130	
EPDRF4010-12-005-TH	●			12	0.8	0.94	60	4	4	4.48	13.06	13.42	13.84	14.51	16.09	9,130	
EPDRF4010-16-005-TH	●			16	0.8	0.94	60	4	4	3.71	17.18	17.6	18.4	19.3	21.4	11,580	
EPDRF4010-20-005-TH	●			20	0.8	0.94	60	4	4	3.17	21.29	21.93	22.96	24.09	26.71	14,250	
EPDRF4010-4-01-TH	●			4	0.8	0.94	50	4	4	7.7	4.74	4.95	5.12	5.28	5.55	8,430	
EPDRF4010-6-01-TH	●		6	0.8	0.94	50	4	4	6.54	6.83	7.09	7.3	7.49	8.11	9,130		
EPDRF4010-8-01-TH	●		8	0.8	0.94	50	4	4	5.68	8.91	9.21	9.45	9.72	10.77	9,130		
EPDRF4010-10-01-TH	●		10	0.8	0.94	50	4	4	5.02	10.99	11.32	11.59	12.11	13.42	9,130		
EPDRF4010-12-01-TH	●		12	0.8	0.94	60	4	4	4.5	13.06	13.42	13.83	14.5	16.08	9,130		
EPDRF4010-16-01-TH	●		16	0.8	0.94	60	4	4	3.72	17.18	17.6	18.39	19.29	21.39	11,580		
EPDRF4010-20-01-TH	●		20	0.8	0.94	60	4	4	3.17	21.29	21.93	22.95	24.08	26.7	14,250		
EPDRF4015-4-005-TH	●		1.5	0.05	4	1.35	1.42	50	4	4	7.12	4.8	4.99	5.16	5.31	5.59	9,130
EPDRF4015-8-005-TH	●				8	1.35	1.42	50	4	4	5.1	8.96	9.25	9.48	9.78	10.85	9,130
EPDRF4015-12-005-TH	●	12			1.35	1.42	60	4	4	3.97	13.09	13.45	13.89	14.57	16.16	10,830	
EPDRF4015-15-005-TH	●	15			1.35	1.42	60	4	4	3.41	16.18	16.58	17.31	18.16	20.14	10,830	
EPDRF4015-20-005-TH	●	20			1.35	1.42	60	4	4	2.76	21.32	21.98	23.01	24.14	-	10,830	
EPDRF4015-4-01-TH	●	4			1.35	1.42	50	4	4	7.15	4.8	4.99	5.16	5.31	5.58	9,130	
EPDRF4015-8-01-TH	●	8			1.35	1.42	50	4	4	5.12	8.96	9.24	9.48	9.77	10.83	9,130	
EPDRF4015-12-01-TH	●	12			1.35	1.42	60	4	4	3.98	13.09	13.45	13.88	14.56	16.14	10,830	
EPDRF4015-15-01-TH	●	15		1.35	1.42	60	4	4	3.42	16.18	16.58	17.3	18.15	20.12	10,830		
EPDRF4015-20-01-TH	●	20		1.35	1.42	60	4	4	2.76	21.32	21.98	23.01	24.13	-	10,830		
EPDRF4020-4-005-TH	●	2		0.05	4	1.7	1.92	50	4	4	6.46	4.8	4.99	5.16	5.31	5.59	7,480
EPDRF4020-6-005-TH	●				6	1.7	1.92	50	4	4	5.27	6.88	7.13	7.33	7.52	8.19	8,430
EPDRF4020-8-005-TH	●				8	1.7	1.92	50	4	4	4.46	8.96	9.25	9.48	9.78	10.85	9,130
EPDRF4020-12-005-TH	●				12	1.7	1.92	60	4	4	3.4	13.09	13.45	13.89	14.57	16.16	9,130
EPDRF4020-16-005-TH	●				16	1.7	1.92	60	4	4	2.75	17.21	17.63	18.45	19.36	-	9,130
EPDRF4020-20-005-TH	●				20	1.7	1.92	60	4	4	2.31	21.32	21.98	23.01	24.14	-	9,130
EPDRF4020-4-01-TH	●		4		1.7	1.92	50	4	4	6.49	4.8	4.99	5.16	5.31	5.58	7,480	
EPDRF4020-6-01-TH	●		6		1.7	1.92	50	4	4	5.3	6.88	7.12	7.33	7.51	8.18	8,430	
EPDRF4020-8-01-TH	●		8		1.7	1.92	50	4	4	4.47	8.96	9.24	9.48	9.77	10.83	9,130	
EPDRF4020-12-01-TH	●		12		1.7	1.92	60	4	4	3.41	13.09	13.45	13.88	14.56	16.14	9,130	
EPDRF4020-16-01-TH	●		16		1.7	1.92	60	4	4	2.76	17.21	17.62	18.44	19.35	-	9,130	
EPDRF4020-20-01-TH	●		20		1.7	1.92	60	4	4	2.31	21.32	21.98	23.01	24.13	-	9,130	
EPDRF4020-4-02-TH	●		4	1.7	1.92	50	4	4	6.57	4.79	4.98	5.15	5.3	5.57	7,480		
EPDRF4020-6-02-TH	●		6	1.7	1.92	50	4	4	5.35	6.88	7.12	7.32	7.5	8.14	8,430		
EPDRF4020-8-02-TH	●		8	1.7	1.92	50	4	4	4.51	8.95	9.24	9.47	9.75	10.8	9,130		
EPDRF4020-12-02-TH	●		12	1.7	1.92	60	4	4	3.43	13.09	13.44	13.87	14.54	16.11	9,130		
EPDRF4020-16-02-TH	●		16	1.7	1.92	60	4	4	2.77	17.21	17.62	18.43	19.33	-	9,130		
EPDRF4020-20-02-TH	●		20	1.7	1.92	60	4	4	2.32	21.32	21.97	22.99	24.11	-	9,130		
EPDRF4020-25-02-TH	●		25	1.7	1.92	70	4	4	1.93	26.44	27.42	28.69	-	-	12,220		
EPDRF4020-30-02-TH	●		30	1.7	1.92	70	4	4	1.66	31.55	32.87	34.4	-	-	15,000		

●印：標準在庫品です。
●：Stocked items.

EPDRF4○○○-○○○-○○○-TH

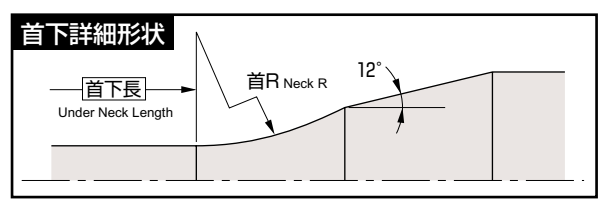

商品コード Item code	在庫 Stock	寸法 Size(mm)								首R Neck R	干渉角度 Interference angle (°) θ_K	勾配角に対する実有効首下長 Effective under neck length with respect to draft angle					希望小売 価格(円) Suggested retail price (¥)						
		外径 Tool dia.	コーナ半径 Corner radius	首下長 Under neck length	刃長 Flute length	首径 Neck dia.	全長 Overall length	シャンク径 Shank dia.	DC			RE	LU	APMX	DN	LF		DCONMS	0.5°	1°	1.5°	2°	3°
		DC	RE	LU	APMX	DN	LF	DCONMS	Neck R			0.5°	1°	1.5°	2°	3°							
EPDRF4020-4-03-TH	●	2	0.3	4	1.7	1.92	50	4	4	4	6.64	4.79	4.97	5.14	5.29	5.55	7,480						
EPDRF4020-8-03-TH	●			8	1.7	1.92	50	4	4	4	4.55	8.95	9.23	9.47	9.73	10.77	9,130						
EPDRF4020-12-03-TH	●			12	1.7	1.92	60	4	4	4	3.45	13.09	13.44	13.85	14.52	16.08	9,130						
EPDRF4020-16-03-TH	●			16	1.7	1.92	60	4	4	4	2.79	17.21	17.61	18.42	19.31	-	9,130						
EPDRF4020-20-03-TH	●			20	1.7	1.92	60	4	4	4	2.33	21.31	21.96	22.98	24.09	-	9,130						
EPDRF4020-4-05-TH	●			4	1.7	1.92	50	4	4	4	6.8	4.78	4.96	5.12	5.26	5.53	7,480						
EPDRF4020-6-05-TH	●		6	1.7	1.92	50	4	4	4	5.5	6.86	7.1	7.3	7.48	8.05	8,430							
EPDRF4020-8-05-TH	●		8	1.7	1.92	50	4	4	4	4.62	8.94	9.22	9.45	9.7	10.7	9,130							
EPDRF4020-12-05-TH	●		12	1.7	1.92	60	4	4	4	3.5	13.08	13.43	13.83	14.48	16.01	9,130							
EPDRF4020-16-05-TH	●		16	1.7	1.92	60	4	4	4	2.81	17.2	17.61	18.39	19.27	-	9,130							
EPDRF4020-20-05-TH	●		20	1.7	1.92	60	4	4	4	2.35	21.31	21.95	22.95	24.06	-	9,130							
EPDRF4020-25-05-TH	●		25	1.7	1.92	70	4	4	4	1.95	26.43	27.39	28.65	-	-	12,220							
EPDRF4020-30-05-TH	●	30	1.7	1.92	70	4	4	4	1.67	31.54	32.84	34.36	-	-	15,000								
EPDRF4025-8-01-TH	●	2.5	0.1	8	2	2.4	50	4	4	4	3.68	9	9.27	9.51	9.83	10.89	9,130						
EPDRF4025-16-01-TH	●			16	2	2.4	60	4	4	4	2.19	17.24	17.67	18.5	19.4	-	9,580						
EPDRF4025-20-01-TH	●			20	2	2.4	60	4	4	4	1.82	21.35	22.03	23.06	-	-	9,580						
EPDRF4025-8-02-TH	●			8	2	2.4	50	4	4	4	3.72	8.99	9.27	9.5	9.81	10.86	9,130						
EPDRF4025-16-02-TH	●		16	2	2.4	60	4	4	4	2.2	17.24	17.67	18.48	19.38	-	9,580							
EPDRF4025-20-02-TH	●		20	2	2.4	60	4	4	4	1.83	21.34	22.02	23.05	-	-	9,580							
EPDRF4025-12-03-TH	●		12	2	2.4	60	4	4	4	2.78	13.12	13.47	13.91	14.58	-	9,580							
EPDRF4025-20-03-TH	●		20	2	2.4	60	4	4	4	1.84	21.34	22.01	23.03	-	-	9,580							
EPDRF4025-12-05-TH	●		12	2	2.4	60	4	4	4	2.82	13.12	13.46	13.88	14.54	-	9,580							
EPDRF4025-20-05-TH	●		20	2	2.4	60	4	4	4	1.85	21.34	22	23	-	-	9,580							
EPDRF4030-8-01-TH	●		3	0.1	8	2.5	2.86	60	6	4	4	5.61	9.07	9.34	9.56	9.94	11.02	9,130					
EPDRF4030-16-01-TH	●				16	2.5	2.86	60	6	4	4	3.69	17.3	17.78	18.6	19.52	21.64	11,790					
EPDRF4030-25-01-TH	●	25			2.5	2.86	70	6	4	4	2.67	26.52	27.58	28.87	30.28	-	11,790						
EPDRF4030-30-01-TH	●	30			2.5	2.86	80	6	4	4	2.31	31.62	33.03	34.57	36.27	-	13,610						
EPDRF4030-8-02-TH	●	8		2.5	2.86	60	6	4	4	5.65	9.07	9.33	9.55	9.92	10.99	9,130							
EPDRF4030-12-02-TH	●	12		2.5	2.86	60	6	4	4	4.48	13.19	13.52	14.03	14.71	16.3	10,470							
EPDRF4030-16-02-TH	●	16		2.5	2.86	60	6	4	4	3.71	17.3	17.77	18.59	19.5	21.6	11,790							
EPDRF4030-20-02-TH	●	20		2.5	2.86	70	6	4	4	3.16	21.4	22.13	23.15	24.28	26.91	11,790							
EPDRF4030-25-02-TH	●	25		2.5	2.86	70	6	4	4	2.67	26.51	27.57	28.86	30.27	-	11,790							
EPDRF4030-30-02-TH	●	30		2.5	2.86	80	6	4	4	2.31	31.62	33.02	34.56	36.25	-	13,610							
EPDRF4030-8-03-TH	●	8		2.5	2.86	60	6	4	4	5.68	9.07	9.33	9.54	9.9	10.95	9,130							
EPDRF4030-16-03-TH	●	16		2.5	2.86	60	6	4	4	3.72	17.3	17.76	18.58	19.48	21.57	11,790							
EPDRF4030-20-03-TH	●	20	2.5	2.86	70	6	4	4	3.17	21.4	22.12	23.14	24.26	26.88	11,790								
EPDRF4030-25-03-TH	●	25	2.5	2.86	70	6	4	4	2.68	26.51	27.56	28.84	30.25	-	11,790								
EPDRF4030-30-03-TH	●	30	2.5	2.86	80	6	4	4	2.32	31.62	33.01	34.54	36.23	-	13,610								
EPDRF4030-8-05-TH	●	8	2.5	2.86	60	6	4	4	5.76	9.06	9.31	9.53	9.87	10.89	9,130								
EPDRF4030-12-05-TH	●	12	2.5	2.86	60	6	4	4	4.55	13.18	13.51	13.99	14.65	16.2	10,470								
EPDRF4030-16-05-TH	●	16	2.5	2.86	60	6	4	4	3.75	17.29	17.74	18.55	19.44	21.51	11,790								
EPDRF4030-20-05-TH	●	20	2.5	2.86	70	6	4	4	3.2	21.39	22.1	23.11	24.22	26.82	11,790								
EPDRF4030-25-05-TH	●	25	2.5	2.86	70	6	4	4	2.7	26.51	27.55	28.81	30.21	-	11,790								
EPDRF4030-30-05-TH	●	30	2.5	2.86	80	6	4	4	2.33	31.61	32.99	34.52	36.19	-	13,610								
EPDRF4030-35-05-TH	●	35	2.5	2.86	80	6	4	4	2.06	36.82	38.44	40.22	42.17	-	15,000								

エポックディープラジアスF

超硬合金ドリル

EPDRF4○○○○-○○○-○○○-TH

商品コード Item code	在庫 Stock	寸法 Size(mm)									干渉角度 Interference angle (°) θ_K	勾配角に対する実有効首下長 Effective under neck length with respect to draft angle					希望小売 価格(円) Suggested retail price (¥)
		外径 Tool dia.	コーナ半径 Corner radius	首下長 Under neck length	刃長 Flute length	首径 Neck dia.	全長 Overall length	シャンク径 Shank dia.	首R	0.5°		1°	1.5°	2°	3°		
		DC	RE	LU	APMX	DN	LF	DCONMS	Neck R								
EPDRF4040-12-01-TH	●	4	0.1	12	4	3.9	60	6	4	3.4	13.13	13.47	13.94	14.62	16.2	10,470	
EPDRF4040-20-01-TH	●			20	4	3.9	60	6	4	2.31	21.35	22.03	23.06	24.19	-	11,790	
EPDRF4040-30-01-TH	●			30	4	3.9	80	6	4	1.65	31.57	32.93	34.46	-	-	11,790	
EPDRF4040-40-01-TH	●		40	4	3.9	80	6	4	1.28	41.95	43.82	-	-	-	15,000		
EPDRF4040-12-02-TH	●		0.2	12	4	3.9	60	6	4	3.42	13.12	13.47	13.92	14.6	16.17	10,470	
EPDRF4040-20-02-TH	●			20	4	3.9	60	6	4	2.32	21.34	22.02	23.05	24.17	-	11,790	
EPDRF4040-30-02-TH	●			30	4	3.9	80	6	4	1.65	31.57	32.92	34.45	-	-	11,790	
EPDRF4040-40-02-TH	●		40	4	3.9	80	6	4	1.29	41.94	43.81	-	-	-	15,000		
EPDRF4040-12-03-TH	●		0.3	12	4	3.9	60	6	4	3.44	13.12	13.47	13.91	14.58	16.14	10,470	
EPDRF4040-20-03-TH	●			20	4	3.9	60	6	4	2.33	21.34	22.01	23.03	24.15	-	11,790	
EPDRF4040-30-03-TH	●			30	4	3.9	80	6	4	1.66	31.57	32.91	34.44	-	-	11,790	
EPDRF4040-40-03-TH	●		40	4	3.9	80	6	4	1.29	41.94	43.8	-	-	-	15,000		
EPDRF4040-12-05-TH	●		0.5	12	4	3.9	60	6	4	3.49	13.12	13.46	13.88	14.54	16.07	10,470	
EPDRF4040-20-05-TH	●			20	4	3.9	60	6	4	2.35	21.34	22	23	24.11	-	11,790	
EPDRF4040-30-05-TH	●			30	4	3.9	80	6	4	1.67	31.57	32.89	34.41	-	-	11,790	
EPDRF4040-40-05-TH	●			40	4	3.9	80	6	4	1.29	41.93	43.79	-	-	-	15,000	
EPDRF4050-20-01-TH	●	5	0.1	20	5	4.9	70	6	4	1.28	21.35	22.03	-	-	-	17,740	
EPDRF4050-40-01-TH	●			40	5	4.9	90	6	4	0.68	41.95	-	-	-	-	19,080	
EPDRF4050-20-02-TH	●		0.2	20	5	4.9	70	6	4	1.28	21.34	22.02	-	-	-	17,740	
EPDRF4050-40-02-TH	●			40	5	4.9	90	6	4	0.68	41.94	-	-	-	-	19,080	
EPDRF4050-20-03-TH	●		0.3	20	5	4.9	70	6	4	1.29	21.34	22.01	-	-	-	17,740	
EPDRF4050-40-03-TH	●			40	5	4.9	90	6	4	0.68	41.94	-	-	-	-	19,080	
EPDRF4050-20-05-TH	●		0.5	20	5	4.9	70	6	4	1.3	21.34	22	-	-	-	17,740	
EPDRF4050-40-05-TH	●			40	5	4.9	90	6	4	0.69	41.93	-	-	-	-	19,080	
EPDRF4050-20-10-TH	●		1	20	5	4.9	70	6	4	1.33	21.32	21.95	-	-	-	17,740	
EPDRF4050-40-10-TH	●			40	5	4.9	90	6	4	0.69	41.91	-	-	-	-	19,080	
EPDRF4060-30-02-TH	●	6	0.2	30	6	5.9	80	6	4	0	-	-	-	-	-	18,640	
EPDRF4060-54-02-TH	●			54	6	5.9	100	6	4	0	-	-	-	-	-	-	22,790
EPDRF4060-72-02-TH	●		72	6	5.9	120	6	4	0	-	-	-	-	-	-	26,930	
EPDRF4060-30-03-TH	●		0.3	30	6	5.9	80	6	4	0	-	-	-	-	-	-	18,640
EPDRF4060-54-03-TH	●			54	6	5.9	100	6	4	0	-	-	-	-	-	-	22,790
EPDRF4060-72-03-TH	●		72	6	5.9	120	6	4	0	-	-	-	-	-	-	26,930	
EPDRF4060-30-05-TH	●		0.5	30	6	5.9	80	6	4	0	-	-	-	-	-	-	18,640
EPDRF4060-54-05-TH	●			54	6	5.9	100	6	4	0	-	-	-	-	-	-	22,790
EPDRF4060-72-05-TH	●		72	6	5.9	120	6	4	0	-	-	-	-	-	-	26,930	
EPDRF4060-30-10-TH	●		1	30	6	5.9	80	6	4	0	-	-	-	-	-	-	18,640
EPDRF4060-54-10-TH	●			54	6	5.9	100	6	4	0	-	-	-	-	-	-	22,790
EPDRF4060-72-10-TH	●		72	6	5.9	120	6	4	0	-	-	-	-	-	-	26,930	

○ 対応被削材 Applicable work material

炭素鋼 合金鋼 Carbon steel Alloy steel	プリハー ド鋼 Pre-hardened steel	高硬度 Hardened steel			ステン レス鋼 Stainless steel	チタン合金 耐熱合金 Titanium alloy Heat-resistant alloy	銅合金 Copper alloy	アルミ 合金 Aluminum alloy
○	○	> 45HRC ≤ 55HRC	> 55HRC ≤ 65HRC	> 65HRC	○	○	○	○

○：標準在庫品です。●：Stocked items.

○ 再研磨対応外径範囲 Re-grinding compatibility range

商品コード Item code	外周 Outer dia. (mm)	エンド End (mm)
EPDRF-TH	× (N/A)	4 ~ 6

【注意】首下長/外径が10DCを超える工具の再研磨可否については、弊社営業にお問い合わせください。
【Note】Contact our sales office regarding whether or not regrinding is possible for tools where under neck length/tool diameter more than 10DC.

標準切削条件表 Recommended cutting conditions

EPDRF-TH

被削材 Work material				1		2		3		4		5		6	
				銅 Copper		炭素鋼・合金鋼 Carbon steels, Alloy steels (180~250HB)		ステンレス鋼・工具鋼 Stainless steels, Tool steels (25~35HRC)		プリハードン鋼 Pre-hardened steels (35~45HRC)		焼入れ鋼 Hardened steels (45~55HRC)		焼入れ鋼 Hardened steels (55~65HRC)	
切り込み比率 Ratio to standard depth of cut				120%		100%		90%		80%		65%		60%	
外径DC Tool dia. (mm)	コーナ半径RE Corner radius (mm)	首下長LU Under neck length (mm)	基本切り込み Standard depth of Cut (mm)	回転数 n min ⁻¹	送り速度 Vf mm/min	回転数 n min ⁻¹	送り速度 Vf mm/min	回転数 n min ⁻¹	送り速度 Vf mm/min	回転数 n min ⁻¹	送り速度 Vf mm/min	回転数 n min ⁻¹	送り速度 Vf mm/min	回転数 n min ⁻¹	送り速度 Vf mm/min
1	0.05	4	0.012	38,900	2,440	31,120	1,952	28,008	1,757	26,608	1,669	23,947	1,230	22,749	1,000
		6	0.01	31,500	1,780	25,200	1,424	22,680	1,282	21,546	1,218	19,391	990	18,422	810
		8	0.008	28,000	1,580	22,400	1,264	20,160	1,138	19,152	1,081	17,237	880	16,375	720
		10	0.005	24,500	1,390	19,600	1,112	17,640	1,001	16,758	951	15,082	770	14,328	630
		12	0.004	21,800	1,100	17,440	880	15,696	792	14,911	752	13,420	600	12,749	480
		16	0.003	21,800	960	17,440	768	15,696	691	14,911	657	13,420	510	12,749	400
	0.1	20	0.002	16,300	720	13,040	576	11,736	518	11,149	492	10,034	385	9,533	300
		4	0.02	38,900	2,440	31,120	1,952	28,008	1,757	26,608	1,669	23,947	1,230	22,749	1,000
		6	0.018	31,500	1,780	25,200	1,424	22,680	1,282	21,546	1,218	19,391	990	18,422	810
		8	0.014	28,000	1,580	22,400	1,264	20,160	1,138	19,152	1,081	17,237	880	16,375	720
		10	0.01	24,500	1,390	19,600	1,112	17,640	1,001	16,758	951	15,082	770	14,328	630
		12	0.008	21,800	1,100	17,440	880	15,696	792	14,911	752	13,420	600	12,749	480
		16	0.006	21,800	960	17,440	768	15,696	691	14,911	657	13,420	510	12,749	400
		20	0.004	16,300	720	13,040	576	11,736	518	11,149	492	10,034	385	9,533	300
1.5	0.05	4	0.02	29,900	2,030	23,920	1,624	21,528	1,462	20,452	1,389	18,406	1,020	17,486	830
		8	0.014	27,200	1,850	21,760	1,480	19,584	1,332	18,605	1,265	16,744	1,030	15,907	840
		12	0.007	21,800	1,480	17,440	1,184	15,696	1,066	14,911	1,012	13,420	820	12,749	670
		15	0.006	16,900	1,020	13,520	816	12,168	734	11,560	698	10,404	560	9,883	450
		20	0.004	16,900	1,020	13,520	816	12,168	734	11,560	698	10,404	560	9,883	450
	0.1	4	0.027	29,900	2,030	23,920	1,624	21,528	1,462	20,452	1,389	18,406	1,020	17,486	830
		8	0.02	27,200	1,850	21,760	1,480	19,584	1,332	18,605	1,265	16,744	1,030	15,907	840
		12	0.017	21,800	1,480	17,440	1,184	15,696	1,066	14,911	1,012	13,420	820	12,749	670
		15	0.014	16,900	1,020	13,520	816	12,168	734	11,560	698	10,404	560	9,883	450
		20	0.01	16,900	1,020	13,520	816	12,168	734	11,560	698	10,404	560	9,883	450
2	0.05	4	0.035	24,900	2,940	20,800	2,450	18,700	2,210	17,700	2,080	15,600	1,470	14,600	1,200
		6	0.03	24,900	2,940	20,800	2,450	18,700	2,210	17,700	2,080	15,600	1,470	14,600	1,200
		8	0.025	22,700	2,670	18,900	2,230	17,000	2,010	16,100	1,890	14,200	1,340	13,200	1,090
		12	0.02	18,400	1,950	15,300	1,620	13,800	1,460	13,000	1,380	11,500	1,080	10,700	890
		16	0.015	16,300	1,730	13,600	1,440	12,200	1,300	11,600	1,230	10,200	960	9,500	790
		20	0.01	14,300	1,520	11,900	1,260	10,700	1,140	10,100	1,070	8,900	840	8,300	690
	0.1	4	0.042	24,900	2,940	20,800	2,450	18,700	2,210	17,700	2,080	15,600	1,470	14,600	1,200
		6	0.042	24,900	2,940	20,800	2,450	18,700	2,210	17,700	2,080	15,600	1,470	14,600	1,200
		8	0.036	22,700	2,670	18,900	2,230	17,000	2,010	16,100	1,890	14,200	1,340	13,200	1,090
		12	0.036	18,400	1,950	15,300	1,620	13,800	1,460	13,000	1,380	11,500	1,080	10,700	890
		16	0.023	16,300	1,730	13,600	1,440	12,200	1,300	11,600	1,230	10,200	960	9,500	790
		20	0.018	14,300	1,520	11,900	1,260	10,700	1,140	10,100	1,070	8,900	840	8,300	690
	0.2	4	0.08	24,900	2,940	20,800	2,450	18,700	2,210	17,700	2,080	15,600	1,470	14,600	1,200
		6	0.08	24,900	2,940	20,800	2,450	18,700	2,210	17,700	2,080	15,600	1,470	14,600	1,200
		8	0.07	22,700	2,670	18,900	2,230	17,000	2,010	16,100	1,890	14,200	1,340	13,200	1,090
		12	0.04	18,400	1,950	15,300	1,620	13,800	1,460	13,000	1,380	11,500	1,080	10,700	890
		16	0.04	16,300	1,730	13,600	1,440	12,200	1,300	11,600	1,230	10,200	960	9,500	790
		20	0.035	14,300	1,520	11,900	1,260	10,700	1,140	10,100	1,070	8,900	840	8,300	690
	0.3	4	0.11	24,900	2,940	20,800	2,450	18,700	2,210	17,700	2,080	15,600	1,470	14,600	1,200
		8	0.09	22,700	2,850	18,900	2,350	17,000	2,100	16,100	1,950	14,200	1,490	13,200	1,210
		12	0.06	18,400	2,170	15,300	1,810	13,800	1,620	13,000	1,530	11,500	1,200	10,700	980
		16	0.06	16,300	1,930	13,600	1,610	12,200	1,440	11,600	1,360	10,200	1,070	9,500	870
		20	0.037	14,300	1,680	11,900	1,400	10,700	1,260	10,100	1,190	8,900	940	8,300	770

【注意】 ご使用にあたっては、A221ページの表下の項目と注意を参照してください。 **【Note】** Upon usage, please refer to comments and notes below table on page A221.

エポックディープラジアスF

EPDRF-TH

被削材 Work material				1		2		3		4		5		6	
				銅 Copper		炭素鋼・合金鋼 Carbon steels, Alloy steels (180~250HB)		ステンレス鋼・工具鋼 Stainless steels, Tool steels (25~35HRC)		プリハードン鋼 Pre-hardened steels (35~45HRC)		焼入れ鋼 Hardened steels (45~55HRC)		焼入れ鋼 Hardened steels (55~65HRC)	
切り込み比率 Ratio to standard depth of cut				120%		100%		90%		80%		65%		60%	
外径DC Tool dia. (mm)	コーナ半径RE Corner radius (mm)	首下長LU Under neck length (mm)	基本切り込み Standard depth of Cut (mm)	回転数 n min ⁻¹	送り速度 Vf mm/min	回転数 n min ⁻¹	送り速度 Vf mm/min	回転数 n min ⁻¹	送り速度 Vf mm/min	回転数 n min ⁻¹	送り速度 Vf mm/min	回転数 n min ⁻¹	送り速度 Vf mm/min	回転数 n min ⁻¹	送り速度 Vf mm/min
2	0.5	4	0.17	24,900	2,940	20,800	2,450	18,700	2,210	17,700	2,080	15,600	1,470	14,600	1,200
		6	0.17	24,900	2,940	20,800	2,450	18,700	2,210	17,700	2,080	15,600	1,470	14,600	1,200
		8	0.14	22,700	2,850	18,900	2,350	17,000	2,100	16,100	1,950	14,200	1,490	13,200	1,210
		12	0.08	18,400	2,170	15,300	1,810	13,800	1,620	13,000	1,530	11,500	1,200	10,700	980
		16	0.08	16,300	1,930	13,600	1,610	12,200	1,440	11,600	1,360	10,200	1,070	9,500	870
		20	0.05	14,300	1,680	11,900	1,400	10,700	1,260	10,100	1,190	8,900	940	8,300	770
		25	0.05	14,300	1,680	11,900	1,400	10,700	1,260	10,100	1,190	8,900	940	8,300	770
		30	0.03	13,600	1,600	11,300	1,330	10,200	1,200	9,600	1,130	8,500	850	7,900	730
2.5	0.1	8	0.047	22,700	2,970	18,900	2,480	17,000	2,230	16,100	2,100	14,200	1,490	13,200	1,210
		16	0.037	16,300	1,930	13,600	1,610	12,200	1,440	11,600	1,360	10,200	1,070	9,500	870
		20	0.025	14,300	1,680	11,900	1,400	10,700	1,260	10,100	1,190	8,900	940	8,300	770
	0.2	8	0.08	19,400	2,570	16,200	2,140	14,600	1,920	13,800	1,820	12,200	1,280	11,300	1,100
		16	0.045	16,900	2,130	14,100	1,770	12,700	1,600	12,000	1,510	10,600	1,110	9,900	960
		20	0.042	14,100	1,750	11,800	1,410	10,600	1,270	10,000	1,200	8,800	930	8,200	790
	0.3	12	0.09	17,700	2,350	14,800	1,960	13,300	1,760	12,500	1,660	11,100	1,230	10,300	1,010
		20	0.052	14,100	1,870	11,800	1,560	10,600	1,400	10,000	1,330	8,800	1,040	8,200	850
	0.5	12	0.1	17,700	2,350	14,800	1,960	13,300	1,760	12,500	1,660	11,100	1,230	10,300	1,010
		20	0.07	14,100	1,870	11,800	1,560	10,600	1,400	10,000	1,330	8,800	1,040	8,200	850
3	0.1	8	0.055	17,300	2,550	14,400	2,120	13,000	1,910	12,200	1,800	10,800	1,270	10,100	1,040
		16	0.035	17,300	2,550	14,400	2,120	13,000	1,910	12,200	1,800	10,800	1,270	10,100	1,040
		25	0.022	14,000	2,060	11,700	1,720	10,500	1,550	9,900	1,460	8,700	1,150	8,200	940
		30	0.014	10,900	2,060	9,100	1,720	8,200	1,550	7,700	1,460	6,800	1,150	6,400	940
	0.2	8	0.09	17,300	2,550	14,400	2,120	13,000	1,910	12,200	1,800	10,800	1,270	10,100	1,040
		12	0.07	17,300	2,550	14,400	2,120	13,000	1,910	12,200	1,800	10,800	1,270	10,100	1,040
		16	0.05	17,300	2,550	14,400	2,120	13,000	1,910	12,200	1,800	10,800	1,270	10,100	1,040
		20	0.05	14,000	2,060	11,700	1,720	10,500	1,550	9,900	1,460	8,700	1,150	8,200	940
		25	0.045	14,000	2,060	11,700	1,720	10,500	1,550	9,900	1,460	8,700	1,150	8,200	940
		30	0.04	10,900	2,060	9,100	1,720	8,200	1,550	7,700	1,460	6,800	1,150	6,400	940
	0.3	8	0.13	17,300	2,830	14,400	2,360	13,000	2,120	12,200	2,010	10,800	1,410	10,100	1,160
		16	0.075	17,300	2,830	14,400	2,360	13,000	2,120	12,200	2,010	10,800	1,410	10,100	1,160
		20	0.075	14,000	2,290	11,700	1,910	10,500	1,720	9,900	1,620	8,700	1,270	8,200	1,040
		25	0.067	14,000	2,290	11,700	1,910	10,500	1,720	9,900	1,620	8,700	1,270	8,200	1,040
		30	0.06	10,900	2,290	9,100	1,910	8,200	1,720	7,700	1,620	6,800	1,270	6,400	1,040
	0.5	8	0.18	17,300	2,830	14,400	2,360	13,000	2,120	12,200	2,010	10,800	1,410	10,100	1,160
		12	0.13	17,300	2,830	14,400	2,360	13,000	2,120	12,200	2,010	10,800	1,410	10,100	1,160
		16	0.1	17,300	2,830	14,400	2,360	13,000	2,120	12,200	2,010	10,800	1,410	10,100	1,160
		20	0.1	14,000	2,290	11,700	1,910	10,500	1,720	9,900	1,620	8,700	1,270	8,200	1,040
		25	0.09	14,000	2,290	11,700	1,910	10,500	1,720	9,900	1,620	8,700	1,270	8,200	1,040
30		0.08	10,900	2,290	9,100	1,910	8,200	1,720	7,700	1,620	6,800	1,270	6,400	1,040	
35		0.065	10,900	2,290	9,100	1,910	8,200	1,720	7,700	1,620	6,800	1,270	6,400	1,040	
4	0.1	12	0.065	12,400	3,350	10,400	2,790	9,300	2,520	8,800	2,240	7,800	1,750	7,200	1,300
		20	0.055	12,400	3,350	10,400	2,790	9,300	2,520	8,800	2,240	7,800	1,750	7,200	1,300
		30	0.045	11,200	3,020	9,300	2,520	8,400	2,010	7,900	1,830	7,000	1,470	6,500	1,170
		40	0.03	11,200	3,020	9,300	2,520	8,400	2,010	7,900	1,830	7,000	1,470	6,500	1,170
	0.2	12	0.13	12,400	3,350	10,400	2,790	9,300	2,520	8,800	2,240	7,800	1,750	7,200	1,300
		20	0.1	12,400	3,350	10,400	2,790	9,300	2,520	8,800	2,240	7,800	1,750	7,200	1,300
		30	0.08	11,200	3,020	9,300	2,520	8,400	2,010	7,900	1,830	7,000	1,470	6,500	1,170
		40	0.06	11,200	3,020	9,300	2,520	8,400	2,010	7,900	1,830	7,000	1,470	6,500	1,170

超硬合金チップ

リニアガイド

被削材 Work material				1		2		3		4		5		6	
				銅 Copper		炭素鋼・合金鋼 Carbon steels, Alloy steels (180~250HB)		ステンレス鋼・工具鋼 Stainless steels, Tool steels (25~35HRC)		プリハードン鋼 Pre-hardened steels (35~45HRC)		焼入れ鋼 Hardened steels (45~55HRC)		焼入れ鋼 Hardened steels (55~65HRC)	
切り込み比率 Ratio to standard depth of cut				120%		100%		90%		80%		65%		60%	
外径DC Tool dia. (mm)	コーナ半径RE Corner radius (mm)	首下長LU Under neck length (mm)	基本切り込み Standard depth of Cut (mm)	回転数 n min ⁻¹	送り速度 V_f mm/min	回転数 n min ⁻¹	送り速度 V_f mm/min	回転数 n min ⁻¹	送り速度 V_f mm/min	回転数 n min ⁻¹	送り速度 V_f mm/min	回転数 n min ⁻¹	送り速度 V_f mm/min	回転数 n min ⁻¹	送り速度 V_f mm/min
4	0.3	12	0.17	12,400	3,350	10,400	2,790	9,300	2,520	8,800	2,380	7,800	1,860	7,200	1,410
		20	0.13	12,400	3,350	10,400	2,790	9,300	2,520	8,800	2,380	7,800	1,860	7,200	1,410
		30	0.1	11,200	3,020	9,300	2,520	8,400	2,260	7,900	1,900	7,000	1,570	6,500	1,170
		40	0.08	11,200	3,020	9,300	2,520	8,400	2,260	7,900	1,900	7,000	1,570	6,500	1,170
	0.5	12	0.24	12,400	3,350	10,400	2,790	9,300	2,520	8,800	2,380	7,800	1,860	7,200	1,410
		20	0.2	12,400	3,350	10,400	2,790	9,300	2,520	8,800	2,380	7,800	1,860	7,200	1,410
		30	0.17	11,200	3,020	9,300	2,520	8,400	2,260	7,900	1,900	7,000	1,570	6,500	1,170
5	0.1	20	0.07	9,700	2,620	8,100	2,190	7,300	1,970	6,900	1,760	6,100	1,370	5,700	1,020
		40	0.035	8,700	2,360	7,300	1,970	6,600	1,570	6,200	1,430	5,500	1,150	5,100	920
	0.2	20	0.15	9,700	2,620	8,100	2,190	7,300	1,970	6,900	1,760	6,100	1,370	5,700	1,020
		40	0.08	8,700	2,360	7,300	1,970	6,600	1,570	6,200	1,430	5,500	1,150	5,100	920
	0.3	20	0.21	9,700	2,620	8,100	2,190	7,300	1,970	6,900	1,860	6,100	1,460	5,700	1,110
		40	0.1	8,700	2,360	7,300	1,970	6,600	1,770	6,200	1,490	5,500	1,230	5,100	920
	0.5	20	0.28	9,700	2,620	8,100	2,190	7,300	1,970	6,900	1,860	6,100	1,460	5,700	1,110
		40	0.14	8,700	2,360	7,300	1,970	6,600	1,770	6,200	1,490	5,500	1,230	5,100	920
1	20	0.35	9,700	2,620	8,100	2,190	7,300	1,970	6,900	1,860	6,100	1,460	5,700	1,110	
	40	0.18	8,700	2,360	7,300	1,970	6,600	1,770	6,200	1,490	5,500	1,230	5,100	920	
6	0.2	30	0.15	8,600	2,330	7,200	1,940	6,500	1,750	6,100	1,560	5,400	1,220	5,000	910
		54	0.1	7,800	2,100	6,500	1,750	5,800	1,400	5,500	1,270	4,900	1,020	4,500	820
		72	0.07	7,800	2,100	6,500	1,750	5,800	1,400	5,500	1,270	4,900	1,020	4,500	820
	0.3	30	0.25	8,600	2,330	7,200	1,940	6,500	1,750	6,100	1,560	5,400	1,300	5,000	980
		54	0.18	7,800	2,100	6,500	1,750	5,800	1,570	5,500	1,270	4,900	1,090	4,500	820
		72	0.1	7,800	2,100	6,500	1,750	5,800	1,570	5,500	1,270	4,900	1,090	4,500	820
	0.5	30	0.35	8,600	2,330	7,200	1,940	6,500	1,750	6,100	1,650	5,400	1,300	5,000	980
		54	0.25	7,800	2,100	6,500	1,750	5,800	1,570	5,500	1,320	4,900	1,090	4,500	820
		72	0.15	7,800	2,100	6,500	1,750	5,800	1,570	5,500	1,320	4,900	1,090	4,500	820
	1	30	0.55	8,600	2,330	7,200	1,940	6,500	1,750	6,100	1,650	5,400	1,300	5,000	980
		54	0.4	7,800	2,100	6,500	1,750	5,800	1,570	5,500	1,320	4,900	1,090	4,500	820
		72	0.22	7,800	2,100	6,500	1,750	5,800	1,570	5,500	1,320	4,900	1,090	4,500	820

【注意】

基本切り込みは被削材グループ2での目安を示しています。その他のグループの場合は、上表の切り込み比率を目安に調整してください。
上記条件は仕上げ加工条件の目安です。荒加工においては、送り速度を更に30%程度上げる事が可能です。

- ①被削材、加工形状に合わせて、適切なクーラントを使用してください。
- ②この標準切削条件表は切削条件の目安を示すものです。実際の加工では加工形状、目的、使用機械等により条件を調整してください。
- ③機械の回転数が足りない場合は、回転数と送り速度を同じ比率で下げてください。

【Note】

The indicated standard cutting depth is a reference value for Group 2 work materials. For materials in other groups, the cutting depth should be adjusted using the reference ratio shown in the above table.

The above conditions are reference conditions for finish machining. For rough machining, it is possible to increase the feed rate by around 30%.

- ①Use the appropriate coolant for the work material and machining shape.
- ②These Recommended Cutting Conditions indicate only the rule of a thumb for the cutting conditions.
In actual machining, the condition should be adjusted according to the machining shape, purpose and the machine type.
- ③If the machine rotation speed is insufficient, reduce the rotation speed and feed rate by the same ratio.

Epoch Turbo Rib エポックターボリブ

ストレートネック

Straight Neck

ビビリ振動を抑制して、より深くより速く加工可能。
Suppresses chattering to enable deeper, faster machining.



RE公差 ±0.01

h5

(mm)

4枚刃
4Flutes

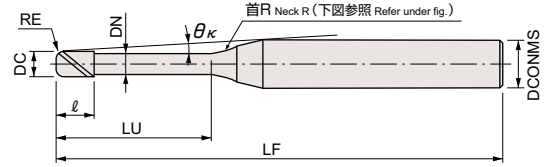

ETR4 ○○○○ - ○○○○ - ○○○○ - TH

超硬 TH ねじり45° 切削条件表 A224
Carbide Helix angle Cutting Conditions

商品コード Item code	在庫 Stock	寸法 Size (mm)								干渉角度 Interference angle (°)	勾配角に対する実有効首下長 Effective under neck length with respect to draft angle					希望小売 価格(円) Suggested retail price (¥)
		外径 Tool dia.	コーナ半径 Corner radius	首下長 Under neck length	刃長 Flute length	首径 Neck dia.	全長L Overall length	シャンク径 Shank dia.	首R Neck R		0.5°	1°	1.5°	2°	3°	
		DC	RE	LU	ℓ	DN	LF	DCONMS								
ETR4010-5-02-TH	●	1	0.2	5	1	0.94	50	6	4	8.52	5.79	6.01	6.21	6.38	6.75	10,110
ETR4010-7.5-02-TH	●			7.5	1	0.94	50	6	4	7.42	8.39	8.68	8.91	9.11	10.07	10,940
ETR4010-10-02-TH	●			10	1	0.94	50	6	4	6.58	10.98	11.32	11.58	12.09	13.39	10,940
ETR4010-12.5-02-TH	●			12.5	1	0.94	60	6	4	5.90	13.57	13.94	14.38	15.08	16.71	10,940
ETR4010-15-02-TH	●			15	1	0.94	60	6	4	5.35	16.15	16.55	17.24	18.07	20.03	13,930
ETR4010-17.5-02-TH	●			17.5	1	0.94	60	6	4	4.90	18.72	19.20	20.09	21.07	23.35	13,930
ETR4010-20-02-TH	●			20	1	0.94	60	6	4	4.51	21.29	21.92	22.94	24.06	26.66	17,140
ETR4010-22.5-02-TH	●			22.5	1	0.94	70	6	4	4.19	23.85	24.64	25.79	27.05	29.98	22,930
ETR4010-25-02-TH	●			25	1	0.94	70	6	4	3.90	26.41	27.37	28.64	30.04	33.30	22,930
ETR4010-27.5-02-TH	●			27.5	1	0.94	70	6	4	3.65	28.97	30.09	31.49	33.03	36.62	28,180
ETR4010-30-02-TH	●	30	1	0.94	70	6	4	3.44	31.52	32.82	34.34	36.02	39.94	28,180		
ETR40125-5-02-TH	●	1.25	0.2	5	1.25	1.18	50	6	4	8.38	5.81	6.03	6.22	6.39	6.79	10,110
ETR40125-10-02-TH	●			10	1.25	1.18	50	6	4	6.42	11.00	11.33	11.59	12.12	13.42	10,940
ETR40125-15-02-TH	●			15	1.25	1.18	60	6	4	5.20	16.16	16.56	17.26	18.10	20.06	13,930
ETR40125-20-02-TH	●			20	1.25	1.18	60	6	4	4.37	21.30	21.95	22.97	24.09	26.69	17,140
ETR40125-25-02-TH	●			25	1.25	1.18	70	6	4	3.77	26.42	27.39	28.67	30.07	33.33	22,930
ETR40125-30-02-TH	●	30	1.25	1.18	70	6	4	3.31	31.54	32.84	34.37	36.05	39.97	28,180		
ETR4015-5-03-TH	●	1.5	0.3	5	1.5	1.42	50	6	4	8.28	5.83	6.05	6.23	6.40	6.79	10,410
ETR4015-10-03-TH	●			10	1.5	1.42	50	6	4	6.28	11.02	11.34	11.60	12.13	13.42	10,940
ETR4015-15-03-TH	●			15	1.5	1.42	60	6	4	5.05	16.18	16.57	17.28	18.11	20.06	12,970
ETR4015-20-03-TH	●			20	1.5	1.42	60	6	4	4.23	21.31	21.96	22.98	24.09	26.69	12,970
ETR4015-25-03-TH	●			25	1.5	1.42	70	6	4	3.63	26.43	27.41	28.68	30.08	33.33	17,360
ETR4015-30-03-TH	●	30	1.5	1.42	70	6	4	3.19	31.55	32.86	34.38	36.06	39.97	21,320		
ETR40175-10-03-TH	●	1.75	0.3	10	1.75	1.65	50	6	4	6.09	11.06	11.37	11.63	12.18	13.48	10,940
ETR40175-20-03-TH	●			20	1.75	1.65	60	6	4	4.07	21.34	22.01	23.03	24.15	26.76	12,970
ETR40175-30-03-TH	●			30	1.75	1.65	70	6	4	3.05	31.57	32.91	34.44	36.12	40.03	21,320
ETR40175-40-03-TH	●			40	1.75	1.65	80	6	4	2.44	41.94	43.80	45.84	48.08	干渉なし	25,600
ETR4020-10-05-TH	●	2	0.5	10	2	1.92	50	6	4	5.98	11.01	11.33	11.59	12.09	13.36	10,940
ETR4020-15-05-TH	●			15	2	1.92	60	6	4	4.75	16.17	16.56	17.25	18.07	19.99	10,940
ETR4020-20-05-TH	●			20	2	1.92	60	6	4	3.94	21.31	21.95	22.95	24.06	26.63	10,940
ETR4020-25-05-TH	●			25	2	1.92	70	6	4	3.36	26.43	27.39	28.65	30.04	33.27	14,680
ETR4020-30-05-TH	●			30	2	1.92	70	6	4	2.93	31.54	32.84	34.36	36.02	干渉なし	18,000
ETR4020-35-05-TH	●			35	2	1.92	80	6	4	2.60	36.67	38.29	40.06	42.00	干渉なし	19,820
ETR4020-40-05-TH	●	40	2	1.92	80	6	4	2.34	41.88	43.73	45.76	47.99	干渉なし	21,650		
ETR4025-10-05-TH	●	2.5	0.5	10	2.5	2.4	50	6	4	5.57	11.05	11.36	11.61	12.15	13.42	10,940
ETR4025-20-05-TH	●			20	2.5	2.4	60	6	4	3.59	21.34	22.00	23.00	24.11	26.69	11,470
ETR4025-30-05-TH	●			30	2.5	2.4	70	6	4	2.64	31.57	32.89	34.41	36.08	干渉なし	18,860
ETR4025-40-05-TH	●			40	2.5	2.4	80	6	4	2.09	41.93	43.79	45.81	48.04	干渉なし	22,610
ETR4025-50-05-TH	●	50	2.5	2.4	90	6	4	1.73	52.36	54.68	57.22	干渉なし	干渉なし	26,780		
ETR4030-10-08-TH	●	3	0.8	10	3	2.86	50	6	4	5.17	11.12	11.40	11.66	12.20	13.45	12,540
ETR4030-20-08-TH	●			20	3	2.86	60	6	4	3.23	21.39	22.07	23.07	24.17	26.72	14,150
ETR4030-30-08-TH	●			30	3	2.86	70	6	4	2.35	31.61	32.97	34.47	36.13	干渉なし	16,290
ETR4030-40-08-TH	●			40	3	2.86	80	6	4	1.85	42.02	43.86	45.88	干渉なし	干渉なし	20,780
ETR4030-50-08-TH	●	50	3	2.86	90	6	4	1.52	52.45	54.76	57.28	干渉なし	干渉なし	24,530		

首下詳細形状

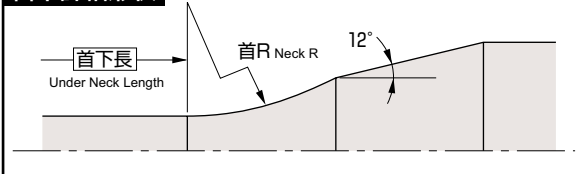

【注意】

加工物に勾配がついている場合、干渉領域は、首下長さよりも長くなります。それぞれの勾配角に対する実有効首下長をご参照ください。
また、工具が加工物に干渉する角度を干渉角度 θ_k で表示していますので合わせてご参照ください。

【Note】

If the workpiece has draft angle, the interference length will be longer than the under-neck length. Please refer to the effective under-neck length for the various draft angles.
In addition, the angle at which the tool will interfere with the workpiece is shown as the "interference angle θ_k ", and should also be referred to.

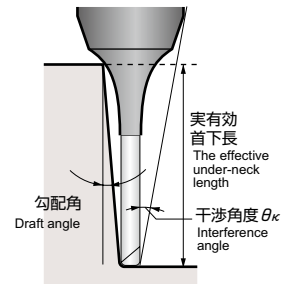

●：標準在庫品です。●：Stocked items. 干渉なし：No interference

ペンシルネック Pencil Neck



RE公差 ±0.01

h5

(mm)

4枚刃
4Flutes



ビビリ振動を抑制して、より深くより速く加工可能。
Suppresses chattering to enable deeper, faster machining.

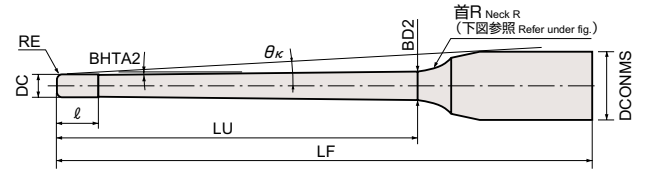

ETRP4-TH

超硬 TH 切れ味45 切削条件表 A225

商品コード Item code	在庫 Stock	寸法 Size (mm)										干渉角度 Interference angle (°)	勾配角に対する実有効首下長 Effective under neck length with respect to draft angle					希望小売 価格 (円) Suggested retail price (¥)
		外径 Tool dia.	コーナ半径 Corner radius	首下長 Under neck length	首下角 Neck angle	刃長 Flute length	首元径dn Under neck dia.	全長L Overall length	シャンク径 Shank dia.	首R Neck R	θ _k		0°	1°	1.5°	2°	3°	
		DC	RE	LU	BHTA2	ℓ	BD2	LF	DCONMS									
ETRP4010-5-0902-TH	●	1	0.2	5	0.9	1	1.066	60	6	4	8.67	2.91	5.70	5.96	6.17	6.51	12,540	
ETRP4010-7.5-0902-TH	●			7.5	0.9	1	1.144	60	6	7	7.61	2.91	8.50	8.97	9.34	9.93	12,540	
ETRP4010-10-0902-TH	●			10	0.9	1	1.223	60	6	7	6.78	2.91	11.04	11.60	12.03	12.70	12,540	
ETRP4010-15-0902-TH	●			15	0.9	1	1.380	60	6	10	5.57	2.91	16.35	17.25	17.89	18.89	16,830	
ETRP4010-20-0902-TH	●			20	0.9	1	1.537	70	6	10	4.72	2.91	21.42	22.49	23.22	24.80	19,820	
ETRP4010-25-0902-TH	●			25	0.9	1	1.694	70	6	10	4.10	2.91	26.49	27.70	28.52	30.95	20,680	
ETRP4010-30-0902-TH	●			30	0.9	1	1.851	80	6	10	3.62	2.91	31.55	32.90	33.79	37.09	21,650	
ETRP4010-35-0902-TH	●			35	0.9	1	2.008	80	6	10	3.24	2.91	36.61	38.08	39.03	43.24	22,500	
ETRP4010-40-0902-TH	●			40	0.9	1	2.165	90	6	10	2.94	2.91	41.67	43.25	44.54	干涉なし	24,000	
ETRP4010-45-0902-TH	●			45	0.9	1	2.322	90	6	10	2.68	2.91	46.73	48.41	50.08	干涉なし	24,640	
ETRP4010-50-0902-TH	●	50	0.9	1	2.480	100	6	10	2.47	2.91	51.78	53.56	55.62	干涉なし	25,290			
ETRP40125-10-0902-TH	●	1.25	0.2	10	0.9	1.25	1.455	60	6	7	6.62	3.47	11.10	11.65	12.06	12.73	12,540	
ETRP40125-15-0902-TH	●			15	0.9	1.25	1.612	60	6	10	5.41	3.47	16.42	17.29	17.92	18.91	16,830	
ETRP40125-20-0902-TH	●			20	0.9	1.25	1.769	70	6	10	4.57	3.47	21.49	22.52	23.25	24.86	19,820	
ETRP40125-30-0902-TH	●			30	0.9	1.25	2.083	80	6	10	3.49	3.47	31.61	32.93	33.81	37.15	21,650	
ETRP40125-40-0902-TH	●			40	0.9	1.25	2.397	90	6	10	2.82	3.47	41.73	43.28	44.59	干涉なし	24,000	
ETRP40125-50-0902-TH	●			50	0.9	1.25	2.712	100	6	10	2.37	3.47	51.83	53.59	55.67	干涉なし	25,290	
ETRP4015-10-0903-TH	●	1.5	0.3	10	0.9	1.5	1.687	60	6	7	6.47	4.04	11.15	11.67	12.08	12.74	12,540	
ETRP4015-15-0903-TH	●			15	0.9	1.5	1.844	60	6	7	5.26	4.04	16.21	16.89	17.40	18.73	15,000	
ETRP4015-20-0903-TH	●			20	0.9	1.5	2.001	70	6	10	4.43	4.04	21.54	22.55	23.27	24.88	15,000	
ETRP4015-30-0903-TH	●			30	0.9	1.5	2.315	80	6	10	3.36	4.04	31.66	32.95	33.83	37.17	20,680	
ETRP4015-40-0903-TH	●			40	0.9	1.5	2.630	90	6	10	2.71	4.04	41.77	43.30	44.62	干涉なし	24,000	
ETRP4015-50-0903-TH	●			50	0.9	1.5	2.944	100	6	10	2.27	4.04	51.88	53.60	55.70	干涉なし	25,290	
ETRP40175-10-0903-TH	●	1.75	0.3	10	0.9	1.75	1.909	60	6	7	6.28	4.93	11.24	11.74	12.13	12.77	12,540	
ETRP40175-15-0903-TH	●			15	0.9	1.75	2.066	60	6	7	5.07	4.93	16.29	16.95	17.44	18.82	15,000	
ETRP40175-20-0903-TH	●			20	0.9	1.75	2.223	70	6	10	4.26	4.93	21.64	22.61	23.32	24.97	15,000	
ETRP40175-30-0903-TH	●			30	0.9	1.75	2.538	80	6	10	3.22	4.93	31.75	33.00	33.86	37.26	20,680	
ETRP40175-40-0903-TH	●			40	0.9	1.75	2.852	90	6	10	2.59	4.93	41.86	43.34	44.70	干涉なし	24,000	
ETRP40175-50-0903-TH	●			50	0.9	1.75	3.166	100	6	10	2.16	4.93	51.95	53.64	55.78	干涉なし	25,290	
ETRP4020-15-0905-TH	●	2	0.5	15	0.9	2	2.328	60	6	7	4.95	4.54	16.23	16.91	17.40	18.72	12,540	
ETRP4020-20-0905-TH	●			20	0.9	2	2.486	70	6	7	4.12	4.54	21.29	22.10	22.67	24.86	12,540	
ETRP4020-25-0905-TH	●			25	0.9	2	2.643	70	6	10	3.54	4.54	26.63	27.77	28.57	31.01	16,830	
ETRP4020-30-0905-TH	●			30	0.9	2	2.800	80	6	10	3.1	4.54	31.69	32.96	33.83	37.16	20,680	
ETRP4020-35-0905-TH	●			35	0.9	2	2.957	80	6	10	2.75	4.54	36.75	38.14	39.09	干涉なし	21,650	
ETRP4020-40-0905-TH	●			40	0.9	2	3.114	90	6	10	2.48	4.54	41.80	43.31	44.63	干涉なし	22,500	
ETRP4020-45-0905-TH	●			45	0.9	2	3.271	90	6	10	2.25	4.54	46.85	48.46	50.17	干涉なし	25,290	
ETRP4020-50-0905-TH	●			50	0.9	2	3.428	100	6	10	2.07	4.54	51.90	53.61	55.71	干涉なし	25,290	
ETRP4020-55-0905-TH	●			55	0.9	2	3.585	100	6	10	1.91	4.54	56.95	58.75	干涉なし	26,900		
ETRP4020-60-0905-TH	●			60	0.9	2	3.742	110	6	10	1.77	4.54	62.00	63.89	干涉なし	26,900		
ETRP4025-20-0905-TH	●	2.5	0.5	20	0.9	2.5	2.950	70	6	7	3.76	5.68	21.39	22.16	22.72	24.98	16,290	
ETRP4025-30-0905-TH	●			30	0.9	2.5	3.264	80	6	10	2.79	5.68	31.80	33.02	33.88	干涉なし	20,680	
ETRP4025-40-0905-TH	●			40	0.9	2.5	3.578	90	6	10	2.22	5.68	41.90	43.36	44.73	干涉なし	22,500	
ETRP4025-50-0905-TH	●			50	0.9	2.5	3.892	100	6	10	1.85	5.68	52.00	53.66	干涉なし	25,290		
ETRP4025-60-0905-TH	●			60	0.9	2.5	4.207	110	6	10	1.58	5.68	62.09	63.93	干涉なし	26,900		
ETRP4030-20-0908-TH	●			3	0.8	20	0.9	3	3.394	70	6	7	3.39	7.45	21.50	22.22	22.76	25.05
ETRP4030-30-0908-TH	●	30	0.9			3	3.708	80	6	7	2.49	7.45	31.59	32.54	33.74	干涉なし	18,750	
ETRP4030-40-0908-TH	●	40	0.9			3	4.022	90	6	10	1.96	7.45	42.03	43.42	干涉なし	21,650		
ETRP4030-50-0908-TH	●	50	0.9			3	4.337	100	6	10	1.62	7.45	52.12	53.72	干涉なし	23,360		
ETRP4030-60-0908-TH	●	60	0.9			3	4.651	110	6	10	1.37	7.45	62.20	干涉なし	干涉なし	25,290		

ETR-TH、ETRP-THの対応被削材

Applicable work material of ETR-TH, ETRP-TH

炭素鋼 合金鋼 Carbon steel Alloy steel	プリハー ド鋼 Pre-hardened steel ≤ 45HRC	高硬度 Hardened steel			ステン レス鋼 Stainless steel	チタン合金 耐熱合金 Titanium alloy Heat-resistant alloy	銅合金 Copper alloy	アルミ 合金 Aluminum alloy
○	○	> 45HRC ≤ 55HRC	> 55HRC ≤ 65HRC	> 65HRC	○	○	○	

再研磨対応外径範囲 Re-grinding compatibility range

商品コード Item code	外周 Outer dia. (mm)	エンド End (mm)
ETR-TH	× (N/A)	2 ~ 3
ETRP-TH	× (N/A)	2 ~ 3

[注意] 首下長 / 外径が10DCを超える工具の再研磨可否については、弊社営業にお問い合わせください。
[Note] Contact our sales office regarding whether or not regrinding is possible for tools where under neck length/tool diameter more than 10DC

Epoch Turbo Rib エポックターボリブ

標準切削条件表 Recommended cutting conditions

ETR-TH

首下ストレート
Straight Neck

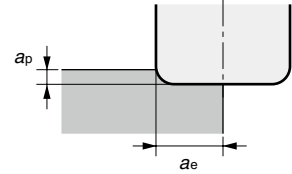

被削材 Work material	鋳鉄・炭素鋼・合金鋼 Cast irons, Carbon steels, Alloy steels (150~250HB) FC S50C SCM				工具鋼 Tool steels (25~35HRC) SUS304 SKD				プリハードン鋼 Pre-hardened steels (35~45HRC) NAK80 CENA1				焼入れ鋼 Hardened steels (45~55HRC) SKD61 SKT4				焼入れ鋼 Hardened steels (55~60HRC) SKD11 SKH51					
	外径 Tool dia. mm	首下長 Under neck length mm	回転数 min ⁻¹	送り速度 mm/min	ap mm	ae mm	回転数 min ⁻¹	送り速度 mm/min	ap mm	ae mm	回転数 min ⁻¹	送り速度 mm/min	ap mm	ae mm	回転数 min ⁻¹	送り速度 mm/min	ap mm	ae mm	回転数 min ⁻¹	送り速度 mm/min	ap mm	ae mm
1	5	5	32,000	5,820	0.040	0.50	27,100	4,510	0.040	0.50	22,300	2,900	0.032	0.50	19,100	2,480	0.020	0.50	15,900	830	0.012	0.50
	7.5	5	32,000	5,820	0.027	0.50	27,100	4,510	0.027	0.50	22,300	2,900	0.021	0.50	19,100	2,480	0.013	0.50	15,900	830	0.008	0.50
	10	5	32,000	5,820	0.020	0.50	27,100	4,510	0.020	0.50	22,300	2,900	0.016	0.50	19,100	2,480	0.010	0.50	15,900	830	0.006	0.50
	12.5	5	28,800	5,240	0.016	0.50	24,400	4,060	0.016	0.50	20,100	2,610	0.013	0.50	17,200	2,230	0.008	0.50	14,300	750	0.005	0.50
	15	5	28,800	5,240	0.013	0.50	24,400	4,060	0.013	0.50	20,100	2,610	0.011	0.50	17,200	2,230	0.007	0.50	14,300	750	0.004	0.50
	17.5	5	25,600	4,660	0.011	0.50	21,700	3,610	0.011	0.50	17,800	2,320	0.009	0.50	15,300	1,980	0.006	0.50	12,700	660	0.003	0.50
	20	5	25,600	4,660	0.010	0.50	21,700	3,610	0.010	0.50	17,800	2,320	0.008	0.50	15,300	1,980	0.005	0.50	12,700	660	0.003	0.50
	22.5	5	22,400	4,070	0.009	0.50	19,000	3,160	0.009	0.50	15,600	2,030	0.007	0.50	13,400	1,740	0.004	0.50	11,100	580	0.003	0.50
	25	5	22,400	4,070	0.008	0.50	19,000	3,160	0.008	0.50	15,600	2,030	0.006	0.50	13,400	1,740	0.004	0.50	11,100	580	0.002	0.50
	27.5	5	19,200	3,490	0.007	0.50	16,300	2,710	0.007	0.50	13,400	1,740	0.006	0.50	11,500	1,490	0.004	0.50	9,500	500	0.002	0.50
30	5	19,200	3,490	0.007	0.50	16,300	2,710	0.007	0.50	13,400	1,740	0.005	0.50	11,500	1,490	0.003	0.50	9,500	500	0.002	0.50	
1.25	5	10	25,000	6,130	0.063	0.62	21,600	4,840	0.063	0.62	17,800	3,120	0.050	0.62	15,300	2,680	0.031	0.62	12,700	890	0.019	0.62
	10	10	25,000	6,130	0.031	0.62	21,600	4,840	0.031	0.62	17,800	3,120	0.025	0.62	15,300	2,680	0.016	0.62	12,700	890	0.009	0.62
	15	10	22,500	5,520	0.021	0.62	19,400	4,360	0.021	0.62	16,000	2,810	0.017	0.62	13,800	2,410	0.010	0.62	11,400	800	0.006	0.62
	20	10	20,000	4,900	0.016	0.62	17,300	3,870	0.016	0.62	14,200	2,500	0.013	0.62	12,200	2,140	0.008	0.62	10,200	710	0.005	0.62
	25	10	20,000	4,900	0.013	0.62	17,300	3,870	0.013	0.62	14,200	2,500	0.010	0.62	12,200	2,140	0.006	0.62	10,200	710	0.004	0.62
1.5	5	10	21,000	6,620	0.090	0.75	18,000	5,180	0.090	0.75	14,900	3,350	0.072	0.75	12,700	2,860	0.045	0.75	10,600	950	0.027	0.75
	10	10	21,000	6,620	0.045	0.75	18,000	5,180	0.045	0.75	14,900	3,350	0.036	0.75	12,700	2,860	0.023	0.75	10,600	950	0.014	0.75
	15	10	21,000	6,620	0.030	0.75	18,000	5,180	0.030	0.75	14,900	3,350	0.024	0.75	12,700	2,860	0.015	0.75	10,600	950	0.009	0.75
	20	10	18,900	5,960	0.023	0.75	16,200	4,660	0.023	0.75	13,400	3,020	0.018	0.75	11,400	2,570	0.011	0.75	9,500	860	0.007	0.75
	25	10	16,800	5,300	0.018	0.75	14,400	4,140	0.018	0.75	11,900	2,680	0.014	0.75	10,200	2,290	0.009	0.75	8,500	760	0.005	0.75
1.75	10	10	18,000	7,060	0.061	0.87	15,500	5,560	0.061	0.87	12,700	3,560	0.049	0.87	10,900	3,050	0.031	0.87	9,100	1,020	0.018	0.87
	20	10	16,200	6,350	0.031	0.87	14,000	5,000	0.031	0.87	11,400	3,200	0.025	0.87	9,800	2,750	0.015	0.87	8,200	920	0.009	0.87
	30	10	14,400	5,650	0.020	0.87	12,400	4,450	0.020	0.87	10,200	2,850	0.016	0.87	8,700	2,440	0.010	0.87	7,300	820	0.006	0.87
	40	10	12,600	4,940	0.015	0.87	10,900	3,890	0.015	0.87	8,900	2,490	0.012	0.87	7,600	2,140	0.008	0.87	6,400	710	0.005	0.87
2	10	10	16,000	7,620	0.080	1.00	13,500	5,880	0.080	1.00	11,100	3,770	0.064	1.00	9,500	3,230	0.040	1.00	8,000	1,090	0.024	1.00
	15	10	16,000	7,620	0.053	1.00	13,500	5,880	0.053	1.00	11,100	3,770	0.043	1.00	9,500	3,230	0.027	1.00	8,000	1,090	0.016	1.00
	20	10	16,000	7,620	0.040	1.00	13,500	5,880	0.040	1.00	11,100	3,770	0.032	1.00	9,500	3,230	0.020	1.00	8,000	1,090	0.012	1.00
	25	10	14,400	6,860	0.032	1.00	12,200	5,290	0.032	1.00	10,000	3,390	0.026	1.00	8,600	2,910	0.016	1.00	7,200	980	0.010	1.00
	30	10	14,400	6,860	0.027	1.00	12,200	5,290	0.027	1.00	10,000	3,390	0.021	1.00	8,600	2,910	0.013	1.00	7,200	980	0.008	1.00
	35	10	12,800	6,100	0.023	1.00	10,800	4,700	0.023	1.00	8,900	3,020	0.018	1.00	7,600	2,580	0.011	1.00	6,400	870	0.007	1.00
	40	10	12,800	6,100	0.020	1.00	10,800	4,700	0.020	1.00	8,900	3,020	0.016	1.00	7,600	2,580	0.010	1.00	6,400	870	0.006	1.00
2.5	10	10	13,000	8,190	0.125	1.25	10,800	6,220	0.125	1.25	8,900	4,010	0.100	1.25	7,600	3,420	0.063	1.25	6,400	1,150	0.038	1.25
	20	10	13,000	8,190	0.063	1.25	10,800	6,220	0.063	1.25	8,900	4,010	0.050	1.25	7,600	3,420	0.031	1.25	6,400	1,150	0.019	1.25
	30	10	11,700	7,370	0.042	1.25	9,700	5,600	0.042	1.25	8,000	3,610	0.033	1.25	6,800	3,080	0.021	1.25	5,800	1,040	0.013	1.25
	40	10	10,400	6,550	0.031	1.25	8,600	4,980	0.031	1.25	7,100	3,210	0.025	1.25	6,100	2,740	0.016	1.25	5,100	920	0.009	1.25
	50	10	10,400	6,550	0.025	1.25	8,600	4,980	0.025	1.25	7,100	3,210	0.020	1.25	6,100	2,740	0.013	1.25	5,100	920	0.008	1.25
3	10	10	10,600	8,460	0.180	1.40	9,000	6,570	0.180	1.40	7,400	4,220	0.144	1.40	6,400	3,650	0.090	1.40	5,300	1,210	0.054	1.40
	20	10	10,600	8,460	0.090	1.40	9,000	6,570	0.090	1.40	7,400	4,220	0.072	1.40	6,400	3,650	0.045	1.40	5,300	1,210	0.027	1.40
	30	10	10,600	8,460	0.060	1.40	9,000	6,570	0.060	1.40	7,400	4,220	0.048	1.40	6,400	3,650	0.030	1.40	5,300	1,210	0.018	1.40
	40	10	9,540	7,610	0.045	1.40	8,100	5,910	0.045	1.40	6,700	3,800	0.036	1.40	5,800	3,290	0.023	1.40	4,800	1,090	0.014	1.40
	50	10	8,480	6,770	0.036	1.40	7,200	5,260	0.036	1.40	5,900	3,380	0.029	1.40	5,100	2,920	0.018	1.40	4,200	970	0.011	1.40

- 【注意】**
- ①できるだけ高剛性、高精度の機械をご使用ください。
 - ②被削材、加工形状に合わせて、適切なクーラントを使用してください。
 - ③この切削条件表は切削条件の目安を示すものです。実際の加工では加工形状、目的、使用機械等により条件を調整してください。
 - ④機械の回転数が足りない場合には、回転数と送り速度を同じ比率で下げてください。
 - ⑤彫り込み時の傾斜進入角度を1°として送り速度は上記の60~70%で設定ください。
 - ⑥最初から首下長の長い(L/D=15以上)工具をご使用の場合は、工具のバタつきを抑制し加工を安定させる為に、首下長の短いタイプやボール等で加工形状に合わせたガイドを加工しておくことを推奨いたします。

ETRP-TH

ペンシルネックタイプ
Straight Neck

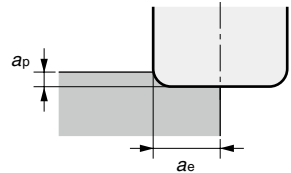

被削材 Work material		鋳鉄・炭素鋼・合金鋼 Cast irons, Carbon steels, Alloy steels (150~250HB) FC S50C SCM				工具鋼 Tool steels (25~35HRC) SUS304 SKD				プリハードン鋼 Pre-hardened steels (35~45HRC) NAK80 CENA1				焼入れ鋼 Hardened steels (45~55HRC) SKD61 SKT4				焼入れ鋼 Hardened steels (55~60HRC) SKD11 SKH51			
		回転数 min ⁻¹	送り速度 mm/min	ap mm	ae mm	回転数 min ⁻¹	送り速度 mm/min	ap mm	ae mm	回転数 min ⁻¹	送り速度 mm/min	ap mm	ae mm	回転数 min ⁻¹	送り速度 mm/min	ap mm	ae mm	回転数 min ⁻¹	送り速度 mm/min	ap mm	ae mm
外径 Tool dia. mm	首下長 Under neck length mm																				
1	5	32,000	5,820	0.060	0.50	27,100	4,510	0.060	0.50	22,300	2,900	0.048	0.50	19,100	2,480	0.030	0.50	15,900	830	0.018	0.50
	7.5	32,000	5,820	0.045	0.50	27,100	4,510	0.045	0.50	22,300	2,900	0.036	0.50	19,100	2,480	0.023	0.50	15,900	830	0.013	0.50
	10	32,000	5,820	0.030	0.50	27,100	4,510	0.030	0.50	22,300	2,900	0.024	0.50	19,100	2,480	0.015	0.50	15,900	830	0.009	0.50
	15	28,800	5,240	0.020	0.50	24,400	4,060	0.020	0.50	20,100	2,610	0.016	0.50	17,200	2,230	0.010	0.50	14,300	750	0.006	0.50
	20	28,800	5,240	0.015	0.50	24,400	4,060	0.015	0.50	20,100	2,610	0.012	0.50	17,200	2,230	0.008	0.50	14,300	750	0.005	0.50
	25	25,600	4,660	0.012	0.50	21,700	3,610	0.012	0.50	17,800	2,320	0.010	0.50	15,300	1,980	0.006	0.50	12,700	660	0.004	0.50
	30	24,000	4,370	0.010	0.50	20,300	3,380	0.010	0.50	16,700	2,180	0.008	0.50	14,300	1,860	0.005	0.50	11,900	620	0.003	0.50
	35	22,400	4,070	0.009	0.50	19,000	3,160	0.009	0.50	15,600	2,030	0.007	0.50	13,400	1,740	0.004	0.50	11,100	580	0.003	0.50
	40	20,800	3,780	0.008	0.50	17,600	2,930	0.008	0.50	14,500	1,890	0.006	0.50	12,400	1,610	0.004	0.50	10,300	540	0.002	0.50
	45	19,200	3,490	0.007	0.50	16,300	2,710	0.007	0.50	13,400	1,740	0.005	0.50	11,500	1,490	0.003	0.50	9,500	500	0.002	0.50
50	16,000	2,910	0.006	0.50	13,600	2,260	0.006	0.50	11,200	1,450	0.005	0.50	9,600	1,240	0.003	0.50	8,000	420	0.002	0.50	
1.25	10	25,000	6,130	0.047	0.62	21,600	4,840	0.047	0.62	17,800	3,120	0.038	0.62	15,300	2,680	0.023	0.62	12,700	890	0.014	0.62
	15	23,800	5,830	0.035	0.62	20,500	4,600	0.035	0.62	16,900	2,965	0.029	0.62	14,550	2,545	0.018	0.62	12,050	845	0.011	0.62
	20	22,500	5,520	0.023	0.62	19,400	4,360	0.023	0.62	16,000	2,810	0.019	0.62	13,800	2,410	0.012	0.62	11,400	800	0.007	0.62
	30	20,000	4,900	0.016	0.62	17,300	3,870	0.016	0.62	14,200	2,500	0.013	0.62	12,200	2,140	0.008	0.62	10,200	710	0.005	0.62
	40	17,500	4,290	0.012	0.62	15,100	3,390	0.012	0.62	12,500	2,180	0.009	0.62	10,700	1,880	0.006	0.62	8,900	620	0.004	0.62
	50	16,300	3,980	0.009	0.62	14,000	3,150	0.009	0.62	11,600	2,030	0.008	0.62	9,900	1,740	0.005	0.62	8,300	580	0.003	0.62
1.5	10	21,000	6,620	0.068	0.75	18,000	5,180	0.068	0.75	14,900	3,350	0.054	0.75	12,700	2,860	0.034	0.75	10,600	950	0.020	0.75
	15	21,000	6,620	0.051	0.75	18,000	5,180	0.051	0.75	14,900	3,350	0.041	0.75	12,700	2,860	0.026	0.75	10,600	950	0.015	0.75
	20	18,900	5,960	0.034	0.75	16,200	4,660	0.034	0.75	13,400	3,020	0.027	0.75	11,400	2,570	0.017	0.75	9,500	860	0.010	0.75
	30	18,900	5,960	0.023	0.75	16,200	4,660	0.023	0.75	13,400	3,020	0.018	0.75	11,400	2,570	0.011	0.75	9,500	860	0.007	0.75
	40	15,800	4,970	0.017	0.75	13,500	3,890	0.017	0.75	11,200	2,510	0.014	0.75	9,500	2,150	0.008	0.75	8,000	710	0.005	0.75
	50	14,700	4,630	0.014	0.75	12,600	3,630	0.014	0.75	10,400	2,350	0.011	0.75	8,900	2,000	0.007	0.75	7,400	670	0.004	0.75
1.75	10	18,000	7,060	0.092	0.87	15,500	5,560	0.092	0.87	12,700	3,560	0.074	0.87	10,900	3,050	0.046	0.87	9,100	1,020	0.028	0.87
	15	18,000	7,060	0.069	0.87	15,500	5,560	0.069	0.87	12,700	3,560	0.056	0.87	10,900	3,050	0.035	0.87	9,100	1,020	0.021	0.87
	20	16,200	6,350	0.046	0.87	14,000	5,000	0.046	0.87	11,400	3,200	0.037	0.87	9,800	2,750	0.023	0.87	8,200	920	0.014	0.87
	30	16,200	6,350	0.031	0.87	14,000	5,000	0.031	0.87	11,400	3,200	0.025	0.87	9,800	2,750	0.015	0.87	8,200	920	0.009	0.87
	40	14,400	5,650	0.023	0.87	12,400	4,450	0.023	0.87	10,200	2,850	0.018	0.87	8,700	2,440	0.011	0.87	7,300	820	0.007	0.87
	50	13,500	5,300	0.018	0.87	11,600	4,170	0.018	0.87	9,500	2,670	0.015	0.87	8,200	2,290	0.009	0.87	6,800	770	0.006	0.87
2	15	16,000	7,620	0.080	1.00	13,500	5,880	0.080	1.00	11,100	3,770	0.064	1.00	9,500	3,230	0.040	1.00	8,000	1,090	0.024	1.00
	20	16,000	7,620	0.060	1.00	13,500	5,880	0.060	1.00	11,100	3,770	0.048	1.00	9,500	3,230	0.030	1.00	8,000	1,090	0.018	1.00
	25	14,400	6,860	0.048	1.00	12,200	5,290	0.048	1.00	10,000	3,390	0.038	1.00	8,600	2,910	0.024	1.00	7,200	980	0.014	1.00
	30	14,400	6,860	0.040	1.00	12,200	5,290	0.040	1.00	10,000	3,390	0.032	1.00	8,600	2,910	0.020	1.00	7,200	980	0.012	1.00
	35	14,400	6,860	0.034	1.00	12,200	5,290	0.034	1.00	10,000	3,390	0.027	1.00	8,600	2,910	0.017	1.00	7,200	980	0.010	1.00
	40	14,400	6,860	0.030	1.00	12,200	5,290	0.030	1.00	10,000	3,390	0.024	1.00	8,600	2,910	0.015	1.00	7,200	980	0.009	1.00
	45	12,800	6,100	0.027	1.00	10,800	4,700	0.027	1.00	8,900	3,020	0.021	1.00	7,600	2,580	0.013	1.00	6,400	870	0.008	1.00
	50	12,800	6,100	0.024	1.00	10,800	4,700	0.024	1.00	8,900	3,020	0.019	1.00	7,600	2,580	0.012	1.00	6,400	870	0.007	1.00
	55	12,000	5,720	0.022	1.00	10,100	4,410	0.022	1.00	8,300	2,830	0.017	1.00	7,100	2,420	0.011	1.00	6,000	820	0.007	1.00
	60	12,000	5,720	0.020	1.00	10,100	4,410	0.020	1.00	8,300	2,830	0.016	1.00	7,100	2,420	0.010	1.00	6,000	820	0.006	1.00
2.5	20	13,000	8,190	0.094	1.25	10,800	6,220	0.094	1.25	8,900	4,010	0.075	1.25	7,600	3,420	0.047	1.25	6,400	1,150	0.028	1.25
	30	11,700	7,370	0.063	1.25	9,700	5,600	0.063	1.25	8,000	3,610	0.050	1.25	6,800	3,080	0.031	1.25	5,800	1,040	0.019	1.25
	40	11,700	7,370	0.047	1.25	9,700	5,600	0.047	1.25	8,000	3,610	0.038	1.25	6,800	3,080	0.023	1.25	5,800	1,040	0.014	1.25
	50	11,700	7,370	0.038	1.25	9,700	5,600	0.038	1.25	8,000	3,610	0.030	1.25	6,800	3,080	0.019	1.25	5,800	1,040	0.011	1.25
	60	10,400	6,550	0.031	1.25	8,600	4,980	0.031	1.25	7,100	3,210	0.025	1.25	6,100	2,740	0.016	1.25	5,100	920	0.009	1.25
3	20	10,600	8,460	0.135	1.40	9,000	6,570	0.135	1.40	7,400	4,220	0.108	1.40	6,400	3,650	0.068	1.40	5,300	1,210	0.041	1.40
	30	10,600	8,460	0.090	1.40	9,000	6,570	0.090	1.40	7,400	4,220	0.072	1.40	6,400	3,650	0.045	1.40	5,300	1,210	0.027	1.40
	40	9,500	7,610	0.068	1.40	8,100	5,910	0.068	1.40	6,700	3,800	0.054	1.40	5,800	3,290	0.034	1.40	4,800	1,090	0.020	1.40
	50	9,500	7,610	0.054	1.40	8,100	5,910	0.054	1.40	6,700	3,800	0.043	1.40	5,800	3,290	0.027	1.40	4,800	1,090	0.016	1.40
	60	9,500	7,610	0.045	1.40	8,100	5,910	0.045	1.40	6,700	3,800	0.036	1.40	5,800	3,290	0.023	1.40	4,800	1,090	0.014	1.40

- [Note]**
- ① Use a machine having as high rigidity and high accuracy as possible.
 - ② Use the appropriate coolant for the work material and machining shape.
 - ③ The cutting conditions shown in this table are intended as general criteria and should be adjusted according to the cutting shape, purpose, machine used, etc.
 - ④ If the rotation speed of the machine is insufficient, reduce the rotation speed and feed rate by the same ratios.
 - ⑤ For cutting in, set the ramp introduction angle to 1° and set the feed rate to 60 to 70% of the above values.
 - ⑥ In the case of using tools with L/D = 15 or more length from the first process, in order to suppress the chattering vibration of the tools and stabilize the cutting, it is recommended to make suitable guides by using short neck type or ball end mills.

Epoch Turbo Mill エポックターボミル

ビビリ振動を抑制。高効率加工用コーナRエンドミル。
Suppresses chattering. Corner R end mill for high-efficiency machining.

首下ストレート

Straight Neck

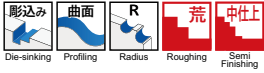

RE公差 ±0.015



(mm)

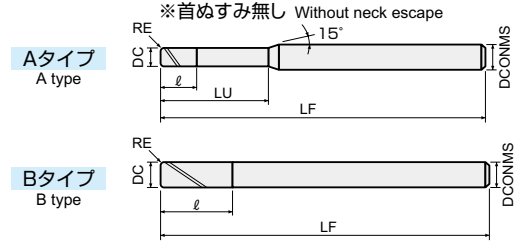

ETM4000-00-TH

超硬 TH 刃角 45° 切削条件表 A228
Carbide Helix angle Cutting Conditions

商品コード Item code	在庫 Stock	寸法 Size(mm)						首形状 Shape	希望小売価格 (円) Suggested retail price(¥)
		外径 Tool dia.	コーナ半径 Corner radius	首下長 Under neck length	刃長 Flute length	全長 Overall length	シャンク径 Shank dia.		
		DC	RE	LU	ℓ	LF	DCONMS		
ETM4020-05-TH	●	2	0.5	6	4	70	6	A	19,500
ETM4030-08-TH	●	3	0.8	9	6	70	6		19,280
ETM4040-10-TH	●	4	1.0	12	8	70	6		19,280
ETM4050-12-TH	●	5	1.2	15	10	70	6	B	20,430
ETM4060-15-TH	●	6	1.5	—	12	90	6		21,770
ETM4080-20-TH	●	8	2.0	—	16	100	8		28,050
ETM4100-20-TH	●	10	2.0	—	20	110	10		34,790
ETM4120-20-TH	●	12	2.0	—	24	120	12		46,350
ETM4160-30-TH	●	16	3.0	—	32	140	16		103,360
ETM4200-30-TH	●	20	3.0	—	40	150	20	144,280	

ロングネック

Long Neck

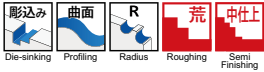

RE公差 ±0.015



(mm)

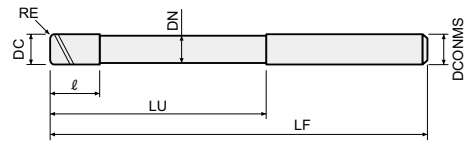

ETMLN4000-00-00-TH

超硬 TH 刃角 45° 切削条件表 A228
Carbide Helix angle Cutting Conditions

商品コード Item code	在庫 Stock	寸法 Size(mm)							希望小売価格 (円) Suggested retail price(¥)
		外径 Tool dia.	コーナ半径 Corner radius	首下長 Under neck length	刃長 Flute length	首径 Neck dia.	全長 Overall length	シャンク径 Shank dia.	
		DC	RE	LU	ℓ	DN	LF	DCONMS	
ETMLN4040-20-10-TH	●	4	1.0	20	6	3.8	70	4	16,500
ETMLN4040-28-10-TH	●			28	6	3.8	70	4	17,140
ETMLN4060-30-15-TH	●	6	1.5	30	9	5.7	75	6	19,310
ETMLN4060-42-15-TH	●			42	9	5.7	90	6	20,090
ETMLN4060-54-15-TH	●			54	9	5.7	100	6	20,990
ETMLN4080-40-20-TH	●	8	2.0	40	12	7.6	85	8	24,920
ETMLN4080-56-20-TH	●			56	12	7.6	100	8	26,600
ETMLN4080-72-20-TH	●			72	12	7.6	120	8	29,860
ETMLN4100-50-20-TH	●	10	2.0	50	15	9.5	100	10	29,970
ETMLN4100-70-20-TH	●			70	15	9.5	120	10	33,550
ETMLN4100-90-20-TH	●			90	15	9.5	140	10	36,810
ETMLN4120-60-20-TH	●	12	2.0	60	18	11.5	110	12	41,300
ETMLN4120-84-20-TH	●			84	18	11.5	135	12	45,680
ETMLN4120-108-20-TH	●			108	18	11.5	160	12	53,190
ETMLN4160-80-30-TH	●	16	3.0	80	24	15.5	140	16	94,320
ETMLN4160-120-30-TH	●			120	24	15.5	175	16	107,920

●印：標準在庫品です。 ●：Stocked items.

ペンシルネック Pencil Neck

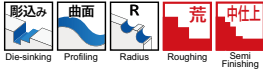

RE公差 ±0.015



(mm)

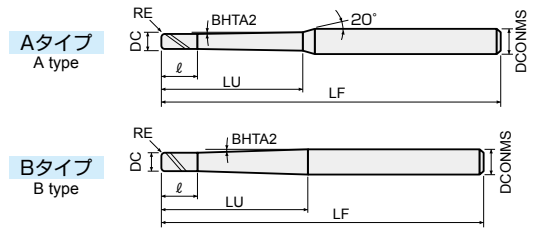

ETMP4-TH



商品コード Item code	在庫 Stock	寸法 Size(mm)							首形状 Shape	希望小売価格 (円) Suggested retail price(¥)
		外径 Tool dia.	コーナ半径 Corner radius	首下長 Under neck length	刃長 Flute length	首部テーパ半角 Neck angle	全長 Overall length	シャンク径 Shank dia.		
		DC	RE	LU	ℓ	BHTA2	LF	DCONMS		
ETMP4020-12-05-TH	●	2	0.5	12	3	1°	70	6	A	17,140
ETMP4020-16-05-TH	●			16	3	1°	70	6	A	17,470
ETMP4020-20-05-TH	●			20	3	1°	70	6	A	17,470
ETMP4030-18-08-TH	●	3	0.8	18	4.5	1°	80	6	A	16,610
ETMP4030-24-08-TH	●			24	4.5	1°	80	6	A	17,140
ETMP4030-30-08-TH	●			30	4.5	1°	80	6	A	17,570
ETMP4040-24-10-TH	●	4	1.0	24	6	1°	90	6	A	17,360
ETMP4040-32-10-TH	●			32	6	1°	90	6	A	17,790
ETMP4040-40-10-TH	●			40	6	1°	90	6	A	18,330
ETMP4050-30-12-TH	●	5	1.2	30	7.5	1°	90	6	A	18,970
ETMP4050-40-12-TH	●			40	7.5	1°	100	8	A	24,020
ETMP4050-50-12-TH	●			50	7.5	1°	110	8	A	25,810
ETMP4060-40-15-TH	●	6	1.5	40	9	1°	100	8	A	24,580
ETMP4060-55-15-TH	●			55	9	1°	110	8	A	26,600
ETMP4060-67-15-TH	●			67	9	1°	125	8	B	27,830
ETMP4080-55-20-TH	●	8	2.0	55	12	1°	110	10	A	30,860
ETMP4080-70-20-TH	●			70	12	1°	130	10	B	32,660
ETMP4080-90-20-TH	●			90	12	1°	145	12	A	40,400
ETMP4100-73-20-TH	●	10	2.0	73	15	1°	135	12	B	39,620
ETMP4100-95-20-TH	●			95	15	1°	150	16	A	78,780
ETMP4100-115-20-TH	●			115	15	1°	170	16	A	84,720
ETMP4120-80-20-TH	●	12	2.0	80	18	1°	135	16	A	83,480
ETMP4120-105-20-TH	●			105	18	1°	160	16	A	90,330
ETMP4160-105-30-TH	●	16	3.0	105	24	1°	160	20	A	137,250
ETMP4160-140-30-TH	●			140	24	1°	200	20	B	156,010

ETM-TH, ETMLN-TH, ETMP-THの対応被削材

Applicable work material of ETM-TH, ETMLN-TH, ETMP-TH

炭素鋼 合金鋼 Carbon steel Alloy steel	プリハー ド鋼 Pre-hardened steel ≤ 45HRC	高硬度 Hardened steel		ステン レス鋼 Stainless steel	チタン合金 耐熱合金 Titanium alloy Heat-resistant alloy	銅合金 Copper alloy	アルミ 合金 Aluminum alloy
		> 45HRC ≤ 55HRC	> 55HRC ≤ 65HRC				
◎	◎	◎	○	○	◎	○	○

再研磨対応外径範囲

Re-grinding compatibility range

商品コード Item code	外周 Outer dia. (mm)	エンド End (mm)
ETM-TH	× (N/A)	2 ~ 20
ETMLN-TH	× (N/A)	4 ~ 16
ETMP-TH	× (N/A)	2 ~ 16

【注意】首下長/外径が10DCを超える工具の再研磨可否については、弊社営業にお問い合わせください。
【Note】Contact our sales office regarding whether or not regrinding is possible for tools where under neck length/tool diameter more than 10DC

Epoch Turbo Mill エポックターボミル

超硬超高速ターボミル
ラジアンエポックミル

標準切削条件表 Recommended cutting conditions

ETM-TH ETMLN-TH ETMP-TH

首下ストレート Straight Neck ロングネック Long Neck ペンシルネック Pencil Neck

設備や用途に合わせて下記5種類の切削条件から使用条件を選択ください。まずは一般条件での使用を推奨します。

Select the conditions for use from the five types of cutting conditions below based on the equipment and application. It is recommended that the standard condition be used first.

		特長 Features
荒加工条件	一般条件 Standard condition	低速で使用でき汎用性のある条件です。 最も長寿命で安定した高能率加工が可能です。 General-purpose condition for low-speed use. Provides stable high-efficiency cutting with the longest tool life.
	高速条件 High speed condition	高性能な高速機で高送りに機械が追従できる場合に適用できる条件です。 高速回転により、送り速度がアップし、一般条件以上の高能率加工が可能です。 Enables ultra-high-efficiency cutting by enabling higher feed rates due to higher rotation speeds.
	高切り込み条件 High depth of cut condition	一般条件では送り速度が追従しないが、機械剛性は十分にある場合に適用できる条件です。送り速度が低い分、切り込みを大きく設定し、能率低下を最小限に抑えます。 Condition for machines which are not capable of the feed rates of the standard condition, but which have sufficient rigidity. The reduced feed rate is compensated for by setting a large cutting depth, minimizing reductions in work efficiency.
	低負荷条件 Low load condition	1刃送り量を小さくして切削負荷を小さくした条件です。 切削抵抗を低減できるので、剛性のない機械でも使用可能です。 Condition which reduces cutting load by reducing the per-flute feed rate. Since cutting resistance can be reduced, it enables use even on machines with low rigidity.
	仕上げ条件 Finish condition	仕上げ加工に用いる条件です。 最も高精度な仕上げ加工が可能です。(コーナ半径RE精度±0.015) Condition for finish cutting. High-accuracy finishing is possible. (Tolerance on RE is ±0.015mm.)

一般条件表 (低速・高送り)

Standard conditions (Low revolution, High feed)

被削材 Work material	鋳鉄・炭素鋼・合金鋼 Cast irons, Carbon steels, Alloy steels (150~250HB) FC, S50C, SCM			工具鋼 Tool steels (25~35HRC) SKD			プリハードン鋼 Pre-hardened steels (35~45HRC) NAK80, CENA1			焼入れ鋼 Hardened steels (45~55HRC) SKD61, SKT4			焼入れ鋼 Hardened steels (55~60HRC) SKD11, SKH51		
	切込み比率 Ratio to standard depth of cut	100%			100%			100%			70%			50%	
外径DC Tool dia.(mm)	回転数 n (min ⁻¹)	1刃送り fz (mm/t)	送り速度 vf (mm/min)	回転数 n (min ⁻¹)	1刃送り fz (mm/t)	送り速度 vf (mm/min)	回転数 n (min ⁻¹)	1刃送り fz (mm/t)	送り速度 vf (mm/min)	回転数 n (min ⁻¹)	1刃送り fz (mm/t)	送り速度 vf (mm/min)	回転数 n (min ⁻¹)	1刃送り fz (mm/t)	送り速度 vf (mm/min)
φ2	12,000	0.11	5,380	11,000	0.1	4,510	10,000	0.08	3,200	8,000	0.08	2,560	8,000	0.03	1,020
φ3	8,000	0.19	6,050	7,400	0.17	5,110	6,900	0.14	3,730	5,300	0.14	2,860	5,300	0.05	1,140
φ4	6,000	0.27	6,380	5,600	0.24	5,450	5,200	0.19	3,950	4,000	0.19	3,040	4,000	0.08	1,220
φ5	4,800	0.33	6,380	4,500	0.3	5,470	4,100	0.24	3,900	3,200	0.24	3,040	3,200	0.1	1,220
φ6	4,000	0.42	6,720	3,700	0.38	5,680	3,400	0.3	4,080	2,700	0.3	3,240	2,700	0.12	1,300
φ8	3,000	0.56	6,720	2,800	0.51	5,730	2,600	0.4	4,160	2,000	0.4	3,200	2,000	0.16	1,280
φ10	2,400	0.7	6,720	2,200	0.64	5,630	2,100	0.5	4,200	1,600	0.5	3,200	1,600	0.2	1,280
φ12	2,000	0.8	6,380	1,900	0.73	5,540	1,700	0.57	3,880	1,300	0.57	2,960	1,300	0.23	1,190
φ16	1,500	0.9	5,380	1,400	0.82	4,590	1,300	0.64	3,330	1,000	0.64	2,560	1,000	0.26	1,020
φ20	1,200	0.91	4,370	1,100	0.83	3,660	1,000	0.65	2,600	800	0.65	2,080	800	0.26	830

- 【注意】**
- ①できるだけ高剛性、高精度の機械をご使用ください。
 - ②被削材、加工形状に合わせて、適切なクーラントを使用してください。
 - ③この切削条件表は切削条件の目安を示すものです。実際の加工では加工形状、目的、使用機械等により条件を調整してください。
 - ④機械の回転数が足りない場合には、回転数と送り速度を同じ比率で下げてください。

- 【Note】**
- ① Use a highly rigid and accurate machine as possible.
 - ② Use the appropriate coolant for the work material and machining shape.
 - ③ These conditions are for general guidance; in actual machining conditions adjust the parameters according to your actual machine and work-piece conditions.
 - ④ If the rpm available is lower than that recommended please reduce the feed rate to the same ratio.

高速条件表 (高速・高送り)

High speed conditions (High revolution, High feed)

被削材 Work material	鋳鉄・炭素鋼・合金鋼 Cast irons, Carbon steels, Alloy steels (150~250HB) FC, S50C, SCM			工具鋼 Tool steels (25~35HRC) SKD			プリハードン鋼 Pre-hardened steels (35~45HRC) NAK80, CENA1			焼入れ鋼 Hardened steels (45~55HRC) SKD61,SKT4			焼入れ鋼 Hardened steels (55~60HRC) SKD11,SKH51		
	80%			80%			70%			60%			40%		
切込み比率 Ratio to standard depth of cut	80%			80%			70%			60%			40%		
外径DC Tool dia.(mm)	回転数 n (min ⁻¹)	1刃送り fz (mm/t)	送り速度 Vf (mm/min)	回転数 n (min ⁻¹)	1刃送り fz (mm/t)	送り速度 Vf (mm/min)	回転数 n (min ⁻¹)	1刃送り fz (mm/t)	送り速度 Vf (mm/min)	回転数 n (min ⁻¹)	1刃送り fz (mm/t)	送り速度 Vf (mm/min)	回転数 n (min ⁻¹)	1刃送り fz (mm/t)	送り速度 Vf (mm/min)
φ2	20,000	0.11	8,960	18,000	0.1	7,370	16,000	0.08	5,120	12,700	0.08	4,060	11,100	0.03	1,420
φ3	13,300	0.19	10,050	11,700	0.17	8,090	10,600	0.14	5,720	8,500	0.14	4,590	7,400	0.05	1,600
φ4	9,900	0.27	10,530	8,800	0.24	8,560	8,000	0.19	6,080	6,400	0.19	4,860	5,600	0.08	1,700
φ5	8,000	0.33	10,640	7,000	0.3	8,510	6,400	0.24	6,080	5,100	0.24	4,850	4,500	0.1	1,710
φ6	6,600	0.42	11,090	5,800	0.38	8,910	5,300	0.3	6,360	4,200	0.3	5,040	3,700	0.12	1,780
φ8	5,000	0.56	11,200	4,400	0.51	9,010	4,000	0.4	6,400	3,200	0.4	5,120	2,800	0.16	1,790
φ10	4,000	0.7	11,200	3,500	0.64	8,960	3,200	0.5	6,400	2,500	0.5	5,000	2,200	0.2	1,760
φ12	3,300	0.8	10,530	2,900	0.73	8,460	2,700	0.57	6,160	2,100	0.57	4,790	1,900	0.23	1,730
φ16	2,500	0.9	8,960	2,200	0.82	7,210	2,000	0.64	5,120	1,600	0.64	4,100	1,400	0.26	1,430
φ20	2,000	0.91	7,280	1,800	0.83	5,990	1,600	0.65	4,160	1,300	0.65	3,380	1,100	0.26	1,140

高切り込み条件表 (低速・高切り込み)

High depth of cut conditions (Low revolution, High depth of cut)

被削材 Work material	鋳鉄・炭素鋼・合金鋼 Cast irons, Carbon steels, Alloy steels (150~250HB) FC, S50C, SCM			工具鋼 Tool steels (25~35HRC) SKD			プリハードン鋼 Pre-hardened steels (35~45HRC) NAK80, CENA1			焼入れ鋼 Hardened steels (45~55HRC) SKD61,SKT4			焼入れ鋼 Hardened steels (55~60HRC) SKD11,SKH51		
	200%			180%			160%			120%			70%		
切込み比率 Ratio to standard depth of cut	200%			180%			160%			120%			70%		
外径DC Tool dia.(mm)	回転数 n (min ⁻¹)	1刃送り fz (mm/t)	送り速度 Vf (mm/min)	回転数 n (min ⁻¹)	1刃送り fz (mm/t)	送り速度 Vf (mm/min)	回転数 n (min ⁻¹)	1刃送り fz (mm/t)	送り速度 Vf (mm/min)	回転数 n (min ⁻¹)	1刃送り fz (mm/t)	送り速度 Vf (mm/min)	回転数 n (min ⁻¹)	1刃送り fz (mm/t)	送り速度 Vf (mm/min)
φ2	12,000	0.05	2,460	11,000	0.05	2,110	10,000	0.04	1,600	8,000	0.04	1,280	8,000	0.02	610
φ3	8,000	0.09	2,760	7,400	0.08	2,400	6,900	0.07	1,860	5,300	0.07	1,430	5,300	0.03	690
φ4	6,000	0.12	2,920	5,600	0.11	2,550	5,200	0.1	1,980	4,000	0.1	1,520	4,000	0.05	730
φ5	4,800	0.15	2,920	4,500	0.14	2,570	4,100	0.12	1,950	3,200	0.12	1,520	3,200	0.06	730
φ6	4,000	0.19	3,070	3,700	0.18	2,660	3,400	0.15	2,040	2,700	0.15	1,620	2,700	0.07	780
φ8	3,000	0.26	3,070	2,800	0.24	2,690	2,600	0.2	2,080	2,000	0.2	1,600	2,000	0.1	770
φ10	2,400	0.32	3,070	2,200	0.3	2,640	2,100	0.25	2,100	1,600	0.25	1,600	1,600	0.12	770
φ12	2,000	0.36	2,920	1,900	0.34	2,600	1,700	0.29	1,940	1,300	0.29	1,480	1,300	0.14	710
φ16	1,500	0.41	2,460	1,400	0.38	2,150	1,300	0.32	1,660	1,000	0.32	1,280	1,000	0.15	610
φ20	1,200	0.42	2,000	1,100	0.39	1,720	1,000	0.33	1,300	800	0.33	1,040	800	0.16	500

- [注意]**
- ①できるだけ高剛性、高精度の機械をご使用ください。
 - ②被削材、加工形状に合わせて、適切なクーラントを使用してください。
 - ③この切削条件表は切削条件の目安を示すものです。実際の加工では加工形状、目的、使用機械等により条件を調整してください。
 - ④機械の回転数が足りない場合には、回転数と送り速度を同じ比率で下げてください。

- [Note]**
- ① Use a highly rigid and accurate machine as possible.
 - ② Use the appropriate coolant for the work material and machining shape.
 - ③ These conditions are for general guidance; in actual machining conditions adjust the parameters according to your actual machine and work-piece conditions.
 - ④ If the rpm available is lower than that recommended please reduce the feed rate to the same ratio.

Epoch Turbo Mill エポックターボミル

超硬合金ターボミル

低負荷条件表 (中速・高送り)

Low load conditions (Medium revolution, high feed)

被削材 Work material	鋳鉄・炭素鋼・合金鋼 Cast irons, Carbon steels, Alloy steels (150~250HB) FC, S50C, SCM			工具鋼 Tool steels (25~35HRC) SKD			プリハードン鋼 Pre-hardened steels (35~45HRC) NAK80, CENA 1			焼入れ鋼 Hardened steels (45~55HRC) SKD61, SKT4			焼入れ鋼 Hardened steels (55~60HRC) SKD11, SKH51		
	100%			100%			100%			70%			50%		
切込み比率 Ratio to standard depth of cut	100%			100%			100%			70%			50%		
外径DC Tool dia. (mm)	回転数 n (min ⁻¹)	1刃送り fz (mm/t)	送り速度 vf (mm/min)	回転数 n (min ⁻¹)	1刃送り fz (mm/t)	送り速度 vf (mm/min)	回転数 n (min ⁻¹)	1刃送り fz (mm/t)	送り速度 vf (mm/min)	回転数 n (min ⁻¹)	1刃送り fz (mm/t)	送り速度 vf (mm/min)	回転数 n (min ⁻¹)	1刃送り fz (mm/t)	送り速度 vf (mm/min)
φ2	15,000	0.09	5,180	14,000	0.08	4,300	14,000	0.06	3,400	10,300	0.06	2,310	9,500	0.02	910
φ3	10,100	0.15	5,890	9,500	0.13	4,920	9,000	0.1	3,690	6,900	0.09	2,610	6,400	0.04	1,040
φ4	7,600	0.21	6,240	7,200	0.18	5,250	6,800	0.14	3,930	5,200	0.13	2,770	4,800	0.06	1,090
φ5	6,000	0.26	6,160	5,700	0.23	5,200	5,400	0.18	3,900	4,100	0.17	2,730	3,800	0.07	1,080
φ6	5,000	0.32	6,480	4,800	0.29	5,530	4,500	0.23	4,100	3,400	0.21	2,860	3,200	0.09	1,150
φ8	3,800	0.43	6,570	3,600	0.38	5,530	3,400	0.3	4,130	2,600	0.28	2,910	2,400	0.12	1,150
φ10	3,000	0.54	6,480	2,900	0.48	5,570	2,700	0.38	4,100	2,100	0.35	2,940	1,900	0.15	1,140
φ12	2,500	0.62	6,160	2,400	0.55	5,250	2,300	0.43	3,990	1,700	0.4	2,710	1,600	0.17	1,090
φ16	1,900	0.69	5,250	1,800	0.61	4,420	1,700	0.49	3,310	1,300	0.45	2,330	1,200	0.19	920
φ20	1,500	0.7	4,210	1,400	0.62	3,490	1,400	0.49	2,770	1,000	0.46	1,820	1,000	0.2	780

【注意】

- ①できるだけ高剛性、高精度の機械をご使用ください。
- ②被削材、加工形状に合わせて、適切なクーラントを使用してください。
- ③この切削条件表は切削条件の目安を示すものです。実際の加工では加工形状、目的、使用機械等により条件を調整してください。
- ④機械の回転数が足りない場合には、回転数と送り速度を同じ比率で下げてください。

【Note】

- ① Use a highly rigid and accurate machine as possible.
- ② Use the appropriate coolant for the work material and machining shape.
- ③ These conditions are for general guidance; in actual machining conditions adjust the parameters according to your actual machine and work-piece conditions.
- ④ If the rpm available is lower than that recommended please reduce the feed rate to the same ratio.

切り込み量と工具突き出し比率 Relation between the depth of cut and overhang.

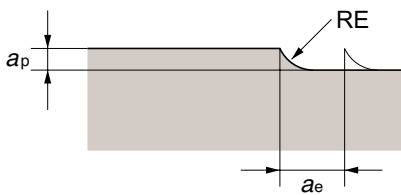

a_e : 工具先端フラット部の半径 = (外径DC/2) - コーナ半径RE
Half of flat length on bottom edge Tool dia. Corner radius

a_p : 下表参照 Below table

工具突き出し比率 Overhang	a_p : Z方向切り込み mm Z pick	工具突き出し比率 Overhang	a_p : Z方向切り込み mm Z pick
5DC以下 or less	$0.3 \times RE \times$ 切り込み比率 Cutting depth ratio	8DC	$0.23 \times RE \times$ 切り込み比率 Cutting depth ratio
6DC	$0.27 \times RE \times$ 切り込み比率 Cutting depth ratio	9DC	$0.19 \times RE \times$ 切り込み比率 Cutting depth ratio
7DC	$0.25 \times RE \times$ 切り込み比率 Cutting depth ratio	10DC	$0.15 \times RE \times$ 切り込み比率 Cutting depth ratio

- ① 上表の6DC以上は、ペンシルネックタイプでの切り込みを示しています。6DC以上のストレートタイプ・ロングネックタイプの場合、Z方向の切り込み量を上記より10%程度小さく設定してください。
- ② 等高線・ダウンカットでご使用ください。Z方向は傾斜切り込み（傾斜角1°）とし、この際の送り速度は70%~60%に下げてください。
- ③ コーナ減速を設定していただくことを推奨いたします。減速距離は使用工具の約半径分、送り速度は60%~50%に下げてください。

- ① Feed rates for pencil-neck types are shown for 6DC and higher in the above table. For straight type and long-neck type of 6DC or higher, cutting depth in the Z direction should be set about 10% lower than the above values.
- ② Use for cutting contour lines or down cutting. In Z direction, cut at an incline (incline angle: 1°) and reduce feed rate to between 60% and 70%.
- ③ It is recommended that speed reduction for corners be set. The speed reduction distance should be approximately 1/2 the diameter of the tool being used, and the feed rate should be reduced to between 50% and 60%.

仕上げ条件

Finish condition

被削材 Work material	鋳鉄・炭素鋼・合金鋼 Cast irons, Carbon steels, Alloy steels (150~250HB) FC, S50C, SCM			工具鋼 Tool steels (25~35HRC) SKD			プリハードン鋼 Pre-hardened steels (35~45HRC) NAK80, CENA1			焼入れ鋼 Hardened steels (45~55HRC) SKD61,SKT4			焼入れ鋼 Hardened steels (55~60HRC) SKD11,SKH51		
	外径DC Tool dia.(mm)	回転数 n (min^{-1})	1刃送り f_z (mm/t)	送り速度 v_f (mm/min)	回転数 n (min^{-1})	1刃送り f_z (mm/t)	送り速度 v_f (mm/min)	回転数 n (min^{-1})	1刃送り f_z (mm/t)	送り速度 v_f (mm/min)	回転数 n (min^{-1})	1刃送り f_z (mm/t)	送り速度 v_f (mm/min)	回転数 n (min^{-1})	1刃送り f_z (mm/t)
$\phi 2$	29,000	0.02	1,860	24,000	0.01	1,230	19,000	0.01	730	14,300	0.01	460	11,100	0.01	280
$\phi 3$	19,100	0.03	2,060	15,900	0.02	1,370	12,700	0.02	820	9,500	0.01	510	7,400	0.01	320
$\phi 4$	14,300	0.04	2,170	11,900	0.03	1,450	9,500	0.02	870	7,200	0.02	550	5,600	0.02	340
$\phi 5$	11,500	0.05	2,190	9,500	0.04	1,440	7,600	0.03	870	5,700	0.02	540	4,500	0.02	340
$\phi 6$	9,500	0.06	2,280	8,000	0.05	1,540	6,400	0.04	920	4,800	0.03	580	3,700	0.02	360
$\phi 8$	7,200	0.08	2,300	6,000	0.06	1,540	4,800	0.05	920	3,600	0.04	580	2,800	0.03	360
$\phi 10$	5,700	0.1	2,280	4,800	0.08	1,540	3,800	0.06	910	2,900	0.05	580	2,200	0.04	350
$\phi 12$	4,800	0.11	2,190	4,000	0.09	1,460	3,200	0.07	880	2,400	0.06	550	1,900	0.05	350
$\phi 16$	3,600	0.13	1,840	3,000	0.1	1,230	2,400	0.08	740	1,800	0.06	460	1,400	0.05	290
$\phi 20$	2,900	0.13	1,510	2,400	0.1	1,000	1,900	0.08	590	1,400	0.07	360	1,100	0.05	230

- 【注意】**
- ①できるだけ高剛性、高精度の機械をご使用ください。
 - ②下図の切り込み量は目安です。実際にはカスプハイトを参考に選定してください。
 - ③被削材、加工形状に合わせて、適切なクーラントを使用してください。
 - ④この切削条件表は切削条件の目安を示すものです。実際の加工では加工形状、目的、使用機械等により条件を調整してください。
 - ⑤機械の回転数が足りない場合には、回転数と送り速度を同じ比率で下げてください。

- 【Note】**
- ① Use a highly rigid and accurate machine as possible.
 - ② The below cutting depths are general criteria. In actual use, the cutting depth should be selected by referring to the cusp height.
 - ③ Use the appropriate coolant for the work material and machining shape.
 - ④ These conditions are for general guidance; in actual machining conditions adjust the parameters according to your actual machine and work-piece conditions.
 - ⑤ If the rpm available is lower than that recommended please reduce the feed rate to the same ratio.

切り込み量 Depth of cut

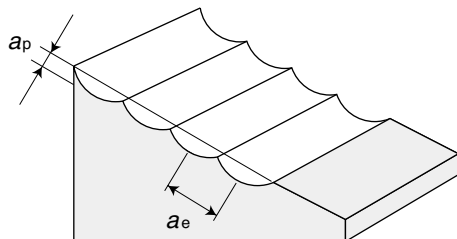

a_p : 仕上げ代
 $a_p = 0.05\text{mm} \sim 0.1\text{mm}$
 a_e : ピックフィード
 $a_e = 0.1RE$

Epoch G Turbo エポックGターボ

2枚刃

2Flutes



外径公差
Dia. tolerance 0~-0.03

RE公差
RE tolerance ±0.01

h5

2枚刃
2Flutes



低抵抗刃形の採用により高硬度材の高効率加工が可能。汎用性重視。
Employs low-resistance flute shape to enable high-efficiency machining of high-hardness materials. Focus on general-purpose characteristics.

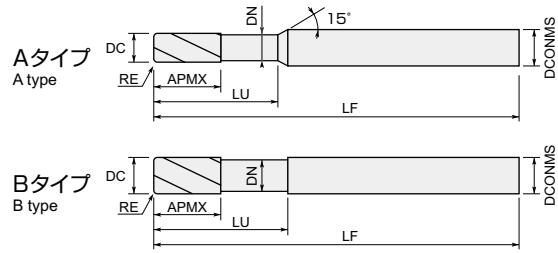

超硬 Carbide ATH 切削条件表 A233 Cutting Conditions

HGOF2-TH

商品コード Item code	在庫 Stock	寸法 Size (mm)							刃数 No. of flutes	形状 Shape	希望小売価格 (円) Suggested retail price(¥)
		外径 Tool dia.	コーナ半径 Corner radius	刃長 Flute length	首下長 Under neck length	首径 Neck dia.	全長 Overall length	シャンク径 Shank dia.			
		DC	RE	APMX	LU	DN	LF	DCONMS			
HGOF2020-05-TH	●	2	0.5	3	6	1.9	60	6	2	A	13,610
HGOF2030-08-TH	●	3	0.8	4.5	9	2.9	60	6	2	A	13,390
HGOF2040-10-TH	●	4	1	6	12	3.8	60	6	2	A	13,390
HGOF2050-12-TH	●	5	1.2	7.5	15	4.7	60	6	2	A	14,260
HGOF2060-15-TH	●	6	1.5	9	18	5.7	60	6	2	B	15,150
HGOF2080-20-TH	●	8	2	12	24	7.6	75	8	2	B	19,530
HGOF2100-20-TH	●	10	2	15	30	9.5	80	10	2	B	24,250
HGOF2120-20-TH	●	12	2	18	36	11.5	100	12	2	B	32,210

4枚刃

4Flutes



外径公差
Dia. tolerance 0~-0.03

RE公差
RE tolerance ±0.01

h5

4枚刃
4Flutes



低抵抗刃形の採用により高硬度材の高効率加工が可能。
Employs low-resistance flute shape to enable high-efficiency machining of high-hardness materials.

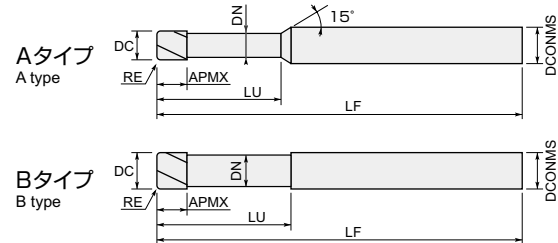

超硬 Carbide ATH 切削条件表 A234 Cutting Conditions

HGOF4-TH

商品コード Item code	在庫 Stock	寸法 Size (mm)							刃数 No. of flutes	形状 Shape	希望小売価格 (円) Suggested retail price(¥)
		外径 Tool dia.	コーナ半径 Corner radius	刃長 Flute length	首下長 Under neck length	首径 Neck dia.	全長 Overall length	シャンク径 Shank dia.			
		DC	RE	APMX	LU	DN	LF	DCONMS			
HGOF4020-05-TH	●	2	0.5	1	6	1.9	60	6	4	A	15,650
HGOF4030-08-TH	●	3	0.8	1.5	9	2.9	60	6	4	A	15,430
HGOF4040-10-TH	●	4	1	2	12	3.8	60	6	4	A	15,430
HGOF4050-12-TH	●	5	1.2	2.5	15	4.7	60	6	4	A	16,390
HGOF4060-15-TH	●	6	1.5	3	18	5.7	60	6	4	B	17,400
HGOF4080-20-TH	●	8	2	4	24	7.6	75	8	4	B	22,440
HGOF4100-20-TH	●	10	2	5	30	9.5	80	10	4	B	27,830
HGOF4120-20-TH	●	12	2	6	36	11.5	100	12	4	B	37,030

対応被削材 Applicable work material

刃数 No. of flutes	炭素鋼 合金鋼 Carbon steel Alloy steel	プリハード ド鋼 Pre-hardened steel ≤ 45HRC	高硬度 Hardened steel			ステン レス鋼 Stainless steel	チタン 合金 耐熱合金 Titanium alloy Heat-resistant alloy	銅合金 Copper alloy	アルミ 合金 Aluminum alloy
			> 45HRC ≤ 55HRC	> 55HRC ≤ 65HRC	> 65HRC				
2	○	○	○	○	○	○	○	○	
4	○	○	○	○	○	○	○	○	

○ : 標準在庫品です。 ● : Stocked items.

再研磨対応外径範囲 Re-grinding compatibility range

商品コード Item code	外周 Outer dia. (mm)	エンド End (mm)
HGOF2-TH	6 ~ 12	2 ~ 12
HGOF4-TH	× (N/A)	2 ~ 12

標準切削条件表 Recommended cutting conditions

HGOF2-TH

2枚刃
2Flutes

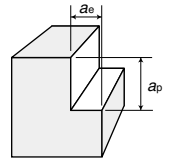

〈側面切削〉 Side milling

被削材 Work material	鋳鉄・炭素鋼・合金鋼 Cast irons, Carbon steels, Alloy steels (200~250HB) FC, S50C		合金鋼 Alloy steels (25~35HRC) SKD,SCM		ステンレス鋼 Stainless steels (25~35HRC) SUS304		プリハードン鋼 Pre-hardened steels (35~45HRC) CENA1, NAK80		焼入れ鋼 Hardened steels (45~55HRC) SKD61,SKT4	
	切込み Depth of cut (mm) $a_p \leq 1.5DC$ $a_e = 0.15DC$		切込み Depth of cut (mm) $a_p \leq 1.5DC$ $a_e = 0.1DC$		切込み Depth of cut (mm) $a_p \leq 1.5DC$ $a_e = 0.1DC$		切込み Depth of cut (mm) $a_p \leq 1.5DC$ $a_e = 0.07DC$		切込み Depth of cut (mm) $a_p \leq 1.5DC$ $a_e = 0.05DC$	
外径 DC Tool dia.(mm)	回転数 n (min^{-1})	送り速度 V_f (mm/min)	回転数 n (min^{-1})	送り速度 V_f (mm/min)	回転数 n (min^{-1})	送り速度 V_f (mm/min)	回転数 n (min^{-1})	送り速度 V_f (mm/min)	回転数 n (min^{-1})	送り速度 V_f (mm/min)
φ2	14,300	385	14,300	345	10,000	225	12,700	280	11,100	200
φ3	9,600	430	9,600	385	6,720	250	8,500	305	7,400	230
φ4	7,200	460	7,200	415	5,040	270	6,400	330	5,600	250
φ5	5,700	500	5,700	450	4,000	295	5,100	360	4,500	275
φ6	4,800	540	4,800	485	3,360	315	4,200	375	3,700	290
φ8	3,600	575	3,600	520	2,520	340	3,200	410	2,800	315
φ10	2,900	535	2,900	480	2,030	315	2,500	370	2,200	285
φ12	2,400	500	2,400	450	1,680	295	2,100	350	1,900	275

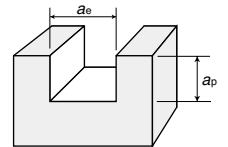

〈溝切削〉 Slotting

被削材 Work material	鋳鉄・炭素鋼・合金鋼 Cast irons, Carbon steels, Alloy steels (200~250HB) FC, S50C		合金鋼 Alloy steels (25~35HRC) SKD,SCM		ステンレス鋼 Stainless steels (25~35HRC) SUS304		プリハードン鋼 Pre-hardened steels (35~45HRC) CENA1, NAK80		焼入れ鋼 Hardened steels (45~55HRC) SKD61,SKT4	
	切込み Depth of cut (mm) $a_p \leq 1DC$ $a_e = 1DC$		切込み Depth of cut (mm) $a_p \leq 0.5DC$ $a_e = 1DC$		切込み Depth of cut (mm) $a_p \leq 0.5DC$ $a_e = 1DC$		切込み Depth of cut (mm) $a_p \leq 0.5DC$ $a_e = 1DC$		切込み Depth of cut (mm) $a_p \leq 0.2DC$ $a_e = 1DC$	
外径 DC Tool dia.(mm)	回転数 n (min^{-1})	送り速度 V_f (mm/min)	回転数 n (min^{-1})	送り速度 V_f (mm/min)	回転数 n (min^{-1})	送り速度 V_f (mm/min)	回転数 n (min^{-1})	送り速度 V_f (mm/min)	回転数 n (min^{-1})	送り速度 V_f (mm/min)
φ2	9,550	168	9,550	136	6,685	90	8,750	112	8,000	76
φ3	6,400	196	6,400	176	4,480	115	5,800	144	5,300	96
φ4	4,800	220	4,800	200	3,360	130	4,400	164	4,000	112
φ5	3,800	232	3,800	212	2,660	138	3,500	172	3,200	116
φ6	3,200	244	3,200	220	2,240	145	2,900	180	2,700	124
φ8	2,400	260	2,400	236	1,680	155	2,200	192	2,000	132
φ10	1,900	232	1,900	208	1,330	135	1,800	176	1,600	116
φ12	1,600	216	1,600	192	1,120	125	1,500	160	1,300	104

- 【注意】**
- ①できるだけ高剛性、高精度の機械をご使用ください。
 - ②被削材、加工形状に合わせて、適切なクーラントを使用してください。
 - ③この切削条件表は切削条件の目安を示すものです。実際の加工では加工形状、目的、使用機械等により条件を調整してください。
 - ④機械の回転数が足りない場合には、回転数と送り速度を同じ比率で下げてください。
 - ⑤更に能率を上げる場合は、**回転数と送り速度を同じ比率にて上げてください。**

- 【Note】**
- ① Use a highly rigid and accurate machine as possible.
 - ② Use the appropriate coolant for the work material and machining shape.
 - ③ These conditions are for general guidance; in actual machining conditions adjust the parameters according to your actual machine and work-piece conditions.
 - ④ If the rpm available is lower than that recommended please reduce the feed rate to the same ratio.
 - ⑤ To increase efficiency even further, **increase the rotation speed and the feed rate by the same ratio.**

Epoch G Turbo エポックGターボ

2枚刃は送り速度のみを50%を目安に下げてください。また2枚刃は55HRC以上の被削材には推奨しておりません

When using the 2-flute model, set feed rate only to 50% of the value below as a general criteria. Further, it is not recommended to use the 2-flute model for cutting materials with hardness of 55HRC.

HGOF2-TH

2枚刃
2Flutes

HGOF4-TH

4枚刃
4Flutes

〈等高線加工〉 Contouring

被削材 Work material	鋳鉄・炭素鋼・合金鋼 Cast Irons, Carbon steels, Alloy steels (150~250HB) FC, S50C, SCM				工具鋼 Tool steels (25~35HRC) SUS304, SKD				プリハードン鋼 Pre-hardened steels (35~45HRC) NAK80, CENA1				焼入れ鋼 Hardened steels (45~55HRC) SKD61, SKT4				焼入れ鋼 Hardened steels (55~60HRC) SKD11, SKH51			
	外径 DC Tool dia.(mm)	回転数 n (min^{-1})	送り速度 V_f (mm/min)	a_p (mm)	a_e (mm)	回転数 n (min^{-1})	送り速度 V_f (mm/min)	a_p (mm)	a_e (mm)	回転数 n (min^{-1})	送り速度 V_f (mm/min)	a_p (mm)	a_e (mm)	回転数 n (min^{-1})	送り速度 V_f (mm/min)	a_p (mm)	a_e (mm)	回転数 n (min^{-1})	送り速度 V_f (mm/min)	a_p (mm)
φ2	12,000	5,380	0.12	0.5	11,000	4,510	0.12	0.5	10,000	3,200	0.12	0.5	8,000	2,560	0.08	0.5	8,000	1,275	0.06	0.5
φ3	8,000	6,050	0.19	0.7	7,400	5,110	0.19	0.7	6,900	3,730	0.19	0.7	5,300	2,860	0.13	0.7	5,300	1,425	0.10	0.7
φ4	6,000	6,380	0.24	1	5,600	5,450	0.24	1	5,200	3,950	0.24	1	4,000	3,040	0.17	1	4,000	1,525	0.12	1
φ5	4,800	6,380	0.29	1.3	4,500	5,470	0.29	1.3	4,100	3,900	0.29	1.3	3,200	3,040	0.20	1.3	3,200	1,525	0.14	1.3
φ6	4,000	6,720	0.36	1.5	3,700	5,680	0.36	1.5	3,400	4,080	0.36	1.5	2,700	3,240	0.25	1.5	2,700	1,625	0.18	1.5
φ8	3,000	6,720	0.48	2	2,800	5,730	0.48	2	2,600	4,160	0.48	2	2,000	3,200	0.34	2	2,000	1,600	0.24	2
φ10	2,400	6,720	0.48	3	2,200	5,630	0.48	3	2,100	4,200	0.48	3	1,600	3,200	0.34	3	1,600	1,600	0.24	3
φ12	2,000	6,380	0.48	4	1,900	5,540	0.48	4	1,700	3,880	0.48	4	1,300	2,960	0.34	4	1,300	1,488	0.24	4

- 【注意】**
- ①できるだけ高剛性、高精度の機械をご使用ください。
 - ②被削材、加工形状に合わせて、適切なクーラントを使用してください。
 - ③この切削条件表は切削条件の目安を示すものです。実際の加工では加工形状、目的、使用機械等により条件を調整してください。
 - ④機械の回転数が足りない場合には、回転数と送り速度を同じ比率で下げてください。

- 【Note】**
- ① Use a highly rigid and accurate machine as possible.
 - ② Use the appropriate coolant for the work material and machining shape.
 - ③ These conditions are for general guidance; in actual machining conditions adjust the parameters according to your actual machine and work-piece conditions.
 - ④ If the rpm available is lower than that recommended please reduce the feed rate to the same ratio.

Epoch SUS Multi エポックSUSマルチ

レギュラー刃長・ラジアスタイプ Regular, Radius type

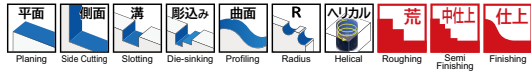

外径公差 Dia. tolerance
 $\phi 1 \sim \phi 6 : 0 \sim -0.015$
 $\phi 7 \sim \phi 20 : 0 \sim -0.02$

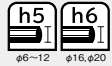

(mm)

4枚刃
4 Flutes



ステンレス鋼、炭素鋼、合金鋼等の荒～仕上げ加工までマルチに対応。
Multi-purpose for roughing to finishing of stainless steel, carbon steel, alloy steel, etc.

スクエアはA311頁を参照してください
Please refer to page A311 for Square

Aタイプ
A type

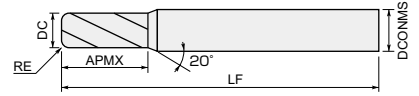

Bタイプ
B type

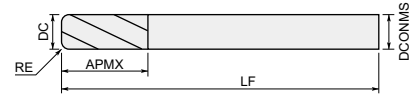

EPSM4-R-PN

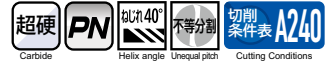

商品コード Item code	在庫 Stock	寸法 Size(mm)					刃数 No. of flutes	形状 Shape	希望小売価格(円) Suggested retail price(¥)
		外径 Tool dia.	コーナ半径 Coner radius	刃長 Flute length	全長 Overall length	シャンク径 Shank dia.			
		DC	RE	APMX	LF	DCONMS			
EPSM4010-R0.1-PN	●	1	0.1	2.5	56	6	4	A	10,830
EPSM4020-R0.1-PN	●	2	0.1	5	56	6	4	A	10,830
EPSM4020-R0.2-PN	●		0.2	5	56	6	4	A	10,830
EPSM4030-R0.2-PN	●	3	0.2	7.5	56	6	4	A	10,830
EPSM4030-R0.5-PN	●		0.5	7.5	56	6	4	A	10,830
EPSM4040-R0.2-PN	●	4	0.2	10	56	6	4	A	11,150
EPSM4040-R0.5-PN	●		0.5	10	56	6	4	A	11,150
EPSM4040-R1.0-PN	●		1	10	56	6	4	A	11,150
EPSM4050-R0.2-PN	●	5	0.2	12.5	56	6	4	A	12,350
EPSM4050-R0.5-PN	●		0.5	12.5	56	6	4	A	12,350
EPSM4050-R1.0-PN	●		1	12.5	56	6	4	A	12,350
EPSM4060-R0.3-PN	●	6	0.3	15	56	6	4	B	13,140
EPSM4060-R0.5-PN	●		0.5	15	56	6	4	B	13,140
EPSM4060-R1.0-PN	●		1	15	56	6	4	B	13,140
EPSM4060-R1.5-PN	●		1.5	15	56	6	4	B	13,140
EPSM4070-R0.3-PN	●	7	0.3	17.5	63	8	4	A	15,380
EPSM4070-R0.5-PN	●		0.5	17.5	63	8	4	A	15,380
EPSM4070-R1.0-PN	●		1	17.5	63	8	4	A	15,380
EPSM4080-R0.3-PN	●	8	0.3	20	63	8	4	B	15,380
EPSM4080-R0.5-PN	●		0.5	20	63	8	4	B	15,380
EPSM4080-R1.0-PN	●		1	20	63	8	4	B	15,380
EPSM4080-R1.5-PN	●		1.5	20	63	8	4	B	15,380
EPSM4080-R2.0-PN	●		2	20	63	8	4	B	15,380
EPSM4090-R0.3-PN	●	9	0.3	22.5	74	10	4	A	19,870
EPSM4090-R0.5-PN	●		0.5	22.5	74	10	4	A	19,870
EPSM4090-R1.0-PN	●		1	22.5	74	10	4	A	19,870
EPSM4100-R0.3-PN	●	10	0.3	25	74	10	4	B	19,870
EPSM4100-R0.5-PN	●		0.5	25	74	10	4	B	19,870
EPSM4100-R1.0-PN	●		1	25	74	10	4	B	19,870
EPSM4100-R1.5-PN	●		1.5	25	74	10	4	B	19,870
EPSM4100-R2.0-PN	●		2	25	74	10	4	B	19,870
EPSM4110-R0.3-PN	●	11	0.3	27.5	86	12	4	A	23,910
EPSM4110-R0.5-PN	●		0.5	27.5	86	12	4	A	23,910
EPSM4110-R1.0-PN	●		1	27.5	86	12	4	A	23,910
EPSM4120-R0.3-PN	●	12	0.3	30	86	12	4	B	23,910
EPSM4120-R0.5-PN	●		0.5	30	86	12	4	B	23,910
EPSM4120-R1.0-PN	●		1	30	86	12	4	B	23,910
EPSM4120-R1.5-PN	●		1.5	30	86	12	4	B	23,910
EPSM4120-R2.0-PN	●		2	30	86	12	4	B	23,910
EPSM4120-R2.5-PN	●		2.5	30	86	12	4	B	23,910
EPSM4120-R3.0-PN	●	3	30	86	12	4	B	23,910	

●印：標準在庫品です。□印：特定代理店在庫です。弊社営業へお問い合わせください。
 ● : Stocked items. □ : Stocked by specified distributor. Contact with our sales department.

EPISM4○○○-R○○-PN

商品コード Item code	在庫 Stock	寸法 Size(mm)					刃数 No. of flutes	形状 Shape	希望小売価格(円) Suggested retail price(¥)
		外径 Tool dia.	コーナ半径 Coner radius	刃長 Flute length	全長 Overall length	シャンク径 Shank dia.			
		DC	RE	APMX	LF	DCONMS			
EPISM4130-R0.5-PN	<input type="checkbox"/>	13	0.5	32.5	105	16	4	A	-
EPISM4130-R1.0-PN	<input type="checkbox"/>		1	32.5	105	16	4	A	-
EPISM4130-R1.5-PN	<input type="checkbox"/>		1.5	32.5	105	16	4	A	-
EPISM4130-R2.0-PN	<input type="checkbox"/>		2	32.5	105	16	4	A	-
EPISM4130-R3.0-PN	<input type="checkbox"/>		3	32.5	105	16	4	A	-
EPISM4140-R0.5-PN	<input type="checkbox"/>	14	0.5	35	105	16	4	A	-
EPISM4140-R1.0-PN	<input type="checkbox"/>		1	35	105	16	4	A	-
EPISM4140-R1.5-PN	<input type="checkbox"/>		1.5	35	105	16	4	A	-
EPISM4140-R2.0-PN	<input type="checkbox"/>		2	35	105	16	4	A	-
EPISM4140-R3.0-PN	<input type="checkbox"/>		3	35	105	16	4	A	-
EPISM4150-R0.5-PN	<input type="checkbox"/>	15	0.5	37.5	110	16	4	A	-
EPISM4150-R1.0-PN	<input type="checkbox"/>		1	37.5	110	16	4	A	-
EPISM4150-R1.5-PN	<input type="checkbox"/>		1.5	37.5	110	16	4	A	-
EPISM4150-R2.0-PN	<input type="checkbox"/>		2	37.5	110	16	4	A	-
EPISM4150-R3.0-PN	<input type="checkbox"/>		3	37.5	110	16	4	A	-
EPISM4160-R0.5-PN	<input checked="" type="checkbox"/>	16	0.5	40	110	16	4	B	48,100
EPISM4160-R1.0-PN	<input checked="" type="checkbox"/>		1	40	110	16	4	B	48,100
EPISM4160-R1.5-PN	<input checked="" type="checkbox"/>		1.5	40	110	16	4	B	48,100
EPISM4160-R2.0-PN	<input checked="" type="checkbox"/>		2	40	110	16	4	B	48,100
EPISM4160-R3.0-PN	<input checked="" type="checkbox"/>		3	40	110	16	4	B	48,100
EPISM4170-R0.5-PN	<input type="checkbox"/>	17	0.5	42.5	120	20	4	A	-
EPISM4170-R1.0-PN	<input type="checkbox"/>		1	42.5	120	20	4	A	-
EPISM4170-R1.5-PN	<input type="checkbox"/>		1.5	42.5	120	20	4	A	-
EPISM4170-R2.0-PN	<input type="checkbox"/>		2	42.5	120	20	4	A	-
EPISM4170-R3.0-PN	<input type="checkbox"/>		3	42.5	120	20	4	A	-
EPISM4180-R0.5-PN	<input type="checkbox"/>	18	0.5	45	120	20	4	A	-
EPISM4180-R1.0-PN	<input type="checkbox"/>		1	45	120	20	4	A	-
EPISM4180-R1.5-PN	<input type="checkbox"/>		1.5	45	120	20	4	A	-
EPISM4180-R2.0-PN	<input type="checkbox"/>		2	45	120	20	4	A	-
EPISM4180-R3.0-PN	<input type="checkbox"/>		3	45	120	20	4	A	-
EPISM4190-R0.5-PN	<input type="checkbox"/>	19	0.5	47.5	125	20	4	A	-
EPISM4190-R1.0-PN	<input type="checkbox"/>		1	47.5	125	20	4	A	-
EPISM4190-R1.5-PN	<input type="checkbox"/>		1.5	47.5	125	20	4	A	-
EPISM4190-R2.0-PN	<input type="checkbox"/>		2	47.5	125	20	4	A	-
EPISM4190-R3.0-PN	<input type="checkbox"/>		3	47.5	125	20	4	A	-
EPISM4200-R0.5-PN	<input checked="" type="checkbox"/>	20	0.5	50	125	20	4	B	68,630
EPISM4200-R1.0-PN	<input checked="" type="checkbox"/>		1	50	125	20	4	B	68,630
EPISM4200-R1.5-PN	<input checked="" type="checkbox"/>		1.5	50	125	20	4	B	68,630
EPISM4200-R2.0-PN	<input checked="" type="checkbox"/>		2	50	125	20	4	B	68,630
EPISM4200-R3.0-PN	<input checked="" type="checkbox"/>		3	50	125	20	4	B	68,630
EPISM4200-R5.0-PN	<input checked="" type="checkbox"/>	5	50	125	20	4	B	68,630	

○ 対応被削材 Applicable work material

炭素鋼 合金鋼 Carbon steel Alloy steel	プリハー ド鋼 Pre-hardened steel	高硬度 Hardened steel			ステン レス鋼 Stainless steel	チタン合金 耐熱合金 Titanium alloy Heat-resistant alloy	銅合金 Copper alloy	アルミ 合金 Aluminum alloy
		> 45HRC ≤ 45HRC	> 55HRC ≤ 55HRC	> 65HRC				
○	○				○	○	○	

○ 再研磨対応外径範囲 Re-grinding compatibility range

商品コード Item code	外周 Outer dia. (mm)	エンド End (mm)
EPISM-CR-PN	6 ~ 20	4 ~ 20

● : 標準在庫品です。 □印 : 特定代理店在庫です。弊社営業へお問合せください
 ● : Stocked items. □ : Stocked by specified distributor. Contact with our sales department.

ロング刃長・ラジアスタイプ Long, Radius type

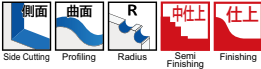

外径公差 Dia. tolerance	φ6 : 0~-0.015 φ8~φ20 : 0~-0.02	h5 φ6~12	h6 φ16, φ20	(mm)
------------------------	-----------------------------------	-------------	----------------	------

ステンレス鋼、炭素鋼、合金鋼等の荒～仕上げ加工までマルチに対応。
Multi-purpose for roughing to finishing of stainless steel, carbon steel, alloy steel, etc.

スクエアはA311頁を参照してください
Please refer to page A311 for Square

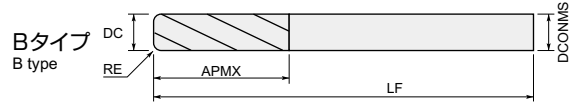

EPSML4○○○-R○○-PN

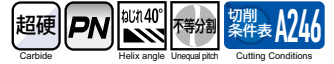

商品コード Item code	在庫 Stock	寸法 Size(mm)					刃数 No. of flutes	形状 Shape	希望小売価格(円) Suggested retail price(¥)
		外径 Tool dia.	コーナ半径 Cone radius	刃長 Flute length	全長 Overall length	シャンク径 Shank dia.			
		DC	RE	APMX	LF	DCONMS			
EPSML4060-R0.3-PN	<input type="checkbox"/>	6	0.3	30	70	6	4	B	—
EPSML4060-R0.5-PN	<input type="checkbox"/>		0.5	30	70	6	4	B	—
EPSML4060-R1.0-PN	<input type="checkbox"/>		1	30	70	6	4	B	—
EPSML4060-R1.5-PN	<input type="checkbox"/>		1.5	30	70	6	4	B	—
EPSML4080-R0.3-PN	<input type="checkbox"/>	8	0.3	40	80	8	4	B	—
EPSML4080-R0.5-PN	<input type="checkbox"/>		0.5	40	80	8	4	B	—
EPSML4080-R1.0-PN	<input type="checkbox"/>		1	40	80	8	4	B	—
EPSML4080-R1.5-PN	<input type="checkbox"/>		1.5	40	80	8	4	B	—
EPSML4080-R2.0-PN	<input type="checkbox"/>		2	40	80	8	4	B	—
EPSML4100-R0.3-PN	<input type="checkbox"/>	10	0.3	50	100	10	4	B	—
EPSML4100-R0.5-PN	<input type="checkbox"/>		0.5	50	100	10	4	B	—
EPSML4100-R1.0-PN	<input type="checkbox"/>		1	50	100	10	4	B	—
EPSML4100-R1.5-PN	<input type="checkbox"/>		1.5	50	100	10	4	B	—
EPSML4100-R2.0-PN	<input type="checkbox"/>		2	50	100	10	4	B	—
EPSML4120-R0.3-PN	<input type="checkbox"/>	12	0.3	60	120	12	4	B	—
EPSML4120-R0.5-PN	<input type="checkbox"/>		0.5	60	120	12	4	B	—
EPSML4120-R1.0-PN	<input type="checkbox"/>		1	60	120	12	4	B	—
EPSML4120-R1.5-PN	<input type="checkbox"/>		1.5	60	120	12	4	B	—
EPSML4120-R2.0-PN	<input type="checkbox"/>		2	60	120	12	4	B	—
EPSML4120-R2.5-PN	<input type="checkbox"/>		2.5	60	120	12	4	B	—
EPSML4120-R3.0-PN	<input type="checkbox"/>		3	60	120	12	4	B	—
EPSML4160-R0.5-PN	<input type="checkbox"/>	16	0.5	80	135	16	4	B	—
EPSML4160-R1.0-PN	<input type="checkbox"/>		1	80	135	16	4	B	—
EPSML4160-R1.5-PN	<input type="checkbox"/>		1.5	80	135	16	4	B	—
EPSML4160-R2.0-PN	<input type="checkbox"/>		2	80	135	16	4	B	—
EPSML4160-R3.0-PN	<input type="checkbox"/>		3	80	135	16	4	B	—
EPSML4200-R0.5-PN	<input type="checkbox"/>	20	0.5	100	155	20	4	B	—
EPSML4200-R1.0-PN	<input type="checkbox"/>		1	100	155	20	4	B	—
EPSML4200-R1.5-PN	<input type="checkbox"/>		1.5	100	155	20	4	B	—
EPSML4200-R2.0-PN	<input type="checkbox"/>		2	100	155	20	4	B	—
EPSML4200-R3.0-PN	<input type="checkbox"/>		3	100	155	20	4	B	—
EPSML4200-R5.0-PN	<input type="checkbox"/>		5	100	155	20	4	B	—

対応被削材 Applicable work material

炭素鋼 合金鋼 Carbon steel Alloy steel	プリハー ド鋼 Pre-hardened steel ≤ 45HRC	高硬度 Hardened steel > 45HRC > 55HRC > 65HRC ≤ 55HRC ≤ 65HRC			ステン レス鋼 Stainless steel	チタン合金 耐熱合金 Titanium alloy Heat-resistant alloy	銅合金 Copper alloy	アルミ 合金 Aluminum alloy
○	○			○	○	○	○	

再研磨対応外径範囲 Re-grinding compatibility range

商品コード Item code	外周 Outer dia. (mm)	エンド End (mm)
EPSML-CR-PN	6 ~ 20	6 ~ 20

Epoch SUS Multi エポックSUSマルチ

首下5DC・ラジアスタイプ Under neck 5DC, Radius type



ステンレス鋼、炭素鋼、合金鋼等の荒～仕上げ加工までマルチに対応。
Multi-purpose for roughing to finishing of stainless steel, carbon steel, alloy steel, etc.

スクエアはA311頁を参照してください
Please refer to page A311 for Square

外径公差
φ1~φ6 : 0~-0.015
φ7~φ20 : 0~-0.02
h5 h6
φ6~12 φ16,φ20 (mm)

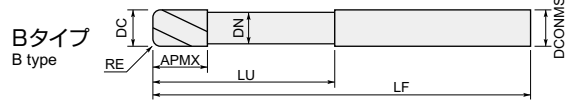
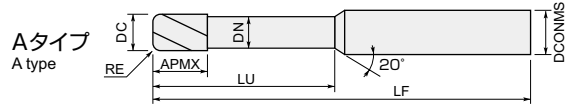

4枚刃
4 Flutes



EPMS4-000-000-R0.0-PN

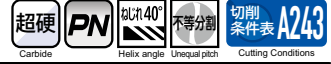

商品コード Item code	在庫 Stock	寸法 Size(mm)							刃数 No. of flutes	形状 Shape	希望小売 価格(円) Suggested retail price(¥)
		外径 Tool dia.	コーナ半径 Coner radius	刃長 Flute length	首下長 Under neck length	首径 Neck dia.	全長 Overall length	シャンク径 Shank dia.			
		DC	RE	APMX	LU	DN	LF	DCONMS			
EPMS4010-5-R0.1-PN	●	1	0.1	1.5	5	0.96	68	6	4	A	11,900
EPMS4020-10-R0.1-PN	●	2	0.1	3	10	1.92	68	6	4	A	11,900
EPMS4020-10-R0.2-PN	●		0.2	3	10	1.92	68	6	4	A	11,900
EPMS4030-15-R0.2-PN	●	3	0.2	4.5	15	2.88	68	6	4	A	11,900
EPMS4030-15-R0.5-PN	●		0.5	4.5	15	2.88	68	6	4	A	11,900
EPMS4040-20-R0.2-PN	●	4	0.2	6	20	3.7	68	6	4	A	12,220
EPMS4040-20-R0.5-PN	●		0.5	6	20	3.7	68	6	4	A	12,220
EPMS4040-20-R1.0-PN	●		1	6	20	3.7	68	6	4	A	12,220
EPMS4050-25-R0.2-PN	●	5	0.2	7.5	25	4.6	68	6	4	A	13,590
EPMS4050-25-R0.5-PN	●		0.5	7.5	25	4.6	68	6	4	A	13,590
EPMS4050-25-R1.0-PN	●		1	7.5	25	4.6	68	6	4	A	13,590
EPMS4060-30-R0.3-PN	●	6	0.3	9	30	5.5	68	6	4	B	14,480
EPMS4060-30-R0.5-PN	●		0.5	9	30	5.5	68	6	4	B	14,480
EPMS4060-30-R1.0-PN	●		1	9	30	5.5	68	6	4	B	14,480
EPMS4060-30-R1.5-PN	●		1.5	9	30	5.5	68	6	4	B	14,480
EPMS4070-35-R0.3-PN	●	7	0.3	10.5	35	6.4	80	8	4	A	16,960
EPMS4070-35-R0.5-PN	●		0.5	10.5	35	6.4	80	8	4	A	16,960
EPMS4070-35-R1.0-PN	●		1	10.5	35	6.4	80	8	4	A	16,960
EPMS4080-40-R0.3-PN	●	8	0.3	12	40	7.3	80	8	4	B	16,960
EPMS4080-40-R0.5-PN	●		0.5	12	40	7.3	80	8	4	B	16,960
EPMS4080-40-R1.0-PN	●		1	12	40	7.3	80	8	4	B	16,960
EPMS4080-40-R1.5-PN	●		1.5	12	40	7.3	80	8	4	B	16,960
EPMS4080-40-R2.0-PN	●		2	12	40	7.3	80	8	4	B	16,960
EPMS4090-45-R0.3-PN	●	9	0.3	13.5	45	8.3	94	10	4	A	21,880
EPMS4090-45-R0.5-PN	●		0.5	13.5	45	8.3	94	10	4	A	21,880
EPMS4090-45-R1.0-PN	●		1	13.5	45	8.3	94	10	4	A	21,880
EPMS4100-50-R0.3-PN	●	10	0.3	15	50	9.1	94	10	4	B	21,880
EPMS4100-50-R0.5-PN	●		0.5	15	50	9.1	94	10	4	B	21,880
EPMS4100-50-R1.0-PN	●		1	15	50	9.1	94	10	4	B	21,880
EPMS4100-50-R1.5-PN	●		1.5	15	50	9.1	94	10	4	B	21,880
EPMS4100-50-R2.0-PN	●		2	15	50	9.1	94	10	4	B	21,880
EPMS4110-55-R0.3-PN	●	11	0.3	16.5	55	10.2	110	12	4	A	26,260
EPMS4110-55-R0.5-PN	●		0.5	16.5	55	10.2	110	12	4	A	26,260
EPMS4110-55-R1.0-PN	●		1	16.5	55	10.2	110	12	4	A	26,260
EPMS4120-60-R0.3-PN	●	12	0.3	18	60	11	110	12	4	B	26,260
EPMS4120-60-R0.5-PN	●		0.5	18	60	11	110	12	4	B	26,260
EPMS4120-60-R1.0-PN	●		1	18	60	11	110	12	4	B	26,260
EPMS4120-60-R1.5-PN	●		1.5	18	60	11	110	12	4	B	26,260
EPMS4120-60-R2.0-PN	●		2	18	60	11	110	12	4	B	26,260
EPMS4120-60-R2.5-PN	●		2.5	18	60	11	110	12	4	B	26,260
EPMS4120-60-R3.0-PN	●	3	18	60	11	110	12	4	B	26,260	

● : 標準在庫品です。 □印 : 特定代理店在庫です。弊社営業へお問合せください
● : Stocked items. □ : Stocked by specified distributor. Contact with our sales department.

EPSM4○○○-○○○-R○.○-PN

商品コード Item code	在庫 Stock	寸法 Size(mm)						刃数 No. of flutes	形状 Shape	希望小売 価格(円) Suggested retail price(¥)	
		外径 Tool dia.	コーナ半径 Coner radius	刃長 Flute length	首下長 Under neck length	首径 Neck dia.	全長 Overall length				シャンク径 Shank dia.
		DC	RE	APMX	LU	DN	LF				DCONMS
EPSM4130-65-R0.5-PN	<input type="checkbox"/>	13	0.5	19.5	65	11.7	125	16	4	A	-
EPSM4130-65-R1.0-PN	<input type="checkbox"/>		1	19.5	65	11.7	125	16	4	A	-
EPSM4130-65-R1.5-PN	<input type="checkbox"/>		1.5	19.5	65	11.7	125	16	4	A	-
EPSM4130-65-R2.0-PN	<input type="checkbox"/>		2	19.5	65	11.7	125	16	4	A	-
EPSM4130-65-R3.0-PN	<input type="checkbox"/>		3	19.5	65	11.7	125	16	4	A	-
EPSM4140-70-R0.5-PN	<input type="checkbox"/>	14	0.5	21	70	12.7	125	16	4	A	-
EPSM4140-70-R1.0-PN	<input type="checkbox"/>		1	21	70	12.7	125	16	4	A	-
EPSM4140-70-R1.5-PN	<input type="checkbox"/>		1.5	21	70	12.7	125	16	4	A	-
EPSM4140-70-R2.0-PN	<input type="checkbox"/>		2	21	70	12.7	125	16	4	A	-
EPSM4140-70-R3.0-PN	<input type="checkbox"/>		3	21	70	12.7	125	16	4	A	-
EPSM4150-75-R0.5-PN	<input type="checkbox"/>	15	0.5	22.5	75	13.6	135	16	4	A	-
EPSM4150-75-R1.0-PN	<input type="checkbox"/>		1	22.5	75	13.6	135	16	4	A	-
EPSM4150-75-R1.5-PN	<input type="checkbox"/>		1.5	22.5	75	13.6	135	16	4	A	-
EPSM4150-75-R2.0-PN	<input type="checkbox"/>		2	22.5	75	13.6	135	16	4	A	-
EPSM4150-75-R3.0-PN	<input type="checkbox"/>		3	22.5	75	13.6	135	16	4	A	-
EPSM4160-80-R0.5-PN	<input checked="" type="checkbox"/>	16	0.5	24	80	14.5	135	16	4	B	52,920
EPSM4160-80-R1.0-PN	<input checked="" type="checkbox"/>		1	24	80	14.5	135	16	4	B	52,920
EPSM4160-80-R1.5-PN	<input checked="" type="checkbox"/>		1.5	24	80	14.5	135	16	4	B	52,920
EPSM4160-80-R2.0-PN	<input checked="" type="checkbox"/>		2	24	80	14.5	135	16	4	B	52,920
EPSM4160-80-R3.0-PN	<input checked="" type="checkbox"/>		3	24	80	14.5	135	16	4	B	52,920
EPSM4170-85-R0.5-PN	<input type="checkbox"/>	17	0.5	25.5	85	15.4	145	20	4	A	-
EPSM4170-85-R1.0-PN	<input type="checkbox"/>		1	25.5	85	15.4	145	20	4	A	-
EPSM4170-85-R1.5-PN	<input type="checkbox"/>		1.5	25.5	85	15.4	145	20	4	A	-
EPSM4170-85-R2.0-PN	<input type="checkbox"/>		2	25.5	85	15.4	145	20	4	A	-
EPSM4170-85-R3.0-PN	<input type="checkbox"/>		3	25.5	85	15.4	145	20	4	A	-
EPSM4180-90-R0.5-PN	<input type="checkbox"/>	18	0.5	27	90	16.3	145	20	4	A	-
EPSM4180-90-R1.0-PN	<input type="checkbox"/>		1	27	90	16.3	145	20	4	A	-
EPSM4180-90-R1.5-PN	<input type="checkbox"/>		1.5	27	90	16.3	145	20	4	A	-
EPSM4180-90-R2.0-PN	<input type="checkbox"/>		2	27	90	16.3	145	20	4	A	-
EPSM4180-90-R3.0-PN	<input type="checkbox"/>		3	27	90	16.3	145	20	4	A	-
EPSM4190-95-R0.5-PN	<input type="checkbox"/>	19	0.5	28.5	95	17.3	155	20	4	A	-
EPSM4190-95-R1.0-PN	<input type="checkbox"/>		1	28.5	95	17.3	155	20	4	A	-
EPSM4190-95-R1.5-PN	<input type="checkbox"/>		1.5	28.5	95	17.3	155	20	4	A	-
EPSM4190-95-R2.0-PN	<input type="checkbox"/>		2	28.5	95	17.3	155	20	4	A	-
EPSM4190-95-R3.0-PN	<input type="checkbox"/>		3	28.5	95	17.3	155	20	4	A	-
EPSM4200-100-R0.5-PN	<input checked="" type="checkbox"/>	20	0.5	30	100	18.2	155	20	4	B	75,550
EPSM4200-100-R1.0-PN	<input checked="" type="checkbox"/>		1	30	100	18.2	155	20	4	B	75,550
EPSM4200-100-R1.5-PN	<input checked="" type="checkbox"/>		1.5	30	100	18.2	155	20	4	B	75,550
EPSM4200-100-R2.0-PN	<input checked="" type="checkbox"/>		2	30	100	18.2	155	20	4	B	75,550
EPSM4200-100-R3.0-PN	<input checked="" type="checkbox"/>		3	30	100	18.2	155	20	4	B	75,550
EPSM4200-100-R5.0-PN	<input checked="" type="checkbox"/>		5	30	100	18.2	155	20	4	B	75,550

○ 対応被削材 Applicable work material

炭素鋼 合金鋼 Carbon steel Alloy steel	プリハー ド鋼 Pre-hardened steel	高硬度 Hardened steel			ステン レス鋼 Stainless steel	チタン合金 耐熱合金 Titanium alloy Heat-resistant alloy	銅合金 Copper alloy	アルミ 合金 Aluminum alloy
○	○	> 45HRC ≤ 55HRC	> 55HRC ≤ 65HRC	> 65HRC	○	○	○	○

○ 再研磨対応外径範囲 Re-grinding compatibility range

商品コード Item code	外周 Outer dia. (mm)	エンド End (mm)
EPSM-5DC-CR-PN	6 ~ 20	4 ~ 20

Epoch SUS Multi エポックSUSマルチ

標準切削条件表 Recommended cutting conditions

汎用 側面切削条件 General Side milling conditions

EPISM-CR

レギュラー刃長・コーナーR付き
Regular, Corner radius

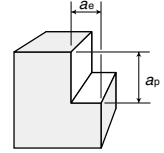

外径 DC Tool dia. (mm)	炭素鋼・合金鋼・鋳鉄 (~30HRC) Carbon steels, Alloy steels Cast irons		工具鋼・プリハードン鋼 (30~40HRC) Tool steels, Pre-hardened steels		ステンレス鋼 Stainless steels		チタン合金 Titanium alloys		超耐熱合金 Super heat-resistant alloys	
	$a_p=1DC, a_e=0.5DC$		$a_p=1DC, a_e=0.5DC$		$a_p=1DC, a_e=0.5DC$		$a_p=1DC, a_e=0.1DC$		$a_p=1DC, a_e=0.05DC$	
	回転数 n min ⁻¹	送り速度 v_f mm/min	回転数 n min ⁻¹	送り速度 v_f mm/min	回転数 n min ⁻¹	送り速度 v_f mm/min	回転数 n min ⁻¹	送り速度 v_f mm/min	回転数 n min ⁻¹	送り速度 v_f mm/min
1	31,800	760	22,300	360	19,100	310	12,700	150	9,500	76
2	15,900	810	11,100	380	9,500	320	6,400	160	4,800	82
3	10,600	860	7,400	400	6,400	350	4,200	170	3,200	86
4	8,000	910	5,600	430	4,800	360	3,200	180	2,400	91
5	6,400	960	4,500	450	3,800	380	2,500	190	1,900	95
6	5,300	950	3,700	440	3,200	380	2,100	190	1,600	96
7	4,500	940	3,200	450	2,700	380	1,800	190	1,400	98
8	4,000	960	2,800	450	2,400	380	1,600	190	1,200	96
9	3,500	940	2,500	450	2,100	380	1,400	190	1,100	99
10	3,200	960	2,200	440	1,900	380	1,300	200	1,000	100
11	2,900	910	2,000	420	1,700	360	1,200	190	900	94
12	2,700	870	1,900	410	1,600	350	1,100	180	800	86
13	2,400	820	1,700	390	1,500	340	1,000	170	700	80
14	2,300	840	1,600	390	1,400	340	900	160	700	85
15	2,100	810	1,500	390	1,300	340	800	150	600	77
16	2,000	820	1,400	380	1,200	330	800	160	600	82
17	1,900	800	1,300	370	1,100	310	700	150	600	85
18	1,800	800	1,200	350	1,100	320	700	150	500	74
19	1,700	780	1,200	370	1,000	310	700	160	500	77
20	1,600	770	1,100	350	1,000	320	600	140	500	80

【注意】 本工具のPNコーティングはその性質上、通電性が微小です。従って、通電方式の工具長測定装置をご使用の際にはご注意ください。
被削材、加工形状に合わせて、適切なクーラントを使用してください。
できるだけ高剛性、高精度の機械及びチャックをご使用ください。
この標準切削条件表は切削条件の目安を示すものです。実際の加工では、加工条件、目的、使用機械等により条件を調整してください。
ビビリや異常振動が発生する場合は条件を調整してください。

【Note】 PN coating is less electro conductive. Therefore, electric transmitted measuring systems may not work.
Use the appropriate coolant for the work material and machining shape.
Use the high-rigidity and high accuracy machine as possible.
These Recommended Cutting Conditions indicate only the rule of a thumb for the cutting conditions. In actual machining, the condition should be adjusted according to the machining shape, purpose and the machine type.
Please adjust it if chatter or abnormal vibration occurs.

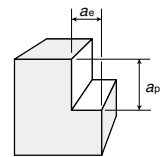

高速 側面切削条件 High speed Side milling conditions

EPISM-CR

レギュラー刃長・コーナR付き
Regular, Corner radius

外径 DC Tool dia. (mm)	炭素鋼・合金鋼・鋳鉄 (~30HRC) Carbon steels, Alloy steels Cast irons		工具鋼・プリハードン鋼 (30~40HRC) Tool steels, Pre-hardened steels		ステンレス鋼 Stainless steels		チタン合金 Titanium alloys		超耐熱合金 Super heat-resistant alloys	
	$a_p=1DC, a_e=0.5DC$		$a_p=1DC, a_e=0.5DC$		$a_p=1DC, a_e=0.5DC$		$a_p=1DC, a_e=0.1DC$		$a_p=1DC, a_e=0.05DC$	
	回転数 n min ⁻¹	送り速度 v_f mm/min	回転数 n min ⁻¹	送り速度 v_f mm/min	回転数 n min ⁻¹	送り速度 v_f mm/min	回転数 n min ⁻¹	送り速度 v_f mm/min	回転数 n min ⁻¹	送り速度 v_f mm/min
1	41,400	990	31,800	510	28,600	460	19,100	230	15,900	127
2	20,700	1,060	15,900	540	14,300	490	9,500	240	8,000	136
3	13,800	1,120	10,600	570	9,500	510	6,400	260	5,300	143
4	10,300	1,170	8,000	610	7,200	550	4,800	270	4,000	152
5	8,300	1,250	6,400	640	5,700	570	3,800	280	3,200	160
6	6,900	1,240	5,300	640	4,800	580	3,200	290	2,700	162
7	5,900	1,240	4,500	630	4,100	570	2,700	280	2,300	161
8	5,200	1,250	4,000	640	3,600	580	2,400	290	2,000	160
9	4,600	1,240	3,500	630	3,200	580	2,100	280	1,800	162
10	4,100	1,230	3,200	640	2,900	580	1,900	290	1,600	160
11	3,800	1,190	2,900	610	2,600	540	1,700	270	1,400	146
12	3,400	1,100	2,700	580	2,400	520	1,600	260	1,300	140
13	3,200	1,100	2,400	550	2,200	500	1,500	260	1,200	137
14	3,000	1,100	2,300	560	2,000	490	1,400	260	1,100	134
15	2,800	1,080	2,100	540	1,900	490	1,300	250	1,100	142
16	2,600	1,060	2,000	540	1,800	490	1,200	240	1,000	136
17	2,400	1,020	1,900	540	1,700	480	1,100	230	900	127
18	2,300	1,020	1,800	530	1,600	470	1,100	240	900	133
19	2,200	1,020	1,700	520	1,500	460	1,000	230	800	123
20	2,100	1,010	1,600	510	1,400	450	1,000	240	800	128

【注意】 本工具のPNコーティングはその性質上、通電性が微小です。従って、通電方式の工具長測定装置をご使用の際にはご注意ください。
被削材、加工形状に合わせて、適切なクーラントを使用してください。
できるだけ高剛性、高精度の機械及びチャックをご使用ください。
この標準切削条件表は切削条件の目安を示すものです。実際の加工では、加工条件、目的、使用機械等により条件を調整してください。
ビビリや異常振動が発生する場合は条件を調整してください。

【Note】 PN coating is less electro conductive. Therefore, electric transmitted measuring systems may not work.
Use the appropriate coolant for the work material and machining shape.
Use the high-rigidity and high accuracy machine as possible.
These Recommended Cutting Conditions indicate only the rule of a thumb for the cutting conditions. In actual machining, the condition should be adjusted according to the machining shape, purpose and the machine type.
Please adjust it if chatter or abnormal vibration occurs.

Epoch SUS Multi エポックSUSマルチ

超硬合金ドリル
リジッドエポックSUSマルチ

汎用 溝切削条件 General Slotting conditions

EPISM-CR

レギュラー刃長・コーナR付き
Regular, Corner radius

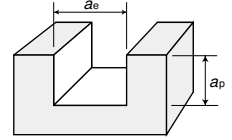

外径 DC Tool dia. (mm)	炭素鋼・合金鋼・鋳鉄 (~30HRC) Carbon steels, Alloy steels Cast iron		工具鋼・プリハードン鋼 (30~40HRC) Tool steels, Pre-hardened steels		ステンレス鋼 Stainless steels		チタン合金 Titanium alloys		超耐熱合金 Super heat-resistant alloys	
	ap=1DC		ap=1DC		ap=1DC		ap=0.5DC		ap=0.5DC	
	回転数 n min ⁻¹	送り速度 vf mm/min	回転数 n min ⁻¹	送り速度 vf mm/min	回転数 n min ⁻¹	送り速度 vf mm/min	回転数 n min ⁻¹	送り速度 vf mm/min	回転数 n min ⁻¹	送り速度 vf mm/min
1	28,600	360	19,100	190	17,500	130	11,100	60	6,400	19
2	14,300	430	9,500	230	8,800	160	5,600	70	3,200	23
3	9,500	500	6,400	270	5,800	180	3,700	80	2,100	26
4	7,200	580	4,800	310	4,400	210	2,800	90	1,600	31
5	5,700	640	3,800	340	3,500	240	2,200	100	1,300	35
6	4,800	720	3,200	380	2,900	260	1,900	110	1,100	40
7	4,100	720	2,700	380	2,500	260	1,600	110	900	38
8	3,600	720	2,400	380	2,200	260	1,400	110	800	38
9	3,200	720	2,100	380	1,900	260	1,200	110	700	38
10	2,900	730	1,900	380	1,800	270	1,100	110	600	36
11	2,600	680	1,700	360	1,600	250	1,000	100	600	38
12	2,400	650	1,600	350	1,500	240	900	100	500	32
13	2,200	630	1,500	340	1,300	220	900	100	500	34
14	2,000	610	1,400	340	1,300	240	800	100	500	37
15	1,900	610	1,300	340	1,200	230	700	90	400	31
16	1,800	610	1,200	330	1,100	220	700	100	400	33
17	1,700	600	1,100	310	1,000	210	700	100	400	34
18	1,600	590	1,100	320	1,000	220	600	90	400	35
19	1,500	580	1,000	310	900	210	600	90	300	28
20	1,400	560	1,000	320	900	220	600	100	300	29

【注意】 本工具のPNコーティングはその性質上、通電性が微小です。従って、通電方式の工具長測定装置をご使用の際にはご注意ください。
被削材、加工形状に合わせて、適切なクーラントを使用してください。
できるだけ高剛性、高精度の機械及びチャックをご使用ください。
この標準切削条件表は切削条件の目安を示すものです。実際の加工では、加工条件、目的、使用機械等により条件を調整してください。
ビビリや異常振動が発生する場合は条件を調整してください。
座繰り加工を行う際に、送り速度を溝条件の1/5に、0.01DCのステップに設定してください。
傾斜進入加工を行う際に、進入角度を3°以下、送り速度を溝条件の70%送りに設定してください。

【Note】 PN coating is less electro conductive. Therefore, electric transmitted measuring systems may not work.
Use the appropriate coolant for the work material and machining shape.
Use the high-rigidity and high accuracy machine as possible.
These Recommended Cutting Conditions indicate only the rule of a thumb for the cutting conditions. In actual machining, the condition should be adjusted according to the machining shape, purpose and the machine type.
Please adjust it if chatter or abnormal vibration occurs.
Please setup feed 1/5 that of slotting parameter and step 0.01DC for drilling application.
Please setup feed 70% of slotting parameter and ramping angle 3° for ramping application.

側面仕上げ切削条件 Side finishing conditions

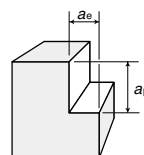

EP5M-CR **EP5M-5DC-CR**
 レギュラー刃長・コーナR付き 首下5DCタイプ・コーナR付き
 Regular, Corner radius Under neck 5DC, Corner radius

外径 DC Tool dia. (mm)	炭素鋼・合金鋼・鋳鉄 (~30HRC) Carbon steels, Alloy steels Cast irons		工具鋼・プリハードン鋼 (30~40HRC) Tool steels, Pre-hardened steels		ステンレス鋼 Stainless steels		チタン合金 Titanium alloys		超耐熱合金 Super heat-resistant alloys	
	ap=1DC, ae=0.001~0.02DC		ap=1DC, ae=0.001~0.02DC		ap=1DC, ae=0.001~0.02DC		ap=1DC, ae=0.001~0.02DC		ap=1DC, ae=0.001~0.02DC	
	回転数 n min ⁻¹	送り速度 vf mm/min	回転数 n min ⁻¹	送り速度 vf mm/min	回転数 n min ⁻¹	送り速度 vf mm/min	回転数 n min ⁻¹	送り速度 vf mm/min	回転数 n min ⁻¹	送り速度 vf mm/min
1	45,500	980	35,000	500	31,500	450	21,000	230	17,500	130
2	22,800	1,050	17,500	540	15,800	480	10,500	240	8,800	130
3	15,200	1,110	11,700	570	10,500	510	7,000	260	5,800	140
4	11,400	1,170	8,800	600	7,900	540	5,300	270	4,400	150
5	9,100	1,230	7,000	630	6,300	570	4,200	280	3,500	160
6	7,600	1,230	5,800	630	5,300	570	3,500	280	2,900	160
7	6,500	1,230	5,000	630	4,500	570	3,000	280	2,500	160
8	5,700	1,230	4,400	630	3,900	560	2,600	280	2,200	160
9	5,100	1,240	3,900	630	3,500	570	2,300	280	1,900	150
10	4,600	1,240	3,500	630	3,200	580	2,100	280	1,800	160
11	4,100	1,160	3,200	600	2,900	550	1,900	270	1,600	150
12	3,800	1,110	2,900	560	2,600	510	1,800	260	1,500	150
13	3,500	1,080	2,700	560	2,400	490	1,600	250	1,300	130
14	3,300	1,090	2,500	550	2,300	500	1,500	250	1,300	140
15	3,000	1,040	2,300	530	2,100	490	1,400	240	1,200	140
16	2,800	1,030	2,200	540	2,000	490	1,300	240	1,100	130
17	2,700	1,030	2,100	530	1,900	480	1,200	230	1,000	130
18	2,500	1,000	1,900	500	1,800	480	1,200	240	1,000	130
19	2,400	1,000	1,800	500	1,700	470	1,100	230	900	120
20	2,300	990	1,800	520	1,600	460	1,100	240	900	130

※上表はレギュラー刃の切削条件表です。5DCタイプをご使用の場合は回転数・送り速度を70%を目安に調整してください。

※The table above indicates cutting parameter for regular type, please reduce both rotation and feed rate to 70% when using 5DC type

Epoch SUS Multi エポックSUSマルチ

超硬合金チップ
リジッドエポックSUSマルチ

汎用 側面切削条件 General Side milling conditions

EPSM-5DC-CR

首下5DCタイプ・コーナーR付き
Under neck 5DC, Corner radius

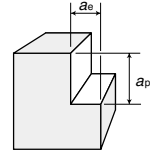

外径 DC Tool dia. (mm)	炭素鋼・合金鋼・鋳鉄 (~30HRC) Carbon steels, Alloy steels Cast irons		工具鋼・プリハードン鋼 (30~40HRC) Tool steels, Pre-hardened steels		ステンレス鋼 Stainless steels		チタン合金 Titanium alloys		超耐熱合金 Super heat-resistant alloys	
	$a_p=0.5DC, a_e=0.25DC$		$a_p=0.5DC, a_e=0.25DC$		$a_p=0.5DC, a_e=0.25DC$		$a_p=0.5DC, a_e=0.1DC$		$a_p=0.5DC, a_e=0.05DC$	
	回転数 n min ⁻¹	送り速度 v_f mm/min	回転数 n min ⁻¹	送り速度 v_f mm/min	回転数 n min ⁻¹	送り速度 v_f mm/min	回転数 n min ⁻¹	送り速度 v_f mm/min	回転数 n min ⁻¹	送り速度 v_f mm/min
1	28,600	690	19,100	310	15,900	250	12,700	150	9,500	76
2	14,300	730	9,500	320	8,000	270	6,400	160	4,800	82
3	9,500	770	6,400	350	5,300	290	4,200	170	3,200	86
4	7,200	820	4,800	360	4,000	300	3,200	180	2,400	91
5	5,700	860	3,800	380	3,200	320	2,500	190	1,900	95
6	4,800	860	3,200	380	2,700	320	2,100	190	1,600	96
7	4,100	860	2,700	380	2,300	320	1,800	190	1,400	98
8	3,600	860	2,400	380	2,000	320	1,600	190	1,200	96
9	3,200	860	2,100	380	1,800	320	1,400	190	1,100	99
10	2,900	870	1,900	380	1,600	320	1,300	200	1,000	100
11	2,600	820	1,700	360	1,400	290	1,200	190	900	94
12	2,400	780	1,600	350	1,300	280	1,100	180	800	86
13	2,200	760	1,500	350	1,200	280	1,000	170	700	81
14	2,000	740	1,400	340	1,100	270	900	170	700	86
15	1,900	740	1,300	340	1,100	280	800	150	600	77
16	1,800	730	1,200	330	1,000	270	800	160	600	82
17	1,700	730	1,100	310	900	260	700	150	600	86
18	1,600	720	1,100	330	900	270	700	160	500	75
19	1,500	690	1,000	310	800	250	700	160	500	77
20	1,400	670	1,000	320	800	260	600	140	500	80

※₂ 上表は5DCタイプおよび5DC 突出した際の切削条件表です。工具突出し量により条件を調整してください。

※₂ The above table shows cutting conditions for 5DC type tools with a 5DC overhang. Adjust conditions according to the tool overhang amount.

【注意】 本工具のPNコーティングはその性質上、通電性が微小です。従って、通電方式の工具長測定装置をご使用の際にはご注意ください。
被削材、加工形状に合わせて、適切なクーラントを使用してください。
できるだけ高剛性、高精度の機械及びチャックをご使用ください。
この標準切削条件表は切削条件の目安を示すものです。実際の加工では、加工条件、目的、使用機械等により条件を調整してください。
ビビリや異常振動が発生する場合は条件を調整してください。

[Note] PN coating is less electro conductive. Therefore, electric transmitted measuring systems may not work.
Use the appropriate coolant for the work material and machining shape.
Use the high-rigidity and high accuracy machine as possible
These Recommended Cutting Conditions indicate only the rule of a thumb for the cutting conditions. In actual machining, the condition should be adjusted according to the machining shape, purpose and the machine type.
Please adjust it if chatter or abnormal vibration occurs.

汎用 溝切削条件 General Slotting conditions

EPSM-5DC-CR

首下5DCタイプ・コーナー付き
Under neck 5DC, Corner radius

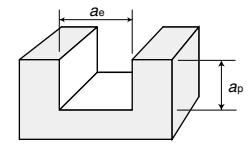

外径 DC Tool dia. (mm)	炭素鋼・合金鋼・鋳鉄 (~30HRC) Carbon steels, Alloy steels Cast irons		工具鋼・プリハードン鋼 (30~40HRC) Tool steels, Pre-hardened steels		ステンレス鋼 Stainless steels		チタン合金 Titanium alloys		超耐熱合金 Super heat-resistant alloys	
	$a_p=0.5DC$		$a_p=0.5DC$		$a_p=0.5DC$		$a_p=0.25DC$		$a_p=0.25DC$	
	回転数 n min ⁻¹	送り速度 v_f mm/min	回転数 n min ⁻¹	送り速度 v_f mm/min	回転数 n min ⁻¹	送り速度 v_f mm/min	回転数 n min ⁻¹	送り速度 v_f mm/min	回転数 n min ⁻¹	送り速度 v_f mm/min
1	25,500	320	15,900	160	14,300	110	9,500	50	4,800	14
2	12,700	380	8,000	190	7,200	130	4,800	60	2,400	17
3	8,500	450	5,300	220	4,800	150	3,200	70	1,600	20
4	6,400	510	4,000	260	3,600	170	2,400	80	1,200	23
5	5,100	570	3,200	290	2,900	200	1,900	90	1,000	27
6	4,200	630	2,700	320	2,400	220	1,600	100	800	29
7	3,600	630	2,300	320	2,000	210	1,400	100	700	29
8	3,200	640	2,000	320	1,800	220	1,200	100	600	29
9	2,800	630	1,800	320	1,600	220	1,100	100	500	27
10	2,500	630	1,600	320	1,400	210	1,000	100	500	30
11	2,300	600	1,400	290	1,300	200	900	90	400	25
12	2,100	570	1,300	280	1,200	190	800	90	400	26
13	2,000	580	1,200	280	1,100	190	700	80	400	28
14	1,800	550	1,100	270	1,000	180	700	90	300	22
15	1,700	550	1,100	280	1,000	190	600	80	300	23
16	1,600	540	1,000	270	900	180	600	80	300	24
17	1,500	540	900	260	800	170	600	90	300	26
18	1,400	520	900	270	800	180	500	70	300	27
19	1,300	500	800	250	800	180	500	80	300	28
20	1,300	520	800	260	700	170	500	80	200	19

【注意】 本工具のPNコーティングはその性質上、通電性が微小です。従って、通電方式の工具長測定装置をご使用の際にはご注意ください。
被削材、加工形状に合わせて、適切なクーラントを使用してください。
できるだけ高剛性、高精度の機械及びチャックをご使用ください。
この標準切削条件表は切削条件の目安を示すものです。実際の加工では、加工条件、目的、使用機械等により条件を調整してください。
ビビリや異常振動が発生する場合は条件を調整してください。
座繰り加工を行う際に、送り速度を溝条件の1/5に、0.01DCのステップに設定してください。
傾斜進入加工を行う際に、進入角度を3°以下、送り速度を溝条件の70%送りに設定してください。

【Note】 PN coating is less electro conductive. Therefore, electric transmitted measuring systems may not work.
Use the appropriate coolant for the work material and machining shape.
Use the high-rigidity and high accuracy machine as possible
These Recommended Cutting Conditions indicate only the rule of a thumb for the cutting conditions. In actual machining, the condition should be adjusted according to the machining shape, purpose and the machine type.
Please adjust it if chatter or abnormal vibration occurs.
Please setup feed 1/5 that of slotting parameter and step 0.01DC for drilling application.
Please setup feed 70% of slotting parameter and ramping angle 3° for ramping application.

Epoch TH Power Mill エポック TH パワーミル

高硬度材加工用。切りくず排出性抜群で高効率が可能。
For machining of high-hardness materials. Excellent chip removal performance enables high efficiency.

コーナR付き

Corner radius

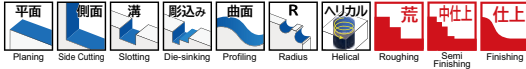

スクエアはA328頁を参照してください
Please refer to page A328 for Square

外径公差
Dia. tolerance

φ3~φ6 : 0~-0.015
φ8~φ20 : 0~-0.02



(mm)



EPP4○○○○-○○-TH



商品コード Item code	在庫 Stock	寸法 Size (mm)					希望小売価格 (円) Suggested retail price(¥)
		外径 Tool dia.	コーナ半径 Corner radius	刃長 Flute length	全長 Overall length	シャンク径 Shank dia.	
EPP4030-02-TH	●	3	0.2	8	60	6	15,960
EPP4030-05-TH	●		0.5	8	60	6	15,960
EPP4040-02-TH	●	4	0.2	11	60	6	16,720
EPP4040-05-TH	●		0.5	11	60	6	16,720
EPP4040-10-TH	●		1.0	11	60	6	16,720
EPP4050-02-TH	●	5	0.2	13	60	6	18,640
EPP4050-05-TH	●		0.5	13	60	6	18,640
EPP4050-10-TH	●		1.0	13	60	6	18,640
EPP4060-03-TH	●	6	0.3	13	60	6	20,430
EPP4060-05-TH	●		0.5	13	60	6	20,430
EPP4060-10-TH	●		1.0	13	60	6	20,430
EPP4060-15-TH	●		1.5	13	60	6	20,430
EPP4080-03-TH	●	8	0.3	19	75	8	25,030
EPP4080-05-TH	●		0.5	19	75	8	25,030
EPP4080-10-TH	●		1.0	19	75	8	25,030
EPP4080-15-TH	●		1.5	19	75	8	25,030
EPP4080-20-TH	●		2.0	19	75	8	25,030
EPP4100-03-TH	●	10	0.3	22	80	10	33,550
EPP4100-05-TH	●		0.5	22	80	10	33,550
EPP4100-10-TH	●		1.0	22	80	10	33,550
EPP4100-15-TH	●		1.5	22	80	10	33,550
EPP4100-20-TH	●		2.0	22	80	10	33,550
EPP4120-05-TH	●	12	0.5	26	100	12	42,080
EPP4120-10-TH	●		1.0	26	100	12	42,080
EPP4120-15-TH	●		1.5	26	100	12	42,080
EPP4120-20-TH	●		2.0	26	100	12	42,080
EPP4120-30-TH	●		3.0	26	100	12	42,080
EPP4160-10-TH	●	16	1.0	32	110	16	96,550
EPP4160-15-TH	●		1.5	32	110	16	96,550
EPP4160-20-TH	●		2.0	32	110	16	96,550
EPP4160-30-TH	●		3.0	32	110	16	96,550
EPP4200-10-TH	●	20	1.0	38	125	20	140,760
EPP4200-15-TH	●		1.5	38	125	20	140,760
EPP4200-20-TH	●		2.0	38	125	20	140,760
EPP4200-30-TH	●		3.0	38	125	20	140,760

○ 対応被削材 Applicable work material

炭素鋼 合金鋼 Carbon steel Alloy steel	プリハード ド鋼 Pre-hardened steel	高硬度 Hardened steel			ステン レス鋼 Stainless steel	チタン合金 耐熱合金 Titanium alloy Heat-resistant alloy	銅合金 Copper alloy	アルミ 合金 Aluminum alloy
		> 45HRC ≤ 55HRC	> 55HRC ≤ 65HRC	> 65HRC				
○	○	○	○	○	○	○	○	

○ : 標準在庫品です。 ● : Stocked items.

○ 再研磨対応外径範囲 Re-grinding compatibility range

商品コード Item code	外周 Outer dia. (mm)	エンド End (mm)
EPP-CR-TH	6 ~ 20	3 ~ 20

Epoch TH Power Mill エポック TH パワーミル

超硬合金パワーミル
リジッドアスエントミル

標準切削条件表 Recommended cutting conditions

EPP4-CR-TH

レギュラー刃長・コーナR付き
Regular, Corner radius

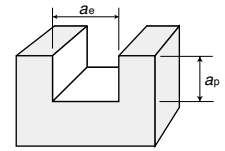

<溝切削> Slotting

被削材 Work material	合金鋼 Alloy steels (200~250HB) SKD61,SKD11				合金鋼 Alloy steels (25~35HRC) SCM440				プリハードン鋼 Pre-hardened steels (35~45HRC) NAK80				焼入れ鋼 Hardened steels (45~55HRC) SKD61,SKT4			
	高速条件 High speed		汎用条件 General		高速条件 High speed		汎用条件 General		高速条件 High speed		汎用条件 General		高速条件 High speed		汎用条件 General	
切込み Depth of cut (mm)	$a_p \leq 0.5DC$ $a_e = 1DC$		$a_p \leq 1DC$ $a_e = 1DC$				$a_p \leq 0.5DC$ $a_e = 1DC$				$a_p \leq 0.5DC$ $a_e = 1DC$				$a_p \leq 0.2DC$ $a_e = 1DC$	
外径DC Tool dia. (mm)	回転数 n (min^{-1})	送り速度 V_f (mm/min)	回転数 n (min^{-1})	送り速度 V_f (mm/min)	回転数 n (min^{-1})	送り速度 V_f (mm/min)	回転数 n (min^{-1})	送り速度 V_f (mm/min)	回転数 n (min^{-1})	送り速度 V_f (mm/min)	回転数 n (min^{-1})	送り速度 V_f (mm/min)	回転数 n (min^{-1})	送り速度 V_f (mm/min)	回転数 n (min^{-1})	送り速度 V_f (mm/min)
φ3	8,500	820	6,400	490			6,400	440			5,800	360			5,300	240
φ4	6,400	920	4,800	550			4,800	500			4,400	410			4,000	280
φ5	5,100	980	3,800	580			3,800	530			3,500	430			3,200	290
φ6	4,200	1,010	3,200	610			3,200	550			2,900	450			2,700	310
φ8	3,200	1,090	2,400	650			2,400	590			2,200	480			2,000	330
φ10	2,500	950	1,900	580			1,900	520			1,800	440			1,600	290
φ12	2,100	880	1,600	540			1,600	480			1,500	400			1,300	260
φ16	1,600	770	1,200	460			1,200	410			1,100	340			1,000	230
φ20	1,300	750	1,000	460			1,000	420			900	330			800	200

<側面切削> Side milling

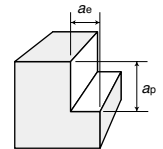

被削材 Work material	合金鋼 Alloy steels (200~250HB) SKD61,SKD11				合金鋼 Alloy steels (25~35HRC) SCM440				プリハードン鋼 Pre-hardened steels (35~45HRC) CENA1,NAK80				焼入れ鋼 Hardened steels (45~55HRC) SKD61,SKT4			
	高速条件 High speed		汎用条件 General		高速条件 High speed		汎用条件 General		高速条件 High speed		汎用条件 General		高速条件 High speed		汎用条件 General	
切込み Depth of cut (mm)	$a_p = 1.5DC$ $a_e = 0.1DC$		$a_p = 1.5DC$ $a_e = 0.15DC$		$a_p = 1.5DC$ $a_e = 0.05DC$		$a_p = 1.5DC$ $a_e = 0.1DC$		$a_p = 1.5DC$ $a_e = 0.05DC$		$a_p = 1.5DC$ $a_e = 0.07DC$		$a_p = 1.5DC$ $a_e = 0.02DC$		$a_p = 1.5DC$ $a_e = 0.05DC$	
外径DC Tool dia. (mm)	回転数 n (min^{-1})	送り速度 V_f (mm/min)	回転数 n (min^{-1})	送り速度 V_f (mm/min)	回転数 n (min^{-1})	送り速度 V_f (mm/min)	回転数 n (min^{-1})	送り速度 V_f (mm/min)	回転数 n (min^{-1})	送り速度 V_f (mm/min)	回転数 n (min^{-1})	送り速度 V_f (mm/min)	回転数 n (min^{-1})	送り速度 V_f (mm/min)	回転数 n (min^{-1})	送り速度 V_f (mm/min)
φ3	16,000	1,800	9,600	860	14,000	1,400	9,600	770	12,000	1,100	8,500	610	11,000	860	7,400	460
φ4	12,000	1,900	7,200	920	10,000	1,400	7,200	830	8,800	1,100	6,400	660	8,000	900	5,600	500
φ5	9,600	2,100	5,700	1,000	8,300	1,600	5,700	900	7,000	1,200	5,100	720	6,400	990	4,500	550
φ6	8,000	2,200	4,800	1,080	6,900	1,700	4,800	970	5,800	1,300	4,200	750	5,300	1,040	3,700	580
φ8	6,000	2,400	3,600	1,150	5,200	1,900	3,600	1,040	4,400	1,400	3,200	820	4,000	1,120	2,800	630
φ10	4,800	2,200	2,900	1,070	4,100	1,700	2,900	960	3,500	1,300	2,500	740	3,200	1,030	2,200	570
φ12	4,000	2,100	2,400	1,000	3,500	1,600	2,400	900	2,900	1,200	2,100	700	2,700	980	1,900	550
φ16	3,000	1,700	1,800	810	2,600	1,300	1,800	730	2,200	1,000	1,600	570	2,000	780	1,400	440
φ20	2,400	1,400	1,400	670	2,100	1,100	1,400	600	1,800	860	1,300	500	1,590	670	1,110	370

- 【注意】**
- ①できるだけ高剛性、高精度の機械をご使用ください。
 - ②被削材、加工形状に合わせて、適切なクーラントを使用してください。
 - ③この切削条件表は切削条件の目安を示すものです。実際の加工では加工形状、目的、使用機械等により条件を調整してください。
 - ④機械の回転数が足りない場合には、回転数と送り速度を同じ比率で下げてください。

- 【Note】**
- ① Use a highly rigid and accurate machine as possible.
 - ② Use the appropriate coolant for the work material and machining shape.
 - ③ These conditions are for general guidance; in actual machining conditions adjust the parameters according to your actual machine and work-piece conditions.
 - ④ If the rpm available is lower than that recommended please reduce the feed rate to the same ratio.

Epoch Power Mill エポックパワーミル

切りくず排出性抜群で高能率が可能。
Excellent chip removal enables high efficiency.

スクエアはA336頁を参照してください
Please refer to page A336 for Square

レギュラー刃長・コーナR付き Regular, Corner radius

外径公差 Dia. tolerance
 $\phi 3 \sim \phi 6 : 0 \sim -0.015$
 $\phi 8 \sim \phi 25 : 0 \sim -0.02$

h6

(mm)

ロング刃長・コーナR付き Long, Corner radius

外径公差 Dia. tolerance
 $\phi 6 : 0 \sim -0.015$
 $\phi 8 \sim \phi 25 : 0 \sim -0.02$

h6

(mm)



EPP4-○○○○-○○

超硬 Carbide $\geq 43^\circ$ Helix angle 切削条件表 A251 Cutting Conditions

商品コード Item code	在庫 Stock	寸法 Size (mm)					希望小売 価格(円) Suggested retail price(¥)
		外径 Tool dia.	コーナ半径 Corner radius	刃長 Flute length	全長 Overall length	シャンク径 Shank dia.	
EPP4030-02	●	3	0.2	8	60	6	14,460
EPP4030-05	●		0.5	8	60	6	14,460
EPP4040-02	●	4	0.2	11	60	6	15,220
EPP4040-05	●		0.5	11	60	6	15,220
EPP4040-10	●		1	11	60	6	15,220
EPP4050-02	●	5	0.2	13	60	6	16,960
EPP4050-05	●		0.5	13	60	6	16,960
EPP4050-10	●		1	13	60	6	16,960
EPP4060-03	●	6	0.3	13	60	6	18,520
EPP4060-05	●		0.5	13	60	6	18,520
EPP4060-10	●		1	13	60	6	18,520
EPP4060-15	●		1.5	13	60	6	18,520
EPP4080-03	●	8	0.3	19	75	8	22,790
EPP4080-05	●		0.5	19	75	8	22,790
EPP4080-10	●		1	19	75	8	22,790
EPP4080-15	●		1.5	19	75	8	22,790
EPP4080-20	●		2	19	75	8	22,790
EPP4100-03	●	10	0.3	22	80	10	30,530
EPP4100-05	●		0.5	22	80	10	30,530
EPP4100-10	●		1	22	80	10	30,530
EPP4100-15	●		1.5	22	80	10	30,530
EPP4100-20	●		2	22	80	10	30,530
EPP4120-05	●	12	0.5	26	100	12	38,270
EPP4120-10	●		1	26	100	12	38,270
EPP4120-15	●		1.5	26	100	12	38,270
EPP4120-20	●		2	26	100	12	38,270
EPP4120-30	●		3	26	100	12	38,270
EPP4160-10	●	16	1	32	110	16	87,750
EPP4160-15	●		1.5	32	110	16	87,750
EPP4160-20	●		2	32	110	16	87,750
EPP4160-30	●		3	32	110	16	87,750
EPP4200-10	●	20	1	38	125	20	127,860
EPP4200-15	●		1.5	38	125	20	127,860
EPP4200-20	●		2	38	125	20	127,860
EPP4200-30	●		3	38	125	20	127,860
EPP4250-10	□	25	1	63	140	25	—
EPP4250-15	□		1.5	63	140	25	—
EPP4250-20	□		2	63	140	25	—
EPP4250-30	□		3	63	140	25	—

EPPL4-○○○○-○○

超硬 Carbide $\geq 43^\circ$ Helix angle 切削条件表 A253 Cutting Conditions

商品コード Item code	在庫 Stock	寸法 Size (mm)					希望小売 価格(円) Suggested retail price(¥)
		外径 Tool dia.	コーナ半径 Corner radius	刃長 Flute length	全長 Overall length	シャンク径 Shank dia.	
EPPL4060-05	●	6	0.5	25	70	6	25,930
EPPL4060-10	●		1	25	70	6	25,930
EPPL4080-05	●	8	0.5	35	90	8	31,870
EPPL4080-10	●		1	35	90	8	31,870
EPPL4080-15	●		1.5	35	90	8	31,870
EPPL4080-20	●		2	35	90	8	31,870
EPPL4100-05	●	10	0.5	45	100	10	42,760
EPPL4100-10	●		1	45	100	10	42,760
EPPL4100-15	●		1.5	45	100	10	42,760
EPPL4100-20	●		2	45	100	10	42,760
EPPL4120-05	●	12	0.5	55	120	12	53,640
EPPL4120-10	●		1	55	120	12	53,640
EPPL4120-15	●		1.5	55	120	12	53,640
EPPL4120-20	●		2	55	120	12	53,640
EPPL4120-30	●		3	55	120	12	53,640
EPPL4160-10	●	16	1	65	135	16	123,170
EPPL4160-15	●		1.5	65	135	16	123,170
EPPL4160-20	●		2	65	135	16	123,170
EPPL4160-30	●		3	65	135	16	123,170
EPPL4200-10	●	20	1	75	155	20	179,470
EPPL4200-15	●		1.5	75	155	20	179,470
EPPL4200-20	●		2	75	155	20	179,470
EPPL4200-30	●		3	75	155	20	179,470
EPPL4250-10	□	25	1	100	200	25	—
EPPL4250-15	□		1.5	100	200	25	—
EPPL4250-20	□		2	100	200	25	—
EPPL4250-30	□		3	100	200	25	—

○ EPP-CR、EPPL-CR、EPPLS-CR の対応被削材

Applicable work material of EPP-CR, EPPL-CR, EPPLS-CR

炭素鋼 合金鋼 Carbon steel Alloy steel	プリハー ド鋼 Pre-hardened steel ≤ 45HRC	高硬度 Hardened steel			ステン レス鋼 Stainless steel	チタン合金 耐熱合金 Titanium alloy Heat-resistant alloy	銅合金 Copper alloy	アルミ 合金 Aluminum alloy
		> 45HRC ≤ 55HRC	> 55HRC ≤ 65HRC	> 65HRC				
○	○	○	○	○	○	○	○	

- : 標準在庫品です。 □印 : 特定代理店在庫です。弊社営業へお問合せください
- : Stocked items. □ : Stocked by specified distributor. Contact with our sales department.

○ 再研磨対応外径範囲

Re-grinding compatibility range

商品コード Item code	外周 Outer dia. (mm)	エンド End (mm)
EPP-CR	6 ~ 25	3 ~ 25
EPPL-CR	6 ~ 25	6 ~ 25
EPPLS-CR	6 ~ 17	3 ~ 17

Epoch Power Mill エポックパワーミル

切りくず排出性抜群で高効率が可能。
Excellent chip removal enables high efficiency.

スクエアはA336頁を参照してください
Please refer to page A336 for Square

ロングシャンク・コーナR付き Long Shank, Corner radius

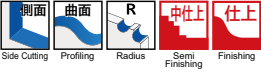

外径公差 Dia.tolerance
φ3~φ6 : 0~-0.015
φ7~φ17 : 0~-0.02



(mm)

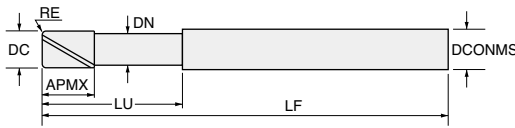

A タイプ
A type

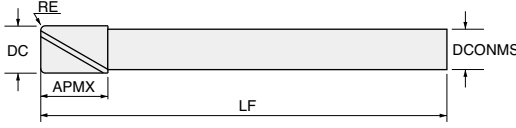

B タイプ
B type

EPPLS4



商品コード Item code	在庫 Stock	寸法 Size (mm)							形状 Shape	希望小売価格 (円) Suggested retail price(¥)
		外径 Tool dia. DC	コーナ半径 Corner radius RE	刃長 Flute length APMX	首径 Neck dia. DN	首下長 Under neck length LU	全長 Overall length LF	シャンク径 Shank dia. DCONMS		
EPPLS4030-02	●	3	0.2	4.5	2.9	10.5	80	6	A	17,570
EPPLS4030-05	●		0.5	4.5	2.9	10.5	80	6	A	17,570
EPPLS4040-02	●	4	0.2	6	3.8	14	80	6	A	18,330
EPPLS4040-05	●		0.5	6	3.8	14	80	6	A	18,330
EPPLS4050-02	●	5	0.2	7.5	4.8	17.5	100	6	A	22,110
EPPLS4050-05	●		0.5	7.5	4.8	17.5	100	6	A	22,110
EPPLS4060-03	●	6	0.3	9	-	-	120	5	B	25,030
EPPLS4060-05	●		0.5	9	-	-	120	5	B	25,030
EPPLS4060-10	●		1	9	-	-	120	5	B	25,030
EPPLS4070-03	●	7	0.3	9	-	-	120	6	B	25,030
EPPLS4070-05	●		0.5	9	-	-	120	6	B	25,030
EPPLS4070-10	●		1	9	-	-	120	6	B	25,030
EPPLS4080-05	●	8	0.5	12	-	-	135	7	B	30,750
EPPLS4080-10	●		1	12	-	-	135	7	B	30,750
EPPLS4080-15	●		1.5	12	-	-	135	7	B	30,750
EPPLS4090-05	●	9	0.5	12	-	-	135	8	B	30,750
EPPLS4090-10	●		1	12	-	-	135	8	B	30,750
EPPLS4090-15	●		1.5	12	-	-	135	8	B	30,750
EPPLS4100-05	●	10	0.5	15	-	-	150	9	B	41,300
EPPLS4100-10	●		1	15	-	-	150	9	B	41,300
EPPLS4100-15	●		1.5	15	-	-	150	9	B	41,300
EPPLS4110-05	●	11	0.5	15	-	-	150	10	B	41,300
EPPLS4110-10	●		1	15	-	-	150	10	B	41,300
EPPLS4110-15	●		1.5	15	-	-	150	10	B	41,300
EPPLS4120-05	●	12	0.5	18	-	-	160	11	B	51,850
EPPLS4120-10	●		1	18	-	-	160	11	B	51,850
EPPLS4120-15	●		1.5	18	-	-	160	11	B	51,850
EPPLS4120-20	●		2	18	-	-	160	11	B	51,850
EPPLS4130-05	●	13	0.5	18	-	-	160	12	B	61,360
EPPLS4130-10	●		1	18	-	-	160	12	B	61,360
EPPLS4130-15	●		1.5	18	-	-	160	12	B	61,360
EPPLS4130-20	●		2	18	-	-	160	12	B	61,360
EPPLS4160-10	●	16	1	24	-	-	180	15	B	114,370
EPPLS4160-15	●		1.5	24	-	-	180	15	B	114,370
EPPLS4160-20	●		2	24	-	-	180	15	B	114,370
EPPLS4170-10	●	17	1	24	-	-	180	16	B	114,370
EPPLS4170-15	●		1.5	24	-	-	180	16	B	114,370
EPPLS4170-20	●		2	24	-	-	180	16	B	114,370

● : 標準在庫品です。 □印 : 特定代理店在庫です。弊社営業へお問合せください
● : Stocked items. □ : Stocked by specified distributor. Contact with our sales department.

標準切削条件表 Recommended cutting conditions

EPP-CR
レギュラー刃長・コーナR付き
Regular, Corner radius

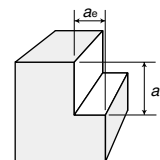

<側面切削> Side milling

被削材 Work material	鋳鉄 Cast irons (150~200HB) FC250		炭素鋼 Carbon steels (180~220HB) SS400, S50C		合金鋼 Alloy steels (200~250HB) SCM440, SNCM		ステンレス鋼・工具鋼 Stainless steels, Tool steels (25~35HRC) SUS304, SKD		プリハードン鋼 Pre-hardened steels (35~45HRC) HPM1, NAK55		焼入れ鋼 Hardened steels (45~55HRC) SKD61, SKT4		チタン合金 Titanium alloys Ti-6Al-4V		超耐熱合金 Super heat-resistant alloys Inconel Hasteloy		
	$a_p=1.5DC$ $a_e=0.1DC$		$a_p=1.5DC$ $a_e=0.1DC$		$a_p=1.5DC$ $a_e=0.1DC$		$a_p=1.5DC$ $a_e=0.1DC$		$a_p=1.5DC$ $a_e=0.1DC$		$a_p=1.5DC$ $a_e=0.05DC$		$a_p=1.5DC$ $a_e=0.05DC$		$a_p=1.5DC$ $a_e=0.05DC$		
外径DC Tool dia. (mm)	回転数 n (min^{-1})	送り速度 v_f (mm/min)	回転数 n (min^{-1})	送り速度 v_f (mm/min)	回転数 n (min^{-1})	送り速度 v_f (mm/min)	回転数 n (min^{-1})	送り速度 v_f (mm/min)	回転数 n (min^{-1})	送り速度 v_f (mm/min)	回転数 n (min^{-1})	送り速度 v_f (mm/min)	回転数 n (min^{-1})	送り速度 v_f (mm/min)	回転数 n (min^{-1})	送り速度 v_f (mm/min)	
高速条件 High speed	$\phi 3$	12,700	1,020	12,700	1,020	10,600	850	8,490	510	8,490	510	6,370	250	6,370	250	2,650	110
	$\phi 4$	9,550	1,150	9,550	1,150	7,960	960	6,370	640	6,370	640	4,770	380	4,770	380	1,990	160
	$\phi 5$	7,640	1,220	7,640	1,220	6,370	1,020	5,090	710	5,090	710	3,820	460	3,820	460	1,590	190
	$\phi 6$	6,370	1,270	6,370	1,270	5,310	1,060	4,240	680	4,240	680	3,180	450	3,180	450	1,330	190
	$\phi 8$	4,770	1,340	4,770	1,340	3,980	1,110	3,180	640	3,180	640	2,390	430	2,390	430	990	180
	$\phi 10$	3,820	1,220	3,820	1,220	3,180	1,020	2,550	610	2,550	610	1,910	420	1,910	420	800	180
	$\phi 12$	3,180	1,140	3,180	1,140	2,650	950	2,120	590	2,120	590	1,590	380	1,590	380	660	160
	$\phi 16$	2,390	960	2,390	960	1,990	800	1,590	540	1,590	540	1,190	330	1,190	330	500	140
$\phi 20$	1,910	920	1,910	920	1,590	760	1,270	510	1,270	510	950	300	950	300	400	130	
汎用条件 General	$\phi 3$	10,600	850	10,600	850	8,490	680	6,370	380	6,370	380	4,240	170	4,240	170	2,120	85
	$\phi 4$	7,960	960	7,960	960	6,370	760	4,770	480	4,770	480	3,180	250	3,180	250	1,590	130
	$\phi 5$	6,370	1,020	6,370	1,020	5,090	810	3,820	530	3,820	530	2,550	310	2,550	310	1,270	150
	$\phi 6$	5,310	1,060	5,310	1,060	4,240	850	3,180	510	3,180	510	2,120	300	2,120	300	1,060	150
	$\phi 8$	3,980	1,110	3,980	1,110	3,180	890	2,390	480	2,390	480	1,590	290	1,590	290	800	140
	$\phi 10$	3,180	1,020	3,180	1,020	2,550	820	1,910	460	1,910	460	1,270	280	1,270	280	640	140
	$\phi 12$	2,650	950	2,650	950	2,120	760	1,590	450	1,590	450	1,060	250	1,060	250	530	130
	$\phi 16$	1,990	800	1,990	800	1,590	640	1,190	400	1,190	400	800	220	800	220	400	110
$\phi 20$	1,590	760	1,590	760	1,270	610	950	380	950	380	640	200	640	200	320	100	

【注意】

- ① 切削方法は、ダウンカットで使用ください。
- ② 一般材、とくに高速切削は、乾式（エアブロー）またはオイルミストクーラントにてご使用ください。
- ③ ステンレス鋼および超耐熱合金には、不水溶性切削油のご使用が適しています。
- ④ 安定した切削を行うため、剛性の高い機械とセットアップでご使用ください。
- ⑤ 機械の回転数が足りない場合は、主軸回転数とテーブル送り速度を同比率で下げてください。
- ⑥ 加工形状、機械の剛性、工具突き出し量等、ご使用の状況により、主軸回転数とテーブル送り速度の調整を行ってください。

【Note】

- ① Down-cutting is recommended.
- ② Use generally dry (air-blow) or oil-mist coolant, especially at the high-speed machining.
- ③ Oil base coolant is recommended for machining stainless steels and heat-resistant alloys.
- ④ Use a machine tool with rigidity and rigid set-up, to machine stably.
- ⑤ When the revolution speed is not enough, reduce the revolution speed and table speed at the same ratio.
- ⑥ Adjust the revolution speed and table speed, according to cutting conditions such as machining shape, rigidity of machine tool, over-hang and so on.

Epoch Power Mill エポックパワーミル

超硬コーナースロットミル
リジッドアックスエポックミル

EPP-CR

レギュラー刃長・コーナー付き
Regular, Corner radius

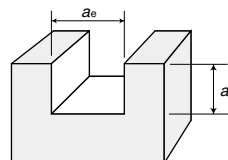

<溝切削> Slotting

被削材 Work material	鋳鉄 Cast irons (150~200HB) FC250		炭素鋼 Carbon steels (180~220HB) SS400, S50C		合金鋼 Alloy steels (200~250HB) SCM440, SNCM		ステンレス鋼・工具鋼 Stainless steels, Tool steels (25~35HRC) SUS304, SKD		プリハードン鋼 Pre-hardened steels (35~45HRC) HPM1, NAK55		焼入れ鋼 Hardened steels (45~55HRC) SKD61, SKT4		チタン合金 Titanium alloys Ti-6Al-4V		超耐熱合金 Super heat-resistant alloys Inconel Hasteloy			
	切込み Depth of cut (mm)	$a_p \leq 0.5DC$ $a_e = 1DC$	$a_p \leq 0.5DC$ $a_e = 1DC$	$a_p \leq 0.5DC$ $a_e = 1DC$	$a_p \leq 0.5DC$ $a_e = 1DC$	$a_p \leq 0.2DC$ $a_e = 1DC$	$a_p \leq 0.2DC$ $a_e = 1DC$	$a_p \leq 0.2DC$ $a_e = 1DC$	$a_p \leq 0.2DC$ $a_e = 1DC$	$a_p \leq 0.2DC$ $a_e = 1DC$	$a_p \leq 0.2DC$ $a_e = 1DC$	$a_p \leq 0.2DC$ $a_e = 1DC$	$a_p \leq 0.2DC$ $a_e = 1DC$	$a_p \leq 0.2DC$ $a_e = 1DC$	$a_p \leq 0.2DC$ $a_e = 1DC$	$a_p \leq 0.2DC$ $a_e = 1DC$		
高速条件 High speed	外径DC Tool dia. (mm)	回転数 n (min^{-1})	送り速度 V_f (mm/min)	回転数 n (min^{-1})	送り速度 V_f (mm/min)	回転数 n (min^{-1})	送り速度 V_f (mm/min)	回転数 n (min^{-1})	送り速度 V_f (mm/min)	回転数 n (min^{-1})	送り速度 V_f (mm/min)	回転数 n (min^{-1})	送り速度 V_f (mm/min)	回転数 n (min^{-1})	送り速度 V_f (mm/min)	回転数 n (min^{-1})	送り速度 V_f (mm/min)	
	$\phi 3$	5,310	420	8,490	680	7,430	590	5,310	320	5,310	320							
	$\phi 4$	3,980	480	6,370	760	5,570	670	3,980	400	3,980	400							
	$\phi 5$	3,180	510	5,090	810	4,460	710	3,180	450	3,180	450							
	$\phi 6$	2,650	530	4,240	850	3,710	740	2,650	420	2,650	420							
	$\phi 8$	1,990	560	3,180	890	2,790	780	1,990	400	1,990	400							
	$\phi 10$	1,590	510	2,550	820	2,230	710	1,590	380	1,590	380							
	$\phi 12$	1,330	480	2,120	760	1,860	670	1,330	370	1,330	370							
	$\phi 16$	990	400	1,590	640	1,390	560	990	340	990	340							
	$\phi 20$	800	380	1,270	610	1,110	530	800	320	800	320							
汎用条件 General	切込み Depth of cut (mm)	$a_p \leq 1DC$ $a_e = 1DC$	$a_p \leq 1DC$ $a_e = 1DC$	$a_p \leq 1DC$ $a_e = 1DC$	$a_p \leq 1DC$ $a_e = 1DC$	$a_p \leq 0.5DC$ $a_e = 1DC$	$a_p \leq 0.5DC$ $a_e = 1DC$	$a_p \leq 0.5DC$ $a_e = 1DC$	$a_p \leq 0.5DC$ $a_e = 1DC$	$a_p \leq 0.2DC$ $a_e = 1DC$	$a_p \leq 0.2DC$ $a_e = 1DC$	$a_p \leq 0.2DC$ $a_e = 1DC$	$a_p \leq 0.2DC$ $a_e = 1DC$	$a_p \leq 0.2DC$ $a_e = 1DC$	$a_p \leq 0.2DC$ $a_e = 1DC$	$a_p \leq 0.2DC$ $a_e = 1DC$	$a_p \leq 0.2DC$ $a_e = 1DC$	
	$\phi 3$	3,180	250	7,430	590	5,310	420	4,240	250	4,240	250	2,120	85	3,180	130	1,590	65	
	$\phi 4$	2,390	290	5,570	670	3,980	480	3,180	320	3,180	320	1,590	130	2,390	190	1,190	95	
	$\phi 5$	1,910	310	4,460	710	3,180	510	2,550	360	2,550	360	1,270	150	1,910	230	950	110	
	$\phi 6$	1,590	320	3,710	740	2,650	530	2,120	340	2,120	340	1,060	150	1,590	220	800	110	
	$\phi 8$	1,190	330	2,790	780	1,990	560	1,590	320	1,590	320	800	140	1,190	210	600	110	
	$\phi 10$	950	300	2,230	710	1,590	510	1,270	300	1,270	300	640	140	950	210	480	110	
	$\phi 12$	800	290	1,860	670	1,330	480	1,060	300	1,060	300	530	130	800	190	400	95	
	$\phi 16$	600	240	1,390	560	990	400	800	270	800	270	400	110	600	170	300	85	
	$\phi 20$	480	230	1,110	530	800	380	640	260	640	260	320	100	480	150	240	75	

【注意】

- ① 一般材、とくに高速切削は、乾式（エアブロー）またはオイルミストクーラントにてご使用ください。
- ② ステンレス鋼および超耐熱合金には、不水溶性切削油のご使用が適しています。
- ③ 安定した切削を行うため、剛性の高い機械とセットアップでご使用ください。
- ④ 機械の回転数が足りない場合は、主軸回転数とテーブル送り速度を同比率で下げてください。
- ⑤ 加工形状、機械の剛性、工具突き出し量等、ご使用の状況により、主軸回転数とテーブル送り速度の調整を行ってください。

【Note】

- ① Use generally dry (air-blow) or oil-mist coolant, especially at the high-speed machining.
- ② Oil base coolant is recommended for machining stainless steels and heat-resistant alloys.
- ③ Use a machine tool with rigidity and rigid set-up, to machine stably.
- ④ When the revolution speed is not enough, reduce the revolution speed and table speed at the same ratio.
- ⑤ Adjust the revolution speed and table speed, according to cutting conditions such as machining shape, rigidity of machine tool, over-hang and so on.

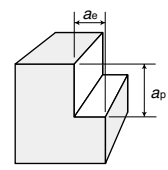

EPPL-CR
ロング刃長・コーナーR付き
Long, Corner radius

<側面切削> Side milling

被削材 Work material	鋳鉄 Cast irons (150~200HB) FC250		炭素鋼 Carbon steels (180~220HB) SS400, S50C		合金鋼 Alloy steels (200~250HB) SCM440, SNCM		ステンレス鋼・工具鋼 Stainless steels, Tool steels (25~35HRC) SUS304, SKD		プリハードン鋼 Pre-hardened steels (35~45HRC) HPM1, NAK55		焼入れ鋼 Hardened steels (45~55HRC) SKD61, SKT4		チタン合金 Titanium alloys Ti-6Al-4V		超耐熱合金 Super heat-resistant alloys Inconel Hasteloy	
	切込み Depth of cut (mm) $a_p=3DC$ $a_e=0.02DC$		$a_p=3DC$ $a_e=0.02DC$		$a_p=3DC$ $a_e=0.02DC$		$a_p=3DC$ $a_e=0.02DC$		$a_p=3DC$ $a_e=0.02DC$		$a_p=3DC$ $a_e=0.01DC$		$a_p=3DC$ $a_e=0.01DC$		$a_p=3DC$ $a_e=0.01DC$	
外径DC Tool dia. (mm)	回転数 n (min ⁻¹)	送り速度 V_f (mm/min)	回転数 n (min ⁻¹)	送り速度 V_f (mm/min)	回転数 n (min ⁻¹)	送り速度 V_f (mm/min)	回転数 n (min ⁻¹)	送り速度 V_f (mm/min)	回転数 n (min ⁻¹)	送り速度 V_f (mm/min)	回転数 n (min ⁻¹)	送り速度 V_f (mm/min)	回転数 n (min ⁻¹)	送り速度 V_f (mm/min)	回転数 n (min ⁻¹)	送り速度 V_f (mm/min)
φ6	2,650	530	2,650	530	2,120	420	1,590	250	1,590	250	1,060	150	1,060	150	530	75
φ8	1,990	560	1,990	560	1,590	450	1,190	240	1,190	240	800	140	800	140	400	70
φ10	1,590	510	1,590	510	1,270	410	950	230	950	230	640	140	640	140	320	70
φ12	1,330	480	1,330	480	1,060	380	800	220	800	220	530	130	530	130	270	65
φ16	990	400	990	400	800	320	600	200	600	200	400	110	400	110	200	55
φ20	800	380	800	380	640	310	480	190	480	190	320	100	320	100	160	50

EPPLS-CR
ロングシャンク・コーナーR付き
Long Shank, Corner radius

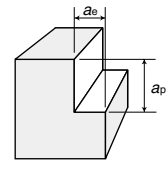

<側面切削> Side milling

被削材 Work material	鋳鉄 Cast irons (150~200HB) FC250		炭素鋼 Carbon steels (180~220HB) SS400, S50C		合金鋼 Alloy steels (200~250HB) SCM440, SNCM		ステンレス鋼・工具鋼 Stainless steels, Tool steels (25~35HRC) SUS304, SKD		プリハードン鋼 Pre-hardened steels (35~45HRC) HPM1, NAK55		焼入れ鋼 Hardened steels (45~55HRC) SKD61, SKT4		チタン合金 Titanium alloys Ti-6Al-4V		超耐熱合金 Super heat-resistant alloys Inconel Hasteloy	
	切込み Depth of cut (mm) $a_p=1.5DC$ $a_e=0.1DC$		$a_p=1.5DC$ $a_e=0.1DC$		$a_p=1.5DC$ $a_e=0.1DC$		$a_p=1.5DC$ $a_e=0.1DC$		$a_p=1.5DC$ $a_e=0.1DC$		$a_p=1.5DC$ $a_e=0.05DC$		$a_p=1.5DC$ $a_e=0.05DC$		$a_p=1.5DC$ $a_e=0.05DC$	
外径DC Tool dia. (mm)	回転数 n (min ⁻¹)	送り速度 V_f (mm/min)	回転数 n (min ⁻¹)	送り速度 V_f (mm/min)	回転数 n (min ⁻¹)	送り速度 V_f (mm/min)	回転数 n (min ⁻¹)	送り速度 V_f (mm/min)	回転数 n (min ⁻¹)	送り速度 V_f (mm/min)	回転数 n (min ⁻¹)	送り速度 V_f (mm/min)	回転数 n (min ⁻¹)	送り速度 V_f (mm/min)	回転数 n (min ⁻¹)	送り速度 V_f (mm/min)
φ3	5,310	420	5,310	420	4,240	340	3,180	190	3,180	190	2,120	85	2,120	85	1,060	42
φ4	3,980	480	3,980	480	3,180	380	2,390	240	2,390	240	1,590	130	1,590	130	800	65
φ5	3,180	510	3,180	510	2,550	410	1,910	270	1,910	270	1,270	150	1,270	150	640	75
φ6	2,650	530	2,650	530	2,120	420	1,590	250	1,590	250	1,060	150	1,060	150	530	75
φ8	1,990	560	1,990	560	1,590	450	1,190	240	1,190	240	800	140	800	140	400	70
φ10	1,590	510	1,590	510	1,270	410	950	230	950	230	640	140	640	140	320	70
φ12	1,330	480	1,330	480	1,060	380	800	220	800	220	530	130	530	130	270	65
φ16	990	400	990	400	800	320	600	200	600	200	400	110	400	110	200	55

【注意】

- ① 切削方法は、ダウンカットで使用ください。
- ② 一般材、とくに高速切削は、乾式（エアブロー）またはオイルミストクーラントにてご使用ください。
- ③ ステンレス鋼および超耐熱合金には、不水溶性切削油のご使用が適しています。
- ④ 安定した切削を行うため、剛性の高い機械とセットアップでご使用ください。
- ⑤ 機械の回転数が足りない場合は、主軸回転数とテーブル送り速度を同比率で下げてください。
- ⑥ 加工形状、機械の剛性、工具突き出し量等、ご使用の状況により、主軸回転数とテーブル送り速度の調整を行ってください。

【Note】

- ① Down-cutting is recommended.
- ② Use generally dry (air-blow) or oil-mist coolant, especially at the high-speed machining.
- ③ Oil base coolant is recommended for machining stainless steels and heat-resistant alloys.
- ④ Use a machine tool with rigidity and rigid set-up, to machine stably.
- ⑤ When the revolution speed is not enough, reduce the revolution speed and table speed at the same ratio.
- ⑥ Adjust the revolution speed and table speed, according to cutting conditions such as machining shape, rigidity of machine tool, over-hang and so on.

8-flutes End Mill for Vertical Wall/Bottom Face Finishing 立壁／底面仕上げ用8枚刃エンドミル



立壁と底面の仕上げ加工の“極”これ1本で立壁と底面を仕上げる!!
The Zenith of Milling for Vertical Wall and Bottom Face Finishing
Vertical wall and bottom face finishing with a single tool!

外径公差
φ6 : 0~-0.015
φ7~φ12 : 0~-0.02

h5 h6
φ6,8,10,12 φ7,9,11

(mm)

スクエアはA344頁を参照してください
Please refer to page A344 for Square

8枚刃
8 Flutes

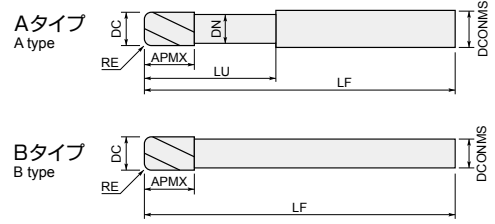

ER8WB LN(LS)-R-ATH



商品コード Item code	在庫 Stock	寸法 Size(mm)							形状 Shape	希望小売価格 Suggested retail price(¥)
		外径 Tool dia.	コーナ半径 Corner radius	刃長 Flute length	首下長 Under neck length	首径 Neck dia.	全長 Overall length	シャンク径 Shank dia.		
		DC	RE	APMX	LU	DN	LF	DCONMS		
ER8WB0600LN-20-R1.0-ATH	●	6	1	7	20	5.88	70	6	A	17,070
ER8WB0600LN-30-R1.0-ATH	●		1	7	30	5.88	80	6	A	17,750
ER8WB0600LN-40-R1.0-ATH	●		1	7	40	5.88	90	6	A	18,460
ER8WB0600LN-50-R1.0-ATH	●		1	7	50	5.88	100	6	A	19,180
ER8WB0700LS-R1.0-ATH	●	7	1	8	-	-	90	6	B	25,630
ER8WB0800LN-30-R1.0-ATH	●	8	1	9	30	7.84	75	8	A	18,870
ER8WB0800LN-40-R1.0-ATH	●		1	9	40	7.84	90	8	A	20,010
ER8WB0800LN-50-R1.0-ATH	●		1	9	50	7.84	100	8	A	20,890
ER8WB0800LN-60-R1.0-ATH	●		1	9	60	7.84	110	8	A	22,360
ER8WB0900LS-R1.0-ATH	●	9	1	10	-	-	100	8	B	29,230
ER8WB1000LN-35-R1.0-ATH	●	10	1	11	35	9.8	80	10	A	22,420
ER8WB1000LN-50-R1.0-ATH	●		1	11	50	9.8	100	10	A	24,580
ER8WB1000LN-60-R1.0-ATH	●		1	11	60	9.8	110	10	A	26,140
ER8WB1000LN-80-R1.0-ATH	●		1	11	80	9.8	130	10	A	28,480
ER8WB1100LS-R1.0-ATH	●	11	1	12	-	-	110	10	B	34,930
ER8WB1200LN-40-R1.0-ATH	●	12	1	13	40	11.8	90	12	A	27,370
ER8WB1200LN-60-R1.0-ATH	●		1	13	60	11.8	110	12	A	30,340
ER8WB1200LN-80-R1.0-ATH	●		1	13	80	11.8	130	12	A	32,970
ER8WB1200LN-100-R1.0-ATH	●		1	13	100	11.8	150	12	A	35,600

対応被削材 Applicable work material								
炭素鋼 合金鋼 Carbon steel Alloy steel	プリハードン鋼 Pre-hardened steel	高硬度 Hardened steel			ステンレス鋼 Stainless steel	チタン合金 耐熱合金 Titanium alloy Heat-resistant alloy	銅合金 Copper alloy	アルミ合金 Aluminum alloy
○	◎	> 45HRC ≤ 55HRC	> 55HRC ≤ 65HRC	> 65HRC				

再研磨対応外径範囲 Re-grinding compatibility range		
商品コード Item code	外周 Outer dia. (mm)	エンド End (mm)
ER8WB-ATH	6 ~ 12	6 ~ 12

● : 標準在庫品です。 ● : Stocked items.

標準切削条件表 Recommended cutting conditions

ER8WB-ATH

立壁仕上げ

Vertical wall finishing

被削材 Work material			炭素鋼・合金鋼 Carbon steels, Alloy steels (180~250HB)		工具鋼 Tool steels (25~35HRC)		プリハードン鋼 Pre-hardened steels (35~45HRC)		焼入れ鋼 Hardened steels (45~55HRC)		焼入れ鋼 Hardened steels (55~62HRC)	
商品コード Item code	軸切込み ap (mm)	径切込み ae (mm)	回転数 n (min ⁻¹)	送り速度 vf (mm/min)	回転数 n (min ⁻¹)	送り速度 vf (mm/min)	回転数 n (min ⁻¹)	送り速度 vf (mm/min)	回転数 n (min ⁻¹)	送り速度 vf (mm/min)	回転数 n (min ⁻¹)	送り速度 vf (mm/min)
ER8WB0600LN-20-R1.0-ATH	3	≦0.1	7960	1910	6370	1530	4770	1140	3180	760	2650	640
ER8WB0600LN-30-R1.0-ATH	3	≦0.1	6630	1590	5310	1270	3980	960	2650	640	2120	510
ER8WB0600LN-40-R1.0-ATH	3	≦0.1	4640	780	3710	620	2790	470	1860	310	1490	250
ER8WB0600LN-50-R1.0-ATH	3	≦0.1	3320	400	2650	320	1990	240	1330	160	1060	130
ER8WB0700LS-R1.0-ATH	3.5	≦0.1	5680	1590	4550	1270	3410	950	2270	640	1820	510
ER8WB0800LN-30-R1.0-ATH	4	≦0.1	5970	1910	4770	1530	3580	1150	2390	760	1990	640
ER8WB0800LN-40-R1.0-ATH	4	≦0.1	4970	1590	3980	1270	2980	950	1990	640	1590	510
ER8WB0800LN-50-R1.0-ATH	4	≦0.1	3480	890	2790	620	2090	540	1390	360	1110	280
ER8WB0800LN-60-R1.0-ATH	4	≦0.1	2490	400	1990	320	1490	240	990	160	800	130
ER8WB0900LS-R1.0-ATH	4.5	≦0.1	4420	1590	3540	1270	2650	950	1770	640	1410	510
ER8WB1000LN-35-R1.0-ATH	5	≦0.1	4770	1910	3820	1530	2860	1140	1910	760	1590	640
ER8WB1000LN-50-R1.0-ATH	5	≦0.1	3980	1590	3180	1270	2390	960	1590	640	1270	510
ER8WB1000LN-60-R1.0-ATH	5	≦0.1	2790	890	2230	620	1670	530	1110	360	890	280
ER8WB1000LN-80-R1.0-ATH	5	≦0.1	1990	400	1590	320	1190	240	800	160	640	130
ER8WB1100LS-R1.0-ATH	5.5	≦0.1	3620	1510	2890	1210	2170	910	1450	610	1160	480
ER8WB1200LN-40-R1.0-ATH	6	≦0.1	3980	1720	3180	1370	2390	1030	1590	690	1330	570
ER8WB1200LN-60-R1.0-ATH	6	≦0.1	3320	1430	2650	1140	1990	860	1330	570	1060	460
ER8WB1200LN-80-R1.0-ATH	6	≦0.1	2320	700	1860	560	1390	420	930	280	740	220
ER8WB1200LN-100-R1.0-ATH	6	≦0.1	1660	360	1330	290	990	210	660	140	530	110

※ロングシャンクタイプ(φ7.9, 11)の切削条件は工具突き出し量が5DC(工具径×5倍)時の条件です。突き出し量を変更する場合は下記補正値を参考に条件を設定ください。
* Cutting conditions for the long-shank type (φ7.9/11) are for a tool projection of 5DC (tool diameter × 5). Modify the conditions using the following correction factors if the projection amount changes.

ロングシャンクタイプの切削条件補正値 Cutting condition correction factors for long-shank type (%)

被削材 Work material			炭素鋼・合金鋼 Carbon steels, Alloy steels (180~250HB)		工具鋼 Tool steels (25~35HRC)		プリハードン鋼 Pre-hardened steels (35~45HRC)		焼入れ鋼 Hardened steels (45~55HRC)		焼入れ鋼 Hardened steels (55~62HRC)	
突き出し量 Projection	軸切込み ap (mm)	径切込み ae (mm)	回転数 n (min ⁻¹)	送り速度 vf (mm/min)	回転数 n (min ⁻¹)	送り速度 vf (mm/min)	回転数 n (min ⁻¹)	送り速度 vf (mm/min)	回転数 n (min ⁻¹)	送り速度 vf (mm/min)	回転数 n (min ⁻¹)	送り速度 vf (mm/min)
5DC	100%	100%	100%	100%	100%	100%	100%	100%	100%	100%	100%	100%
6DC	100%	100%	70%	60%	70%	60%	70%	60%	70%	60%	70%	60%
7DC	100%	100%	70%	50%	70%	50%	70%	50%	70%	50%	70%	50%

- [注意]** ①被削材、加工形状に合わせて、適切なクーラントを使用してください。
②できるだけ高剛性、高精度の機械をご使用ください。
③この切削条件表は切削条件の目安を示すものです。実際の加工では加工形状、目的、使用機械等により条件を調整してください。
④機械の回転数が足りない場合は、回転数と送り速度を同じ比率で下げてください。

- [Note]** ① Use the appropriate coolant for the work material and machining shape.
② Use a highly rigid and accurate machine as possible.
③ These Recommended Cutting Conditions indicate only the rule of a thumb for the cutting conditions. In actual machining, the condition should be adjusted according to the machining shape, purpose and the machine type.
④ If the rpm available is lower than that recommended please reduce the feed rate to the same ratio.

8-flutes End Mill for Vertical Wall/Bottom Face Finishing

立壁／底面仕上げ用8枚刃エンドミル

ER8WB-ATH

底面仕上げ

Bottom face finishing

※底面仕上げはラジアスタイプ(ER8WB-ATH)をご使用ください。A radius type (ER8WB-ATH) should be used for bottom face finishing.

被削材 Work material			炭素鋼・合金鋼 Carbon steels, Alloy steels (180~250HB)		工具鋼 Tool steels (25~35HRC)		プリハードン鋼 Pre-hardened steels (35~45HRC)		焼入れ鋼 Hardened steels (45~55HRC)		焼入れ鋼 Hardened steels (55~62HRC)	
商品コード Item code	軸切込み ap (mm)	径切込み ae (mm)	回転数 n (min ⁻¹)	送り速度 vf (mm/min)	回転数 n (min ⁻¹)	送り速度 vf (mm/min)	回転数 n (min ⁻¹)	送り速度 vf (mm/min)	回転数 n (min ⁻¹)	送り速度 vf (mm/min)	回転数 n (min ⁻¹)	送り速度 vf (mm/min)
ER8WB0600LN-20-R1.0-ATH	0.05~0.1	3~6	9550	2290	7960	1910	6370	1530	4770	1140	3180	760
ER8WB0600LN-30-R1.0-ATH	0.05~0.1	3~6	7960	1910	6630	1590	5310	1270	3980	960	2650	640
ER8WB0600LN-40-R1.0-ATH	0.05~0.1	3~6	5570	940	4640	780	3710	620	2790	470	1860	310
ER8WB0600LN-50-R1.0-ATH	0.05~0.1	3~6	3980	480	3320	400	2650	320	1990	240	1330	160
ER8WB0700LS-R1.0-ATH	0.05~0.1	3.5~7	6820	1910	5680	1590	4550	1270	3410	950	2270	640
ER8WB0800LN-30-R1.0-ATH	0.05~0.1	4~8	7160	2290	5970	1910	4770	1530	3580	1150	2390	760
ER8WB0800LN-40-R1.0-ATH	0.05~0.1	4~8	5970	1910	4970	1590	3980	1270	2980	950	1990	640
ER8WB0800LN-50-R1.0-ATH	0.05~0.1	4~8	4180	1070	3480	890	2790	710	2090	540	1390	360
ER8WB0800LN-60-R1.0-ATH	0.05~0.1	4~8	2980	480	2490	400	1990	320	1490	240	990	160
ER8WB0900LS-R1.0-ATH	0.05~0.1	4.5~9	5310	1910	4420	1590	3540	1270	2650	950	1770	640
ER8WB1000LN-35-R1.0-ATH	0.05~0.1	5~10	5730	2290	4770	1910	3820	1530	2860	1140	1910	760
ER8WB1000LN-50-R1.0-ATH	0.05~0.1	5~10	4770	1910	3980	1590	3180	1270	2390	960	1590	640
ER8WB1000LN-60-R1.0-ATH	0.05~0.1	5~10	3340	1070	2790	890	2230	710	1670	530	1110	360
ER8WB1000LN-80-R1.0-ATH	0.05~0.1	5~10	2390	480	1990	400	1590	320	1190	240	800	160
ER8WB1100LS-R1.0-ATH	0.05~0.1	5.5~11	4340	1810	3620	1510	2890	1210	2170	910	1450	610
ER8WB1200LN-40-R1.0-ATH	0.05~0.1	6~12	4770	2060	3980	1720	3180	1370	2390	1030	1590	690
ER8WB1200LN-60-R1.0-ATH	0.05~0.1	6~12	3980	1720	3320	1430	2650	1140	1990	860	1330	570
ER8WB1200LN-80-R1.0-ATH	0.05~0.1	6~12	2790	840	2320	700	1860	560	1390	420	930	280
ER8WB1200LN-100-R1.0-ATH	0.05~0.1	6~12	1990	430	1660	360	1330	290	990	210	660	140

※ロングシャックタイプ(φ7,9,11)の切削条件は工具突き出し量が5DC(工具径×5倍)時の条件です。突き出し量を変更する場合は下記補正値を参考に条件を設定ください。
* Cutting conditions for the long-shank type (φ7/9/11) are for a tool projection of 5DC (tool diameter × 5). Modify the conditions using the following correction factors if the projection amount changes:

ロングシャックタイプの切削条件補正値 Cutting condition correction factors for long-shank type (%)

被削材 Work material			炭素鋼・合金鋼 Carbon steels, Alloy steels (180~250HB)		工具鋼 Tool steels (25~35HRC)		プリハードン鋼 Pre-hardened steels (35~45HRC)		焼入れ鋼 Hardened steels (45~55HRC)		焼入れ鋼 Hardened steels (55~62HRC)	
突出し量 Projection	軸切込み ap (mm)	径切込み ae (mm)	回転数 n (min ⁻¹)	送り速度 vf (mm/min)	回転数 n (min ⁻¹)	送り速度 vf (mm/min)	回転数 n (min ⁻¹)	送り速度 vf (mm/min)	回転数 n (min ⁻¹)	送り速度 vf (mm/min)	回転数 n (min ⁻¹)	送り速度 vf (mm/min)
5DC	100%	100%	100%	100%	100%	100%	100%	100%	100%	100%	100%	100%
6DC	100%	100%	70%	60%	70%	60%	70%	60%	70%	60%	70%	60%
7DC	100%	100%	70%	50%	70%	50%	70%	50%	70%	50%	70%	50%

- 【注意】**
- ①被削材、加工形状に合わせて、適切なクーラントを使用してください。
 - ②できるだけ高剛性、高精度の機械をご使用ください。
 - ③この切削条件表は切削条件の目安を示すものです。実際の加工では加工形状、目的、使用機械等により条件を調整してください。
 - ④機械の回転数が足りない場合は、回転数と送り速度を同じ比率で下げてください。
 - ⑤溝切削の場合、送り速度を50%を目安に調整してください。
 - ⑥傾斜切削の場合、傾斜角は0.5°以下、送り速度を50%を目安に調整してください。

- 【Note】**
- ① Use the appropriate coolant for the work material and machining shape.
 - ② Use a highly rigid and accurate machine as possible.
 - ③ These Recommended Cutting Conditions indicate only the rule of a thumb for the cutting conditions. In actual machining, the condition should be adjusted according to the machining shape, purpose and the machine type.
 - ④ If the rpm available is lower than that recommended please reduce the feed rate to the same ratio.
 - ⑤ For slotting, adjust the feed rate to 50% as general criteria.
 - ⑥ For ramping, adjust the ramp angle to 0.5° or less and the feed rate to 50% as general criteria.

End mill for adaptive milling 高能率側面切削用エンドミル



首下 3.5DCタイプ Under neck 3.5DC type

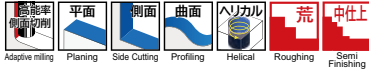

外径公差 Dia. tolerance
 $\phi 6$: 0 ~ -0.015
 $\phi 8 \sim \phi 20$: 0 ~ -0.02



(mm)

5枚刃
5 Flutes



負荷制御ツールパスとの組合せで高能率な加工を実現!
 Enables high-efficiency machining in conjunction with adaptive milling tool paths!

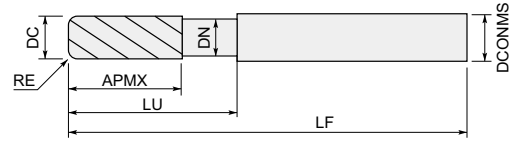

ER5HS-○-PN

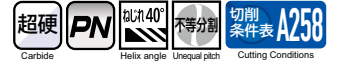

商品コード Item code	在庫 Stock	寸法 Size(mm)							希望小売価格 Suggested retail price(¥)
		外径 Tool dia.	コーナ半径 Corner radius	刃長 Flute length	首下長 Under neck length	首径 Neck dia.	全長 Overall length	シャンク径 Shank dia.	
		DC	RE	APMX	LU	DN	LF	DCONMS	
ER5HS06-PN	●	6	0.5	18	21	5.5	60	6	13,140
ER5HS08-PN	●	8	1.0	24	28	7.3	75	8	15,380
ER5HS10-PN	●	10	1.0	30	35	9.2	80	10	19,870
ER5HS12-PN	●	12	1.0	36	42	11	100	12	23,910
ER5HS16-PN	●	16	1.0	48	56	14.7	110	16	51,600
ER5HS20-PN	●	20	1.0	60	70	18.4	125	20	71,900

首下 5DCタイプ Under neck 5DC type

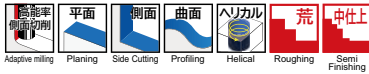

外径公差 Dia. tolerance
 $\phi 6$: 0 ~ -0.015
 $\phi 8 \sim \phi 20$: 0 ~ -0.02



(mm)

5枚刃
5 Flutes

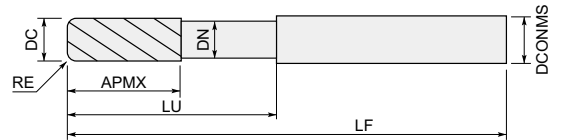

ER5HS-○-○-PN

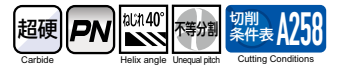

商品コード Item code	在庫 Stock	寸法 Size(mm)							希望小売価格 Suggested retail price(¥)
		外径 Tool dia.	コーナ半径 Corner radius	刃長 Flute length	首下長 Under neck length	首径 Neck dia.	全長 Overall length	シャンク径 Shank dia.	
		DC	RE	APMX	LU	DN	LF	DCONMS	
ER5HS06-30-PN	●	6	0.5	18	30	5.5	70	6	14,480
ER5HS08-40-PN	●	8	1.0	24	40	7.3	80	8	16,960
ER5HS10-50-PN	●	10	1.0	30	50	9.2	100	10	21,880
ER5HS12-60-PN	●	12	1.0	36	60	11	120	12	26,260
ER5HS16-80-PN	●	16	1.0	48	80	14.7	135	16	58,100
ER5HS20-100-PN	●	20	1.0	60	100	18.4	155	20	84,000

○ 対応被削材 Applicable work material

炭素鋼 合金鋼 Carbon steel Alloy steel	プリハードン鋼 Pre-hardened steel ≤ 45HRC	高硬度 Hardened steel			ステンレス鋼 Stainless steel	チタン合金 耐熱合金 Titanium alloy Heat-resistant alloy	銅合金 Copper alloy	アルミ合金 Aluminum alloy
		> 45HRC ≤ 55HRC	> 55HRC ≤ 65HRC	> 65HRC				
○	○				○	○		

○ : 標準在庫品です。 ● : Stocked items.

○ 再研磨対応外径範囲 Re-grinding compatibility range

商品コード Item code	外周 Outer dia. (mm)	エンド End (mm)
ER5HS-PN	6 ~ 20	6 ~ 20

End mill for adaptive milling 高能率側面切削用エンドミル

標準切削条件表 Recommended cutting conditions ER5HS-3.5DC-PN ER5HS-5DC-PN

標準切削条件 Recommended cutting conditions

被削材 Work material	炭素鋼・合金鋼 Carbon steels, Alloy steels (~30HRC)		プリハードン鋼 Pre-hardened steels (30~40HRC)		ステンレス鋼 Stainless steels	
切削速度 Cutting speed	vc=150m/min		vc=100m/min		vc=150m/min	
切込み Depth of cut (mm)	ap=3DC-1mm, ae=0.08DC		ap=3DC-1mm, ae=0.08DC		ap=3DC-1mm, ae=0.06DC	
外径DC Tool dia.(mm)	回転数 n (min ⁻¹)	送り速度 vf (mm/min)	回転数 n (min ⁻¹)	送り速度 vf (mm/min)	回転数 n (min ⁻¹)	送り速度 vf (mm/min)
6	7,960	3,980	5,310	2,655	7,960	3,180
8	5,970	2,985	3,980	1,990	5,970	2,390
10	4,775	2,865	3,185	1,910	4,775	2,390
12	3,980	2,390	2,660	1,600	3,980	1,990
16	2,990	1,500	1,990	1,000	2,990	1,200
20	2,390	1,200	1,600	800	2,390	960

首下5DC切削条件 (標準切削条件に対する割合) Under neck 5DC cutting conditions (as percentage of recommended cutting conditions)

被削材 Work material	炭素鋼・合金鋼 Carbon steels, Alloy steels (~30HRC)			プリハードン鋼 Pre-hardened steels (30~40HRC)			ステンレス鋼 Stainless steels		
割合 Percentage	回転数 n (min ⁻¹)	送り速度 vf (mm/min)	径方向切込み ae (mm)	回転数 n (min ⁻¹)	送り速度 vf (mm/min)	径方向切込み ae (mm)	回転数 n (min ⁻¹)	送り速度 vf (mm/min)	径方向切込み ae (mm)
	100%	100%	60%	100%	50%	75%	100%	100%	50%

apは標準切削条件を参考に調整ください。切削条件例 炭素鋼：φ10 n=4,775min⁻¹ vf=2,865mm/min ap=29mm ae=0.48mm
Adjust ap by referring to the recommended cutting conditions. Example of carbon steel:

高速切削条件 (首下3.5DCのみ) High-speed cutting conditions (under neck 3.5DC only)

被削材 Work material	炭素鋼・合金鋼 Carbon steels, Alloy steels (~30HRC)		プリハードン鋼 Pre-hardened steels (30~40HRC)	
切削速度 Cutting speed	vc=200m/min		vc=150m/min	
切込み Depth of cut (mm)	ap=3DC-1mm, ae=0.08DC		ap=3DC-1mm, ae=0.08DC	
外径DC Tool dia.(mm)	回転数 n (min ⁻¹)	送り速度 vf (mm/min)	回転数 n (min ⁻¹)	送り速度 vf (mm/min)
6	10,610	5,300	7,960	3,980
8	7,960	4,000	5,970	2,985
10	6,370	3,820	4,775	2,865
12	5,310	3,190	3,980	2,390
16	3,980	2,000	2,990	1,500
20	3,185	1,600	2,390	1,200

ステンレス鋼の高速切削は推奨いたしません。High-speed cutting is not recommended with stainless steel.

【注意】

- ①できるだけ高剛性の機械をご使用ください。
※φ16以上の工具を使用する際はBT50クラス以上の高剛性の機械をご使用ください。
- ②閉塞域が多い切削ではコレットスルーエアなど、ホルダー端面からのクーラント供給をご使用ください。
- ③被削材、加工形状に合わせて、適切なクーラントを使用してください。
- ④この切削条件表は切削条件の目安を示すものです。実際の加工では加工形状、目的、使用機械等により条件を調整してください。
- ⑤機械の回転数が足りない場合には、回転数と送り速度を同じ比率で下げてください。
- ⑥彫り込み時の傾斜進入角度は推奨1°として送り速度は上記の50~60%で設定ください。
また、回転数が調整可能な場合はvc=100m/min程度に設定ください。

【Note】

- ① Use a highly rigid machine as possible.
※When using φ16 or larger tools, use a BT50-class or higher high-rigidity machine.
- ② Supply coolant from the holder end face (using a through-collet air supply, for example) when cutting work material with many enclosed areas.
- ③ Use the appropriate coolant for the work material and machining shape.
- ④ These Recommended Cutting Conditions indicate only the rule of a thumb for the cutting conditions. In actual machining, the condition should be adjusted according to the machining shape, purpose and the machine type.
- ⑤ If the rpm available is lower than that recommended please reduce the feed rate to the same ratio.
- ⑥ The recommended ramping angle for helical interpolation is 1°. Set the feed rate to between 50% and 60% of the values indicated above. Additionally, where this can be adjusted, set the rotation speed to around vc = 100 m/min.

クーラントについて Coolant

クーラントノズル Coolant nozzle

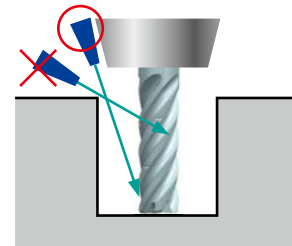

クーラントノズルをご使用される際は、クーラントが底まで当たる位置にクーラントノズルを設定してください。またクーラント圧は切りくずが排出されるように調整してください。設定が悪い場合は切りくず詰まりによる刃先損傷や工具折損を引き起こす可能性があります。

When using a coolant nozzle, arrange the coolant nozzle so that the coolant hits the end of the tool. Adjust the coolant pressure required to discharge the chips. Insufficient pressure may result in edge damage or tool breakage due to chip clogging.

コレットスルーなどの端面供給 End feed using through-collet supply

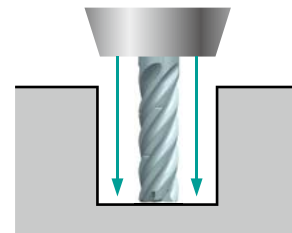

コレットスルーなどを使用することで、切りくずの排出が良好となり、刃先損傷や工具折損を低減します。

Using a through-collet coolant feed improves chip discharge and reduces edge damage and tool breakage.

Epoch Mirus Type R エポックミルス タイプ R

4枚刃・ラジアス・ストレート・3DC 4 flutes, Radius, Straight, 3DC

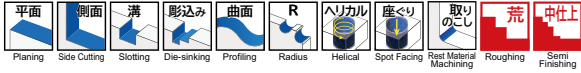

外径公差 Dia.tolerance 0~-0.05



(mm)

高切り込み&高送りにより驚異の加工能率を実現。

Achieves amazing machining efficiency with high cutting depth and high feed rate.

スクエアはA346頁を参照してください
Please refer to page A346 for Square

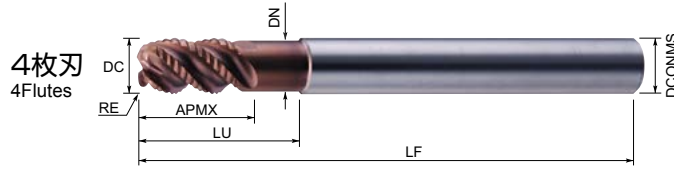

EMXR4-TH 3DC

超硬 Carbide RTH 45° Helix angle 切削条件表 A261 Cutting Conditions

商品コード Item code	在庫 Stock	寸法 Size (mm)							刃数 No. of flutes	希望小売価格 (円) Suggested retail price(¥)
		外径 Tool dia. DC	刃長 Flute length APMX	コーナ半径 Corner radius RE	首径 Neck dia. DN	首下長 Under neck length LU	全長 Overall length LF	シャンク径 Shank dia. DCONMS		
EMXR4060-18-15-TH	●	6	9	1.5	5.5	18	60	6	4	20,650
EMXR4080-24-20-TH	●	8	12	2	7.3	24	75	8	4	25,250
EMXR4100-30-20-TH	●	10	15	2	9.1	30	80	10	4	33,440
EMXR4120-36-20-TH	●	12	18	2	11	36	100	12	4	42,310

4枚刃・ラジアス・ストレート・5DC 4 flutes, Radius, Straight, 5DC

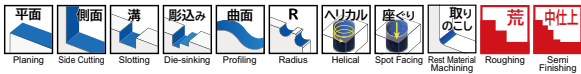

外径公差 Dia.tolerance 0~-0.05



(mm)

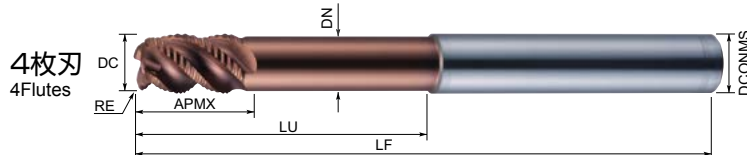

EMXR4-TH 5DC

超硬 Carbide RTH 45° Helix angle 切削条件表 A261 Cutting Conditions

商品コード Item code	在庫 Stock	寸法 Size (mm)							刃数 No. of flutes	希望小売価格 (円) Suggested retail price(¥)
		外径 Tool dia. DC	刃長 Flute length APMX	コーナ半径 Corner radius RE	首径 Neck dia. DN	首下長 Under neck length LU	全長 Overall length LF	シャンク径 Shank dia. DCONMS		
EMXR4060-30-15-TH	●	6	9	1.5	5.5	30	75	6	4	22,680
EMXR4080-40-20-TH	●	8	12	2	7.3	40	85	8	4	27,830
EMXR4100-50-20-TH	●	10	15	2	9.1	50	100	10	4	36,810
EMXR4120-60-20-TH	●	12	18	2	11	60	110	12	4	46,570

EMXR-3DC-TH、EMXR-5DC-THの対応被削材

Applicable work material of EMXR-3DC-TH, EMXR-5DC-TH

炭素鋼 合金鋼 Carbon steel Alloy steel	プリハードン鋼 Pre-hardened steel	高硬度 Hardened steel			ステンレス鋼 Stainless steel	チタン合金 耐熱合金 Titanium alloy Heat-resistant alloy	銅合金 Copper alloy	アルミ 合金 Aluminum alloy
○	○	> 45HRC ≤ 55HRC	> 55HRC ≤ 65HRC	> 65HRC	○	○	○	

○：標準在庫品です。●：Stocked items.

再研磨対応外径範囲

Re-grinding compatibility range

商品コード Item code	外周 Outer dia. (mm)	エンド End (mm)
EMXR-3DC-TH	6 ~ 12	6 ~ 12
EMXR-5DC-TH	6 ~ 12	6 ~ 12

Carbide End Mills
Radius End Mills

Epoch Mirus Type N エポックミルス タイプ N

高切り込み&高送りにより驚異の加工能力を実現。
Achieves amazing machining efficiency with high cutting depth and high feed rate.

4枚刃・ラジアス・ストレート・3DC 4 flutes, Radius, Straight, 3DC

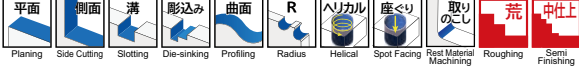

スクエアはA347 頁を参照してください
Please refer to page A347 for Square

外径公差
Dia. tolerance
0~-0.03

h5

(mm)

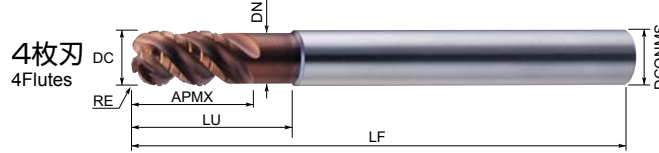

EMXN4-TH 3DC

超硬 Carbide ATH 刃角 45° Helix angle 切削条件表 A261 Cutting Conditions

商品コード Item code	在庫 Stock	寸法 Size (mm)							刃数 No. of flutes	希望小売価格 (円) Suggested retail price(¥)
		外径 Tool dia. DC	刃長 Flute length APMX	コーナ半径 Corner radius RE	首径 Neck dia. DN	首下長 Under neck length LU	全長 Overall length LF	シャンク径 Shank dia. DCONMS		
EMXN4060-18-05-TH	●	6	9	0.5	5.5	18	60	6	4	20,650
EMXN4060-18-15-TH	●		9	1.5	5.5	18	60	6	4	20,650
EMXN4080-24-05-TH	●	8	12	0.5	7.3	24	75	8	4	25,250
EMXN4080-24-20-TH	●		12	2	7.3	24	75	8	4	25,250
EMXN4100-30-05-TH	●	10	15	0.5	9.1	30	80	10	4	33,440
EMXN4100-30-20-TH	●		15	2	9.1	30	80	10	4	33,440
EMXN4120-36-05-TH	●	12	18	0.5	11	36	100	12	4	42,310
EMXN4120-36-20-TH	●		18	2	11	36	100	12	4	42,310

4枚刃・ラジアス・ストレート・5DC 4 flutes, Radius, Straight, 5DC

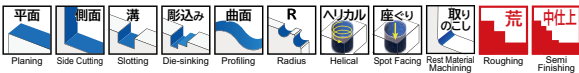

外径公差
Dia. tolerance
0~-0.03

h5

(mm)

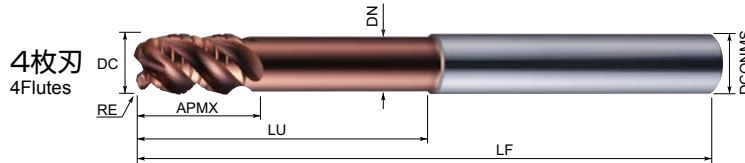

EMXN4-TH 5DC

超硬 Carbide ATH 刃角 45° Helix angle 切削条件表 A262 Cutting Conditions

商品コード Item code	在庫 Stock	寸法 Size (mm)							刃数 No. of flutes	希望小売価格 (円) Suggested retail price(¥)
		外径 Tool dia. DC	刃長 Flute length APMX	コーナ半径 Corner radius RE	首径 Neck dia. DN	首下長 Under neck length LU	全長 Overall length LF	シャンク径 Shank dia. DCONMS		
EMXN4060-30-15-TH	●	6	9	1.5	5.5	30	75	6	4	22,680
EMXN4080-40-20-TH	●	8	12	2	7.3	40	85	8	4	27,830
EMXN4100-50-20-TH	●	10	15	2	9.1	50	100	10	4	36,810
EMXN4120-60-20-TH	●	12	18	2	11	60	110	12	4	46,570

EMXN-3DC-TH、EMXN-5DC-THの対応被削材

Applicable work material of EMXN-3DC-TH, EMXR-5DC-TH

炭素鋼 合金鋼 Carbon steel Alloy steel	プリハー ド鋼 Pre-hardened steel	高硬度 Hardened steel			ステン レス鋼 Stainless steel	チタン合金 耐熱合金 Titanium alloy Heat-resistant alloy	銅合金 Copper alloy	アルミ 合金 Aluminum alloy
○	○	> 45HRC ≤ 55HRC	> 55HRC ≤ 65HRC	> 65HRC	○	○	○	

再研磨対応外径範囲

Re-grinding compatibility range

商品コード Item code	外周 Outer dia. (mm)	エンド End (mm)
EMXN-3DC-TH	6 ~ 12	6 ~ 12
EMXN-5DC-TH	6 ~ 12	6 ~ 12

Epoch Mirus Type R/Type N エポックミルス タイプR/タイプN

標準切削条件表 Recommended cutting conditions

EMXR-CR-TH EMXN-CR-TH 4枚刃・ラジアス・ストレート 4 flutes, Radius, Straight, 3D

3DC

側面切削 Side milling

タイプ Type R	工具鋼 Tool steels (25~35HRC) SKD				プリハードン鋼 Pre-hardened steels (35~45HRC) NAK80, CENA1		焼入れ鋼 Hardened steels (45~55HRC) SKD61, SKT4		タイプN Type N		工具鋼 Tool steels (25~35HRC) SKD		ステンレス鋼 Stainless steels SUS		プリハードン鋼 Pre-hardened steels (35~45HRC) NAK80, CENA1		焼入れ鋼 Hardened steels (45~55HRC) SKD61, SKT4	
	切削深み Depth of cut (mm)		最大 $a_e=0.5DC$		最大 $a_e=0.375DC$		最大 $a_e=0.25DC$		最大 $a_e=0.5DC$		最大 $a_e=0.375DC$		最大 $a_e=0.375DC$		最大 $a_e=0.25DC$		最大 $a_e=0.125DC$	
外径DC Tool dia.(mm)	回転数 n min ⁻¹	送り速度 v_f mm/min	回転数 n min ⁻¹	送り速度 v_f mm/min	回転数 n min ⁻¹	送り速度 v_f mm/min	回転数 n min ⁻¹	送り速度 v_f mm/min	回転数 n min ⁻¹	送り速度 v_f mm/min	回転数 n min ⁻¹	送り速度 v_f mm/min	回転数 n min ⁻¹	送り速度 v_f mm/min	回転数 n min ⁻¹	送り速度 v_f mm/min	回転数 n min ⁻¹	送り速度 v_f mm/min
φ6	8,000	1,380	7,200	1,000	6,400	710	5,600	500	7,400	1,280	6,600	910	6,600	270	5,800	640	5,000	440
φ8	6,000	1,460	5,400	1,050	4,800	750	4,200	520	5,600	1,360	5,000	970	5,000	290	4,400	680	3,800	470
φ10	4,800	1,460	4,300	1,050	3,800	740	3,300	510	4,500	1,370	4,000	970	4,000	290	3,500	680	3,000	470
φ12	4,000	1,380	3,600	1,000	3,200	710	2,800	500	3,700	1,280	3,300	910	3,300	270	2,900	640	2,500	440

溝切削 Slotting

タイプ Type R	工具鋼 Tool steels (25~35HRC) SKD				プリハードン鋼 Pre-hardened steels (35~45HRC) NAK80, CENA1		焼入れ鋼 Hardened steels (45~55HRC) SKD61, SKT4		タイプN Type N		工具鋼 Tool steels (25~35HRC) SKD		ステンレス鋼 Stainless steels SUS		プリハードン鋼 Pre-hardened steels (35~45HRC) NAK80, CENA1		焼入れ鋼 Hardened steels (45~55HRC) SKD61, SKT4		
	切削深み Depth of cut (mm)		最大 $a_p=1.0DC$		最大 $a_p=0.8DC$		最大 $a_p=0.5DC$		最大 $a_p=0.2DC$		最大 $a_p=1.0DC$		最大 $a_p=0.8DC$		最大 $a_p=0.8DC$		最大 $a_p=0.5DC$		最大 $a_p=0.2DC$
外径DC Tool dia.(mm)	回転数 n min ⁻¹	送り速度 v_f mm/min	回転数 n min ⁻¹	送り速度 v_f mm/min	回転数 n min ⁻¹	送り速度 v_f mm/min	回転数 n min ⁻¹	送り速度 v_f mm/min	回転数 n min ⁻¹	送り速度 v_f mm/min	回転数 n min ⁻¹	送り速度 v_f mm/min	回転数 n min ⁻¹	送り速度 v_f mm/min	回転数 n min ⁻¹	送り速度 v_f mm/min	回転数 n min ⁻¹	送り速度 v_f mm/min	
φ6	6,900	950	6,100	670	5,300	470	4,500	320	6,400	880	5,600	620	5,600	190	4,800	420	4,000	280	
φ8	5,200	1,010	4,600	720	4,000	500	3,400	340	4,800	930	4,200	650	4,200	200	3,600	450	3,000	300	
φ10	4,100	1,000	3,700	720	3,200	500	2,700	340	3,800	920	3,300	640	3,300	190	2,900	450	2,400	300	
φ12	3,400	940	3,100	690	2,700	480	2,300	330	3,200	880	2,800	620	2,800	190	2,400	420	2,000	280	

傾斜切削 Ramping

タイプ Type R	工具鋼 Tool steels (25~35HRC) SKD				プリハードン鋼 Pre-hardened steels (35~45HRC) NAK80, CENA1		焼入れ鋼 Hardened steels (45~55HRC) SKD61, SKT4		タイプN Type N		工具鋼 Tool steels (25~35HRC) SKD		ステンレス鋼 Stainless steels SUS		プリハードン鋼 Pre-hardened steels (35~45HRC) NAK80, CENA1		焼入れ鋼 Hardened steels (45~55HRC) SKD61, SKT4	
	最大傾斜角 Max. ramping angle		30°以下 30° or less		15°以下 15° or less		5°以下 5° or less		20°以下 20° or less		10°以下 10° or less		5°以下 5° or less		10°以下 10° or less		5°以下 5° or less	
外径DC Tool dia.(mm)	回転数 n min ⁻¹	送り速度 v_f mm/min	回転数 n min ⁻¹	送り速度 v_f mm/min	回転数 n min ⁻¹	送り速度 v_f mm/min	回転数 n min ⁻¹	送り速度 v_f mm/min	回転数 n min ⁻¹	送り速度 v_f mm/min	回転数 n min ⁻¹	送り速度 v_f mm/min	回転数 n min ⁻¹	送り速度 v_f mm/min	回転数 n min ⁻¹	送り速度 v_f mm/min	回転数 n min ⁻¹	送り速度 v_f mm/min
φ6	6,900	750	6,100	530	5,300	370	4,500	250	6,400	690	5,600	480	5,600	140	4,800	330	4,000	220
φ8	5,200	790	4,600	560	4,000	390	3,400	260	4,800	730	4,200	510	4,200	150	3,600	350	3,000	230
φ10	4,100	780	3,700	560	3,200	390	2,700	260	3,800	720	3,300	500	3,300	150	2,900	350	2,400	230
φ12	3,400	730	3,100	540	2,700	370	2,300	250	3,200	690	2,800	480	2,800	140	2,400	330	2,000	220

往復食い加工 Two-way profiling

タイプ Type R	工具鋼 Tool steels (25~35HRC) SKD				プリハードン鋼 Pre-hardened steels (35~45HRC) NAK80, CENA1		焼入れ鋼 Hardened steels (45~55HRC) SKD61, SKT4		タイプN Type N		工具鋼 Tool steels (25~35HRC) SKD		ステンレス鋼 Stainless steels SUS		プリハードン鋼 Pre-hardened steels (35~45HRC) NAK80, CENA1		焼入れ鋼 Hardened steels (45~55HRC) SKD61, SKT4		
	切削深み Depth of cut (mm)		最大 $a_e=0.5DC$		最大 $a_e=0.375DC$		最大 $a_e=0.25DC$		最大 $a_e=0.125DC$		最大 $a_e=0.5DC$		最大 $a_e=0.375DC$		最大 $a_e=0.375DC$		最大 $a_e=0.25DC$		最大 $a_e=0.125DC$
外径DC Tool dia.(mm)	回転数 n min ⁻¹	送り速度 v_f mm/min	回転数 n min ⁻¹	送り速度 v_f mm/min	回転数 n min ⁻¹	送り速度 v_f mm/min	回転数 n min ⁻¹	送り速度 v_f mm/min	回転数 n min ⁻¹	送り速度 v_f mm/min	回転数 n min ⁻¹	送り速度 v_f mm/min	回転数 n min ⁻¹	送り速度 v_f mm/min	回転数 n min ⁻¹	送り速度 v_f mm/min	回転数 n min ⁻¹	送り速度 v_f mm/min	
φ6	8,000	1,730	7,200	1,240	6,400	880	5,600	620	7,400	1,600	6,600	1,140	6,600	340	5,800	800	5,000	550	
φ8	6,000	1,820	5,400	1,310	4,800	930	4,200	650	5,600	1,700	5,000	1,220	5,000	370	4,400	860	3,800	590	
φ10	4,800	1,820	4,300	1,310	3,800	920	3,300	640	4,500	1,710	4,000	1,220	4,000	370	3,500	850	3,000	580	
φ12	4,000	1,730	3,600	1,240	3,200	880	2,800	620	3,700	1,600	3,300	1,140	3,300	340	2,900	800	2,500	550	

【注意】 ご使用にあたっては、次ページの表下の項目と注意を参照してください。【Note】 Upon usage, please refer to comments and notes below table on next page.

主軸別 使用領域概念図

Cutting condition adjustment based on spindle type

標準切削条件はBT50相当の主軸での切削条件です。
主軸剛性の弱い機械では右記の図を参考に切り込み量を調整してください。

Standard cutting condition is for BT50 class spindle situation.
Please adjust the step according to right chart.

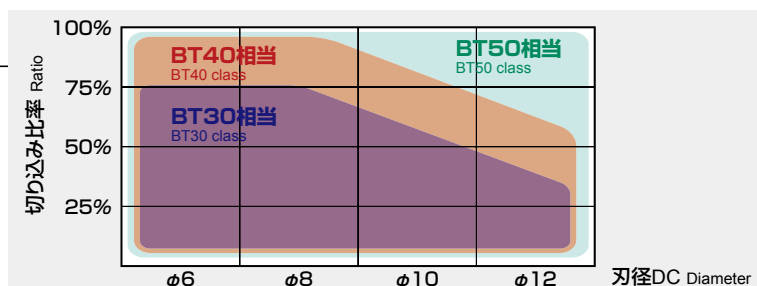

EMXR-CR-TH EMXN-CR-TH 4枚刃・ラジアス・ストレート 4 flutes, Radius, Straight, 5DC

5DC

側面切削 Side milling

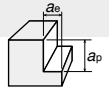

タイプR Type R				タイプN Type N				
材料	工具鋼	プリハードン鋼	焼入れ鋼	材料	工具鋼	ステンレス鋼	プリハードン鋼	焼入れ鋼
Cast iron, Carbon steels, Alloy steels (150~250HB) FC, S50C, SCM	Tool steels (25~35HRC) SKD	Pre-hardened steels (35~45HRC) NAK80, CENA1	Hardened steels (45~55HRC) SKD61, SKT4	Cast iron, Carbon steels, Alloy steels (150~250HB) FC, S50C, SCM	Tool steels (25~35HRC) SKD	Stainless steels SUS	Pre-hardened steels (35~45HRC) NAK80, CENA1	Hardened steels (45~55HRC) SKD61, SKT4
切込み Depth of cut (mm)	$a_p=0.7DC$ $a_e=0.35DC$		$a_p=0.7DC$ $a_e=0.26DC$		$a_p=0.7DC$ $a_e=0.175DC$		$a_p=0.7DC$ $a_e=0.087DC$	
外径DC Tool dia.(mm)	回転数 n min ⁻¹	送り速度 v mm/min	回転数 n min ⁻¹	送り速度 v mm/min	回転数 n min ⁻¹	送り速度 v mm/min	回転数 n min ⁻¹	送り速度 v mm/min
φ6	5,600	970	4,800	660	4,000	440	3,200	280
φ8	4,200	1,020	3,600	700	3,000	470	2,400	300
φ10	3,300	1,000	2,900	710	2,400	470	1,900	300
φ12	2,800	970	2,400	660	2,000	440	1,600	280

溝切削 Slotting

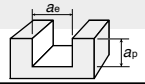

タイプR Type R				タイプN Type N				
材料	工具鋼	プリハードン鋼	焼入れ鋼	材料	工具鋼	ステンレス鋼	プリハードン鋼	焼入れ鋼
Cast iron, Carbon steels, Alloy steels (150~250HB) FC, S50C, SCM	Tool steels (25~35HRC) SKD	Pre-hardened steels (35~45HRC) NAK80, CENA1	Hardened steels (45~55HRC) SKD61, SKT4	Cast iron, Carbon steels, Alloy steels (150~250HB) FC, S50C, SCM	Tool steels (25~35HRC) SKD	Stainless steels SUS	Pre-hardened steels (35~45HRC) NAK80, CENA1	Hardened steels (45~55HRC) SKD61, SKT4
切込み Depth of cut (mm)	$a_p=0.7DC$		$a_p=0.56DC$		$a_p=0.35DC$		$a_p=0.14DC$	
外径DC Tool dia.(mm)	回転数 n min ⁻¹	送り速度 v mm/min	回転数 n min ⁻¹	送り速度 v mm/min	回転数 n min ⁻¹	送り速度 v mm/min	回転数 n min ⁻¹	送り速度 v mm/min
φ6	4,200	580	3,400	380	2,700	240	1,900	130
φ8	3,200	620	2,600	400	2,000	250	1,400	140
φ10	2,500	610	2,100	410	1,600	250	1,100	140
φ12	2,100	580	1,700	380	1,300	230	900	130

傾斜切削 Ramping



タイプR Type R				タイプN Type N				
材料	工具鋼	プリハードン鋼	焼入れ鋼	材料	工具鋼	ステンレス鋼	プリハードン鋼	焼入れ鋼
Cast iron, Carbon steels, Alloy steels (150~250HB) FC, S50C, SCM	Tool steels (25~35HRC) SKD	Pre-hardened steels (35~45HRC) NAK80, CENA1	Hardened steels (45~55HRC) SKD61, SKT4	Cast iron, Carbon steels, Alloy steels (150~250HB) FC, S50C, SCM	Tool steels (25~35HRC) SKD	Stainless steels SUS	Pre-hardened steels (35~45HRC) NAK80, CENA1	Hardened steels (45~55HRC) SKD61, SKT4
最大傾斜角 Max. ramping angle	30°以下 30° or less		15°以下 15° or less		15°以下 15° or less		5°以下 5° or less	
外径DC Tool dia.(mm)	回転数 n min ⁻¹	送り速度 v mm/min	回転数 n min ⁻¹	送り速度 v mm/min	回転数 n min ⁻¹	送り速度 v mm/min	回転数 n min ⁻¹	送り速度 v mm/min
φ6	4,800	520	4,000	350	3,200	220	2,400	130
φ8	3,600	550	3,000	360	2,400	230	1,800	140
φ10	2,900	550	2,400	360	1,900	230	1,400	140
φ12	2,400	520	2,000	350	1,600	220	1,200	130

往復食い加工 Two-way profiling



タイプR Type R				タイプN Type N				
材料	工具鋼	プリハードン鋼	焼入れ鋼	材料	工具鋼	ステンレス鋼	プリハードン鋼	焼入れ鋼
Cast iron, Carbon steels, Alloy steels (150~250HB) FC, S50C, SCM	Tool steels (25~35HRC) SKD	Pre-hardened steels (35~45HRC) NAK80, CENA1	Hardened steels (45~55HRC) SKD61, SKT4	Cast iron, Carbon steels, Alloy steels (150~250HB) FC, S50C, SCM	Tool steels (25~35HRC) SKD	Stainless steels SUS	Pre-hardened steels (35~45HRC) NAK80, CENA1	Hardened steels (45~55HRC) SKD61, SKT4
切込み Depth of cut (mm)	最大max. $a_e=0.35DC$		最大max. $a_e=0.26DC$		最大max. $a_e=0.175DC$		最大max. $a_e=0.087DC$	
外径DC Tool dia.(mm)	回転数 n min ⁻¹	送り速度 v mm/min	回転数 n min ⁻¹	送り速度 v mm/min	回転数 n min ⁻¹	送り速度 v mm/min	回転数 n min ⁻¹	送り速度 v mm/min
φ6	5,600	1,210	4,800	830	4,000	550	3,200	350
φ8	4,200	1,280	3,600	880	3,000	580	2,400	370
φ10	3,300	1,250	2,900	880	2,400	580	1,900	370
φ12	2,800	1,210	2,400	830	2,000	550	1,600	350

※タイプRはステンレス鋼及びチタン合金に推奨できません。

※Type R is not recommendable for milling stainless steel or Ti alloy.

【特長】 本工具を用いると、図①に示すような形状から、往復食い加工を行うことが可能です。図①形状の切削条件は側面切削条件を参照ください。

Features MIRUS has the capability of two-way profiling a work from geometry as figure 1 shown. Please refer to side milling cutting conditions for previous process.

- 【注意】**
- ① ラジスタタイプではZ突込み加工は出来ません。
 - ② できるだけ高剛性、高精度の機械をご使用ください。
 - ③ この切削条件表は切削条件の目安を示すものです。実際の加工では加工形状、目的、使用機械等により条件を調整してください。
 - ④ 機械の回転数が足りない場合には、回転数と送り速度を同じ比率で下げてください。
 - ⑤ エアブローやクーラントの位置に十分ご注意ください。
 - ⑥ 使用条件(コレット等)によっては、工具が抜ける恐れがありますので、機械・ホルダーの種類によって、条件を調整してください。

- Note**
- ① Radius type is not recommendable for Z plunging.
 - ② Use a highly rigid and accurate machine as possible.
 - ③ These conditions are for general guidance; in actual machining conditions adjust the parameters according to your actual machine and work-piece conditions.
 - ④ If the rpm available is lower than that recommended please reduce the feed rate to the same ratio.
 - ⑤ Please ensure that air blow or coolant is correctly positioned in order to remove the chip immediately.
 - ⑥ In order to avoid clamping looseness, Please adjust cutting conditions according to type of machine center and holder.

Epoch High Hard Radius エポックハイハードラジラス

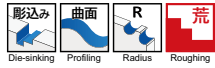

外径公差 Dia. tolerance	0 ~ -0.02	h5	D CONMS ≤ 6 : 0 ~ -0.005 6 < D CONMS ≤ 10 : 0 ~ -0.006 10 < D CONMS : 0 ~ -0.008	(mm)
------------------------	-----------	----	--	------

刃先交換式高送り工具をソリッド化、高硬度鋼の高送り加工が可能です。
Adopt the design of indexable high-feed cutter to solid end mill.
High feed cutting for high hardness steel possible

4,6枚刃
4,6 Flutes

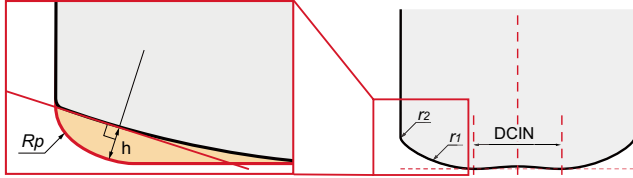

Aタイプ
A type

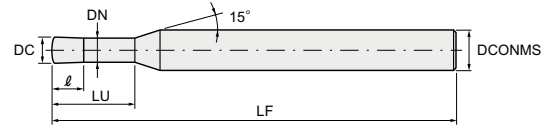

Bタイプ
B type



EHHRE(-S)-TH3



商品コード Item code	在庫 Stock	寸法 Size (mm)										刃数 No. of flutes	形状 Type	希望小売 価格(円) Suggested retail price (¥)	
		外径 Tool dia.	近似R Approx radius	先端フラット径 Lowest point diameter	底R End R	コーナR Corner radius	首下長 Under Neck length	刃長 Flute length	首径 Neck dia.	全長 Overall Length	シャンク径 Shank dia.				DCONMS
		DC	Rp	DCIN	r1	r2	LU	ℓ	DN	LF	DCONMS				
EHHRE4010-S4-TH3	●	1	0.134	0.28	1.1	0.1	3	1	0.95	50	4	4	A	11,250	
EHHRE4010-S6-TH3	●							1							6
EHHRE4020-S4-TH3	●	2	0.194	0.56	2.2	0.1	6	2	1.9	50	4	4	A	11,900	
EHHRE4020-S6-TH3	●							2							6
EHHRE4030-S4-TH3	●	3	0.328	0.84	3.3	0.2	9	3	2.9	60	4	4	A	12,540	
EHHRE4030-S6-TH3	●							3							6
EHHRE6040-S4-TH3	●	4	0.387	1.12	4.4	0.2	12	4	3.9	60	4	6	B	12,540	
EHHRE6040-S6-TH3	●							4							6
EHHRE6050-TH3	●	5	0.521	1.4	5.5	0.3	15	5	4.7	60	6	6	A	15,600	
EHHRE6060-TH3	●	6	0.581	1.68	6.6	0.3	18	6	5.7	60	6	6	B	16,500	
EHHRE6080-TH3	●	8	0.849	2.24	8.8	0.5	24	8	7.6	75	8	6	B	21,550	
EHHRE6100-TH3	●	10	0.968	2.8	11	0.5	30	10	9.5	80	10	6	B	27,490	
EHHRE6120-TH3	●	12	1.088	3.36	13.2	0.5	36	12	11.5	100	12	6	B	35,690	

加工プログラム作成上の注意点 Precaution for creating machining program

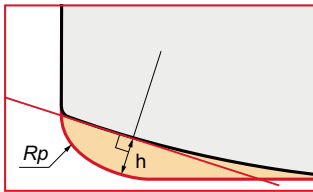

- CAMでラジラスエンドミルとして寸法値を入力する場合は、コーナR値は近似Rを使用してください
- 工具形状データが必要な場合は、弊社ホームページのTool SearchよりDXFデータをダウンロードしてください

- When entering corner radius into CAM as radius end mill, Please use approximate R for your programming corner radius.
- For precise tool definition for the CAM system please download DXF data from "TOOL SEARCH" program on our website.

【注意】

- 本工具は工具形状が通常のラジラス工具とは異なるため、工具自動測定の際は、調整が必要になる場合があります。測定機の機種によっては、正確に測定出来ない場合がありますので、工具形状をDXFにて確認頂きご使用下さい。
- Since the shape of this tool is different from that of a conventional radius tool, adjustment may be required in case of using automatic tool measurement equipment. Depending on the model of the measuring equipment, it may not be possible to measure accurately, so please check the tool shape with DXF before use.

外径 DC Tool Dia.	CAM入力近似Rと最大削り残り量 Approx radius and maximum remains at CAM input		傾斜切削の 最大傾斜角 θ Ramping angle	加工可能な ヘリカル穴径 D Possible helical hole dia.
	近似R Rp Approx radius	最大削り残り量 h Max remains		
Φ1	0.134	0.026	0.5° 以下 0.5° or less	1.3~1.9
Φ2	0.194	0.068		2.6~3.8
Φ3	0.328	0.094		3.9~5.7
Φ4	0.387	0.136		5.2~7.6
Φ5	0.521	0.162		6.4~9.5
Φ6	0.581	0.204		7.7~11.4
Φ8	0.849	0.255		10.3~15.2
Φ10	0.968	0.34		12.8~19.0
Φ12	1.088	0.424		15.4~22.8

※ヘリカル加工を行う場合は送り速度を標準切削条件の70%に設定してください。
For helical machining, Please set feed rate to 70% of recommended cutting condition.

対応被削材 Applicable work material

炭素鋼 合金鋼 Carbon steel Alloy steel	プリハードン 鋼 Pre-hardened steel	高硬度 Hardened steel			ステン レス鋼 Stainless steel	チタン合金 耐熱合金 Titanium alloy Heat-resistant alloy	銅合金 Copper alloy	アルミ 合金 Aluminum alloy
○	○	> 45HRC ≤ 55HRC	> 55HRC ≤ 65HRC	> 65HRC	○	○	○	○

○ : 標準在庫品です。 ● : Stocked items.

再研磨対応外径範囲 Re-grinding compatibility range

商品コード Item code	外周 Outer dia. (mm)	エンド End (mm)
EHHRE-TH3	× (N/A)	2 ~ 12

標準切削条件表 Recommended cutting conditions

EHHRE-TH3

超硬工具
リジッドエポック
ミッドエポック
ソフトエポック

一般切削条件 (寿命重視)
General cutting conditions (Emphasis on tool life)

被削材 Work material		焼入れ鋼 Hardened steels (50~55HRC) ※1				焼入れ鋼 Hardened steels (55~62HRC)				
外径DC Tool dia. (mm)	刃数 No. of flutes	切削速度 Cutting speed $v_c=80\text{m/min}$				切削速度 Cutting speed $v_c=60\text{m/min}$				
		n (min ⁻¹)	V_f (mm/min)	a_p (mm)	a_e (mm)	n (min ⁻¹)	V_f (mm/min)	a_p (mm)	a_e (mm)	
1	4	25,500	3,670	0.040	0.55	19,100	1,720	0.023	0.55	
2		12,700	3,660	0.080	1.1	9,600	1,730	0.046	1.1	
3		8,500	3,840	0.120	1.65	6,400	1,800	0.069	1.65	
4		6,400	5,840	0.160	2.2	4,800	2,740	0.092	2.2	
5	6	5,100	5,940	0.200	2.75	3,800	2,760	0.115	2.75	
6		4,200	5,870	0.240	3.3	3,200	2,790	0.138	3.3	
8		3,200	6,140	0.320	4.4	2,400	2,880	0.184	4.4	
10		2,500	6,000	0.400	5.5	1,900	2,850	0.230	5.5	
12		2,100	5,750	0.480	6.6	1,600	2,740	0.276	6.6	
被削材 Work material		焼入れ鋼 Hardened steels (62~66HRC)				焼入れ鋼 Hardened steels (66~72HRC)				
外径DC Tool dia. (mm)		刃数 No. of flutes	切削速度 Cutting speed $v_c=50\text{m/min}$				切削速度 Cutting speed $v_c=40\text{m/min}$			
			n (min ⁻¹)	V_f (mm/min)	a_p (mm)	a_e (mm)	n (min ⁻¹)	V_f (mm/min)	a_p (mm)	a_e (mm)
1	4	15,900	1,070	0.019	0.55	12,700	570	0.013	0.5	
2		8,000	1,080	0.038	1.1	6,400	580	0.026	1	
3		5,300	1,120	0.057	1.65	4,200	590	0.039	1.5	
4		4,000	1,710	0.076	2.2	3,200	910	0.052	2	
5	6	3,200	1,750	0.095	2.75	2,500	910	0.065	2.5	
6		2,700	1,770	0.114	3.3	2,100	920	0.078	3	
8		2,000	1,800	0.152	4.4	1,600	960	0.104	4	
10		1,600	1,800	0.190	5.5	1,300	980	0.130	5	
12		1,300	1,670	0.228	6.6	1,100	940	0.156	6	

高能率切削条件 (能率重視)
Cutting conditions for high-efficiency cutting (Emphasis on efficiency)

被削材 Work material		焼入れ鋼 Hardened steels (50~55HRC) ※1				焼入れ鋼 Hardened steels (55~62HRC)				
外径DC Tool dia. (mm)	刃数 No. of flutes	切削速度 Cutting speed $v_c=100\text{m/min}$				切削速度 Cutting speed $v_c=70\text{m/min}$				
		n (min ⁻¹)	V_f (mm/min)	a_p (mm)	a_e (mm)	n (min ⁻¹)	V_f (mm/min)	a_p (mm)	a_e (mm)	
1	4	31,880	4,730	0.038	0.7	22,280	2,070	0.022	0.7	
2		15,880	4,710	0.076	1.4	11,200	2,080	0.044	1.4	
3		10,630	4,940	0.114	2.1	7,470	2,170	0.066	2.1	
4		8,000	7,510	0.152	2.8	5,600	3,290	0.087	2.8	
5	6	6,380	7,650	0.190	3.5	4,430	3,320	0.109	3.5	
6		5,250	7,550	0.228	4.2	3,730	3,350	0.131	4.2	
8		4,000	7,910	0.304	5.6	2,800	3,460	0.175	5.6	
10		3,130	7,740	0.380	7	2,220	3,430	0.219	7	
12		2,630	7,410	0.456	8.4	1,870	3,290	0.262	8.4	
被削材 Work material		焼入れ鋼 Hardened steels (62~66HRC)				焼入れ鋼 Hardened steels (66~72HRC)				
外径DC Tool dia. (mm)		刃数 No. of flutes	切削速度 Cutting speed $v_c=60\text{m/min}$				切削速度 Cutting speed $v_c=50\text{m/min}$			
			n (min ⁻¹)	V_f (mm/min)	a_p (mm)	a_e (mm)	n (min ⁻¹)	V_f (mm/min)	a_p (mm)	a_e (mm)
1	4	19,080	1,330	0.018	0.7	15,880	740	0.012	0.6	
2		9,600	1,330	0.036	1.4	8,000	740	0.025	1.2	
3		6,360	1,390	0.054	2.1	5,250	760	0.037	1.8	
4		4,800	2,110	0.072	2.8	4,000	1,170	0.049	2.4	
5	6	3,840	2,160	0.090	3.5	3,130	1,170	0.062	3	
6		3,240	2,190	0.108	4.2	2,630	1,180	0.074	3.6	
8		2,400	2,220	0.144	5.6	2,000	1,240	0.099	4.8	
10		1,920	2,220	0.181	7	1,630	1,260	0.124	6	
12		1,560	2,060	0.217	8.4	1,380	1,220	0.148	7.2	

- 【注意】**
- ①被削材、加工形状に合わせて、適切なクーラントを使用してください。
 - ②できるだけ高剛性、高精度の機械をご使用ください。
 - ③この切削条件表は切削条件の目安を示すものです。実際の加工では加工形状、目的、使用機械等により条件を調整してください。
 - ④機械の回転数が足りない場合には、回転数と送り速度を同じ比率で下げてください。
 - ⑤等高線加工での使用をお願いいたします。
 - ⑥ピック量 a_e を先端フラット径より大きく設定するとカスプが残ります。

- ① Use the appropriate coolant for the work material and machining shape.
- ② Use a highly rigid and accurate machine as possible.
- ③ These Recommended Cutting Conditions indicate only the rule of a thumb for the cutting conditions. In actual machining, the condition should be adjusted according to the machining shape, purpose and the machine type.
- ④ If the rpm available is lower than that recommended please reduce the feed rate to the same ratio.
- ⑤ Please use for contouring process.
- ⑥ Setting pick feed (a_e) larger than lowest point diameter will remain cusp.

※1 EHHRE-TH3は高硬度鋼加工刃形を採用しておりますので高靱性熱間工具鋼(SKD61改良鋼)には適していません。高靱性熱間工具鋼にはEMBE-ATHを推奨します。
Since EHHRE-TH3 adopts a cutting edge geometry for high hardness steel cutting, it is not suitable for sticky hard material such as hot forging material SKD61 (reformed). EMBE-ATH is recommended for cutting SKD61 (reformed).

Epoch TH Hard エポックTHハード

レギュラー刃長・コーナR付き Regular, Corner radius



高硬度材加工用ラジアスエンドミル。
Radius end mill for machining high-hardness materials.

スクエアはA352頁を参照してください
Please refer to page A352 for Square

外径公差 Dia. tolerance
φ6 : 0~-0.015
φ8~φ20 : 0~-0.02



(mm)



CEPR6-TH



商品コード Item code	在庫 Stock	寸法 Size (mm)					刃数 No. of Flutes	希望小売価格 (円) Suggested retail price(¥)
		外径 Tool dia.	コーナ半径 Corner radius	刃長 Flute length	全長 Overall length	シャンク径 Shank dia.		
CEPR6060-03-TH	●	6	0.3	15	60	6	6	21,100
CEPR6060-05-TH	●		0.5	15	60	6	6	21,100
CEPR6060-10-TH	●		1.0	15	60	6	6	21,100
CEPR6080-03-TH	●	8	0.3	20	75	8	6	26,600
CEPR6080-05-TH	●		0.5	20	75	8	6	26,600
CEPR6080-10-TH	●		1.0	20	75	8	6	26,600
CEPR6100-05-TH	●	10	0.5	25	80	10	6	35,690
CEPR6100-10-TH	●		1.0	25	80	10	6	35,690
CEPR6100-15-TH	●		1.5	25	80	10	6	35,690
CEPR6100-20-TH	●		2.0	25	80	10	6	35,690
CEPR6120-05-TH	●	12	0.5	30	100	12	6	43,650
CEPR6120-10-TH	●		1.0	30	100	12	6	43,650
CEPR6120-15-TH	●		1.5	30	100	12	6	43,650
CEPR6120-20-TH	●		2.0	30	100	12	6	43,650
CEPR6160-10-TH	●	16	1.0	40	110	16	6	101,600
CEPR6160-20-TH	●		2.0	40	110	16	6	101,600
CEPR6200-10-TH	●	20	1.0	45	125	20	6	150,150
CEPR6200-20-TH	●		2.0	45	125	20	6	150,150
CEPR6200-30-TH	●		3.0	45	125	20	6	150,150

○ 対応被削材 Applicable work material

炭素鋼 合金鋼 Carbon steel Alloy steel	プリハー ド鋼 Pre-hardened steel	高硬度 Hardened steel			ステン レス鋼 Stainless steel	チタン合金 耐熱合金 Titanium alloy Heat-resistant alloy	銅合金 Copper alloy	アルミ 合金 Aluminum alloy
		> 45HRC ≤ 45HRC	> 55HRC ≤ 55HRC	> 65HRC				
○	○	○	○	○	○	○	○	

○ 再研磨対応外径範囲 Re-grinding compatibility range

商品コード Item code	外周 Outer dia. (mm)	エンド End (mm)
CEPR-CR-TH	8 ~ 20	6 ~ 20

● : 標準在庫品です。 ● : Stocked items.

Epoch TH Hard エポックTHハード

標準切削条件表 Recommended cutting conditions

CEPR-CR-TH

コーナR付き
Corner radius

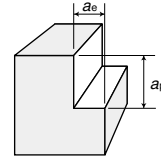

<側面切削> Side milling

被削材 Work material	工具鋼 Tool steels (25~35HRC) SKD			プリハードン鋼 Pre-hardened steels (35~45HRC) GENA1, NAK80		焼入れ鋼 Hardened steels (45~55HRC) SKD61, SKT4		焼入れ鋼 Hardened steels (55~65HRC) SKD11, SKH51		焼入れ鋼 Hardened steels (65~70HRC) SKH, HAP	
	切込み Depth of cut (mm)	回転数n (min ⁻¹)	送り速度vf (mm/min)	回転数n (min ⁻¹)	送り速度vf (mm/min)	回転数n (min ⁻¹)	送り速度vf (mm/min)	回転数n (min ⁻¹)	送り速度vf (mm/min)	回転数n (min ⁻¹)	送り速度vf (mm/min)
高速条件 High Speed	切込み Depth of cut (mm)	ap=1.5DC ae=0.1DC		ap=1.5DC ae=0.05DC		ap=1.5DC ae=0.03DC		ap=1.5DC ae=0.02DC		ap=1.5DC ae=0.02DC	
	外径DC Tool dia. (mm)	回転数n (min ⁻¹)	送り速度vf (mm/min)	回転数n (min ⁻¹)	送り速度vf (mm/min)	回転数n (min ⁻¹)	送り速度vf (mm/min)	回転数n (min ⁻¹)	送り速度vf (mm/min)	回転数n (min ⁻¹)	送り速度vf (mm/min)
	φ6	13,000	4,910	13,000	4,390	11,000	3,270	8,000	2,160	5,300	1,290
	φ8	10,000	5,040	10,000	4,500	8,000	3,170	6,000	2,160	4,000	1,300
	φ10	8,000	4,840	8,000	4,320	6,400	3,040	4,800	2,070	3,200	1,240
	φ12	6,600	4,440	6,600	3,960	5,300	2,800	4,000	1,920	2,700	1,170
汎用条件 General	切込み Depth of cut (mm)	ap=1.5DC ae=0.1DC		ap=1.5DC ae=0.1DC		ap=1.5DC ae=0.06DC		ap=1.5DC ae=0.04DC		ap=1.5DC ae=0.04DC	
	外径DC Tool dia. (mm)	回転数n (min ⁻¹)	送り速度vf (mm/min)	回転数n (min ⁻¹)	送り速度vf (mm/min)	回転数n (min ⁻¹)	送り速度vf (mm/min)	回転数n (min ⁻¹)	送り速度vf (mm/min)	回転数n (min ⁻¹)	送り速度vf (mm/min)
	φ6	6,400	2,420	5,300	1,250	4,200	870	3,200	600	2,100	360
	φ8	4,800	2,420	4,000	1,260	3,200	890	2,400	600	1,600	360
	φ10	3,800	2,300	3,200	1,210	2,500	830	1,900	570	1,300	350
	φ12	3,200	2,150	2,700	1,130	2,100	780	1,600	540	1,100	330
φ16	2,400	2,070	2,000	1,080	1,600	760	1,200	520	800	310	
φ20	1,900	1,920	1,600	1,010	1,300	720	1,000	500	600	270	

- [注意]**
- ①できるだけ高剛性、高精度の機械をご使用ください。
 - ②被削材、加工形状に合わせて、適切なクーラントを使用してください。
 - ③この切削条件表は切削条件の目安を示すものです。実際の加工では加工形状、目的、使用機械等により条件を調整してください。
 - ④機械の回転数が足りない場合には、回転数と送り速度を同じ比率で下げてください。

- [Note]**
- ① Use a highly rigid and accurate machine as possible.
 - ② Use the appropriate coolant for the work material and machining shape.
 - ③ These conditions are for general guidance; in actual machining conditions adjust the parameters according to your actual machine and work-piece conditions.
 - ④ If the rpm available is lower than that recommended please reduce the feed rate to the same ratio.

Epoch End Mill エポックエンドミル

エポック21・コーナR付き Epoch 21, Corner radius



高硬度材加工用ラジアスエンドミル。
Radius end mill for machining high-hardness materials.

スクエアはA355頁を参照してください
Please refer to page A355 for Square

外径公差 Dia. tolerance
φ6 : 0~-0.015
φ8~φ30 : 0~-0.02



(mm)



CEPR



商品コード Item code	在庫 Stock	寸法 Size (mm)					刃数 No. of Flutes	希望小売価格 (円) Suggested retail price(¥)
		外径 Tool dia.	コーナ半径 Corner radius	刃長 Flute length	全長 Overall length	シャンク径 Shank dia.		
CEPR6060-03	●	6	0.3	15	60	6	6	19,200
CEPR6060-05	●		0.5	15	60	6	6	19,200
CEPR6060-10	●		1	15	60	6	6	19,200
CEPR6080-03	●	8	0.3	20	75	8	6	24,130
CEPR6080-05	●		0.5	20	75	8	6	24,130
CEPR6080-10	●		1	20	75	8	6	24,130
CEPR6080-15	●		1.5	20	75	8	6	24,130
CEPR6100-05	●	10	0.5	25	80	10	6	32,430
CEPR6100-10	●		1	25	80	10	6	32,430
CEPR6100-15	●		1.5	25	80	10	6	32,430
CEPR6100-20	●		2	25	80	10	6	32,430
CEPR6120-05	●	12	0.5	30	100	12	6	39,620
CEPR6120-10	●		1	30	100	12	6	39,620
CEPR6120-15	●		1.5	30	100	12	6	39,620
CEPR6120-20	●		2	30	100	12	6	39,620
CEPR6160-10	●	16	1	40	110	16	6	92,330
CEPR6160-15	●		1.5	40	110	16	6	92,330
CEPR6160-20	●		2	40	110	16	6	92,330
CEPR6160-25	●		2.5	40	110	16	6	92,330
CEPR6200-10	●	20	1	45	125	20	6	136,070
CEPR6200-15	●		1.5	45	125	20	6	136,070
CEPR6200-20	●		2	45	125	20	6	136,070
CEPR6200-25	●		2.5	45	125	20	6	136,070
CEPR6200-30	●		3	45	125	20	6	136,070
CEPR8250-10	□	25	1	50	140	25	8	—
CEPR8250-15	□		1.5	50	140	25	8	—
CEPR8250-20	□		2	50	140	25	8	—
CEPR8250-25	□		2.5	50	140	25	8	—
CEPR8250-30	□		3	50	140	25	8	—
CEPR8300-10	□	30	1	60	165	32	8	—
CEPR8300-15	□		1.5	60	165	32	8	—
CEPR8300-20	□		2	60	165	32	8	—
CEPR8300-25	□		2.5	60	165	32	8	—
CEPR8300-30	□		3	60	165	32	8	—

○ 対応被削材 Applicable work material

炭素鋼 合金鋼 Carbon steel Alloy steel	プリハー ド鋼 Pre-hardened steel ≤ 45HRC	高硬度 Hardened steel			ステン レス鋼 Stainless steel	チタン合金 耐熱合金 Titanium alloy Heat-resistant alloy	銅合金 Copper alloy	アルミ 合金 Aluminum alloy
		> 45HRC ≤ 55HRC	> 55HRC ≤ 65HRC	> 65HRC				
○	○	○	○	○	○	○	○	

●印：標準在庫品です。
●： Stocked items.

□印：特定代理店在庫です。弊社営業へお問合せください。
□： Stocked by specified distributor. Contact with our sales department.

○ 再研磨対応外径範囲 Re-grinding compatibility range

商品コード Item code	外周 Outer dia. (mm)	エンド End (mm)
CEPR-CR	8 ~ 30	6 ~ 30

Epoch End Mill エポックエンドミル

超硬エンドミル
リジッドエンドミル

標準切削条件表 Recommended cutting conditions

CEPR-CR
エポック21・レギュラー刃長・コーナー付き
Epoch21, Regular, Corner radius

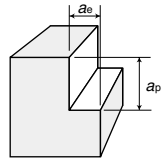

<側面切削> Side milling

被削材 Work material	鋳鉄 Cast irons (150~200HB) FC250		炭素鋼 Carbon steels (180~220HB) SS400, S50C		合金鋼 Alloy steels (200~250HB) SCM440, SNCM		ステンレス鋼・工具鋼 Stainless steels, Tool steels (25~35HRC) SUS304, SKD		プリハードン鋼 Pre-hardened steels (35~45HRC) HPM1, NAK55		焼入れ鋼 Hardened steels (45~55HRC) SKD61, SKT4		焼入れ鋼 Hardened steels (55~65HRC) SKD11, SKH51		
	切込み Depth of cut (mm) $a_p=1.5DC$ $a_e \leq 0.1DC$		切込み Depth of cut (mm) $a_p=1.5DC$ $a_e \leq 0.1DC$		切込み Depth of cut (mm) $a_p=1.5DC$ $a_e \leq 0.05DC$		切込み Depth of cut (mm) $a_p=1.5DC$ $a_e \leq 0.05DC$		切込み Depth of cut (mm) $a_p=1.5DC$ $a_e \leq 0.02DC$		切込み Depth of cut (mm) $a_p=1.5DC$ $a_e \leq 0.01DC$		切込み Depth of cut (mm) $a_p=1.5DC$ $a_e \leq 0.01DC$		
外径DC Tool dia. (mm)	回転数 n (min^{-1})	送り速度 v_f (mm/min)	回転数 n (min^{-1})	送り速度 v_f (mm/min)	回転数 n (min^{-1})	送り速度 v_f (mm/min)	回転数 n (min^{-1})	送り速度 v_f (mm/min)	回転数 n (min^{-1})	送り速度 v_f (mm/min)	回転数 n (min^{-1})	送り速度 v_f (mm/min)	回転数 n (min^{-1})	送り速度 v_f (mm/min)	
高速条件 High Speed	$\phi 6$	16,660	7,980	16,000	6,700	15,000	6,300	13,800	5,000	13,300	4,800	6,400	2,300	5,300	1,900
	$\phi 8$	12,500	7,860	12,000	7,200	11,100	6,700	10,300	4,330	9,950	4,180	4,800	2,000	4,000	1,680
	$\phi 10$	10,000	6,900	9,550	6,300	8,900	5,800	8,300	4,000	8,000	3,840	3,800	1,800	3,200	1,500
	$\phi 12$	8,330	6,250	8,000	5,760	7,400	5,300	6,900	4,140	6,600	3,900	3,200	1,920	2,650	1,590
	$\phi 16$	6,250	5,060	6,000	4,680	5,600	4,400	5,200	3,750	5,000	3,600	2,400	1,730	2,000	1,440
	$\phi 20$	5,000	4,200	4,770	3,720	4,460	3,500	4,140	3,000	4,000	2,880	1,900	1,400	1,600	1,150
	$\phi 25$	4,000	4,480	3,800	4,000	3,560	3,700	3,300	3,170	3,200	3,070	1,500	1,440	1,270	1,200
汎用条件 General	$\phi 6$	8,500	3,250	8,500	3,570	6,400	2,700	5,850	2,100	4,800	1,730	2,100	750	1,300	470
	$\phi 8$	6,400	4,000	6,400	3,840	4,770	2,860	4,400	1,850	3,600	1,500	1,600	670	1,000	420
	$\phi 10$	5,100	3,500	5,100	3,350	3,800	2,500	3,500	1,680	2,900	1,400	1,300	625	800	380
	$\phi 12$	4,200	3,150	4,200	3,000	3,200	2,300	2,920	1,750	2,400	1,440	1,060	640	660	400
	$\phi 16$	3,200	2,600	3,200	2,500	2,400	1,870	2,200	1,600	1,800	1,300	800	580	500	360
	$\phi 20$	2,550	1,800	2,550	2,000	1,900	1,500	1,750	1,260	1,450	1,040	640	460	400	290
	$\phi 25$	2,040	2,300	2,040	2,120	1,530	1,600	1,400	1,340	1,150	1,100	510	490	320	300
$\phi 30$	1,700	1,900	1,700	1,770	1,270	1,320	1,170	1,120	950	910	420	400	265	254	

【注意】

- ① 切削方法は、ダウンカットで使用ください。
- ② 一般材、とくに高速切削は、乾式（エアブロー）またはオイルミストクーラントにてご使用ください。
- ③ ステンレス鋼および超耐熱合金には、不水溶性切削油のご使用が適しています。
- ④ 安定した切削を行うため、剛性の高い機械とセットアップでご使用ください。
- ⑤ 機械の回転数が足りない場合は、主軸回転数とテーブル送り速度を同比率で下げてください。
- ⑥ 加工形状、機械の剛性、工具突き出し量等、ご使用の状況により、主軸回転数とテーブル送り速度の調整を行ってください。

【Note】

- ① Down-cutting is recommended.
- ② Use generally dry (air-blow) or oil-mist coolant, especially at the high-speed machining.
- ③ Oil base coolant is recommended for machining stainless steels and heat-resistant alloys.
- ④ Use a machine tool with rigidity and rigid set-up, to machine stably.
- ⑤ When the revolution speed is not enough, reduce the revolution speed and table speed at the same ratio.
- ⑥ Adjust the revolution speed and table speed, according to cutting conditions such as machining shape, rigidity of machine tool, over-hang and so on.

Epoch Aero Power Mill エポックエアロパワーミル

耐熱鋼、チタン合金などの難削材に適しています。

スクエアはA371頁を参照してください
Please refer to page A371 for Square

Ideal for difficult-to-cut materials such as heat-resistant steel, titanium alloys, etc.

4枚刃・コーナR付き

4 flutes, Corner radius

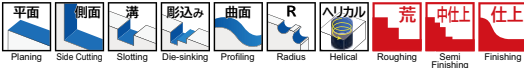

外径公差 Dia. tolerance 0~-0.02

h6

(mm)

4枚刃
4Flutes



6枚刃・コーナR付き

6 flutes, Corner radius

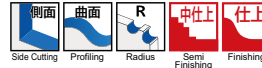

外径公差 Dia. tolerance 0~-0.02

h6

(mm)

6枚刃
6Flutes



切削条件表 A270
Cutting Conditions

EAP4-TH

超硬 TH ねじり43° 不等分刃
Carbide Helix angle Unequal pitch

商品コード Item code	在庫 Stock	寸法 Size (mm)				
		外径 Tool dia.	コーナ半径 Corner radius	刃長 Flute length	全長 Overall length	シャンク径 Shank dia.
EAP4060-05-TH	◎	6	0.5	15	60	6
EAP4060-10-TH	◎		1	15	60	6
EAP4080-05-TH	◎	8	0.5	20	75	8
EAP4080-10-TH	◎		1	20	75	8
EAP4080-15-TH	◎		1.5	20	75	8
EAP4100-05-TH	◎	10	0.5	25	80	10
EAP4100-10-TH	◎		1	25	80	10
EAP4100-15-TH	◎		1.5	25	80	10
EAP4100-20-TH	◎		2	25	80	10
EAP4120-05-TH	◎	12	0.5	30	100	12
EAP4120-10-TH	◎		1	30	100	12
EAP4120-15-TH	◎		1.5	30	100	12
EAP4120-20-TH	◎		2	30	100	12
EAP4160-10-TH	◎	16	1	40	110	16
EAP4160-15-TH	◎		1.5	40	110	16
EAP4160-20-TH	◎		2	40	110	16
EAP4160-30-TH	◎		3	40	110	16
EAP4200-10-TH	◎	20	1	45	125	20
EAP4200-15-TH	◎		1.5	45	125	20
EAP4200-20-TH	◎		2	45	125	20
EAP4200-30-TH	◎		3	45	125	20

切削条件表 A271
Cutting Conditions

EAP6-TH

超硬 TH ねじり43° 不等分刃
Carbide Helix angle Unequal pitch

商品コード Item code	在庫 Stock	寸法 Size (mm)					
		外径 Tool dia.	コーナ半径 Corner radius	刃長 Flute length	全長 Overall length	シャンク径 Shank dia.	
EAP6060-05-TH	◎	6	0.5	15	60	6	
EAP6060-10-TH	◎		1	15	60	6	
EAP6080-05-TH	◎	8	0.5	20	75	8	
EAP6080-10-TH	◎		1	20	75	8	
EAP6080-15-TH	◎		1.5	20	75	8	
EAP6100-05-TH	◎	10	0.5	25	80	10	
EAP6100-10-TH	◎		1	25	80	10	
EAP6100-15-TH	◎		1.5	25	80	10	
EAP6100-20-TH	◎		2	25	80	10	
EAP6120-05-TH	◎	12	0.5	30	100	12	
EAP6120-10-TH	◎		1	30	100	12	
EAP6120-15-TH	◎		1.5	30	100	12	
EAP6120-20-TH	◎		2	30	100	12	
EAP6160-10-TH	◎	16	1	40	110	16	
EAP6160-15-TH	◎		1.5	40	110	16	
EAP6200-10-TH	◎		20	1	45	125	20
EAP6200-15-TH	◎			1.5	45	125	20

○ EAP4-CR-TH、EAP6-CR-TH の対応被削材

Applicable work material of EAP4-CR-TH, EAP6-CR-TH

炭素鋼 合金鋼 Carbon steel Alloy steel	プリハー ド鋼 Pre-hardened steel	高硬度 Hardened steel			ステン レス鋼 Stainless steel	チタン合金 耐熱合金 Titanium alloy Heat-resistant alloy	銅合金 Copper alloy	アルミ 合金 Aluminum alloy
		> 45HRC ≤ 55HRC	> 55HRC ≤ 65HRC	> 65HRC				
◎	◎	◎	◎	◎	◎	◎	◎	

○ 再研磨対応外径範囲

Re-grinding compatibility range

商品コード Item code	外周 Outer dia. (mm)	エンド End (mm)
EAP4-CR-TH	6 ~ 20	6 ~ 20
EAP6-CR-TH	8 ~ 20	6 ~ 20

◎印：メーカー在庫品です。弊社営業へお問い合わせください。○：Manufacturer stocked items. Contact with our sales department.

Epoch Aero Power Mill エポックエアロパワーミル

超硬合金ミル
リジッドエアロパワーミル

標準切削条件表 Recommended cutting conditions

EAP4-CR-TH
4枚刃・レギュラー刃長・コーナR付き
4ft, Regular, Corner radius

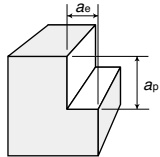

〈側面切削〉 Side milling

被削材 Work material	合金鋼 Alloy steels		ステンレス鋼・耐熱鋼 Stainless steels, Heat resistant steels SUS, SUH		チタン・チタン合金 Titanium Titanium alloys Ti-6Al-4V		超耐熱合金 Super heat resistant alloys Inconel718		焼入れ鋼 Hardened steels (45~55HRC) SKD61,SKT4	
	SCM, SNCM		SUS, SUH		Ti-6Al-4V		Inconel718		SKD61,SKT4	
切込み Depth of cut (mm)	$a_p = 1.5DC$ $a_e < 0.1DC$		$a_p = 1DC$ $a_e < 0.05DC$		$a_p = 1DC$ $a_e < 0.05DC$		$a_p = 1DC$ $a_e < 0.05DC$		適していません Unsuitable for high hardness material.	
外径 DC Tool dia.(mm)	回転数 n (min^{-1})	送り速度 v_f (mm/min)	回転数 n (min^{-1})	送り速度 v_f (mm/min)	回転数 n (min^{-1})	送り速度 v_f (mm/min)	回転数 n (min^{-1})	送り速度 v_f (mm/min)		
φ6	5,300	1,060	3,700	590	3,700	590	2,100	230		
φ8	4,000	1,110	2,800	560	2,800	560	1,600	220		
φ10	3,200	1,020	2,200	540	2,200	540	1,300	200		
φ12	2,700	960	1,900	520	1,850	520	1,100	170		
φ16	2,000	800	1,400	450	1,400	450	800	130		
φ20	1,600	760	1,100	450	1,100	450	640	100		

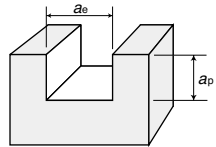

〈溝切削〉 Slotting

被削材 Work material	合金鋼 Alloy steels		ステンレス鋼・耐熱鋼 Stainless steels, Heat resistant steels SUS, SUH		チタン・チタン合金 Titanium Titanium alloys Ti-6Al-4V		超耐熱合金 Super heat resistant alloys Inconel718		焼入れ鋼 Hardened steels (45~55HRC) SKD61,SKT4	
	SCM, SNCM		SUS, SUH		Ti-6Al-4V		Inconel718		SKD61,SKT4	
切込み Depth of cut (mm)	$a_p < 1DC$ $a_e = 1DC$		$a_p = 0.5DC$ $a_e = 1DC$		$a_p = 0.2DC$ $a_e = 1DC$		$a_p = 0.2DC$ $a_e = 1DC$		適していません Unsuitable for high hardness material.	
外径 DC Tool dia.(mm)	回転数 n (min^{-1})	送り速度 v_f (mm/min)	回転数 n (min^{-1})	送り速度 v_f (mm/min)	回転数 n (min^{-1})	送り速度 v_f (mm/min)	回転数 n (min^{-1})	送り速度 v_f (mm/min)		
φ6	2,650	420	2,400	380	2,100	340	1,000	100		
φ8	2,000	400	1,800	360	1,600	320	720	90		
φ10	1,600	380	1,450	340	1,300	310	600	85		
φ12	1,300	370	1,200	330	1,050	300	500	70		
φ16	1,000	320	900	290	800	250	360	50		
φ20	800	320	700	290	650	250	290	40		

- 【注意】**
- ①被削材、加工形状に合わせて、適切なクーラントを使用してください。
 - ②できるだけ高剛性、高精度の機械及びチャックをご使用ください。
 - ③この標準切削条件表は切削条件の目安を示すものです。ヒビや異常振動が発生する場合は条件を調整してください。

- 【Note】**
- ① Use the appropriate coolant for the work material and machining shape.
 - ② Use the high-rigidity and high accuracy machine as possible
 - ③ Cutting parameters in shown table are general recommendation. Please adjust it if chatter or abnormal vibration occurs.

EAP6-CR-TH

6枚刃・レギュラー刃長・コーナR付き
6fl, Regular, Corner radius

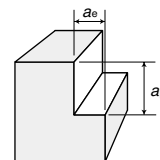

〈側面切削〉 Side milling

被削材 Work material	合金鋼 Alloy steels		ステンレス鋼・耐熱鋼 Stainless steels, Heat resistant steels		チタン・チタン合金 Titanium Titanium alloys		超耐熱合金 Super heat resistant alloys		焼入れ鋼 Hardened steels (45~55HRC) SKD61, SKT4
	SCM, SNCM		SUS, SUH		Ti-6Al-4V		Inconel718		
切込み Depth of cut (mm)	$a_p = 1.5DC$ $a_e < 0.1DC$		$a_p = 1DC$ $a_e < 0.05DC$		$a_p = 1DC$ $a_e < 0.05DC$		$a_p = 1DC$ $a_e < 0.05DC$		適していません Unsuitable for high hardness material.
外径 DC Tool dia.(mm)	回転数 n (min^{-1})	送り速度 v_f (mm/min)	回転数 n (min^{-1})	送り速度 v_f (mm/min)	回転数 n (min^{-1})	送り速度 v_f (mm/min)	回転数 n (min^{-1})	送り速度 v_f (mm/min)	
φ6	7,950	1,910	4,250	920	3,700	800	2,100	320	
φ8	6,000	1,970	3,200	900	2,800	790	1,600	300	
φ10	4,800	2,010	2,550	760	2,200	670	1,300	260	
φ12	4,000	1,910	2,100	840	1,850	740	1,100	230	
φ16	3,000	1,610	1,600	740	1,400	640	800	180	
φ20	2,400	1,430	1,300	690	1,100	600	640	150	

- 【注意】**
- ①被削材、加工形状に合わせて、適切なクーラントを使用してください。
 - ②できるだけ高剛性、高精度の機械及びチャックをご使用ください。
 - ③この標準切削条件表は切削条件の目安を示すものです。ビビリや異常振動が発生する場合は条件を調整してください。

- 【Note】**
- ①Use the appropriate coolant for the work material and machining shape.
 - ②Use the high-rigidity and high accuracy machine as possible
 - ③Cutting parameters in shown table are general recommendation. Please adjust it if chatter or abnormal vibration occurs.

加工上の注意点

Cautions

- ① 高硬度材の切削には不適です。硬さが45HRCを超える材料の場合には、CEPR-THあるいはEPP-THを推奨いたします。
When handling the work with hardness more than 45HRC, please use our CEPR-TH or EPP-TH.
- ② 必ず十分なクーラントをかけて、切削を行ってください。
Coolant is necessary for machining heat resistant materials.
- ③ 板材のような剛性の弱いワーク形状の溝切削の場合には、トロコイド加工を推奨します。
In the case of slotting in a plate, We recommend using a trochoidal cutting.
- ④ 耐熱鋼と超耐熱合金の穴加工には、4枚刃仕様でのヘリカル加工あるいは弊社のノンステップボーラーを推奨いたします。
When hole machining is needed on heat resistant material, We recommend performing a helical boring by Adopting EAP4, or using our NSB borer for higher efficiency.
- ⑤ 耐熱鋼と超耐熱合金の切削においては、加工硬化面を切削する事を避けるために、0.1mm以上の径方向切込み量を推奨いたします。
In order to avoid constant cutting work-hardened layer, We recommend to set up width of cut more than 0.1mm.

Epoch Mirus Type A for Aluminium エポックミルス タイプA (アルミ用)

メーカー在庫品

Manufacture stocked items

高能率アルミ加工用エンドミル
High efficiency end mill for aluminium.

スクエアはA374頁を参照してください
Please refer to page A374 for Square



外径公差
0~-0.02



(mm)

2枚刃タイプ 2Flutes type

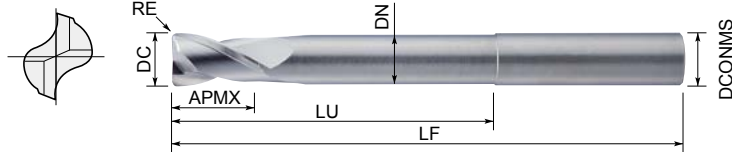

EMXA2

ノンコーティング
Non Coating

超硬 Carbide ねじ30° Helix angle 切削条件表 A274 Cutting Conditions

商品コード Item code	在庫 Stock	寸法 Size(mm)						
		外径 Tool dia. DC	コーナ半径 Corner radius RE	刃長 Flute length APMX	首下長 Under neck length LU	首径 Neck dia. DN	全長 Overall length LF	シャンク径 Shank dia. DCONMS
		EMXA2100-45-10	◎	φ10	1.0	8	45	9.5
EMXA2120-60-10	◎	φ12	1.0	10	60	11.5	100	12
EMXA2160-75-10	◎	φ16	1.0	13	75	15.5	120	16
EMXA2200-80-30	◎	φ20	3.0	16	80	19.5	125	20
EMXA2250-100-30	◎	φ25	3.0	20	100	24.5	150	25

3枚刃タイプ 3Flutes type

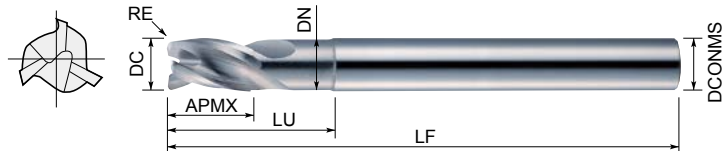

EMXA3

ノンコーティング
Non Coating

超硬 Carbide ねじ30° Helix angle 切削条件表 A274 Cutting Conditions

商品コード Item code	在庫 Stock	寸法 Size(mm)						
		外径 Tool dia. DC	コーナ半径 Corner radius RE	刃長 Flute length APMX	首下長 Under neck length LU	首径 Neck dia. DN	全長 Overall length LF	シャンク径 Shank dia. DCONMS
		EMXA3030-9-05	◎	3	0.5	4.5	9	2.9
EMXA3040-12-05	◎	4	6	12		3.75	60	6
EMXA3050-15-05	◎	5	7.5	15		4.75	80	6
EMXA3060-18-05	◎	6	9	18		5.75	80	6
EMXA3080-24-05	◎	8	12	24		7.5	90	8
EMXA3100-30-10	◎	10	1.0	15	30	9.5	100	10
EMXA3120-36-10	◎	12		18	36	11.5	120	12
EMXA3160-45-10	◎	16		19	45	15.5	90	16

受注生産品(フルオーダー) Made-to-order items (Full-order)

上記以外のラインナップにつきましては、下記範囲にて受注生産品として承ります。
For the lineup of products other than above-mentioned list, made-to-order products within the following ranges are available.



ご注文方法
Ordering method

ご注文コード: EMXA - (A) - (B) - (C)

刃数 外径 首下長 コーナ半径 コーティング
No. of flutes Mill dia. Under neck length Corner radius Coating

外径・刃数 : 2枚刃タイプ: φ10~φ25
3枚刃タイプ: φ3~φ16
首下長 : 10DC以下
(ただし、全長によってはお受け出来ない場合があります。)
コーナ半径 : 0.05mm~0.3DC ※コーナ半径無しも可能です。
コーティング : ノンコーティング/ PNコーティング/ SDコーティング

Mill dia., No. of flutes : 2Flutes type : φ10~φ25
3Flutes type : φ3~φ16
Under neck length : 10DC or less (However, orders cannot be accepted in some cases depending on the overall length.)
Corner radius : 0.05mm to 0.3DC
※Square type is also available.
Coating : Non Coating/ PN Coating / SD Coating

◎印: メーカー在庫品です。弊社営業へお問い合わせください。 ○: Manufacturer stocked items. Contact with our sales department.

受注生産品 (セミオーダー) Made-to-order items (Semi-order)



0~-0.02



(mm)

2枚刃タイプ 2Flutes type

コーナR、コーティングをご指定ください。
Please specify the desired corner radius and coating.

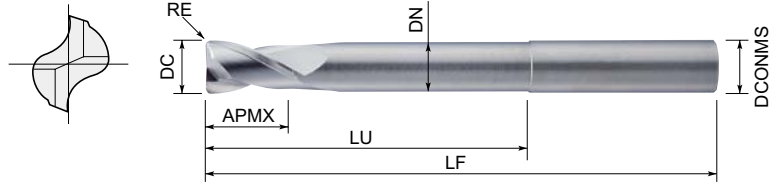

EMXA2○○○-○○○-(B)-(C)



ご注文コード Order code	コーティングの種類 Kind of coating (C)	寸法 Size(mm)						
		外径 Tool dia. DC	コーナ半径 Corner radius (B) RE	刃長 Flute length APMX	首下長 Under neck length (A) LU	首径 Neck dia. DN	全長 Overall length LF	シャンク径 Shank dia. DCONMS
EMXA2100-45-(B)-(C)	無しNon-coat/PN/SD	10	RE	8	45	9.5	80	10
EMXA2100-60-(B)-(C)	無しNon-coat/PN/SD			8	60	9.5	95	10
EMXA2120-45-(B)-(C)	無しNon-coat/PN/SD	12	RE	10	45	11.5	85	12
EMXA2120-60-(B)-(C)	無しNon-coat/PN/SD			10	60	11.5	100	12
EMXA2160-45-(B)-(C)	無しNon-coat/PN/SD	16	RE	13	45	15.5	90	16
EMXA2160-60-(B)-(C)	無しNon-coat/PN/SD			13	60	15.5	105	16
EMXA2160-75-(B)-(C)	無しNon-coat/PN/SD	16	RE	13	75	15.5	120	16
EMXA2200-45-(B)-(C)	無しNon-coat/PN/SD			16	45	19.5	90	20
EMXA2200-60-(B)-(C)	無しNon-coat/PN/SD	20	RE	16	60	19.5	105	20
EMXA2200-80-(B)-(C)	無しNon-coat/PN/SD			16	80	19.5	125	20
EMXA2200-100-(B)-(C)	無しNon-coat/PN/SD	20	RE	16	100	19.5	145	20
EMXA2250-45-(B)-(C)	無しNon-coat/PN/SD			20	45	24.5	95	25
EMXA2250-60-(B)-(C)	無しNon-coat/PN/SD	25	RE	20	60	24.5	110	25
EMXA2250-80-(B)-(C)	無しNon-coat/PN/SD			20	80	24.5	130	25
EMXA2250-100-(B)-(C)	無しNon-coat/PN/SD	25	RE	20	100	24.5	150	25

3枚刃タイプ 3Flutes type

首下長さ、コーティングをご指定ください。
Please specify the desired under neck length and coating.

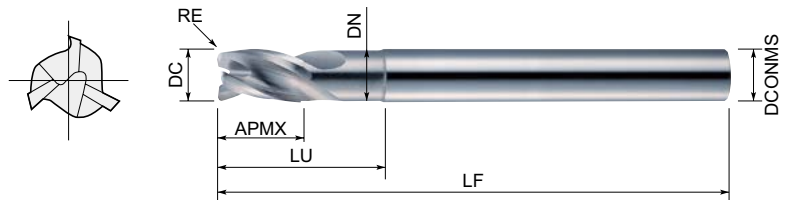

EMXA3○○○-(A)-○○○-(C)



ご注文コード Order code	コーティングの種類 Kind of coating (C)	寸法 Size(mm)						
		外径 Tool dia. DC	コーナ半径 Corner radius (B) RE	刃長 Flute length APMX	首下長 Under neck length (A) LU	首径 Neck dia. DN	全長 Overall length LF	シャンク径 Shank dia. DCONMS
EMXA3030-(A)-05-(C)	無しNon-coat/PN/SD	3	RE	4.5	8DC以下の長さでご指定下さい Please specify a length of 8DC or less.	2.9	60	6
EMXA3040-(A)-05-(C)	無しNon-coat/PN/SD			6		3.75	60	6
EMXA3050-(A)-05-(C)	無しNon-coat/PN/SD	5	RE	7.5	8DC以下の長さでご指定下さい Please specify a length of 8DC or less.	4.75	80	6
EMXA3060-(A)-05-(C)	無しNon-coat/PN/SD			9		5.75	80	6
EMXA3080-(A)-05-(C)	無しNon-coat/PN/SD	8	RE	12	5DC以下の長さでご指定下さい Please specify a length of 5DC or less.	7.5	90	8
EMXA3100-(A)-10-(C)	無しNon-coat/PN/SD			15		9.5	100	10
EMXA3120-(A)-10-(C)	無しNon-coat/PN/SD	12	RE	18	5DC以下の長さでご指定下さい Please specify a length of 5DC or less.	11.5	120	12
EMXA3160-45-10-(C)	無しNon-coat/PN/SD			19		15.5	90	16
EMXA3160-75-10-(C)	無しNon-coat/PN/SD	16	RE	19	5DC以下の長さでご指定下さい Please specify a length of 5DC or less.	15.5	120	16

EMXA2、EMXA3の対応被削材

Applicable work material of EMXA2, EMXA3

炭素鋼 合金鋼 Carbon steel Alloy steel	プリハードン ド鋼 Pre-hardened steel	高硬度 Hardened steel			ステン レス鋼 Stainless steel	チタン合金 耐熱合金 Titanium alloy Heat-resistant alloy	銅合金 Copper alloy	アルミ 合金 Aluminum alloy
		> 45HRC ≤ 55HRC	> 55HRC ≤ 65HRC	> 65HRC				

再研磨対応外径範囲

Re-grinding compatibility range

商品コード Item code	外周 Outer dia. (mm)	エンド End (mm)
EMXA2	10 ~ 25	10 ~ 25
EMXA3	6 ~ 16	3 ~ 16

Epoch Mirus Type A for Aluminium

エポックミルス タイプA (アルミ用)

超硬合金ミル
リジッドエポックミル

参考切削条件表 Reference cutting conditions

<側面切削> Side milling **2枚刃タイプ 2Flutes type**

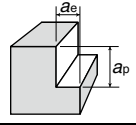

被削材 Work material			アルミ合金(A7075等) Aluminum alloys				アルミ合金鋳物(AC4A等) Cast Aluminum alloys				銅・銅合金(C1100等) Copper, Copper alloys				樹脂等 Resin etc.			
外径DC Tool dia. (mm)	首下長 Under neck length (mm)	切込み Depth of cut ap, ae (mm)	高速条件 High speed		汎用条件 General		高速条件 High speed		汎用条件 General		高速条件 High speed		汎用条件 General		高速条件 High speed		汎用条件 General	
			回転数 min ⁻¹	送り mm/min	回転数 min ⁻¹	送り mm/min	回転数 min ⁻¹	送り mm/min	回転数 min ⁻¹	送り mm/min	回転数 min ⁻¹	送り mm/min	回転数 min ⁻¹	送り mm/min	回転数 min ⁻¹	送り mm/min	回転数 min ⁻¹	送り mm/min
10	45	ap ≤ 0.5DC ae ≤ 0.8DC	22,000	3,300	6,000	1,600	18,500	2,300	5,100	1,200	10,000	1,500	3,500	750	10,120	1,650	3,500	800
	60		20,000	3,000	5,500	1,500	17,000	2,100	4,700	1,000	9,200	1,400	3,200	700	9,200	1,500	3,200	750
12	45		24,000	6,600	7,700	2,200	21,000	4,600	6,500	1,500	11,000	3,000	3,500	1,000	11,040	3,300	3,500	1,100
	60		22,000	6,000	7,000	2,000	18,500	4,200	5,800	1,400	10,000	2,700	3,200	920	10,120	3,000	3,200	1,000
16	45		29,000	7,200	11,000	2,400	24,500	5,000	9,200	1,700	13,000	3,300	5,000	1,100	13,340	3,600	5,000	1,200
	60		26,000	6,600	9,900	2,200	22,000	4,600	8,300	1,500	12,000	3,000	4,500	1,000	11,960	3,300	4,500	1,100
	75		24,000	6,000	9,000	2,000	20,000	4,200	7,500	1,400	11,000	2,700	4,100	900	11,040	3,000	4,100	1,000
20	45		30,000	8,000	9,300	1,300	25,000	5,600	7,800	900	14,000	3,700	4,300	600	13,800	4,000	4,300	650
	60		27,000	7,300	8,500	1,200	23,000	5,100	7,100	850	12,500	3,300	3,900	550	12,420	3,650	3,900	600
	80		24,000	6,600	7,700	1,100	20,000	4,600	6,500	750	11,000	3,000	3,500	500	11,040	3,300	3,500	550
	100		22,000	6,000	7,000	1,000	18,500	4,200	5,800	700	10,000	2,700	3,200	450	10,120	3,000	3,200	500
25	45		24,000	8,000	11,000	1,300	20,000	5,600	9,200	900	11,000	3,700	5,000	600	11,040	4,000	5,000	650
	60	22,000	7,300	10,000	1,200	18,500	5,100	8,400	850	10,000	3,300	4,600	550	10,120	3,650	4,600	600	
	80	20,000	6,600	8,800	1,100	16,800	4,600	7,400	750	9,200	3,000	4,000	500	9,200	3,300	4,000	550	
	100	18,000	6,000	8,000	1,000	15,000	4,200	6,700	700	8,300	2,700	3,700	460	8,280	3,000	3,700	500	

<側面切削> Side milling **3枚刃タイプ 3Flutes type**

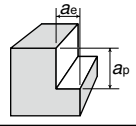

被削材 Work material			アルミ合金(A7075等) Aluminum alloys				アルミ合金鋳物(AC4A等) Cast Aluminum alloys				銅・銅合金(C1100等) Copper, Copper alloys				樹脂等 Resin etc.			
外径DC Tool dia. (mm)	首下長 Under neck length (mm)	切込み Depth of cut ap, ae (mm)	高速条件 High speed		汎用条件 General		高速条件 High speed		汎用条件 General		高速条件 High speed		汎用条件 General		高速条件 High speed		汎用条件 General	
			回転数 min ⁻¹	送り mm/min	回転数 min ⁻¹	送り mm/min	回転数 min ⁻¹	送り mm/min	回転数 min ⁻¹	送り mm/min	回転数 min ⁻¹	送り mm/min	回転数 min ⁻¹	送り mm/min	回転数 min ⁻¹	送り mm/min	回転数 min ⁻¹	送り mm/min
3	3DC以下	ap ≤ 1.0DC ae ≤ 0.2DC	26,000	9,000	20,800	4,500	21,000	6,000	16,800	3,000	21,000	4,000	16,800	2,000	21,000	4,400	16,800	2,200
	3DC~5DC		19,500	6,300	15,600	3,150	15,500	4,200	12,400	2,100	15,500	2,800	12,400	1,400	15,500	3,100	12,400	1,550
	5DC~8DC		14,000	3,000	11,200	1,500	12,000	2,940	9,600	1,500	12,000	2,100	9,600	1,100	12,000	2,300	9,600	1,150
4	3DC以下		24,000	8,100	19,200	4,050	19,000	6,000	15,200	3,000	18,000	4,050	14,400	2,050	18,000	4,450	14,400	2,250
	3DC~5DC		18,000	5,700	14,400	2,850	14,250	4,200	11,400	2,100	13,500	2,800	10,800	1,400	13,500	3,100	10,800	1,550
	5DC~8DC		13,500	3,900	10,800	1,950	10,500	2,940	8,400	1,500	10,125	2,100	8,100	1,100	10,125	2,300	8,100	1,150
5	3DC以下		20,000	8,500	16,000	4,250	16,000	6,000	12,800	3,000	15,000	4,200	12,000	2,100	15,000	4,600	12,000	2,300
	3DC~5DC		15,000	6,000	12,000	3,000	12,000	4,200	9,600	2,100	11,250	2,950	9,000	1,500	11,250	3,250	9,000	1,650
	5DC~8DC		11,250	4,200	9,000	2,100	9,000	2,940	7,200	1,500	8,438	2,100	6,750	1,100	8,438	2,300	6,750	1,150
6	3DC以下		20,000	9,000	16,000	4,500	13,000	6,000	10,400	3,000	12,000	4,500	9,600	2,250	12,000	4,950	9,600	2,500
	3DC~5DC		15,000	6,300	12,000	3,150	9,750	4,200	7,800	2,100	9,000	3,150	7,200	1,600	9,000	3,450	7,200	1,750
	5DC~8DC		11,250	4,400	9,000	2,200	7,300	3,000	5,850	1,500	6,750	2,200	5,400	1,100	6,750	2,400	5,400	1,200
8	3DC以下	18,000	9,000	14,400	4,500	10,000	4,300	8,000	2,150	9,600	3,800	7,700	1,900	9,600	4,200	7,680	2,100	
	3DC~5DC	13,500	6,300	10,800	3,150	7,500	3,100	6,000	1,550	7,200	2,650	5,750	1,350	7,200	2,900	5,760	1,450	
	5DC~8DC	10,125	4,400	8,100	2,200	5,650	2,300	4,500	1,150	5,400	1,850	4,350	950	5,400	2,000	4,320	1,000	
10	3DC以下	17,000	9,000	13,600	4,500	10,000	4,300	8,000	2,150	9,600	3,800	7,700	1,900	9,600	4,200	7,680	2,100	
	3DC~5DC	12,750	6,300	10,200	3,150	7,500	3,100	6,000	1,550	7,200	2,650	5,750	1,350	7,200	2,900	5,760	1,450	
	5DC~8DC	9,550	4,400	7,640	2,200	5,650	2,300	4,500	1,150	5,400	1,850	4,350	950	5,400	2,000	4,320	1,000	
12	3DC以下	17,000	9,000	13,600	4,500	10,000	4,300	8,000	2,150	9,600	3,800	7,700	1,900	9,600	4,200	7,680	2,100	
	3DC~5DC	12,750	6,300	10,200	3,150	7,500	3,100	6,000	1,550	7,200	2,650	5,750	1,350	7,200	2,900	5,760	1,450	
	5DC~8DC	9,550	4,400	7,650	2,200	5,650	2,300	4,500	1,150	5,400	1,850	4,350	950	5,400	2,050	4,320	1,050	
16	3DC以下	17,000	9,000	13,600	4,500	10,000	4,300	8,000	2,150	9,600	3,800	7,700	1,900	9,600	4,200	7,680	2,100	
	3DC~5DC	12,750	6,300	10,200	3,150	7,500	3,100	6,000	1,550	7,200	2,650	5,750	1,350	7,200	2,900	5,760	1,450	
	5DC~8DC	9,550	4,400	7,650	2,200	5,625	2,300	4,500	1,150	5,400	1,850	4,350	950	5,400	2,050	4,320	1,050	

- 【注意】**
- 被削材、加工形状に合わせて、適切なクーラントを使用してください。
 - この切削条件表は切削条件の目安を示すものです。実際の加工では加工形状、目的、使用機械等により条件を調整してください。
 - 切込み量 a_p は目安です。機械剛性、ワーク剛性により調節してください。 a_p を小さくすれば送りはさらに上がります。
 - 水溶性切削液のご使用を推奨いたします。
 - 機械の回転数が足りない場合は、回転数と送り速度を同じ比率で下げてください。

- 【Note】**
- Use the appropriate coolant for the work material and machining shape.
 - These conditions are for general guidance; in actual machining conditions adjust the parameters according to your actual machine and work-piece conditions.
 - The recommended a_p (depth of cut) is a general recommend. Please adjust basing on your machine and work piece rigidity. If a_p is reduced, higher feed should be possible.
 - Please apply water base coolant, when using EMXA series.
 - If the machine rotation speed is insufficient, reduce the rotation speed and feed rage by the same ratio.

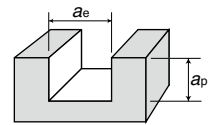

<溝切削> Slotting

2枚刃タイプ 2Flutes type



被削材 Work material			アルミニウム合金(A7075等) Aluminum alloys				アルミニウム合金鋳物(AC4A等) Cast Aluminum alloys				銅・銅合金(C1100等) Copper, Copper alloys				樹脂等 Resin etc.			
外径DC Tool dia. (mm)	首下長 Under neck length (mm)	切込み Depth of cut ap, ae (mm)	高速条件 High speed		汎用条件 General		高速条件 High speed		汎用条件 General		高速条件 High speed		汎用条件 General		高速条件 High speed		汎用条件 General	
			回転数 min ⁻¹	送り mm/min	回転数 min ⁻¹	送り mm/min	回転数 min ⁻¹	送り mm/min	回転数 min ⁻¹	送り mm/min	回転数 min ⁻¹	送り mm/min	回転数 min ⁻¹	送り mm/min	回転数 min ⁻¹	送り mm/min	回転数 min ⁻¹	送り mm/min
10	45	ap≤0.5DC ae≤1.0DC	22,000	2,640	6,000	1,280	18,500	1,840	5,100	960	10,000	1,200	3,500	600	10,120	1,320	3,500	640
	60		20,000	2,400	5,500	1,200	17,000	1,680	4,700	800	9,200	1,120	3,200	560	9,200	1,200	3,200	600
12	45		24,000	5,280	7,700	1,760	21,000	3,680	6,500	1,200	11,000	2,400	3,500	800	11,040	2,640	3,500	880
	60		22,000	4,800	7,000	1,600	18,500	3,360	5,800	1,120	10,000	2,160	3,200	736	10,120	2,400	3,200	800
16	45		29,000	5,760	11,000	1,920	24,500	4,000	9,200	1,360	13,000	2,640	5,000	880	13,340	2,880	5,000	960
	60		26,000	5,280	9,900	1,760	22,000	3,680	8,300	1,200	12,000	2,400	4,500	800	11,960	2,640	4,500	880
	75		24,000	4,800	9,000	1,600	20,000	3,360	7,500	1,120	11,000	2,160	4,100	720	11,040	2,400	4,100	800
20	45		30,000	6,400	9,300	1,040	25,000	4,480	7,800	720	14,000	2,960	4,300	480	13,800	3,200	4,300	520
	60		27,000	5,840	8,500	960	23,000	4,080	7,100	680	12,500	2,640	3,900	440	12,420	2,920	3,900	480
	80		24,000	5,280	7,700	880	20,000	3,680	6,500	600	11,000	2,400	3,500	400	11,040	2,640	3,500	440
	100		22,000	4,800	7,000	800	18,500	3,360	5,800	560	10,000	2,160	3,200	360	10,120	2,400	3,200	400
25	45		24,000	6,400	11,000	1,040	20,000	4,480	9,200	720	11,000	2,960	5,000	480	11,040	3,200	5,000	520
	60	22,000	5,840	10,000	960	18,500	4,080	8,400	680	10,000	2,640	4,600	440	10,120	2,920	4,600	480	
	80	20,000	5,280	8,800	880	16,800	3,680	7,400	600	9,200	2,400	4,000	400	9,200	2,640	4,000	440	
	100	18,000	4,800	8,000	800	15,000	3,360	6,700	560	8,300	2,160	3,700	370	8,280	2,400	3,700	400	

<溝切削> Slotting

3枚刃タイプ 3Flutes type

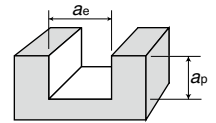

被削材 Work material			アルミニウム合金(A7075等) Aluminum alloys				アルミニウム合金鋳物(AC4A等) Cast Aluminum alloys				銅・銅合金(C1100等) Copper, Copper alloys				樹脂等 Resin etc.			
外径DC Tool dia. (mm)	首下長 Under neck length (mm)	切込み Depth of cut ap, ae (mm)	高速条件 High speed		汎用条件 General		高速条件 High speed		汎用条件 General		高速条件 High speed		汎用条件 General		高速条件 High speed		汎用条件 General	
			回転数 min ⁻¹	送り mm/min	回転数 min ⁻¹	送り mm/min	回転数 min ⁻¹	送り mm/min	回転数 min ⁻¹	送り mm/min	回転数 min ⁻¹	送り mm/min	回転数 min ⁻¹	送り mm/min	回転数 min ⁻¹	送り mm/min	回転数 min ⁻¹	送り mm/min
3	3DC以下	ap≤0.5DC ae=1.0DC	20,000	3,000	16,000	1,800	17,000	2,200	13,600	1,350	16,000	2,000	8,000	1,000	16,000	2,200	8,000	1,100
	3DC~5DC		15,000	2,300	12,000	1,350	12,750	1,700	10,200	1,050	12,000	1,500	6,000	750	12,000	1,650	6,000	850
	5DC~8DC		11,250	1,700	9,000	1,050	9,500	1,200	7,600	750	9,000	1,125	4,500	550	9,000	1,250	4,500	650
4	3DC以下		19,000	3,300	15,200	2,000	16,000	2,250	12,800	1,350	15,000	2,050	7,500	1,050	15,000	2,250	7,500	1,150
	3DC~5DC		14,250	2,400	11,400	1,450	12,000	1,700	9,600	1,050	11,250	1,500	5,650	750	11,250	1,650	5,650	850
	5DC~8DC		10,700	1,900	8,650	1,150	9,000	1,300	7,200	750	8,450	1,150	4,250	550	8,450	1,250	4,250	650
5	3DC以下		16,000	3,400	12,800	2,050	14,000	2,400	11,200	1,450	13,500	2,050	6,750	1,025	13,500	2,250	6,750	1,150
	3DC~5DC		12,000	2,500	9,600	1,500	10,500	1,800	8,400	1,050	10,125	1,500	5,050	750	10,125	1,650	5,050	850
	5DC~8DC		9,000	2,000	7,200	1,200	7,850	1,300	6,280	750	7,600	1,150	3,800	550	7,600	1,250	3,800	650
6	3DC以下		13,000	3,600	10,400	2,150	11,000	2,550	8,800	1,550	10,500	2,000	5,250	1,000	10,500	2,200	5,250	1,100
	3DC~5DC		9,750	2,700	7,800	1,600	8,250	1,900	6,600	1,150	7,900	1,500	3,950	750	7,900	1,650	3,950	850
	5DC~8DC		7,300	2,000	5,840	1,200	6,200	1,400	4,960	850	5,950	1,150	3,000	550	5,950	1,250	3,000	650
8	3DC以下	9,500	3,900	7,600	2,350	8,000	2,700	6,400	1,650	7,500	2,250	3,750	1,150	7,500	2,500	3,750	1,250	
	3DC~5DC	7,150	3,000	5,700	1,800	6,000	2,000	4,800	1,200	5,650	1,700	2,850	850	5,650	1,900	2,850	950	
	5DC~8DC	5,350	2,200	4,250	1,350	4,500	1,500	3,600	900	4,250	1,250	2,150	650	4,250	1,400	2,150	700	
10	3DC以下	7,600	3,900	6,050	2,350	6,400	2,700	5,150	1,650	6,000	2,250	3,000	1,150	6,000	2,500	3,000	1,250	
	3DC~5DC	5,700	3,000	4,550	1,800	4,800	2,000	3,850	1,200	4,500	1,700	2,250	850	4,500	1,900	2,250	950	
	5DC~8DC	4,250	2,200	3,400	1,350	3,600	1,500	2,850	900	3,400	1,250	1,700	650	3,400	1,400	1,700	700	
12	3DC以下	7,600	3,900	6,050	2,350	6,400	2,700	5,150	1,650	6,000	2,250	3,000	1,150	6,000	2,500	3,000	1,250	
	3DC~5DC	5,700	3,000	4,550	1,800	4,800	2,000	3,850	1,200	4,500	1,700	2,250	850	4,500	1,900	2,250	950	
	5DC~8DC	4,250	2,200	3,400	1,350	3,600	1,500	2,850	900	3,400	1,250	1,700	650	3,400	1,400	1,700	700	
16	3DC以下	7,600	3,900	6,050	2,350	6,400	2,700	5,150	1,650	6,000	2,250	3,000	1,150	6,000	2,500	3,000	1,250	
	3DC~5DC	5,700	3,000	4,550	1,800	4,800	2,000	3,850	1,200	4,500	1,700	2,250	850	4,500	1,900	2,250	950	
	5DC~8DC	4,250	2,200	3,400	1,350	3,600	1,500	2,850	900	3,400	1,250	1,700	650	3,400	1,400	1,700	700	

[注意] ①この切削条件表は切削条件の目安を示すものです。実際の加工では加工形状、目的、使用機械等により条件を調整してください。
②切込み量apは目安です。機械剛性、ワーク剛性により調節してください。apを小さくすれば送りはさらに上がります。
③水溶性切削液のご使用を推奨いたします。
④機械の回転数が足りない場合は、回転数と送り速度を同じ比率で下げてください。

[Note] ①These conditions are for general guidance; in actual machining conditions adjust the parameters according to your actual machine and work-piece conditions.
②The recommended ap (depth of cut) is a general recommend. Please adjust basing on your machine and work piece rigidity. If ap is reduced, higher feed should be possible.
③Please apply water base coolant, when using EMXA series.
④If the machine rotation speed is insufficient, reduce the rotation speed and feed rate by the same ratio.

Multi Flutes Taper Raidus End Mill 多刃テーパラジアスエンドミル

受注生産品

Made-to-order items



(mm)

難削材対応刃形と多刃化による高送り加工の実現!
最新鋭の機械との組合せにより更なる高送り加工も可能!
Flute shape compatible with difficult-to-cut materials and use of multiple flutes realizes high-feed-rate machining!
Enables even higher feed rate machining when combined with state-of-the-art machines!



※コーナ半径及び刃部テーパ半角の別サイズについては別途ご相談ください
For tools with other sizes of corner radius or taper angle on side, please ask our sales office.



寸法 Size (mm)					刃部テーパ半角※ Taper angle on side (°)	刃数 No. of flutes	備考 Note
外径 Tool dia.	コーナ半径※ Corner radius	刃長 Flute length	全長 Overall length	シャンク径 Shank dia.			
DC	RE	APMX	LF	DCONMS	BHTA1		
11	1.0	3.56	100	12	8	9	3穴OH付 With 3 oil holes
15	1.0	3.56	110	16	8	12	3穴OH付 With 3 oil holes
19	1.0	3.56	110	20	8	12	3穴OH付 With 3 oil holes

オイルホールなしも製作可能です。Products without oil holes can also be manufactured.

標準切削条件表 Recommended cutting conditions

外径 DC Tool dia. (mm)	切込み $a_p \times a_e$ Depth of cut (mm)	ステンレス鋼 Stainless steels (12Cr鋼、SUS400系、SUS600系)		超耐熱合金 Super heat-resistant alloys (Ni 基合金等) (Nickel based alloys etc.)	
		回転数 n min^{-1}	送り速度 v_f mm/min	回転数 n min^{-1}	送り速度 v_f mm/min
11	0.3×0.9	5,790	3,130	2,320	1,040
15	0.4×1.2	4,250	3,060	1,700	1,020
19	0.5×1.5	3,350	3,220	1,340	1,130

- 【注意】**
- 被削材、加工形状に合わせて、適切なクーラントを使用してください。
 - できるだけ高剛性、高精度の機械およびチャックをご使用ください。
 - この標準切削条件表は切削条件の目安を示すものです。実際の加工では、加工条件、目的、使用機械等により条件を調整してください。
 - ビビリや異常振動が発生する場合は条件を調整してください。
 - オイルホールにより一部底刃が切れている部分があるため、底刃を使用した座繰り加工やヘリカル加工等には不適です。

- 【Note】**
- Use the appropriate coolant for the work material and machining shape.
 - Use the high-rigidity and high accuracy machine as possible.
 - Cutting parameters in shown table are general recommendation. Please adjust it if chatter or abnormal vibration occurs.
 - If chattering or abnormal vibrations occur, adjust the conditions.
 - Since part of the bottom flute is cut due to the oil hole, it is not suitable for spot facing, helical milling, etc. using the bottom flute.

対応被削材 Applicable work materia

炭素鋼 合金鋼 Carbon steel Alloy steel	プリハードン鋼 Pre-hardened steel ≤ 45HRC	高硬度 Hardened steel			ステンレス鋼 Stainless steel	チタン合金 耐熱合金 Titanium alloy Heat-resistant alloy	銅合金 Copper alloy	アルミ合金 Aluminum alloy
		> 45HRC ≤ 55HRC	> 55HRC ≤ 65HRC	> 65HRC				
					○	○		

再研磨対応外径範囲 Re-grinding compatibility range

商品コード Item code	外周 Outer dia. (mm)	エンド End (mm)
	11 ~ 19	11 ~ 19

●：標準在庫品です。●：Stocked items. 干涉なし：No interference

Epoch HD Coating Deep Radius End Mill エポックHDコーティングディープラジアエンドミル

ダイヤモンドコーティング Diamond Coating



グラファイト・高Siアルミ合金・FRP加工に適しています。
ダイヤモンドコーティング。

Ideal for machining of graphite, high-Si aluminum alloys, and FRP. Diamond Coating.

2枚刃
2Flutes

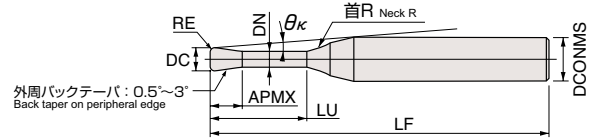

EGDR2-○○○-○○-○○-HD



商品コード Item code	在庫 Stock	寸法 Size (mm)								干渉角度 Interference angle (°)	勾配角に対する実有効首下長 Effective under neck length with respect to draft angle					希望小売価格(円) Suggested retail price(¥)
		外径 Tool dia. DC	コーナ半径 Corner radius RE	首下長 Under neck length LU	首径 Neck dia. DN	刃長 Flute length APMX	全長 Overall length LF	シャンク径 Shank dia. DCONMS	首R Neck R		0.5°	1°	1.5°	2°	3°	
EGDR2005-5-01-HD	●	0.5	0.1	5	0.47	0.75	60	4	10	7.55	6.16	6.59	6.96	7.29	7.87	33,530
EGDR2005-10-01-HD	●	0.5	0.1	10	0.47	0.75	60	4	10	5.5	11.5	12.1	12.59	13.01	13.75	33,530
EGDR2005-15-01-HD	●	0.5	0.1	15	0.47	0.75	60	4	10	4.32	16.78	17.5	18.07	18.57	19.97	35,670
EGDR2005-20-01-HD	●	0.5	0.1	20	0.47	0.75	60	4	10	3.56	22.02	22.84	23.48	24.03	26.6	37,820
EGDR2010-10-02-HD	●	1	0.2	10	0.96	1.5	60	4	10	5.06	11.53	12.12	12.6	13.02	13.75	33,530
EGDR2010-20-02-HD	●	1	0.2	20	0.96	1.5	60	4	10	3.19	22.04	22.85	23.49	24.04	26.6	33,530
EGDR2010-30-02-HD	●	1	0.2	30	0.96	1.5	80	4	10	2.33	32.43	33.41	34.29	35.97	干渉なし	35,670
EGDR2010-40-02-HD	●	1	0.2	40	0.96	1.5	80	4	10	1.83	42.77	43.87	45.69	干渉なし	干渉なし	37,820
EGDR2015-20-02-HD	●	1.5	0.2	20	1.44	2.25	60	4	10	2.78	22.09	22.88	23.52	24.06	干渉なし	33,530
EGDR2015-40-02-HD	●	1.5	0.2	40	1.44	2.25	80	4	10	1.57	42.8	43.9	45.75	干渉なし	干渉なし	35,670
EGDR2020-20-02-HD	●	2	0.2	20	1.92	3	60	4	10	2.32	22.13	22.92	23.55	24.11	干渉なし	33,530
EGDR2020-40-02-HD	●	2	0.2	40	1.92	3	80	4	10	1.29	42.84	43.92	干渉なし	干渉なし	干渉なし	35,670
EGDR2020-60-02-HD	●	2	0.2	60	1.92	3	100	4	10	0.89	63.38	干渉なし	干渉なし	干渉なし	干渉なし	37,820
EGDR2030-20-02-HD	●	3	0.2	20	2.88	4.5	60	4	10	1.25	22.23	22.99	干渉なし	干渉なし	干渉なし	33,530
EGDR2030-40-02-HD	●	3	0.2	40	2.88	4.5	80	4	10	0.67	42.9	干渉なし	干渉なし	干渉なし	干渉なし	33,530
EGDR2030-60-02-HD	●	3	0.2	60	2.88	4.5	100	4	10	0.46	干渉なし	干渉なし	干渉なし	干渉なし	干渉なし	35,670

首下詳細形状

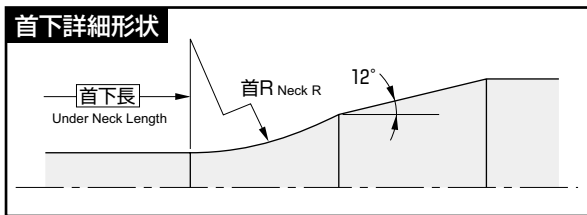

【注意】

加工物に勾配がついている場合、干渉領域は、首下長さよりも長くなります。それぞれの勾配角に対する実有効首下長をご参照ください。
また、工具が加工物に干渉する角度を干渉角度 θ_{κ} で表示していますので合わせてご参照ください。

【Note】

If the workpiece has draft angle, the interference length will be longer than the under-neck length. Please refer to the effective under-neck length for the various draft angles.
In addition, the angle at which the tool will interfere with the workpiece is shown as the "interference angle θ_{κ} ", and should also be referred to.

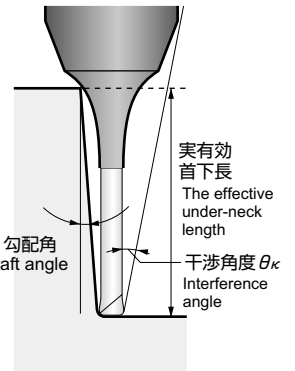

○ 対応被削材 Applicable work material

炭素鋼 合金鋼 Carbon steel Alloy steel	プリハード ド鋼 Pre-hardened steel	高硬度 Hardened steel			ステン レス鋼 Stainless steel	チタン合金 耐熱合金 Titanium alloy Heat-resistant alloy	銅合金 Copper alloy	アルミ 合金 Aluminum alloy
		> 45HRC ≤ 55HRC	> 55HRC ≤ 65HRC	> 65HRC				

グラファイト・FRP・高Siアルミニウム合金など for Graphite, FRP, High Si aluminum alloy etc.

○ 再研磨対応外径範囲 Re-grinding compatibility range

商品コード Item code	外周 Outer dia. (mm)	エンド End (mm)
EGDR-HD	× (N/A)	× (N/A)

●：標準在庫品です。●：Stocked items. 干渉なし：No interference

○ 標準切削条件表 Recommended cutting conditions

EGDR-HD

商品コード Item code	外径DC Tool dia. (mm)	コーナ半径RE Corner radius (mm)	首下長LU Under neck length (mm)	L/D	被削材 Work material	グラファイト Graphite		アルミニウム合金鋳物 Cast aluminum alloys AC4A,ADC12等 (エアブローorウエット:水溶性) (Air-blow or wet:water-soluble agent)	
						切込み量 Depth of cut (mm) $a_p \times a_e$	回転数 n min^{-1}	送り速度 v_f mm/min	回転数 n min^{-1}
EGDR2005-5-01-HD	0.5	0.1	5	10	0.05×0.4	15,000~18,000	700~900	13,000~18,000	400~600
EGDR2005-10-01-HD	0.5	0.1	10	20	0.05×0.4	14,000~16,000	650~800	13,000~18,000	300~600
EGDR2005-15-01-HD	0.5	0.1	15	30	0.045×0.4	12,000~15,000	650~750	11,000~16,000	200~500
EGDR2005-20-01-HD	0.5	0.1	20	40	0.04×0.4	10,000~13,000	600~700	9,000~14,000	200~400
EGDR2010-10-02-HD	1	0.2	10	10	0.1×0.8	13,000~16,000	650~800	10,000~15,000	300~600
EGDR2010-20-02-HD	1	0.2	20	20	0.1×0.8	12,000~14,000	600~700	8,000~13,000	300~600
EGDR2010-30-02-HD	1	0.2	30	30	0.08×0.8	10,000~12,000	550~650	6,000~11,000	250~500
EGDR2010-40-02-HD	1	0.2	40	40	0.06×0.8	9,000~11,000	500~600	5,000~10,000	250~500
EGDR2015-20-02-HD	1.5	0.2	20	13	0.15×1.0	12,000~15,000	700~850	10,000~15,000	350~600
EGDR2015-40-02-HD	1.5	0.2	40	27	0.12×1.0	10,000~12,000	650~750	7,000~12,000	300~500
EGDR2020-20-02-HD	2	0.2	20	10	0.2×1.4	12,000~15,000	650~800	10,000~15,000	350~650
EGDR2020-40-02-HD	2	0.2	40	20	0.16×1.4	10,000~13,000	500~750	7,000~12,000	300~550
EGDR2020-60-02-HD	2	0.2	60	30	0.12×1.4	8,000~10,000	550~700	5,000~10,000	250~500
EGDR2030-20-02-HD	3	0.2	20	7	0.3×2.1	10,000~13,000	750~850	10,000~15,000	350~650
EGDR2030-40-02-HD	3	0.2	40	13	0.24×2.1	8,000~10,000	650~750	7,000~12,000	300~650
EGDR2030-60-02-HD	3	0.2	60	20	0.2×2.1	7,000~9,000	600~700	5,000~10,000	250~600

- 【注意】** ①被削材、加工形状に合わせて、適切なクーラントを使用してください。
②この標準切削条件表は切削条件の目安を示すものです。実際の加工では加工形状、目的、使用機械等により条件を調整してください。

- 【Note】** ①Use the appropriate coolant for the work material and machining shape.
②These Recommended Cutting Conditions indicate only the rule of a thumb for the cutting conditions. In actual machining, the condition should be adjusted according to the machining shape, purpose and the machine type.

Epoch HD Coating Radius End Mill エポックHDコーティングラジアスエンドミル

ダイヤモンドコーティング Diamond Coating

h5

グラファイト・高Siアルミ合金・FRP加工に適しています。
ダイヤモンドコーティング。
Ideal for machining of graphite, high-Si aluminum alloys, and FRP.
Diamond Coating.

2枚刃
2Flutes

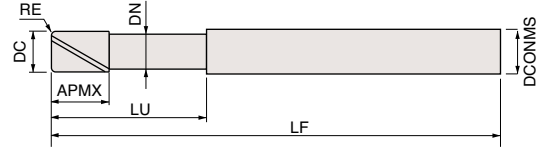

EGR2○○○-05-HD

超硬 Carbide **HD** 傾斜角 Helix angle 30° 切削条件表 Cutting Conditions **A279**

商品コード Item code	在庫 Stock	寸法 Size (mm)							希望小売価格 (円) Suggested retail price(¥)
		外径 Tool dia. DC	コーナ半径 Corner radius RE	首下長 Under neck length LU	首径 Neck dia. DN	刃長 Flute length APMX	全長 Overall length LF	シャンク径 Shank dia. DCONMS	
EGR2040-05-HD	●	4	0.5	40	3.9	8	100	4	41,350
EGR2060-05-HD	●	6		60	5.9	12	120	6	53,080
EGR2080-05-HD	●	8		80	7.9	16	140	8	65,200
EGR2100-05-HD	●	10		100	9.9	20	150	10	84,840

標準切削条件表 Recommended cutting conditions

EGR-HD

被削材 Work material	グラファイト Graphite		アルミニウム合金鋳物 Cast aluminum alloys AC4A,ADC12等 (エアブローorウエット水溶性) (Air-blow or wet:water-soluble agent)		
	外径DC Tool Dia. (mm)	回転数 n min ⁻¹	送り速度 v_f mm/min	回転数 n min ⁻¹	送り速度 v_f mm/min
切込み量 Depth of cut (mm)	4	8,000~10000	1,300~1,600	6,000~9,000	900~1,300
	6	7,000~9000	1,500~1,800	5,000~8,000	800~1,200
	8	6,000~8000	1,700~2,000	4,000~7,000	700~1,100
	10	6,000~8000	1,900~2,200	3,000~6,000	600~1,000

$a_p \leq 0.1DC$
 $a_e \leq 0.8DC$

[注意] ①被削材、加工形状に合わせて、適切なクーラントを使用してください。
②この標準切削条件表は切削条件の目安を示すものです。実際の加工では加工形状、目的、使用機械等により条件を調整してください。

[Note] ① Use the appropriate coolant for the work material and machining shape.
② These Recommended Cutting Conditions indicate only the rule of a thumb for the cutting conditions.
In actual machining, the condition should be adjusted according to the machining shape, purpose and the machine type.

対応被削材 Applicable work material

炭素鋼 合金鋼 Carbon steel Alloy steel	プリハードン鋼 Pre-hardened steel $\leq 45HRC$	高硬度 Hardened steel			ステンレス鋼 Stainless steel	チタン合金 耐熱合金 Titanium alloy Heat-resistant alloy	銅合金 Copper alloy	アルミ 合金 Aluminum alloy
		> 45HRC $\leq 55HRC$	> 55HRC $\leq 65HRC$	> 65HRC				

グラファイト・FRP・高Siアルミニウム合金など for Graphite, FRP, High Si aluminum alloy etc.

再研磨対応外径範囲 Re-grinding compatibility range

商品コード Item code	外周 Outer dia. (mm)	エンド End (mm)
EGR-HD	× (N/A)	× (N/A)

●：標準在庫品です。●：Stocked items.

Ceramic End Mill Corner Radius Type

セラミックエンドミル コーナRタイプ

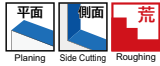

外径公差 Dia tolerance	-0.01 ~ -0.04	RE公差 RE tolerance	±0.02	h5	(mm)
-----------------------	---------------	----------------------	-------	----	------

次世代の高効率加工を実現!
 切削速度 $v_c=800\text{m/min}$ を実現!!
 Achieves next-generation high-performance machining!
 Achieves cutting speed of $v_c=800\text{m/min}$!.

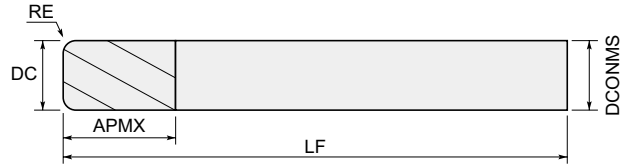

SCE6○○○○-R○.○○○



商品コード Item code	在庫 Stock	寸法 Size (mm)					刃数 No. of flutes	希望小売価格(円) Suggested retail price(¥)
		外径 Tool dia.	刃長 Flute length	コーナ半径 Corner radius	全長 Overall length	シャンク径 Shank dia.		
		DC	APMX	RE	LF	DCONMS		
SCE6060-R0.75	●	6	6	0.75	60	6	6	38,380
SCE6080-R1.00	●	8	8	1	70	8	6	49,150
SCE6100-R1.25	●	10	10	1.25	80	10	6	59,470
SCE6120-R1.50	●	12	12	1.5	80	12	6	71,140

標準切削条件表 Recommended cutting conditions

被削材：超耐熱合金

Work material : Super heat resistant alloys

外径 DC Tool dia. (mm)	切削速度 v_c Cutting speed (m/min)	一刃送り f_z Feed per tooth (mm/t)	平面 Planing		側面 Side cutting	
			切込み a_p Depth of cut (mm)	切込み a_e Depth of cut (mm)	切込み a_p Depth of cut (mm)	切込み a_e Depth of cut (mm)
6	400~1,000	0.024	0.3以下 or less	3.0以下 or less	6.0以下 or less	0.6以下 or less
8		0.028	0.4以下 or less	4.0以下 or less	8.0以下 or less	0.8以下 or less
10		0.03	0.5以下 or less	5.0以下 or less	10.0以下 or less	1.0以下 or less
12		0.032	0.6以下 or less	6.0以下 or less	12.0以下 or less	1.2以下 or less

対応被削材 Applicable work material

炭素鋼 合金鋼 Carbon steel Alloy steel	プリハー ド鋼 Pre-hardened steel ≤ 45HRC	高硬度 Hardened steel			ステン レス鋼 Stainless steel	チタン合金 耐熱合金 Titanium alloy Heat-resistant alloy	銅合金 Copper alloy	アルミ 合金 Aluminum alloy
		> 45HRC ≤ 55HRC	> 55HRC ≤ 65HRC	> 65HRC				

再研磨対応外径範囲 Re-grinding compatibility range

商品コード Item code	外周 Outer dia. (mm)
SCE-R	6 ~ 12

Epoch CBN Super Radius End Mill

エポックCBNスーパーラジアスエンドミル



切れ味と刃先強度を両立した新発想CBNエンドミル。

New-concept CBN end mill providing both good cutting performance and strong flute edges.

Includes actual measured mill diameter value.

外径実測値付き

RE公差 ±0.005 (中心基準 central axis)

h4

(mm)

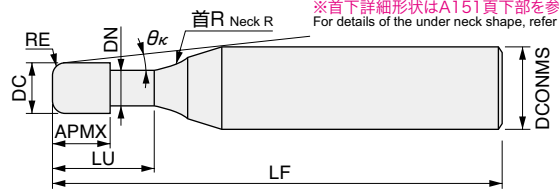

※首下詳細形状はA151頁下部を参照ください
For details of the under neck shape, refer to p. A151

CBN-EP SR2 ○○○○ - ○○○○ - ○○○○ ※外径実測値をケースに表示しています

Actual measured mill diameter value is shown on case.

CBN 切削条件表 A282 Cutting Conditions

商品コード Item code	在庫 Stock	寸法 Size (mm)					全数外径実測値表示			干渉角度 Interference angle (°)	勾配角に対する実有効首下長					希望小売 価格(¥) Suggested retail price(¥)			
		外径 Tool dia. DC	コーナ 半径 Corner radius RE	首下長 Under neck length LU	刃長 Flute length APMX	首径 Neck dia. DN	全長 Overall length LF	シャンク径 Shank dia. DC ONMS	首R Neck R		0.5°	1°	1.5°	2°	3°				
CBN-EP SR2002-0.5-005	●	0.2	0.05	0.5	0.07	0.18	50	4	1	11.39	0.67	0.7	0.73	0.76	0.81	29,680			
CBN-EP SR2002-1-005	●			1	0.07	0.18	50	4	1	10.83	1.19	1.24	1.28	1.32	1.39	30,530			
CBN-EP SR2003-0.5-005	●	0.3	0.05	0.5	0.11	0.27	50	4	1	11.35	0.7	0.73	0.75	0.78	0.82	29,350			
CBN-EP SR2003-0.75-005	●			0.75	0.11	0.27	50	4	1	11.05	0.96	0.99	1.03	1.06	1.12	29,780			
CBN-EP SR2003-1.5-005	●			1.5	0.11	0.27	50	4	1	10.26	1.74	1.79	1.84	1.89	2.06	30,110			
CBN-EP SR2003-2-005	●			2	0.11	0.27	50	4	1	9.79	2.25	2.32	2.38	2.46	2.73	30,530			
CBN-EP SR2004-0.5-005	●	0.4	0.05	0.5	0.14	0.37	50	4	1	11.33	0.7	0.73	0.75	0.78	0.82	27,850			
CBN-EP SR2004-1-005	●			1	0.14	0.37	50	4	1	10.75	1.22	1.26	1.3	1.34	1.4	28,070			
CBN-EP SR2004-2-005	●			2	0.14	0.37	50	4	1	9.74	2.25	2.32	2.38	2.46	2.73	28,710			
CBN-EP SR2005-0.5-005	●	0.5	0.05	0.5	0.18	0.47	50	4	1	11.31	0.7	0.73	0.75	0.78	0.82	22,820			
CBN-EP SR2005-1.5-005	●			1.5	0.18	0.47	50	4	1	10.18	1.74	1.79	1.84	1.89	2.06	23,250			
CBN-EP SR2005-3-005	●			3	0.18	0.47	50	4	1	8.84	3.29	3.37	3.49	3.66	4.05	24,530			
CBN-EP SR2005-0.5-01	●			0.5	0.18	0.47	50	4	1	11.37	0.7	0.72	0.75	0.77	0.82	22,820			
CBN-EP SR2005-1.5-01	●			1.5	0.18	0.47	50	4	1	10.23	1.74	1.79	1.84	1.88	2.05	23,250			
CBN-EP SR2005-3-01	●	3	0.18	0.47	50	4	1	8.88	3.28	3.37	3.48	3.65	4.04	24,530					
CBN-EP SR2006-1.5-01	●	0.6	0.1	1.5	0.21	0.57	50	4	1	10.18	1.74	1.79	1.84	1.88	2.05	23,250			
CBN-EP SR2006-3-01	●			3	0.21	0.57	50	4	1	8.82	3.28	3.37	3.48	3.65	4.04	24,530			
CBN-EP SR2008-2.5-01	●	0.8	0.1	2.5	0.28	0.77	50	4	1	9.1	2.77	2.84	2.91	3.05	3.37	25,500			
CBN-EP SR2008-5-01	●			5	0.28	0.77	50	4	1	7.3	5.34	5.51	5.76	6.04	6.69	26,240			
CBN-EP SR2010-1-005	●	1	0.05	1	0.35	0.96	50	4	1	10.5	1.24	1.28	1.32	1.35	1.43	21,320			
CBN-EP SR2010-2.5-005	●			2.5	0.35	0.96	50	4	1	8.88	2.79	2.86	2.95	3.09	3.42	21,320			
CBN-EP SR2010-5-005	●			5	0.35	0.96	50	4	1	7.07	5.35	5.54	5.8	6.08	6.74	24,100			
CBN-EP SR2010-1-01	●			1	0.35	0.96	50	4	1	10.56	1.24	1.28	1.31	1.35	1.42	21,320			
CBN-EP SR2010-2.5-01	●			2.5	0.35	0.96	50	4	1	8.93	2.79	2.86	2.94	3.08	3.41	21,320			
CBN-EP SR2010-5-01	●		5	0.35	0.96	50	4	1	7.1	5.35	5.54	5.79	6.07	6.72	24,100				
CBN-EP SR2010-2.5-02	●		0.2	0.1	2.5	0.35	0.96	50	4	1	9.02	2.78	2.85	2.93	3.06	3.37	21,320		
CBN-EP SR2010-5-02	●				5	0.35	0.96	50	4	1	7.16	5.35	5.53	5.78	6.05	6.69	24,100		
CBN-EP SR2010-10-02	●				10	0.35	0.96	50	4	1	5.06	10.51	10.97	11.48	12.03	13.33	26,780		
CBN-EP SR2015-2-005	●				1.5	0.05	2	0.53	1.44	50	4	1	8.92	2.31	2.36	2.43	2.55	2.82	22,180
CBN-EP SR2015-5-005	●	5					0.53	1.44	50	4	1	6.5	5.38	5.59	5.85	6.14	6.8	25,070	
CBN-EP SR2015-2-01	●	2	0.53	1.44			50	4	1	8.97	2.31	2.36	2.42	2.54	2.8	22,180			
CBN-EP SR2015-5-01	●	5	0.53	1.44		50	4	1	6.53	5.38	5.59	5.84	6.13	6.79	25,070				
CBN-EP SR2015-5-02	●	0.2	0.1	5		0.53	1.44	50	4	1	6.59	5.38	5.58	5.83	6.11	6.75	25,070		
CBN-EP SR2015-10-02	●			10		0.53	1.44	50	4	1	4.52	10.56	11.03	11.53	12.09	13.39	27,850		
CBN-EP SR2020-3-005	●	2	0.05	3	0.7	1.92	50	4	1	7.27	3.36	3.46	3.62	3.8	4.21	25,930			
CBN-EP SR2020-5-005	●			5	0.7	1.92	50	4	1	5.81	5.4	5.64	5.91	6.19	6.87	25,930			
CBN-EP SR2020-10-005	●			10	0.7	1.92	50	4	1	3.86	10.62	11.09	11.61	12.18	13.5	28,920			
CBN-EP SR2020-3-01	●			0.1	0.1	3	0.7	1.92	50	4	1	7.32	3.36	3.46	3.62	3.79	4.19	25,930	
CBN-EP SR2020-5-01	●					5	0.7	1.92	50	4	1	5.84	5.4	5.64	5.9	6.18	6.85	25,930	
CBN-EP SR2020-10-01	●		10			0.7	1.92	50	4	1	3.87	10.62	11.09	11.6	12.17	13.49	28,920		
CBN-EP SR2020-5-02	●		0.2			0.1	5	0.7	1.92	50	4	1	5.9	5.4	5.63	5.88	6.16	6.82	25,930
CBN-EP SR2020-10-02	●						10	0.7	1.92	50	4	1	3.9	10.61	11.08	11.59	12.15	13.45	28,820
CBN-EP SR2020-20-02	●				20	0.7	1.92	55	4	1	2.32	21.04	21.97	22.99	24.11	干渉なし	33,210		
CBN-EP SR2030-6-005	●		3	0.05	6	1.05	2.86	50	4	1	3.32	6.59	6.89	7.21	7.56	8.38	32,890		
CBN-EP SR2030-6-01	●	6			1.05	2.86	50	4	1	3.34	6.59	6.88	7.2	7.55	8.36	32,890			
CBN-EP SR2030-6-05	●	6			1.05	2.86	50	4	1	3.5	6.57	6.85	7.14	7.47	8.24	32,890			

対応被削材 Applicable work material

炭素鋼 合金鋼 Carbon steel Alloy steel	プリハー ド鋼 Pre-hardened steel ≤ 45HRC	高硬度 Hardened steel > 45HRC > 55HRC > 65HRC			ステン レス鋼 Stainless steel	チタン 合金 耐熱合金 Titanium alloy Heat-resistant alloy	銅合金 Copper alloy	アルミ 合金 Aluminum alloy
	○	◎	◎					

● : 標準在庫品です。 ◎ : Stocked items. 干渉なし : No interference

再研磨対応外径範囲 Re-grinding compatibility range

商品コード Item code	外周 Outer dia. (mm)	エンド End (mm)
CBN-EP SR	× (N/A)	× (N/A)

標準切削条件表 Recommended cutting conditions **CBN-EPSR**

＜仕上げ加工条件＞ Finishing condition

被削材 Work material					1		2		3		4		
					焼入れ鋼 Hardened steels (~55HRC) HPM1,SKD61,SKT4		焼入れ鋼 Hardened steels (55~65HRC) SKD11,SKH51		焼入れ鋼 Hardened steels (65~68HRC) SKH,溶製ハイス		焼入れ鋼 Hardened steels (68~72HRC) HAP,粉末ハイス		
切込み比率 Ratio to standard depth of cut					100%		90%		80%		70%		
外径DC Tool dia. (mm)	コーナ半径RE Corner radius (mm)	首下長LU Under neck length (mm)	切込み量 Depth of cut (mm)		回転数 n min ⁻¹	送り速度 vf mm/min	回転数 n min ⁻¹	送り速度 vf mm/min	回転数 n min ⁻¹	送り速度 vf mm/min	回転数 n min ⁻¹	送り速度 vf mm/min	
			ap	ae									
0.2	0.05	0.5	0.004	0.05	50,000	400	48,000	350	45,000	290	43,000	240	
			0.003	0.05	45,000	340	43,000	290	41,000	250	38,000	200	
0.3	0.05	0.5	0.006	0.1	50,000	600	48,000	520	45,000	430	43,000	360	
			0.006	0.1	50,000	600	48,000	520	45,000	430	43,000	360	
		1.5	0.005	0.1	45,000	510	43,000	440	41,000	370	38,000	300	
		2	0.003	0.1	40,000	430	38,000	370	36,000	310	34,000	260	
0.4	0.05	0.5	0.008	0.15	46,000	740	44,000	630	41,000	520	39,000	440	
			0.008	0.15	46,000	740	44,000	630	41,000	520	39,000	440	
		2	0.006	0.15	41,000	620	39,000	530	37,000	450	35,000	370	
0.5	0.05	0.5	0.01	0.2	46,000	920	44,000	790	41,000	660	39,000	550	
			0.01	0.2	46,000	920	44,000	790	41,000	660	39,000	550	
		3	0.005	0.2	37,000	670	35,000	570	33,000	480	31,000	390	
	0.1	0.5	0.01	0.15	46,000	920	44,000	790	41,000	660	39,000	550	
			0.01	0.15	46,000	920	44,000	790	41,000	660	39,000	550	
		3	0.005	0.15	37,000	670	35,000	570	33,000	480	31,000	390	
0.6	0.1	1.5	0.012	0.2	42,000	1,010	40,000	860	38,000	730	36,000	600	
			0.009	0.2	38,000	870	36,000	740	34,000	620	32,000	510	
0.8	0.1	2.5	0.012	0.3	42,000	1,280	40,000	1,090	38,000	920	36,000	770	
			0.008	0.3	38,000	1,090	36,000	930	34,000	780	32,000	650	
1	0.05	1	0.02	0.45	38,000	1,520	36,000	1,300	34,000	1,090	32,000	900	
			0.02	0.45	38,000	1,520	36,000	1,300	34,000	1,090	32,000	900	
		5	0.015	0.45	34,000	1,290	32,000	1,090	31,000	940	29,000	770	
	0.1	1	0.02	0.4	38,000	1,520	36,000	1,300	34,000	1,090	32,000	900	
			0.02	0.4	38,000	1,520	36,000	1,300	34,000	1,090	32,000	900	
		5	0.015	0.4	34,000	1,290	32,000	1,090	31,000	940	29,000	770	
	0.2	2.5	1	0.02	0.3	38,000	1,520	36,000	1,300	34,000	1,090	32,000	900
				0.015	0.3	34,000	1,290	32,000	1,090	31,000	940	29,000	770
		10	5	0.005	0.3	27,000	920	26,000	800	24,000	650	23,000	550
				0.005	0.3	27,000	920	26,000	800	24,000	650	23,000	550
1.5	0.05	2	0.02	0.7	32,000	1,920	30,000	1,620	29,000	1,390	27,000	1,130	
			0.02	0.7	29,000	1,650	28,000	1,440	26,000	1,190	25,000	1,000	
	0.1	2	0.02	0.65	32,000	1,920	30,000	1,620	29,000	1,390	27,000	1,130	
			0.02	0.65	29,000	1,650	28,000	1,440	26,000	1,190	25,000	1,000	
	0.2	5	0.02	0.55	29,000	1,650	28,000	1,440	26,000	1,190	25,000	1,000	
			0.015	0.55	26,000	1,400	25,000	1,220	23,000	990	22,000	830	
	2	0.05	3	0.02	0.95	28,000	2,240	27,000	1,940	25,000	1,600	24,000	1,340
				0.02	0.95	28,000	2,240	27,000	1,940	25,000	1,600	24,000	1,340
			10	0.02	0.95	25,000	1,900	24,000	1,640	23,000	1,400	21,000	1,120
		0.1	3	0.02	0.9	28,000	2,240	27,000	1,940	25,000	1,600	24,000	1,340
0.02				0.9	28,000	2,240	27,000	1,940	25,000	1,600	24,000	1,340	
10			0.02	0.9	25,000	1,900	24,000	1,640	23,000	1,400	21,000	1,120	
0.2		5	0.02	0.8	28,000	2,240	27,000	1,940	25,000	1,600	24,000	1,340	
			0.02	0.8	25,000	1,900	24,000	1,640	23,000	1,400	21,000	1,120	
		20	0.01	0.8	20,000	1,360	19,000	1,160	18,000	980	17,000	810	
3		0.05	6	0.02	1.45	24,000	2,450	23,000	2,110	22,000	1,800	20,000	1,430
				0.02	1.4	24,000	2,450	23,000	2,110	22,000	1,800	20,000	1,430
		0.5	6	0.02	1	24,000	2,450	23,000	2,110	22,000	1,800	20,000	1,430

※基本切込みは被削材グループ1での目安を示しています。その他のグループの場合は、上表の切込み比率を目安に調整してください。
本切削条件における切込み量は、底面加工時を想定して算出しております。勾配面などの仕上げ加工においては、理論面粗さ(カスプハイト量)から設定してください。

The indicated standard cutting depth is a reference value for Group 1 work materials. For materials in other groups, the cutting depth should be adjusted using the reference ratio shown in the above table.
The depth of cut stated in these cutting conditions are calculated assuming bottom surface machining. For finishing machining such as slope machining, it should be set according to the theoretical surface roughness (cusp height).

- 【注意】** ①被削材、加工形状に合わせて、適切なクーラントを使用してください。
②この標準切削条件表は切削条件の目安を示すものです。実際の加工では加工形状、目的、使用機械等により条件を調整してください。
③機械の回転数が足りない場合は、回転数と送り速度を同じ比率で下げてください。

- 【Note】** 1) Use the appropriate coolant for the work material and machining shape.
2) This standard cutting condition table is intended as reference cutting conditions. The conditions should be adjusted as necessary according to the actual conditions of machined shape, purpose, machine used, etc.
3) If the machine rotation speed is insufficient, reduce the rotation speed and feed rate by the same ratio.

Epoch Deep Radius エポックディープラジラス

ストレートネック

Straight Neck

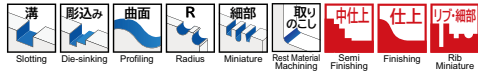

THコーティング採用で高硬度材に適しています。高い耐折損性。
TH Coating makes it ideal for high-hardness materials. High breakage resistance.

外径公差
Dia. tolerance
0~-0.015

RE公差
RE tolerance
±0.005

h5

(mm)

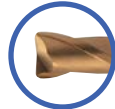

2枚刃
2Flutes

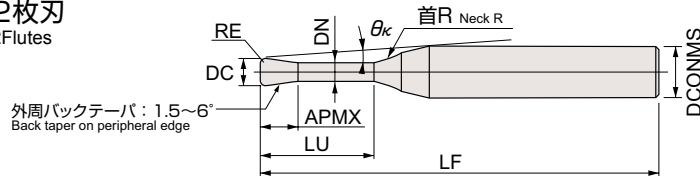

EPDR2-TH

超硬 TH 超硬 130° 切削条件表 A286
Carbide TH Helix angle Cutting Conditions

商品コード Item code	在庫 Stock	寸法 Size(mm)								干渉角度 Interference angle (°) θ_k	勾配角に対する実有効首下長 Actual effective length in incline angles					希望小売価格(円) Suggested retail price (¥)	
		外径 Tool dia. DC	コーナ半径 Corner radius RE	首下長 Under neck length LU	刃長 Flute length APMX	首径 Neck dia. DN	全長 Overall length LF	シャンク径 Shank dia. DCONMS	首R Neck R		0.5°	1°	1.5°	2°	3°		
		EPDR2002-0.5-005-TH	△	0.2	0.05	0.5	0.15	0.17	50		4	4	11.36	0.92	1		1.07
EPDR2002-1-005-TH	△	1	0.15			0.17	50	4	7	10.81	1.63	1.79	1.95	2.09	2.37	14,150	
EPDR2002-1.5-005-TH	△	1.5	0.15			0.17	50	4	7	10.3	2.18	2.38	2.56	2.72	3.04	15,320	
EPDR2002-2-005-TH	△	2	0.15			0.17	50	4	10	9.84	2.89	3.17	3.43	3.67	4.12	16,720	
EPDR2003-1-005-TH	△	0.3	0.05	1	0.25	0.27	50	4	4	10.78	1.46	1.57	1.67	1.77	1.95	14,150	
EPDR2003-1.5-005-TH	△			1.5	0.25	0.27	50	4	7	10.26	2.18	2.38	2.56	2.72	3.04	15,320	
EPDR2003-2-005-TH	△			2	0.25	0.27	50	4	7	9.79	2.73	2.95	3.15	3.34	3.68	15,320	
EPDR2003-2.5-005-TH	△			2.5	0.25	0.27	50	4	7	9.36	3.27	3.52	3.74	3.94	4.31	15,860	
EPDR2003-3-005-TH	△			3	0.25	0.27	50	4	10	8.97	3.99	4.33	4.63	4.91	5.41	15,860	
EPDR2004-1-005-TH	△	0.4	0.05	1	0.3	0.37	50	4	4	10.75	1.46	1.57	1.67	1.77	1.95	9,630	
EPDR2004-1.5-005-TH	△			1.5	0.3	0.37	50	4	4	10.22	2	2.13	2.26	2.37	2.57	10,200	
EPDR2004-2-005-TH	△			2	0.3	0.37	50	4	7	9.74	2.73	2.95	3.15	3.34	3.68	10,200	
EPDR2004-2.5-005-TH	△			2.5	0.3	0.37	50	4	7	9.31	3.27	3.52	3.74	3.94	4.31	10,580	
EPDR2004-3-005-TH	△			3	0.3	0.37	50	4	7	8.91	3.81	4.09	4.32	4.54	4.92	11,370	
EPDR2004-3.5-005-TH	△			3.5	0.3	0.37	50	4	7	8.54	4.35	4.65	4.9	5.13	5.53	11,370	
EPDR2004-4-005-TH	△			4	0.3	0.37	50	4	10	8.21	5.08	5.47	5.81	6.11	6.66	11,370	
EPDR2004-2-01-TH	△	0.1	0.05	2	0.3	0.37	50	4	7	9.79	2.72	2.94	3.14	3.33	3.67	10,200	
EPDR2004-3-01-TH	△			3	0.3	0.37	50	4	7	8.95	3.81	4.08	4.32	4.53	4.91	11,370	
EPDR2004-4-01-TH	△			4	0.3	0.37	50	4	10	8.24	5.07	5.47	5.8	6.1	6.65	11,370	
EPDR2005-1-005-TH	△			0.5	0.05	1	0.35	0.47	50	4	4	10.71	1.46	1.57	1.67	1.77	1.95
EPDR2005-2-005-TH	△	2	0.35			0.47	50	4	4	9.69	2.54	2.69	2.83	2.95	3.18	9,630	
EPDR2005-3-005-TH	△	3	0.35			0.47	50	4	7	8.84	3.81	4.09	4.32	4.54	4.92	9,630	
EPDR2005-4-005-TH	△	4	0.35			0.47	50	4	7	8.13	4.89	5.2	5.47	5.71	6.13	9,630	
EPDR2005-5-005-TH	△	5	0.35			0.47	50	4	10	7.53	6.16	6.6	6.97	7.3	7.88	9,630	
EPDR2005-6-005-TH	△	6	0.35			0.47	50	4	10	7	7.24	7.71	8.11	8.46	9.08	10,200	
EPDR2005-1-01-TH	△	0.1	0.05		1	0.35	0.47	50	4	4	10.77	1.46	1.56	1.66	1.76	1.93	9,630
EPDR2005-2-01-TH	△				2	0.35	0.47	50	4	4	9.74	2.53	2.69	2.82	2.95	3.17	9,630
EPDR2005-3-01-TH	△				3	0.35	0.47	50	4	7	8.88	3.81	4.08	4.32	4.53	4.91	9,630
EPDR2005-4-01-TH	△				4	0.35	0.47	50	4	7	8.17	4.89	5.2	5.46	5.7	6.12	9,630
EPDR2005-5-01-TH	△				5	0.35	0.47	50	4	10	7.55	6.16	6.59	6.96	7.29	7.87	9,630
EPDR2005-6-01-TH	△				6	0.35	0.47	50	4	10	7.03	7.24	7.71	8.1	8.45	9.07	10,200

△印：在庫が無くなり次第受注生産品となるものです。△：When the Stock is out, will become to produce on request.

エポックディープラジラス

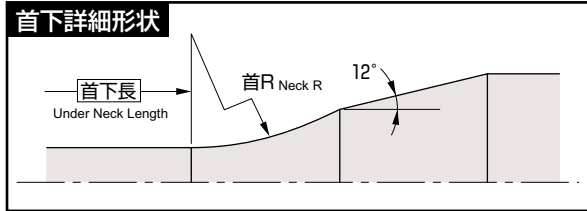

【注意】

加工物に勾配がついている場合、干渉領域は、首下長さよりも長くなります。それぞれの勾配角に対する実有効首下長をご参照ください。
また、工具が加工物に干渉する角度を干渉角度 θ_K で表示していますので合わせてご参照ください。

【Note】

If the workpiece has draft angle, the interference length will be longer than the under-neck length. Please refer to the effective under-neck length for the various draft angles.
In addition, the angle at which the tool will interfere with the workpiece is shown as the "interference angle θ_K ", and should also be referred to.

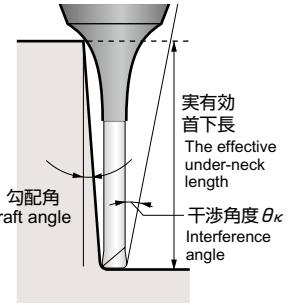

EPDR2-○○○-○○○-○○○-TH

商品コード Item code	在庫 Stock	寸法 Size(mm)								干渉角度 Interference angle (°) θ_K	勾配角に対する実有効首下長 Actual effective length in incline angles					希望小売 価格(円) Suggested retail price (¥)	
		外径 Tool dia.	コーナ半径 Corner radius	首下長 Under neck length	刃長 Flute length	首径 Neck dia.	全長 Overall length	シャンク径 Shank dia.	首R Neck R		0.5°	1°	1.5°	2°	3°		
		DC	RE	LU	APMX	DN	LF	DCONMS									
EPDR2006-2-01-TH	△	0.6	0.1	2	0.4	0.57	50	4	4	9.68	2.53	2.69	2.82	2.95	3.17	7,370	
EPDR2006-4-01-TH	△			4	0.4	0.57	50	4	7	8.09	4.89	5.2	5.46	5.7	6.12	7,930	
EPDR2006-6-01-TH	△			6	0.4	0.57	50	4	10	6.94	7.24	7.71	8.1	8.45	9.07	7,930	
EPDR2006-8-01-TH	△			8	0.4	0.57	50	4	10	6.08	9.38	9.92	10.36	10.75	11.43	11,370	
EPDR2006-10-01-TH	△			10	0.4	0.57	50	4	10	5.41	11.5	12.1	12.59	13.01	13.75	11,790	
EPDR2008-4-01-TH	△	0.8	0.1	4	0.5	0.77	50	4	7	7.93	4.88	5.2	5.46	5.7	6.12	7,930	
EPDR2008-6-01-TH	△			6	0.5	0.77	50	4	7	6.77	7.02	7.4	7.71	7.99	8.48	7,930	
EPDR2008-8-01-TH	△			8	0.5	0.77	50	4	10	5.9	9.38	9.92	10.36	10.75	11.43	7,930	
EPDR2008-12-01-TH	△			12	0.5	0.77	55	4	10	4.7	13.62	14.27	14.79	15.25	16.03	11,370	
EPDR2008-4-02-TH	△		0.2	4	0.5	0.77	50	4	7	8	4.88	5.19	5.45	5.68	6.1	7,930	
EPDR2008-6-02-TH	△			6	0.5	0.77	50	4	7	6.82	7.01	7.39	7.7	7.98	8.46	7,930	
EPDR2010-4-01-TH	△	1	0.1	4	0.8	0.94	50	4	4	7.7	4.74	4.95	5.12	5.28	5.55	7,030	
EPDR2010-6-01-TH	△			6	0.8	0.94	50	4	7	6.54	7.12	7.48	7.78	8.05	8.52	7,610	
EPDR2010-8-01-TH	△			8	0.8	0.94	50	4	7	5.68	9.23	9.64	9.99	10.29	10.81	7,610	
EPDR2010-10-01-TH	△			10	0.8	0.94	50	4	10	5.02	11.6	12.18	12.65	13.07	13.79	7,610	
EPDR2010-12-01-TH	△			12	0.8	0.94	55	4	10	4.5	13.71	14.34	14.85	15.3	16.08	7,610	
EPDR2010-16-01-TH	△			16	0.8	0.94	60	4	10	3.72	17.91	18.63	19.21	19.71	21.39	9,630	
EPDR2010-20-01-TH	△			20	0.8	0.94	60	4	10	3.17	22.09	22.89	23.52	24.08	26.7	11,900	
EPDR2010-4-02-TH	△			0.2	4	0.8	0.94	50	4	4	7.77	4.74	4.94	5.11	5.27	5.54	7,030
EPDR2010-6-02-TH	△		6		0.8	0.94	50	4	7	6.59	7.12	7.47	7.77	8.03	8.51	7,610	
EPDR2010-8-02-TH	△		8		0.8	0.94	50	4	7	5.72	9.22	9.63	9.98	10.28	10.8	7,610	
EPDR2010-10-02-TH	△		10		0.8	0.94	50	4	10	5.05	11.6	12.17	12.64	13.05	13.77	7,610	
EPDR2010-12-02-TH	△		12		0.8	0.94	55	4	10	4.52	13.71	14.33	14.84	15.29	16.05	7,610	
EPDR2010-16-02-TH	△		16		0.8	0.94	60	4	10	3.74	17.91	18.62	19.2	19.7	21.35	9,630	
EPDR2010-20-02-TH	△		20		0.8	0.94	60	4	10	3.19	22.09	22.88	23.52	24.06	26.66	11,900	
EPDR2010-6-03-TH	△		0.3		6	0.8	0.94	50	4	7	6.64	7.11	7.46	7.76	8.02	8.49	7,610
EPDR2010-10-03-TH	△			10	0.8	0.94	50	4	10	5.08	11.59	12.16	12.63	13.04	13.76	7,610	
EPDR2010-16-03-TH	△			16	0.8	0.94	60	4	10	3.75	17.9	18.62	19.19	19.69	21.32	9,630	
EPDR2010-20-03-TH	△			20	0.8	0.94	60	4	10	3.2	22.08	22.88	23.51	24.05	26.63	11,900	
EPDR2015-4-01-TH	△		1.5	0.1	4	1.35	1.42	50	4	4	7.15	4.8	4.99	5.16	5.31	5.58	7,610
EPDR2015-8-01-TH	△				8	1.35	1.42	50	4	7	5.12	9.29	9.69	10.02	10.32	10.84	7,610
EPDR2015-12-01-TH	△	12			1.35	1.42	55	4	7	3.98	13.47	13.96	14.37	14.72	16.14	9,060	
EPDR2015-15-01-TH	△	15			1.35	1.42	55	4	10	3.42	16.92	17.6	18.16	18.64	20.12	9,060	
EPDR2015-20-01-TH	△	20		1.35	1.42	60	4	10	2.76	22.14	22.92	23.55	24.13	干渉なし	9,060		
EPDR2015-4-02-TH	△	0.2		4	1.35	1.42	50	4	4	7.22	4.79	4.98	5.15	5.3	5.57	7,610	
EPDR2015-8-02-TH	△			8	1.35	1.42	50	4	7	5.16	9.28	9.68	10.01	10.31	10.82	7,610	
EPDR2015-12-02-TH	△			12	1.35	1.42	55	4	7	4.01	13.46	13.96	14.36	14.71	16.11	9,060	
EPDR2015-15-02-TH	△			15	1.35	1.42	55	4	10	3.43	16.91	17.59	18.15	18.63	20.09	9,060	
EPDR2015-20-02-TH	△			20	1.35	1.42	60	4	10	2.77	22.13	22.92	23.55	24.11	干渉なし	9,060	
EPDR2015-8-03-TH	△			0.3	8	1.35	1.42	50	4	7	5.19	9.28	9.67	10	10.3	10.81	7,610
EPDR2015-15-03-TH	△				15	1.35	1.42	55	4	10	3.45	16.91	17.59	18.14	18.62	20.06	9,060
EPDR2015-20-03-TH	△				20	1.35	1.42	60	4	10	2.78	22.13	22.91	23.54	24.09	干渉なし	9,060

△印：在庫が無くなり次第受注生産品となるものです。 △：When the Stock is out, will become to produce on request. 干渉なし：No interference

EPDR2-TH

商品コード Item code	在庫 Stock	寸法 Size(mm)								干渉角度 Interference angle (°) θ _K	勾配角に対する実有効首下長 Actual effective length in incline angles					希望小売 価格 (円) Suggested retail price (¥)
		外径 Tool dia.	コーナ半径 Corner radius	首下長 Under neck length	刃長 Flute length	首径 Neck dia.	全長 Overall length	シャンク径 Shank dia.	首R Neck R		0.5°	1°	1.5°	2°	3°	
		DC	RE	LU	APMX	DN	LF	DCONMS								
EPDR2020-6-02-TH	△	2	0.2	6	1.7	1.92	50	4	4	5.35	6.88	7.12	7.32	7.5	8.14	7,030
EPDR2020-8-02-TH	△			8	1.7	1.92	50	4	4	4.51	8.95	9.24	9.47	9.75	10.8	7,610
EPDR2020-12-02-TH	△			12	1.7	1.92	55	4	7	3.43	13.46	13.96	14.36	14.71	16.11	7,610
EPDR2020-16-02-TH	△			16	1.7	1.92	55	4	7	2.77	17.62	18.19	18.65	19.33	干涉なし	7,610
EPDR2020-20-02-TH	△			20	1.7	1.92	60	4	10	2.32	22.13	22.92	23.55	24.11	干涉なし	7,610
EPDR2020-25-02-TH	△			25	1.7	1.92	65	4	10	1.93	27.33	28.2	28.89	干涉なし	干涉なし	10,200
EPDR2020-30-02-TH	△		30	1.7	1.92	70	4	10	1.66	32.51	33.46	34.4	干涉なし	干涉なし	12,540	
EPDR2020-8-03-TH	△		0.3	8	1.7	1.92	50	4	4	4.55	8.95	9.23	9.47	9.73	10.77	7,610
EPDR2020-16-03-TH	△			16	1.7	1.92	55	4	7	2.79	17.62	18.19	18.64	19.31	干涉なし	7,610
EPDR2020-20-03-TH	△			20	1.7	1.92	60	4	10	2.33	22.13	22.91	23.54	24.09	干涉なし	7,610
EPDR2020-6-05-TH	△		0.5	6	1.7	1.92	50	4	4	5.5	6.86	7.1	7.3	7.48	8.05	7,030
EPDR2020-8-05-TH	△			8	1.7	1.92	50	4	4	4.62	8.94	9.22	9.45	9.69	10.7	7,610
EPDR2020-12-05-TH	△			12	1.7	1.92	55	4	7	3.5	13.45	13.94	14.33	14.68	16.01	7,610
EPDR2020-16-05-TH	△			16	1.7	1.92	55	4	7	2.81	17.61	18.18	18.63	19.27	干涉なし	7,610
EPDR2020-20-05-TH	△			20	1.7	1.92	60	4	10	2.35	22.12	22.9	23.52	24.06	干涉なし	7,610
EPDR2020-25-05-TH	△			25	1.7	1.92	65	4	10	1.95	27.32	28.19	28.87	干涉なし	干涉なし	10,200
EPDR2020-30-05-TH	△		30	1.7	1.92	70	4	10	1.67	32.5	33.45	34.36	干涉なし	干涉なし	12,540	
EPDR2020-8-08-TH	△		0.8	8	1.7	1.92	50	4	4	4.73	8.93	9.2	9.43	9.64	10.61	7,610
EPDR2020-16-08-TH	△			16	1.7	1.92	55	4	7	2.85	17.6	18.16	18.61	19.21	干涉なし	7,610
EPDR2020-20-08-TH	△			20	1.7	1.92	60	4	10	2.38	22.11	22.88	23.5	24.03	干涉なし	7,610
EPDR2030-8-02-TH	△	3	0.2	8	2.5	2.86	55	6	4	5.65	9.07	9.33	9.55	9.92	10.99	7,610
EPDR2030-12-02-TH	△			12	2.5	2.86	60	6	4	4.48	13.19	13.52	14.03	14.71	16.29	8,730
EPDR2030-16-02-TH	△			16	2.5	2.86	60	6	7	3.71	17.75	18.29	18.73	19.5	21.6	9,860
EPDR2030-20-02-TH	△			20	2.5	2.86	65	6	7	3.16	21.88	22.49	23.15	24.28	26.91	9,860
EPDR2030-30-02-TH	△			30	2.5	2.86	75	6	10	2.31	32.63	33.55	34.56	36.25	干涉なし	11,370
EPDR2030-35-02-TH	△			35	2.5	2.86	80	6	10	2.04	37.79	38.78	40.26	42.23	干涉なし	12,540
EPDR2030-8-03-TH	△		0.3	8	2.5	2.86	55	6	4	5.68	9.07	9.33	9.54	9.9	10.95	7,610
EPDR2030-16-03-TH	△			16	2.5	2.86	60	6	7	3.72	17.74	18.28	18.72	19.48	21.57	9,860
EPDR2030-20-03-TH	△			20	2.5	2.86	65	6	7	3.17	21.88	22.48	23.14	24.26	26.88	9,860
EPDR2030-30-03-TH	△		30	2.5	2.86	75	6	10	2.32	32.62	33.54	34.54	36.23	干涉なし	11,370	
EPDR2030-8-05-TH	△		0.5	8	2.5	2.86	55	6	4	5.76	9.06	9.31	9.53	9.86	10.89	7,610
EPDR2030-12-05-TH	△			12	2.5	2.86	60	6	4	4.55	13.18	13.51	13.99	14.65	16.2	8,730
EPDR2030-16-05-TH	△			16	2.5	2.86	60	6	7	3.75	17.74	18.27	18.71	19.44	21.51	9,860
EPDR2030-20-05-TH	△			20	2.5	2.86	65	6	7	3.2	21.87	22.47	23.11	24.22	26.82	9,860
EPDR2030-30-05-TH	△			30	2.5	2.86	75	6	10	2.33	32.62	33.53	34.52	36.19	干涉なし	11,370
EPDR2030-35-05-TH	△			35	2.5	2.86	80	6	10	2.06	37.78	38.77	40.22	42.17	干涉なし	12,540

○ 対応被削材 Applicable work material

炭素鋼 合金鋼 Carbon steel Alloy steel	プリハー ド鋼 Pre-hardened steel	高硬度 Hardened steel			ステン レス鋼 Stainless steel	チタン合金 耐熱合金 Titanium alloy Heat-resistant alloy	銅合金 Copper alloy	アルミ 合金 Aluminum alloy
○	○	> 45HRC ≤ 55HRC	> 55HRC ≤ 65HRC	> 65HRC	○	○	○	

○ 再研磨対応外径範囲 Re-grinding compatibility range

商品コード Item code	外周 Outer dia. (mm)	エンド End (mm)
EPDR-TH	× (N/A)	× (N/A)

標準切削条件表 Recommended cutting conditions

EPDR-TH

標準切削条件 Standard cutting condition

被削材 Work material				1		2		3		4		5		6	
				銅 Coppers		炭素鋼・合金鋼 Carbon steels, Alloy steels (180~250HB)		ステンレス鋼・工具鋼 Stainless steels, Tool steels (25~35HRC)		プリハードン鋼 Pre-hardened steels (35~45HRC)		焼入れ鋼 Hardened steels (45~55HRC)		焼入れ鋼 Hardened steels (55~65HRC)	
切り込み比率 Ratio to standard depth of cut				120%		100%		90%		80%		65%		60%	
外径DC Tool dia. (mm)	コーナ半径R Corner radius (mm)	首下長LU Under neck length (mm)	基本切り込み Standard depth of cut (mm)	回転数 n min ⁻¹	送り速度 Vf mm/min	回転数 n min ⁻¹	送り速度 Vf mm/min	回転数 n min ⁻¹	送り速度 Vf mm/min	回転数 n min ⁻¹	送り速度 Vf mm/min	回転数 n min ⁻¹	送り速度 Vf mm/min	回転数 n min ⁻¹	送り速度 Vf mm/min
0.2	0.05	0.5	0.02	50,000	307	50,000	258	50,000	230	50,000	205	50,000	180	50,000	160
		1	0.014	50,000	307	50,000	258	50,000	230	50,000	205	50,000	180	50,000	160
		1.5	0.008	50,000	276	50,000	240	48,600	223	45,900	202	45,900	170	45,900	153
		2	0.008	50,000	246	42,000	202	37,800	181	36,700	176	36,700	162	36,700	147
0.3	0.05	1	0.021	50,000	696	50,000	585	50,000	516	50,000	456	50,000	336	50,000	320
		1.5	0.016	50,000	696	50,000	585	45,000	516	45,000	456	45,000	336	45,000	320
		2	0.012	45,000	620	45,000	530	45,000	460	45,000	420	45,000	300	45,000	290
		2.5	0.01	40,000	551	40,000	471	40,000	409	40,000	373	40,000	267	40,000	258
0.4	0.05	1	0.025	50,000	691	50,000	580	50,000	518	50,000	461	40,000	320	36,000	270
		1.5	0.02	50,000	691	50,000	580	50,000	518	50,000	461	40,000	320	36,000	270
		2	0.016	45,000	620	45,000	520	45,000	470	45,000	410	36,000	290	34,000	240
		2.5	0.015	40,500	560	40,500	480	40,500	400	40,500	370	33,400	270	30,600	220
		3	0.014	40,000	480	40,000	410	40,000	370	40,000	330	32,800	240	25,600	200
		3.5	0.012	36,000	420	36,000	380	36,000	320	36,000	300	29,400	200	22,920	180
	0.1	2	0.028	45,000	620	45,000	520	45,000	470	45,000	410	36,000	290	34,000	240
		3	0.016	40,000	480	40,000	410	40,000	370	40,000	330	32,800	240	25,600	200
		4	0.01	30,000	370	30,000	320	30,000	280	30,000	250	21,600	160	19,200	150
		4	0.008	30,000	370	30,000	320	30,000	280	30,000	250	21,600	160	19,200	150
0.5	0.05	1	0.03	50,000	1,070	50,000	898	50,000	756	40,000	464	30,000	378	28,000	315
		2	0.023	50,000	1,070	50,000	898	50,000	756	40,000	464	30,000	378	28,000	315
		3	0.017	45,000	960	45,000	810	45,000	684	36,000	414	27,000	315	24,500	261
		4	0.017	40,000	850	40,000	720	40,000	603	32,000	378	24,000	279	20,000	234
		5	0.011	30,000	640	28,800	540	24,000	380	19,400	280	18,000	250	15,000	200
		6	0.008	30,000	570	28,800	480	24,000	380	19,400	260	18,000	250	15,000	200
	0.1	1	0.035	50,000	1,070	50,000	898	50,000	756	40,000	464	30,000	378	28,000	315
		2	0.03	50,000	1,070	50,000	898	50,000	756	40,000	464	30,000	378	28,000	315
		3	0.02	45,000	960	45,000	810	45,000	684	36,000	414	27,000	315	24,500	261
		4	0.02	40,000	850	40,000	720	40,000	603	32,000	378	24,000	279	20,000	234
		5	0.013	30,000	640	28,800	540	24,000	380	19,400	280	18,000	250	15,000	200
		6	0.013	30,000	570	28,800	480	24,000	380	19,400	260	18,000	250	15,000	200
0.6	0.1	2	0.035	50,000	1,380	50,000	1,159	46,800	920	37,830	600	28,200	390	23,000	320
		4	0.024	40,000	980	40,000	830	34,500	620	27,800	440	23,600	280	21,000	230
		6	0.015	30,000	580	24,000	490	20,000	360	18,000	300	17,800	240	15,000	210
		8	0.013	30,000	551	24,000	466	20,000	342	18,000	285	17,800	228	15,000	200
		10	0.009	30,000	534	24,000	451	20,000	331	18,000	276	17,800	221	15,000	193
0.8	0.1	4	0.032	50,000	1,312	48,000	1,102	36,000	750	28,000	518	20,000	320	20,000	288
		6	0.019	40,000	950	38,700	800	26,000	530	25,000	461	18,000	288	18,000	256
		8	0.015	30,000	713	29,025	600	20,800	424	20,000	369	16,200	259	16,200	230
		12	0.012	30,000	677	29,025	570	20,800	403	20,000	350	16,200	246	16,200	219
	0.2	4	0.056	50,000	1,312	48,000	1,102	36,000	750	28,000	518	20,000	320	20,000	288
		6	0.032	40,000	950	38,700	800	26,000	530	25,000	461	18,000	288	18,000	256

被削材 Work material				1		2		3		4		5		6		
				銅 Coppers		炭素鋼・合金鋼 Carbon steels, Alloy steels (180~250HB)		ステンレス鋼・工具鋼 Stainless steels, Tool steels (25~35HRC)		プリハードン鋼 Pre-hardened steels (35~45HRC)		焼入れ鋼 Hardened steels (45~55HRC)		焼入れ鋼 Hardened steels (55~65HRC)		
切り込み比率 Ratio to standard depth of cut				120%		100%		90%		80%		65%		60%		
外径DC Tool dia. (mm)	コーナ半径R Corner radius (mm)	首下長LU Under neck length (mm)	基本切り込み Standard depth of cut (mm)	回転数 n min ⁻¹	送り速度 v_f mm/min	回転数 n min ⁻¹	送り速度 v_f mm/min	回転数 n min ⁻¹	送り速度 v_f mm/min	回転数 n min ⁻¹	送り速度 v_f mm/min	回転数 n min ⁻¹	送り速度 v_f mm/min	回転数 n min ⁻¹	送り速度 v_f mm/min	
1	0.1	4	0.038	38,880	1,630	32,400	1,359	29,160	1,223	27,540	1,039	24,300	815	22,680	666	
		6	0.024	31,493	1,189	26,244	990	23,620	891	22,307	842	19,683	660	18,371	539	
		8	0.024	27,994	1,056	23,328	880	20,995	792	19,829	748	17,496	587	16,330	479	
		10	0.015	24,494	924	20,412	770	18,371	693	17,350	655	15,309	514	14,288	419	
		12	0.015	21,773	730	18,144	609	16,330	548	15,422	453	13,608	399	12,701	320	
		16	0.009	21,773	639	18,144	533	16,330	479	15,422	420	13,608	342	12,701	266	
		20	0.006	16,330	479	13,608	399	12,247	359	11,567	315	10,206	257	9,526	200	
	0.2	4	0.07	38,880	1,630	32,400	1,359	29,160	1,223	27,540	1,039	24,300	815	22,680	666	
		6	0.04	31,493	1,189	26,244	990	23,620	891	22,307	842	19,683	660	18,371	539	
		8	0.04	27,994	1,056	23,328	880	20,995	792	19,829	748	17,496	587	16,330	479	
		10	0.025	24,494	924	20,412	770	18,371	693	17,350	655	15,309	514	14,288	419	
		12	0.025	21,773	730	18,144	609	16,330	548	15,422	453	13,608	399	12,701	320	
		16	0.015	21,773	639	18,144	533	16,330	479	15,422	420	13,608	342	12,701	266	
		20	0.01	16,330	479	13,608	399	12,247	359	11,567	315	10,206	257	9,526	200	
	0.3	6	0.04	31,493	1,189	26,244	990	23,620	891	22,307	842	19,683	660	18,371	539	
		10	0.025	24,494	924	20,412	770	18,371	693	17,350	655	15,309	514	14,288	419	
		16	0.015	21,773	639	18,144	533	16,330	479	15,422	420	13,608	342	12,701	266	
		20	0.01	16,330	479	13,608	399	12,247	359	11,567	315	10,206	257	9,526	200	
	1.5	0.1	4	0.042	29,938	1,356	24,930	1,130	22,453	1,017	20,956	868	18,711	678	17,364	556
			8	0.036	27,216	1,233	22,680	1,027	20,412	924	19,278	873	17,010	685	15,876	559
			12	0.036	21,773	986	18,144	822	16,330	740	15,422	698	13,608	548	12,701	447
15			0.023	16,934	682	14,112	568	12,701	511	11,995	423	10,584	373	9,878	298	
0.2		4	0.07	29,938	1,356	24,930	1,130	22,453	1,017	20,956	868	18,711	678	17,364	556	
		8	0.06	27,216	1,233	22,680	1,027	20,412	924	19,278	873	17,010	685	15,876	559	
		12	0.06	21,773	986	18,144	822	16,330	740	15,422	698	13,608	548	12,701	447	
		15	0.038	16,934	682	14,112	568	12,701	511	11,995	423	10,584	373	9,878	298	
		20	0.03	16,934	682	14,112	568	12,701	511	11,995	423	10,584	373	9,878	298	
0.3		8	0.06	27,216	1,233	22,680	1,027	20,412	924	19,278	873	17,010	685	15,876	559	
		15	0.038	16,934	682	14,112	568	12,701	511	11,995	423	10,584	373	9,878	298	
		20	0.03	16,934	682	14,112	568	12,701	511	11,995	423	10,584	373	9,878	298	

【注意】 ご使用にあたっては、A288ページの表下の項目と注意を参照してください。 **【Note】** Upon usage, please refer to comments and notes below table on page A288.

Epoch Deep Radius エポックディープラジラス

超幅厚エンドミル
ラジラスエンドミル

EPDR-TH

標準切削条件 Standard cutting condition

被削材 Work material				1		2		3		4		5		6		
				銅 Coppers		炭素鋼・合金鋼 Carbon steels, Alloy steels (180~250HB)		ステンレス鋼・工具鋼 Stainless steels, Tool steels (25~35HRC)		プリハードン鋼 Pre-hardened steels (35~45HRC)		焼入れ鋼 Hardened steels (45~55HRC)		焼入れ鋼 Hardened steels (55~65HRC)		
切り込み比率 Ratio to standard depth of cut				120%		100%		90%		80%		65%		60%		
外径DC Tool dia. (mm)	コーナ半径 Corner radius (mm)	首下長LU Under neck length (mm)	基本切り込み Standard depth of cut (mm)	回転数 n min ⁻¹		送り速度 V_f mm/min		回転数 n min ⁻¹		送り速度 V_f mm/min		回転数 n min ⁻¹		送り速度 V_f mm/min		
				2	0.2	6	0.08	24,948	1,962	20,790	1,635	18,711	1,471	17,672	1,389	15,593
8	0.07	22,680	1,783			18,900	1,486	17,010	1,337	16,065	1,263	14,175	892	13,230	728	
12	0.04	18,371	1,300			15,309	1,083	13,778	975	13,013	921	11,482	722	10,716	590	
16	0.04	16,330	1,156			13,608	963	12,247	867	11,567	818	10,206	642	9,526	524	
20	0.035	14,288	1,011			11,907	843	10,716	758	10,121	716	8,930	562	8,335	459	
25	0.025	14,288	1,011			11,907	843	10,716	758	10,121	716	8,930	562	8,335	459	
0.3	8	0.09	22,680		1,981	18,900	1,651	17,010	1,486	16,065	1,403	14,175	991	13,230	809	
	16	0.06	16,330		1,284	13,608	1,070	12,247	963	11,567	909	10,206	713	9,526	583	
	20	0.037	14,288		1,123	11,907	936	10,716	843	10,121	796	8,930	624	8,335	510	
0.5	6	0.17	24,948		1,962	20,790	1,635	18,711	1,471	17,672	1,389	15,593	981	14,553	801	
	8	0.14	22,680		1,981	18,900	1,651	17,010	1,486	16,065	1,403	14,175	991	13,230	809	
	12	0.08	18,371		1,444	15,309	1,204	13,778	1,083	13,013	1,023	11,482	802	10,716	655	
	16	0.08	16,330		1,284	13,608	1,070	12,247	963	11,567	909	10,206	713	9,526	583	
	20	0.05	14,288		1,123	11,907	936	10,716	843	10,121	796	8,930	624	8,335	510	
	25	0.05	14,288		1,123	11,907	936	10,716	843	10,121	796	8,930	624	8,335	510	
0.8	8	0.2	22,680		1,981	18,900	1,651	17,010	1,486	16,065	1,403	14,175	991	13,230	809	
	16	0.1	16,330		1,284	13,608	1,070	12,247	963	11,567	909	10,206	713	9,526	583	
	20	0.06	14,288		1,123	11,907	936	10,716	843	10,121	796	8,930	624	8,335	510	
3	0.2	8	0.09		17,280	1,698	14,400	1,415	12,960	1,274	12,240	1,203	10,800	849	10,080	693
		12	0.07		17,280	1,698	14,400	1,415	12,960	1,274	12,240	1,203	10,800	849	10,080	693
		16	0.05		17,280	1,698	14,400	1,415	12,960	1,274	12,240	1,203	10,800	849	10,080	693
		20	0.05		13,997	1,376	11,664	1,146	10,498	1,032	9,914	974	8,748	764	8,165	624
		30	0.04		10,886	1,376	9,072	1,146	8,165	1,032	7,711	974	6,804	764	6,350	624
	0.3	35	0.035		10,886	1,376	9,072	1,146	8,165	1,032	7,711	974	6,804	764	6,350	624
		8	0.13	17,280	1,887	14,400	1,572	12,960	1,415	12,240	1,337	10,800	943	10,080	771	
		16	0.075	17,280	1,887	14,400	1,572	12,960	1,415	12,240	1,337	10,800	943	10,080	771	
		20	0.075	13,997	1,528	11,664	1,274	10,498	1,146	9,914	1,083	8,748	849	8,165	693	
	0.5	30	0.06	10,886	1,528	9,072	1,274	8,165	1,146	7,711	1,083	6,804	849	6,350	693	
		8	0.18	17,280	1,887	14,400	1,572	12,960	1,415	12,240	1,337	10,800	943	10,080	771	
		12	0.13	17,280	1,887	14,400	1,572	12,960	1,415	12,240	1,337	10,800	943	10,080	771	
		16	0.1	17,280	1,887	14,400	1,572	12,960	1,415	12,240	1,337	10,800	943	10,080	771	
		20	0.1	13,997	1,528	11,664	1,274	10,498	1,146	9,914	1,083	8,748	849	8,165	693	
	35	0.065	10,886	1,528	9,072	1,274	8,165	1,146	7,711	1,083	6,804	849	6,350	693		

※基本切込みは被削材グループ2での目安を示しています。その他のグループの場合は、上表の切込み比率を目安に調整して下さい。

※Standard cutting depth is shown as the criteria for Group 2 workpieces. For other groups, adjust the cutting depth according to the cutting depth factors in the above table.

- 【注意】**
- ①被削材、加工形状に合わせて、適切なクーラントを使用してください。
 - ②この標準切削条件表は切削条件の目安を示すものです。実際の加工では加工形状、目的、使用機械等により条件を調整してください。
 - ③機械の回転数が足りない場合は、回転数と送り速度を同じ比率で下げてください。

- 【Note】**
1. Use the appropriate coolant for the work material and machining shape.
 2. These Recommended Cutting Conditions indicate only the rule of a thumb for the cutting conditions. In actual machining, the condition should be adjusted according to the machining shape, purpose and the machine type.
 3. If the rpm of the machine is low, lower the feed rate also to put the rpm and feed rate in the same ratio.

高効率切削条件

High efficiency cutting condition

被削材 Work material				1		2		3		4		5		6	
				銅 Coppers		炭素鋼・合金鋼 Carbon steels, Alloy steels (180~250HB)		ステンレス鋼・工具鋼 Stainless steels, Tool steels (25~35HRC)		プリハードン鋼 Pre-hardened steels (35~45HRC)		焼入れ鋼 Hardened steels (45~55HRC)		焼入れ鋼 Hardened steels (55~65HRC)	
切り込み比率 Ratio to standard depth of cut				120%		100%		90%		80%		65%		60%	
外径DC Tool dia. (mm)	コーナー半径 Corner radius (mm)	首下長LU Under neck length (mm)	基本切り込み Standard depth of cut (mm)	回転数 n min ⁻¹	送り速度 V_f mm/min	回転数 n min ⁻¹	送り速度 V_f mm/min	回転数 n min ⁻¹	送り速度 V_f mm/min	回転数 n min ⁻¹	送り速度 V_f mm/min	回転数 n min ⁻¹	送り速度 V_f mm/min	回転数 n min ⁻¹	送り速度 V_f mm/min
0.2	0.05	0.5	0.02	50,000	922	50,000	922	45,000	829	42,500	705	37,500	553	35,000	452
		1	0.014	50,000	922	50,000	922	45,000	829	42,500	705	37,500	553	35,000	452
		1.5	0.008	50,000	922	47,000	866	42,750	788	40,375	670	35,625	525	33,250	429
		2	0.008	50,000	922	42,000	774	40,500	746	38,250	635	33,750	498	31,500	406
0.3	0.05	1	0.021	50,000	1,208	48,000	1,161	43,200	1,045	40,800	733	36,000	547	33,600	441
		1.5	0.016	47,500	1,147	45,600	1,103	41,040	993	38,760	697	34,200	520	31,920	419
		2	0.012	45,000	998	38,880	860	34,992	774	33,048	594	29,160	443	27,216	357
		2.5	0.01	45,000	998	38,880	860	34,992	774	33,048	594	29,160	443	27,216	357
0.4	0.05	3	0.008	42,750	881	36,936	760	33,242	684	31,396	525	27,702	392	25,855	316
		1	0.025	46,080	1,239	38,300	1,032	34,560	929	32,256	793	28,800	620	26,726	508
		1.5	0.02	46,080	1,239	38,300	1,032	34,560	929	32,256	793	28,800	620	26,726	508
		2	0.016	46,080	1,115	38,300	929	34,560	836	32,256	714	28,800	557	26,726	457
	0.1	2.5	0.015	43,200	1,062	36,000	885	32,400	796	30,600	677	27,000	531	25,200	434
		3	0.014	35,250	780	29,325	649	26,437	585	24,675	499	22,031	390	20,445	320
		3.5	0.012	33,048	731	27,540	609	24,786	548	23,409	518	20,655	406	19,278	332
		4	0.008	29,029	642	24,150	535	21,772	481	20,320	411	18,143	321	16,837	263
0.5	0.05	2	0.028	48,000	1,180	40,000	983	36,000	885	34,000	752	30,000	590	28,000	482
		3	0.016	36,720	812	30,600	677	27,540	609	26,010	575	22,950	451	21,420	368
		4	0.01	30,240	669	25,200	557	22,680	502	21,420	474	18,900	372	17,640	303
		1	0.03	46,080	1,239	38,300	1,032	34,560	929	32,256	793	28,800	620	26,726	508
		2	0.023	46,080	1,239	38,300	1,032	34,560	929	32,256	793	28,800	620	26,726	508
		3	0.017	37,325	1,101	31,104	917	27,994	826	26,438	634	23,328	473	21,773	381
	0.1	4	0.017	33,178	978	27,648	815	24,883	734	23,501	563	20,736	420	19,354	339
		5	0.011	29,030	856	24,192	713	21,773	642	20,563	493	18,144	368	16,934	297
		6	0.008	25,805	666	21,504	555	19,354	499	18,278	320	16,128	282	15,053	222
		1	0.035	46,080	1,239	38,300	1,032	34,560	929	32,256	793	28,800	620	26,726	508
		2	0.03	46,080	1,239	38,300	1,032	34,560	929	32,256	793	28,800	620	26,726	508
		3	0.02	37,325	1,101	31,104	917	27,994	826	26,438	634	23,328	473	21,773	381
0.6	0.1	4	0.02	33,178	978	27,648	815	24,883	734	23,501	563	20,736	420	19,354	339
		5	0.013	29,030	856	24,192	713	21,773	642	20,563	493	18,144	368	16,934	297
		6	0.013	25,805	666	21,504	555	19,354	499	18,278	320	16,128	282	15,053	222
		2	0.035	46,080	1,548	38,300	1,290	34,560	1,161	32,256	991	28,800	774	26,726	635
		4	0.024	37,325	1,376	31,104	1,147	27,994	1,032	26,438	792	23,328	591	21,773	477
0.8	0.1	6	0.015	29,030	1,070	24,192	892	21,773	803	20,563	616	18,144	460	16,934	371
		8	0.013	27,579	1,017	22,982	847	20,684	763	19,535	585	17,237	437	16,088	352
		10	0.009	24,676	910	20,563	758	18,507	682	17,479	524	15,422	391	14,394	315
		4	0.032	48,000	1,769	40,000	1,475	36,000	1,327	34,000	1,128	30,000	885	28,000	723
0.2	0.1	6	0.019	36,720	1,218	30,600	1,015	27,540	914	26,010	863	22,950	677	21,420	553
		8	0.015	29,376	906	24,480	755	22,032	680	20,808	642	18,360	504	17,136	411
		12	0.012	26,438	759	22,032	632	19,829	569	18,727	537	16,524	421	15,422	344
		4	0.056	48,000	1,769	40,000	1,475	36,000	1,327	34,000	1,128	30,000	885	28,000	723
0.2	0.1	6	0.032	36,720	1,218	30,600	1,015	27,540	914	26,010	863	22,950	677	21,420	553

【注意】 ご使用にあたっては、A291ページの表下の項目と注意を参照してください。 **【Note】** Upon usage, please refer to comments and notes below table on page A291.

Epoch Deep Radius エポックディープラジラス

EPDR-TH

高効率切削条件 High efficiency cutting condition

被削材 Work material				1		2		3		4		5		6		
				銅 Coppers		炭素鋼・合金鋼 Carbon steels, Alloy steels (180~250HB)		ステンレス鋼・工具鋼 Stainless steels, Tool steels (25~35HRC)		プリハードン鋼 Pre-hardened steels (35~45HRC)		焼入れ鋼 Hardened steels (45~55HRC)		焼入れ鋼 Hardened steels (55~65HRC)		
切り込み比率 Ratio to standard depth of cut				120%		100%		90%		80%		65%		60%		
外径DC Tool dia. (mm)	コーナー半径RE Corner radius (mm)	首下長LU Under neck length (mm)	基本切り込み Standard depth of cut (mm)	回転数 n min ⁻¹	送り速度 V_f mm/min	回転数 n min ⁻¹	送り速度 V_f mm/min	回転数 n min ⁻¹	送り速度 V_f mm/min	回転数 n min ⁻¹	送り速度 V_f mm/min	回転数 n min ⁻¹	送り速度 V_f mm/min	回転数 n min ⁻¹	送り速度 V_f mm/min	
1	0.1	4	0.038	43,200	2,588	36,000	2,157	32,400	1,941	30,600	1,650	27,000	1,294	25,200	1,057	
		6	0.024	34,992	1,887	29,160	1,572	26,244	1,415	24,786	1,336	21,870	1,048	20,412	856	
		8	0.024	31,104	1,677	25,920	1,397	23,328	1,258	22,032	1,188	19,440	932	18,144	761	
		10	0.015	27,216	1,467	22,680	1,223	20,412	1,100	19,278	1,039	17,010	815	15,876	666	
		12	0.015	24,192	1,159	20,160	966	18,144	870	17,136	719	15,120	634	14,112	507	
		16	0.009	24,192	1,014	20,160	845	18,144	761	17,136	667	15,120	543	14,112	423	
		20	0.006	18,144	761	15,120	634	13,608	571	12,852	500	11,340	408	10,584	317	
	0.2	4	0.07	43,200	2,588	36,000	2,157	32,400	1,941	30,600	1,650	27,000	1,294	25,200	1,057	
		6	0.04	34,992	1,887	29,160	1,572	26,244	1,415	24,786	1,336	21,870	1,048	20,412	856	
		8	0.04	31,104	1,677	25,920	1,397	23,328	1,258	22,032	1,188	19,440	932	18,144	761	
		10	0.025	27,216	1,467	22,680	1,223	20,412	1,100	19,278	1,039	17,010	815	15,876	666	
		12	0.025	24,192	1,159	20,160	966	18,144	870	17,136	719	15,120	634	14,112	507	
		16	0.015	24,192	1,014	20,160	845	18,144	761	17,136	667	15,120	543	14,112	423	
		20	0.01	18,144	761	15,120	634	13,608	571	12,852	500	11,340	408	10,584	317	
	0.3	6	0.04	34,992	1,887	29,160	1,572	26,244	1,415	24,786	1,336	21,870	1,048	20,412	856	
		10	0.025	27,216	1,467	22,680	1,223	20,412	1,100	19,278	1,039	17,010	815	15,876	666	
		16	0.015	24,192	1,014	20,160	845	18,144	761	17,136	667	15,120	543	14,112	423	
		20	0.01	18,144	761	15,120	634	13,608	571	12,852	500	11,340	408	10,584	317	
		20	0.01	18,144	761	15,120	634	13,608	571	12,852	500	11,340	408	10,584	317	
	1.5	0.1	4	0.042	33,264	2,153	27,700	1,793	24,948	1,614	23,285	1,378	20,790	1,076	19,293	883
			8	0.036	30,240	1,956	25,200	1,630	22,680	1,467	21,420	1,386	18,900	1,087	17,640	888
			12	0.036	24,192	1,565	20,160	1,304	18,144	1,174	17,136	1,109	15,120	870	14,112	710
			15	0.023	18,816	1,082	15,680	902	14,112	812	13,328	671	11,760	592	10,976	473
			20	0.018	18,816	1,082	15,680	902	14,112	812	13,328	671	11,760	592	10,976	473
0.2		4	0.07	33,264	2,153	27,700	1,793	24,948	1,614	23,285	1,378	20,790	1,076	19,293	883	
		8	0.06	30,240	1,956	25,200	1,630	22,680	1,467	21,420	1,386	18,900	1,087	17,640	888	
		12	0.06	24,192	1,565	20,160	1,304	18,144	1,174	17,136	1,109	15,120	870	14,112	710	
		15	0.038	18,816	1,082	15,680	902	14,112	812	13,328	671	11,760	592	10,976	473	
		20	0.03	18,816	1,082	15,680	902	14,112	812	13,328	671	11,760	592	10,976	473	
0.3		8	0.06	30,240	1,956	25,200	1,630	22,680	1,467	21,420	1,386	18,900	1,087	17,640	888	
		15	0.038	18,816	1,082	15,680	902	14,112	812	13,328	671	11,760	592	10,976	473	
		20	0.03	18,816	1,082	15,680	902	14,112	812	13,328	671	11,760	592	10,976	473	
		20	0.03	18,816	1,082	15,680	902	14,112	812	13,328	671	11,760	592	10,976	473	
		20	0.03	18,816	1,082	15,680	902	14,112	812	13,328	671	11,760	592	10,976	473	

超硬エンドミル
ラジラスエンドミル

被削材 Work material				1		2		3		4		5		6		
				銅 Coppers		炭素鋼・合金鋼 Carbon steels, Alloy steels		ステンレス鋼・工具鋼 Stainless steels, Tool steels		プリハードン鋼 Pre-hardened steels		焼入れ鋼 Hardened steels		焼入れ鋼 Hardened steels		
切り込み比率 Ratio to standard depth of cut				120%		100%		90%		80%		65%		60%		
外径DC Tool dia. (mm)	コーナ半径R Corner radius (mm)	首下長LU Under neck length (mm)	基本切り込み Standard depth of cut (mm)	回転数 n min ⁻¹	送り速度 V _f mm/min	回転数 n min ⁻¹	送り速度 V _f mm/min	回転数 n min ⁻¹	送り速度 V _f mm/min	回転数 n min ⁻¹	送り速度 V _f mm/min	回転数 n min ⁻¹	送り速度 V _f mm/min	回転数 n min ⁻¹	送り速度 V _f mm/min	
2	0.2	6	0.08	27,720	3,114	23,100	2,595	20,790	2,335	19,635	2,205	17,325	1,557	16,170	1,271	
		8	0.07	25,200	2,830	21,000	2,359	18,900	2,123	17,850	2,005	15,750	1,415	14,700	1,156	
		12	0.04	20,412	2,063	17,010	1,720	15,309	1,548	14,459	1,462	12,758	1,146	11,907	936	
		16	0.04	18,144	1,834	15,120	1,528	13,608	1,376	12,852	1,299	11,340	1,019	10,584	832	
		20	0.035	15,876	1,605	13,230	1,337	11,907	1,204	11,246	1,137	9,923	892	9,261	728	
		25	0.025	15,876	1,605	13,230	1,337	11,907	1,204	11,246	1,137	9,923	892	9,261	728	
	0.3	8	0.09	25,200	3,145	21,000	2,621	18,900	2,359	17,850	2,228	15,750	1,572	14,700	1,284	
		16	0.06	18,144	2,038	15,120	1,698	13,608	1,528	12,852	1,444	11,340	1,132	10,584	925	
		20	0.037	15,876	1,783	13,230	1,486	11,907	1,337	11,246	1,263	9,923	991	9,261	809	
		0.5	6	0.17	27,720	3,459	23,100	2,883	20,790	2,595	19,635	2,450	17,325	1,730	16,170	1,413
			8	0.14	25,200	3,145	21,000	2,621	18,900	2,359	17,850	2,228	15,750	1,572	14,700	1,284
			12	0.08	20,412	2,293	17,010	1,911	15,309	1,720	14,459	1,624	12,758	1,274	11,907	1,040
	16		0.08	18,144	2,038	15,120	1,698	13,608	1,528	12,852	1,444	11,340	1,132	10,584	925	
	20	0.05	15,876	1,783	13,230	1,486	11,907	1,337	11,246	1,263	9,923	991	9,261	809		
	25	0.05	15,876	1,783	13,230	1,486	11,907	1,337	11,246	1,263	9,923	991	9,261	809		
	0.8	30	0.03	15,082	1,694	12,569	1,412	11,312	1,271	10,683	1,200	9,426	941	8,798	769	
		8	0.2	25,200	3,145	21,000	2,621	18,900	2,359	17,850	2,228	15,750	1,572	14,700	1,284	
		16	0.1	18,144	2,038	15,120	1,698	13,608	1,528	12,852	1,444	11,340	1,132	10,584	925	
		20	0.06	15,876	1,783	13,230	1,486	11,907	1,337	11,246	1,263	9,923	991	9,261	809	
	3	0.2	8	0.09	19,200	2,696	16,000	2,246	14,400	2,022	13,600	1,909	12,000	1,348	11,200	1,101
			12	0.07	19,200	2,696	16,000	2,246	14,400	2,022	13,600	1,909	12,000	1,348	11,200	1,101
			16	0.05	19,200	2,696	16,000	2,246	14,400	2,022	13,600	1,909	12,000	1,348	11,200	1,101
			20	0.05	15,552	2,184	12,960	1,820	11,664	1,638	11,016	1,547	9,720	1,213	9,072	991
			30	0.04	12,096	2,184	10,080	1,820	9,072	1,638	8,568	1,547	7,560	1,213	7,056	991
35			0.035	12,096	2,184	10,080	1,820	9,072	1,638	8,568	1,547	7,560	1,213	7,056	991	
0.3		8	0.13	19,200	2,995	16,000	2,496	14,400	2,246	13,600	2,122	12,000	1,498	11,200	1,223	
		16	0.075	19,200	2,995	16,000	2,496	14,400	2,246	13,600	2,122	12,000	1,498	11,200	1,223	
		20	0.075	15,552	2,426	12,960	2,022	11,664	1,820	11,016	1,718	9,720	1,348	9,072	1,101	
		30	0.06	12,096	2,426	10,080	2,022	9,072	1,820	8,568	1,718	7,560	1,348	7,056	1,101	
		0.5	8	0.18	19,200	2,995	16,000	2,496	14,400	2,246	13,600	2,122	12,000	1,498	11,200	1,223
			12	0.13	19,200	2,995	16,000	2,496	14,400	2,246	13,600	2,122	12,000	1,498	11,200	1,223
16			0.1	19,200	2,995	16,000	2,496	14,400	2,246	13,600	2,122	12,000	1,498	11,200	1,223	
20			0.1	15,552	2,426	12,960	2,022	11,664	1,820	11,016	1,718	9,720	1,348	9,072	1,101	
30			0.08	12,096	2,426	10,080	2,022	9,072	1,820	8,568	1,718	7,560	1,348	7,056	1,101	
35			0.065	12,096	2,426	10,080	2,022	9,072	1,820	8,568	1,718	7,560	1,348	7,056	1,101	

※基本切り込みは被削材グループ2での目安を示しています。その他のグループの場合は、上表の切り込み比率を目安に調整して下さい。
 ※Standard cutting depth is shown as the criteria for Group 2 workpieces. For other groups, adjust the cutting depth according to the cutting depth factors in the above table.

- [注意]**
- ①被削材、加工形状に合わせて、適切なクーラントを使用してください。
 - ②この標準切削条件表は切削条件の目安を示すものです。実際の加工では加工形状、目的、使用機械等により条件を調整してください。
 - ③機械の回転数が足りない場合は、回転数と送り速度を同じ比率で下げてください。

- [Note]**
1. Use the appropriate coolant for the work material and machining shape.
 2. These Recommended Cutting Conditions indicate only the rule of a thumb for the cutting conditions. In actual machining, the condition should be adjusted according to the machining shape, purpose and the machine type.
 3. If the rpm of the machine is low, lower the feed rate also to put the rpm and feed rate in the same ratio.

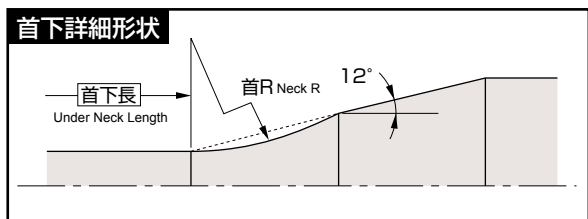

【注意】
 エポックディープスクエアEPDSとは有効首下長が異なります。再度ご確認ください。

【Note】
 The effective under-neck length is different from Epoch Deep Square EPDS. Please recheck the interference region.

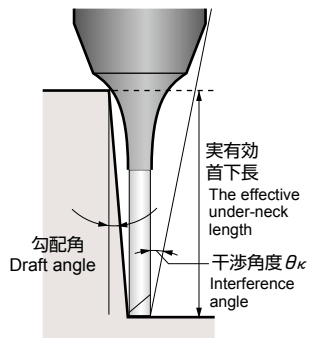

EPDSE2-ATH

商品コード Item code	在庫 Stock ATH	寸法 Size(mm)							干渉角度 Interference angle $\theta\kappa$	勾配角に対する実有効首下長 Effective under neck length with respect to draft angle					希望小売 価格(円) Suggested retail price (¥)
		外径 Tool dia.	首下長 Under Neck length	刃長 Flute length	首径 Neck dia.	全長 Overall length	シャンク径 Shank dia.	首R Neck R		0.5°	1°	1.5°	2°	3°	
		DC	LU	APMX	DN	LF	DCONMS								
EPDSE2008-2-ATH	●	0.8	2	1.2	0.77	50	4	4	9.47	2.54	2.70	2.84	2.96	3.19	5,440
EPDSE2008-4-ATH	●		4	1.2	0.77	50	4	4	7.86	4.66	4.89	5.07	5.24	5.53	5,440
EPDSE2008-6-ATH	●		6	1.2	0.77	50	4	4	6.72	6.76	7.04	7.26	7.45	8.05	5,440
EPDSE2008-8-ATH	●		8	1.2	0.77	50	4	4	5.86	8.85	9.17	9.42	9.65	10.71	5,440
EPDSE2008-10-ATH	●		10	1.2	0.77	50	4	4	5.20	10.93	11.28	11.56	12.05	13.36	7,940
EPDSE2008-12-ATH	●		12	1.2	0.77	55	4	4	4.67	13.00	13.38	13.76	14.44	16.02	9,060
EPDSE2009-2-ATH	●	0.9	2	1.35	0.86	50	4	4	9.38	2.58	2.73	2.86	2.98	3.21	6,270
EPDSE2009-4-ATH	●		4	1.35	0.86	50	4	4	7.76	4.69	4.91	5.09	5.26	5.54	6,270
EPDSE2009-6-ATH	●		6	1.35	0.86	50	4	4	6.61	6.79	7.06	7.28	7.47	8.08	6,270
EPDSE2009-8-ATH	●		8	1.35	0.86	50	4	4	5.76	8.87	9.18	9.43	9.68	10.74	6,270
EPDSE2009-10-ATH	●		10	1.35	0.86	50	4	4	5.10	10.95	11.30	11.57	12.07	13.39	6,270
EPDSE2009-12-ATH	●		12	1.35	0.86	55	4	4	4.58	13.02	13.40	13.79	14.47	16.05	7,160
EPDSE2010-2-ATH	●	1	2	1.5	0.96	50	4	4	9.31	2.58	2.73	2.86	2.98	3.21	4,890
EPDSE2010-3-ATH	●		3	1.5	0.96	50	4	4	8.41	3.64	3.82	3.99	4.13	4.39	4,890
EPDSE2010-4-ATH	●		4	1.5	0.96	50	4	4	7.67	4.69	4.91	5.09	5.26	5.54	4,890
EPDSE2010-5-ATH	●		5	1.5	0.96	50	4	4	7.04	5.74	5.99	6.19	6.37	6.76	4,890
EPDSE2010-6-ATH	●		6	1.5	0.96	50	4	4	6.51	6.79	7.06	7.28	7.47	8.08	4,890
EPDSE2010-7-ATH	●		7	1.5	0.96	50	4	4	6.06	7.83	8.12	8.36	8.56	9.41	4,890
EPDSE2010-8-ATH	●		8	1.5	0.96	50	4	4	5.66	8.87	9.18	9.43	9.68	10.74	4,890
EPDSE2010-9-ATH	●		9	1.5	0.96	50	4	4	5.31	9.91	10.24	10.50	10.88	12.07	4,890
EPDSE2010-10-ATH	●		10	1.5	0.96	50	4	4	5.00	10.95	11.30	11.57	12.07	13.39	4,890
EPDSE2010-12-ATH	●		12	1.5	0.96	55	4	4	4.48	13.02	13.40	13.79	14.47	16.05	4,890
EPDSE2010-14-ATH	●		14	1.5	0.96	55	4	4	4.06	15.09	15.49	16.07	16.86	18.70	4,890
EPDSE2010-16-ATH	●		16	1.5	0.96	55	4	4	3.71	17.15	17.58	18.35	19.25	21.36	7,940
EPDSE2010-20-ATH	●		20	1.5	0.96	60	4	4	3.17	21.26	21.89	22.91	24.04	26.66	7,940
EPDSE2010-25-ATH	●		25	1.5	0.96	65	4	4	2.68	26.39	27.33	28.61	30.02	干渉なし	9,200
EPDSE2012-4-ATH	●		1.2	4	1.8	1.15	50	4	4	7.46	4.72	4.93	5.11	5.27	5.55
EPDSE2012-6-ATH	●	6		1.8	1.15	50	4	4	6.29	6.81	7.08	7.29	7.48	8.11	5,160
EPDSE2012-8-ATH	●	8		1.8	1.15	50	4	4	5.44	8.90	9.20	9.45	9.71	10.77	5,160
EPDSE2012-10-ATH	●	10		1.8	1.15	50	4	4	4.80	10.97	11.31	11.58	12.10	13.42	5,160
EPDSE2012-12-ATH	●	12		1.8	1.15	55	4	4	4.29	13.04	13.41	13.82	14.49	16.08	5,160
EPDSE2012-16-ATH	●	16		1.8	1.15	55	4	4	3.53	17.16	17.59	18.38	19.28	21.39	8,230
EPDSE2014-6-ATH	●	1.4	6	2.1	1.34	50	4	4	6.06	6.84	7.09	7.31	7.50	8.15	5,300
EPDSE2014-12-ATH	●		12	2.1	1.34	55	4	4	4.08	13.06	13.43	13.84	14.52	16.11	5,300
EPDSE2015-4-ATH	●	1.5	4	2.25	1.44	50	4	4	7.11	4.75	4.95	5.13	5.29	5.57	5,160
EPDSE2015-6-ATH	●		6	2.25	1.44	50	4	4	5.94	6.84	7.09	7.31	7.50	8.15	5,160
EPDSE2015-8-ATH	●		8	2.25	1.44	50	4	4	5.10	8.92	9.22	9.46	9.74	10.80	5,160
EPDSE2015-10-ATH	●		10	2.25	1.44	50	4	4	4.47	10.99	11.33	11.59	12.13	13.45	5,160
EPDSE2015-12-ATH	●		12	2.25	1.44	55	4	4	3.97	13.06	13.43	13.84	14.52	16.11	5,160
EPDSE2015-14-ATH	●		14	2.25	1.44	55	4	4	3.58	15.12	15.52	16.12	16.92	18.76	5,300
EPDSE2015-16-ATH	●		16	2.25	1.44	55	4	4	3.25	17.18	17.60	18.40	19.31	21.42	5,300
EPDSE2015-18-ATH	●		18	2.25	1.44	60	4	4	2.98	19.24	19.76	20.69	21.70	干渉なし	5,300
EPDSE2015-20-ATH	●		20	2.25	1.44	60	4	4	2.76	21.29	21.94	22.97	24.10	干渉なし	5,300
EPDSE2015-25-ATH	●		25	2.25	1.44	65	4	4	2.31	26.42	27.39	28.67	30.08	干渉なし	7,940
EPDSE2015-30-ATH	●		30	2.25	1.44	70	4	4	1.99	31.53	32.83	34.37	干渉なし	干渉なし	7,940
EPDSE2015-35-ATH	●		35	2.25	1.44	75	4	4	1.75	36.64	38.28	40.07	干渉なし	干渉なし	9,060
EPDSE2015-40-ATH	●	40	2.25	1.44	80	4	4	1.56	41.85	43.73	45.78	干渉なし	干渉なし	10,170	
EPDSE2016-6-ATH	●	1.6	6	2.4	1.54	50	4	4	5.82	6.84	7.09	7.31	7.50	8.15	5,300
EPDSE2016-8-ATH	●		8	2.4	1.54	50	4	4	4.98	8.92	9.22	9.46	9.74	10.80	5,300
EPDSE2018-6-ATH	●	1.8	6	2.7	1.73	50	4	4	5.55	6.86	7.11	7.32	7.51	8.18	5,300
EPDSE2018-8-ATH	●		8	2.7	1.73	50	4	4	4.72	8.94	9.23	9.47	9.76	10.83	5,300

EPDSE2-000-000-ATH

商品コード Item code	在庫 Stock ATH	寸法 Size(mm)							干渉角度 Interference angle θ_K	勾配角に対する実有効首下長 Effective under neck length with respect to draft angle					希望小売 価格(円) Suggested retail price (¥)
		外径 Tool dia. DC	首下長 Under Neck length LU	刃長 Flute length APMX	首径 Neck dia. DN	全長 Overall length LF	シャンク径 Shank dia. DCONMS	首R Neck R R		0.5°	1°	1.5°	2°	3°	
		EPDSE2020-4-ATH	●	4	3	1.92	50	4		4	6.42	4.80	5.00	5.17	
EPDSE2020-6-ATH	●	6	3	1.92	50	4	4	5.25	6.88	7.13	7.34	7.52	8.21	5,160	
EPDSE2020-8-ATH	●	8	3	1.92	50	4	4	4.44	8.96	9.25	9.49	9.79	10.86	5,160	
EPDSE2020-10-ATH	●	10	3	1.92	50	4	4	3.85	11.03	11.35	11.62	12.19	13.52	5,160	
EPDSE2020-12-ATH	●	12	3	1.92	55	4	4	3.39	13.10	13.45	13.90	14.58	16.17	5,160	
EPDSE2020-14-ATH	●	14	3	1.92	55	4	4	3.03	15.16	15.54	16.18	16.97	18.83	5,160	
EPDSE2020-16-ATH	●	16	3	1.92	55	4	4	2.75	17.21	17.63	18.46	19.37	干涉なし	5,160	
EPDSE2020-18-ATH	●	18	3	1.92	60	4	4	2.51	19.27	19.81	20.74	21.76	干涉なし	5,160	
EPDSE2020-20-ATH	●	20	3	1.92	60	4	4	2.31	21.32	21.99	23.02	24.15	干涉なし	5,160	
EPDSE2020-25-ATH	●	25	3	1.92	65	4	4	1.92	26.44	27.44	28.72	干涉なし	干涉なし	5,160	
EPDSE2020-30-ATH	●	30	3	1.92	70	4	4	1.65	31.55	32.88	34.42	干涉なし	干涉なし	6,410	
EPDSE2020-35-ATH	●	35	3	1.92	75	4	4	1.44	36.69	38.33	干涉なし	干涉なし	干涉なし	7,670	
EPDSE2020-40-ATH	●	40	3	1.92	80	4	4	1.28	41.90	43.78	干涉なし	干涉なし	干涉なし	9,610	
EPDSE2020-50-ATH	●	50	3	1.92	90	4	4	1.05	52.33	54.67	干涉なし	干涉なし	干涉なし	11,580	
EPDSE2025-8-ATH	●	8	3.75	2.4	50	4	4	3.65	9.00	9.28	9.51	9.85	10.93	5,440	
EPDSE2025-12-ATH	●	12	3.75	2.4	55	4	4	2.73	13.13	13.48	13.95	14.64	干涉なし	5,440	
EPDSE2025-16-ATH	●	16	3.75	2.4	55	4	4	2.18	17.25	17.68	18.51	19.42	干涉なし	5,440	
EPDSE2025-20-ATH	●	20	3.75	2.4	60	4	4	1.81	21.35	22.04	23.07	干涉なし	干涉なし	5,440	
EPDSE2025-30-ATH	●	30	3.75	2.4	70	4	4	1.28	31.58	32.94	干涉なし	干涉なし	干涉なし	5,850	
EPDSE2025-40-ATH	●	40	3.75	2.4	80	4	4	0.99	41.95	干涉なし	干涉なし	干涉なし	干涉なし	8,230	
EPDSE2025-50-ATH	●	50	3.75	2.4	90	4	4	0.80	52.38	干涉なし	干涉なし	干涉なし	干涉なし	10,170	
EPDSE2030-8-ATH	●	8	4.5	2.88	55	6	4	5.59	9.04	9.31	9.54	9.91	10.99	6,970	
EPDSE2030-12-ATH	●	12	4.5	2.88	60	6	4	4.44	13.16	13.50	14.00	14.69	16.30	6,970	
EPDSE2030-16-ATH	●	16	4.5	2.88	60	6	4	3.68	17.28	17.73	18.57	19.48	21.61	6,970	
EPDSE2030-20-ATH	●	20	4.5	2.88	65	6	4	3.15	21.38	22.09	23.13	24.26	26.91	6,970	
EPDSE2030-25-ATH	●	25	4.5	2.88	70	6	4	2.66	26.49	27.54	28.83	30.25	干涉なし	6,970	
EPDSE2030-30-ATH	●	30	4.5	2.88	75	6	4	2.31	31.60	32.99	34.53	36.23	干涉なし	8,360	
EPDSE2030-40-ATH	●	40	4.5	2.88	90	6	4	1.82	42.00	43.88	45.94	干涉なし	干涉なし	8,650	
EPDSE2030-50-ATH	●	50	4.5	2.88	100	6	4	1.50	52.43	54.78	干涉なし	干涉なし	干涉なし	12,110	
EPDSE2040-12-ATH	●	12	6	3.85	60	6	4	3.36	13.21	13.54	14.08	14.78	16.39	8,090	
EPDSE2040-16-ATH	●	16	6	3.85	60	6	4	2.72	17.32	17.81	18.65	19.56	干涉なし	8,090	
EPDSE2040-20-ATH	●	20	6	3.85	70	6	4	2.29	21.42	22.17	23.21	24.35	干涉なし	8,090	
EPDSE2040-25-ATH	●	25	6	3.85	70	6	4	1.91	26.53	27.62	28.91	干涉なし	干涉なし	8,090	
EPDSE2040-30-ATH	●	30	6	3.85	80	6	4	1.64	31.65	33.06	34.61	干涉なし	干涉なし	8,090	
EPDSE2040-35-ATH	●	35	6	3.85	80	6	4	1.44	36.86	38.51	干涉なし	干涉なし	干涉なし	8,090	
EPDSE2040-40-ATH	●	40	6	3.85	90	6	4	1.28	42.08	43.96	干涉なし	干涉なし	干涉なし	10,170	
EPDSE2040-50-ATH	●	50	6	3.85	100	6	4	1.05	52.50	54.85	干涉なし	干涉なし	干涉なし	15,000	
EPDSE2050-20-ATH	●	20	7.5	4.85	70	6	4	1.27	21.42	22.17	干涉なし	干涉なし	干涉なし	10,650	
EPDSE2050-25-ATH	●	25	7.5	4.85	70	6	4	1.04	26.53	27.62	干涉なし	干涉なし	干涉なし	10,650	
EPDSE2050-30-ATH	●	30	7.5	4.85	80	6	4	0.88	31.65	干涉なし	干涉なし	干涉なし	干涉なし	10,650	
EPDSE2050-40-ATH	●	40	7.5	4.85	90	6	4	0.68	42.08	干涉なし	干涉なし	干涉なし	干涉なし	10,650	
EPDSE2050-50-ATH	●	50	7.5	4.85	100	6	4	0.55	52.50	干涉なし	干涉なし	干涉なし	干涉なし	16,830	
EPDSE2060-20-ATH	●	20	9	5.85	70	6	-	0	干涉なし	干涉なし	干涉なし	干涉なし	干涉なし	10,950	
EPDSE2060-30-ATH	●	30	9	5.85	80	6	-	0	干涉なし	干涉なし	干涉なし	干涉なし	干涉なし	11,220	
EPDSE2060-40-ATH	●	40	9	5.85	90	6	-	0	干涉なし	干涉なし	干涉なし	干涉なし	干涉なし	13,250	
EPDSE2060-50-ATH	●	50	9	5.85	100	6	-	0	干涉なし	干涉なし	干涉なし	干涉なし	干涉なし	16,830	

炭素鋼 合金鋼 Carbon steel Alloy steel	プリハー ド鋼 Pre-hardened steel	高硬度 Hardened steel			ステン レス鋼 Stainless steel	チタン合金 耐熱合金 Titanium alloy Heat-resistant alloy	銅合金 Copper alloy	アルミ 合金 Aluminum alloy
○	◎	> 45HRC ≤ 55HRC	> 55HRC ≤ 65HRC	> 65HRC	○	◎	○	

再研磨対応外径範囲 Re-grinding compatibility range		
商品コード Item code	外周 Outer dia. (mm)	エンド End (mm)
EPDSE-ATH	6	2~6

[注意] 首下長/外径が10DCを超える工具の再研磨可否については、弊社営業にお問い合わせください。
[Note] Contact our sales office regarding whether or not re-grinding is possible for tools where under neck length/tool diameter more than 10DC

● : 標準在庫品です。 ◎ : Stocked items. 干涉なし : No interference

エポックディープスクエア エボリューション PN Coating



外径公差
Dia. tolerance

φ0.1~φ0.5 : 0~-0.007
φ0.6~φ0.9 : 0~-0.01
φ1~φ6 : 0~-0.015



(mm)

刃先と首形状の改良によりタオレを抑制し高精度加工を実現。

ATH&PNコーティングの採用で更なる長寿命加工。

Improved flute tip shape and neck shape suppresses warping to enable high-accuracy cutting. Use of ATH and PN coatings further extends tool life.

2枚刃
2 Flutes

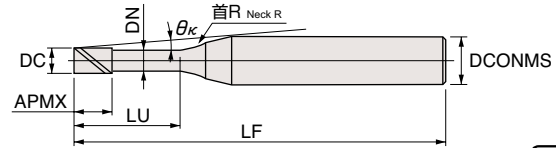

切削条件表 A298
Cutting Conditions

超硬 PN 傾斜30°
Carbide Helix angle

EPDSE2-0.1-0.5-1-0.2-0.3-0.4-0.5-0.6-0.7-PN

商品コード Item code	在庫 Stock	寸法 Size(mm)							干渉角度 Interference angle θκ	勾配角に対する実有効首下長 Effective under neck length with respect to draft angle					希望小売 価格(円) Suggested retail price (¥)
		外径 Tool dia. DC	首下長 Under Neck length LU	刃長 Flute length APMX	首径 Neck dia. DN	全長 Overall length LF	シャンク径 Shank dia. DCONMS	首R Neck R		0.5°	1°	1.5°	2°	3°	
										PN					
EPDSE2001-0.3-PN	●	0.1	0.3	0.15	0.08	45	4	1	11.58	0.46	0.49	0.51	0.53	0.58	12,970
EPDSE2001-0.5-PN	●		0.5	0.15	0.08	45	4	1	11.35	0.67	0.71	0.74	0.76	0.82	14,150
EPDSE2001-1-PN	●		1	0.15	0.08	45	4	1	10.81	1.20	1.25	1.29	1.33	1.39	17,680
EPDSE2002-0.5-PN	●	0.2	0.5	0.3	0.17	50	4	1	11.30	0.70	0.73	0.76	0.78	0.83	8,490
EPDSE2002-1-PN	●		1	0.3	0.17	50	4	1	10.75	1.22	1.27	1.31	1.34	1.42	9,200
EPDSE2002-1.5-PN	●		1.5	0.3	0.17	50	4	1	10.25	1.74	1.80	1.85	1.89	2.08	11,040
EPDSE2002-2-PN	●	0.3	2	0.3	0.17	50	4	1	9.80	2.26	2.32	2.38	2.47	2.74	12,440
EPDSE2002-3-PN	●		3	0.3	0.17	50	4	1	9.00	3.29	3.37	3.50	3.67	4.07	12,860
EPDSE2003-1-PN	●		1	0.45	0.27	50	4	2	10.72	1.32	1.39	1.45	1.51	1.62	7,430
EPDSE2003-1.5-PN	●	0.4	1.5	0.45	0.27	50	4	2	10.21	1.85	1.93	2.01	2.08	2.21	7,430
EPDSE2003-2-PN	●		2	0.45	0.27	50	4	2	9.75	2.37	2.47	2.56	2.64	2.78	9,200
EPDSE2003-2.5-PN	●		2.5	0.45	0.27	50	4	2	9.32	2.89	3.01	3.11	3.20	3.41	9,550
EPDSE2003-3-PN	●	0.5	3	0.45	0.27	50	4	2	8.93	3.42	3.54	3.65	3.75	4.07	9,550
EPDSE2004-1-PN	●		1	0.6	0.37	50	4	2	10.69	1.32	1.39	1.45	1.51	1.62	5,430
EPDSE2004-1.5-PN	●		0.6	1.5	0.6	0.37	50	4	2	10.17	1.85	1.93	2.01	2.08	2.21
EPDSE2004-2-PN	●	2		0.6	0.37	50	4	2	9.70	2.37	2.47	2.56	2.64	2.78	5,430
EPDSE2004-2.5-PN	●	2.5		0.6	0.37	50	4	2	9.27	2.89	3.01	3.11	3.20	3.41	5,430
EPDSE2004-3-PN	●	0.7	3	0.6	0.37	50	4	2	8.87	3.42	3.54	3.65	3.75	4.07	5,430
EPDSE2004-3.5-PN	●		3.5	0.6	0.37	50	4	2	8.51	3.94	4.08	4.19	4.29	4.73	5,430
EPDSE2004-4-PN	●		4	0.6	0.37	50	4	2	8.17	4.46	4.61	4.73	4.87	5.40	5,430
EPDSE2004-5-PN	●	0.8	5	0.6	0.37	50	4	2	7.58	5.49	5.66	5.79	6.06	6.72	5,430
EPDSE2004-6-PN	●		6	0.6	0.37	50	4	2	7.06	6.53	6.71	6.92	7.26	8.05	6,720
EPDSE2004-8-PN	●		8	0.6	0.37	50	4	2	6.22	8.59	8.80	9.20	9.65	10.71	11,790
EPDSE2004-10-PN	●	1.0	10	0.6	0.37	50	4	2	5.55	10.64	10.97	11.48	12.05	13.36	12,860
EPDSE2005-1-PN	●		1	0.75	0.47	50	4	2	10.66	1.32	1.39	1.45	1.51	1.62	3,900
EPDSE2005-1.5-PN	●		0.5	1.5	0.75	0.47	50	4	2	10.13	1.85	1.93	2.01	2.08	2.21
EPDSE2005-2-PN	●	2		0.75	0.47	50	4	2	9.64	2.37	2.47	2.56	2.64	2.78	3,900
EPDSE2005-2.5-PN	●	2.5		0.75	0.47	50	4	2	9.21	2.89	3.01	3.11	3.20	3.41	3,900
EPDSE2005-3-PN	●	0.6	3	0.75	0.47	50	4	2	8.81	3.42	3.54	3.65	3.75	4.07	3,900
EPDSE2005-4-PN	●		4	0.75	0.47	50	4	2	8.10	4.46	4.61	4.73	4.87	5.40	3,900
EPDSE2005-5-PN	●		5	0.75	0.47	50	4	2	7.50	5.49	5.66	5.79	6.06	6.72	3,900
EPDSE2005-6-PN	●	0.7	6	0.75	0.47	50	4	2	6.98	6.53	6.71	6.92	7.26	8.05	3,900
EPDSE2005-8-PN	●		8	0.75	0.47	50	4	2	6.13	8.59	8.80	9.20	9.65	10.71	6,490
EPDSE2005-10-PN	●		10	0.75	0.47	50	4	2	5.47	10.64	10.97	11.48	12.05	13.36	6,490
EPDSE2006-2-PN	●	0.8	2	0.9	0.57	50	4	4	9.59	2.54	2.70	2.84	2.96	3.19	4,130
EPDSE2006-3-PN	●		3	0.9	0.57	50	4	4	8.74	3.60	3.80	3.96	4.11	4.37	4,130
EPDSE2006-4-PN	●		4	0.9	0.57	50	4	4	8.02	4.66	4.89	5.07	5.24	5.53	4,130
EPDSE2006-5-PN	●	0.9	5	0.9	0.57	50	4	4	7.42	5.71	5.96	6.17	6.35	6.72	4,130
EPDSE2006-6-PN	●		6	0.9	0.57	50	4	4	6.90	6.76	7.04	7.26	7.45	8.05	4,130
EPDSE2006-7-PN	●		7	0.9	0.57	50	4	4	6.44	7.81	8.10	8.34	8.55	9.38	5,190
EPDSE2006-8-PN	●	1.0	8	0.9	0.57	50	4	4	6.04	8.85	9.17	9.42	9.65	10.71	6,720
EPDSE2006-9-PN	●		9	0.9	0.57	50	4	4	5.69	9.89	10.22	10.49	10.85	12.03	7,790
EPDSE2006-10-PN	●		10	0.9	0.57	50	4	4	5.38	10.93	11.28	11.56	12.05	13.36	7,790
EPDSE2007-2-PN	●	0.9	2	1.05	0.67	50	4	4	9.53	2.54	2.70	2.84	2.96	3.19	4,720
EPDSE2007-4-PN	●		4	1.05	0.67	50	4	4	7.94	4.66	4.89	5.07	5.24	5.53	4,720
EPDSE2007-6-PN	●		6	1.05	0.67	50	4	4	6.81	6.76	7.04	7.26	7.45	8.05	4,720
EPDSE2007-8-PN	●	1.0	8	1.05	0.67	50	4	4	5.95	8.85	9.17	9.42	9.65	10.71	7,670
EPDSE2007-10-PN	●		10	1.05	0.67	50	4	4	5.29	10.93	11.28	11.56	12.05	13.36	10,020

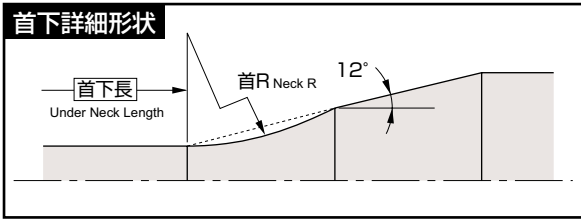

【注意】

エポックディープスクエアEPDSとは有効首下長が異なります。再度ご確認ください。

【Note】

The effective under-neck length is different from Epoch Deep Square EPDS. Please recheck the interference region.

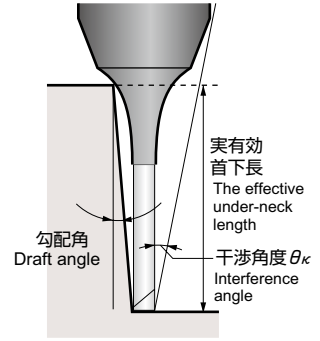

EPDSE2-0.8-1.8-PN

商品コード Item code	在庫 Stock PN	寸法 Size(mm)							干渉角度 Interference angle θ_k	勾配角に対する有効首下長 Effective under neck length with respect to draft angle					希望小売 価格(円) Suggested retail price (¥)
		外径 Tool dia. DC	首下長 Under Neck length LU	刃長 Flute length APMX	首径 Neck dia. DN	全長 Overall length LF	シャンク径 Shank dia. DCONMS	首R Neck R		0.5°	1°	1.5°	2°	3°	
EPDSE2008-2-PN	●	0.8	2	1.2	0.77	50	4	4	9.47	2.54	2.70	2.84	2.96	3.19	4,600
EPDSE2008-4-PN	●	0.8	4	1.2	0.77	50	4	4	7.86	4.66	4.89	5.07	5.24	5.53	4,600
EPDSE2008-6-PN	●	0.8	6	1.2	0.77	50	4	4	6.72	6.76	7.04	7.26	7.45	8.05	4,600
EPDSE2008-8-PN	●	0.8	8	1.2	0.77	50	4	4	5.86	8.85	9.17	9.42	9.65	10.71	4,600
EPDSE2008-10-PN	●	0.8	10	1.2	0.77	50	4	4	5.20	10.93	11.28	11.56	12.05	13.36	6,720
EPDSE2008-12-PN	●	0.8	12	1.2	0.77	55	4	4	4.67	13.00	13.38	13.76	14.44	16.02	7,670
EPDSE2009-2-PN	●	0.9	2	1.35	0.86	50	4	4	9.38	2.58	2.73	2.86	2.98	3.21	5,310
EPDSE2009-4-PN	●	0.9	4	1.35	0.86	50	4	4	7.76	4.69	4.91	5.09	5.26	5.54	5,310
EPDSE2009-6-PN	●	0.9	6	1.35	0.86	50	4	4	6.61	6.79	7.06	7.28	7.47	8.08	5,310
EPDSE2009-8-PN	●	0.9	8	1.35	0.86	50	4	4	5.76	8.87	9.18	9.43	9.68	10.74	5,310
EPDSE2009-10-PN	●	0.9	10	1.35	0.86	50	4	4	5.10	10.95	11.30	11.57	12.07	13.39	5,310
EPDSE2009-12-PN	●	0.9	12	1.35	0.86	55	4	4	4.58	13.02	13.40	13.79	14.47	16.05	6,050
EPDSE2010-2-PN	●	1	2	1.5	0.96	50	4	4	9.31	2.58	2.73	2.86	2.98	3.21	4,130
EPDSE2010-3-PN	●	1	3	1.5	0.96	50	4	4	8.41	3.64	3.82	3.99	4.13	4.39	4,130
EPDSE2010-4-PN	●	1	4	1.5	0.96	50	4	4	7.67	4.69	4.91	5.09	5.26	5.54	4,130
EPDSE2010-5-PN	●	1	5	1.5	0.96	50	4	4	7.04	5.74	5.99	6.19	6.37	6.76	4,130
EPDSE2010-6-PN	●	1	6	1.5	0.96	50	4	4	6.51	6.79	7.06	7.28	7.47	8.08	4,130
EPDSE2010-7-PN	●	1	7	1.5	0.96	50	4	4	6.06	7.83	8.12	8.36	8.56	9.41	4,130
EPDSE2010-8-PN	●	1	8	1.5	0.96	50	4	4	5.66	8.87	9.18	9.43	9.68	10.74	4,130
EPDSE2010-9-PN	●	1	9	1.5	0.96	50	4	4	5.31	9.91	10.24	10.50	10.88	12.07	4,130
EPDSE2010-10-PN	●	1	10	1.5	0.96	50	4	4	5.00	10.95	11.30	11.57	12.07	13.39	4,130
EPDSE2010-12-PN	●	1	12	1.5	0.96	55	4	4	4.48	13.02	13.40	13.79	14.47	16.05	4,130
EPDSE2010-14-PN	●	1	14	1.5	0.96	55	4	4	4.06	15.09	15.49	16.07	16.86	18.70	4,130
EPDSE2010-16-PN	●	1	16	1.5	0.96	55	4	4	3.71	17.15	17.58	18.35	19.25	21.36	6,720
EPDSE2010-20-PN	●	1	20	1.5	0.96	60	4	4	3.17	21.26	21.89	22.91	24.04	26.66	6,720
EPDSE2010-25-PN	●	1	25	1.5	0.96	65	4	4	2.68	26.39	27.33	28.61	30.02	干渉なし	7,790
EPDSE2012-4-PN	●	1.2	4	1.8	1.15	50	4	4	7.46	4.72	4.93	5.11	5.27	5.55	4,370
EPDSE2012-6-PN	●	1.2	6	1.8	1.15	50	4	4	6.29	6.81	7.08	7.29	7.48	8.11	4,370
EPDSE2012-8-PN	●	1.2	8	1.8	1.15	50	4	4	5.44	8.90	9.20	9.45	9.71	10.77	4,370
EPDSE2012-10-PN	●	1.2	10	1.8	1.15	50	4	4	4.80	10.97	11.31	11.58	12.10	13.42	4,370
EPDSE2012-12-PN	●	1.2	12	1.8	1.15	55	4	4	4.29	13.04	13.41	13.82	14.49	16.08	4,370
EPDSE2012-16-PN	●	1.2	16	1.8	1.15	55	4	4	3.53	17.16	17.59	18.38	19.28	21.39	6,960
EPDSE2014-6-PN	●	1.4	6	2.1	1.34	50	4	4	6.06	6.84	7.09	7.31	7.50	8.15	4,490
EPDSE2014-12-PN	●	1.4	12	2.1	1.34	55	4	4	4.08	13.06	13.43	13.84	14.52	16.11	4,490
EPDSE2015-4-PN	●	1.5	4	2.25	1.44	50	4	4	7.11	4.75	4.95	5.13	5.29	5.57	4,370
EPDSE2015-6-PN	●	1.5	6	2.25	1.44	50	4	4	5.94	6.84	7.09	7.31	7.50	8.15	4,370
EPDSE2015-8-PN	●	1.5	8	2.25	1.44	50	4	4	5.10	8.92	9.22	9.46	9.74	10.80	4,370
EPDSE2015-10-PN	●	1.5	10	2.25	1.44	50	4	4	4.47	10.99	11.33	11.59	12.13	13.45	4,370
EPDSE2015-12-PN	●	1.5	12	2.25	1.44	55	4	4	3.97	13.06	13.43	13.84	14.52	16.11	4,370
EPDSE2015-14-PN	●	1.5	14	2.25	1.44	55	4	4	3.58	15.12	15.52	16.12	16.92	18.76	4,490
EPDSE2015-16-PN	●	1.5	16	2.25	1.44	55	4	4	3.25	17.18	17.60	18.40	19.31	21.42	4,490
EPDSE2015-18-PN	●	1.5	18	2.25	1.44	60	4	4	2.98	19.24	19.76	20.69	21.70	干渉なし	4,490
EPDSE2015-20-PN	●	1.5	20	2.25	1.44	60	4	4	2.76	21.29	21.94	22.97	24.10	干渉なし	4,490
EPDSE2015-25-PN	●	1.5	25	2.25	1.44	65	4	4	2.31	26.42	27.39	28.67	30.08	干渉なし	6,720
EPDSE2015-30-PN	●	1.5	30	2.25	1.44	70	4	4	1.99	31.53	32.83	34.37	干渉なし	干渉なし	6,720
EPDSE2015-35-PN	●	1.5	35	2.25	1.44	75	4	4	1.75	36.64	38.28	40.07	干渉なし	干渉なし	7,670
EPDSE2015-40-PN	●	1.5	40	2.25	1.44	80	4	4	1.56	41.85	43.73	45.78	干渉なし	干渉なし	8,610
EPDSE2016-6-PN	●	1.6	6	2.4	1.54	50	4	4	5.82	6.84	7.09	7.31	7.50	8.15	4,490
EPDSE2016-8-PN	●	1.6	8	2.4	1.54	50	4	4	4.98	8.92	9.22	9.46	9.74	10.80	4,490
EPDSE2018-6-PN	●	1.8	6	2.7	1.73	50	4	4	5.55	6.86	7.11	7.32	7.51	8.18	4,490
EPDSE2018-8-PN	●	1.8	8	2.7	1.73	50	4	4	4.72	8.94	9.23	9.47	9.76	10.83	4,490

● : 標準在庫品です。● : Stocked items. 干渉なし : No interference

EPDSE2000-000-000-PN

商品コード Item code	在庫 Stock PN	寸法 Size(mm)						干渉角度 Interference angle θ_K	勾配角に対する実有効首下長 Effective under neck length with respect to draft angle					希望小売 価格(円) Suggested retail price (¥)	
		外径 Tool dia. DC	首下長 Under Neck length LU	刃長 Flute length APMX	首径 Neck dia. DN	全長 Overall length LF	シャンク径 Shank dia. DCONMS		首R Neck R	0.5°	1°	1.5°	2°		3°
		EPDSE2020-4-PN	●	4	3	1.92	50		4	4	6.42	4.80	5.00		5.17
EPDSE2020-6-PN	●	6	3	1.92	50	4	4	5.25	6.88	7.13	7.34	7.52	8.21	4,370	
EPDSE2020-8-PN	●	8	3	1.92	50	4	4	4.44	8.96	9.25	9.49	9.79	10.86	4,370	
EPDSE2020-10-PN	●	10	3	1.92	50	4	4	3.85	11.03	11.35	11.62	12.19	13.52	4,370	
EPDSE2020-12-PN	●	12	3	1.92	55	4	4	3.39	13.10	13.45	13.90	14.58	16.17	4,370	
EPDSE2020-14-PN	●	14	3	1.92	55	4	4	3.03	15.16	15.54	16.18	16.97	18.83	4,370	
EPDSE2020-16-PN	●	16	3	1.92	55	4	4	2.75	17.21	17.63	18.46	19.37	干渉なし	4,370	
EPDSE2020-18-PN	●	18	3	1.92	60	4	4	2.51	19.27	19.81	20.74	21.76	干渉なし	4,370	
EPDSE2020-20-PN	●	20	3	1.92	60	4	4	2.31	21.32	21.99	23.02	24.15	干渉なし	4,370	
EPDSE2020-25-PN	●	25	3	1.92	65	4	4	1.92	26.44	27.44	28.72	30.24	干渉なし	4,370	
EPDSE2020-30-PN	●	30	3	1.92	70	4	4	1.65	31.55	32.88	34.42	干渉なし	干渉なし	5,430	
EPDSE2020-35-PN	●	35	3	1.92	75	4	4	1.44	36.69	38.33	干渉なし	干渉なし	干渉なし	6,490	
EPDSE2020-40-PN	●	40	3	1.92	80	4	4	1.28	41.90	43.78	干渉なし	干渉なし	干渉なし	8,140	
EPDSE2020-50-PN	●	50	3	1.92	90	4	4	1.05	52.33	54.67	干渉なし	干渉なし	干渉なし	9,790	
EPDSE2025-8-PN	●	8	3.75	2.4	50	4	4	3.65	9.00	9.28	9.51	9.85	10.93	4,600	
EPDSE2025-12-PN	●	12	3.75	2.4	55	4	4	2.73	13.13	13.48	13.95	14.64	干渉なし	4,600	
EPDSE2025-16-PN	●	16	3.75	2.4	55	4	4	2.18	17.25	17.68	18.51	19.42	干渉なし	4,600	
EPDSE2025-20-PN	●	20	3.75	2.4	60	4	4	1.81	21.35	22.04	23.07	干渉なし	干渉なし	4,600	
EPDSE2025-30-PN	●	30	3.75	2.4	70	4	4	1.28	31.58	32.94	干渉なし	干渉なし	干渉なし	4,960	
EPDSE2025-40-PN	●	40	3.75	2.4	80	4	4	0.99	41.95	干渉なし	干渉なし	干渉なし	干渉なし	6,960	
EPDSE2025-50-PN	●	50	3.75	2.4	90	4	4	0.80	52.38	干渉なし	干渉なし	干渉なし	干渉なし	8,610	
EPDSE2030-8-PN	●	8	4.5	2.88	55	6	4	5.59	9.04	9.31	9.54	9.91	10.99	5,900	
EPDSE2030-12-PN	●	12	4.5	2.88	60	6	4	4.44	13.16	13.50	14.00	14.69	16.30	5,900	
EPDSE2030-16-PN	●	16	4.5	2.88	60	6	4	3.68	17.28	17.73	18.57	19.48	21.61	5,900	
EPDSE2030-20-PN	●	20	4.5	2.88	65	6	4	3.15	21.38	22.09	23.13	24.26	26.91	5,900	
EPDSE2030-25-PN	●	25	4.5	2.88	70	6	4	2.66	26.49	27.54	28.83	30.25	干渉なし	5,900	
EPDSE2030-30-PN	●	30	4.5	2.88	75	6	4	2.31	31.60	32.99	34.53	36.23	干渉なし	7,080	
EPDSE2030-40-PN	●	40	4.5	2.88	90	6	4	1.82	42.00	43.88	45.94	干渉なし	干渉なし	7,310	
EPDSE2030-50-PN	●	50	4.5	2.88	100	6	4	1.50	52.43	54.78	干渉なし	干渉なし	干渉なし	10,260	
EPDSE2040-12-PN	●	12	6	3.85	60	6	4	3.36	13.21	13.54	14.08	14.78	16.39	6,840	
EPDSE2040-16-PN	●	16	6	3.85	60	6	4	2.72	17.32	17.81	18.65	19.56	干渉なし	6,840	
EPDSE2040-20-PN	●	20	6	3.85	70	6	4	2.29	21.42	22.17	23.21	24.35	干渉なし	6,840	
EPDSE2040-25-PN	●	25	6	3.85	70	6	4	1.91	26.53	27.62	28.91	干渉なし	干渉なし	6,840	
EPDSE2040-30-PN	●	30	6	3.85	80	6	4	1.64	31.65	33.06	34.61	干渉なし	干渉なし	6,840	
EPDSE2040-35-PN	●	35	6	3.85	80	6	4	1.44	36.86	38.51	干渉なし	干渉なし	干渉なし	6,840	
EPDSE2040-40-PN	●	40	6	3.85	90	6	4	1.28	42.08	43.96	干渉なし	干渉なし	干渉なし	8,610	
EPDSE2040-50-PN	●	50	6	3.85	100	6	4	1.05	52.50	54.85	干渉なし	干渉なし	干渉なし	12,750	
EPDSE2050-20-PN	●	20	7.5	4.85	70	6	4	1.27	21.42	22.17	干渉なし	干渉なし	干渉なし	9,020	
EPDSE2050-25-PN	●	25	7.5	4.85	70	6	4	1.04	26.53	27.62	干渉なし	干渉なし	干渉なし	9,020	
EPDSE2050-30-PN	●	30	7.5	4.85	80	6	4	0.88	31.65	干渉なし	干渉なし	干渉なし	干渉なし	9,020	
EPDSE2050-40-PN	●	40	7.5	4.85	90	6	4	0.68	42.08	干渉なし	干渉なし	干渉なし	干渉なし	9,020	
EPDSE2050-50-PN	●	50	7.5	4.85	100	6	4	0.55	52.50	干渉なし	干渉なし	干渉なし	干渉なし	14,260	
EPDSE2060-20-PN	●	20	9	5.85	70	6	-	0	干渉なし	干渉なし	干渉なし	干渉なし	干渉なし	9,270	
EPDSE2060-30-PN	●	30	9	5.85	80	6	-	0	干渉なし	干渉なし	干渉なし	干渉なし	干渉なし	9,510	
EPDSE2060-40-PN	●	40	9	5.85	90	6	-	0	干渉なし	干渉なし	干渉なし	干渉なし	干渉なし	11,220	
EPDSE2060-50-PN	●	50	9	5.85	100	6	-	0	干渉なし	干渉なし	干渉なし	干渉なし	干渉なし	14,260	

○ 対応被削材 Applicable work material

炭素鋼 合金鋼 Carbon steel Alloy steel	プリハー ドン鋼 Pre-hardened steel ≤ 45HRC	高硬度 Hardened steel			ステン レス鋼 Stainless steel	チタン合金 耐熱合金 Titanium alloy Heat-resistant alloy	銅合金 Copper alloy	アルミ 合金 Aluminum alloy
○	○	> 45HRC ≤ 55HRC	> 55HRC ≤ 65HRC	> 65HRC	○	○	○	○

○ 再研磨対応外径範囲 Re-grinding compatibility range

商品コード Item code	外周 Outer dia. (mm)	エンド End (mm)
EPDSE-PN	6	2 ~ 6

[注意] 首下長/外径が10DCを超える工具の再研磨可否については、弊社営業にお問い合わせください。
[Note] Contact our sales office regarding whether or not regrinding is possible for tools where under neck length/tool diameter more than 10DC

標準切削条件表
Recommended cutting conditions

高能率切削条件
High efficiency cutting conditions

高精度切削条件
High accuracy cutting conditions

EPDSE-ATH | **EPDSE-PN**

高精度切削条件はA301ページを参照してください。
Please refer to P.A301 about high accuracy cutting conditions

推奨領域 Recommended range		PNシリーズ PN series													
		ATHシリーズ ATH series													
被削材 Work material			1		2		3		4		5		6		
			銅 Coppers		炭素鋼・合金鋼 Carbon steels, Alloy steels (180~250HB)		ステンレス鋼・工具鋼 Stainless steels, Tool steels (25~35HRC)		プリハードン鋼 Pre-hardened steels (35~45HRC)		焼入れ鋼 Hardened steels (45~55HRC)		焼入れ鋼 Hardened steels (55~65HRC)		
切込み比率 Ratio to standard depth of cut		120%		100%		90%		70%		50%		45%			
外径DC Tool dia. (mm)	首下長LU Under neck length (mm)	ap (mm)	回転数 n min ⁻¹		送り速度 vf mm/min		回転数 n min ⁻¹		送り速度 vf mm/min		回転数 n min ⁻¹		送り速度 vf mm/min		
			0.1	0.3	0.006	50,000	500	50,000	500	50,000	475	48,600	348	42,750	255
	0.5	0.004	50,000	500	50,000	500	50,000	475	48,600	348	42,750	255	40,050	208	
	1	0.003	50,000	455	50,000	455	48,600	430	43,700	315	38,500	232	36,050	187	
0.2	0.5	0.02	50,000	708	45,000	638	40,500	574	38,250	403	33,750	301	31,500	242	
	1	0.014	50,000	708	45,000	638	40,500	574	38,250	403	33,750	301	31,500	242	
	1.5	0.008	48,600	630	40,500	525	36,450	472	34,425	362	30,375	271	28,350	218	
	2	0.005	43,200	504	36,000	420	32,400	378	30,600	286	27,000	214	25,200	172	
	3	0.003	43,200	454	36,000	378	32,400	340	30,600	257	27,000	193	25,200	155	
0.3	1	0.021	48,000	680	40,000	567	36,000	510	34,000	358	30,000	267	28,000	216	
	1.5	0.021	48,000	680	40,000	567	36,000	510	34,000	358	30,000	267	28,000	216	
	2	0.012	43,200	560	36,000	467	32,400	420	30,600	322	27,000	241	25,200	194	
	2.5	0.01	43,200	560	36,000	467	32,400	420	30,600	322	27,000	241	25,200	194	
	3	0.008	43,200	560	36,000	467	32,400	420	30,600	322	27,000	241	25,200	194	
0.4	1	0.04	38,400	847	32,000	706	28,800	635	27,200	446	24,000	333	22,400	268	
	1.5	0.028	38,400	847	32,000	706	28,800	635	27,200	446	24,000	333	22,400	268	
	2	0.028	38,400	847	32,000	706	28,800	635	27,200	446	24,000	333	22,400	268	
	2.5	0.022	34,560	697	28,800	581	25,920	523	24,480	401	21,600	299	20,160	241	
	3	0.016	34,560	697	28,800	581	25,920	523	24,480	401	21,600	299	20,160	241	
	3.5	0.012	34,560	697	28,800	581	25,920	523	24,480	401	21,600	299	20,160	241	
	4	0.01	34,560	697	28,800	581	25,920	523	24,480	401	21,600	299	20,160	241	
	5	0.01	30,720	542	25,600	452	23,040	406	21,760	260	19,200	230	17,920	181	
	6	0.006	30,720	542	25,600	452	23,040	406	21,760	260	19,200	230	17,920	181	
	8	0.003	26,880	413	22,400	344	20,160	310	19,040	200	16,800	172	15,680	131	
0.5	10	0.002	23,040	304	19,200	253	17,280	228	16,320	147	14,400	127	13,440	96	
	1	0.05	38,400	847	32,000	706	28,800	635	27,200	535	24,000	333	22,400	268	
	1.5	0.05	38,400	847	32,000	706	28,800	635	27,200	535	24,000	333	22,400	268	
	2	0.035	38,400	847	32,000	706	28,800	635	27,200	535	24,000	333	22,400	268	
	2.5	0.03	34,560	697	28,800	581	25,920	523	24,480	441	21,600	299	20,160	241	
	3	0.02	34,560	697	28,800	581	25,920	523	24,480	441	21,600	299	20,160	241	
	4	0.02	34,560	697	28,800	581	25,920	523	24,480	401	21,600	299	20,160	241	
	5	0.013	34,560	697	28,800	581	25,920	523	24,480	401	21,600	299	20,160	241	
	6	0.013	30,720	542	25,600	452	23,040	406	21,760	260	19,200	230	17,920	181	
	8	0.008	30,720	464	25,600	387	23,040	348	21,760	247	19,200	194	17,920	147	
0.6	10	0.004	26,880	360	22,400	300	20,160	270	19,040	174	16,800	150	15,680	114	
	2	0.042	38,400	1,210	32,000	1,008	28,800	907	27,200	636	24,000	475	22,400	383	
	3	0.035	34,560	995	28,800	829	25,920	746	24,480	573	21,600	428	20,160	345	
	4	0.024	34,560	995	28,800	829	25,920	746	24,480	573	21,600	428	20,160	345	
	5	0.02	34,560	995	28,800	829	25,920	746	24,480	573	21,600	428	20,160	345	
	6	0.015	34,560	995	28,800	829	25,920	746	24,480	573	21,600	428	20,160	345	
	7	0.015	30,720	859	25,600	716	23,040	644	21,760	494	19,200	369	17,920	298	
	8	0.015	30,720	774	25,600	645	23,040	581	21,760	372	19,200	328	17,920	258	
	9	0.012	30,720	774	25,600	645	23,040	581	21,760	372	19,200	328	17,920	258	
	10	0.009	30,720	774	25,600	645	23,040	581	21,760	372	19,200	328	17,920	258	
0.7	2	0.07	38,400	1,210	32,000	1,008	28,800	907	27,200	636	24,000	475	22,400	384	
	4	0.049	34,560	995	28,800	829	25,920	746	24,480	573	21,600	428	20,160	345	
	6	0.018	34,560	995	28,800	829	25,920	746	24,480	573	21,600	428	20,160	345	
	8	0.018	30,720	774	25,600	645	23,040	581	21,760	372	19,200	328	17,920	258	
	10	0.018	30,720	774	25,600	645	23,040	581	21,760	372	19,200	328	17,920	258	

超硬エポックディープスクエアエボリューション

推奨領域 Recommended range			PNシリーズ PN series											
			ATHシリーズ ATH series											
被削材 Work material			1		2		3		4		5		6	
			銅 Coppers		炭素鋼・合金鋼 Carbon steels, Alloy steels (180~250HB)		ステンレス鋼・工具鋼 Stainless steels, Tool steels (25~35HRC)		プリハードン鋼 Pre-hardened steels (35~45HRC)		焼入れ鋼 Hardened steels (45~55HRC)		焼入れ鋼 Hardened steels (55~65HRC)	
切込み比率 Ratio to standard depth of cut			120%		100%		90%		70%		50%		45%	
外径DC Tool dia. (mm)	首下長LU Under neck length (mm)	ap (mm)	回転数 n min ⁻¹		送り速度 vf mm/min		回転数 n min ⁻¹		送り速度 vf mm/min		回転数 n min ⁻¹		送り速度 vf mm/min	
			0.8	2	0.08	38,400	1,210	32,000	1,008	28,800	907	27,200	780	24,000
	4	0.056	38,400	1,210	32,000	1,008	28,800	907	27,200	780	24,000	688	22,400	422
	6	0.032	34,560	995	28,800	829	25,920	746	24,480	678	24,000	665	20,160	379
	8	0.02	34,560	995	28,800	829	25,920	746	24,480	573	21,600	428	20,160	345
	10	0.02	30,720	774	25,600	645	23,040	581	21,760	372	19,200	328	17,920	258
	12	0.012	30,720	774	25,600	645	23,040	581	21,760	372	19,200	328	17,920	258
0.9	2	0.09	38,400	1,326	32,000	1,205	28,800	1,085	27,200	833	24,000	674	22,400	502
	4	0.063	38,400	1,326	32,000	1,205	28,800	1,085	27,200	833	24,000	674	22,400	502
	6	0.036	34,560	1,094	28,800	994	25,920	895	24,480	687	21,600	556	20,160	414
	8	0.023	34,560	1,094	28,800	911	25,920	820	24,480	630	21,600	513	20,160	379
	10	0.023	30,720	774	25,600	645	23,040	581	21,760	372	19,200	328	17,920	258
	12	0.023	30,720	774	25,600	645	23,040	581	21,760	372	19,200	328	17,920	258
1	2	0.1	34,560	1,628	28,800	1,356	25,920	1,220	24,480	1,150	22,930	1,008	20,160	846
	3	0.085	34,560	1,628	28,800	1,356	25,920	1,220	24,480	1,150	22,930	1,008	20,160	846
	4	0.07	34,560	1,628	28,800	1,356	25,920	1,220	24,480	1,077	22,930	963	20,160	766
	5	0.055	34,560	1,628	28,800	1,356	25,920	1,220	24,480	1,028	22,930	871	20,160	685
	6	0.04	31,104	1,344	25,920	1,120	23,328	1,008	22,032	903	20,700	745	18,144	465
	7	0.04	31,104	1,344	25,920	1,120	23,328	1,008	22,032	837	20,700	703	18,144	465
	8	0.04	31,104	1,344	25,920	1,120	23,328	1,008	22,032	837	20,700	622	18,144	465
	9	0.033	31,104	1,344	25,920	1,120	23,328	1,008	22,032	773	19,440	577	18,144	465
	10	0.025	31,104	1,344	25,920	1,120	23,328	1,008	22,032	773	19,440	577	18,144	465
	12	0.025	27,648	1,045	23,040	871	20,736	784	19,584	502	17,280	443	16,128	348
	14	0.025	27,648	1,045	23,040	871	20,736	784	19,584	502	17,280	443	16,128	348
	16	0.015	27,648	896	23,040	746	20,736	672	19,584	476	17,280	373	16,128	283
	20	0.01	24,828	732	20,690	610	22,345	549	17,587	348	15,518	305	14,483	226
	25	0.005	21,000	569	17,500	474	18,900	427	14,875	270	13,125	237	12,250	175
1.2	4	0.09	30,720	1,452	25,600	1,210	23,040	1,089	21,760	870	19,200	570	17,920	460
	6	0.084	30,720	1,452	25,600	1,210	23,040	1,089	21,760	870	19,200	570	17,920	460
	8	0.048	27,648	1,194	23,040	995	20,736	896	19,584	783	17,280	513	16,128	414
	10	0.03	27,648	1,194	23,040	995	20,736	896	19,584	744	17,280	513	16,128	414
	12	0.03	27,648	1,194	23,040	995	20,736	896	19,584	687	17,280	513	16,128	414
	16	0.02	24,576	1,061	20,480	884	18,432	796	17,408	611	15,360	456	14,336	368
1.4	6	0.1	26,880	1,270	22,400	1,058	20,160	953	19,040	668	16,800	499	15,680	403
	12	0.035	24,192	1,045	20,160	871	18,144	784	17,136	601	15,120	449	14,112	362
1.5	4	0.11	26,880	1,397	22,400	1,163	20,160	1,048	19,040	801	16,800	648	15,680	482
	6	0.11	26,880	1,397	22,400	1,163	20,160	1,048	19,040	801	16,800	623	15,680	482
	8	0.08	24,192	1,149	20,160	958	18,144	940	17,136	721	15,120	538	14,112	416
	10	0.06	24,192	1,149	20,160	871	18,144	862	17,136	721	15,120	538	14,112	416
	12	0.06	24,192	1,045	20,160	871	18,144	784	17,136	721	15,120	449	14,112	362
	14	0.038	24,192	1,045	20,160	871	18,144	784	17,136	721	15,120	449	14,112	362
	16	0.038	21,504	813	17,920	677	16,128	610	15,232	391	13,440	345	12,544	271
	18	0.038	21,504	813	17,920	677	16,128	610	15,232	391	13,440	345	12,544	271
	20	0.038	21,504	813	17,920	677	16,128	610	15,232	391	13,440	345	12,544	271
	25	0.023	16,128	523	13,440	435	12,096	392	11,424	278	10,080	218	9,408	165
	30	0.015	13,440	355	11,200	296	12,096	266	9,520	178	8,400	139	7,840	112
	35	0.01	13,440	355	11,200	296	12,096	266	9,520	178	8,400	139	7,840	112
	40	0.005	10,752	190	8,960	158	8,064	142	7,616	95	6,720	74	6,272	60
1.6	6	0.11	24,960	1,310	20,800	1,201	18,720	1,130	17,680	759	15,600	566	14,560	456
	8	0.11	24,960	1,310	20,800	1,201	18,720	983	17,680	690	15,600	566	14,560	456
1.8	6	0.13	24,960	1,310	20,800	1,201	18,720	1,179	17,680	759	15,600	618	14,560	498
	8	0.13	24,960	1,310	20,800	1,201	18,720	1,081	17,680	690	15,600	618	14,560	498

[注意] ご使用にあたっては、A300ページの表下の項目と注意を参照してください。 **[Note]** Upon usage, please refer to comments and notes below table on page A300.

EPDSE-ATH **EPDSE-PN**

高能率切削条件
High efficiency cutting condition

高精度切削条件
High accuracy cutting condition

高精度切削条件はA301ページを参照してください。
Please refer to P.A301 about high accuracy cutting conditions

推奨領域 Recommended range			PNシリーズ PN series											
			ATHシリーズ ATH series											
被削材 Work material			1	2	3	4	5	6						
			銅 Coppers	炭素鋼・合金鋼 Carbon steels, Alloy steels (180~250HB)	ステンレス鋼・工具鋼 Stainless steels, Tool steels (25~35HRC)	プリハードン鋼 Pre-hardened steels (35~45HRC)	焼入れ鋼 Hardened steels (45~55HRC)	焼入れ鋼 Hardened steels (55~65HRC)						
切込み比率 Ratio to standard depth of cut			120%	100%	90%	70%	50%	45%						
外径DC Tool dia. (mm)	首下長LU Under neck length (mm)	ap (mm)	回転数 n min ⁻¹	送り速度 vf mm/min	回転数 n min ⁻¹	送り速度 vf mm/min	回転数 n min ⁻¹	送り速度 vf mm/min	回転数 n min ⁻¹	送り速度 vf mm/min	回転数 n min ⁻¹	送り速度 vf mm/min	回転数 n min ⁻¹	送り速度 vf mm/min
2	4	0.2	20,160	1,397	16,800	1,174	15,120	1,048	14,280	734	12,600	548	11,760	443
	6	0.2	20,160	1,397	16,800	1,174	15,120	1,048	14,280	734	12,600	548	11,760	443
	8	0.14	20,160	1,397	16,800	1,174	15,120	1,048	14,280	734	12,600	548	11,760	443
	10	0.14	20,160	1,397	16,800	1,174	15,120	1,048	14,280	734	12,600	548	11,760	443
	12	0.1	18,144	1,149	15,120	958	13,608	862	12,852	661	11,340	493	10,584	398
	14	0.08	18,144	1,149	15,120	958	13,608	862	12,852	661	11,340	493	10,584	362
	16	0.08	18,144	1,045	15,120	914	13,608	862	12,852	601	11,340	449	10,584	362
	18	0.05	18,144	1,045	15,120	914	13,608	862	12,852	601	11,340	449	10,584	362
	20	0.05	18,144	1,045	15,120	871	13,608	784	12,852	601	11,340	449	10,584	362
	25	0.05	16,128	813	13,440	677	12,096	610	11,424	391	10,080	345	9,408	271
	30	0.03	16,128	813	13,440	677	12,096	610	11,424	391	10,080	345	9,408	271
	35	0.02	14,112	583	11,760	486	10,584	437	9,996	282	8,820	228	8,232	185
40	0.01	14,112	583	11,760	486	10,584	437	9,996	282	8,820	228	8,232	185	
50	0.005	12,096	355	10,080	296	9,072	266	8,568	172	7,560	139	7,056	112	
2.5	8	0.18	17,280	1,497	14,400	1,247	12,960	1,123	12,240	787	10,800	642	10,080	474
	12	0.18	17,280	1,260	14,400	1,247	12,960	1,123	12,240	716	10,800	588	10,080	431
	16	0.1	15,552	1,120	12,960	1,073	11,664	966	11,016	644	9,720	529	9,072	388
	20	0.1	15,552	1,120	12,960	933	11,664	840	11,016	644	9,720	529	9,072	388
	30	0.06	13,824	870	11,520	725	10,368	653	9,792	435	8,640	341	8,064	276
	40	0.03	12,096	625	10,080	521	9,072	469	8,568	313	7,560	245	7,056	198
50	0.01	12,096	625	10,080	521	9,072	469	8,568	313	7,560	245	7,056	198	
3	8	0.3	15,360	1,331	12,800	1,108	11,520	997	10,880	699	10,600	570	8,960	422
	12	0.21	15,360	1,331	12,800	1,108	11,520	997	10,880	699	10,600	570	8,960	422
	16	0.15	13,824	1,144	11,520	994	10,368	820	9,792	630	9,450	513	8,064	379
	20	0.12	13,824	995	11,520	911	10,368	820	9,792	630	9,450	513	8,064	379
	25	0.08	13,824	995	11,520	911	10,368	820	9,792	630	9,450	513	8,064	379
	30	0.08	13,824	995	11,520	829	10,368	746	9,792	630	9,450	513	8,064	347
	40	0.05	12,288	884	10,240	737	9,216	663	8,704	509	7,680	380	7,168	307
	50	0.02	10,752	556	8,960	463	8,064	417	7,616	278	6,720	218	6,272	176
4	12	0.4	11,500	2,300	9,400	1,880	8,460	1,524	7,990	1,358	7,050	902	6,580	728
	16	0.28	11,500	2,300	9,400	1,880	8,460	1,524	7,990	1,358	7,050	902	6,580	728
	20	0.28	10,350	2,070	8,460	1,692	7,614	1,371	7,191	1,222	6,345	812	5,922	655
	25	0.16	10,350	1,863	8,460	1,524	7,614	1,233	7,191	1,100	6,345	812	5,922	655
	30	0.16	10,350	1,863	8,460	1,524	7,614	1,233	7,191	1,100	6,345	812	5,922	655
	35	0.1	9,137	1,645	7,614	1,371	6,853	1,110	6,472	990	5,711	731	5,330	589
	40	0.1	9,137	1,645	7,614	1,371	6,853	1,110	6,472	990	5,711	731	5,330	589
	50	0.06	7,896	1,128	6,580	940	5,922	846	5,593	658	4,935	442	4,606	357
5	20	0.3	9,014	1,802	7,512	1,652	6,761	1,487	6,385	1,051	5,634	706	5,258	571
	25	0.3	8,112	1,621	6,760	1,351	6,084	1,216	5,746	946	5,070	635	4,732	513
	30	0.2	8,112	1,461	6,760	1,217	6,084	1,094	5,746	851	5,070	573	4,732	462
	40	0.15	7,301	1,315	6,084	1,096	5,476	986	5,171	767	4,563	515	4,259	416
	50	0.1	7,301	1,315	6,084	1,096	5,476	986	5,171	767	4,563	515	4,259	416
6	20	0.5	7,418	1,629	6,182	1,481	5,564	1,333	5,255	1,036	4,637	766	4,327	562
	30	0.4	6,744	1,480	5,620	1,346	5,058	1,212	4,777	942	4,215	696	3,934	511
	40	0.3	6,744	1,332	5,620	1,109	5,058	998	4,777	847	4,215	625	3,934	459
	50	0.2	6,000	1,090	5,000	986	4,500	887	4,250	690	3,750	515	3,500	379

*apは被削材グループ2での目安を示しています。その他のグループの場合は、上表の切込み比率を目安に調整してください。

*ap is shown as the criteria for Group 2 workpieces. For other groups, adjust the cutting depth according to the cutting depth factors in the above table.

- 【注意】**
- ① PNコーティングはその性質上、通電性が微小です。従って、通電方式の工具長測定装置をご使用の際にはご注意ください。
 - ② 被削材、加工形状に合わせて、適切なクーラントを使用してください。
 - ③ この標準切削条件は目安を示すものです。実際の加工では加工形状、目的、使用機械等により条件を調整してください。
 - ④ 機械の回転数が足りない場合は、回転数と送り速度を同じ比率で下げてください。

- 【Note】**
- ① PN coating is less electro conductive. Therefore, electric transmitted measuring systems may not work.
 - ② Use the appropriate coolant for the work material and machining shape.
 - ③ These Recommended Cutting Conditions indicate only the rule of a thumb for the cutting conditions. In actual machining, the condition should be adjusted according to the machining shape, purpose and the machine type.
 - ④ If the rpm of the machine is low, lower the feed rate also to put the rpm and feed rate in the same ratio.



標準切削条件表

Recommended cutting conditions

高能率切削条件
High efficiency cutting condition

高精度切削条件
High accuracy cutting condition

EPDSE-ATH EPDSE-PN

高能率切削条件はA298ページを参照してください。
Please refer to P.A298 about high efficiency cutting conditions

推奨領域 Recommended range			PNシリーズ PN series											
			ATHシリーズ ATH series											
被削材 Work material			1		2		3		4		5		6	
			銅 Coppers		炭素鋼・合金鋼 Carbon steels, Alloy steels (180~250HB)		ステンレス鋼・工具鋼 Stainless steels, Tool steels (25~35HRC)		プリハードン鋼 Pre-hardened steels (35~45HRC)		焼入れ鋼 Hardened steels (45~55HRC)		焼入れ鋼 Hardened steels (55~65HRC)	
切込み比率 Ratio to standard depth of cut			120%		100%		90%		70%		50%		45%	
外径DC Tool dia. (mm)	首下長LU Under neck length (mm)	a_p (mm)	回転数	送り速度	回転数	送り速度	回転数	送り速度	回転数	送り速度	回転数	送り速度	回転数	送り速度
			n min ⁻¹	v_f mm/min	n min ⁻¹	v_f mm/min	n min ⁻¹	v_f mm/min	n min ⁻¹	v_f mm/min	n min ⁻¹	v_f mm/min	n min ⁻¹	v_f mm/min
0.1	0.3	0.006	50,000	350	50,000	350	50,000	332	48,600	242	42,750	178	40,050	144
	0.5	0.004	50,000	350	50,000	350	50,000	332	48,600	242	42,750	178	40,050	144
	1	0.003	50,000	318	50,000	318	48,600	301	43,700	220	38,500	162	36,050	129
0.2	0.5	0.015	50,000	495	45,000	446	40,500	401	38,250	282	33,750	210	31,500	169
	1	0.011	50,000	495	45,000	446	40,500	401	38,250	282	33,750	210	31,500	169
	1.5	0.006	48,600	441	40,500	367	36,450	330	34,425	253	30,375	189	28,350	152
	2	0.004	43,200	352	36,000	294	32,400	264	30,600	200	27,000	165	25,200	147
0.3	0.5	0.002	43,200	317	36,000	264	32,400	238	30,600	179	27,000	165	25,200	133
	1	0.021	48,000	544	40,000	453	36,000	408	34,000	286	30,000	240	28,000	193
	1.5	0.021	48,000	544	40,000	453	36,000	408	34,000	286	30,000	240	28,000	193
	2	0.012	43,200	448	36,000	373	32,400	336	30,600	257	27,000	192	25,200	155
0.4	0.5	0.008	43,200	448	36,000	373	32,400	336	30,600	257	27,000	192	25,200	155
	1	0.04	38,400	762	32,000	635	28,800	571	27,200	401	24,000	297	22,400	241
	1.5	0.028	38,400	762	32,000	635	28,800	571	27,200	401	24,000	297	22,400	241
	2	0.028	38,400	762	32,000	635	28,800	571	27,200	401	24,000	297	22,400	241
0.5	2.5	0.022	34,560	557	28,800	464	25,920	418	24,480	320	21,600	239	20,160	192
	3	0.016	34,560	557	28,800	464	25,920	418	24,480	320	21,600	239	20,160	192
	3.5	0.012	34,560	557	28,800	464	25,920	418	24,480	320	21,600	239	20,160	192
	4	0.01	34,560	557	28,800	464	25,920	418	24,480	320	21,600	239	20,160	192
	5	0.01	30,720	406	25,600	316	23,040	284	21,760	208	19,200	184	17,920	144
	6	0.006	30,720	406	25,600	316	23,040	284	21,760	208	19,200	184	17,920	144
	8	0.003	26,880	289	22,400	240	20,160	217	19,040	160	16,800	141	15,680	128
0.6	10	0.002	23,040	212	19,200	177	17,280	159	16,320	117	14,400	103	13,440	94
	1	0.05	38,400	762	32,000	635	28,800	571	27,200	446	24,000	299	22,400	241
	1.5	0.05	38,400	762	32,000	635	28,800	571	27,200	446	24,000	299	22,400	241
	2	0.035	38,400	762	32,000	635	28,800	571	27,200	446	24,000	299	22,400	241
	2.5	0.03	34,560	557	28,800	464	25,920	418	24,480	354	21,600	239	20,160	192
	3	0.02	34,560	557	28,800	464	25,920	418	24,480	354	21,600	239	20,160	192
	4	0.02	34,560	557	28,800	464	25,920	418	24,480	320	21,600	239	20,160	192
	5	0.013	34,560	557	28,800	464	25,920	418	24,480	320	21,600	239	20,160	192
	6	0.013	30,720	433	25,600	361	23,040	324	21,760	208	19,200	184	17,920	144
	8	0.008	30,720	371	25,600	309	23,040	278	21,760	172	19,200	155	17,920	117
0.7	10	0.004	26,880	288	22,400	240	20,160	216	19,040	121	16,800	105	15,680	79
	2	0.042	38,400	1,089	32,000	907	28,800	816	27,200	572	24,000	427	22,400	344
	3	0.035	34,560	895	28,800	746	25,920	671	24,480	515	21,600	385	20,160	310
	4	0.024	34,560	895	28,800	746	25,920	671	24,480	515	21,600	385	20,160	310
	5	0.02	34,560	796	28,800	663	25,920	596	24,480	458	21,600	342	20,160	276
	6	0.015	34,560	796	28,800	663	25,920	596	24,480	458	21,600	342	20,160	276
	7	0.015	30,720	687	25,600	572	23,040	515	21,760	395	19,200	295	17,920	238
	8	0.015	30,720	595	25,600	516	23,040	464	21,760	297	19,200	262	17,920	206
	9	0.012	30,720	595	25,600	516	23,040	464	21,760	297	19,200	262	17,920	206
	10	0.009	30,720	595	25,600	516	23,040	464	21,760	297	19,200	262	17,920	206
0.8	2	0.07	38,400	1,089	32,000	907	28,800	816	27,200	572	24,000	427	22,400	344
	4	0.049	34,560	796	28,800	663	25,920	596	24,480	458	21,600	342	20,160	276
	6	0.018	34,560	796	28,800	663	25,920	596	24,480	458	21,600	342	20,160	276
	8	0.018	30,720	541	25,600	451	23,040	406	21,760	260	19,200	229	17,920	180
0.9	10	0.018	30,720	541	25,600	451	23,040	406	21,760	260	19,200	229	17,920	180

[注意] ご使用にあたっては、A303ページの表下の項目と注意を参照してください。

[Note] Upon usage, please refer to comments and notes below table on page A303.

EPDSE-ATH EPDSE-PN

高能率切削条件
High efficiency cutting condition

高精度切削条件
High accuracy cutting condition

高能率切削条件はA298ページを参照してください。
Please refer to P.A298 about high efficiency cutting conditions

推奨領域 Recommended range			PNシリーズ PN series											
			ATHシリーズ ATH series						PNシリーズ PN series					
被削材 Work material			1		2		3		4		5		6	
			銅 Coppers		炭素鋼・合金鋼 Carbon steels, Alloy steels (180~250HB)		ステンレス鋼・工具鋼 Stainless steels, Tool steels (25~35HRC)		プリハードン鋼 Pre-hardened steels (35~45HRC)		焼入れ鋼 Hardened steels (45~55HRC)		焼入れ鋼 Hardened steels (55~65HRC)	
切込み比率 Ratio to standard depth of cut			120%		100%		90%		70%		50%		45%	
外径DC Tool dia. (mm)	首下長LU Under neck length (mm)	ap (mm)	回転数 n min ⁻¹		送り速度 vf mm/min		回転数 n min ⁻¹		送り速度 vf mm/min		回転数 n min ⁻¹		送り速度 vf mm/min	
						120%		100%		90%		70%		50%
0.8	2	0.08	38,400	1,089	32,000	907	28,800	816	27,200	636	24,000	475	22,400	383
	4	0.056	38,400	1,089	32,000	907	28,800	816	27,200	636	24,000	475	22,400	383
	6	0.032	34,560	796	28,800	663	25,920	596	24,480	573	21,600	428	20,160	345
	8	0.02	34,560	796	28,800	663	25,920	596	24,480	458	21,600	342	20,160	276
	10	0.02	30,720	541	25,600	451	23,040	406	21,760	260	19,200	229	17,920	180
0.9	2	0.09	38,400	1,206	32,000	1,005	28,800	904	27,200	695	24,000	519	22,400	418
	4	0.063	38,400	1,206	32,000	1,005	28,800	904	27,200	695	24,000	519	22,400	418
	6	0.036	34,560	995	28,800	829	25,920	746	24,480	573	21,600	428	20,160	345
	8	0.023	34,560	995	28,800	829	25,920	746	24,480	573	21,600	428	20,160	345
	10	0.023	30,720	619	25,600	516	23,040	464	21,760	297	19,200	262	17,920	206
1	2	0.09	34,560	1,465	28,800	1,220	25,920	1,098	24,480	936	21,600	699	20,160	563
	3	0.07	34,560	1,465	28,800	1,220	25,920	1,098	24,480	936	21,600	699	20,160	563
	4	0.065	34,560	1,465	28,800	1,220	25,920	1,098	24,480	936	21,600	699	20,160	563
	5	0.05	34,560	1,465	28,800	1,220	25,920	1,098	24,480	936	21,600	699	20,160	563
	6	0.035	31,104	1,276	25,920	1,008	23,328	907	22,032	773	19,440	577	18,144	418
	7	0.035	31,104	1,276	25,920	1,008	23,328	907	22,032	773	19,440	577	18,144	418
	8	0.035	31,104	1,209	25,920	1,008	23,328	907	22,032	773	19,440	577	18,144	418
	9	0.03	31,104	1,209	25,920	1,008	23,328	907	22,032	695	19,440	461	18,144	372
	10	0.022	31,104	1,209	25,920	896	23,328	816	22,032	695	19,440	461	18,144	372
	12	0.022	27,648	836	23,040	696	20,736	627	19,584	401	17,280	354	16,128	278
	14	0.022	27,648	836	23,040	696	20,736	627	19,584	401	17,280	354	16,128	278
	16	0.012	27,648	716	23,040	596	20,736	537	19,584	380	17,280	298	16,128	226
	20	0.008	24,828	586	20,690	488	18,621	439	17,587	278	15,518	213	14,483	158
25	0.005	21,000	455	17,500	379	15,750	341	14,875	216	13,125	165	12,250	122	
1.2	4	0.09	30,720	1,306	25,600	1,089	23,040	980	21,760	760	19,200	513	17,920	414
	6	0.084	30,720	1,306	25,600	1,089	23,040	980	21,760	760	19,200	513	17,920	414
	8	0.048	27,648	1,074	23,040	895	20,736	806	19,584	684	17,280	461	16,128	372
	10	0.03	27,648	1,074	23,040	895	20,736	806	19,584	684	17,280	461	16,128	372
	12	0.03	27,648	955	23,040	716	20,736	642	19,584	549	17,280	410	16,128	331
1.4	6	0.1	26,880	1,143	22,400	952	20,160	857	19,040	601	16,800	449	15,680	361
	12	0.035	24,192	940	20,160	783	18,144	705	17,136	540	15,120	404	14,112	325
1.5	4	0.11	26,880	1,270	22,400	1,058	20,160	953	19,040	668	16,800	499	15,680	402
	6	0.11	26,880	1,143	22,400	952	20,160	866	19,040	668	16,800	499	15,680	402
	8	0.06	24,192	1,045	20,160	871	18,144	784	17,136	601	15,120	449	14,112	362
	10	0.06	24,192	1,045	20,160	783	18,144	705	17,136	601	15,120	449	14,112	362
	12	0.06	24,192	940	20,160	783	18,144	705	17,136	601	15,120	404	14,112	325
	14	0.038	24,192	940	20,160	783	18,144	705	17,136	601	15,120	404	14,112	325
	16	0.038	21,504	731	17,920	609	16,128	549	15,232	351	13,440	310	12,544	243
	18	0.038	21,504	731	17,920	609	16,128	549	15,232	351	13,440	310	12,544	243
	20	0.038	21,504	731	17,920	609	16,128	488	15,232	312	13,440	276	12,544	216
	25	0.023	16,128	470	13,440	391	12,096	313	11,424	222	10,080	174	9,408	132
	30	0.015	13,440	319	11,200	266	12,096	212	9,520	149	8,400	111	7,840	89
	35	0.01	13,440	284	11,200	236	12,096	186	9,520	149	8,400	111	7,840	89
40	0.005	10,752	152	8,960	126	8,064	113	7,616	76	6,720	59	6,272	48	
1.6	6	0.11	24,960	1,179	20,800	977	18,720	884	17,680	690	15,600	515	14,560	415
	8	0.11	24,960	1,179	20,800	977	18,720	884	17,680	621	15,600	515	14,560	415
1.8	6	0.13	24,960	1,179	20,800	997	18,720	884	17,680	690	15,600	515	14,560	415
	8	0.13	24,960	1,179	20,800	997	18,720	884	17,680	621	15,600	515	14,560	415

超硬エポックディープスクエアエボリューション

推奨領域 Recommended range			PNシリーズ PN series											
			ATHシリーズ ATH series											
被削材 Work material			1		2		3		4		5		6	
			銅 Coppers		炭素鋼・合金鋼 Carbon steels, Alloy steels (180~250HB)		ステンレス鋼・工具鋼 Stainless steels, Tool steels (25~35HRC)		プリハードン鋼 Pre-hardened steels (35~45HRC)		焼入れ鋼 Hardened steels (45~55HRC)		焼入れ鋼 Hardened steels (55~65HRC)	
切込み比率 Ratio to standard depth of cut			120%		100%		90%		70%		50%		45%	
外径DC Tool dia. (mm)	首下長LU Under neck length (mm)	ap (mm)	回転数 n min ⁻¹		送り速度 vf mm/min		回転数 n min ⁻¹		送り速度 vf mm/min		回転数 n min ⁻¹		送り速度 vf mm/min	
			2	4	0.2	20,160	1,270	16,800	952	15,120	861	14,280	655	12,600
6	0.2	20,160		1,270	16,800	952	15,120	861	14,280	655	12,600	499	11,760	402
8	0.14	20,160		1,270	16,800	952	15,120	861	14,280	655	12,600	499	11,760	402
10	0.14	20,160		1,270	16,800	952	15,120	861	14,280	655	12,600	499	11,760	402
12	0.08	18,144		1,045	15,120	871	13,608	784	12,852	590	11,340	449	10,584	362
14	0.08	18,144		1,045	15,120	871	13,608	784	12,852	590	11,340	449	10,584	325
16	0.08	18,144		940	15,120	783	13,608	707	12,852	540	11,340	426	10,584	325
18	0.05	18,144		940	15,120	783	13,608	707	12,852	540	11,340	404	10,584	289
20	0.05	18,144		888	15,120	696	13,608	627	12,852	480	11,340	359	10,584	289
25	0.05	16,128		731	13,440	609	12,096	549	11,424	312	10,080	310	9,408	232
30	0.03	16,128		650	13,440	541	12,096	488	11,424	273	10,080	276	9,408	216
35	0.02	14,112		466	11,760	388	10,584	349	9,996	225	8,820	182	8,232	148
40	0.01	14,112	408	11,760	340	10,584	306	9,996	197	8,820	159	8,232	129	
50	0.005	12,096	284	10,080	236	9,072	186	8,568	120	7,560	97	7,056	78	
2.5	8	0.18	17,280	1,361	14,400	1,134	12,960	1,021	12,240	716	10,800	535	10,080	431
	12	0.18	17,280	1,134	14,400	1,020	12,960	933	12,240	644	10,800	520	10,080	387
	16	0.1	15,552	1,008	12,960	839	11,664	758	11,016	579	9,720	450	9,072	349
	20	0.1	15,552	840	12,960	794	11,664	711	11,016	515	9,720	450	9,072	310
	30	0.06	13,824	696	11,520	580	10,368	457	9,792	348	8,640	272	8,064	220
	40	0.03	12,096	437	10,080	364	9,072	328	8,568	250	7,560	196	7,056	158
3	8	0.3	15,360	1,210	12,800	1,008	11,520	907	10,880	636	9,600	475	8,960	383
	12	0.21	15,360	1,210	12,800	1,008	11,520	907	10,880	636	9,600	475	8,960	383
	16	0.12	13,824	995	11,520	829	10,368	746	9,792	573	8,640	428	8,064	344
	20	0.12	13,824	895	11,520	787	10,368	705	9,792	573	8,640	428	8,064	344
	25	0.08	13,824	895	11,520	787	10,368	705	9,792	573	8,640	428	8,064	344
	30	0.08	13,824	796	11,520	663	10,368	601	9,792	573	8,640	428	8,064	310
	40	0.05	12,288	618	10,240	515	9,216	464	8,704	356	7,680	304	7,168	245
4	12	0.4	11,500	2,070	9,400	1,692	8,460	1,370	7,990	1,222	7,050	811	6,580	654
	16	0.28	11,500	2,070	9,400	1,692	8,460	1,370	7,990	1,222	7,050	811	6,580	654
	20	0.28	10,350	1,863	8,460	1,522	7,614	1,233	7,191	1,099	6,345	730	5,922	588
	25	0.16	10,350	1,676	8,460	1,370	7,614	1,109	7,191	990	6,345	730	5,922	588
	30	0.16	10,350	1,676	8,460	1,370	7,614	1,109	7,191	880	6,345	649	5,922	588
	35	0.1	9,137	1,316	7,614	1,096	6,853	888	6,472	792	5,711	584	5,330	471
	40	0.1	9,137	1,151	7,614	959	6,853	777	6,472	693	5,711	511	5,330	412
5	20	0.3	9,014	1,621	7,512	1,351	6,761	1,216	6,385	945	5,634	635	5,258	513
	25	0.3	8,112	1,458	6,760	1,215	6,084	1,094	5,746	850	5,070	571	4,732	461
	30	0.2	8,112	1,313	6,760	1,094	6,084	984	5,746	765	5,070	514	4,732	415
	40	0.15	7,301	1,052	6,084	876	5,476	788	5,171	613	4,563	412	4,259	332
	50	0.1	7,301	986	6,084	876	5,476	690	5,171	575	4,563	360	4,259	291
6	20	0.5	7,418	1,481	6,182	1,234	5,564	1,111	5,255	864	4,637	580	4,327	469
	30	0.4	6,744	1,346	5,620	1,122	5,058	1,010	4,777	785	4,215	527	3,934	426
	40	0.3	6,744	1,211	5,620	1,009	5,058	908	4,777	706	4,215	474	3,934	383
	50	0.2	6,000	981	5,000	817	4,500	735	4,250	636	3,750	427	3,500	345

※apは被削材グループ2での目安を示しています。その他のグループの場合は、上表の切込み比率を目安に調整してください。

※ap is shown as the criteria for Group 2 workpieces. For other groups, adjust the cutting depth according to the cutting depth factors in the above table.

- 【注意】**
- ①PNコーティングはその性質上、通電性が微小です。従って、通電方式の工具長測定装置をご使用の際にはご注意ください。
 - ②被削材、加工形状に合わせて、適切なクーラントを使用してください。
 - ③この標準切削条件表は切削条件の目安を示すものです。実際の加工では加工形状、目的、使用機械等により条件を調整してください。
 - ④機械の回転数が足りない場合は、回転数と送り速度を同じ比率で下げてください。

- 【Note】**
- ① PN coating is less electro conductive. Therefore, electric transmitted measuring systems may not work.
 - ② Use the appropriate coolant for the work material and machining shape.
 - ③ These Recommended Cutting Conditions indicate only the rule of a thumb for the cutting conditions. In actual machining, the condition should be adjusted according to the machining shape, purpose and the machine type.
 - ④ If the rpm of the machine is low, lower the feed rate also to put the rpm and feed rate in the same ratio.

エポックパナシアスクエア

驚異の耐密着性と耐摩耗性のPNコーティング。幅広い被削材の加工が可能。

PN Coating for amazing seizure resistance and wear resistance. Enables machining of a wide variety of materials.

2枚刃

2 flutes



外径公差
 $\phi 0.2 \sim \phi 0.9 : 0 \sim -0.015$
 $\phi 1.0 \sim \phi 20 : 0 \sim -0.02$



(mm)

2枚刃
2Flutes

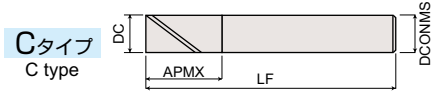
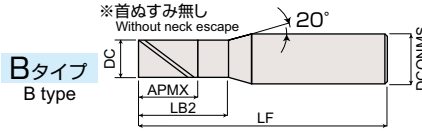
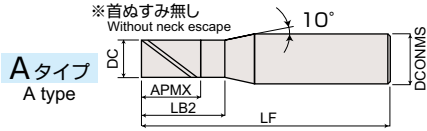

HGOS2○○○-PN



商品コード Item code	在庫 Stock	寸法 Size (mm)					シャンク径 Shank dia. DCONMS	刃数 No. of flutes	タイプ Type	希望小売価格(円) Suggested retail price(¥)
		外径 Tool dia. DC	刃長 Flute length APMX	首下長 Under neck length LB2	全長 Overall length LF					
HGOS2002-PN	●	0.2	0.4	0.6	40	4	2	A	9,180	
HGOS2003-PN	●	0.3	0.6	0.9	40	4	2	A	8,490	
HGOS2004-PN	●	0.4	0.8	1.1	40	4	2	A	8,490	
HGOS2005-PN	●	0.5	1	1.3	40	4	2	A	8,160	
HGOS2006-PN	●	0.6	1.2	1.5	40	4	2	A	8,160	
HGOS2007-PN	●	0.7	1.4	1.7	40	4	2	A	8,000	
HGOS2008-PN	●	0.8	1.6	1.9	40	4	2	A	8,000	
HGOS2009-PN	●	0.9	1.8	2.1	40	4	2	A	7,670	
HGOS2010-PN	●	1	2	2.5	40	4	2	A	6,720	
HGOS2015-PN	●	1.5	3	3.5	40	4	2	A	6,720	
HGOS2020-PN	●	2	6	7	40	4	2	A	6,720	
HGOS2025-PN	●	2.5	8	9	40	4	2	A	6,720	
HGOS2030-PN	●	3	8	9	45	6	2	A	7,940	
HGOS2035-PN	●	3.5	10	11	45	6	2	A	8,280	
HGOS2040-PN	●	4	11	12	45	6	2	B	8,280	
HGOS2045-PN	●	4.5	11	12	45	6	2	B	9,390	
HGOS2050-PN	●	5	13	14	60	6	2	B	9,390	
HGOS2055-PN	●	5.5	13	14	60	6	2	B	10,070	
HGOS2060-PN	●	6	13	-	60	6	2	C	9,720	
HGOS2070-PN	●	7	16	17	70	8	2	B	11,570	
HGOS2080-PN	●	8	19	-	75	8	2	C	12,580	
HGOS2090-PN	●	9	19	20	80	10	2	B	15,150	
HGOS2100-PN	●	10	22	-	80	10	2	C	15,600	
HGOS2120-PN	●	12	26	-	100	12	2	C	21,100	
HGOS2160-PN	●	16	35	-	110	16	2	C	42,820	
HGOS2200-PN	●	20	40	-	125	20	2	C	72,730	

●：標準在庫品です。●：Stocked items.

超硬エポックパナシアスクエア

4枚刃 4 flutes

平面 Planing
 側面 Side Cutting
 彫込み Die-sinking
 ヘルカル Helical
 座ぐり Spot Facing
 中仕上げ Semi Finishing
 仕上げ Finishing

外径公差 Dia. tolerance 0~-0.02
 h5

(mm)

4枚刃
4Flutes

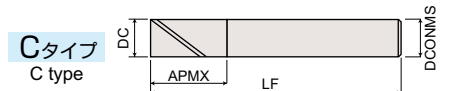
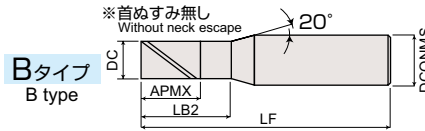
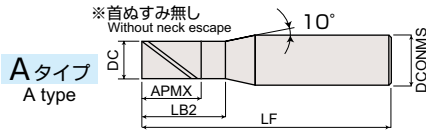

HGOS4--PN

超硬 Carbide
 PN
 ねじり30° Helix angle
 切削条件表 A306 Cutting Conditions

商品コード Item code	在庫 Stock	寸法 Size (mm)					刃数 No. of flutes	タイプ Type	希望小売価格 (円) Suggested retail price (¥)
		外径 Tool dia.	刃長 Flute length	首下長 Under neck length	全長 Overall length	シャンク径 Shank dia.			
		DC	APMX	LB2	LF	DCONMS			
HGOS4010-PN	●	1	2.5	3	40	4	4	8,930	
HGOS4015-PN	●	1.5	4	4.5	40	4	4	8,930	
HGOS4020-PN	●	2	6	7	40	4	4	8,930	
HGOS4025-PN	●	2.5	8	9	40	4	4	9,100	
HGOS4030-PN	●	3	10	11	45	6	4	9,100	
HGOS4040-PN	●	4	12	13	45	6	4	9,450	
HGOS4050-PN	●	5	15	16	60	6	4	10,550	
HGOS4060-PN	●	6	15	-	60	6	4	11,460	
HGOS4080-PN	●	8	20	-	75	8	4	14,260	
HGOS4100-PN	●	10	25	-	80	10	4	18,970	
HGOS4120-PN	●	12	30	-	100	12	4	23,910	
HGOS4160-PN	●	16	35	-	110	16	4	54,910	
HGOS4200-PN	●	20	40	-	125	20	4	80,240	

○ HGOS2-PN、HGOS4-PNの対応被削材

Applicable work material of HGOS2-PN, HGOS4-PN

炭素鋼 合金鋼 Carbon steel Alloy steel	プリハー ド鋼 Pre-hardened steel	高硬度 Hardened steel			ステン レス鋼 Stainless steel	チタン合金 耐熱合金 Titanium alloy Heat-resistant alloy	銅合金 Copper alloy	アルミ 合金 Aluminum alloy
		> 45HRC ≤ 55HRC	> 55HRC ≤ 65HRC	> 65HRC				
○	○	○	○	○	○	○	○	

●：標準在庫品です。●：Stocked items. 干渉なし：No interference

○ 再研磨対応外径範囲

Re-grinding compatibility range

商品コード Item code	外周 Outer dia. (mm)	エンド End (mm)
HGOS2-PN	6 ~ 20	2 ~ 20
HGOS4-PN	6 ~ 20	2 ~ 20

Epoch Panacea Square エポックパナシアスクエア

標準切削条件表 Recommended cutting conditions

HGOS2-PN HGOS4-PN

側面切削 Side cutting

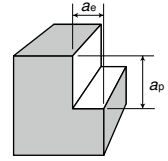

外径 DC Tool dia. (mm)	刃長 APMX Flute length (mm)	銅合金・アルミ合金 Copper alloys, Aluminum alloys				鋳鉄・炭素鋼 Cast irons, Carbon steels (150~200HB) FC250,S50C,S55C				ステンレス鋼 Stainless steels (25~35HRC) SUS304,SUS316			
		回転数 min ⁻¹	送り速度 mm/min	ap mm	ae mm	回転数 min ⁻¹	送り速度 mm/min	ap mm	ae mm	回転数 min ⁻¹	送り速度 mm/min	ap mm	ae mm
0.2	0.4	66,879	669	0.300	0.010	55,732	557	0.300	0.010	33,439	301	0.300	0.008
0.3	0.6	44,586	446	0.450	0.015	37,155	372	0.450	0.015	22,293	201	0.450	0.012
0.4	0.8	38,217	382	0.600	0.020	27,866	279	0.600	0.020	16,720	150	0.600	0.016
0.5	1	38,217	382	0.750	0.025	25,478	255	0.750	0.025	15,287	138	0.750	0.020
0.6	1.2	41,401	662	0.900	0.030	26,539	425	0.900	0.030	15,924	229	0.900	0.024
0.7	1.4	35,487	568	1.050	0.035	29,572	473	1.050	0.035	17,743	256	1.050	0.028
0.8	1.6	33,439	535	1.200	0.040	25,876	414	1.200	0.040	15,525	224	1.200	0.032
0.9	1.8	33,970	544	1.350	0.045	24,770	396	1.350	0.045	14,862	214	1.350	0.036
1	2	38,217	764	1.500	0.050	25,478	510	1.500	0.050	15,287	275	1.500	0.040
1.5	3	28,025	561	2.250	0.150	21,231	425	2.250	0.150	12,739	229	2.250	0.135
2	6	21,019	631	3.000	0.200	17,516	525	3.000	0.200	10,510	284	3.000	0.180
2.5	8	16,815	504	3.750	0.250	14,013	420	3.750	0.250	8,408	227	3.750	0.225
3	8	15,287	611	4.500	0.300	11,677	467	4.500	0.300	7,006	252	4.500	0.270
3.5	10	13,103	524	5.250	0.350	10,919	437	5.250	0.350	6,551	236	5.250	0.315
4	11	11,465	573	6.000	0.400	9,554	478	6.000	0.400	5,732	258	6.000	0.360
4.5	11	10,191	510	6.750	0.450	8,493	425	6.750	0.450	5,096	229	6.750	0.405
5	13	9,172	550	7.500	0.500	7,643	459	7.500	0.500	4,586	248	7.500	0.450
5.5	13	8,338	500	8.250	0.550	6,948	417	8.250	0.550	4,169	225	8.250	0.495
6	13	7,643	459	9.000	0.600	6,369	382	9.000	0.600	3,822	206	9.000	0.540
7	16	6,551	459	10.500	0.700	5,460	382	10.500	0.700	3,276	206	10.500	0.630
8	19	5,732	401	12.000	0.800	4,777	334	12.000	0.800	2,866	181	12.000	0.720
9	19	5,096	408	13.500	0.900	4,246	340	13.500	0.900	2,548	183	13.500	0.810
10	22	4,586	459	15.000	1.000	3,822	382	15.000	1.000	2,293	206	15.000	0.900
12	26	3,822	459	18.000	1.200	3,185	382	18.000	1.200	1,911	206	18.000	1.080
16	35	2,866	401	24.000	1.600	2,389	334	24.000	1.600	1,433	181	24.000	1.440
20	40	2,293	367	30.000	2.000	1,911	306	30.000	2.000	1,146	165	30.000	1.800

外径 DC Tool dia. (mm)	刃長 APMX Flute length (mm)	合金鋼・工具鋼 Alloy steels (25~35HRC) HPM7,SKD61Ⓐ,SKT4				プリハードン鋼 Pre-hardened steels (35~45HRC) HPM-MAGIC,CENA1,NAK80				焼入れ鋼 Hardened steels (45~52HRC) SKD61Ⓐ,HPM38,DAC-MAGIC			
		回転数 min ⁻¹	送り速度 mm/min	ap mm	ae mm	回転数 min ⁻¹	送り速度 mm/min	ap mm	ae mm	回転数 min ⁻¹	送り速度 mm/min	ap mm	ae mm
0.2	0.4	33,439	301	0.300	0.008	26,752	217	0.300	0.006	16,720	105	0.300	0.006
0.3	0.6	22,293	201	0.450	0.012	17,834	144	0.450	0.009	11,146	70	0.450	0.009
0.4	0.8	16,720	150	0.600	0.016	13,376	108	0.600	0.012	8,360	53	0.600	0.012
0.5	1	15,287	138	0.750	0.020	12,229	99	0.750	0.015	7,643	48	0.750	0.015
0.6	1.2	15,924	229	0.900	0.024	12,739	165	0.900	0.018	7,962	80	0.900	0.018
0.7	1.4	17,743	256	1.050	0.028	14,195	184	1.050	0.021	8,872	89	1.050	0.021
0.8	1.6	15,525	224	1.200	0.032	12,420	161	1.200	0.024	7,763	78	1.200	0.024
0.9	1.8	14,862	214	1.350	0.036	11,890	154	1.350	0.027	7,431	75	1.350	0.027
1	2	15,287	275	1.500	0.040	12,229	198	1.500	0.030	7,643	96	1.500	0.030
1.5	3	12,739	229	2.250	0.135	10,191	165	2.250	0.120	6,369	80	2.250	0.045
2	6	10,510	284	3.000	0.180	6,115	149	3.000	0.160	5,732	108	3.000	0.060
2.5	8	8,408	227	3.750	0.225	5,707	139	3.750	0.200	5,350	101	3.750	0.075
3	8	7,006	252	4.500	0.270	5,096	165	4.500	0.240	4,777	120	4.500	0.090
3.5	10	6,551	236	5.250	0.315	4,659	151	5.250	0.280	4,368	110	5.250	0.105
4	11	5,732	258	6.000	0.360	4,331	175	6.000	0.320	4,061	128	6.000	0.120
4.5	11	5,096	229	6.750	0.405	4,076	165	6.750	0.360	3,822	120	6.750	0.135
5	13	4,586	248	7.500	0.450	3,873	188	7.500	0.400	3,631	137	7.500	0.150
5.5	13	4,169	225	8.250	0.495	3,706	180	8.250	0.440	3,474	131	8.250	0.165
6	13	3,822	206	9.000	0.540	3,397	165	9.000	0.480	3,185	120	9.000	0.180
7	16	3,276	206	10.500	0.630	2,912	165	10.500	0.560	2,730	120	10.500	0.210
8	19	2,866	181	12.000	0.720	2,548	144	12.000	0.640	2,389	105	12.000	0.240
9	19	2,548	183	13.500	0.810	2,265	147	13.500	0.720	2,123	107	13.500	0.270
10	22	2,293	206	15.000	0.900	2,038	165	15.000	0.800	1,911	120	15.000	0.300
12	26	1,911	206	18.000	1.080	1,699	165	18.000	0.960	1,592	120	18.000	0.360
16	35	1,433	181	24.000	1.440	1,274	144	24.000	1.280	1,194	105	24.000	0.480
20	40	1,146	165	30.000	1.800	1,019	132	30.000	1.600	955	96	30.000	0.600

- 【注意】**
- ① 本工具のPNコーティングはその性質上、通電性が微小です。従って通電方式の工具長測定装置をご使用の際にはご注意ください。
 - ② 切削条件は2枚刃の場合を示します。4枚刃は送り速度を1.5倍にしてください。
 - ③ できるだけ高剛性、高精度の機械をご使用ください。
 - ④ 被削材、加工形状に合わせて、適切なクーラントを使用してください。
 - ⑤ この切削条件表は切削条件の目安を示すものです。実際の加工では加工形状、目的使用機械等により条件を調整してください。
 - ⑥ 機械の回転数が足りない場合には、回転数と送り速度を同じ比率で下げてください。

- 【Note】**
- ① PN coating is less electro conductive. Therefore, electric transmitted measuring systems may not work.
 - ② The cutting conditions given above is applied to 2 flutes type end mills. As for 4 flutes type, increase the feed rate by 1.5 times.
 - ③ Use a highly rigid and accurate machine as possible.
 - ④ Use the appropriate coolant for the work material and machining shape.
 - ⑤ These conditions are for general guidance; in actual machining conditions adjust the parameters according to your actual machine and work-piece conditions.
 - ⑥ If the rpm available is lower than that recommended please reduce the feed rate to the same ratio.

HGOS2-PN

溝切削 Slotting

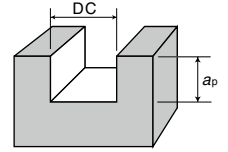

Carbide End Mills Square End Mills

外径 DC Tool dia. (mm)	刃長 APMX Flute length (mm)	銅合金・アルミ合金 Copper alloys, Aluminum alloys			鋳鉄・炭素鋼 Cast irons, Carbon steels (150~200HB) FC250,S50C,S55C			ステンレス鋼 Stainless steels (25~35HRC) SUS304,SUS316		
		回転数 min ⁻¹	送り速度 mm/min	ap mm	回転数 min ⁻¹	送り速度 mm/min	ap mm	回転数 min ⁻¹	送り速度 mm/min	ap mm
0.2	0.4	58,678	235	0.01	53,344	213	0.01	37,341	157	0.01
0.3	0.6	39,119	156	0.02	35,563	142	0.02	24,894	120	0.02
0.4	0.8	35,032	140	0.02	26,672	107	0.02	22,293	103	0.02
0.5	1	31,529	126	0.03	25,478	102	0.03	20,064	103	0.03
0.6	1.2	32,113	180	0.03	23,885	191	0.03	20,435	143	0.03
0.7	1.4	30,027	240	0.04	25,023	200	0.04	19,108	161	0.04
0.8	1.6	28,463	228	0.04	23,885	191	0.04	18,113	152	0.04
0.9	1.8	27,247	218	0.05	23,001	184	0.05	17,339	143	0.05
1	2	28,025	215	0.05	22,293	175	0.05	17,834	125	0.05
1.5	3	21,019	210	0.08	16,985	170	0.08	12,739	115	0.08
2	6	15,764	189	0.12	14,331	172	0.12	8,917	96	0.12
2.5	8	12,611	151	0.18	11,465	138	0.18	7,643	83	0.18
3	8	11,677	163	0.30	9,554	134	0.30	6,794	86	0.30
3.5	10	10,009	140	0.35	9,099	127	0.35	6,187	78	0.35
4	11	8,758	140	0.60	7,962	127	0.60	5,732	83	0.60
4.5	11	7,785	125	0.90	7,077	113	0.90	4,034	58	0.90
5	13	7,006	140	1.25	6,369	127	1.25	3,822	69	1.25
5.5	13	6,369	127	1.38	5,790	116	1.38	3,648	66	1.38
6	13	5,839	160	1.80	5,308	150	1.80	3,503	90	1.80
7	16	5,005	200	2.45	4,550	182	2.45	3,139	113	2.45
8	19	4,379	215	3.20	3,981	200	3.20	1,672	125	3.20
9	19	3,892	234	4.05	3,539	212	4.05	1,486	146	4.05
10	22	3,503	210	5.00	3,185	191	5.00	1,338	134	5.00
12	26	2,919	234	6.00	2,654	212	6.00	1,115	103	6.00
16	35	2,189	219	8.00	1,990	199	8.00	975	100	8.00
20	40	1,752	210	10.00	1,592	191	10.00	836	103	10.00

外径 DC Tool dia. (mm)	刃長 APMX Flute length (mm)	合金鋼・工具鋼 Alloy steels (25~35HRC) HPM7,SKD61Ⓐ,SKT4			プリハードン鋼 Pre-hardened steels (35~45HRC) HPM-MAGIC,CENA1,NAK80			焼入れ鋼 Hardened steels (45~52HRC) SKD61Ⓑ,HPM38,DAC-MAGIC		
		回転数 min ⁻¹	送り速度 mm/min	ap mm	回転数 min ⁻¹	送り速度 mm/min	ap mm	回転数 min ⁻¹	送り速度 mm/min	ap mm
0.2	0.4	24,005	122	0.01	14,936	56	0.01	8,402	34	0.01
0.3	0.6	16,003	109	0.02	9,958	50	0.01	5,601	30	0.01
0.4	0.8	14,331	103	0.02	8,917	56	0.02	5,016	34	0.02
0.5	1	12,898	93	0.03	8,025	51	0.02	4,514	31	0.02
0.6	1.2	13,137	112	0.03	8,174	51	0.03	4,598	31	0.02
0.7	1.4	12,284	125	0.04	7,643	58	0.03	4,299	35	0.03
0.8	1.6	11,644	119	0.04	7,245	55	0.04	4,075	33	0.03
0.9	1.8	11,146	133	0.05	6,936	61	0.04	3,901	37	0.04
1	2	11,465	125	0.05	7,134	58	0.05	4,013	35	0.04
1.5	3	9,554	114	0.08	5,945	52	0.07	3,344	32	0.06
2	6	7,166	122	0.12	4,459	56	0.11	2,508	34	0.10
2.5	8	5,732	97	0.18	3,567	45	0.16	2,006	27	0.14
3	8	4,777	81	0.30	2,972	37	0.27	1,672	23	0.24
3.5	10	4,095	104	0.35	2,548	48	0.32	1,433	29	0.28
4	11	3,583	91	0.60	2,229	42	0.54	1,254	26	0.49
4.5	11	3,185	92	0.90	1,982	50	0.81	1,115	30	0.73
5	13	2,866	103	1.25	1,783	45	1.13	1,003	27	1.01
5.5	13	2,606	89	1.38	1,621	41	1.24	912	25	1.11
6	13	2,389	105	1.80	1,486	48	1.62	836	30	1.46
7	16	2,047	122	2.45	1,274	56	2.21	717	34	1.98
8	19	1,075	120	3.20	669	54	2.88	376	33	2.59
9	19	955	114	4.05	594	52	3.65	334	32	3.28
10	22	860	117	5.00	535	54	4.50	301	33	4.05
12	26	717	110	6.00	446	51	5.40	251	31	4.86
16	35	627	107	8.00	390	49	7.20	219	30	6.48
20	40	537	100	10.00	334	51	9.00	188	31	8.10

[注意] 4枚刃は溝切削には適しません。 **[Note]** The 4 flutes not suitable for slotting.

Epoch CS Power Mill 3flutes

エポックCSパワーミル 3枚刃

レギュラー刃長

Regular

3枚刃多機能エンドミル。CSコーティング採用で長寿命。
3-flute multi-function end mill. Uses CS Coating for long life.



外径公差
 $\phi 2 \sim \phi 6$: 0 ~ -0.015
 $\phi 6.5 \sim \phi 25$: 0 ~ -0.02



(mm)

3枚刃
3Flutes



EPP3○○○-CS



商品コード Item code	在庫 Stock	寸法 Size (mm)				希望小売 価格(円) Suggested retail price(¥)
		外径 Tool dia.	刃長 Flute length	全長 Overall length	シャンク径 Shank dia.	
EPP3020-CS	<input type="checkbox"/>	2	6	60	6	—
EPP3025-CS	<input type="checkbox"/>	2.5	8	60	6	—
EPP3030-CS	<input checked="" type="checkbox"/>	3	8	60	6	10,940
EPP3035-CS	<input type="checkbox"/>	3.5	10	60	6	—
EPP3040-CS	<input checked="" type="checkbox"/>	4	11	60	6	11,470
EPP3045-CS	<input type="checkbox"/>	4.5	11	60	6	—
EPP3050-CS	<input checked="" type="checkbox"/>	5	13	60	6	12,800
EPP3055-CS	<input type="checkbox"/>	5.5	13	60	6	—
EPP3060-CS	<input checked="" type="checkbox"/>	6	13	60	6	14,030
EPP3065-CS	<input type="checkbox"/>	6.5	16	70	8	—
EPP3070-CS	<input type="checkbox"/>	7	16	70	8	—
EPP3075-CS	<input type="checkbox"/>	7.5	16	70	8	—
EPP3080-CS	<input checked="" type="checkbox"/>	8	19	75	8	17,180
EPP3085-CS	<input type="checkbox"/>	8.5	19	80	10	—
EPP3090-CS	<input type="checkbox"/>	9	19	80	10	—
EPP3095-CS	<input type="checkbox"/>	9.5	19	80	10	—
EPP3100-CS	<input checked="" type="checkbox"/>	10	22	80	10	23,130
EPP3110-CS	<input type="checkbox"/>	11	22	100	12	—
EPP3120-CS	<input checked="" type="checkbox"/>	12	26	100	12	28,960
EPP3130-CS	<input type="checkbox"/>	13	26	100	12	—
EPP3140-CS	<input type="checkbox"/>	14	26	110	16	—
EPP3150-CS	<input type="checkbox"/>	15	26	110	16	—
EPP3160-CS	<input checked="" type="checkbox"/>	16	32	110	16	66,640
EPP3170-CS	<input type="checkbox"/>	17	32	110	16	—
EPP3180-CS	<input type="checkbox"/>	18	32	125	20	—
EPP3190-CS	<input type="checkbox"/>	19	32	125	20	—
EPP3200-CS	<input checked="" type="checkbox"/>	20	38	125	20	97,250
EPP3210-CS	<input type="checkbox"/>	21	38	125	20	—
EPP3220-CS	<input type="checkbox"/>	22	38	125	20	—
EPP3230-CS	<input type="checkbox"/>	23	45	140	25	—
EPP3240-CS	<input type="checkbox"/>	24	45	140	25	—
EPP3250-CS	<input type="checkbox"/>	25	63	140	25	—

○ 対応被削材 Applicable work material

炭素鋼 合金鋼 Carbon steel Alloy steel	プリハー ド鋼 Pre-hardened steel	高硬度 Hardened steel		ステン レス鋼 Stainless steel	チタン合金 耐熱合金 Titanium alloy Heat-resistant alloy	銅合金 Copper alloy	アルミ 合金 Aluminum alloy
○	○	> 45HRC ≤ 55HRC	> 55HRC ≤ 65HRC	> 65HRC	○	○	○

●印：標準在庫品です。 ○印：特定代理店在庫です。弊社営業へお問合せください。
● : Stocked items. ○ : Stocked by specified distributor. Contact with our sales department.

○ 再研磨対応外径範囲 Re-grinding compatibility range

商品コード Item code	外周 Outer dia. (mm)	エンド End (mm)
EPP3-CS	6 ~ 25	3NT 2 ~ 25

標準切削条件表 Recommended cutting conditions

EPP3-CS

溝切削 Slotting 側面切削 Side milling

被削材 Work material	アルミニウム合金展伸材 Aluminum alloy wrought A7075 A5052		鋳鉄 Cast irons (150~200HB) FC250		炭素鋼 Carbon steels (180~220HB) SS400, S50C		合金鋼 Alloy steels (200~250HB) SCM, SNCM		工具鋼・プリハードン鋼 Tool steels, Pre-hardened steels (25~40HRC) SKD, CENA1		ステンレス鋼 Stainless steels SUS304 SUS630		チタン合金 Titanium alloys Ti-6Al-4V		超耐熱合金 Super heat-resistant alloys Inconel Hasteloy		
	溝 切込み (Slotting) Depth of cut (mm)	$a_p \leq 0.5DC$ $a_e = 1DC$	$a_p \leq 0.5DC$ $a_e = 1DC$	$a_p \leq 0.5DC$ $a_e = 1DC$	$a_p \leq 0.5DC$ $a_e = 1DC$	$a_p \leq 0.5DC$ $a_e = 1DC$	$a_p \leq 0.5DC$ $a_e = 1DC$	$a_p \leq 0.5DC$ $a_e = 1DC$	$a_p \leq 0.5DC$ $a_e = 1DC$	$a_p \leq 0.5DC$ $a_e = 1DC$	$a_p \leq 0.5DC$ $a_e = 1DC$	$a_p \leq 0.5DC$ $a_e = 1DC$	$a_p \leq 0.2DC$ $a_e = 1DC$	$a_p \leq 0.2DC$ $a_e = 1DC$			
側面 切込み (Side milling) Depth of cut (mm)	$a_p = 1.5DC$ $a_e = 0.1DC$	$a_p = 1.5DC$ $a_e = 0.1DC$	$a_p = 1.5DC$ $a_e = 0.1DC$	$a_p = 1.5DC$ $a_e = 0.1DC$	$a_p = 1.5DC$ $a_e = 0.1DC$	$a_p = 1.5DC$ $a_e = 0.1DC$	$a_p = 1.5DC$ $a_e = 0.1DC$	$a_p = 1.5DC$ $a_e = 0.1DC$	$a_p = 1.5DC$ $a_e = 0.1DC$	$a_p = 1.5DC$ $a_e = 0.1DC$	$a_p = 1.5DC$ $a_e = 0.1DC$	$a_p = 1.5DC$ $a_e = 0.1DC$	$a_p = 1.5DC$ $a_e = 0.05DC$				
	外径DC Tool Dia. (mm)	回転数 n (min^{-1})	送り速度 V_f (mm/min)	回転数 n (min^{-1})	送り速度 V_f (mm/min)	回転数 n (min^{-1})	送り速度 V_f (mm/min)	回転数 n (min^{-1})	送り速度 V_f (mm/min)	回転数 n (min^{-1})	送り速度 V_f (mm/min)	回転数 n (min^{-1})	送り速度 V_f (mm/min)	回転数 n (min^{-1})	送り速度 V_f (mm/min)		
高速 条件 High speed	$\phi 2$	50,000	2,240	9,500	420	14,000	630	11,000	490								
	$\phi 3$	37,000	2,800	6,400	480	9,600	860	7,400	670								
	$\phi 4$	28,000	2,900	4,800	500	7,200	860	5,600	670								
	$\phi 5$	22,000	3,200	3,800	550	5,700	940	4,500	740								
	$\phi 6$	19,000	3,500	3,200	600	4,800	1,010	3,700	780								
	$\phi 8$	14,000	3,600	2,400	610	3,600	1,030	2,800	800								
	$\phi 10$	11,000	3,300	1,900	570	2,900	1,000	2,200	760								
	$\phi 12$	9,300	3,100	1,600	530	2,400	900	1,900	710								
	$\phi 16$	7,000	2,600	1,200	450	1,800	760	1,400	590								
	$\phi 20$	5,600	2,400	1,000	420	1,400	650	1,100	510								
$\phi 25$	4,460	2,000	760	340	1,100	500	890	400									
汎用 条件 General	溝 切込み (Slotting) Depth of cut (mm)	$a_p \leq 1DC$ $a_e = 1DC$	$a_p \leq 1DC$ $a_e = 1DC$	$a_p \leq 1DC$ $a_e = 1DC$	$a_p \leq 1DC$ $a_e = 1DC$	$a_p \leq 1DC$ $a_e = 1DC$	$a_p \leq 1DC$ $a_e = 1DC$	$a_p \leq 1DC$ $a_e = 1DC$	$a_p \leq 0.5DC$ $a_e = 1DC$	$a_p \leq 0.5DC$ $a_e = 1DC$	$a_p \leq 0.2DC$ $a_e = 1DC$	$a_p \leq 0.2DC$ $a_e = 1DC$					
	側面 切込み (Side milling) Depth of cut (mm)	$a_p = 1.5DC$ $a_e = 0.2DC$	$a_p = 1.5DC$ $a_e = 0.2DC$	$a_p = 1.5DC$ $a_e = 0.2DC$	$a_p = 1.5DC$ $a_e = 0.2DC$	$a_p = 1.5DC$ $a_e = 0.2DC$	$a_p = 1.5DC$ $a_e = 0.2DC$	$a_p = 1.5DC$ $a_e = 0.15DC$	$a_p = 1.5DC$ $a_e = 0.1DC$	$a_p = 1.5DC$ $a_e = 0.1DC$	$a_p = 1.5DC$ $a_e = 0.1DC$	$a_p = 1.5DC$ $a_e = 0.05DC$					
	外径DC Tool Dia. (mm)	回転数 n (min^{-1})	送り速度 V_f (mm/min)	回転数 n (min^{-1})	送り速度 V_f (mm/min)	回転数 n (min^{-1})	送り速度 V_f (mm/min)	回転数 n (min^{-1})	送り速度 V_f (mm/min)	回転数 n (min^{-1})	送り速度 V_f (mm/min)	回転数 n (min^{-1})	送り速度 V_f (mm/min)	回転数 n (min^{-1})	送り速度 V_f (mm/min)		
	$\phi 2$	31,800	1,400	6,400	380	11,000	660	8,000	360	8,000	360	7,950	280	7,950	360	3,180	80
	$\phi 3$	21,000	1,600	4,200	320	7,400	560	5,300	400	5,300	360	5,300	290	5,300	360	2,100	90
	$\phi 4$	16,000	1,700	3,200	340	5,600	590	4,000	420	4,000	360	4,000	290	4,000	360	1,600	100
	$\phi 5$	13,000	1,900	2,500	360	4,500	650	3,200	460	3,200	400	3,200	320	3,200	400	1,300	110
	$\phi 6$	11,000	2,000	2,100	390	3,700	690	2,700	500	2,700	430	2,700	340	2,700	430	1,100	120
	$\phi 8$	8,000	2,000	1,600	410	2,800	710	2,000	510	2,000	430	2,000	340	2,000	430	800	110
	$\phi 10$	6,400	1,900	1,300	390	2,200	660	1,600	480	1,600	410	1,600	330	1,600	410	640	110
$\phi 12$	5,300	1,700	1,100	360	1,900	630	1,300	430	1,300	370	1,300	290	1,300	370	530	100	
$\phi 16$	4,000	1,500	800	300	1,400	530	1,000	380	1,000	320	1,000	250	1,000	320	400	80	
$\phi 20$	3,200	1,300	600	250	1,100	460	800	340	800	280	800	220	800	280	320	70	
$\phi 25$	2,550	1,100	510	240	890	430	640	230	640	230	630	190	630	250	250	60	

※溝切削については上表の条件を、側面切削については回転数が上表の1~1.3倍、送り速度が1~1.5倍の条件を標準切削条件といたします。
 ※座ぐり切削は汎用条件の回転数で、送り速度のみ1/5程度に下げてください。

For slotting, please refer to above table with depth of cut for slotting.
 For side milling, please increase Revolution Speed to 1~1.3 times and Feed Rate to 1~1.5 times of above table.
 When the rpm generally used for slotting is used for spot facing, just lower the feed rate by about 20%.

- [注意]**
- ①できるだけ高剛性、高精度の機械をご使用ください。
 - ②この標準切削条件表は切削条件の目安を示すものです。実際の加工では加工形状、目的、使用機械等により条件を調整してください。
 - ③機械の回転数が足りない場合は、回転数と送り速度を同じ比率で下げてください。
 - ④ステンレス鋼・超耐熱合金には、切削液をご使用ください。(防火対策を必ず行ってください。)

- [Note]**
- ① Use a highly rigid and accurate machine as possible.
 - ② These conditions are for general guidance; in actual machining conditions adjust the parameters according to your actual machine and work-piece conditions.
 - ③ If the rpm available is lower than that recommended please reduce the feed rate to the same ratio.
 - ④ For the stainless steel and heat resistant alloys please use cutting fluid. (Please provide adequate fire prevention.)

Epoch SUS Finish エポックSUSフィニッシュ

仕上げ加工用にSUSフィニッシュを追加。
Additional lineup of Epoch SUS Finish for finishing.

レギュラー刃長 Regular



外径公差 Dia.tolerance
φ3~φ6 : 0~-0.015
φ7~φ12 : 0~-0.02



(mm)

4枚刃
4 Flutes



ミディアム刃長 Medium



外径公差 Dia.tolerance
φ3~φ6 : 0~-0.015
φ7~φ12 : 0~-0.02



(mm)

4枚刃
4 Flutes



EPSF4-PN



商品コード Item code	在庫 Stock	寸法 Size(mm)				形状 Shape	希望小売 価格(円) Suggested retail price(¥)
		外径 Tool dia. DC	刃長 Flute length APMX	全長 Overall length LF	シャンク径 Shank dia. DCONMS		
EPSF4030-PN	●	3	7.5	56	6	A	8,090
EPSF4035-PN	●	3.5	8.8	56	6	A	9,180
EPSF4040-PN	●	4	10	56	6	A	8,530
EPSF4045-PN	●	4.5	11.3	56	6	A	10,250
EPSF4050-PN	●	5	12.5	56	6	A	9,520
EPSF4055-PN	●	5.5	13.8	56	6	A	11,220
EPSF4060-PN	●	6	15	56	6	B	10,370
EPSF4070-PN	●	7	17.5	63	8	A	12,870
EPSF4080-PN	●	8	20	63	8	B	12,870
EPSF4090-PN	●	9	22.5	74	10	A	17,460
EPSF4100-PN	●	10	25	74	10	B	17,460
EPSF4110-PN	●	11	27.5	86	12	A	21,700
EPSF4120-PN	●	12	30	86	12	B	21,700

EPSFM-PN

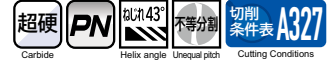

商品コード Item code	在庫 Stock	寸法 Size(mm)				形状 Shape	希望小売 価格(円) Suggested retail price(¥)
		外径 Tool dia. DC	刃長 Flute length APMX	全長 Overall length LF	シャンク径 Shank dia. DCONMS		
EPSFM4030-PN	●	3	12	56	6	A	9,640
EPSFM4035-PN	●	3.5	14	56	6	A	11,150
EPSFM4040-PN	●	4	16	56	6	A	10,240
EPSFM4045-PN	●	4.5	18	70	6	A	12,350
EPSFM4050-PN	●	5	20	70	6	A	11,370
EPSFM4055-PN	●	5.5	22	70	6	A	13,590
EPSFM4060-PN	●	6	24	70	6	B	12,490
EPSFM4070-PN	●	7	28	75	8	A	15,290
EPSFM4080-PN	●	8	32	80	8	B	15,290
EPSFM4090-PN	●	9	36	100	10	A	20,490
EPSFM4100-PN	●	10	40	100	10	B	20,490
EPSFM4110-PN	●	11	44	120	12	A	25,850
EPSFM4120-PN	●	12	48	120	12	B	25,850

ロング刃長 Long



外径公差 Dia.tolerance
φ3~φ6 : 0~-0.015
φ7~φ12 : 0~-0.02



(mm)

4枚刃
4 Flutes



EPSFL4-PN

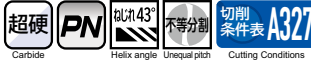

商品コード Item code	在庫 Stock	寸法 Size(mm)				形状 Shape	希望小売 価格(円) Suggested retail price(¥)
		外径 Tool dia. DC	刃長 Flute length APMX	全長 Overall length LF	シャンク径 Shank dia. DCONMS		
EPSFL4030-PN	●	3	15	56	6	A	14,490
EPSFL4040-PN	●	4	20	70	6	A	15,180
EPSFL4050-PN	●	5	25	70	6	A	16,930
EPSFL4060-PN	●	6	30	70	6	B	18,370
EPSFL4070-PN	●	7	35	80	8	A	23,030
EPSFL4080-PN	●	8	40	80	8	B	23,030
EPSFL4090-PN	●	9	45	100	10	A	30,970
EPSFL4100-PN	●	10	50	100	10	B	30,970
EPSFL4110-PN	●	11	55	120	12	A	37,990
EPSFL4120-PN	●	12	60	120	12	B	37,990

エポックSUSフィニッシュの工具形状

Tool shape of Epoch SUS Finish

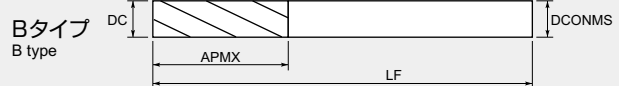
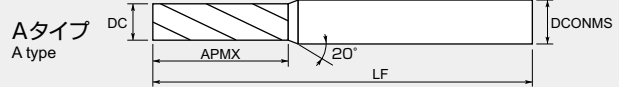

EPSF-PN、EPSFM-PN、EPSFL-PNの対応被削材

Applicable work material of EPSF-PN, EPSFM-PN, EPSFL-PN

炭素鋼 合金鋼 Carbon steel Alloy steel	プリハー ド鋼 Pre-hardened steel	高硬度 Hardened steel			ステン レス鋼 Stainless steel	チタン合金 耐熱合金 Titanium alloy Heat-resistant alloy	銅合金 Copper alloy	アルミ 合金 Aluminum alloy
		> 45HRC ≤ 55HRC	> 55HRC ≤ 65HRC	> 65HRC				
○	○				○	○	○	

再研磨対応外径範囲

Re-grinding compatibility range

商品コード Item code	外周 Outer dia. (mm)	エンド End (mm)
EPSF-PN	6 ~ 12	4 ~ 12
EPSFM-PN	6 ~ 12	4 ~ 12
EPSFL-PN	6 ~ 12	4 ~ 12

●印：標準在庫品です。 ●：Stocked Items.

Epoch SUS Multi エポックSUSマルチ



ショート刃長 Short



外径公差 Dia. tolerance $\phi 1 \sim \phi 6 : 0 \sim -0.015$
 $\phi 6.1 \sim \phi 20 : 0 \sim -0.02$
 h5 h6 $\phi 0 \sim 12 \quad \phi 16, \phi 20$ (mm)



ステンレス鋼、炭素鋼、合金鋼等の荒～仕上げ加工までマルチに対応。
 Multi-purpose for roughing to finishing of stainless steel, carbon steel, alloy steel, etc.

ラジウスはA235頁を参照してください
 Please refer to page A235 for Radius

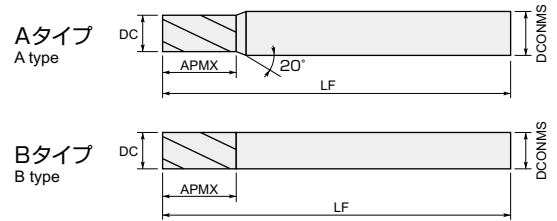

EPSMS4-PN

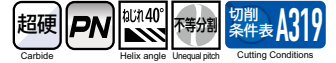

商品コード Item code	在庫 Stock	寸法 Size(mm)				形状 Shape	希望小売 価格(円) Suggested retail price(¥)
		外径 Tool dia. DC	刃長 Flute length APMX	全長 Overall length LF	シャンク径 Shank dia. DCONMS		
EPSMS4010-PN	<input type="checkbox"/>	1	1.5	56	6	A	—
EPSMS4011-PN	<input type="checkbox"/>	1.1	1.7	56	6	A	—
EPSMS4012-PN	<input type="checkbox"/>	1.2	1.8	56	6	A	—
EPSMS4013-PN	<input type="checkbox"/>	1.3	2	56	6	A	—
EPSMS4014-PN	<input type="checkbox"/>	1.4	2.1	56	6	A	—
EPSMS4015-PN	<input type="checkbox"/>	1.5	2.3	56	6	A	—
EPSMS4016-PN	<input type="checkbox"/>	1.6	2.4	56	6	A	—
EPSMS4017-PN	<input type="checkbox"/>	1.7	2.6	56	6	A	—
EPSMS4018-PN	<input type="checkbox"/>	1.8	2.7	56	6	A	—
EPSMS4019-PN	<input type="checkbox"/>	1.9	2.9	56	6	A	—
EPSMS4020-PN	<input type="checkbox"/>	2	3	56	6	A	—
EPSMS4021-PN	<input type="checkbox"/>	2.1	3.2	56	6	A	—
EPSMS4022-PN	<input type="checkbox"/>	2.2	3.3	56	6	A	—
EPSMS4023-PN	<input type="checkbox"/>	2.3	3.5	56	6	A	—
EPSMS4024-PN	<input type="checkbox"/>	2.4	3.6	56	6	A	—
EPSMS4025-PN	<input type="checkbox"/>	2.5	3.8	56	6	A	—
EPSMS4026-PN	<input type="checkbox"/>	2.6	3.9	56	6	A	—
EPSMS4027-PN	<input type="checkbox"/>	2.7	4.1	56	6	A	—
EPSMS4028-PN	<input type="checkbox"/>	2.8	4.2	56	6	A	—
EPSMS4029-PN	<input type="checkbox"/>	2.9	4.4	56	6	A	—
EPSMS4030-PN	<input type="checkbox"/>	3	4.5	56	6	A	—
EPSMS4031-PN	<input type="checkbox"/>	3.1	4.7	56	6	A	—
EPSMS4032-PN	<input type="checkbox"/>	3.2	4.8	56	6	A	—
EPSMS4033-PN	<input type="checkbox"/>	3.3	5	56	6	A	—
EPSMS4034-PN	<input type="checkbox"/>	3.4	5.1	56	6	A	—
EPSMS4035-PN	<input type="checkbox"/>	3.5	5.3	56	6	A	—
EPSMS4036-PN	<input type="checkbox"/>	3.6	5.4	56	6	A	—
EPSMS4037-PN	<input type="checkbox"/>	3.7	5.6	56	6	A	—
EPSMS4038-PN	<input type="checkbox"/>	3.8	5.7	56	6	A	—
EPSMS4039-PN	<input type="checkbox"/>	3.9	5.9	56	6	A	—
EPSMS4040-PN	<input type="checkbox"/>	4	6	56	6	A	—
EPSMS4041-PN	<input type="checkbox"/>	4.1	6.2	56	6	A	—
EPSMS4042-PN	<input type="checkbox"/>	4.2	6.3	56	6	A	—
EPSMS4043-PN	<input type="checkbox"/>	4.3	6.5	56	6	A	—
EPSMS4044-PN	<input type="checkbox"/>	4.4	6.6	56	6	A	—
EPSMS4045-PN	<input type="checkbox"/>	4.5	6.8	56	6	A	—
EPSMS4046-PN	<input type="checkbox"/>	4.6	6.9	56	6	A	—
EPSMS4047-PN	<input type="checkbox"/>	4.7	7.1	56	6	A	—
EPSMS4048-PN	<input type="checkbox"/>	4.8	7.2	56	6	A	—
EPSMS4049-PN	<input type="checkbox"/>	4.9	7.4	56	6	A	—

商品コード Item code	在庫 Stock	寸法 Size(mm)				形状 Shape	希望小売 価格(円) Suggested retail price(¥)
		外径 Tool dia. DC	刃長 Flute length APMX	全長 Overall length LF	シャンク径 Shank dia. DCONMS		
EPSMS4050-PN	<input type="checkbox"/>	5	7.5	56	6	A	—
EPSMS4051-PN	<input type="checkbox"/>	5.1	7.7	56	6	A	—
EPSMS4052-PN	<input type="checkbox"/>	5.2	7.8	56	6	A	—
EPSMS4053-PN	<input type="checkbox"/>	5.3	8	56	6	A	—
EPSMS4054-PN	<input type="checkbox"/>	5.4	8.1	56	6	A	—
EPSMS4055-PN	<input type="checkbox"/>	5.5	8.3	56	6	A	—
EPSMS4056-PN	<input type="checkbox"/>	5.6	8.4	56	6	A	—
EPSMS4057-PN	<input type="checkbox"/>	5.7	8.6	56	6	A	—
EPSMS4058-PN	<input type="checkbox"/>	5.8	8.7	56	6	A	—
EPSMS4059-PN	<input type="checkbox"/>	5.9	8.9	56	6	A	—
EPSMS4060-PN	<input type="checkbox"/>	6	9	56	6	B	—
EPSMS4061-PN	<input type="checkbox"/>	6.1	9.2	63	8	A	—
EPSMS4062-PN	<input type="checkbox"/>	6.2	9.3	63	8	A	—
EPSMS4063-PN	<input type="checkbox"/>	6.3	9.5	63	8	A	—
EPSMS4064-PN	<input type="checkbox"/>	6.4	9.6	63	8	A	—
EPSMS4065-PN	<input type="checkbox"/>	6.5	9.8	63	8	A	—
EPSMS4066-PN	<input type="checkbox"/>	6.6	9.9	63	8	A	—
EPSMS4067-PN	<input type="checkbox"/>	6.7	10.1	63	8	A	—
EPSMS4068-PN	<input type="checkbox"/>	6.8	10.2	63	8	A	—
EPSMS4069-PN	<input type="checkbox"/>	6.9	10.4	63	8	A	—
EPSMS4070-PN	<input type="checkbox"/>	7	10.5	63	8	A	—
EPSMS4071-PN	<input type="checkbox"/>	7.1	10.7	63	8	A	—
EPSMS4072-PN	<input type="checkbox"/>	7.2	10.8	63	8	A	—
EPSMS4073-PN	<input type="checkbox"/>	7.3	11	63	8	A	—
EPSMS4074-PN	<input type="checkbox"/>	7.4	11.1	63	8	A	—
EPSMS4075-PN	<input type="checkbox"/>	7.5	11.3	63	8	A	—
EPSMS4076-PN	<input type="checkbox"/>	7.6	11.4	63	8	A	—
EPSMS4077-PN	<input type="checkbox"/>	7.7	11.6	63	8	A	—
EPSMS4078-PN	<input type="checkbox"/>	7.8	11.7	63	8	A	—
EPSMS4079-PN	<input type="checkbox"/>	7.9	11.9	63	8	A	—
EPSMS4080-PN	<input type="checkbox"/>	8	12	63	8	B	—
EPSMS4081-PN	<input type="checkbox"/>	8.1	12.2	74	10	A	—
EPSMS4082-PN	<input type="checkbox"/>	8.2	12.3	74	10	A	—
EPSMS4083-PN	<input type="checkbox"/>	8.3	12.5	74	10	A	—
EPSMS4084-PN	<input type="checkbox"/>	8.4	12.6	74	10	A	—
EPSMS4085-PN	<input type="checkbox"/>	8.5	12.8	74	10	A	—
EPSMS4086-PN	<input type="checkbox"/>	8.6	12.9	74	10	A	—
EPSMS4087-PN	<input type="checkbox"/>	8.7	13.1	74	10	A	—
EPSMS4088-PN	<input type="checkbox"/>	8.8	13.2	74	10	A	—
EPSMS4089-PN	<input type="checkbox"/>	8.9	13.4	74	10	A	—

印：特定代理店在庫です。弊社営業へお問合せください。
：Stocked by specified distributor. Contact with our sales department.

EPSMS4^{○○○○}-PN

商品コード Item code	在庫 Stock	寸法 Size(mm)				形状 Shape	希望小売 価格(円) Suggested retail price(¥)
		外径 Tool dia.	刃長 Flute length	全長 Overall length	シャンク径 Shank dia.		
		DC	APMX	LF	DCONMS		
EPSMS4090-PN	<input type="checkbox"/>	9	13.5	74	10	A	—
EPSMS4091-PN	<input type="checkbox"/>	9.1	13.7	74	10	A	—
EPSMS4092-PN	<input type="checkbox"/>	9.2	13.8	74	10	A	—
EPSMS4093-PN	<input type="checkbox"/>	9.3	14	74	10	A	—
EPSMS4094-PN	<input type="checkbox"/>	9.4	14.1	74	10	A	—
EPSMS4095-PN	<input type="checkbox"/>	9.5	14.3	74	10	A	—
EPSMS4096-PN	<input type="checkbox"/>	9.6	14.4	74	10	A	—
EPSMS4097-PN	<input type="checkbox"/>	9.7	14.6	74	10	A	—
EPSMS4098-PN	<input type="checkbox"/>	9.8	14.7	74	10	A	—
EPSMS4099-PN	<input type="checkbox"/>	9.9	14.9	74	10	A	—
EPSMS4100-PN	<input type="checkbox"/>	10	15	74	10	B	—
EPSMS4101-PN	<input type="checkbox"/>	10.1	15.2	86	12	A	—
EPSMS4102-PN	<input type="checkbox"/>	10.2	15.3	86	12	A	—
EPSMS4103-PN	<input type="checkbox"/>	10.3	15.5	86	12	A	—
EPSMS4104-PN	<input type="checkbox"/>	10.4	15.6	86	12	A	—
EPSMS4105-PN	<input type="checkbox"/>	10.5	15.8	86	12	A	—
EPSMS4106-PN	<input type="checkbox"/>	10.6	15.9	86	12	A	—
EPSMS4107-PN	<input type="checkbox"/>	10.7	16.1	86	12	A	—
EPSMS4108-PN	<input type="checkbox"/>	10.8	16.2	86	12	A	—
EPSMS4109-PN	<input type="checkbox"/>	10.9	16.4	86	12	A	—
EPSMS4110-PN	<input type="checkbox"/>	11	16.5	86	12	A	—
EPSMS4111-PN	<input type="checkbox"/>	11.1	16.7	86	12	A	—
EPSMS4112-PN	<input type="checkbox"/>	11.2	16.8	86	12	A	—
EPSMS4113-PN	<input type="checkbox"/>	11.3	17	86	12	A	—

商品コード Item code	在庫 Stock	寸法 Size(mm)				形状 Shape	希望小売 価格(円) Suggested retail price(¥)
		外径 Tool dia.	刃長 Flute length	全長 Overall length	シャンク径 Shank dia.		
		DC	APMX	LF	DCONMS		
EPSMS4114-PN	<input type="checkbox"/>	11.4	17.1	86	12	A	—
EPSMS4115-PN	<input type="checkbox"/>	11.5	17.3	86	12	A	—
EPSMS4116-PN	<input type="checkbox"/>	11.6	17.4	86	12	A	—
EPSMS4117-PN	<input type="checkbox"/>	11.7	17.6	86	12	A	—
EPSMS4118-PN	<input type="checkbox"/>	11.8	17.7	86	12	A	—
EPSMS4119-PN	<input type="checkbox"/>	11.9	17.9	86	12	A	—
EPSMS4120-PN	<input type="checkbox"/>	12	18	86	12	B	—
EPSMS4125-PN	<input type="checkbox"/>	12.5	18.8	100	16	A	—
EPSMS4130-PN	<input type="checkbox"/>	13	19.5	100	16	A	—
EPSMS4135-PN	<input type="checkbox"/>	13.5	20.3	100	16	A	—
EPSMS4140-PN	<input type="checkbox"/>	14	21	100	16	A	—
EPSMS4145-PN	<input type="checkbox"/>	14.5	21.8	100	16	A	—
EPSMS4150-PN	<input type="checkbox"/>	15	22.5	100	16	A	—
EPSMS4155-PN	<input type="checkbox"/>	15.5	23.3	100	16	A	—
EPSMS4160-PN	<input type="checkbox"/>	16	24	100	16	B	—
EPSMS4165-PN	<input type="checkbox"/>	16.5	24.8	110	20	A	—
EPSMS4170-PN	<input type="checkbox"/>	17	25.5	110	20	A	—
EPSMS4175-PN	<input type="checkbox"/>	17.5	26.3	110	20	A	—
EPSMS4180-PN	<input type="checkbox"/>	18	27	110	20	A	—
EPSMS4185-PN	<input type="checkbox"/>	18.5	27.8	110	20	A	—
EPSMS4190-PN	<input type="checkbox"/>	19	28.5	110	20	A	—
EPSMS4195-PN	<input type="checkbox"/>	19.5	29.3	110	20	A	—
EPSMS4200-PN	<input type="checkbox"/>	20	30	110	20	B	—

対応被削材 Applicable work material

炭素鋼 合金鋼 Carbon steel Alloy steel	プリハー ド鋼 Pre-hardened steel ≤ 45HRC	高硬度 Hardened steel			ステン レス鋼 Stainless steel	チタン合金 耐熱合金 Titanium alloy Heat-resistant alloy	銅合金 Copper alloy	アルミ 合金 Aluminum alloy
		> 45HRC ≤ 55HRC	> 55HRC ≤ 65HRC	> 65HRC				
○	○				○	○	○	

再研磨対応外径範囲 Re-grinding compatibility range

商品コード Item code	外周 Outer dia. (mm)	エンド End (mm)
EPSMS-PN	6 ~ 20	4 ~ 20

●印：標準在庫品です。
●：Stocked items.

□印：特定代理店在庫です。弊社営業へお問合せください。
□：Stocked by specified distributor. Contact with our sales department.

レギュラー刃長

Regular



外径公差 Dia. tolerance $\phi 1 \sim \phi 6 : 0 \sim -0.015$
 $\phi 6.05 \sim \phi 20 : 0 \sim -0.02$

h5 $\phi 6 \sim 12$ h6 $\phi 16, \phi 20$ (mm)

4枚刃
4 Flutes



EP4M4-PN

商品コード Item code	在庫 Stock	寸法 Size(mm)				形状 Shape	希望小売 価格(円) Suggested retail price(¥)
		外径 Tool dia. DC	刃長 Flute length APMX	全長 Overall length LF	シャンク径 Shank dia. DCONMS		
EP4M4010-PN	●	1	2.5	56	6	A	7,500
EP4M40105-PN	□	1.05	2.8	56	6	A	—
EP4M4011-PN	□	1.1	2.8	56	6	A	—
EP4M40115-PN	□	1.15	3	56	6	A	—
EP4M4012-PN	□	1.2	3	56	6	A	—
EP4M40125-PN	□	1.25	3.3	56	6	A	—
EP4M4013-PN	□	1.3	3.3	56	6	A	—
EP4M40135-PN	□	1.35	3.5	56	6	A	—
EP4M4014-PN	□	1.4	3.5	56	6	A	—
EP4M40145-PN	□	1.45	3.8	56	6	A	—
EP4M4015-PN	□	1.5	3.8	56	6	A	—
EP4M40155-PN	□	1.55	4	56	6	A	—
EP4M4016-PN	□	1.6	4	56	6	A	—
EP4M40165-PN	□	1.65	4.3	56	6	A	—
EP4M4017-PN	□	1.7	4.3	56	6	A	—
EP4M40175-PN	□	1.75	4.5	56	6	A	—
EP4M4018-PN	□	1.8	4.5	56	6	A	—
EP4M40185-PN	□	1.85	4.8	56	6	A	—
EP4M4019-PN	□	1.9	4.8	56	6	A	—
EP4M40195-PN	□	1.95	5	56	6	A	—
EP4M4020-PN	●	2	5	56	6	A	7,500
EP4M40205-PN	□	2.05	5.3	56	6	A	—
EP4M4021-PN	□	2.1	5.3	56	6	A	—
EP4M40215-PN	□	2.15	5.5	56	6	A	—
EP4M4022-PN	□	2.2	5.5	56	6	A	—
EP4M40225-PN	□	2.25	5.8	56	6	A	—
EP4M4023-PN	□	2.3	5.8	56	6	A	—
EP4M40235-PN	□	2.35	6	56	6	A	—
EP4M4024-PN	□	2.4	6	56	6	A	—
EP4M40245-PN	□	2.45	6.3	56	6	A	—
EP4M4025-PN	□	2.5	6.3	56	6	A	—
EP4M40255-PN	□	2.55	6.5	56	6	A	—
EP4M4026-PN	□	2.6	6.5	56	6	A	—
EP4M40265-PN	□	2.65	6.8	56	6	A	—
EP4M4027-PN	□	2.7	6.8	56	6	A	—
EP4M40275-PN	□	2.75	7	56	6	A	—
EP4M4028-PN	□	2.8	7	56	6	A	—
EP4M40285-PN	□	2.85	7.3	56	6	A	—
EP4M4029-PN	□	2.9	7.3	56	6	A	—
EP4M40295-PN	□	2.95	7.5	56	6	A	—
EP4M4030-PN	●	3	7.5	56	6	A	7,500
EP4M40305-PN	□	3.05	7.8	56	6	A	—
EP4M4031-PN	□	3.1	7.8	56	6	A	—
EP4M40315-PN	□	3.15	8	56	6	A	—
EP4M4032-PN	□	3.2	8	56	6	A	—
EP4M40325-PN	□	3.25	8.3	56	6	A	—
EP4M4033-PN	□	3.3	8.3	56	6	A	—
EP4M40335-PN	□	3.35	8.5	56	6	A	—
EP4M4034-PN	□	3.4	8.5	56	6	A	—
EP4M40345-PN	□	3.45	8.8	56	6	A	—
EP4M4035-PN	□	3.5	8.8	56	6	A	—
EP4M40355-PN	□	3.55	9	56	6	A	—
EP4M4036-PN	□	3.6	9	56	6	A	—
EP4M40365-PN	□	3.65	9.3	56	6	A	—
EP4M4037-PN	□	3.7	9.3	56	6	A	—

ステンレス鋼、炭素鋼、合金鋼等の荒～仕上げ加工までマルチに対応。
Multi-purpose for roughing to finishing of stainless steel, carbon steel, alloy steel, etc.

ラジウスはA235頁を参照してください
Please refer to page A235 for Radius

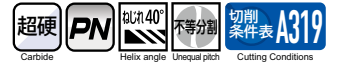
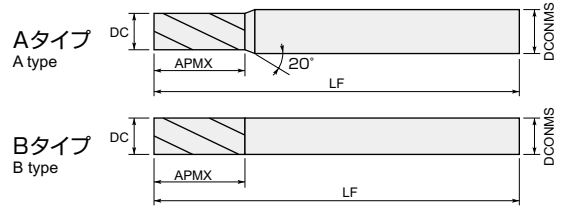

商品コード Item code	在庫 Stock	寸法 Size(mm)				形状 Shape	希望小売 価格(円) Suggested retail price(¥)
		外径 Tool dia. DC	刃長 Flute length APMX	全長 Overall length LF	シャンク径 Shank dia. DCONMS		
EP4M40375-PN	□	3.75	9.5	56	6	A	—
EP4M4038-PN	□	3.8	9.5	56	6	A	—
EP4M40385-PN	□	3.85	9.8	56	6	A	—
EP4M4039-PN	□	3.9	9.8	56	6	A	—
EP4M40395-PN	□	3.95	10	56	6	A	—
EP4M4040-PN	●	4	10	56	6	A	7,890
EP4M40405-PN	□	4.05	10.3	56	6	A	—
EP4M4041-PN	□	4.1	10.3	56	6	A	—
EP4M40415-PN	□	4.15	10.5	56	6	A	—
EP4M4042-PN	□	4.2	10.5	56	6	A	—
EP4M40425-PN	□	4.25	10.8	56	6	A	—
EP4M4043-PN	□	4.3	10.8	56	6	A	—
EP4M40435-PN	□	4.35	11	56	6	A	—
EP4M4044-PN	□	4.4	11	56	6	A	—
EP4M40445-PN	□	4.45	11.3	56	6	A	—
EP4M4045-PN	□	4.5	11.3	56	6	A	—
EP4M40455-PN	□	4.55	11.5	56	6	A	—
EP4M4046-PN	□	4.6	11.5	56	6	A	—
EP4M40465-PN	□	4.65	11.8	56	6	A	—
EP4M4047-PN	□	4.7	11.8	56	6	A	—
EP4M40475-PN	□	4.75	12	56	6	A	—
EP4M4048-PN	□	4.8	12	56	6	A	—
EP4M40485-PN	□	4.85	12.3	56	6	A	—
EP4M4049-PN	□	4.9	12.3	56	6	A	—
EP4M40495-PN	□	4.95	12.5	56	6	A	—
EP4M4050-PN	●	5	12.5	56	6	A	8,820
EP4M40505-PN	□	5.05	12.8	56	6	A	—
EP4M4051-PN	□	5.1	12.8	56	6	A	—
EP4M40515-PN	□	5.15	13	56	6	A	—
EP4M4052-PN	□	5.2	13	56	6	A	—
EP4M40525-PN	□	5.25	13.3	56	6	A	—
EP4M4053-PN	□	5.3	13.3	56	6	A	—
EP4M40535-PN	□	5.35	13.5	56	6	A	—
EP4M4054-PN	□	5.4	13.5	56	6	A	—
EP4M40545-PN	□	5.45	13.8	56	6	A	—
EP4M4055-PN	□	5.5	13.8	56	6	A	—
EP4M40555-PN	□	5.55	14	56	6	A	—
EP4M4056-PN	□	5.6	14	56	6	A	—
EP4M40565-PN	□	5.65	14.3	56	6	A	—
EP4M4057-PN	□	5.7	14.3	56	6	A	—
EP4M40575-PN	□	5.75	14.5	56	6	A	—
EP4M4058-PN	□	5.8	14.5	56	6	A	—
EP4M40585-PN	□	5.85	14.8	56	6	A	—
EP4M4059-PN	□	5.9	14.8	56	6	A	—
EP4M40595-PN	□	5.95	15	56	6	A	—
EP4M4060-PN	●	6	15	56	6	B	9,610
EP4M40605-PN	□	6.05	15.3	63	8	A	—
EP4M4061-PN	□	6.1	15.3	63	8	A	—
EP4M40615-PN	□	6.15	15.5	63	8	A	—
EP4M4062-PN	□	6.2	15.5	63	8	A	—
EP4M40625-PN	□	6.25	15.8	63	8	A	—
EP4M4063-PN	□	6.3	15.8	63	8	A	—
EP4M40635-PN	□	6.35	16	63	8	A	—
EP4M4064-PN	□	6.4	16	63	8	A	—
EP4M40645-PN	□	6.45	16.3	63	8	A	—

●印：標準在庫品です。●：Stocked items. □印：特定代理店在庫です。弊社営業へお問合せください。□：Stocked by specified distributor. Contact with our sales department.

Carbide End Mills
Square End Mills

EP4SM0000-PN

超硬合金ドリル
スクエアシャンクドリル

商品コード Item code	在庫 Stock	寸法 Size(mm)				形状 Shape	希望小売 価格(円) Suggested retail price(¥)
		外径 Tool dia.	刃長 Flute length	全長 Overall length	シャンク径 Shank dia.		
		DC	APMX	LF	DCONMS		
EP4SM065-PN	<input type="checkbox"/>	6.5	16.3	63	8	A	—
EP4SM0655-PN	<input type="checkbox"/>	6.55	16.5	63	8	A	—
EP4SM066-PN	<input type="checkbox"/>	6.6	16.5	63	8	A	—
EP4SM0665-PN	<input type="checkbox"/>	6.65	16.8	63	8	A	—
EP4SM067-PN	<input type="checkbox"/>	6.7	16.8	63	8	A	—
EP4SM0675-PN	<input type="checkbox"/>	6.75	17	63	8	A	—
EP4SM068-PN	<input type="checkbox"/>	6.8	17	63	8	A	—
EP4SM0685-PN	<input type="checkbox"/>	6.85	17.3	63	8	A	—
EP4SM069-PN	<input type="checkbox"/>	6.9	17.3	63	8	A	—
EP4SM0695-PN	<input type="checkbox"/>	6.95	17.5	63	8	A	—
EP4SM070-PN	<input checked="" type="checkbox"/>	7	17.5	63	8	A	11,910
EP4SM0705-PN	<input type="checkbox"/>	7.05	17.8	63	8	A	—
EP4SM071-PN	<input type="checkbox"/>	7.1	17.8	63	8	A	—
EP4SM0715-PN	<input type="checkbox"/>	7.15	18	63	8	A	—
EP4SM072-PN	<input type="checkbox"/>	7.2	18	63	8	A	—
EP4SM0725-PN	<input type="checkbox"/>	7.25	18.3	63	8	A	—
EP4SM073-PN	<input type="checkbox"/>	7.3	18.3	63	8	A	—
EP4SM0735-PN	<input type="checkbox"/>	7.35	18.5	63	8	A	—
EP4SM074-PN	<input type="checkbox"/>	7.4	18.5	63	8	A	—
EP4SM0745-PN	<input type="checkbox"/>	7.45	18.8	63	8	A	—
EP4SM075-PN	<input type="checkbox"/>	7.5	18.8	63	8	A	—
EP4SM0755-PN	<input type="checkbox"/>	7.55	19	63	8	A	—
EP4SM076-PN	<input type="checkbox"/>	7.6	19	63	8	A	—
EP4SM0765-PN	<input type="checkbox"/>	7.65	19.3	63	8	A	—
EP4SM077-PN	<input type="checkbox"/>	7.7	19.3	63	8	A	—
EP4SM0775-PN	<input type="checkbox"/>	7.75	19.5	63	8	A	—
EP4SM078-PN	<input type="checkbox"/>	7.8	19.5	63	8	A	—
EP4SM0785-PN	<input type="checkbox"/>	7.85	19.8	63	8	A	—
EP4SM079-PN	<input type="checkbox"/>	7.9	19.8	63	8	A	—
EP4SM0795-PN	<input type="checkbox"/>	7.95	20	63	8	A	—
EP4SM080-PN	<input checked="" type="checkbox"/>	8	20	63	8	B	11,910
EP4SM0805-PN	<input type="checkbox"/>	8.05	20.3	74	10	A	—
EP4SM081-PN	<input type="checkbox"/>	8.1	20.3	74	10	A	—
EP4SM0815-PN	<input type="checkbox"/>	8.15	20.5	74	10	A	—
EP4SM082-PN	<input type="checkbox"/>	8.2	20.5	74	10	A	—
EP4SM0825-PN	<input type="checkbox"/>	8.25	20.8	74	10	A	—
EP4SM083-PN	<input type="checkbox"/>	8.3	20.8	74	10	A	—
EP4SM0835-PN	<input type="checkbox"/>	8.35	21	74	10	A	—
EP4SM084-PN	<input type="checkbox"/>	8.4	21	74	10	A	—
EP4SM0845-PN	<input type="checkbox"/>	8.45	21.3	74	10	A	—
EP4SM085-PN	<input type="checkbox"/>	8.5	21.3	74	10	A	—
EP4SM0855-PN	<input type="checkbox"/>	8.55	21.5	74	10	A	—
EP4SM086-PN	<input type="checkbox"/>	8.6	21.5	74	10	A	—
EP4SM0865-PN	<input type="checkbox"/>	8.65	21.8	74	10	A	—
EP4SM087-PN	<input type="checkbox"/>	8.7	21.8	74	10	A	—
EP4SM0875-PN	<input type="checkbox"/>	8.75	22	74	10	A	—
EP4SM088-PN	<input type="checkbox"/>	8.8	22	74	10	A	—
EP4SM0885-PN	<input type="checkbox"/>	8.85	22.3	74	10	A	—
EP4SM089-PN	<input type="checkbox"/>	8.9	22.3	74	10	A	—
EP4SM0895-PN	<input type="checkbox"/>	8.95	22.5	74	10	A	—
EP4SM090-PN	<input checked="" type="checkbox"/>	9	22.5	74	10	A	16,160
EP4SM0905-PN	<input type="checkbox"/>	9.05	22.8	74	10	A	—
EP4SM091-PN	<input type="checkbox"/>	9.1	22.8	74	10	A	—
EP4SM0915-PN	<input type="checkbox"/>	9.15	23	74	10	A	—
EP4SM092-PN	<input type="checkbox"/>	9.2	23	74	10	A	—

商品コード Item code	在庫 Stock	寸法 Size(mm)				形状 Shape	希望小売 価格(円) Suggested retail price(¥)
		外径 Tool dia.	刃長 Flute length	全長 Overall length	シャンク径 Shank dia.		
		DC	APMX	LF	DCONMS		
EP4SM0925-PN	<input type="checkbox"/>	9.25	23.3	74	10	A	—
EP4SM093-PN	<input type="checkbox"/>	9.3	23.3	74	10	A	—
EP4SM0935-PN	<input type="checkbox"/>	9.35	23.5	74	10	A	—
EP4SM094-PN	<input type="checkbox"/>	9.4	23.5	74	10	A	—
EP4SM0945-PN	<input type="checkbox"/>	9.45	23.8	74	10	A	—
EP4SM095-PN	<input type="checkbox"/>	9.5	23.8	74	10	A	—
EP4SM0955-PN	<input type="checkbox"/>	9.55	24	74	10	A	—
EP4SM096-PN	<input type="checkbox"/>	9.6	24	74	10	A	—
EP4SM0965-PN	<input type="checkbox"/>	9.65	24.3	74	10	A	—
EP4SM097-PN	<input type="checkbox"/>	9.7	24.3	74	10	A	—
EP4SM0975-PN	<input type="checkbox"/>	9.75	24.5	74	10	A	—
EP4SM098-PN	<input type="checkbox"/>	9.8	24.5	74	10	A	—
EP4SM0985-PN	<input type="checkbox"/>	9.85	24.8	74	10	A	—
EP4SM099-PN	<input type="checkbox"/>	9.9	24.8	74	10	A	—
EP4SM0995-PN	<input type="checkbox"/>	9.95	25	74	10	A	—
EP4SM100-PN	<input checked="" type="checkbox"/>	10	25	74	10	B	16,160
EP4SM101-PN	<input type="checkbox"/>	10.1	25.3	86	12	A	—
EP4SM102-PN	<input type="checkbox"/>	10.2	25.5	86	12	A	—
EP4SM103-PN	<input type="checkbox"/>	10.3	25.8	86	12	A	—
EP4SM104-PN	<input type="checkbox"/>	10.4	26	86	12	A	—
EP4SM105-PN	<input type="checkbox"/>	10.5	26.3	86	12	A	—
EP4SM106-PN	<input type="checkbox"/>	10.6	26.5	86	12	A	—
EP4SM107-PN	<input type="checkbox"/>	10.7	26.8	86	12	A	—
EP4SM108-PN	<input type="checkbox"/>	10.8	27	86	12	A	—
EP4SM109-PN	<input type="checkbox"/>	10.9	27.3	86	12	A	—
EP4SM110-PN	<input checked="" type="checkbox"/>	11	27.5	86	12	A	20,090
EP4SM111-PN	<input type="checkbox"/>	11.1	27.8	86	12	A	—
EP4SM112-PN	<input type="checkbox"/>	11.2	28	86	12	A	—
EP4SM113-PN	<input type="checkbox"/>	11.3	28.3	86	12	A	—
EP4SM114-PN	<input type="checkbox"/>	11.4	28.5	86	12	A	—
EP4SM115-PN	<input type="checkbox"/>	11.5	28.8	86	12	A	—
EP4SM116-PN	<input type="checkbox"/>	11.6	29	86	12	A	—
EP4SM117-PN	<input type="checkbox"/>	11.7	29.3	86	12	A	—
EP4SM118-PN	<input type="checkbox"/>	11.8	29.5	86	12	A	—
EP4SM119-PN	<input type="checkbox"/>	11.9	29.8	86	12	A	—
EP4SM120-PN	<input checked="" type="checkbox"/>	12	30	86	12	B	20,090
EP4SM125-PN	<input type="checkbox"/>	12.5	31.3	105	16	A	—
EP4SM130-PN	<input type="checkbox"/>	13	32.5	105	16	A	—
EP4SM135-PN	<input type="checkbox"/>	13.5	33.8	105	16	A	—
EP4SM140-PN	<input type="checkbox"/>	14	35	105	16	A	—
EP4SM145-PN	<input type="checkbox"/>	14.5	36.3	110	16	A	—
EP4SM150-PN	<input type="checkbox"/>	15	37.5	110	16	A	—
EP4SM155-PN	<input type="checkbox"/>	15.5	38.8	110	16	A	—
EP4SM160-PN	<input checked="" type="checkbox"/>	16	40	110	16	B	45,050
EP4SM165-PN	<input type="checkbox"/>	16.5	41.3	120	20	A	—
EP4SM170-PN	<input type="checkbox"/>	17	42.5	120	20	A	—
EP4SM175-PN	<input type="checkbox"/>	17.5	43.8	120	20	A	—
EP4SM180-PN	<input type="checkbox"/>	18	45	120	20	A	—
EP4SM185-PN	<input type="checkbox"/>	18.5	46.3	125	20	A	—
EP4SM190-PN	<input type="checkbox"/>	19	47.5	125	20	A	—
EP4SM195-PN	<input type="checkbox"/>	19.5	48.8	125	20	A	—
EP4SM200-PN	<input checked="" type="checkbox"/>	20	50	125	20	B	65,460

EP4SM, EP4SM-M, EP4SM-Lの対応被削材

Applicable work material of EP4SM-PN, EP4SM-M-PN, EP4SM-L-PN

炭素鋼 合金鋼 Carbon steel Alloy steel	プリハー ド鋼 Pre-hardened steel	高硬度 Hardened steel			ステン レス鋼 Stainless steel	チタン合金 耐熱合金 Titanium alloy Heat-resistant alloy	銅合金 Copper alloy	アルミ 合金 Aluminum alloy
		> 45HRC ≤ 55HRC	> 55HRC ≤ 65HRC	> 65HRC				
<input type="checkbox"/>	<input type="checkbox"/>	<input type="checkbox"/>	<input type="checkbox"/>	<input type="checkbox"/>	<input type="checkbox"/>	<input type="checkbox"/>	<input type="checkbox"/>	

●印：標準在庫品です。
●： Stocked items.

□印：特定代理店在庫です。弊社営業へお問合せください。
□： Stocked by specified distributor. Contact with our sales department.

再研磨対応外径範囲

Re-grinding compatibility range

商品コード Item code	外周 Outer dia. (mm)	エンド End (mm)
EP4SM-PN	6 ~ 20	4 ~ 20
EP4SM-M-PN	6 ~ 20	4 ~ 20
EP4SM-L-PN	6 ~ 20	6 ~ 20

ミディウム刃長

Medium



φ3~φ6 : 0~-0.015
φ7~φ20 : 0~-0.02

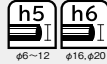

(mm)

4枚刃
4 Flutes



ステンレス鋼、炭素鋼、合金鋼等の荒~仕上げ加工までマルチに対応。
Multi-purpose for roughing to finishing of stainless steel, carbon steel, alloy steel, etc.

ラジウスはA235頁を参照してください
Please refer to page A235 for Radius

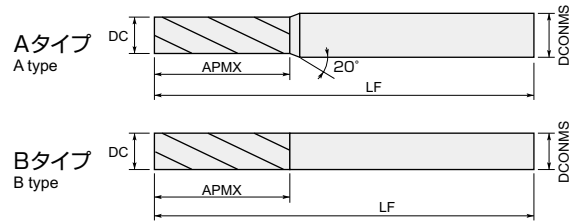

EPSMM4 ϕ -PN

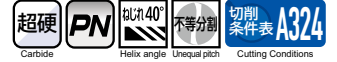

商品コード Item code	在庫 Stock	寸法 Size(mm)				形状 Shape	希望小売 価格(円) Suggested retail price(¥)
		外径 Tool dia.	刃長 Flute length	全長 Overall length	シャンク径 Shank dia.		
		DC	APMX	LF	DCONMS		
EPSMM4030-PN	●	3	12	56	6	A	8,930
EPSMM4040-PN	●	4	16	56	6	A	9,490
EPSMM4050-PN	●	5	20	70	6	A	10,530
EPSMM4060-PN	●	6	24	70	6	B	11,570
EPSMM4070-PN	●	7	28	75	8	A	14,150
EPSMM4080-PN	●	8	32	80	8	B	14,150

商品コード Item code	在庫 Stock	寸法 Size(mm)				形状 Shape	希望小売 価格(円) Suggested retail price(¥)
		外径 Tool dia.	刃長 Flute length	全長 Overall length	シャンク径 Shank dia.		
		DC	APMX	LF	DCONMS		
EPSMM4090-PN	●	9	36	100	10	A	18,970
EPSMM4100-PN	●	10	40	100	10	B	18,970
EPSMM4110-PN	●	11	44	120	12	A	23,910
EPSMM4120-PN	●	12	48	120	12	B	23,910
EPSMM4160-PN	●	16	64	135	16	B	54,430
EPSMM4200-PN	●	20	80	155	20	B	79,540

ロング刃長

Long



φ6 : 0~-0.015
φ7~φ20 : 0~-0.02

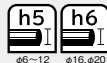

(mm)

4枚刃
4 Flutes



ステンレス鋼、炭素鋼、合金鋼等の荒~仕上げ加工までマルチに対応。
Multi-purpose for roughing to finishing of stainless steel, carbon steel, alloy steel, etc.

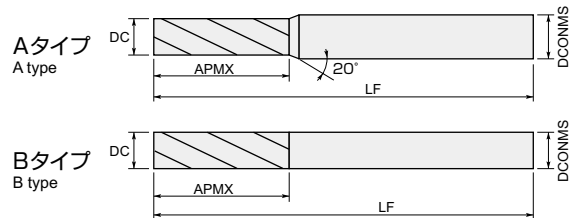

EPSML4 ϕ -PN



商品コード Item code	在庫 Stock	寸法 Size(mm)				刃数 No. of flutes	形状 Shape	希望小売価格(円) Suggested retail price(¥)
		外径 Tool dia.	刃長 Flute length	全長 Overall length	シャンク径 Shank dia.			
		DC	APMX	LF	DCONMS			
EPSML4060-PN	●	6	30	70	6	4	B	16,270
EPSML4070-PN	□	7	35	80	8	4	A	—
EPSML4080-PN	●	8	40	80	8	4	B	20,200
EPSML4090-PN	□	9	45	100	10	4	A	—
EPSML4100-PN	●	10	50	100	10	4	B	27,490
EPSML4110-PN	□	11	55	120	12	4	A	—
EPSML4120-PN	●	12	60	120	12	4	B	34,120
EPSML4130-PN	□	13	65	130	16	4	A	—
EPSML4140-PN	□	14	70	130	16	4	A	—
EPSML4150-PN	□	15	75	130	16	4	A	—
EPSML4160-PN	●	16	80	135	16	4	B	76,610
EPSML4170-PN	□	17	85	135	20	4	A	—
EPSML4180-PN	□	18	90	145	20	4	A	—
EPSML4190-PN	□	19	95	145	20	4	A	—
EPSML4200-PN	●	20	100	155	20	4	B	111,320

Epoch SUS Multi エポックSUSマルチ



ロングシャンク Long shank

ステンレス鋼、炭素鋼、合金鋼等の荒～仕上げ加工までマルチに対応。
Multi-purpose for roughing to finishing of stainless steel, carbon steel, alloy steel, etc.

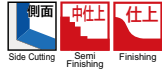

外径公差 Dia. tolerance	φ3~φ6 : 0~-0.015 φ7~φ17 : 0~-0.02	h5 DC3~5	h6 DC6~17	(mm)
------------------------	--------------------------------------	-------------	--------------	------

ラジウスはA235頁を参照してください
Please refer to page A235 for Radius

超硬
エポックSUSマルチ
スクエアエンドミル

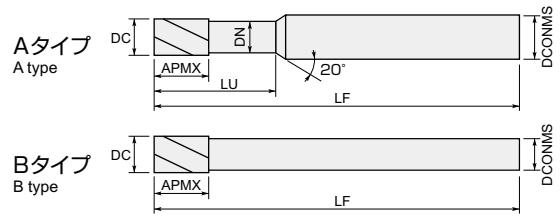

EPSMLS4-PPN

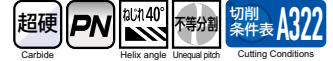

商品コード Item code	在庫 Stock	寸法 Size(mm)						刃数 No. of flutes	形状 Shape	希望小売価格(円) Suggested retail price(¥)
		外径 Tool dia.	刃長 Flute length	首下長 Under neck length	首径 Neck dia.	全長 Overall length	シャンク径 Shank dia.			
		DC	APMX	LU	DN	LF	DCONMS			
EPSMLS4030-PN	●	3	4.5	10.5	2.88	80	6	4	A	10,210
EPSMLS4040-PN	●	4	6	14	3.7	80	6	4	A	10,710
EPSMLS4050-PN	●	5	7.5	17.5	4.6	100	6	4	A	12,910
EPSMLS4060-PN	●	6	9	-	-	120	5	4	B	14,590
EPSMLS4070-PN	●	7	9	-	-	120	6	4	B	18,080
EPSMLS4080-PN	●	8	12	-	-	135	7	4	B	18,080
EPSMLS4090-PN	●	9	12	-	-	135	8	4	B	24,130
EPSMLS4100-PN	●	10	15	-	-	150	9	4	B	24,130
EPSMLS4110-PN	●	11	15	-	-	150	10	4	B	30,300
EPSMLS4120-PN	●	12	18	-	-	160	11	4	B	30,300
EPSMLS4130-PN	●	13	18	-	-	160	12	4	B	35,910
EPSMLS4160-PN	●	16	24	-	-	180	15	4	B	66,870
EPSMLS4170-PN	●	17	24	-	-	180	16	4	B	66,870

●印：標準在庫品です。
●：Stocked items.

□印：特定代理店在庫です。弊社営業へお問合せください。
□：Stocked by specified distributor. Contact with our sales department.

首下3DC

Under neck 3DC



外径公差 Dia tolerance $\phi 1 \sim \phi 6 : 0 \sim -0.015$
 $\phi 6.5 \sim \phi 20 : 0 \sim -0.02$

h5 $\phi 6 \sim 12$ h6 $\phi 16, \phi 20$ (mm)

ステンレス鋼、炭素鋼、合金鋼等の荒～仕上げ加工までマルチに対応。
 Multi-purpose for roughing to finishing of stainless steel, carbon steel, alloy steel, etc.

4枚刃
4 Flutes

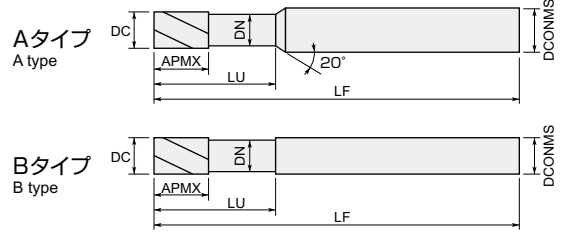

EPMS4-000-00.0-PN

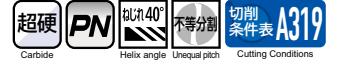

商品コード Item code	在庫 Stock	寸法 Size(mm)						刃数 No. of flutes	形状 Shape	希望小売価格(円) Suggested retail price(¥)
		外径 Tool dia.	刃長 Flute length	首下長 Under neck length	首径 Neck dia.	全長 Overall length	シャンク径 Shank dia.			
		DC	APMX	LU	DN	LF	DCONMS			
EPMS4010-3-PN	●	1	1.5	3	0.96	56	6	4	A	7,500
EPMS4015-4.5-PN	□	1.5	2.3	4.5	1.44	56	6	4	A	—
EPMS4020-6-PN	●	2	3	6	1.92	56	6	4	A	7,500
EPMS4025-7.5-PN	□	2.5	3.8	7.5	2.4	56	6	4	A	—
EPMS4030-9-PN	●	3	4.5	9	2.88	56	6	4	A	7,500
EPMS4035-10.5-PN	□	3.5	5.3	10.5	3.35	56	6	4	A	—
EPMS4040-12-PN	●	4	6	12	3.7	56	6	4	A	7,890
EPMS4045-13.5-PN	□	4.5	6.8	13.5	4.15	56	6	4	A	—
EPMS4050-15-PN	●	5	7.5	15	4.6	56	6	4	A	8,820
EPMS4055-16.5-PN	□	5.5	8.3	16.5	5.05	56	6	4	A	—
EPMS4060-18-PN	●	6	9	18	5.5	56	6	4	B	9,610
EPMS4065-19.5-PN	□	6.5	9.8	19.5	5.95	63	8	4	A	—
EPMS4070-21-PN	●	7	10.5	21	6.4	63	8	4	A	11,910
EPMS4075-22.5-PN	□	7.5	11.3	22.5	6.85	63	8	4	A	—
EPMS4080-24-PN	●	8	12	24	7.3	63	8	4	B	11,910
EPMS4085-25.5-PN	□	8.5	12.8	25.5	7.8	74	10	4	A	—
EPMS4090-27-PN	●	9	13.5	27	8.3	74	10	4	A	16,160
EPMS4095-28.5-PN	□	9.5	14.3	28.5	8.7	74	10	4	A	—
EPMS4100-30-PN	●	10	15	30	9.1	74	10	4	B	16,160
EPMS4105-31.5-PN	□	10.5	15.8	31.5	9.65	86	12	4	A	—
EPMS4110-33-PN	●	11	16.5	33	10.2	86	12	4	A	20,090
EPMS4115-34.5-PN	□	11.5	17.3	34.5	10.6	86	12	4	A	—
EPMS4120-36-PN	●	12	18	36	11	86	12	4	B	20,090
EPMS4130-39-PN	□	13	19.5	39	11.7	105	16	4	A	—
EPMS4140-42-PN	□	14	21	42	12.7	105	16	4	A	—
EPMS4150-45-PN	□	15	22.5	45	13.6	110	16	4	A	—
EPMS4160-48-PN	●	16	24	48	14.5	110	16	4	B	45,050
EPMS4170-51-PN	□	17	25.5	51	15.4	120	20	4	A	—
EPMS4180-54-PN	□	18	27	54	16.3	120	20	4	A	—
EPMS4190-57-PN	□	19	28.5	57	17.3	125	20	4	A	—
EPMS4200-60-PN	●	20	30	60	18.2	125	20	4	B	65,460

EPMSLS-PN、EPMS-3D-PN の対応被削材

Applicable work material of EPMSLS-PN, EPMS-3D-PN

炭素鋼 合金鋼 Carbon steel Alloy steel	プリハー ド鋼 Pre-hardened steel	高硬度 Hardened steel			ステン レス鋼 Stainless steel	チタン 合金 耐熱合金 Titanium alloy Heat-resistant alloy	銅合金 Copper alloy	アルミ 合金 Aluminum alloy
		> 45HRC ≤ 55HRC	> 55HRC ≤ 65HRC	> 65HRC				
○	○				○	○	○	

再研磨対応外径範囲

Re-grinding compatibility range

商品コード Item code	外周 Outer dia. (mm)	エンド End (mm)
EPMSLS-PN	6 ~ 17	4 ~ 17
EPMS-3DC-PN	6 ~ 20	4 ~ 20

Carbide End Mills
Square End Mills

Epoch SUS Finish / Multi エポックSUSマルチ



首下5DC Under neck 5DC



ステンレス鋼、炭素鋼、合金鋼等の荒～仕上げ加工までマルチに対応。
Multi-purpose for roughing to finishing of stainless steel, carbon steel, alloy steel, etc.

ラジラスはA235頁を参照してください
Please refer to page A235 for Radius

外径公差 Dia.tolerance	φ1~φ6 : 0~-0.015 φ6.5~φ20 : 0~-0.02	h5 φ6~12	h6 φ16, φ20	(mm)
-----------------------	--	-------------	----------------	------

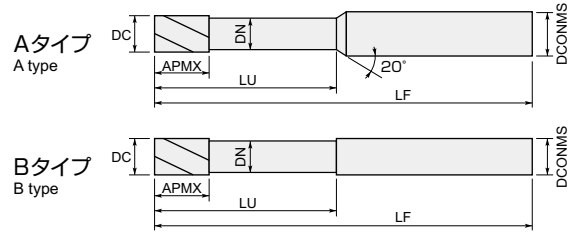

EP5DC-PN

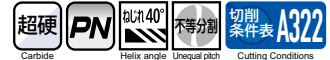

商品コード Item code	在庫 Stock	寸法 Size(mm)						刃数 No. of flutes	形状 Shape	希望小売価格(円) Suggested retail price(¥)
		外径 Tool dia.	刃長 Flute length	首下長 Under neck length	首径 Neck dia.	全長 Overall length	シャンク径 Shank dia.			
		DC	APMX	LU	DN	LF	DCONMS			
EP5DC010-5-PN	●	1	1.5	5	0.96	68	6	4	A	8,260
EP5DC015-7.5-PN	□	1.5	2.3	7.5	1.44	68	6	4	A	-
EP5DC020-10-PN	●	2	3	10	1.92	68	6	4	A	8,260
EP5DC025-12.5-PN	□	2.5	3.8	12.5	2.4	68	6	4	A	-
EP5DC030-15-PN	●	3	4.5	15	2.88	68	6	4	A	8,260
EP5DC035-17.5-PN	□	3.5	5.3	17.5	3.35	68	6	4	A	-
EP5DC040-20-PN	●	4	6	20	3.7	68	6	4	A	8,690
EP5DC045-22.5-PN	□	4.5	6.8	22.5	4.15	68	6	4	A	-
EP5DC050-25-PN	●	5	7.5	25	4.6	68	6	4	A	9,710
EP5DC055-27.5-PN	□	5.5	8.3	27.5	5.05	68	6	4	A	-
EP5DC060-30-PN	●	6	9	30	5.5	68	6	4	B	10,560
EP5DC065-32.5-PN	□	6.5	9.8	32.5	5.95	80	8	4	A	-
EP5DC070-35-PN	●	7	10.5	35	6.4	80	8	4	A	13,140
EP5DC075-37.5-PN	□	7.5	11.3	37.5	6.85	80	8	4	A	-
EP5DC080-40-PN	●	8	12	40	7.3	80	8	4	B	13,140
EP5DC085-42.5-PN	□	8.5	12.8	42.5	7.8	94	10	4	A	-
EP5DC090-45-PN	●	9	13.5	45	8.3	94	10	4	A	17,740
EP5DC095-47.5-PN	□	9.5	14.3	47.5	8.7	94	10	4	A	-
EP5DC100-50-PN	●	10	15	50	9.1	94	10	4	B	17,740
EP5DC105-52.5-PN	□	10.5	15.8	52.5	9.65	110	12	4	A	-
EP5DC110-55-PN	●	11	16.5	55	10.2	110	12	4	A	22,110
EP5DC115-57.5-PN	□	11.5	17.3	57.5	10.6	110	12	4	A	-
EP5DC120-60-PN	●	12	18	60	11	110	12	4	B	22,110
EP5DC130-65-PN	□	13	19.5	65	11.7	125	16	4	A	-
EP5DC140-70-PN	□	14	21	70	12.7	125	16	4	A	-
EP5DC150-75-PN	□	15	22.5	75	13.6	135	16	4	A	-
EP5DC160-80-PN	●	16	24	80	14.5	135	16	4	B	49,510
EP5DC170-85-PN	□	17	25.5	85	15.4	145	20	4	A	-
EP5DC180-90-PN	□	18	27	90	16.3	145	20	4	A	-
EP5DC190-95-PN	□	19	28.5	95	17.3	155	20	4	A	-
EP5DC200-100-PN	●	20	30	100	18.2	155	20	4	B	72,030

対応被削材 Applicable work material

炭素鋼 合金鋼 Carbon steel Alloy steel	プリハー ド鋼 Pre-hardened steel	高硬度 Hardened steel			ステン レス鋼 Stainless steel	チタン合金 耐熱合金 Titanium alloy Heat-resistant alloy	銅合金 Copper alloy	アルミ 合金 Aluminum alloy
		> 45HRC ≤ 55HRC	> 55HRC ≤ 65HRC	> 65HRC				
○	○	○	○	○	○	○	○	

再研磨対応外径範囲 Re-grinding compatibility range

商品コード Item code	外周 Outer dia. (mm)	エンド End (mm)
EP5DC-PN	6 ~ 20	4 ~ 20

標準切削条件表 Recommended cutting conditions

汎用 側面切削条件 General Side milling conditions

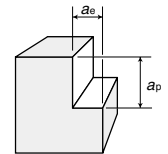

EPSMS※	EPSM	EPSM-3DC
ショート刃長 Short	レギュラー刃長 Regular	首下3DCタイプ Under neck 3DC

外径 DC Tool dia. (mm)	炭素鋼・合金鋼・鋳鉄 (~30HRC) Carbon steels, Alloy steels Cast irons		工具鋼・プリハードン鋼 (30~40HRC) Tool steels, Pre-hardened steels		ステンレス鋼 Stainless steels		チタン合金 Titanium alloys		超耐熱合金 Super heat-resistant alloys	
	$a_p=1DC, a_e=0.5DC$		$a_p=1DC, a_e=0.5DC$		$a_p=1DC, a_e=0.5DC$		$a_p=1DC, a_e=0.1DC$		$a_p=1DC, a_e=0.05DC$	
	回転数 n min ⁻¹	送り速度 v_f mm/min	回転数 n min ⁻¹	送り速度 v_f mm/min	回転数 n min ⁻¹	送り速度 v_f mm/min	回転数 n min ⁻¹	送り速度 v_f mm/min	回転数 n min ⁻¹	送り速度 v_f mm/min
1	31,800	760	22,300	360	19,100	310	12,700	150	9,500	76
1.5	21,200	780	14,900	370	12,700	310	8,500	160	6,400	79
2	15,900	810	11,100	380	9,500	320	6,400	160	4,800	82
2.5	12,700	830	8,900	390	7,600	330	5,100	170	3,800	83
3	10,600	860	7,400	400	6,400	350	4,200	170	3,200	86
3.5	9,100	880	6,400	410	5,500	350	3,600	170	2,700	87
4	8,000	910	5,600	430	4,800	360	3,200	180	2,400	91
4.5	7,100	930	5,000	440	4,200	370	2,800	180	2,100	92
5	6,400	960	4,500	450	3,800	380	2,500	190	1,900	95
5.5	5,800	960	4,100	450	3,500	380	2,300	190	1,700	93
6	5,300	950	3,700	440	3,200	380	2,100	190	1,600	96
6.5	4,900	960	3,400	440	2,900	380	2,000	200	1,500	97
7	4,500	940	3,200	450	2,700	380	1,800	190	1,400	98
7.5	4,200	940	3,000	450	2,500	370	1,700	190	1,300	97
8	4,000	960	2,800	450	2,400	380	1,600	190	1,200	96
8.5	3,700	940	2,600	440	2,200	370	1,500	190	1,100	93
9	3,500	940	2,500	450	2,100	380	1,400	190	1,100	99
9.5	3,400	970	2,300	440	2,000	380	1,300	190	1,000	95
10	3,200	960	2,200	440	1,900	380	1,300	200	1,000	100
10.5	3,000	920	2,100	430	1,800	370	1,200	180	900	92
11	2,900	910	2,000	420	1,700	360	1,200	190	900	94
11.5	2,800	890	1,900	400	1,700	360	1,100	170	800	85
12	2,700	870	1,900	410	1,600	350	1,100	180	800	86
13	2,400	820	1,700	390	1,500	340	1,000	170	700	80
14	2,300	840	1,600	390	1,400	340	900	160	700	85
15	2,100	810	1,500	390	1,300	340	800	150	600	77
16	2,000	820	1,400	380	1,200	330	800	160	600	82
17	1,900	800	1,300	370	1,100	310	700	150	600	85
18	1,800	800	1,200	350	1,100	320	700	150	500	74
19	1,700	780	1,200	370	1,000	310	700	160	500	77
20	1,600	770	1,100	350	1,000	320	600	140	500	80

※上表はレギュラー刃及び3DCタイプの切削条件表です。ショート刃をご使用の場合回転数・送り速度を1.1倍程度を目安に調整してください。
 ※The table above indicates cutting parameter for regular type and 3DC type, please reduce both rotation and feed rate to 1.1 times when using short type.

[注意] 本工具のPNコーティングはその性質上、通電性が微小です。従って、通電方式の工具長測定装置をご使用の際にはご注意ください。
 被削材、加工形状に合わせて、適切なクーラントを使用してください。
 できるだけ高剛性、高精度の機械及びチャックをご使用ください。
 この標準切削条件表は切削条件の目安を示すものです。実際の加工では、加工条件、目的、使用機械等により条件を調整してください。
 ビビリや異常振動が発生する場合は条件を調整してください。

[Note] PN coating is less electro conductive. Therefore, electric transmitted measuring systems may not work.
 Use the appropriate coolant for the work material and machining shape.
 Use the high-rigidity and high accuracy machine as possible.
 These Recommended Cutting Conditions indicate only the rule of a thumb for the cutting conditions. In actual machining, the condition should be adjusted according to the machining shape, purpose and the machine type.
 Please adjust it if chatter or abnormal vibration occurs.

Epoch SUS Finish / Multi エポックSUSマルチ

超硬合金チップ
スクエアエンドミル

高速 側面切削条件 High speed Side milling conditions

EPSMS※	EPSM	EPSM-3DC
ショート刃長 Short	レギュラー刃長 Regular	首下3DCタイプ Under neck 3DC

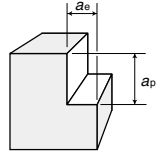

外径 DC Tool dia. (mm)	炭素鋼・合金鋼・鋳鉄 (~30HRC) Carbon steels, Alloy steels Cast irons		工具鋼・プリハードン鋼 (30~40HRC) Tool steels, Pre-hardened steels		ステンレス鋼 Stainless steels		チタン合金 Titanium alloys		超耐熱合金 Super heat-resistant alloys	
	$a_p=1DC, a_e=0.5DC$		$a_p=1DC, a_e=0.5DC$		$a_p=1DC, a_e=0.5DC$		$a_p=1DC, a_e=0.1DC$		$a_p=1DC, a_e=0.05DC$	
	回転数 n min ⁻¹	送り速度 v_f mm/min	回転数 n min ⁻¹	送り速度 v_f mm/min	回転数 n min ⁻¹	送り速度 v_f mm/min	回転数 n min ⁻¹	送り速度 v_f mm/min	回転数 n min ⁻¹	送り速度 v_f mm/min
1	41,400	990	31,800	510	28,600	460	19,100	230	15,900	127
1.5	27,600	1,020	21,200	520	19,100	470	12,700	230	10,600	130
2	20,700	1,060	15,900	540	14,300	490	9,500	240	8,000	136
2.5	16,600	1,080	12,700	550	11,500	500	7,600	250	6,400	139
3	13,800	1,120	10,600	570	9,500	510	6,400	260	5,300	143
3.5	11,800	1,140	9,100	590	8,200	530	5,500	270	4,500	145
4	10,300	1,170	8,000	610	7,200	550	4,800	270	4,000	152
4.5	9,200	1,200	7,100	620	6,400	560	4,200	270	3,500	153
5	8,300	1,250	6,400	640	5,700	570	3,800	280	3,200	160
5.5	7,500	1,240	5,800	640	5,200	570	3,500	290	2,900	160
6	6,900	1,240	5,300	640	4,800	580	3,200	290	2,700	162
6.5	6,400	1,250	4,900	640	4,400	570	2,900	280	2,400	156
7	5,900	1,240	4,500	630	4,100	570	2,700	280	2,300	161
7.5	5,500	1,240	4,200	630	3,800	570	2,500	280	2,100	158
8	5,200	1,250	4,000	640	3,600	580	2,400	290	2,000	160
8.5	4,900	1,250	3,700	630	3,400	580	2,200	280	1,900	162
9	4,600	1,240	3,500	630	3,200	580	2,100	280	1,800	162
9.5	4,400	1,250	3,400	650	3,000	570	2,000	280	1,700	162
10	4,100	1,230	3,200	640	2,900	580	1,900	290	1,600	160
10.5	3,900	1,190	3,000	610	2,700	550	1,800	270	1,500	153
11	3,800	1,190	2,900	610	2,600	540	1,700	270	1,400	146
11.5	3,600	1,140	2,800	590	2,500	530	1,700	270	1,400	148
12	3,400	1,100	2,700	580	2,400	520	1,600	260	1,300	140
13	3,200	1,100	2,400	550	2,200	500	1,500	260	1,200	137
14	3,000	1,100	2,300	560	2,000	490	1,400	260	1,100	134
15	2,800	1,080	2,100	540	1,900	490	1,300	250	1,100	142
16	2,600	1,060	2,000	540	1,800	490	1,200	240	1,000	136
17	2,400	1,020	1,900	540	1,700	480	1,100	230	900	127
18	2,300	1,020	1,800	530	1,600	470	1,100	240	900	133
19	2,200	1,020	1,700	520	1,500	460	1,000	230	800	123
20	2,100	1,010	1,600	510	1,400	450	1,000	240	800	128

※上表はレギュラー刃及び3DCタイプの切削条件表です。ショート刃をご使用の場合回転数・送り速度を1.1倍程度を目安に調整してください。
 ※The table above indicates cutting parameter for regular type and 3DC type, please reduce both rotation and feed rate to 1.1 times when using short type

[注意] 本工具のPNコーティングはその性質上、通電性が微小です。従って、通電方式の工具長測定装置をご使用の際にはご注意ください。
 被削材、加工形状に合わせて、適切なクーラントを使用してください。
 できるだけ高剛性、高精度の機械及びチャックをご使用ください。
 この標準切削条件表は切削条件の目安を示すものです。実際の加工では、加工条件、目的、使用機械等により条件を調整してください。
 ビビリや異常振動が発生する場合は条件を調整してください。

[Note] PN coating is less electro conductive. Therefore, electric transmitted measuring systems may not work.
 Use the appropriate coolant for the work material and machining shape.
 Use the high-rigidity and high accuracy machine as possible.
 These Recommended Cutting Conditions indicate only the rule of a thumb for the cutting conditions. In actual machining, the condition should be adjusted according to the machining shape, purpose and the machine type.
 Please adjust it if chatter or abnormal vibration occurs.

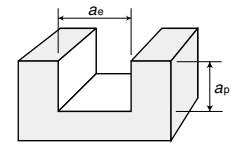

汎用 溝切削条件 General Slotting conditions

EPSMS* ショート刃長 Short	EPSM レギュラー刃長 Regular	EPSM-3DC 首下3DCタイプ Under neck 3DC
----------------------------------	-----------------------------------	---

外径 DC Tool dia. (mm)	炭素鋼・合金鋼・鋳鉄 (~30HRC) Carbon steels, Alloy steels Cast irons		工具鋼・プリハードン鋼 (30~40HRC) Tool steels, Pre-hardened steels		ステンレス鋼 Stainless steels		チタン合金 Titanium alloys		超耐熱合金 Super heat-resistant alloys	
	a _p =1DC		a _p =1DC		a _p =1DC		a _p =0.5DC		a _p =0.5DC	
	回転数 n min ⁻¹	送り速度 v _f mm/min	回転数 n min ⁻¹	送り速度 v _f mm/min	回転数 n min ⁻¹	送り速度 v _f mm/min	回転数 n min ⁻¹	送り速度 v _f mm/min	回転数 n min ⁻¹	送り速度 v _f mm/min
1	28,600	360	19,100	190	17,500	130	11,100	60	6,400	19
1.5	19,100	390	12,700	210	11,700	140	7,400	60	4,200	21
2	14,300	430	9,500	230	8,800	160	5,600	70	3,200	23
2.5	11,500	470	7,600	250	7,000	170	4,500	70	2,500	24
3	9,500	500	6,400	270	5,800	180	3,700	80	2,100	26
3.5	8,200	540	5,500	290	5,000	200	3,200	80	1,800	28
4	7,200	580	4,800	310	4,400	210	2,800	90	1,600	31
4.5	6,400	610	4,200	320	3,900	220	2,500	100	1,400	32
5	5,700	640	3,800	340	3,500	240	2,200	100	1,300	35
5.5	5,200	680	3,500	370	3,200	250	2,000	100	1,200	38
6	4,800	720	3,200	380	2,900	260	1,900	110	1,100	40
6.5	4,400	710	2,900	380	2,700	260	1,700	110	1,000	39
7	4,100	720	2,700	380	2,500	260	1,600	110	900	38
7.5	3,800	710	2,500	370	2,300	260	1,500	110	800	36
8	3,600	720	2,400	380	2,200	260	1,400	110	800	38
8.5	3,400	720	2,200	370	2,100	270	1,300	110	700	36
9	3,200	720	2,100	380	1,900	260	1,200	110	700	38
9.5	3,000	710	2,000	380	1,800	260	1,200	110	700	40
10	2,900	730	1,900	380	1,800	270	1,100	110	600	36
10.5	2,700	690	1,800	370	1,700	260	1,100	110	600	37
11	2,600	680	1,700	360	1,600	250	1,000	100	600	38
11.5	2,500	660	1,700	360	1,500	240	1,000	110	600	38
12	2,400	650	1,600	350	1,500	240	900	100	500	32
13	2,200	630	1,500	340	1,300	220	900	100	500	34
14	2,000	610	1,400	340	1,300	240	800	100	500	37
15	1,900	610	1,300	340	1,200	230	700	90	400	31
16	1,800	610	1,200	330	1,100	220	700	100	400	33
17	1,700	600	1,100	310	1,000	210	700	100	400	34
18	1,600	590	1,100	320	1,000	220	600	90	400	35
19	1,500	580	1,000	310	900	210	600	90	300	28
20	1,400	560	1,000	320	900	220	600	100	300	29

※上表はレギュラー刃及び3DCタイプの切削条件表です。ショート刃をご使用の場合回転数・送り速度を1.1倍程度を目安に調整してください。
 ※The table above indicates cutting parameter for regular type and 3DC type, please reduce both rotation and feed rate to 1.1 times when using short type.

[注意] 本工具のPNコーティングはその性質上、通電性が微小です。従って、通電方式の工具長測定装置をご使用の際にはご注意ください。
 被削材、加工形状に合わせて、適切なクーラントを使用してください。
 できるだけ高剛性、高精度の機械及びチャックをご使用ください。
 この標準切削条件表は切削条件の目安を示すものです。実際の加工では、加工条件、目的、使用機械等により条件を調整してください。
 ビビリや異常振動が発生する場合は条件を調整してください。
 座繰り加工を行う際に、送り速度を溝条件の1/5に、0.01DCのステップに設定してください。
 傾斜進入加工を行う際に、進入角度を3°以下、送り速度を溝条件の70%送りに設定してください。

[Note] PN coating is less electro conductive. Therefore, electric transmitted measuring systems may not work.
 Use the appropriate coolant for the work material and machining shape.
 Use the high-rigidity and high accuracy machine as possible.
 These Recommended Cutting Conditions indicate only the rule of a thumb for the cutting conditions. In actual machining, the condition should be adjusted according to the machining shape, purpose and the machine type.
 Please adjust it if chatter or abnormal vibration occurs.
 Please setup feed 1/5 that of slotting parameter and step 0.01DC for drilling application.
 Please setup feed 70% of slotting parameter and ramping angle 3° for ramping application.

Epoch SUS Finish / Multi エポックSUSマルチ

超硬合金ドリル
スクエアエンドミル

汎用 側面切削条件 General Side milling conditions

EPSMLS EPSM-5DC

ロングシャフト
Long shank

首下5DCタイプ
Under neck 5DC

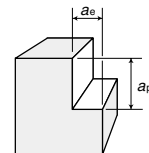

外径 DC Tool dia. (mm)	炭素鋼・合金鋼・鋳鉄 (~30HRC) Carbon steels, Alloy steels Cast irons		工具鋼・プリハードン鋼 (30~40HRC) Tool steels, Pre-hardened steels		ステンレス鋼 Stainless steels		チタン合金 Titanium alloys		超耐熱合金 Super heat-resistant alloys	
	$a_p=0.5DC, a_e=0.25DC$		$a_p=0.5DC, a_e=0.25DC$		$a_p=0.5DC, a_e=0.25DC$		$a_p=0.5DC, a_e=0.1DC$		$a_p=0.5DC, a_e=0.05DC$	
	回転数 n min ⁻¹	送り速度 v_f mm/min	回転数 n min ⁻¹	送り速度 v_f mm/min	回転数 n min ⁻¹	送り速度 v_f mm/min	回転数 n min ⁻¹	送り速度 v_f mm/min	回転数 n min ⁻¹	送り速度 v_f mm/min
1	28,600	690	19,100	310	15,900	250	12,700	150	9,500	76
1.5	19,100	710	12,700	320	10,600	260	8,500	160	6,400	80
2	14,300	730	9,500	320	8,000	270	6,400	160	4,800	82
2.5	11,500	760	7,600	330	6,400	280	5,100	170	3,800	84
3	9,500	770	6,400	350	5,300	290	4,200	170	3,200	86
3.5	8,200	800	5,500	360	4,500	290	3,600	180	2,700	88
4	7,200	820	4,800	360	4,000	300	3,200	180	2,400	91
4.5	6,400	850	4,200	370	3,500	310	2,800	190	2,100	93
5	5,700	860	3,800	380	3,200	320	2,500	190	1,900	95
5.5	5,200	860	3,500	390	2,900	320	2,300	190	1,700	94
6	4,800	860	3,200	380	2,700	320	2,100	190	1,600	96
6.5	4,400	860	2,900	380	2,400	310	2,000	200	1,500	98
7	4,100	860	2,700	380	2,300	320	1,800	190	1,400	98
7.5	3,800	860	2,500	380	2,100	320	1,700	190	1,300	98
8	3,600	860	2,400	380	2,000	320	1,600	190	1,200	96
8.5	3,400	870	2,200	370	1,900	320	1,500	190	1,100	94
9	3,200	860	2,100	380	1,800	320	1,400	190	1,100	99
9.5	3,000	860	2,000	380	1,700	320	1,300	190	1,000	95
10	2,900	870	1,900	380	1,600	320	1,300	200	1,000	100
10.5	2,700	830	1,800	370	1,500	310	1,200	190	900	93
11	2,600	820	1,700	360	1,400	290	1,200	190	900	94
11.5	2,500	800	1,700	360	1,400	300	1,100	180	800	86
12	2,400	780	1,600	350	1,300	280	1,100	180	800	86
13	2,200	760	1,500	350	1,200	280	1,000	170	700	81
14	2,000	740	1,400	340	1,100	270	900	170	700	86
15	1,900	740	1,300	340	1,100	280	800	150	600	77
16	1,800	730	1,200	330	1,000	270	800	160	600	82
17	1,700	730	1,100	310	900	260	700	150	600	86
18	1,600	720	1,100	330	900	270	700	160	500	75
19	1,500	690	1,000	310	800	250	700	160	500	77
20	1,400	670	1,000	320	800	260	600	140	500	80

※3 上表は5DCタイプおよび5DC突出した際の切削条件表です。工具突出し量により条件を調整してください。
 ※3 The above table shows cutting conditions for 5DC type tools with a 5DC overhang. Adjust conditions according to the tool overhang amount.

【注意】 本工具のPNコーティングはその性質上、通電性が微小です。従って、通電方式の工具長測定装置をご使用の際にはご注意ください。
 被削材、加工形状に合わせて、適切なクーラントを使用してください。
 できるだけ高剛性、高精度の機械及びチャックをご使用ください。
 この標準切削条件表は切削条件の目安を示すものです。実際の加工では、加工条件、目的、使用機械等により条件を調整してください。
 ビビリや異常振動が発生する場合は条件を調整してください。

【Note】 PN coating is less electro conductive. Therefore, electric transmitted measuring systems may not work.
 Use the appropriate coolant for the work material and machining shape.
 Use the high-rigidity and high accuracy machine as possible
 These Recommended Cutting Conditions indicate only the rule of a thumb for the cutting conditions. In actual machining, the condition should be adjusted according to the machining shape, purpose and the machine type.
 Please adjust it if chatter or abnormal vibration occurs.

汎用 溝切削条件 General Slotting conditions

EPSM-5DC

首下5DCタイプ
Under neck 5DC

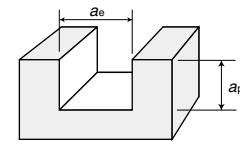

外径 DC Tool dia. (mm)	炭素鋼・合金鋼・鋳鉄 (~30HRC) Carbon steels, Alloy steels Cast irons		工具鋼・プリハードン鋼 (30~40HRC) Tool steels, Pre-hardened steels		ステンレス鋼 Stainless steels		チタン合金 Titanium alloys		超耐熱合金 Super heat-resistant alloys	
	ap=0.5DC		ap=0.5DC		ap=0.5DC		ap=0.25DC		ap=0.25DC	
	回転数 n min ⁻¹	送り速度 vf mm/min	回転数 n min ⁻¹	送り速度 vf mm/min	回転数 n min ⁻¹	送り速度 vf mm/min	回転数 n min ⁻¹	送り速度 vf mm/min	回転数 n min ⁻¹	送り速度 vf mm/min
1	25,500	320	15,900	160	14,300	110	9,500	50	4,800	14
1.5	17,000	350	10,600	170	9,500	120	6,400	50	3,200	16
2	12,700	380	8,000	190	7,200	130	4,800	60	2,400	17
2.5	10,200	410	6,400	210	5,700	140	3,800	60	1,900	19
3	8,500	450	5,300	220	4,800	150	3,200	70	1,600	20
3.5	7,300	480	4,500	240	4,100	160	2,700	70	1,400	22
4	6,400	510	4,000	260	3,600	170	2,400	80	1,200	23
4.5	5,700	550	3,500	270	3,200	180	2,100	80	1,100	25
5	5,100	570	3,200	290	2,900	200	1,900	90	1,000	27
5.5	4,600	600	2,900	300	2,600	200	1,700	90	900	28
6	4,200	630	2,700	320	2,400	220	1,600	100	800	29
6.5	3,900	630	2,400	310	2,200	210	1,500	100	700	27
7	3,600	630	2,300	320	2,000	210	1,400	100	700	29
7.5	3,400	640	2,100	320	1,900	210	1,300	100	600	27
8	3,200	640	2,000	320	1,800	220	1,200	100	600	29
8.5	3,000	640	1,900	320	1,700	220	1,100	90	600	31
9	2,800	630	1,800	320	1,600	220	1,100	100	500	27
9.5	2,700	640	1,700	320	1,500	210	1,000	100	500	29
10	2,500	630	1,600	320	1,400	210	1,000	100	500	30
10.5	2,400	620	1,500	310	1,400	220	900	90	500	31
11	2,300	600	1,400	290	1,300	200	900	90	400	25
11.5	2,200	590	1,400	300	1,200	190	800	90	400	26
12	2,100	570	1,300	280	1,200	190	800	90	400	26
13	2,000	580	1,200	280	1,100	190	700	80	400	28
14	1,800	550	1,100	270	1,000	180	700	90	300	22
15	1,700	550	1,100	280	1,000	190	600	80	300	23
16	1,600	540	1,000	270	900	180	600	80	300	24
17	1,500	540	900	260	800	170	600	90	300	26
18	1,400	520	900	270	800	180	500	70	300	27
19	1,300	500	800	250	800	180	500	80	300	28
20	1,300	520	800	260	700	170	500	80	200	19

【注意】 本工具のPNコーティングはその性質上、通電性が微小です。従って、通電方式の工具長測定装置をご使用の際にはご注意ください。
 被削材、加工形状に合わせて、適切なクーラントを使用してください。
 できるだけ高剛性、高精度の機械及びチャックをご使用ください。
 この標準切削条件表は切削条件の目安を示すものです。実際の加工では、加工条件、目的、使用機械等により条件を調整してください。
 ビビリや異常振動が発生する場合は条件を調整してください。
 座繰り加工を行う際に、送り速度を溝条件の1/5に、0.01DCのステップに設定してください。
 傾斜進入加工を行う際に、進入角度を3°以下、送り速度を溝条件の70%送りに設定してください。

【Note】 PN coating is less electro conductive. Therefore, electric transmitted measuring systems may not work.
 Use the appropriate coolant for the work material and machining shape.
 Use the high-rigidity and high accuracy machine as possible
 These Recommended Cutting Conditions indicate only the rule of a thumb for the cutting conditions. In actual machining, the condition should be adjusted according to the machining shape, purpose and the machine type.
 Please adjust it if chatter or abnormal vibration occurs.
 Please setup feed 1/5 that of slotting parameter and step 0.01DC for drilling application.
 Please setup feed 70% of slotting parameter and ramping angle 3° for ramping application.

汎用 側面切削条件

General Side milling conditions

EPSMM

ミディアム刃長
Medium

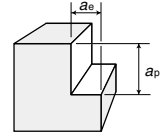

外径 DC Tool dia. (mm)	炭素鋼・合金鋼・鋳鉄 (~30HRC) Carbon steels, Alloy steels, Cast irons		工具鋼・プリハードン鋼 (30~40HRC) Tool steels, Pre-hardened steels		ステンレス鋼 Stainless steels		チタン合金 Titanium alloys		超耐熱合金 Super heat-resistant alloys	
	$a_p=2.5DC, a_e=0.05DC$		$a_p=2.5DC, a_e=0.05DC$		$a_p=2.5DC, a_e=0.05DC$		$a_p=2.5DC, a_e=0.03DC$		$a_p=2.5DC, a_e=0.02DC$	
	回転数 n min ⁻¹	送り速度 v_f mm/min	回転数 n min ⁻¹	送り速度 v_f mm/min	回転数 n min ⁻¹	送り速度 v_f mm/min	回転数 n min ⁻¹	送り速度 v_f mm/min	回転数 n min ⁻¹	送り速度 v_f mm/min
3	7,400	600	5,300	290	4,500	240	3,000	120	2,100	57
4	5,600	640	4,000	300	3,400	260	2,200	120	1,600	61
5	4,500	670	3,200	320	2,700	270	1,800	130	1,300	65
6	3,700	660	2,600	310	2,300	270	1,500	130	1,100	66
7	3,200	670	2,200	310	2,000	280	1,300	130	900	63
8	2,800	670	2,000	320	1,700	270	1,100	130	800	64
9	2,500	670	1,700	310	1,500	270	1,000	130	700	63
10	2,200	660	1,600	320	1,400	280	900	130	600	60
11	2,000	630	1,400	290	1,200	250	800	120	600	63
12	1,800	580	1,300	280	1,100	240	750	120	500	54
16	1,400	570	1,000	270	850	230	550	110	400	54
20	1,100	530	800	260	650	210	450	110	300	48

汎用 側面切削条件

General Side milling conditions

EPSML

ロング刃長
Long

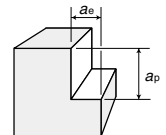

外径 DC Tool dia. (mm)	炭素鋼・合金鋼・鋳鉄 (~30HRC) Carbon steels, Alloy steels, Cast irons		工具鋼・プリハードン鋼 (30~40HRC) Tool steels, Pre-hardened steels		ステンレス鋼 Stainless steels		チタン合金 Titanium alloys		超耐熱合金 Super heat-resistant alloys	
	$a_p=3DC, a_e=0.05DC$		$a_p=3DC, a_e=0.05DC$		$a_p=3DC, a_e=0.05DC$		$a_p=3DC, a_e=0.02DC$		$a_p=3DC, a_e=0.01DC$	
	回転数 n min ⁻¹	送り速度 v_f mm/min	回転数 n min ⁻¹	送り速度 v_f mm/min	回転数 n min ⁻¹	送り速度 v_f mm/min	回転数 n min ⁻¹	送り速度 v_f mm/min	回転数 n min ⁻¹	送り速度 v_f mm/min
6	2,700	490	1,900	230	1,600	190	1,100	100	800	48
8	2,000	480	1,400	220	1,200	190	800	100	600	48
10	1,600	480	1,100	220	1,000	200	600	90	500	50
12	1,300	420	900	190	800	170	500	80	400	43
16	1,000	410	700	190	600	160	400	80	300	41
20	800	380	600	190	500	160	300	70	200	32

[注意] 本工具のPNコーティングはその性質上、通電性が微小です。従って、通電方式の工具長測定装置をご使用の際にはご注意ください。
被削材、加工形状に合わせて、適切なクーラントを使用してください。
できるだけ高剛性、高精度の機械及びチャックをご使用ください。
この標準切削条件表は切削条件の目安を示すものです。実際の加工では、加工条件、目的、使用機械等により条件を調整してください。
ビビリや異常振動が発生する場合は条件を調整してください。

[Note] PN coating is less electro conductive. Therefore, electric transmitted measuring systems may not work.
Use the appropriate coolant for the work material and machining shape.
Use the high-rigidity and high accuracy machine as possible
These Recommended Cutting Conditions indicate only the rule of a thumb for the cutting conditions. In actual machining, the condition should be adjusted according to the machining shape, purpose and the machine type.
Please adjust it if chatter or abnormal vibration occurs.

汎用 側面切削条件 General Side milling conditions

EPSF
レギュラー刃長
Regular

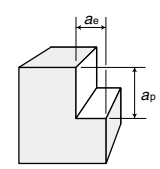

外径 DC Tool dia. (mm)	炭素鋼・合金鋼・鋳鉄 (~30HRC) Carbon steels, Alloy steels Cast irons		工具鋼・プリハードン鋼 (30~40HRC) Tool steels, Pre-hardened steels		ステンレス鋼 Stainless steels		チタン合金 Titanium alloys		超耐熱合金 Super heat-resistant alloys	
	$a_p=1.0DC, a_e=0.2DC$		$a_p=1.0DC, a_e=0.1DC$		$a_p=1.0DC, a_e=0.1DC$		$a_p=1.0DC, a_e=0.05DC$		$a_p=1.0DC, a_e=0.05DC$	
	回転数 n min ⁻¹	送り速度 v_f mm/min	回転数 n min ⁻¹	送り速度 v_f mm/min	回転数 n min ⁻¹	送り速度 v_f mm/min	回転数 n min ⁻¹	送り速度 v_f mm/min	回転数 n min ⁻¹	送り速度 v_f mm/min
3	9,000	850	6,900	470	6,400	430	5,300	140	4,200	85
3.5	7,700	850	5,900	460	5,500	430	4,500	140	3,600	85
4	6,800	900	5,200	490	4,800	460	4,000	150	3,200	91
4.5	6,000	900	4,600	490	4,200	450	3,500	150	2,800	90
5	5,400	950	4,100	510	3,800	480	3,200	160	2,500	94
5.5	4,900	940	3,800	520	3,500	480	2,900	160	2,300	95
6	4,500	950	3,400	510	3,200	480	2,700	160	2,100	95
7	3,900	960	3,000	530	2,700	470	2,300	160	1,800	95
8	3,400	950	2,600	520	2,400	480	2,000	160	1,600	96
9	3,000	950	2,300	520	2,100	470	1,800	160	1,400	95
10	2,700	950	2,100	530	1,900	480	1,600	160	1,300	98
11	2,500	910	1,900	500	1,700	440	1,400	150	1,200	94
12	2,300	870	1,700	460	1,600	430	1,300	140	1,100	89

【注意】 本工具のPNコーティングはその性質上、通電性が低いため、通電方式の工具長測定装置を使用の際には注意してください。
被削材、加工形状に合わせて、適切なクーラントを使用してください。
この切削条件表は切削条件の目安を示すものです。実際の加工では、加工条件、目的、使用機械等により条件を調整してください。

【Note】 PN coating is less electro conductive. Therefore, electric transmitted measuring systems may not work.
Use the appropriate coolant for the work material and machining shape.
These Recommended Cutting Conditions indicate only the rule of a thumb for the cutting conditions. In actual machining, the condition should be adjusted according to the machining shape, purpose and the machine type.

側面仕上げ切削条件 Side finishing conditions

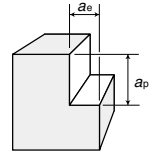

EPSF	EPSMS ^{※2}	EPSM	EPSM-3DC	EPSM-5DC ^{※2}
レギュラー刃長 Regular	ショート刃長 Short	レギュラー刃長 Regular	首下3DCタイプ Under neck 3DC	首下5DCタイプ Under neck 5DC

外径 DC Tool dia. (mm)	炭素鋼・合金鋼・鋳鉄 (~30HRC) Carbon steels, Alloy steels Cast irons		工具鋼・プリハードン鋼 (30~40HRC) Tool steels, Pre-hardened steels		ステンレス鋼 Stainless steels		チタン合金 Titanium alloys		超耐熱合金 Super heat-resistant alloys	
	$a_p=1DC, a_e=0.001\sim0.02DC$		$a_p=1DC, a_e=0.001\sim0.02DC$		$a_p=1DC, a_e=0.001\sim0.02DC$		$a_p=1DC, a_e=0.001\sim0.02DC$		$a_p=1DC, a_e=0.001\sim0.02DC$	
	回転数 n min ⁻¹	送り速度 v_f mm/min	回転数 n min ⁻¹	送り速度 v_f mm/min	回転数 n min ⁻¹	送り速度 v_f mm/min	回転数 n min ⁻¹	送り速度 v_f mm/min	回転数 n min ⁻¹	送り速度 v_f mm/min
1	45,500	980	35,000	500	31,500	450	21,000	230	17,500	130
1.5	30,300	1,010	23,300	520	21,000	460	14,000	230	11,700	130
2	22,800	1,050	17,500	540	15,800	480	10,500	240	8,800	130
2.5	18,200	1,070	14,000	550	12,600	490	8,400	250	7,000	140
3	15,200	1,110	11,700	570	10,500	510	7,000	260	5,800	140
3.5	13,000	1,130	10,000	580	9,000	520	6,000	260	5,000	140
4	11,400	1,170	8,800	600	7,900	540	5,300	270	4,400	150
4.5	10,100	1,190	7,800	610	7,000	550	4,700	280	3,900	150
5	9,100	1,230	7,000	630	6,300	570	4,200	280	3,500	160
5.5	8,300	1,230	6,400	630	5,700	560	3,800	280	3,200	160
6	7,600	1,230	5,800	630	5,300	570	3,500	280	2,900	160
6.5	7,000	1,230	5,400	630	4,800	560	3,200	280	2,700	160
7	6,500	1,230	5,000	630	4,500	570	3,000	280	2,500	160
7.5	6,100	1,240	4,700	630	4,200	570	2,800	280	2,300	160
8	5,700	1,230	4,400	630	3,900	560	2,600	280	2,200	160
8.5	5,400	1,240	4,100	630	3,700	570	2,500	290	2,100	160
9	5,100	1,240	3,900	630	3,500	570	2,300	280	1,900	150
9.5	4,800	1,230	3,700	630	3,300	560	2,200	280	1,800	150
10	4,600	1,240	3,500	630	3,200	580	2,100	280	1,800	160
10.5	4,300	1,180	3,300	600	3,000	550	2,000	270	1,700	160
11	4,100	1,160	3,200	600	2,900	550	1,900	270	1,600	150
11.5	4,000	1,140	3,000	570	2,700	510	1,800	260	1,500	140
12	3,800	1,110	2,900	560	2,600	510	1,800	260	1,500	150
13	3,500	1,080	2,700	560	2,400	490	1,600	250	1,300	130
14	3,300	1,090	2,500	550	2,300	500	1,500	250	1,300	140
15	3,000	1,040	2,300	530	2,100	490	1,400	240	1,200	140
16	2,800	1,030	2,200	540	2,000	490	1,300	240	1,100	130
17	2,700	1,030	2,100	530	1,900	480	1,200	230	1,000	130
18	2,500	1,000	1,900	500	1,800	480	1,200	240	1,000	130
19	2,400	1,000	1,800	500	1,700	470	1,100	230	900	120
20	2,300	990	1,800	520	1,600	460	1,100	240	900	130

※2 上表はレギュラー刃及び3DCタイプの切削条件表です。ショート刃をご使用の場合回転数・送り速度を1.1倍程度を目安に調整してください。5DCタイプをご使用の場合は回転数・送り速度を70%を目安に調整してください。

※2 The table above indicates cutting parameter for regular type and 3DC type, please reduce both rotation and feed rate to 1.1 times when using short type, please reduce both rotation and feed rate to 70% when using 5DC type

[注意] 本工具のPNコーティングはその性質上、通電性が微小です。従って、通電方式の工具長測定装置をご使用の際にはご注意ください。被削材、加工形状に合わせて、適切なクーラントを使用してください。できるだけ高剛性、高精度の機械及びチャックをご使用ください。この標準切削条件表は切削条件の目安を示すものです。実際の加工では、加工条件、目的、使用機械等により条件を調整してください。ビビリや異常振動が発生する場合は条件を調整してください。

[Note] PN coating is less electro conductive. Therefore, electric transmitted measuring systems may not work. Use the appropriate coolant for the work material and machining shape. Use the high-rigidity and high accuracy machine as possible. These Recommended Cutting Conditions indicate only the rule of a thumb for the cutting conditions. In actual machining, the condition should be adjusted according to the machining shape, purpose and the machine type. Please adjust it if chatter or abnormal vibration occurs.

側面仕上げ切削条件 Side finishing conditions

EPSFM
ミディアム刃長
Medium

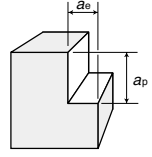

外径 DC Tool dia. (mm)	炭素鋼・合金鋼・鋳鉄 (~30HRC) Carbon steels, Alloy steels Cast irons		工具鋼・プリハードン鋼 (30~40HRC) Tool steels, Pre-hardened steels		ステンレス鋼 Stainless steels		チタン合金 Titanium alloys		超耐熱合金 Super heat-resistant alloys	
	$a_p=2.5DC, a_e=0.001DC\sim0.01DC$		$a_p=2.5DC, a_e=0.001DC\sim0.01DC$		$a_p=2.5DC, a_e=0.001DC\sim0.01DC$		$a_p=2.5DC, a_e=0.001DC\sim0.01DC$		$a_p=2.5DC, a_e=0.001DC\sim0.01DC$	
	回転数 n min ⁻¹	送り速度 v_f mm/min	回転数 n min ⁻¹	送り速度 v_f mm/min	回転数 n min ⁻¹	送り速度 v_f mm/min	回転数 n min ⁻¹	送り速度 v_f mm/min	回転数 n min ⁻¹	送り速度 v_f mm/min
3	7,070	480	4,060	250	4,830	290	4,830	180	2,940	71
4	5,320	510	3,080	260	3,640	310	3,640	190	2,240	77
5	4,200	530	2,450	280	2,870	320	2,870	190	1,750	79
6	3,500	530	2,030	270	2,380	320	2,380	190	1,470	79
7	3,010	530	1,750	280	2,100	330	2,100	200	1,260	79
8	2,660	530	1,540	280	1,820	330	1,820	200	1,120	81
9	2,380	540	1,330	270	1,610	330	1,610	200	980	79
10	2,100	530	1,260	280	1,470	330	1,470	200	910	82
11	1,890	490	1,120	260	1,330	310	1,330	190	840	79
12	1,750	470	1,050	260	1,190	290	1,190	170	770	75

側面仕上げ切削条件 Side finishing conditions

EPSFL
ロング刃長
Long

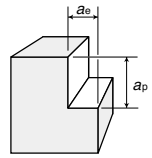

外径 DC Tool dia. (mm)	炭素鋼・合金鋼・鋳鉄 (~30HRC) Carbon steels, Alloy steels Cast irons		工具鋼・プリハードン鋼 (30~40HRC) Tool steels, Pre-hardened steels		ステンレス鋼 Stainless steels		チタン合金 Titanium alloys		超耐熱合金 Super heat-resistant alloys	
	$a_p=3DC, a_e=0.001DC\sim0.01DC$		$a_p=3DC, a_e=0.001DC\sim0.01DC$		$a_p=3DC, a_e=0.001DC\sim0.01DC$		$a_p=3DC, a_e=0.001DC\sim0.01DC$		$a_p=3DC, a_e=0.001DC\sim0.01DC$	
	回転数 n min ⁻¹	送り速度 v_f mm/min	回転数 n min ⁻¹	送り速度 v_f mm/min	回転数 n min ⁻¹	送り速度 v_f mm/min	回転数 n min ⁻¹	送り速度 v_f mm/min	回転数 n min ⁻¹	送り速度 v_f mm/min
3	5,050	340	2,900	180	3,450	210	3,450	130	2,100	51
4	3,800	360	2,200	190	2,600	220	2,600	130	1,600	55
5	3,000	380	1,750	200	2,050	230	2,050	140	1,250	56
6	2,500	380	1,450	200	1,700	230	1,700	140	1,050	57
7	2,150	380	1,250	200	1,500	240	1,500	140	900	57
8	1,900	380	1,100	200	1,300	230	1,300	140	800	58
9	1,700	380	950	190	1,150	230	1,150	140	700	57
10	1,500	380	900	200	1,050	240	1,050	140	650	59
11	1,350	350	800	190	950	220	950	130	600	56
12	1,250	340	750	180	850	210	850	120	550	53

[注意] 本工具のPNコーティングはその性質上、通電性が低いため、通電方式の工具長測定装置を使用の際には注意してください。
被削材、加工形状に合わせて、適切なクーラントを使用してください。
この切削条件表は切削条件の目安を示すものです。実際の加工では、加工条件、目的、使用機械等により条件を調整してください。

[Note] PN coating is less electro conductive. Therefore, electric transmitted measuring systems may not work.
Use the appropriate coolant for the work material and machining shape.
These Recommended Cutting Conditions indicate only the rule of a thumb for the cutting conditions. In actual machining, the condition should be adjusted according to the machining shape, purpose and the machine type.

Epoch TH Power Mill エポックTHパワーミル

高硬度材加工用。
切りくず排出性抜群で高効率が可能。
For machining of high-hardness materials. Excellent chip removal performance enables high efficiency.

ラジウスはA247頁を参照してください
Please refer to page A247 for Radius

ショート刃長 Short

外径公差 Dia. tolerance
 $\phi 3 \sim \phi 6$: 0 ~ -0.015
 $\phi 6.5 \sim \phi 20$: 0 ~ -0.02

(mm)

レギュラー刃長 Regular

外径公差 Dia. tolerance
 $\phi 3 \sim \phi 6$: 0 ~ -0.015
 $\phi 7 \sim \phi 20$: 0 ~ -0.02

(mm)



EPPS4-TH

超硬 TH 傾斜43° 切削条件表 A329
Carbide Helix angle Cutting Conditions

商品コード Item code	在庫 Stock	寸法 Size (mm)				希望小売 価格(円) Suggested retail price(¥)
		外径 Tool dia.	刃長 Flute length	全長 Overall length	シャンク径 Shank dia.	
EPPS4030-TH	●	3	4.5	60	6	10,420
EPPS4035-TH	●	3.5	5.3	60	6	10,940
EPPS4040-TH	●	4	6	60	6	10,940
EPPS4045-TH	●	4.5	6.8	60	6	12,240
EPPS4050-TH	●	5	7.5	60	6	12,240
EPPS4055-TH	●	5.5	8.3	60	6	13,140
EPPS4060-TH	●	6	9	60	6	13,140
EPPS4065-TH	●	6.5	9.8	70	8	17,520
EPPS4070-TH	●	7	10.5	70	8	17,520
EPPS4075-TH	●	7.5	11.3	75	8	19,530
EPPS4080-TH	●	8	12	75	8	16,160
EPPS4085-TH	●	8.5	12.8	80	10	22,440
EPPS4090-TH	●	9	13.5	80	10	22,440
EPPS4095-TH	●	9.5	14.3	80	10	25,810
EPPS4100-TH	●	10	15	80	10	21,770
EPPS4120-TH	●	12	18	100	12	27,490
EPPS4160-TH	●	16	24	110	16	63,230
EPPS4200-TH	●	20	30	125	20	92,330

EPP4-TH

超硬 TH 傾斜43° 切削条件表 A330
Carbide Helix angle Cutting Conditions

商品コード Item code	在庫 Stock	寸法 Size (mm)				希望小売 価格(円) Suggested retail price(¥)
		外径 Tool dia.	刃長 Flute length	全長 Overall length	シャンク径 Shank dia.	
EPP4030-TH	●	3	8	60	6	10,940
EPP4040-TH	●	4	11	60	6	11,470
EPP4050-TH	●	5	13	60	6	12,800
EPP4060-TH	●	6	13	60	6	14,030
EPP4070-TH	●	7	16	70	8	18,410
EPP4080-TH	●	8	19	75	8	17,180
EPP4090-TH	●	9	19	80	10	23,570
EPP4100-TH	●	10	22	80	10	23,130
EPP4110-TH	●	11	22	100	12	31,200
EPP4120-TH	●	12	26	100	12	28,960
EPP4130-TH	●	13	26	100	12	34,380
EPP4140-TH	●	14	26	110	16	52,440
EPP4150-TH	●	15	26	110	16	55,720
EPP4160-TH	●	16	32	110	16	66,640
EPP4170-TH	●	17	32	110	16	90,680
EPP4180-TH	●	18	32	125	20	88,220
EPP4190-TH	●	19	32	125	20	109,810
EPP4200-TH	●	20	38	125	20	97,250

ミディアム刃長 Medium

外径公差 Dia. tolerance
 $\phi 3 \sim \phi 6$: 0 ~ -0.015
 $\phi 8 \sim \phi 20$: 0 ~ -0.02

(mm)

ロング刃長 Long

外径公差 Dia. tolerance
 $\phi 6$: 0 ~ -0.015
 $\phi 8 \sim \phi 20$: 0 ~ -0.02

(mm)



EPPM4-TH

超硬 TH 傾斜43° 切削条件表 A331
Carbide Helix angle Cutting Conditions

商品コード Item code	在庫 Stock	寸法 Size (mm)				希望小売 価格(円) Suggested retail price(¥)
		外径 Tool dia.	刃長 Flute length	全長 Overall length	シャンク径 Shank dia.	
EPPM4030-TH	●	3	15	60	6	13,080
EPPM4040-TH	●	4	17	60	6	13,930
EPPM4050-TH	●	5	20	60	6	15,490
EPPM4060-TH	●	6	20	60	6	16,960
EPPM4080-TH	●	8	25	75	8	20,760
EPPM4100-TH	●	10	33	80	10	27,830
EPPM4120-TH	●	12	37	100	12	35,020
EPPM4160-TH	●	16	47	110	16	79,770
EPPM4200-TH	●	20	55	125	20	116,600

EPPL4-TH

超硬 TH 傾斜43° 切削条件表 A331
Carbide Helix angle Cutting Conditions

商品コード Item code	在庫 Stock	寸法 Size (mm)				希望小売 価格(円) Suggested retail price(¥)
		外径 Tool dia.	刃長 Flute length	全長 Overall length	シャンク径 Shank dia.	
EPPL4060-TH	●	6	25	70	6	24,920
EPPL4080-TH	●	8	35	90	8	31,310
EPPL4100-TH	●	10	45	100	10	42,080
EPPL4120-TH	●	12	55	120	12	51,620
EPPL4160-TH	●	16	65	135	16	120,820
EPPL4200-TH	●	20	75	155	20	175,950

○ EPPS-TH, EPP-TH, EPPM-TH, EPPL-THの対応被削材

Applicable work material of EPPS-TH, EPP-TH, EPPM-TH, EPPL-TH

炭素鋼 合金鋼 Carbon steel Alloy steel	プリハー ド鋼 Pre-hardened steel	高硬度 Hardened steel			ステン レス鋼 Stainless steel	チタン合金 耐熱合金 Titanium alloy Heat-resistant alloy	銅合金 Copper alloy	アルミ 合金 Aluminum alloy
		> 45HRC ≤ 45HRC	> 55HRC ≤ 55HRC	> 65HRC				
○	○	○	○	○	○	○	○	

○ : 標準在庫品です。 ● : Stocked items.

○ 再研磨対応外径範囲

Re-grinding compatibility range

商品コード Item code	外周 Outer dia. (mm)	エンド End (mm)
EPPS-TH, EPP-TH, EPPM-TH	6 ~ 20	3 ~ 20
EPPL-TH	6 ~ 20	6 ~ 20

標準切削条件表 Recommended cutting conditions

EPPS4-TH

ショート刃長
Short

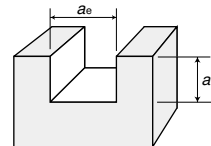

<溝切削> Slotting

被削材 Work material	合金鋼 Alloy steels (200~250HB) SKD61,SKD11				合金鋼 Alloy steels (25~35HRC) SCM440				プリハードン鋼 Pre-hardened steels (35~45HRC) NAK80				焼入れ鋼 Hardened steels (45~55HRC) SKD61,SKT4			
	高速条件 High speed		汎用条件 General		高速条件 High speed		汎用条件 General		高速条件 High speed		汎用条件 General		高速条件 High speed		汎用条件 General	
切込み Depth of cut (mm)	$a_p \leq 0.5DC$		$a_p \leq 1DC$		$a_p \leq 0.2DC$		$a_p \leq 0.5DC$		$a_p \leq 0.2DC$		$a_p \leq 0.5DC$				$a_p \leq 0.2DC$	
外径DC Tool dia. (mm)	回転数 n (min^{-1})	送り速度 v_f (mm/min)	回転数 n (min^{-1})	送り速度 v_f (mm/min)	回転数 n (min^{-1})	送り速度 v_f (mm/min)	回転数 n (min^{-1})	送り速度 v_f (mm/min)	回転数 n (min^{-1})	送り速度 v_f (mm/min)	回転数 n (min^{-1})	送り速度 v_f (mm/min)	回転数 n (min^{-1})	送り速度 v_f (mm/min)	回転数 n (min^{-1})	送り速度 v_f (mm/min)
φ3	15,900	1,260	11,100	900	9,600	570	7,950	480	9,280	550	7,690	460			3,990	200
φ4	11,940	1,440	8,250	1,005	7,200	720	6,000	600	6,960	700	5,800	580			3,000	240
φ5	9,540	1,530	6,840	1,050	5,700	810	4,800	690	5,510	780	4,640	670			2,430	300
φ6	7,980	1,590	5,760	1,110	4,800	750	3,900	630	4,640	730	3,770	610			1,950	330
φ8	5,940	1,650	4,320	1,170	3,600	720	3,000	600	3,480	700	2,900	580			1,500	300
φ10	4,800	1,530	3,420	1,050	2,850	690	2,400	570	2,760	670	2,320	550			1,200	270
φ12	3,750	1,410	2,850	990	2,400	660	1,950	540	2,320	640	1,890	520			1,020	240
φ16	3,000	1,200	2,100	840	1,800	600	1,500	510	1,740	580	1,450	490			750	210
φ20	2,340	1,140	1,650	780	1,500	570	1,200	480	1,450	550	1,160	460			600	180

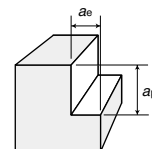

<側面切削> Side milling

被削材 Work material	合金鋼 Alloy steels (200~250HB) SKD61,SKD11				合金鋼 Alloy steels (25~35HRC) SCM440				プリハードン鋼 Pre-hardened steels (35~45HRC) NAK80				焼入れ鋼 Hardened steels (45~55HRC) SKD61,SKT4			
	高速条件 High speed		汎用条件 General		高速条件 High speed		汎用条件 General		高速条件 High speed		汎用条件 General		高速条件 High speed		汎用条件 General	
切込み Depth of cut (mm)	$a_p=1.5DC$		$a_p=1.5DC$		$a_p=1.5DC$		$a_p=1.5DC$		$a_p=1.5DC$		$a_p=1.5DC$		$a_p=1.5DC$		$a_p=1.5DC$	
外径DC Tool dia. (mm)	回転数 n (min^{-1})	送り速度 v_f (mm/min)	回転数 n (min^{-1})	送り速度 v_f (mm/min)	回転数 n (min^{-1})	送り速度 v_f (mm/min)	回転数 n (min^{-1})	送り速度 v_f (mm/min)	回転数 n (min^{-1})	送り速度 v_f (mm/min)	回転数 n (min^{-1})	送り速度 v_f (mm/min)	回転数 n (min^{-1})	送り速度 v_f (mm/min)	回転数 n (min^{-1})	送り速度 v_f (mm/min)
φ3	19,100	1,530	15,900	1,280	17,400	960	12,500	780	15,900	900	10,400	650	12,700	600	9,560	440
φ4	14,300	1,730	11,900	1,440	13,000	1,200	9,600	960	12,000	1,140	7,920	740	9,560	810	7,160	570
φ5	11,500	1,830	9,600	1,530	10,400	1,350	7,500	1,050	9,560	1,280	6,300	780	7,640	920	5,730	690
φ6	9,560	1,910	7,970	1,590	8,700	1,280	6,600	1,020	7,970	1,190	5,220	800	6,360	890	4,770	680
φ8	7,160	2,010	5,970	1,650	6,480	1,200	4,950	960	5,970	1,140	3,960	870	4,770	860	3,590	650
φ10	5,730	1,830	4,770	1,530	5,220	1,140	3,900	900	4,770	1,050	3,240	800	3,830	840	2,870	630
φ12	4,770	1,710	3,750	1,440	4,320	1,110	3,300	870	3,750	1,020	2,700	720	3,180	770	2,390	570
φ16	3,590	1,440	2,930	1,260	3,240	1,020	2,550	810	2,930	930	1,980	620	2,390	680	1,790	510
φ20	2,870	1,380	2,400	1,140	2,520	960	1,950	750	2,400	870	1,620	600	1,910	620	1,500	470

- [注意]**
- ①できるだけ高剛性、高精度の機械をご使用ください。
 - ②被削材、加工形状に合わせて、適切なクーラントを使用してください。
 - ③この切削条件表は切削条件の目安を示すものです。実際の加工では加工形状、目的、使用機械等により条件を調整してください。
 - ④機械の回転数が足りない場合には、回転数と送り速度を同じ比率で下げてください。

- [Note]**
- ① Use a highly rigid and accurate machine as possible.
 - ② Use the appropriate coolant for the work material and machining shape.
 - ③ These conditions are for general guidance; in actual machining conditions adjust the parameters according to your actual machine and work-piece conditions.
 - ④ If the rpm available is lower than that recommended please reduce the feed rate to the same ratio.

Epoch TH Power Mill エポックTHパワーミル

EPP4-TH

レギュラー刃長
Regular

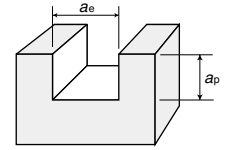

<溝切削> Slotting

被削材 Work material	合金鋼 Alloy steels (200~250HB) SKD61,SKD11				合金鋼 Alloy steels (25~35HRC) SCM440				プリハードン鋼 Pre-hardened steels (35~45HRC) NAK80				焼入れ鋼 Hardened steels (45~55HRC) SKD61,SKT4			
	高速条件 High speed		汎用条件 General		高速条件 High speed		汎用条件 General		高速条件 High speed		汎用条件 General		高速条件 High speed		汎用条件 General	
切込み Depth of cut (mm)	$a_p \leq 0.5DC$ $a_e = 1DC$		$a_p \leq 1DC$ $a_e = 1DC$				$a_p \leq 0.5DC$ $a_e = 1DC$				$a_p \leq 0.5DC$ $a_e = 1DC$				$a_p \leq 0.2DC$ $a_e = 1DC$	
外径DC Tool dia. (mm)	回転数 n (min ⁻¹)	送り速度 v_f (mm/min)	回転数 n (min ⁻¹)	送り速度 v_f (mm/min)	回転数 n (min ⁻¹)	送り速度 v_f (mm/min)	回転数 n (min ⁻¹)	送り速度 v_f (mm/min)	回転数 n (min ⁻¹)	送り速度 v_f (mm/min)	回転数 n (min ⁻¹)	送り速度 v_f (mm/min)	回転数 n (min ⁻¹)	送り速度 v_f (mm/min)	回転数 n (min ⁻¹)	送り速度 v_f (mm/min)
φ3	8,500	820	6,400	490			6,400	440			5,800	360			5,300	240
φ4	6,400	920	4,800	550			4,800	500			4,400	410			4,000	280
φ5	5,100	980	3,800	580			3,800	530			3,500	430			3,200	290
φ6	4,200	1,010	3,200	610			3,200	550			2,900	450			2,700	310
φ8	3,200	1,090	2,400	650			2,400	590			2,200	480			2,000	330
φ10	2,500	950	1,900	580			1,900	520			1,800	440			1,600	290
φ12	2,100	880	1,600	540			1,600	480			1,500	400			1,300	260
φ16	1,600	770	1,200	460			1,200	410			1,100	340			1,000	230
φ20	1,300	750	1,000	460			1,000	420			900	330			800	200

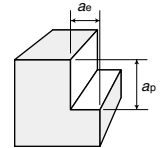

<側面切削> Side milling

被削材 Work material	合金鋼 Alloy steels (200~250HB) SKD61,SKD11				合金鋼 Alloy steels (25~35HRC) SCM440				プリハードン鋼 Pre-hardened steels (35~45HRC) CENA1,NAK80				焼入れ鋼 Hardened steels (45~55HRC) SKD61,SKT4			
	高速条件 High speed		汎用条件 General		高速条件 High speed		汎用条件 General		高速条件 High speed		汎用条件 General		高速条件 High speed		汎用条件 General	
切込み Depth of cut (mm)	$a_p = 1.5DC$ $a_e = 0.1DC$		$a_p = 1.5DC$ $a_e = 0.15DC$		$a_p = 1.5DC$ $a_e = 0.05DC$		$a_p = 1.5DC$ $a_e = 0.1DC$		$a_p = 1.5DC$ $a_e = 0.05DC$		$a_p = 1.5DC$ $a_e = 0.07DC$		$a_p = 1.5DC$ $a_e = 0.02DC$		$a_p = 1.5DC$ $a_e = 0.05DC$	
外径DC Tool dia. (mm)	回転数 n (min ⁻¹)	送り速度 v_f (mm/min)	回転数 n (min ⁻¹)	送り速度 v_f (mm/min)	回転数 n (min ⁻¹)	送り速度 v_f (mm/min)	回転数 n (min ⁻¹)	送り速度 v_f (mm/min)	回転数 n (min ⁻¹)	送り速度 v_f (mm/min)	回転数 n (min ⁻¹)	送り速度 v_f (mm/min)	回転数 n (min ⁻¹)	送り速度 v_f (mm/min)	回転数 n (min ⁻¹)	送り速度 v_f (mm/min)
φ3	16,000	1,800	9,600	860	14,000	1,400	9,600	770	12,000	1,100	8,500	610	11,000	860	7,400	460
φ4	12,000	1,900	7,200	920	10,000	1,400	7,200	830	8,800	1,100	6,400	660	8,000	900	5,600	500
φ5	9,600	2,100	5,700	1,000	8,300	1,600	5,700	900	7,000	1,200	5,100	720	6,400	990	4,500	550
φ6	8,000	2,200	4,800	1,080	6,900	1,700	4,800	970	5,800	1,300	4,200	750	5,300	1,040	3,700	580
φ8	6,000	2,400	3,600	1,150	5,200	1,900	3,600	1,040	4,400	1,400	3,200	820	4,000	1,120	2,800	630
φ10	4,800	2,200	2,900	1,070	4,100	1,700	2,900	960	3,500	1,300	2,500	740	3,200	1,030	2,200	570
φ12	4,000	2,100	2,400	1,000	3,500	1,600	2,400	900	2,900	1,200	2,100	700	2,700	980	1,900	550
φ16	3,000	1,700	1,800	810	2,600	1,300	1,800	730	2,200	1,000	1,600	570	2,000	780	1,400	440
φ20	2,400	1,400	1,400	670	2,100	1,100	1,400	600	1,800	860	1,300	500	1,590	670	1,110	370

- 【注意】**
- ① できるだけ高剛性、高精度の機械をご使用ください。
 - ② 被削材、加工形状に合わせて、適切なクーラントを使用してください。
 - ③ この切削条件表は切削条件の目安を示すものです。実際の加工では加工形状、目的、使用機械等により条件を調整してください。
 - ④ 機械の回転数が足りない場合には、回転数と送り速度を同じ比率で下げてください。

- 【Note】**
- ① Use a highly rigid and accurate machine as possible.
 - ② Use the appropriate coolant for the work material and machining shape.
 - ③ These conditions are for general guidance; in actual machining conditions adjust the parameters according to your actual machine and work-piece conditions.
 - ④ If the rpm available is lower than that recommended please reduce the feed rate to the same ratio.

EPPM4-TH
ミディアム刃長
Medium

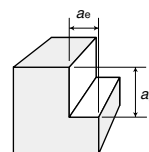

<側面切削> Side milling

被削材 Work material	合金鋼 Alloy steels (200~250HB) SKD61,SKD11		合金鋼 Alloy steels (25~35HRC) SCM440		プリハードン鋼 Pre-hardened steels (35~45HRC) NAK80		焼入れ鋼 Hardened steels (45~55HRC) SKD61,SKT4	
	$a_p=2.5DC$ $a_e=0.02DC$		$a_p=2.5DC$ $a_e=0.02DC$		$a_p=2.5DC$ $a_e=0.02DC$		$a_p=2.5DC$ $a_e=0.01DC$	
外径DC Tool dia. (mm)	回転数 n (min^{-1})	送り速度 v_f (mm/min)	回転数 n (min^{-1})	送り速度 v_f (mm/min)	回転数 n (min^{-1})	送り速度 v_f (mm/min)	回転数 n (min^{-1})	送り速度 v_f (mm/min)
φ3	8,730	730	7,920	590	6,210	370	3,500	170
φ4	6,480	760	5,940	620	4,680	390	2,950	240
φ5	5,220	850	4,770	690	3,690	420	2,300	300
φ6	4,320	880	3,960	720	3,060	440	1,600	310
φ8	3,240	960	2,970	790	2,340	490	1,450	300
φ10	2,610	890	2,340	710	1,890	450	1,200	300
φ12	2,160	840	1,980	690	1,530	420	900	270
φ16	1,620	680	1,530	580	1,170	350	750	200
φ20	1,260	540	1,170	450	900	270	600	180

EPPL4-TH
ロング刃長
Long

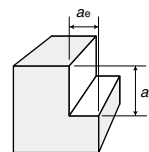

<側面切削> Side milling

被削材 Work material	合金鋼 Alloy steels (200~250HB) SKD61,SKD11		合金鋼 Alloy steels (25~35HRC) SCM440		プリハードン鋼 Pre-hardened steels (35~45HRC) NAK80		焼入れ鋼 Hardened steels (45~55HRC) SKD61,SKT4	
	$a_p=3DC$ $a_e=0.02DC$		$a_p=3DC$ $a_e=0.02DC$		$a_p=3DC$ $a_e=0.02DC$		$a_p=3DC$ $a_e=0.01DC$	
外径DC Tool dia. (mm)	回転数 n (min^{-1})	送り速度 v_f (mm/min)	回転数 n (min^{-1})	送り速度 v_f (mm/min)	回転数 n (min^{-1})	送り速度 v_f (mm/min)	回転数 n (min^{-1})	送り速度 v_f (mm/min)
φ6	3,840	740	2,940	530	2,400	380	1,590	230
φ8	2,880	700	2,200	500	1,800	350	1,200	220
φ10	2,280	690	1,750	480	1,400	330	960	210
φ12	1,920	640	1,500	450	1,200	320	800	200
φ16	1,440	550	1,100	420	900	300	600	170
φ20	1,200	500	900	380	700	250	500	150

- 【注意】**
- ①できるだけ高剛性、高精度の機械をご使用ください。
 - ②被削材、加工形状に合わせて、適切なクーラントを使用してください。
 - ③この切削条件表は切削条件の目安を示すものです。実際の加工では加工形状、目的、使用機械等により条件を調整してください。
 - ④機械の回転数が足りない場合には、回転数と送り速度を同じ比率で下げてください。

- 【Note】**
- ① Use a highly rigid and accurate machine as possible.
 - ② Use the appropriate coolant for the work material and machining shape.
 - ③ These conditions are for general guidance; in actual machining conditions adjust the parameters according to your actual machine and work-piece conditions.
 - ④ If the rpm available is lower than that recommended please reduce the feed rate to the same ratio.

Epoch CS Power Mill エポックCSパワーミル

切りくず排出性抜群のパワーミルにCSコーティングで長寿命。
Power mill with excellent chip removal plus CS Coating for long life.

レギュラー刃長 Regular

Regular



外径公差 Dia. tolerance
 $\phi 3 \sim \phi 6 : 0 \sim -0.015$
 $\phi 8 \sim \phi 20 : 0 \sim -0.02$



(mm)



EPP4--CS

超硬 CS ねじり43° 切削条件表 A333
 Carbide CS Helix angle Cutting Conditions

商品コード Item code	在庫 Stock	寸法 Size (mm)				希望小売 価格(円) Suggested retail price(¥)
		外径 Tool dia.	刃長 Flute length	全長 Overall length	シャンク径 Shank dia.	
EPP4030-CS	●	3	8	60	6	10,940
EPP4040-CS	●	4	11	60	6	11,470
EPP4050-CS	●	5	13	60	6	12,800
EPP4060-CS	●	6	13	60	6	14,030
EPP4080-CS	●	8	19	75	8	17,180

商品コード Item code	在庫 Stock	寸法 Size (mm)				希望小売 価格(円) Suggested retail price(¥)
		外径 Tool dia.	刃長 Flute length	全長 Overall length	シャンク径 Shank dia.	
EPP4100-CS	●	10	22	80	10	23,130
EPP4120-CS	●	12	26	100	12	28,960
EPP4160-CS	●	16	32	110	16	66,640
EPP4200-CS	●	20	38	125	20	97,250

ピンカド®・ショート刃長 PINKADO Short

PINKADO Short



外径公差 Dia. tolerance
 $\phi 1 \sim \phi 6 : 0 \sim -0.015$
 $\phi 7 \sim \phi 12 : 0 \sim -0.02$



(mm)



ピンカド®・レギュラー刃長 PINKADO Regular

PINKADO Regular



外径公差 Dia. tolerance
 $\phi 1 \sim \phi 6 : 0 \sim -0.015$
 $\phi 8 \sim \phi 20 : 0 \sim -0.02$



(mm)



EPPS4--P-CS

超硬 CS ねじり43° 切削条件表 A335
 Carbide CS Helix angle Cutting Conditions

商品コード Item code	在庫 Stock	寸法 Size (mm)				希望小売 価格(円) Suggested retail price(¥)
		外径 Tool dia.	刃長 Flute length	全長 Overall length	シャンク径 Shank dia.	
EPPS4010-P-CS	●	1	1.5	50	6	11,470
EPPS4015-P-CS	●	1.5	2.3	50	6	11,470
EPPS4020-P-CS	●	2	3	50	6	10,940
EPPS4025-P-CS	●	2.5	3.8	50	6	10,640
EPPS4030-P-CS	●	3	4.5	50	6	10,420
EPPS4035-P-CS	●	3.5	5.3	50	6	10,940
EPPS4040-P-CS	●	4	6	50	6	10,940
EPPS4045-P-CS	●	4.5	6.8	50	6	12,240
EPPS4050-P-CS	●	5	7.5	50	6	12,240
EPPS4060-P-CS	●	6	9	50	6	13,140
EPPS4070-P-CS	●	7	10.5	60	8	17,520
EPPS4080-P-CS	●	8	12	60	8	16,270
EPPS4090-P-CS	●	9	13.5	65	10	22,440
EPPS4100-P-CS	●	10	15	70	10	21,770
EPPS4110-P-CS	●	11	16.5	75	12	24,130
EPPS4120-P-CS	●	12	18	75	12	27,490

EPP4--P-CS

超硬 CS ねじり43° 切削条件表 A335
 Carbide CS Helix angle Cutting Conditions

商品コード Item code	在庫 Stock	寸法 Size (mm)				希望小売 価格(円) Suggested retail price(¥)
		外径 Tool dia.	刃長 Flute length	全長 Overall length	シャンク径 Shank dia.	
EPP4010-P-CS	●	1	2.5	60	6	12,010
EPP4015-P-CS	●	1.5	4	60	6	12,010
EPP4020-P-CS	●	2	6	60	6	11,580
EPP4025-P-CS	●	2.5	8	60	6	11,250
EPP4030-P-CS	●	3	8	60	6	10,940
EPP4040-P-CS	●	4	11	60	6	11,470
EPP4050-P-CS	●	5	13	60	6	12,800
EPP4060-P-CS	●	6	13	60	6	14,030
EPP4080-P-CS	●	8	19	75	8	17,180
EPP4100-P-CS	●	10	22	80	10	23,130
EPP4120-P-CS	●	12	26	100	12	28,960
EPP4160-P-CS	●	16	32	110	16	66,640
EPP4200-P-CS	●	20	38	125	20	97,250

○ EPP4-CS、EPPS4-P-CS、EPP4-P-CSの対応被削材

Applicable work material of EPP4-CS, EPPS4-P-CS, EPP4-P-CS

炭素鋼 合金鋼 Carbon steel Alloy steel	プリハードン鋼 Pre-hardened steel	高硬度 Hardened steel			ステン レス鋼 Stainless steel	チタン合金 耐熱合金 Titanium alloy Heat-resistant alloy	銅合金 Copper alloy	アルミ 合金 Aluminum alloy
		> 45HRC ≤ 55HRC	> 55HRC ≤ 65HRC	> 65HRC				
○	○	○	○		○	○	○	○

○ 再研磨対応外径範囲

Re-grinding compatibility range

商品コード Item code	外周 Outer dia. (mm)	エンド End (mm)
EPP4-CS	6 ~ 20	3 ~ 20
EPPS4-P-CS	6 ~ 12	2 ~ 12
EPP4-P-CS	6 ~ 20	2 ~ 20

●印：標準在庫品です。 ●：Stocked items.

標準切削条件表 Recommended cutting conditions

EPP4-CS

レギュラー刃長
Regular

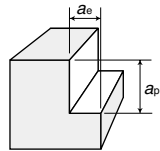

<側面切削> Side milling

被削材 Work material	鋳鉄 Cast irons (150~200HB) FC250		炭素鋼 Carbon steels (180~220HB) SS400, S50C		合金鋼 Alloy steels (200~250HB) SCM440, SNCM		ステンレス鋼・工具鋼 Stainless steels, Tool steels (25~35HRC) SUS304, SKD		プリハードン鋼 Pre-hardened steels (35~45HRC) CEN1, NAK80		焼入れ鋼 Hardened steels (45~55HRC) SKD61, SKT		チタン合金 Titanium alloys Ti-6Al-4V		超耐熱合金 Super heat-resistant alloys Inconel Hasteloy		
	切込み Depth of cut (mm)	$a_p=1.5DC$ $a_e=0.1DC$	$a_p=1.5DC$ $a_e=0.1DC$	$a_p=1.5DC$ $a_e=0.1DC$	$a_p=1.5DC$ $a_e=0.1DC$	$a_p=1.5DC$ $a_e=0.05DC$	$a_p=1.5DC$ $a_e=0.05DC$	$a_p=1.5DC$ $a_e=0.02DC$	$a_p=1.5DC$ $a_e=0.05DC$	$a_p=1.5DC$ $a_e=0.02DC$	$a_p=1.5DC$ $a_e=0.05DC$	$a_p=1.5DC$ $a_e=0.05DC$	$a_p=1.5DC$ $a_e=0.02DC$	$a_p=1.5DC$ $a_e=0.05DC$	$a_p=1.5DC$ $a_e=0.05DC$		
High speed 高速条件	外径DC Tool dia. (mm)	回転数 n (min^{-1})	送り速度 V_f (mm/min)	回転数 n (min^{-1})	送り速度 V_f (mm/min)	回転数 n (min^{-1})	送り速度 V_f (mm/min)	回転数 n (min^{-1})	送り速度 V_f (mm/min)	回転数 n (min^{-1})	送り速度 V_f (mm/min)	回転数 n (min^{-1})	送り速度 V_f (mm/min)	回転数 n (min^{-1})	送り速度 V_f (mm/min)	回転数 n (min^{-1})	送り速度 V_f (mm/min)
	$\phi 3$	13,000	1,660	13,000	1,660	11,000	1,200	9,600	920	8,500	920	6,400	570	9,600	980	8,500	540
	$\phi 4$	9,600	1,730	9,600	1,730	8,000	1,220	7,200	970	6,400	980	4,800	600	7,200	1,040	6,400	580
	$\phi 5$	7,600	1,820	7,600	1,820	6,400	1,310	5,700	1,030	5,100	1,040	3,800	640	5,700	1,090	5,100	610
	$\phi 6$	6,400	1,870	6,400	1,870	5,300	1,320	4,800	1,050	4,200	1,040	3,200	650	4,800	1,120	4,200	610
	$\phi 8$	4,800	1,920	4,800	1,920	4,000	1,360	3,600	1,080	3,200	1,090	2,400	670	3,600	1,150	3,200	640
	$\phi 10$	3,800	1,820	3,800	1,820	3,200	1,310	2,900	1,040	2,500	1,020	1,900	640	2,900	1,110	2,500	600
	$\phi 12$	3,200	1,660	3,200	1,660	2,700	1,190	2,400	940	2,100	930	1,600	580	2,400	1,000	2,100	550
	$\phi 16$	2,400	1,390	2,400	1,390	2,000	990	1,800	780	1,600	790	1,200	490	1,800	840	1,600	460
	$\phi 20$	1,900	1,220	1,900	1,220	1,600	870	1,400	670	1,300	710	960	430	1,400	720	1,300	420
General 汎用条件	切込み Depth of cut (mm)	$a_p=1.5DC$ $a_e=0.2DC$	$a_p=1.5DC$ $a_e=0.2DC$	$a_p=1.5DC$ $a_e=0.15DC$	$a_p=1.5DC$ $a_e=0.1DC$	$a_p=1.5DC$ $a_e=0.07DC$	$a_p=1.5DC$ $a_e=0.05DC$	$a_p=1.5DC$ $a_e=0.1DC$	$a_p=1.5DC$ $a_e=0.05DC$	$a_p=1.5DC$ $a_e=0.1DC$	$a_p=1.5DC$ $a_e=0.05DC$	$a_p=1.5DC$ $a_e=0.1DC$	$a_p=1.5DC$ $a_e=0.05DC$	$a_p=1.5DC$ $a_e=0.05DC$			
	外径DC Tool dia. (mm)	回転数 n (min^{-1})	送り速度 V_f (mm/min)	回転数 n (min^{-1})	送り速度 V_f (mm/min)	回転数 n (min^{-1})	送り速度 V_f (mm/min)	回転数 n (min^{-1})	送り速度 V_f (mm/min)	回転数 n (min^{-1})	送り速度 V_f (mm/min)	回転数 n (min^{-1})	送り速度 V_f (mm/min)	回転数 n (min^{-1})	送り速度 V_f (mm/min)	回転数 n (min^{-1})	送り速度 V_f (mm/min)
	$\phi 3$	9,000	810	9,000	810	8,000	740	6,400	520	5,300	430	4,200	260	6,400	460	3,200	140
	$\phi 4$	6,800	860	6,800	860	6,000	780	4,800	550	4,000	460	3,200	280	4,800	480	2,400	150
	$\phi 5$	5,400	910	5,400	910	4,800	830	3,800	580	3,200	490	2,500	290	3,800	510	1,900	160
	$\phi 6$	4,500	920	4,500	920	4,000	840	3,200	600	2,700	500	2,100	300	3,200	520	1,600	160
	$\phi 8$	3,400	950	3,400	950	3,000	870	2,400	610	2,000	510	1,600	310	2,400	540	1,200	170
	$\phi 10$	2,700	910	2,700	910	2,400	830	1,900	580	1,600	490	1,300	310	1,900	510	960	160
	$\phi 12$	2,300	840	2,300	840	2,000	750	1,600	530	1,300	430	1,100	280	1,600	470	800	150
	$\phi 16$	1,700	690	1,700	690	1,500	630	1,200	440	1,000	370	800	230	1,200	390	600	120
$\phi 20$	1,400	630	1,400	630	1,200	550	960	390	800	330	640	200	960	340	480	110	

- 【注意】**
- ① できるだけ高剛性、高精度の機械をご使用ください。
 - ② この標準切削条件表は切削条件の目安を示すものです。実際の加工では加工形状、目的、使用機械等により条件を調整してください。
 - ③ 機械の回転数が足りない場合、回転数と送り速度を同じ比率で下げてください。
 - ④ ステンレス鋼・耐熱鋼には、切削液をご使用ください。(防火対策を必ず行ってください。)

- 【Note】**
- ① Use a highly rigid and accurate machine as possible.
 - ② These conditions are for general guidance; in actual machining conditions adjust the parameters according to your actual machine and work-piece conditions.
 - ③ If the rpm available is lower than that recommended please reduce the feed rate to the same ratio.
 - ④ For stainless steel and heat resistant alloys please use cutting fluid. (Please provide adequate fire prevention.)

EPP4-CS

レギュラー刃長
Regular

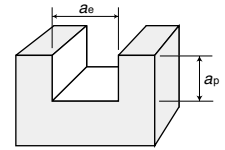

<溝切削> Slotting

被削材 Work material	鋳鉄 Cast irons (150~200HB) FC250		炭素鋼 Carbon steels (180~220HB) SS400, S50C		合金鋼 Alloy steels (200~250HB) SCM440, SNCM		ステンレス鋼・工具鋼 Stainless steels, Tool steels (25~35HRC) SUS304, SKD		プリハードン鋼 Pre-hardened steels (35~45HRC) CENA1, NAK80		チタン合金 Titanium alloys Ti-6Al-4V		超耐熱合金 Super heat-resistant alloys Inconel Hasteloy		
	$a_p \leq 0.5DC$ $a_e = 1DC$		$a_p \leq 0.5DC$ $a_e = 1DC$		$a_p \leq 0.5DC$ $a_e = 1DC$		$a_p \leq 0.5DC$ $a_e = 1DC$		$a_p \leq 0.5DC$ $a_e = 1DC$		$a_p \leq 0.2DC$ $a_e = 1DC$		$a_p \leq 0.2DC$ $a_e = 1DC$		
高速条件 High Speed	切込み Depth of cut (mm)	回転数 n (min^{-1})	送り速度 v_f (mm/min)	回転数 n (min^{-1})	送り速度 v_f (mm/min)	回転数 n (min^{-1})	送り速度 v_f (mm/min)	回転数 n (min^{-1})	送り速度 v_f (mm/min)	回転数 n (min^{-1})	送り速度 v_f (mm/min)	回転数 n (min^{-1})	送り速度 v_f (mm/min)	回転数 n (min^{-1})	送り速度 v_f (mm/min)
	汎用条件 General	外径DC Tool dia. (mm)	回転数 n (min^{-1})	送り速度 v_f (mm/min)	回転数 n (min^{-1})	送り速度 v_f (mm/min)	回転数 n (min^{-1})	送り速度 v_f (mm/min)	回転数 n (min^{-1})	送り速度 v_f (mm/min)	回転数 n (min^{-1})	送り速度 v_f (mm/min)	回転数 n (min^{-1})	送り速度 v_f (mm/min)	回転数 n (min^{-1})
$\phi 3$		5,300	420	9,600	920	7,400	710								
$\phi 4$		4,000	480	7,200	1,040	5,600	810								
$\phi 5$		3,200	510	5,700	1,090	4,500	860								
$\phi 6$		2,700	540	4,800	1,150	3,700	890								
$\phi 8$		2,000	560	3,600	1,210	2,800	940								
$\phi 10$		1,600	510	2,900	1,110	2,200	840								
$\phi 12$		1,300	470	2,400	1,040	1,900	820								
$\phi 16$		1,000	400	1,790	860	1,400	670								
$\phi 20$	800	380	1,430	820	1,100	630									
汎用条件 General	切込み Depth of cut (mm)	$a_p \leq 1DC$ $a_e = 1DC$		$a_p \leq 1DC$ $a_e = 1DC$		$a_p \leq 1DC$ $a_e = 1DC$		$a_p \leq 0.5DC$ $a_e = 1DC$		$a_p \leq 0.5DC$ $a_e = 1DC$		$a_p \leq 0.2DC$ $a_e = 1DC$		$a_p \leq 0.2DC$ $a_e = 1DC$	
	外径DC Tool dia. (mm)	回転数 n (min^{-1})	送り速度 v_f (mm/min)	回転数 n (min^{-1})	送り速度 v_f (mm/min)	回転数 n (min^{-1})	送り速度 v_f (mm/min)	回転数 n (min^{-1})	送り速度 v_f (mm/min)	回転数 n (min^{-1})	送り速度 v_f (mm/min)	回転数 n (min^{-1})	送り速度 v_f (mm/min)	回転数 n (min^{-1})	送り速度 v_f (mm/min)
	$\phi 3$	3,200	230	7,400	570	5,300	410	5,300	380	5,300	380	4,200	300	1,600	80
	$\phi 4$	2,400	290	5,600	650	4,000	460	4,000	430	4,000	430	3,200	350	1,200	90
	$\phi 5$	1,900	300	4,500	690	3,200	490	3,200	460	3,200	460	2,500	360	1,000	100
	$\phi 6$	1,600	320	3,700	710	2,700	520	2,700	490	2,700	490	2,100	380	800	100
	$\phi 8$	1,200	340	2,800	750	2,000	540	2,000	500	2,000	500	1,600	400	600	100
	$\phi 10$	1,000	320	2,200	680	1,600	490	1,600	460	1,600	460	1,300	370	480	90
	$\phi 12$	800	290	1,900	660	1,300	450	1,300	420	1,300	420	1,100	360	400	90
$\phi 16$	600	240	1,400	540	1,000	380	1,000	360	1,000	360	800	290	300	70	
$\phi 20$	480	230	1,100	510	800	370	800	350	800	350	640	280	240	70	

- 【注意】**
- ①できるだけ高剛性、高精度の機械をご使用ください。
 - ②この標準切削条件表は切削条件の目安を示すものです。実際の加工では加工形状、目的、使用機械等により条件を調整してください。
 - ③機械の回転数が足りない場合、回転数と送り速度を同じ比率で下げてください。
 - ④ステンレス鋼・耐熱鋼には、切削液をご使用ください。(防火対策を必ず行ってください。)

- 【Note】**
- ① Use a highly rigid and accurate machine as possible.
 - ② These conditions are for general guidance; in actual machining conditions adjust the parameters according to your actual machine and work-piece conditions.
 - ③ If the rpm available is lower than that recommended please reduce the feed rate to the same ratio.
 - ④ For stainless steel and heat resistant alloys please use cutting fluid. (Please provide adequate fire prevention.)

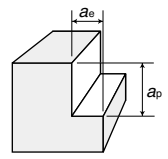

EPPS-P-CS ショート刃長・ピンカド Short, Pinkado
EPP-P-CS レギュラー刃長・ピンカド Regular, Pinkado

<側面切削> Side milling

被削材 Work material	炭素鋼・鋳鉄 Carbon steels, Cast irons (150~200HB) S45C, SS400, FC200		合金鋼・工具鋼・プリハードン鋼 Alloy steels, Tool steels, Pre-hardened steels (25~35HRC) SCM, SKD, HPM		ステンレス鋼・耐熱鋼 Stainless steels Heat-resistant alloy steels SUS304, SUH61		調質鋼・焼入れ鋼 Hardened steels (40~50HRC) SKD, SKT		アルミ展伸材 Aluminum alloy wrought A7075, A5052等		アルミ鋳物 Aluminum alloy casting AC, ADC	
	$a_p \leq 1DC$ $a_e \leq 0.01DC$		$a_p \leq 1DC$ $a_e \leq 0.01DC$		$a_p \leq 1DC$ $a_e \leq 0.01DC$		$a_p \leq 1DC$ $a_e \leq 0.01DC$		$a_p = 1DC$ $a_e \leq 0.1DC$		$a_p = 1DC$ $a_e \leq 0.1DC$	
外径DC Tool dia. (mm)	回転数 n (min ⁻¹)	送り速度 V_f (mm/min)	回転数 n (min ⁻¹)	送り速度 V_f (mm/min)	回転数 n (min ⁻¹)	送り速度 V_f (mm/min)	回転数 n (min ⁻¹)	送り速度 V_f (mm/min)	回転数 n (min ⁻¹)	送り速度 V_f (mm/min)	回転数 n (min ⁻¹)	送り速度 V_f (mm/min)
φ1	27,000	540	17,500	270	16,000	250	11,000	220	50,000	2,000	50,000	1,650
φ2	13,500	650	8,800	320	8,000	260	5,500	240	50,000	3,000	43,000	2,600
φ3	9,000	720	5,800	400	5,300	300	3,700	300	42,000	5,000	29,000	3,400
φ4	6,500	710	4,400	400	4,000	300	2,800	300	32,000	5,100	21,000	3,400
φ6	4,800	900	2,900	450	2,650	320	2,000	300	21,000	5,000	14,000	3,300
φ8	3,600	800	2,200	480	2,000	360	1,500	270	16,000	5,100	11,000	3,500
φ10	2,800	720	1,750	420	1,600	320	1,200	240	13,000	5,200	8,600	3,450
φ12	2,400	720	1,460	410	1,300	310	1,000	240	10,000	4,400	7,200	3,200

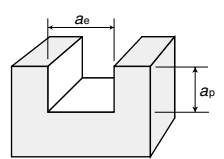

<溝切削> Slotting

被削材 Work material	炭素鋼・鋳鉄 Carbon steels, Cast irons (150~200HB) S45C, SS400, FC200		合金鋼・工具鋼・プリハードン鋼 Alloy steels, Tool steels, Pre-hardened steels (25~35HRC) SCM, SKD, HPM		ステンレス鋼・耐熱鋼 Stainless steels Heat-resistant alloy steels SUS304, SUH61		調質鋼・焼入れ鋼 Hardened steels (40~50HRC) SKD, SKT		アルミ展伸材 Aluminum alloy wrought A7075, A5052等		アルミ鋳物 Aluminum alloy casting AC, ADC	
	$a_p \leq 0.2DC$ $a_e = 1DC$		$a_p \leq 0.2DC$ $a_e = 1DC$		$a_p \leq 0.2DC$ $a_e = 1DC$		$a_p \leq 0.2DC$ $a_e = 1DC$		$a_p \leq 0.5DC$ $a_e = 1DC$		$a_p \leq 0.5DC$ $a_e = 1DC$	
外径DC Tool dia. (mm)	回転数 n (min ⁻¹)	送り速度 V_f (mm/min)	回転数 n (min ⁻¹)	送り速度 V_f (mm/min)	回転数 n (min ⁻¹)	送り速度 V_f (mm/min)	回転数 n (min ⁻¹)	送り速度 V_f (mm/min)	回転数 n (min ⁻¹)	送り速度 V_f (mm/min)	回転数 n (min ⁻¹)	送り速度 V_f (mm/min)
φ1	22,000	700	16,000	400	11,000	250	8,000	160	50,000	1,600	50,000	1,300
φ2	11,000	450	8,000	300	5,500	170	4,000	120	48,000	2,000	32,000	1,350
φ3	7,500	450	5,300	260	3,700	160	2,600	110	32,000	2,600	21,000	1,700
φ4	6,000	480	4,400	290	2,800	160	2,000	110	24,000	3,400	16,000	2,300
φ6	4,000	550	2,900	350	1,900	150	1,300	130	16,000	2,900	11,000	2,000
φ8	3,000	600	2,200	350	1,400	150	1,000	150	12,000	2,800	8,000	1,900
φ10	2,400	530	1,750	330	1,100	150	750	150	10,000	2,800	6,400	1,800
φ12	2,000	460	1,450	290	900	160	660	160	8,000	2,400	5,300	1,600

- 【注意】** ①できるだけ高剛性、高精度の機械およびチャックをご使用ください。
 ②水溶性切削液を必ずご使用ください。
 ③この標準切削条件表は切削条件の目安を示すものです。ビビリや異常振動が発生する場合は条件を調整してください。
 ④Z方向の突っ込みは行わないでください。必ずヘリカル切削（傾斜角度=1°くらいが適当です。）で加工してください。

- 【Note】** ① Use a highly rigid and accurate machine as possible.
 ② Be sure to use water-soluble cutting fluid.
 ③ The cutting conditions shown in the above table are only general recommendations. If chatter or abnormal vibration occurs, adjust the condition.
 ④ Please using helical ramping to enter the work-piece. (ramp angle of 1.)

Epoch Power Mill エポックパワーミル

切りくず排出性抜群で高能率が可能。
Excellent chip removal enables high efficiency.

ラジラスはA249頁を参照してください
Please refer to page A249 for Radius

ショート刃長

Short



外径公差
φ1~φ6 : 0~-0.015
φ6.1~φ25 : 0~-0.02



(mm)



EPPS4



商品コード Item code	在庫 Stock	寸法 Size (mm)				希望小売 価格(円) Suggested retail price(¥)
		外径 Tool dia.	刃長 Flute length	全長 Overall length	シャンク径 Shank dia.	
EPPS4010	<input type="checkbox"/>	1	1.5	60	6	—
EPPS4011	<input type="checkbox"/>	1.1	1.7	60	6	—
EPPS4012	<input type="checkbox"/>	1.2	1.8	60	6	—
EPPS4013	<input type="checkbox"/>	1.3	2	60	6	—
EPPS4014	<input type="checkbox"/>	1.4	2.1	60	6	—
EPPS4015	<input type="checkbox"/>	1.5	2.3	60	6	—
EPPS4016	<input type="checkbox"/>	1.6	2.4	60	6	—
EPPS4017	<input type="checkbox"/>	1.7	2.6	60	6	—
EPPS4018	<input type="checkbox"/>	1.8	2.7	60	6	—
EPPS4019	<input type="checkbox"/>	1.9	2.9	60	6	—
EPPS4020	<input type="checkbox"/>	2	3	60	6	—
EPPS4021	<input type="checkbox"/>	2.1	3.2	60	6	—
EPPS4022	<input type="checkbox"/>	2.2	3.3	60	6	—
EPPS4023	<input type="checkbox"/>	2.3	3.5	60	6	—
EPPS4024	<input type="checkbox"/>	2.4	3.6	60	6	—
EPPS4025	<input type="checkbox"/>	2.5	3.8	60	6	—
EPPS4026	<input type="checkbox"/>	2.6	3.9	60	6	—
EPPS4027	<input type="checkbox"/>	2.7	4.1	60	6	—
EPPS4028	<input type="checkbox"/>	2.8	4.2	60	6	—
EPPS4029	<input type="checkbox"/>	2.9	4.4	60	6	—
EPPS4030	<input checked="" type="checkbox"/>	3	4.5	60	6	9,480
EPPS4031	<input type="checkbox"/>	3.1	4.7	60	6	—
EPPS4032	<input type="checkbox"/>	3.2	4.8	60	6	—
EPPS4033	<input type="checkbox"/>	3.3	5	60	6	—
EPPS4034	<input type="checkbox"/>	3.4	5.1	60	6	—
EPPS4035	<input checked="" type="checkbox"/>	3.5	5.3	60	6	9,960
EPPS4036	<input type="checkbox"/>	3.6	5.4	60	6	—
EPPS4037	<input type="checkbox"/>	3.7	5.6	60	6	—
EPPS4038	<input type="checkbox"/>	3.8	5.7	60	6	—
EPPS4039	<input type="checkbox"/>	3.9	5.9	60	6	—
EPPS4040	<input checked="" type="checkbox"/>	4	6	60	6	9,960
EPPS4041	<input type="checkbox"/>	4.1	6.2	60	6	—
EPPS4042	<input type="checkbox"/>	4.2	6.3	60	6	—
EPPS4043	<input type="checkbox"/>	4.3	6.5	60	6	—
EPPS4044	<input type="checkbox"/>	4.4	6.6	60	6	—
EPPS4045	<input checked="" type="checkbox"/>	4.5	6.8	60	6	11,100
EPPS4046	<input type="checkbox"/>	4.6	6.9	60	6	—
EPPS4047	<input type="checkbox"/>	4.7	7.1	60	6	—
EPPS4048	<input type="checkbox"/>	4.8	7.2	60	6	—
EPPS4049	<input type="checkbox"/>	4.9	7.4	60	6	—
EPPS4050	<input checked="" type="checkbox"/>	5	7.5	60	6	11,100
EPPS4051	<input type="checkbox"/>	5.1	7.7	60	6	—
EPPS4052	<input type="checkbox"/>	5.2	7.8	60	6	—
EPPS4053	<input type="checkbox"/>	5.3	8	60	6	—
EPPS4054	<input type="checkbox"/>	5.4	8.1	60	6	—
EPPS4055	<input checked="" type="checkbox"/>	5.5	8.3	60	6	11,910
EPPS4056	<input type="checkbox"/>	5.6	8.4	60	6	—

商品コード Item code	在庫 Stock	寸法 Size (mm)				希望小売 価格(円) Suggested retail price(¥)
		外径 Tool dia.	刃長 Flute length	全長 Overall length	シャンク径 Shank dia.	
EPPS4057	<input type="checkbox"/>	5.7	8.6	60	6	—
EPPS4058	<input type="checkbox"/>	5.8	8.7	60	6	—
EPPS4059	<input type="checkbox"/>	5.9	8.9	60	6	—
EPPS4060	<input checked="" type="checkbox"/>	6	9	60	6	11,910
EPPS4061	<input type="checkbox"/>	6.1	9.2	60	6	—
EPPS4062	<input type="checkbox"/>	6.2	9.3	60	6	—
EPPS4063	<input type="checkbox"/>	6.3	9.5	60	6	—
EPPS4064	<input type="checkbox"/>	6.4	9.6	60	6	—
EPPS4065	<input checked="" type="checkbox"/>	6.5	9.8	70	8	15,940
EPPS4066	<input type="checkbox"/>	6.6	9.9	70	8	—
EPPS4067	<input type="checkbox"/>	6.7	10.1	70	8	—
EPPS4068	<input type="checkbox"/>	6.8	10.2	70	8	—
EPPS4069	<input type="checkbox"/>	6.9	10.4	70	8	—
EPPS4070	<input checked="" type="checkbox"/>	7	10.5	70	8	15,940
EPPS4071	<input type="checkbox"/>	7.1	10.7	70	8	—
EPPS4072	<input type="checkbox"/>	7.2	10.8	70	8	—
EPPS4073	<input type="checkbox"/>	7.3	11	70	8	—
EPPS4074	<input type="checkbox"/>	7.4	11.1	70	8	—
EPPS4075	<input checked="" type="checkbox"/>	7.5	11.3	75	8	17,740
EPPS4076	<input type="checkbox"/>	7.6	11.4	75	8	—
EPPS4077	<input type="checkbox"/>	7.7	11.6	75	8	—
EPPS4078	<input type="checkbox"/>	7.8	11.7	75	8	—
EPPS4079	<input type="checkbox"/>	7.9	11.9	75	8	—
EPPS4080	<input checked="" type="checkbox"/>	8	12	75	8	14,710
EPPS4081	<input type="checkbox"/>	8.1	12.2	75	8	—
EPPS4082	<input type="checkbox"/>	8.2	12.3	75	8	—
EPPS4083	<input type="checkbox"/>	8.3	12.5	75	8	—
EPPS4084	<input type="checkbox"/>	8.4	12.6	75	8	—
EPPS4085	<input checked="" type="checkbox"/>	8.5	12.8	80	10	20,430
EPPS4086	<input type="checkbox"/>	8.6	12.9	80	10	—
EPPS4087	<input type="checkbox"/>	8.7	13.1	80	10	—
EPPS4088	<input type="checkbox"/>	8.8	13.2	80	10	—
EPPS4089	<input type="checkbox"/>	8.9	13.4	80	10	—
EPPS4090	<input checked="" type="checkbox"/>	9	13.5	80	10	20,430
EPPS4091	<input type="checkbox"/>	9.1	13.7	80	10	—
EPPS4092	<input type="checkbox"/>	9.2	13.8	80	10	—
EPPS4093	<input type="checkbox"/>	9.3	14	80	10	—
EPPS4094	<input type="checkbox"/>	9.4	14.1	80	10	—
EPPS4095	<input checked="" type="checkbox"/>	9.5	14.3	80	10	23,460
EPPS4096	<input type="checkbox"/>	9.6	14.4	80	10	—
EPPS4097	<input type="checkbox"/>	9.7	14.6	80	10	—
EPPS4098	<input type="checkbox"/>	9.8	14.7	80	10	—
EPPS4099	<input type="checkbox"/>	9.9	14.9	80	10	—
EPPS4100	<input checked="" type="checkbox"/>	10	15	80	10	19,760
EPPS4105	<input type="checkbox"/>	10.5	15.8	100	12	—
EPPS4110	<input type="checkbox"/>	11	16.5	100	12	—
EPPS4115	<input type="checkbox"/>	11.5	17.3	100	12	—

●印：標準在庫品です。 □印：特定代理店在庫です。弊社営業へお問合せください。
● : Stocked items. □ : Stocked by specified distributor. Contact with our sales department.

レギュラー刃長 Regular

平面 Planing 側面 Side Cutting 溝 Slotting 荒荒 Roughing 中仕上 Semi Finishing 仕上 Finishing

外径公差 Dia. tolerance
 $\phi 2 \sim \phi 6 : 0 \sim -0.015$
 $\phi 6.5 \sim \phi 25 : 0 \sim -0.02$

h6

(mm)



EPPS4

商品コード Item code	在庫 Stock	寸法 Size (mm)				希望小売 価格(円) Suggested retail price(¥)
		外径 Tool dia.	刃長 Flute length	全長 Overall length	シャンク径 Shank dia.	
EPPS4120	●	12	18	100	12	25,030
EPPS4125	□	12.5	18.8	100	12	—
EPPS4130	□	13	19.5	100	12	—
EPPS4135	□	13.5	20.3	100	12	—
EPPS4140	□	14	21	100	12	—
EPPS4145	□	14.5	21.8	110	16	—
EPPS4150	□	15	22.5	110	16	—
EPPS4155	□	15.5	23.3	110	16	—
EPPS4160	●	16	24	110	16	57,480
EPPS4170	□	17	25.5	110	16	—
EPPS4180	□	18	27	110	16	—
EPPS4190	□	19	28.5	125	20	—
EPPS4200	●	20	30	125	20	83,870
EPPS4210	□	21	31.5	125	20	—
EPPS4220	□	22	33	125	20	—
EPPS4230	□	23	34.5	130	25	—
EPPS4240	□	24	36	130	25	—
EPPS4250	□	25	37.5	130	25	—

EPP4

超硬 Carbide C ねじり43° Helix angle 43° 切削条件表 A341 Cutting Conditions

商品コード Item code	在庫 Stock	寸法 Size (mm)				希望小売 価格(円) Suggested retail price(¥)
		外径 Tool dia.	刃長 Flute length	全長 Overall length	シャンク径 Shank dia.	
EPP4020	□	2	6	60	6	—
EPP4025	□	2.5	8	60	6	—
EPP4030	●	3	8	60	6	9,970
EPP4035	□	3.5	10	60	6	—
EPP4040	●	4	11	60	6	10,480
EPP4045	□	4.5	11	60	6	—
EPP4050	●	5	13	60	6	11,680
EPP4055	□	5.5	13	60	6	—
EPP4060	●	6	13	60	6	12,690
EPP4065	□	6.5	16	70	8	—
EPP4070	●	7	16	70	8	16,720
EPP4075	□	7.5	16	70	8	—
EPP4080	●	8	19	75	8	15,710
EPP4085	□	8.5	19	80	10	—
EPP4090	●	9	19	80	10	21,440
EPP4095	□	9.5	19	80	10	—
EPP4100	●	10	22	80	10	20,990
EPP4110	●	11	22	100	12	28,400
EPP4120	●	12	26	100	12	26,370
EPP4130	●	13	26	100	12	31,220
EPP4140	●	14	26	110	16	47,640
EPP4150	●	15	26	110	16	50,690
EPP4160	●	16	32	110	16	60,540
EPP4170	●	17	32	110	16	82,470
EPP4180	●	18	32	125	20	80,240
EPP4190	●	19	32	125	20	99,840
EPP4200	●	20	38	125	20	88,450
EPP4210	□	21	38	125	20	—
EPP4220	□	22	38	125	20	—
EPP4230	□	23	45	140	25	—
EPP4240	□	24	45	140	25	—
EPP4250	□	25	63	140	25	—

○ EPPS、EPPの対応被削材

Applicable work material of EPPS, EPP

炭素鋼 合金鋼 Carbon steel Alloy steel	プリハー ド鋼 Pre-hardened steel ≤ 45HRC	高硬度 Hardened steel			ステン レス鋼 Stainless steel	チタン合金 耐熱合金 Titanium alloy Heat-resistant alloy	銅合金 Copper alloy	アルミ 合金 Aluminum alloy
		> 45HRC ≤ 55HRC	> 55HRC ≤ 65HRC	> 65HRC				
○	○	○	○	○	○	○	○	

●印：標準在庫品です。 □印：特定代理店在庫です。弊社営業へお問合せください。
 ● : Stocked items. □ : Stocked by specified distributor. Contact with our sales department.

○ 再研磨対応外径範囲

Re-grinding compatibility range

商品コード Item code	外周 Outer dia. (mm)	エンド End (mm)
EPPS	6 ~ 25	2 ~ 25
EPP	6 ~ 25	2 ~ 25

Epoch Power Mill エポックパワーミル

切りくず排出性抜群で高効率が可能。
Excellent chip removal enables high efficiency.

ラジラスはA249頁を参照してください
Please refer to page A249 for Radius

ミディウム刃長 Medium

Medium



外径公差 Dia. tolerance
φ3~φ6 : 0~-0.015
φ7~φ20 : 0~-0.02



(mm)



ロング刃長 Long

Long



外径公差 Dia. tolerance
φ3~φ6 : 0~-0.015
φ7~φ20 : 0~-0.02



(mm)



EPPM4



商品コード Item code	在庫 Stock	寸法 Size (mm)				希望小売 価格(円) Suggested retail price(¥)
		外径 Tool dia.	刃長 Flute length	全長 Overall length	シャンク径 Shank dia.	
EPPM4030	●	3	15	60	6	11,900
EPPM4040	●	4	17	60	6	12,650
EPPM4050	●	5	20	60	6	14,030
EPPM4060	●	6	20	60	6	15,380
EPPM4070	□	7	23	75	8	—
EPPM4080	●	8	25	75	8	18,860
EPPM4090	□	9	30	80	10	—
EPPM4100	●	10	33	80	10	25,250
EPPM4110	□	11	33	100	12	—
EPPM4120	●	12	37	100	12	31,870
EPPM4130	□	13	43	100	12	—
EPPM4140	□	14	43	110	16	—
EPPM4150	□	15	47	110	16	—
EPPM4160	●	16	47	110	16	72,500
EPPM4170	□	17	47	110	16	—
EPPM4180	□	18	55	125	20	—
EPPM4190	□	19	55	125	20	—
EPPM4200	●	20	55	125	20	106,050

EPPL4



商品コード Item code	在庫 Stock	寸法 Size (mm)				希望小売 価格(円) Suggested retail price(¥)
		外径 Tool dia.	刃長 Flute length	全長 Overall length	シャンク径 Shank dia.	
EPPL4030	□	3	18	65	6	—
EPPL4040	□	4	20	65	6	—
EPPL4050	□	5	25	70	6	—
EPPL4060	●	6	25	70	6	22,680
EPPL4070	□	7	35	90	8	—
EPPL4080	●	8	35	90	8	28,510
EPPL4090	□	9	45	100	10	—
EPPL4100	●	10	45	100	10	38,270
EPPL4110	□	11	55	120	12	—
EPPL4120	●	12	55	120	12	46,910
EPPL4130	□	13	55	120	12	—
EPPL4140	□	14	55	125	16	—
EPPL4150	□	15	65	135	16	—
EPPL4160	●	16	65	135	16	109,450
EPPL4170	□	17	65	145	20	—
EPPL4180	□	18	65	145	20	—
EPPL4190	□	19	75	155	20	—
EPPL4200	●	20	75	155	20	159,530

ロングシャンク Long Shank

Long Shank



外径公差 Dia. tolerance
φ3~φ6 : 0~-0.015
φ7~φ20 : 0~-0.02



(mm)

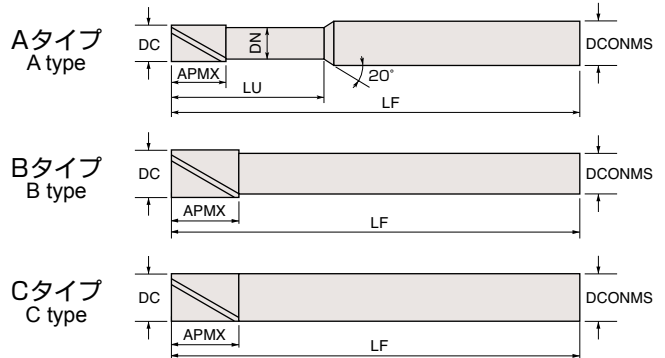

EPPLS4



商品コード Item code	在庫 Stock	寸法 Size (mm)						形状 Shape	希望小売 価格(円) Suggested retail price(¥)
		外径 Tool dia.	刃長 Flute length	首径 Neck dia.	首下長 Under neck length.	全長 Overall length	シャンク径 Shank dia.		
EPPLS4030	●	3	4.5	2.9	10.5	80	6	A	12,010
EPPLS4040	●	4	6	3.8	14	80	6	A	12,650
EPPLS4050	●	5	7.5	4.8	17.5	100	6	A	15,150
EPPLS4060	●	6	9	—	—	120	5	B	17,180
EPPLS4070	●	7	9	—	—	120	6	B	17,180
EPPLS4080	●	8	12	—	—	135	7	B	21,210
EPPLS4090	●	9	12	—	—	135	8	B	21,210
EPPLS4100	●	10	15	—	—	150	9	B	28,400
EPPLS4110	●	11	15	—	—	150	10	B	28,400

商品コード Item code	在庫 Stock	寸法 Size (mm)				形状 Shape	希望小売 価格(円) Suggested retail price(¥)
		外径 Tool dia.	刃長 Flute length	全長 Overall length	シャンク径 Shank dia.		
EPPLS4120	●	12	18	160	11	B	35,690
EPPLS4130	●	13	18	160	12	B	42,230
EPPLS4140	□	14	18	160	13	B	—
EPPLS4150	□	15	22	180	14	B	—
EPPLS4160	●	16	24	180	15	B	78,720
EPPLS4170	●	17	24	180	16	B	78,720
EPPLS4180	□	18	27	180	16	B	—
EPPLS4190	□	19	30	200	18	B	—
EPPLS4200	□	20	30	200	20	C	—

標準切削条件表 Recommended cutting conditions

EPSS

ショート刃長
Short

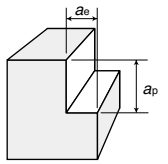

<側面切削> Side milling

被削材 Work material	鋳鉄 Cast irons (150~200HB) FC250		炭素鋼 Carbon steels (180~220HB) SS400, S50C		合金鋼 Alloy steels (200~250HB) SCM440, SNCM		ステンレス鋼・工具鋼 Stainless steels, Tool steels (25~35HRC) SUS304, SKD		プリハードン鋼 Pre-hardened steels (35~45HRC) HPM1, NAK55		焼入れ鋼 Hardened steels (45~55HRC) SKD61, SKT4		チタン合金 Titanium alloys Ti-6Al-4V		超耐熱合金 Super heat-resistant alloys Inconel Hasteloy		
	切込み Depth of cut (mm)	$a_p=1.5DC$ $a_e=0.1DC$	$a_p=1.5DC$ $a_e=0.1DC$	$a_p=1.5DC$ $a_e=0.1DC$	$a_p=1.5DC$ $a_e=0.1DC$	$a_p=1.5DC$ $a_e=0.1DC$	$a_p=1.5DC$ $a_e=0.1DC$	$a_p=1.5DC$ $a_e=0.1DC$	$a_p=1.5DC$ $a_e=0.1DC$	$a_p=1.5DC$ $a_e=0.1DC$	$a_p=1.5DC$ $a_e=0.05DC$	$a_p=1.5DC$ $a_e=0.05DC$	$a_p=1.5DC$ $a_e=0.05DC$	$a_p=1.5DC$ $a_e=0.05DC$	$a_p=1.5DC$ $a_e=0.05DC$	$a_p=1.5DC$ $a_e=0.05DC$	
外径DC Tool dia. (mm)	回転数 n (min^{-1})	送り速度 V_f (mm/min)	回転数 n (min^{-1})	送り速度 V_f (mm/min)	回転数 n (min^{-1})	送り速度 V_f (mm/min)	回転数 n (min^{-1})	送り速度 V_f (mm/min)	回転数 n (min^{-1})	送り速度 V_f (mm/min)	回転数 n (min^{-1})	送り速度 V_f (mm/min)	回転数 n (min^{-1})	送り速度 V_f (mm/min)	回転数 n (min^{-1})	送り速度 V_f (mm/min)	
高速条件 High speed	φ3	15,900	1,270	15,900	1,270	12,700	1,020	10,600	640	10,600	640	8,490	340	8,490	340	3,180	130
	φ4	11,900	1,430	11,900	1,430	9,550	1,150	7,960	800	7,960	800	6,370	510	6,370	510	2,390	190
	φ5	9,550	1,530	9,550	1,530	7,640	1,220	6,370	890	6,370	890	5,090	610	5,090	610	1,910	230
	φ6	7,960	1,590	7,960	1,590	6,370	1,270	5,310	850	5,310	850	4,240	590	4,240	590	1,590	220
	φ8	5,970	1,670	5,970	1,670	4,770	1,340	3,980	800	3,980	800	3,180	570	3,180	570	1,190	210
	φ10	4,770	1,530	4,770	1,530	3,820	1,220	3,180	760	3,180	760	2,550	560	2,550	560	950	210
	φ12	3,980	1,430	3,980	1,430	3,180	1,140	2,650	740	2,650	740	2,120	510	2,120	510	800	190
	φ16	2,980	1,190	2,980	1,190	2,390	960	1,990	680	1,990	680	1,590	450	1,590	450	600	170
φ20	2,390	1,150	2,390	1,150	1,910	920	1,590	640	1,590	640	1,270	410	1,270	410	480	150	
汎用条件 General	φ3	12,700	1,020	12,700	1,020	10,600	850	8,490	510	8,490	510	6,370	250	6,370	250	2,650	110
	φ4	9,550	1,150	9,550	1,150	7,960	960	6,370	640	6,370	640	4,770	380	4,770	380	1,990	160
	φ5	7,640	1,220	7,640	1,220	6,370	1,020	5,090	710	5,090	710	3,820	460	3,820	460	1,590	190
	φ6	6,370	1,270	6,370	1,270	5,310	1,060	4,240	680	4,240	680	3,180	450	3,180	450	1,330	190
	φ8	4,770	1,340	4,770	1,340	3,980	1,110	3,180	640	3,180	640	2,390	430	2,390	430	990	180
	φ10	3,820	1,220	3,820	1,220	3,180	1,020	2,550	610	2,550	610	1,910	420	1,910	420	800	180
	φ12	3,180	1,140	3,180	1,140	2,650	950	2,120	590	2,120	590	1,590	380	1,590	380	660	160
	φ16	2,390	960	2,390	960	1,990	800	1,590	540	1,590	540	1,190	330	1,190	330	500	140
φ20	1,910	920	1,910	920	1,590	760	1,270	510	1,270	510	950	300	950	300	400	130	

【注意】

- ① 切削方法は、ダウンカットで使用ください。
- ② 一般材、とくに高速切削は、乾式（エアブロー）またはオイルミストクーラントにてご使用ください。
- ③ ステンレス鋼および超耐熱合金には、不水溶性切削油のご使用が適しています。
- ④ 安定した切削を行うため、剛性の高い機械とセットアップでご使用ください。
- ⑤ 機械の回転数が足りない場合は、主軸回転数とテーブル送り速度を同比率で下げてください。
- ⑥ 加工形状、機械の剛性、工具突き出し量等、ご使用の状況により、主軸回転数とテーブル送り速度の調整を行ってください。

【Note】

- ① Down-cutting is recommended.
- ② Use generally dry (air-blow) or oil-mist coolant, especially at the high-speed machining.
- ③ Oil base coolant is recommended for machining stainless steels and heat-resistant alloys.
- ④ Use a machine tool with rigidity and rigid set-up, to machine stably.
- ⑤ When the revolution speed is not enough, reduce the revolution speed and table speed at the same ratio.
- ⑥ Adjust the revolution speed and table speed, according to cutting conditions such as machining shape, rigidity of machine tool, over-hang and so on.

EPPM、EPPL、EPPLSの対応被削材

Applicable work material of EPPM, EPPL, EPPLS

炭素鋼 合金鋼 Carbon steel Alloy steel	プリハードン鋼 Pre-hardened steel ≤ 45HRC	高硬度 Hardened steel			ステン レス鋼 Stainless steel	チタン合金 耐熱合金 Titanium alloy Heat-resistant alloy	銅合金 Copper alloy	アルミ 合金 Aluminum alloy
		> 45HRC ≤ 55HRC	> 55HRC ≤ 65HRC	> 65HRC				
◎	◎	○	○	○	○	○	○	

再研磨対応外径範囲

Re-grinding compatibility range

商品コード Item code	外周 Outer dia. (mm)	エンド End (mm)
EPPM	6 ~ 20	3 ~ 20
EPPL	6 ~ 20	3 ~ 20
EPPLS	6 ~ 20	3 ~ 20

Epoch Power Mill エポックパワーミル

EPPS

ショート刃長
Short

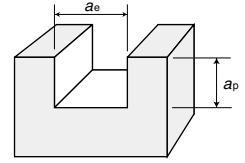

<溝切削> Slotting

被削材 Work material	鋳鉄 Cast irons (150~200HB) FC250		炭素鋼 Carbon steels (180~220HB) SS400, S50C		合金鋼 Alloy steels (200~250HB) SCM440, SNCM		ステンレス鋼・工具鋼 Stainless steels, Tool steels (25~35HRC) SUS304, SKD		プリハードン鋼 Pre-hardened steels (35~45HRC) HPM1, NAK55		焼入れ鋼 Hardened steels (45~55HRC) SKD61, SKT4		チタン合金 Titanium alloys Ti-6Al-4V		超耐熱合金 Super heat-resistant alloys Inconel Hasteloy			
	切込み Depth of cut (mm)	$a_p \leq 0.5DC$ $a_e = 1DC$	切込み Depth of cut (mm)	$a_p \leq 0.5DC$ $a_e = 1DC$	切込み Depth of cut (mm)	$a_p \leq 0.5DC$ $a_e = 1DC$	切込み Depth of cut (mm)	$a_p \leq 0.2DC$ $a_e = 1DC$	切込み Depth of cut (mm)	$a_p \leq 0.2DC$ $a_e = 1DC$	切込み Depth of cut (mm)	$a_p \leq 0.2DC$ $a_e = 1DC$	切込み Depth of cut (mm)	$a_p \leq 0.2DC$ $a_e = 1DC$	切込み Depth of cut (mm)	$a_p \leq 0.2DC$ $a_e = 1DC$		
高速条件 High speed	外径DC Tool dia. (mm)	回転数 n (min^{-1})	送り速度 V_f (mm/min)	回転数 n (min^{-1})	送り速度 V_f (mm/min)	回転数 n (min^{-1})	送り速度 V_f (mm/min)	回転数 n (min^{-1})	送り速度 V_f (mm/min)	回転数 n (min^{-1})	送り速度 V_f (mm/min)	回転数 n (min^{-1})	送り速度 V_f (mm/min)	回転数 n (min^{-1})	送り速度 V_f (mm/min)	回転数 n (min^{-1})	送り速度 V_f (mm/min)	
	$\phi 3$	6,370	510	12,700	1,020	10,600	850	6,370	380	6,370	380							
	$\phi 4$	4,770	570	9,550	1,150	7,960	960	4,770	480	4,770	480							
	$\phi 5$	3,820	610	7,640	1,220	6,370	1,020	3,820	530	3,820	530							
	$\phi 6$	3,180	640	6,370	1,270	5,310	1,060	3,180	510	3,180	510							
	$\phi 8$	2,390	670	4,770	1,340	3,980	1,110	2,390	480	2,390	480							
	$\phi 10$	1,910	610	3,820	1,220	3,180	1,020	1,910	460	1,910	460							
	$\phi 12$	1,590	570	3,180	1,140	2,650	950	1,590	450	1,590	450							
	$\phi 16$	1,190	480	2,390	960	1,990	800	1,190	400	1,190	400							
	$\phi 20$	950	460	1,910	920	1,590	760	950	380	950	380							
汎用条件 General	切込み Depth of cut (mm)	$a_p \leq 1DC$ $a_e = 1DC$	切込み Depth of cut (mm)	$a_p \leq 1DC$ $a_e = 1DC$	切込み Depth of cut (mm)	$a_p \leq 1DC$ $a_e = 1DC$	切込み Depth of cut (mm)	$a_p \leq 0.5DC$ $a_e = 1DC$	切込み Depth of cut (mm)	$a_p \leq 0.5DC$ $a_e = 1DC$	切込み Depth of cut (mm)	$a_p \leq 0.2DC$ $a_e = 1DC$	切込み Depth of cut (mm)	$a_p \leq 0.2DC$ $a_e = 1DC$	切込み Depth of cut (mm)	$a_p \leq 0.2DC$ $a_e = 1DC$		
	外径DC Tool dia. (mm)	回転数 n (min^{-1})	送り速度 V_f (mm/min)	回転数 n (min^{-1})	送り速度 V_f (mm/min)	回転数 n (min^{-1})	送り速度 V_f (mm/min)	回転数 n (min^{-1})	送り速度 V_f (mm/min)	回転数 n (min^{-1})	送り速度 V_f (mm/min)	回転数 n (min^{-1})	送り速度 V_f (mm/min)	回転数 n (min^{-1})	送り速度 V_f (mm/min)	回転数 n (min^{-1})	送り速度 V_f (mm/min)	
	$\phi 3$	5,310	420	8,490	680	7,430	590	5,310	320	5,310	320	2,650	110	4,240	170	2,120	85	
	$\phi 4$	3,980	480	6,370	760	5,570	670	3,980	400	3,980	400	1,990	160	3,180	250	1,590	130	
	$\phi 5$	3,180	510	5,090	810	4,460	710	3,180	450	3,180	450	1,590	190	2,550	310	1,270	150	
	$\phi 6$	2,650	530	4,240	850	3,710	740	2,650	420	2,650	420	1,330	190	2,120	300	1,060	150	
	$\phi 8$	1,990	560	3,180	890	2,790	780	1,990	400	1,990	400	990	180	1,590	290	800	140	
	$\phi 10$	1,590	510	2,550	820	2,230	710	1,590	380	1,590	380	800	180	1,270	280	640	140	
	$\phi 12$	1,330	480	2,120	760	1,860	670	1,330	370	1,330	370	660	160	1,060	250	530	130	
	$\phi 16$	990	400	1,590	640	1,390	560	990	340	990	340	500	140	800	220	400	110	
$\phi 20$	800	380	1,270	610	1,110	530	800	320	800	320	400	130	640	200	320	100		

【注意】

- ① 一般材、とくに高速切削は、乾式（エアブロー）またはオイルミストクーラントにてご使用ください。
- ② ステンレス鋼および超耐熱合金には、不水溶性切削油のご使用が適しています。
- ③ 安定した切削を行うため、剛性の高い機械とセットアップでご使用ください。
- ④ 機械の回転数が足りない場合は、主軸回転数とテーブル送り速度を同比率で下げてください。
- ⑤ 加工形状、機械の剛性、工具突き出し量等、ご使用の状況により、主軸回転数とテーブル送り速度の調整を行ってください。

【Note】

- ① Use generally dry (air-blow) or oil-mist coolant, especially at the high-speed machining.
- ② Oil base coolant is recommended for machining stainless steels and heat-resistant alloys.
- ③ Use a machine tool with rigidity and rigid set-up, to machine stably.
- ④ When the revolution speed is not enough, reduce the revolution speed and table speed at the same ratio.
- ⑤ Adjust the revolution speed and table speed, according to cutting conditions such as machining shape, rigidity of machine tool, over-hang and so on.

EPP

レギュラー刃長
Regular

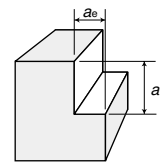

<側面切削> Side milling

被削材 Work material	鋳鉄 Cast irons (150~200HB) FC250		炭素鋼 Carbon steels (180~220HB) SS400, S50C		合金鋼 Alloy steels (200~250HB) SCM440, SNCM		ステンレス鋼・工具鋼 Stainless steels, Tool steels (25~35HRC) SUS304, SKD		プリハードン鋼 Pre-hardened steels (35~45HRC) HPM1, NAK55		焼入れ鋼 Hardened steels (45~55HRC) SKD61, SKT4		チタン合金 Titanium alloys Ti-6Al-4V		超耐熱合金 Super heat-resistant alloys Inconel Hasteloy		
	切込み Depth of cut (mm) $a_p=1.5DC$ $a_e=0.1DC$		$a_p=1.5DC$ $a_e=0.1DC$		$a_p=1.5DC$ $a_e=0.1DC$		$a_p=1.5DC$ $a_e=0.1DC$		$a_p=1.5DC$ $a_e=0.1DC$		$a_p=1.5DC$ $a_e=0.05DC$		$a_p=1.5DC$ $a_e=0.05DC$		$a_p=1.5DC$ $a_e=0.05DC$		
外径DC Tool dia. (mm)	回転数 n (min^{-1})	送り速度 V_f (mm/min)	回転数 n (min^{-1})	送り速度 V_f (mm/min)	回転数 n (min^{-1})	送り速度 V_f (mm/min)	回転数 n (min^{-1})	送り速度 V_f (mm/min)	回転数 n (min^{-1})	送り速度 V_f (mm/min)	回転数 n (min^{-1})	送り速度 V_f (mm/min)	回転数 n (min^{-1})	送り速度 V_f (mm/min)	回転数 n (min^{-1})	送り速度 V_f (mm/min)	
高速条件 High speed	φ3	12,700	1,020	12,700	1,020	10,600	850	8,490	510	8,490	510	6,370	250	6,370	250	2,650	110
	φ4	9,550	1,150	9,550	1,150	7,960	960	6,370	640	6,370	640	4,770	380	4,770	380	1,990	160
	φ5	7,640	1,220	7,640	1,220	6,370	1,020	5,090	710	5,090	710	3,820	460	3,820	460	1,590	190
	φ6	6,370	1,270	6,370	1,270	5,310	1,060	4,240	680	4,240	680	3,180	450	3,180	450	1,330	190
	φ8	4,770	1,340	4,770	1,340	3,980	1,110	3,180	640	3,180	640	2,390	430	2,390	430	990	180
	φ10	3,820	1,220	3,820	1,220	3,180	1,020	2,550	610	2,550	610	1,910	420	1,910	420	800	180
	φ12	3,180	1,140	3,180	1,140	2,650	950	2,120	590	2,120	590	1,590	380	1,590	380	660	160
	φ16	2,390	960	2,390	960	1,990	800	1,590	540	1,590	540	1,190	330	1,190	330	500	140
φ20	1,910	920	1,910	920	1,590	760	1,270	510	1,270	510	950	300	950	300	400	130	
汎用条件 General	φ3	10,600	850	10,600	850	8,490	680	6,370	380	6,370	380	4,240	170	4,240	170	2,120	85
	φ4	7,960	960	7,960	960	6,370	760	4,770	480	4,770	480	3,180	250	3,180	250	1,590	130
	φ5	6,370	1,020	6,370	1,020	5,090	810	3,820	530	3,820	530	2,550	310	2,550	310	1,270	150
	φ6	5,310	1,060	5,310	1,060	4,240	850	3,180	510	3,180	510	2,120	300	2,120	300	1,060	150
	φ8	3,980	1,110	3,980	1,110	3,180	890	2,390	480	2,390	480	1,590	290	1,590	290	800	140
	φ10	3,180	1,020	3,180	1,020	2,550	820	1,910	460	1,910	460	1,270	280	1,270	280	640	140
	φ12	2,650	950	2,650	950	2,120	760	1,590	450	1,590	450	1,060	250	1,060	250	530	130
	φ16	1,990	800	1,990	800	1,590	640	1,190	400	1,190	400	800	220	800	220	400	110
φ20	1,590	760	1,590	760	1,270	610	950	380	950	380	640	200	640	200	320	100	

【注意】

- ① 切削方法は、ダウンカットで使用ください。
- ② 一般材、とくに高速切削は、乾式（エアブロー）またはオイルミストクーラントにてご使用ください。
- ③ ステンレス鋼および超耐熱合金には、不水溶性切削油のご使用が適しています。
- ④ 安定した切削を行うため、剛性の高い機械とセットアップでご使用ください。
- ⑤ 機械の回転数が足りない場合は、主軸回転数とテーブル送り速度を同比率で下げてください。
- ⑥ 加工形状、機械の剛性、工具突き出し量等、ご使用の状況により、主軸回転数とテーブル送り速度の調整を行ってください。

【Note】

- ① Down-cutting is recommended.
- ② Use generally dry (air-blow) or oil-mist coolant, especially at the high-speed machining.
- ③ Oil base coolant is recommended for machining stainless steels and heat-resistant alloys.
- ④ Use a machine tool with rigidity and rigid set-up, to machine stably.
- ⑤ When the revolution speed is not enough, reduce the revolution speed and table speed at the same ratio.
- ⑥ Adjust the revolution speed and table speed, according to cutting conditions such as machining shape, rigidity of machine tool, over-hang and so on.

Epoch Power Mill エポックパワーミル

EPP

レギュラー刃長
Regular

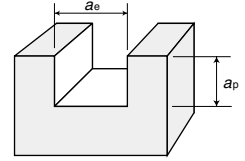

<溝切削> Slotting

被削材 Work material	鋳鉄 Cast irons (150~200HB) FC250		炭素鋼 Carbon steels (180~220HB) SS400, S50C		合金鋼 Alloy steels (200~250HB) SCM440, SNCM		ステンレス鋼・工具鋼 Stainless steels, Tool steels (25~35HRC) SUS304, SKD		プリハードン鋼 Pre-hardened steels (35~45HRC) HPM1, NAK55		焼入れ鋼 Hardened steels (45~55HRC) SKD61, SKT4		チタン合金 Titanium alloys Ti-6Al-4V		超耐熱合金 Super heat-resistant alloys Inconel Hasteloy			
	切込み Depth of cut (mm)	$a_p \leq 0.5DC$ $a_e = 1DC$	切込み Depth of cut (mm)	$a_p \leq 0.5DC$ $a_e = 1DC$	切込み Depth of cut (mm)	$a_p \leq 0.5DC$ $a_e = 1DC$	切込み Depth of cut (mm)	$a_p \leq 0.2DC$ $a_e = 1DC$	切込み Depth of cut (mm)	$a_p \leq 0.2DC$ $a_e = 1DC$	切込み Depth of cut (mm)	$a_p \leq 0.2DC$ $a_e = 1DC$	切込み Depth of cut (mm)	$a_p \leq 0.2DC$ $a_e = 1DC$	切込み Depth of cut (mm)	$a_p \leq 0.2DC$ $a_e = 1DC$		
高速条件 High speed	外径DC Tool dia. (mm)	回転数 n (min ⁻¹)	送り速度 v_f (mm/min)	回転数 n (min ⁻¹)	送り速度 v_f (mm/min)	回転数 n (min ⁻¹)	送り速度 v_f (mm/min)	回転数 n (min ⁻¹)	送り速度 v_f (mm/min)	回転数 n (min ⁻¹)	送り速度 v_f (mm/min)	回転数 n (min ⁻¹)	送り速度 v_f (mm/min)	回転数 n (min ⁻¹)	送り速度 v_f (mm/min)	回転数 n (min ⁻¹)	送り速度 v_f (mm/min)	
	$\phi 3$	5,310	420	8,490	680	7,430	590	5,310	320	5,310	320							
	$\phi 4$	3,980	480	6,370	760	5,570	670	3,980	400	3,980	400							
	$\phi 5$	3,180	510	5,090	810	4,460	710	3,180	450	3,180	450							
	$\phi 6$	2,650	530	4,240	850	3,710	740	2,650	420	2,650	420							
	$\phi 8$	1,990	560	3,180	890	2,790	780	1,990	400	1,990	400							
	$\phi 10$	1,590	510	2,550	820	2,230	710	1,590	380	1,590	380							
	$\phi 12$	1,330	480	2,120	760	1,860	670	1,330	370	1,330	370							
	$\phi 16$	990	400	1,590	640	1,390	560	990	340	990	340							
	$\phi 20$	800	380	1,270	610	1,110	530	800	320	800	320							
汎用条件 General	外径DC Tool dia. (mm)	回転数 n (min ⁻¹)	送り速度 v_f (mm/min)	回転数 n (min ⁻¹)	送り速度 v_f (mm/min)	回転数 n (min ⁻¹)	送り速度 v_f (mm/min)	回転数 n (min ⁻¹)	送り速度 v_f (mm/min)	回転数 n (min ⁻¹)	送り速度 v_f (mm/min)	回転数 n (min ⁻¹)	送り速度 v_f (mm/min)	回転数 n (min ⁻¹)	送り速度 v_f (mm/min)	回転数 n (min ⁻¹)	送り速度 v_f (mm/min)	
	$\phi 3$	3,180	250	7,430	590	5,310	420	4,240	250	4,240	250	2,120	85	3,180	130	1,590	65	
	$\phi 4$	2,390	290	5,570	670	3,980	480	3,180	320	3,180	320	1,590	130	2,390	190	1,190	95	
	$\phi 5$	1,910	310	4,460	710	3,180	510	2,550	360	2,550	360	1,270	150	1,910	230	950	110	
	$\phi 6$	1,590	320	3,710	740	2,650	530	2,120	340	2,120	340	1,060	150	1,590	220	800	110	
	$\phi 8$	1,190	330	2,790	780	1,990	560	1,590	320	1,590	320	800	140	1,190	210	600	110	
	$\phi 10$	950	300	2,230	710	1,590	510	1,270	300	1,270	300	640	140	950	210	480	110	
	$\phi 12$	800	290	1,860	670	1,330	480	1,060	300	1,060	300	530	130	800	190	400	95	
	$\phi 16$	600	240	1,390	560	990	400	800	270	800	270	400	110	600	170	300	85	
	$\phi 20$	480	230	1,110	530	800	380	640	260	640	260	320	100	480	150	240	75	

- 【注意】** ①一般材、とくに高速切削は、乾式（エアブロー）またはオイルミストクーラントにてご使用ください。
 ②ステンレス鋼および超耐熱合金には、不水溶性切削油のご使用が適しています。
 ③安定した切削を行うため、剛性の高い機械とセットアップでご使用ください。
 ④機械の回転数が足りない場合は、主軸回転数とテーブル送り速度を同比率で下げてください。
 ⑤加工形状、機械の剛性、工具突き出し量等、ご使用の状況により、主軸回転数とテーブル送り速度の調整を行ってください。

- 【Note】** ① Use generally dry (air-blow) or oil-mist coolant, especially at the high-speed machining.
 ② Oil base coolant is recommended for machining stainless steels and heat-resistant alloys.
 ③ Use a machine tool with rigidity and rigid set-up, to machine stably.
 ④ When the revolution speed is not enough, reduce the revolution speed and table speed at the same ratio.
 ⑤ Adjust the revolution speed and table speed, according to cutting conditions such as machining shape, rigidity of machine tool, over-hang and so on.

EPPM

ミディアム刃長
Medium

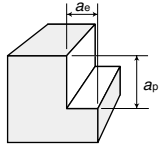

<側面切削> Side milling

被削材 Work material	鋳鉄 Cast irons (150~200HB) FC250		炭素鋼 Carbon steels (180~220HB) SS400, S50C		合金鋼 Alloy steels (200~250HB) SCM440, SNCM		ステンレス鋼・工具鋼 Stainless steels, Tool steels (25~35HRC) SUS304, SKD		プリハードン鋼 Pre-hardened steels (35~45HRC) HPM1, NAK55		焼入れ鋼 Hardened steels (45~55HRC) SKD61, SKT4		チタン合金 Titanium alloys Ti-6Al-4V		超耐熱合金 Super heat-resistant alloys Inconel Hastelloy	
	切込み Depth of cut (mm)	回転数 送り速度 n Vf (min ⁻¹) (mm/min)	回転数 送り速度 n Vf (min ⁻¹) (mm/min)	回転数 送り速度 n Vf (min ⁻¹) (mm/min)	回転数 送り速度 n Vf (min ⁻¹) (mm/min)	回転数 送り速度 n Vf (min ⁻¹) (mm/min)	回転数 送り速度 n Vf (min ⁻¹) (mm/min)	回転数 送り速度 n Vf (min ⁻¹) (mm/min)	回転数 送り速度 n Vf (min ⁻¹) (mm/min)	回転数 送り速度 n Vf (min ⁻¹) (mm/min)	回転数 送り速度 n Vf (min ⁻¹) (mm/min)	回転数 送り速度 n Vf (min ⁻¹) (mm/min)	回転数 送り速度 n Vf (min ⁻¹) (mm/min)	回転数 送り速度 n Vf (min ⁻¹) (mm/min)	回転数 送り速度 n Vf (min ⁻¹) (mm/min)	回転数 送り速度 n Vf (min ⁻¹) (mm/min)
切込み Depth of cut (mm)	ap=2.5DC ae=0.02DC		ap=2.5DC ae=0.02DC		ap=2.5DC ae=0.02DC		ap=2.5DC ae=0.02DC		ap=2.5DC ae=0.02DC		ap=2.5DC ae=0.01DC		ap=2.5DC ae=0.01DC		ap=2.5DC ae=0.01DC	
外径DC Tool dia. (mm)	回転数 送り速度 n Vf (min ⁻¹) (mm/min)	回転数 送り速度 n Vf (min ⁻¹) (mm/min)	回転数 送り速度 n Vf (min ⁻¹) (mm/min)	回転数 送り速度 n Vf (min ⁻¹) (mm/min)	回転数 送り速度 n Vf (min ⁻¹) (mm/min)	回転数 送り速度 n Vf (min ⁻¹) (mm/min)	回転数 送り速度 n Vf (min ⁻¹) (mm/min)	回転数 送り速度 n Vf (min ⁻¹) (mm/min)	回転数 送り速度 n Vf (min ⁻¹) (mm/min)	回転数 送り速度 n Vf (min ⁻¹) (mm/min)	回転数 送り速度 n Vf (min ⁻¹) (mm/min)	回転数 送り速度 n Vf (min ⁻¹) (mm/min)	回転数 送り速度 n Vf (min ⁻¹) (mm/min)	回転数 送り速度 n Vf (min ⁻¹) (mm/min)	回転数 送り速度 n Vf (min ⁻¹) (mm/min)	回転数 送り速度 n Vf (min ⁻¹) (mm/min)
φ3	7,430	590	7,430	590	5,840	470	4,240	250	4,240	250	2,650	110	2,650	110	1,590	65
φ4	5,570	670	5,570	670	4,380	530	3,180	320	3,180	320	1,990	160	1,990	160	1,190	95
φ5	4,460	710	4,460	710	3,500	560	2,550	360	2,550	360	1,590	190	1,590	190	950	110
φ6	3,710	740	3,710	740	2,920	580	2,120	340	2,120	340	1,330	190	1,330	190	800	110
φ8	2,790	780	2,790	780	2,190	610	1,590	320	1,590	320	990	180	990	180	600	110
φ10	2,230	710	2,230	710	1,750	560	1,270	300	1,270	300	800	180	800	180	480	110
φ12	1,860	670	1,860	670	1,460	530	1,060	300	1,060	300	660	160	660	160	400	95
φ16	1,390	560	1,390	560	1,090	440	800	270	800	270	500	140	500	140	300	85
φ20	1,110	530	1,110	530	880	420	640	260	640	260	400	130	400	130	240	75

EPPL

ロング刃長
Long

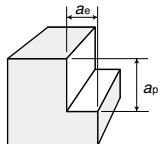

<側面切削> Side milling

被削材 Work material	鋳鉄 Cast irons (150~200HB) FC250		炭素鋼 Carbon steels (180~220HB) SS400, S50C		合金鋼 Alloy steels (200~250HB) SCM440, SNCM		ステンレス鋼・工具鋼 Stainless steels, Tool steels (25~35HRC) SUS304, SKD		プリハードン鋼 Pre-hardened steels (35~45HRC) HPM1, NAK55		焼入れ鋼 Hardened steels (45~55HRC) SKD61, SKT4		チタン合金 Titanium alloys Ti-6Al-4V		超耐熱合金 Super heat-resistant alloys Inconel Hastelloy	
	切込み Depth of cut (mm)	回転数 送り速度 n Vf (min ⁻¹) (mm/min)	回転数 送り速度 n Vf (min ⁻¹) (mm/min)	回転数 送り速度 n Vf (min ⁻¹) (mm/min)	回転数 送り速度 n Vf (min ⁻¹) (mm/min)	回転数 送り速度 n Vf (min ⁻¹) (mm/min)	回転数 送り速度 n Vf (min ⁻¹) (mm/min)	回転数 送り速度 n Vf (min ⁻¹) (mm/min)	回転数 送り速度 n Vf (min ⁻¹) (mm/min)	回転数 送り速度 n Vf (min ⁻¹) (mm/min)	回転数 送り速度 n Vf (min ⁻¹) (mm/min)	回転数 送り速度 n Vf (min ⁻¹) (mm/min)	回転数 送り速度 n Vf (min ⁻¹) (mm/min)	回転数 送り速度 n Vf (min ⁻¹) (mm/min)	回転数 送り速度 n Vf (min ⁻¹) (mm/min)	回転数 送り速度 n Vf (min ⁻¹) (mm/min)
切込み Depth of cut (mm)	ap=3DC ae=0.02DC		ap=3DC ae=0.02DC		ap=3DC ae=0.02DC		ap=3DC ae=0.02DC		ap=3DC ae=0.02DC		ap=3DC ae=0.01DC		ap=3DC ae=0.01DC		ap=3DC ae=0.01DC	
外径DC Tool dia. (mm)	回転数 送り速度 n Vf (min ⁻¹) (mm/min)	回転数 送り速度 n Vf (min ⁻¹) (mm/min)	回転数 送り速度 n Vf (min ⁻¹) (mm/min)	回転数 送り速度 n Vf (min ⁻¹) (mm/min)	回転数 送り速度 n Vf (min ⁻¹) (mm/min)	回転数 送り速度 n Vf (min ⁻¹) (mm/min)	回転数 送り速度 n Vf (min ⁻¹) (mm/min)	回転数 送り速度 n Vf (min ⁻¹) (mm/min)	回転数 送り速度 n Vf (min ⁻¹) (mm/min)	回転数 送り速度 n Vf (min ⁻¹) (mm/min)	回転数 送り速度 n Vf (min ⁻¹) (mm/min)	回転数 送り速度 n Vf (min ⁻¹) (mm/min)	回転数 送り速度 n Vf (min ⁻¹) (mm/min)	回転数 送り速度 n Vf (min ⁻¹) (mm/min)	回転数 送り速度 n Vf (min ⁻¹) (mm/min)	回転数 送り速度 n Vf (min ⁻¹) (mm/min)
φ6	2,650	530	2,650	530	2,120	420	1,590	250	1,590	250	1,060	150	1,060	150	530	75
φ8	1,990	560	1,990	560	1,590	450	1,190	240	1,190	240	800	140	800	140	400	70
φ10	1,590	510	1,590	510	1,270	410	950	230	950	230	640	140	640	140	320	70
φ12	1,330	480	1,330	480	1,060	380	800	220	800	220	530	130	530	130	270	65
φ16	990	400	990	400	800	320	600	200	600	200	400	110	400	110	200	55
φ20	800	380	800	380	640	310	480	190	480	190	320	100	320	100	160	50

EPPLS

ロングシャンク
Long Shank

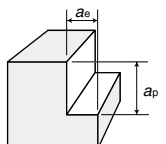

<側面切削> Side milling

被削材 Work material	鋳鉄 Cast irons (150~200HB) FC250		炭素鋼 Carbon steels (180~220HB) SS400, S50C		合金鋼 Alloy steels (200~250HB) SCM440, SNCM		ステンレス鋼・工具鋼 Stainless steels, Tool steels (25~35HRC) SUS304, SKD		プリハードン鋼 Pre-hardened steels (35~45HRC) HPM1, NAK55		焼入れ鋼 Hardened steels (45~55HRC) SKD61, SKT4		チタン合金 Titanium alloys Ti-6Al-4V		超耐熱合金 Super heat-resistant alloys Inconel Hastelloy	
	切込み Depth of cut (mm)	回転数 送り速度 n Vf (min ⁻¹) (mm/min)	回転数 送り速度 n Vf (min ⁻¹) (mm/min)	回転数 送り速度 n Vf (min ⁻¹) (mm/min)	回転数 送り速度 n Vf (min ⁻¹) (mm/min)	回転数 送り速度 n Vf (min ⁻¹) (mm/min)	回転数 送り速度 n Vf (min ⁻¹) (mm/min)	回転数 送り速度 n Vf (min ⁻¹) (mm/min)	回転数 送り速度 n Vf (min ⁻¹) (mm/min)	回転数 送り速度 n Vf (min ⁻¹) (mm/min)	回転数 送り速度 n Vf (min ⁻¹) (mm/min)	回転数 送り速度 n Vf (min ⁻¹) (mm/min)	回転数 送り速度 n Vf (min ⁻¹) (mm/min)	回転数 送り速度 n Vf (min ⁻¹) (mm/min)	回転数 送り速度 n Vf (min ⁻¹) (mm/min)	回転数 送り速度 n Vf (min ⁻¹) (mm/min)
切込み Depth of cut (mm)	ap=1.5DC ae=0.1DC		ap=1.5DC ae=0.1DC		ap=1.5DC ae=0.1DC		ap=1.5DC ae=0.1DC		ap=1.5DC ae=0.1DC		ap=1.5DC ae=0.05DC		ap=1.5DC ae=0.05DC		ap=1.5DC ae=0.05DC	
外径DC Tool dia. (mm)	回転数 送り速度 n Vf (min ⁻¹) (mm/min)	回転数 送り速度 n Vf (min ⁻¹) (mm/min)	回転数 送り速度 n Vf (min ⁻¹) (mm/min)	回転数 送り速度 n Vf (min ⁻¹) (mm/min)	回転数 送り速度 n Vf (min ⁻¹) (mm/min)	回転数 送り速度 n Vf (min ⁻¹) (mm/min)	回転数 送り速度 n Vf (min ⁻¹) (mm/min)	回転数 送り速度 n Vf (min ⁻¹) (mm/min)	回転数 送り速度 n Vf (min ⁻¹) (mm/min)	回転数 送り速度 n Vf (min ⁻¹) (mm/min)	回転数 送り速度 n Vf (min ⁻¹) (mm/min)	回転数 送り速度 n Vf (min ⁻¹) (mm/min)	回転数 送り速度 n Vf (min ⁻¹) (mm/min)	回転数 送り速度 n Vf (min ⁻¹) (mm/min)	回転数 送り速度 n Vf (min ⁻¹) (mm/min)	回転数 送り速度 n Vf (min ⁻¹) (mm/min)
φ3	5,310	420	5,310	420	4,240	340	3,180	190	3,180	190	2,120	85	2,120	85	1,060	42
φ4	3,980	480	3,980	480	3,180	380	2,390	240	2,390	240	1,590	130	1,590	130	800	65
φ5	3,180	510	3,180	510	2,550	410	1,910	270	1,910	270	1,270	150	1,270	150	640	75
φ6	2,650	530	2,650	530	2,120	420	1,590	250	1,590	250	1,060	150	1,060	150	530	75
φ8	1,990	560	1,990	560	1,590	450	1,190	240	1,190	240	800	140	800	140	400	70
φ10	1,590	510	1,590	510	1,270	410	950	230	950	230	640	140	640	140	320	70
φ12	1,330	480	1,330	480	1,060	380	800	220	800	220	530	130	530	130	270	65
φ16	990	400	990	400	800	320	600	200	600	200	400	110	400	110	200	55

- [注意]**
- ① 切削方法は、ダウンカットで使用ください。
 - ② 一般材、とくに高速切削は、乾式（エアブロー）またはオイルミストクーラントにてご使用ください。
 - ③ ステンレス鋼および超耐熱合金には、不水溶性切削油のご使用が適しています。
 - ④ 安定した切削を行うため、剛性の高い機械とセットアップでご使用ください。
 - ⑤ 機械の回転数が足りない場合は、主軸回転数とテーブル送り速度を同比率で下げてください。
 - ⑥ 加工形状、機械の剛性、工具突き出し量等、ご使用の状況により、主軸回転数とテーブル送り速度の調整を行ってください。

- [Note]**
- (1) Down-cutting is recommended.
 - (2) Use generally dry (air-blow) or oil-mist coolant, especially at the high-speed machining.
 - (3) Oil base coolant is recommended for machining stainless steels and heat-resistant alloys.
 - (4) Use a machine tool with rigidity and rigid set-up, to machine stably.
 - (5) When the revolution speed is not enough, reduce the revolution speed and table speed at the same ratio.
 - (6) Adjust the revolution speed and table speed, according to cutting conditions such as machining shape, rigidity of machine tool, over-hand and so on.

8-flutes End Mill for Vertical Wall/Bottom Face Finishing 立壁／底面仕上げ用8枚刃エンドミル



立壁と底面の仕上げ加工の”極”これ1本で立壁と底面を仕上げる!!
The Zenith of Milling for Vertical Wall and Bottom Face Finishing
Vertical wall and bottom face finishing with a single tool!

外径公差 φ6 : 0~-0.015
φ7~φ12 : 0~-0.02

h5 h6
φ6,8,10,12 φ7,9,11 (mm)

ラジウスはA254頁を参照してください
Please refer to page A254 for Radius

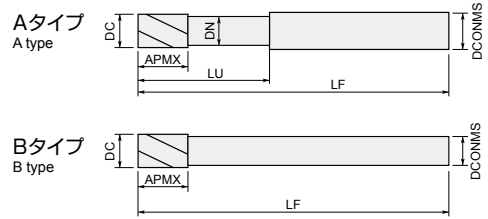

ES8WB LN(LS)-ATH



商品コード Item code	在庫 Stock	寸法 Size(mm)						形状 Shape	希望小売価格 Suggested retail price(¥)
		外径 Tool dia. DC	刃長 Flute length APMX	首下長 Under neck length LU	首径 Neck dia. DN	全長 Overall length LF	シャンク径 Shank dia. DCONMS		
ES8WB0600LN-20-ATH	●	6	6	20	5.88	70	6	A	14,500
ES8WB0600LN-30-ATH	●		6	30	5.88	80	6	A	15,090
ES8WB0600LN-40-ATH	●		6	40	5.88	90	6	A	15,690
ES8WB0600LN-50-ATH	●		6	50	5.88	100	6	A	16,310
ES8WB0700LS-ATH	●	7	7	-	-	90	6	B	21,800
ES8WB0800LN-30-ATH	●	8	8	30	7.84	75	8	A	16,040
ES8WB0800LN-40-ATH	●		8	40	7.84	90	8	A	17,010
ES8WB0800LN-50-ATH	●		8	50	7.84	100	8	A	17,760
ES8WB0800LN-60-ATH	●		8	60	7.84	110	8	A	19,000
ES8WB0900LS-ATH	●	9	9	-	-	100	8	B	24,840
ES8WB1000LN-35-ATH	●	10	10	35	9.8	80	10	A	19,060
ES8WB1000LN-50-ATH	●		10	50	9.8	100	10	A	20,890
ES8WB1000LN-60-ATH	●		10	60	9.8	110	10	A	22,220
ES8WB1000LN-80-ATH	●		10	80	9.8	130	10	A	24,220
ES8WB1100LS-ATH	●	11	11	-	-	110	10	B	29,690
ES8WB1200LN-40-ATH	●	12	12	40	11.8	90	12	A	23,270
ES8WB1200LN-60-ATH	●		12	60	11.8	110	12	A	25,790
ES8WB1200LN-80-ATH	●		12	80	11.8	130	12	A	28,020
ES8WB1200LN-100-ATH	●		12	100	11.8	150	12	A	30,270

○ 対応被削材 Applicable work material

炭素鋼 合金鋼 Carbon steel Alloy steel	プリハー ド鋼 Pre-hardened steel	高硬度 Hardened steel			ステン レス鋼 Stainless steel	チタン合金 耐熱合金 Titanium alloy Heat-resistant alloy	銅合金 Copper alloy	アルミ 合金 Aluminum alloy
		> 45HRC ≤ 55HRC	> 55HRC ≤ 65HRC	> 65HRC				
○	○	○						

○ : 標準在庫品です。 ● : Stocked items.

○ 再研磨対応外径範囲 Re-grinding compatibility range

商品コード Item code	外周 Outer dia. (mm)	エンド End (mm)
ES8WB-ATH	6 ~ 12	6 ~ 12

立壁仕上げ

Vertical wall finishing

被削材 Work material		炭素鋼・合金鋼 Carbon steels, Alloy steels (180~250HB)		工具鋼 Tool steels (25~35HRC)		プリハードン鋼 Pre-hardened steels (35~45HRC)		焼入れ鋼 Hardened steels (45~55HRC)		焼入れ鋼 Hardened steels (55~62HRC)		
商品コード Item code	軸切込み ap (mm)	径切込み ae (mm)	回転数 n (min ⁻¹)	送り速度 vf (mm/min)	回転数 n (min ⁻¹)	送り速度 vf (mm/min)	回転数 n (min ⁻¹)	送り速度 vf (mm/min)	回転数 n (min ⁻¹)	送り速度 vf (mm/min)	回転数 n (min ⁻¹)	送り速度 vf (mm/min)
ES8WB0600LN-20-ATH	3	≦0.1	7960	1910	6370	1530	4770	1140	3180	760	2650	640
ES8WB0600LN-30-ATH	3	≦0.1	6630	1590	5310	1270	3980	960	2650	640	2120	510
ES8WB0600LN-40-ATH	3	≦0.1	4640	780	3710	620	2790	470	1860	310	1490	250
ES8WB0600LN-50-ATH	3	≦0.1	3320	400	2650	320	1990	240	1330	160	1060	130
ES8WB0700LS-ATH	3.5	≦0.1	5680	1590	4550	1270	3410	950	2270	640	1820	510
ES8WB0800LN-30-ATH	4	≦0.1	5970	1910	4770	1530	3580	1150	2390	760	1990	640
ES8WB0800LN-40-ATH	4	≦0.1	4970	1590	3980	1270	2980	950	1990	640	1590	510
ES8WB0800LN-50-ATH	4	≦0.1	3480	890	2790	620	2090	540	1390	360	1110	280
ES8WB0800LN-60-ATH	4	≦0.1	2490	400	1990	320	1490	240	990	160	800	130
ES8WB0900LS-ATH	4.5	≦0.1	4420	1590	3540	1270	2650	950	1770	640	1410	510
ES8WB1000LN-35-ATH	5	≦0.1	4770	1910	3820	1530	2860	1140	1910	760	1590	640
ES8WB1000LN-50-ATH	5	≦0.1	3980	1590	3180	1270	2390	960	1590	640	1270	510
ES8WB1000LN-60-ATH	5	≦0.1	2790	890	2230	620	1670	530	1110	360	890	280
ES8WB1000LN-80-ATH	5	≦0.1	1990	400	1590	320	1190	240	800	160	640	130
ES8WB1100LS-ATH	5.5	≦0.1	3620	1510	2890	1210	2170	910	1450	610	1160	480
ES8WB1200LN-40-ATH	6	≦0.1	3980	1720	3180	1370	2390	1030	1590	690	1330	570
ES8WB1200LN-60-ATH	6	≦0.1	3320	1430	2650	1140	1990	860	1330	570	1060	460
ES8WB1200LN-80-ATH	6	≦0.1	2320	700	1860	560	1390	420	930	280	740	220
ES8WB1200LN-100-ATH	6	≦0.1	1660	360	1330	290	990	210	660	140	530	110

※ロングシャンクタイプ(φ7,9,11)の切削条件は工具突き出し量が5DC(工具径×5倍)時の条件です。突き出し量を変更する場合は下記補正値を参考に条件を設定ください。
* Cutting conditions for the long-shank type (φ7/9/11) are for a tool projection of 5DC (tool diameter × 5). Modify the conditions using the following correction factors if the projection amount changes:

ロングシャンクタイプの切削条件補正値 Cutting condition correction factors for long-shank type (%)

被削材 Work material		炭素鋼・合金鋼 Carbon steels, Alloy steels (180~250HB)		工具鋼 Tool steels (25~35HRC)		プリハードン鋼 Pre-hardened steels (35~45HRC)		焼入れ鋼 Hardened steels (45~55HRC)		焼入れ鋼 Hardened steels (55~62HRC)		
突出し量 Projection	軸切込み ap (mm)	径切込み ae (mm)	回転数 n (min ⁻¹)	送り速度 vf (mm/min)	回転数 n (min ⁻¹)	送り速度 vf (mm/min)	回転数 n (min ⁻¹)	送り速度 vf (mm/min)	回転数 n (min ⁻¹)	送り速度 vf (mm/min)	回転数 n (min ⁻¹)	送り速度 vf (mm/min)
5DC	100%	100%	100%	100%	100%	100%	100%	100%	100%	100%	100%	100%
6DC	100%	100%	70%	60%	70%	60%	70%	60%	70%	60%	70%	60%
7DC	100%	100%	70%	50%	70%	50%	70%	50%	70%	50%	70%	50%

- 【注意】** ①被削材、加工形状に合わせて、適切なクーラントを使用してください。
②できるだけ高剛性、高精度の機械をご使用ください。
③この切削条件表は切削条件の目安を示すものです。実際の加工では加工形状、目的、使用機械等により条件を調整してください。
④機械の回転数が足りない場合は、回転数と送り速度を同じ比率で下げてください。

- 【Note】** ① Use the appropriate coolant for the work material and machining shape.
② Use a highly rigid and accurate machine as possible.
③ These Recommended Cutting Conditions indicate only the rule of a thumb for the cutting conditions. In actual machining, the condition should be adjusted according to the machining shape, purpose and the machine type.
④ If the rpm available is lower than that recommended please reduce the feed rate to the same ratio.

Epoch Mirus Type R エポックミルス タイプ R



4枚刃・スクエア・ストレート 4 flutes, Square, Straight

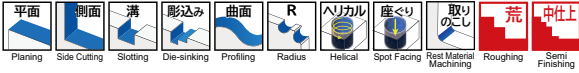

外径公差 Dia.tolerance 0~-0.05 (mm)

h5 h6
φ6~12 φ16, φ20

高切り込み&高送りにより驚異の加工効率を実現。
Achieves amazing machining efficiency with high cutting depth and high feed rate.

ラジラスはA259頁を参照してください
Please refer to page A259 for Radius



EMXR4-TH

商品コード Item code	在庫 Stock	寸法 Size (mm)					刃数 No. of flutes	希望小売価格 (円) Suggested retail price(¥)
		外径 Tool dia.	刃長 Flute length	全長 Overall length	シャンク径 Shank dia.	近似R※ Approx radius		
		DC	APMX	LF	DCONMS			
EMXR4060-TH	●	6	9	60	6	0.4	4	15,940
EMXR4080-TH	●	8	12	75	8	0.5	4	19,530
EMXR4100-TH	●	10	15	80	10	0.5	4	26,260
EMXR4120-TH	●	12	18	100	12	0.5	4	33,330
EMXR4160-TH	●	16	24	110	16	0.7	4	81,070
EMXR4200-TH	●	20	30	125	20	0.7	4	118,480

4枚刃・スクエア・セミロングシャンク 4 flutes, Square, Semi long shank



外径公差 Dia.tolerance 0~-0.05 (mm)

h6

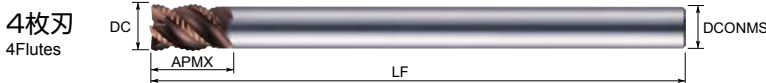

EMXR4-SR-TH

商品コード Item code	在庫 Stock	寸法 Size (mm)					刃数 No. of flutes	希望小売価格 (円) Suggested retail price(¥)
		外径 Tool dia.	刃長 Flute length	全長 Overall length	シャンク径 Shank dia.	近似R※ Approx radius		
		DC	APMX	LF	DCONMS			
EMXR4070-SR-TH	●	7	9	90	6	0.4	4	19,080
EMXR4090-SR-TH	●	9	12	100	8	0.5	4	23,460
EMXR4110-SR-TH	●	11	15	110	10	0.5	4	31,540
EMXR4130-SR-TH	●	13	18	120	12	0.7	4	55,720

※スクエアタイプのエンド刃先はチッピング防止のため、特殊形状になっています。CAM設定の際に、コーナーRサイズを近似Rで設定してください。
Special geometry is adopted on tip of square type, for chipping resistance. please set up tool corner R with approx R for both type.

EMXR-TH、EMXR-SR-THの対応被削材

Applicable work material of EMXR-TH, EMXR-SR-TH

炭素鋼 合金鋼 Carbon steel Alloy steel	プリハー ド鋼 Pre-hardened steel ≤ 45HRC	高硬度 Hardened steel			ステン レス鋼 Stainless steel	チタン合金 耐熱合金 Titanium alloy Heat-resistant alloy	銅合金 Copper alloy	アルミ 合金 Aluminum alloy
		> 45HRC ≤ 55HRC	> 55HRC ≤ 65HRC	> 65HRC				
○	○	○	○	○	○	○	○	

再研磨対応外径範囲

Re-grinding compatibility range

商品コード Item code	外周 Outer dia. (mm)	エンド End (mm)
EMXR-TH	6 ~ 20	6 ~ 20
EMXR-SR-TH	7 ~ 13	7 ~ 13

●印：標準在庫品です。 ●：Stocked items.

Epoch Mirus Type N エポックミルス タイプ N

高切り込み&高送りにより驚異の加工効率を実現。
Achieves amazing machining efficiency with high cutting depth and high feed rate.

4枚刃・スクエア・ストレート 4 flutes, Square, Straight

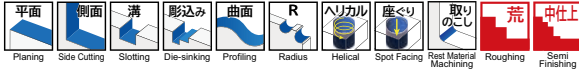

ラジウスはA260頁を参照してください
Please refer to page A260 for Radius

外径公差 Dia.tolerance 0~-0.03

h5 h6
φ6~12 φ16,φ20 (mm)

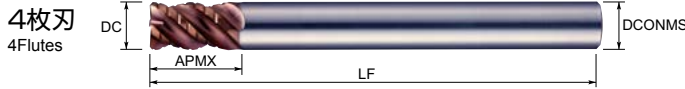

EMXN4-TH

超硬 Carbide ATH ねじり45° Helix angle 切削条件表 A348 Cutting Conditions

商品コード Item code	在庫 Stock	寸法 Size (mm)					刃数 No. of flutes	希望小売価格 (円) Suggested retail price (¥)
		外径 Tool dia.	刃長 Flute length	全長 Overall length	シャンク径 Shank dia.	近似R※ Approx radius		
		DC	APMX	LF	DCONMS			
EMXN4060-TH	●	6	9	60	6	0.4	4	15,940
EMXN4080-TH	●	8	12	75	8	0.5	4	19,530
EMXN4100-TH	●	10	15	80	10	0.5	4	26,260
EMXN4120-TH	●	12	18	100	12	0.5	4	33,330
EMXN4160-TH	●	16	24	110	16	0.7	4	81,070
EMXN4200-TH	●	20	30	125	20	0.7	4	118,480

4枚刃・スクエア・セミロングシャンク 4 flutes, Square, Semi long shank

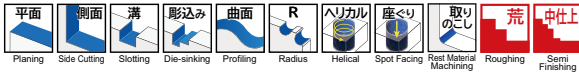

外径公差 Dia.tolerance 0~-0.03

h6 (mm)

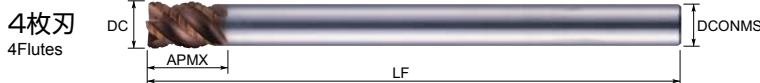

EMXN4-SR-TH

超硬 Carbide ATH ねじり45° Helix angle 切削条件表 A349 Cutting Conditions

商品コード Item code	在庫 Stock	寸法 Size (mm)					刃数 No. of flutes	希望小売価格 (円) Suggested retail price (¥)
		外径 Tool dia.	刃長 Flute length	全長 Overall length	シャンク径 Shank dia.	近似R※ Approx radius		
		DC	APMX	LF	DCONMS			
EMXN4070-SR-TH	●	7	9	90	6	0.4	4	19,080
EMXN4090-SR-TH	●	9	12	100	8	0.5	4	23,460
EMXN4110-SR-TH	●	11	15	110	10	0.5	4	31,540
EMXN4130-SR-TH	●	13	18	120	12	0.5	4	55,720

※スクエアタイプのエンド刃先はチッピング防止のため、特殊形状になっています。CAM設定の際に、コーナーRサイズを近似Rで設定してください。
Special geometry is adopted on tip of square type, for chipping resistance. please set up tool corner R with approx R for both type.

EMXN-TH、EMXN-SR-THの対応被削材

Applicable work material of EMXN-TH, EMXN-SR-TH

炭素鋼 合金鋼 Carbon steel Alloy steel	プリハードン 鋼 Pre-hardened steel	高硬度 Hardened steel			ステンレス 鋼 Stainless steel	チタン合金 耐熱合金 Titanium alloy Heat-resistant alloy	銅合金 Copper alloy	アルミ 合金 Aluminum alloy
	≤ 45HRC	> 45HRC ≤ 55HRC	> 55HRC ≤ 65HRC	> 65HRC				
○	○	○	○	○	○	○	○	

再研磨対応外径範囲

Re-grinding compatibility range

商品コード Item code	外周 Outer dia. (mm)	エンド End (mm)
EMXN-TH	6 ~ 20	6 ~ 20
EMXN-SR-TH	7 ~ 13	7 ~ 13

標準切削条件表 Recommended cutting conditions

EMXR-TH **EMXN-TH** 4枚刃・スクエア・ストレート 4 flutes, Square, Straight

側面切削 Side milling

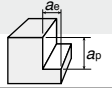

タイプR Type R	鋳鉄・炭素鋼・合金鋼 Cast irons, Carbon steels, Alloy steels (150~250HB) FC, S50C, SCM		工具鋼 Tool steels (25~35HRC) SKD		プリハードン鋼 Pre-hardened steels (35~45HRC) NAK80, CENA1		焼入れ鋼 Hardened steels (45~55HRC) SKD61, SKT4		タイプN Type N	鋳鉄・炭素鋼・合金鋼 Cast irons, Carbon steels, Alloy steels (150~250HB) FC, S50C, SCM		工具鋼 Tool steels (25~35HRC) SKD		ステンレス鋼 Stainless steels SUS		プリハードン鋼 Pre-hardened steels (35~45HRC) NAK80, CENA1		焼入れ鋼 Hardened steels (45~55HRC) SKD61, SKT4												
	切込み Depth of cut (mm)	$a_p=1.0DC$ $a_e=0.5DC$	$a_p=1.0DC$ $a_e=0.375DC$	$a_p=1.0DC$ $a_e=0.25DC$	$a_p=1.0DC$ $a_e=0.125DC$	$a_p=1.0DC$ $a_e=0.5DC$	$a_p=1.0DC$ $a_e=0.375DC$	$a_p=1.0DC$ $a_e=0.25DC$		$a_p=1.0DC$ $a_e=0.125DC$	切込み Depth of cut (mm)	$a_p=1.0DC$ $a_e=0.5DC$	$a_p=1.0DC$ $a_e=0.375DC$	$a_p=1.0DC$ $a_e=0.25DC$	$a_p=1.0DC$ $a_e=0.125DC$	外径DC Tool dia.(mm)	回転数 n rpm	送り速度 v_f mm/min	回転数 n rpm	送り速度 v_f mm/min	回転数 n rpm	送り速度 v_f mm/min	回転数 n rpm	送り速度 v_f mm/min	回転数 n rpm	送り速度 v_f mm/min	回転数 n rpm	送り速度 v_f mm/min	回転数 n rpm	送り速度 v_f mm/min
φ6	8,000	1,380	7,200	1,000	6,400	710	5,600	500	7,400	1,280	6,600	910	6,600	270	5,800	640	5,000	440	5,000	440	4,200	520	5,600	1,360	5,000	290	4,400	680	3,800	470
φ8	6,000	1,460	5,400	1,050	4,800	750	4,200	520	5,600	1,360	5,000	970	5,000	290	4,400	680	3,800	470	3,800	470	3,000	350	4,000	290	3,300	270	2,900	640	2,500	440
φ10	4,800	1,460	4,300	1,050	3,800	740	3,300	510	4,500	1,370	4,000	970	4,000	290	3,500	680	3,000	470	3,000	470	2,800	350	3,700	1,280	3,300	290	2,900	640	2,500	440
φ12	4,000	1,380	3,600	1,000	3,200	710	2,800	500	3,700	1,280	3,300	910	3,300	270	2,900	640	2,500	440	2,500	440	2,200	260	2,800	1,220	2,500	260	2,200	610	1,900	420
φ16	3,000	1,310	2,700	940	2,400	670	2,100	470	2,800	1,220	2,500	870	2,500	260	2,200	610	1,900	420	2,000	420	1,700	230	2,200	1,060	2,000	230	1,800	550	1,500	370
φ20	2,400	1,150	2,100	810	1,900	580	1,700	420	2,200	1,060	2,000	770	2,000	230	1,800	550	1,500	370	1,500	370	1,300	200	2,000	770	2,000	230	1,800	550	1,500	370

溝切削 Slotting

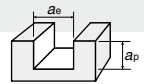

タイプR Type R	鋳鉄・炭素鋼・合金鋼 Cast irons, Carbon steels, Alloy steels (150~250HB) FC, S50C, SCM		工具鋼 Tool steels (25~35HRC) SKD		プリハードン鋼 Pre-hardened steels (35~45HRC) NAK80, CENA1		焼入れ鋼 Hardened steels (45~55HRC) SKD61, SKT4		タイプN Type N	鋳鉄・炭素鋼・合金鋼 Cast irons, Carbon steels, Alloy steels (150~250HB) FC, S50C, SCM		工具鋼 Tool steels (25~35HRC) SKD		ステンレス鋼 Stainless steels SUS		プリハードン鋼 Pre-hardened steels (35~45HRC) NAK80, CENA1		焼入れ鋼 Hardened steels (45~55HRC) SKD61, SKT4														
	切込み Depth of cut (mm)	$a_p=1.0DC$	$a_p=0.8DC$	$a_p=0.5DC$	$a_p=0.2DC$	$a_p=1.0DC$	$a_p=0.8DC$	$a_p=0.8DC$		$a_p=0.5DC$	$a_p=0.2DC$	切込み Depth of cut (mm)	$a_p=1.0DC$	$a_p=0.8DC$	$a_p=0.8DC$	$a_p=0.5DC$	$a_p=0.2DC$	外径DC Tool dia.(mm)	回転数 n rpm	送り速度 v_f mm/min	回転数 n rpm	送り速度 v_f mm/min	回転数 n rpm	送り速度 v_f mm/min	回転数 n rpm	送り速度 v_f mm/min	回転数 n rpm	送り速度 v_f mm/min	回転数 n rpm	送り速度 v_f mm/min	回転数 n rpm	送り速度 v_f mm/min
φ6	6,900	950	6,100	670	5,300	470	4,500	320	6,400	880	5,600	620	5,600	190	4,800	420	4,000	280	4,000	280	3,400	300	3,200	280	3,200	190	2,900	450	2,400	200	2,000	280
φ8	5,200	1,010	4,600	720	4,000	500	3,400	340	4,800	930	4,200	650	4,200	200	3,600	450	3,000	300	3,000	300	2,800	280	2,800	190	2,800	190	2,400	420	2,000	280		
φ10	4,100	1,000	3,700	720	3,200	500	2,700	340	3,800	920	3,300	640	3,300	190	2,900	450	2,400	300	2,400	300	2,200	280	2,200	190	2,200	190	1,800	400	1,500	270		
φ12	3,400	940	3,100	690	2,700	480	2,300	330	3,200	880	2,800	620	2,800	190	2,400	420	2,000	280	2,000	280	1,900	270	1,900	170	1,800	400	1,500	270	1,300	200		
φ16	2,600	910	2,300	640	2,000	450	1,700	300	2,400	840	2,100	580	2,100	170	1,800	400	1,500	270	1,500	270	1,400	240	1,400	160	1,400	340	1,200	240				
φ20	2,100	810	1,800	550	1,600	390	1,400	280	1,900	730	1,700	520	1,700	160	1,400	340	1,200	240	1,200	240	1,100	220	1,100	150	1,100	270	900	210	180			

傾斜切削 Ramping



タイプR Type R	鋳鉄・炭素鋼・合金鋼 Cast irons, Carbon steels, Alloy steels (150~250HB) FC, S50C, SCM		工具鋼 Tool steels (25~35HRC) SKD		プリハードン鋼 Pre-hardened steels (35~45HRC) NAK80, CENA1		焼入れ鋼 Hardened steels (45~55HRC) SKD61, SKT4		タイプN Type N	鋳鉄・炭素鋼・合金鋼 Cast irons, Carbon steels, Alloy steels (150~250HB) FC, S50C, SCM		工具鋼 Tool steels (25~35HRC) SKD		ステンレス鋼 Stainless steels SUS		プリハードン鋼 Pre-hardened steels (35~45HRC) NAK80, CENA1		焼入れ鋼 Hardened steels (45~55HRC) SKD61, SKT4		
	最大傾斜角 Max. ramping angle	30°以下 30° or less	15°以下 15° or less	15°以下 15° or less	5°以下 5° or less	20°以下 20° or less	10°以下 10° or less	5°以下 5° or less		10°以下 10° or less	5°以下 5° or less	最大傾斜角 Max. ramping angle	30°以下 30° or less	15°以下 15° or less	15°以下 15° or less	5°以下 5° or less	10°以下 10° or less	5°以下 5° or less	10°以下 10° or less	5°以下 5° or less
φ6	6,900	750	6,100	530	5,300	370	4,500	250	6,400	690	5,600	480	5,600	140	4,800	330	4,000	220	4,000	220
φ8	5,200	790	4,600	560	4,000	390	3,400	260	4,800	730	4,200	510	4,200	150	3,600	350	3,000	230	3,000	230
φ10	4,100	780	3,700	560	3,200	390	2,700	260	3,800	720	3,300	500	3,300	150	2,900	350	2,400	230	2,400	230
φ12	3,400	730	3,100	540	2,700	370	2,300	250	3,200	690	2,800	480	2,800	140	2,400	330	2,000	220	2,000	220
φ16	2,600	710	2,300	500	2,000	350	1,700	240	2,400	650	2,100	460	2,100	140	1,800	310	1,500	210	1,500	210
φ20	2,100	630	1,800	430	1,600	310	1,400	220	1,900	570	1,700	410	1,700	120	1,400	270	1,200	180	1,200	180

※タイプRはステンレス鋼及びチタン合金に推奨できません。

※Type R is not recommendable for milling stainless steel or Ti alloy.

- 【注意】**
- Z突込み切削は<溝切削>条件の回転数で、送り速度のみ1/3程度に下げてご使用ください。
 - できるだけ高剛性、高精度の機械をご使用ください。
 - この切削条件表は切削条件の目安を示すものです。実際の加工では加工形状、目的、使用機械等により条件を調整してください。
 - 機械の回転数が足りない場合には、回転数と送り速度を同じ比率で下げてください。
 - エアブローやクーラントの位置に十分ご注意ください。
 - 使用条件(コレット等)によっては、工具が抜ける恐れがありますので、機械・ホルダーの種類によって、条件を調整してください。

- Note**
- Please use rpm and 1/3 those of slotting cutting conditions respectively for Z plunging.
 - Use a highly rigid and accurate machine as possible.
 - These conditions are for general guidance; in actual machining conditions adjust the parameters according to your actual machine and work-piece conditions.
 - If the rpm available is lower than that recommended please reduce the feed rate to the same ratio.
 - Please ensure that air blow or coolant is correctly positioned in order to remove the chip immediately.
 - In order to avoid clamping looseness, Please adjust cutting conditions according to type of machine center and holder.

EMXR-TH **EMXN-TH** 4枚刃・スクエア・ストレート 4 flutes, Square, Straight

往復食い加工 Two-way profiling

タイプR Type R		タイプN Type N																									
材料 Material		工具鋼 Tool steels (25~35HRC) SKD				プリハードン鋼 Pre-hardened steels (35~45HRC) NAK80, CENA1				焼入れ鋼 Hardened steels (45~55HRC) SKD61, SKT4				工具鋼 Tool steels (25~35HRC) SKD				ステンレス鋼 Stainless steels SUS		プリハードン鋼 Pre-hardened steels (35~45HRC) NAK80, CENA1		焼入れ鋼 Hardened steels (45~55HRC) SKD61, SKT4					
切込み Depth of cut (mm)		最大max. $a_e=0.5DC$				最大max. $a_e=0.375DC$				最大max. $a_e=0.25DC$				最大max. $a_e=0.125DC$				最大max. $a_e=0.5DC$				最大max. $a_e=0.375DC$		最大max. $a_e=0.25DC$		最大max. $a_e=0.125DC$	
外径DC Tool dia. (mm)	切込み比率 Ratio to standard depth of cut	回転数 n mm/min		送り速度 v_f mm/min		回転数 n mm/min		送り速度 v_f mm/min		回転数 n mm/min		送り速度 v_f mm/min		回転数 n mm/min		送り速度 v_f mm/min		回転数 n mm/min		送り速度 v_f mm/min		回転数 n mm/min		送り速度 v_f mm/min			
		$\phi 6$	100%	8,000	1,730	7,200	1,240	6,400	880	5,600	620	7,400	1,600	6,600	1,140	6,600	340	5,800	800	5,000	550	5,000	370	4,400	860	3,800	590
$\phi 8$	100%	6,000	1,820	5,400	1,310	4,800	930	4,200	650	5,600	1,700	5,000	1,220	5,000	370	4,400	860	3,800	590	5,000	370	4,400	860	3,800	590		
$\phi 10$	100%	4,800	1,820	4,300	1,310	3,800	920	3,300	640	4,500	1,710	4,000	1,220	4,000	370	3,500	850	3,000	580	4,000	370	3,500	850	3,000	580		
$\phi 12$	100%	4,000	1,730	3,600	1,240	3,200	880	2,800	620	3,700	1,600	3,300	1,140	3,300	340	2,900	800	2,500	550	3,300	340	2,900	800	2,500	550		
$\phi 16$	100%	3,000	1,630	2,700	1,180	2,400	840	2,100	580	2,800	1,520	2,500	1,090	2,500	330	2,200	770	1,900	530	2,500	330	2,200	770	1,900	530		
$\phi 20$	100%	2,400	1,440	2,100	1,010	1,900	730	1,700	520	2,200	1,320	2,000	960	2,000	290	1,800	690	1,500	460	2,000	290	1,800	690	1,500	460		

※タイプRはステンレス鋼及びチタン合金に推奨できません。 ※Type R is not recommendable for milling stainless steel or Ti alloy.

【特長】 本工具を用いると、図①に示すような形状から、往復食い加工を行うことが可能です。
【注意】 図①形状の切削条件は側面切削条件を参照してください。

Features MIRUS has the capability of two-way profiling a work from geometry as figure 1 shown. Please refer to side milling cutting conditions for previous process.

Note Please refer to the precautions in previous page.

EMXR-SR-TH **EMXN-SR-TH** 4枚刃・スクエア・セミロングシャンク 4 flutes, Square, Semi long shank

側面切削 Side milling

タイプR Type R		タイプN Type N																									
材料 Material		工具鋼 Tool steels (25~35HRC) SKD				プリハードン鋼 Pre-hardened steels (35~45HRC) NAK80, CENA1				焼入れ鋼 Hardened steels (45~55HRC) SKD61, SKT4				工具鋼 Tool steels (25~35HRC) SKD				ステンレス鋼 Stainless steels SUS		プリハードン鋼 Pre-hardened steels (35~45HRC) NAK80, CENA1		焼入れ鋼 Hardened steels (45~55HRC) SKD61, SKT4					
外径DC Tool dia. (mm)	切込み比率 Ratio to standard depth of cut	回転数 n mm/min		送り速度 v_f mm/min		回転数 n mm/min		送り速度 v_f mm/min		回転数 n mm/min		送り速度 v_f mm/min		回転数 n mm/min		送り速度 v_f mm/min		回転数 n mm/min		送り速度 v_f mm/min		回転数 n mm/min		送り速度 v_f mm/min			
		$\phi 7$	100%	6,800	1,370	6,100	980	5,500	710	4,800	500	6,400	1,290	5,700	920	5,700	280	5,000	650	4,300	440	5,000	650	4,300	440	5,000	650
$\phi 9$	100%	5,300	1,450	4,800	1,050	4,200	740	3,700	520	5,000	1,370	4,400	960	4,400	290	3,900	680	3,400	480	4,400	290	3,900	680	3,400	480	4,400	290
$\phi 11$	100%	4,300	1,440	3,900	1,040	3,500	750	3,000	510	4,100	1,370	3,600	960	3,600	290	3,200	680	2,700	460	3,600	290	3,200	680	2,700	460	3,600	290
$\phi 13$	100%	3,700	1,390	3,300	990	2,900	690	2,600	500	3,400	1,270	3,100	930	3,100	280	2,700	650	2,300	440	3,100	280	2,700	650	2,300	440	3,100	280

※タイプRはステンレス鋼及びチタン合金に推奨できません。 ※Type R is not recommendable for milling stainless steel or Ti alloy.

【注意】 ① Z突込み切削は「溝切削」条件の回転数で、送り速度のみ1/3程度に下げてください。
 ② できるだけ高剛性、高精度の機械をご使用ください。
 ③ この切削条件表は切削条件の目安を示すものです。
 実際の加工では加工形状、目的、使用機械等により条件を調整してください。
 ④ 機械の回転数が足りない場合には、回転数と送り速度を同じ比率で下げてください。
 ⑤ エアブローやクーラントの位置に十分ご注意ください。
 ⑥ 使用条件(コレット等)によっては、工具が抜ける恐れがありますので、機械・ホルダーの種類によって、条件を調整してください。
 7 突出し量か4DCを超える場合の切込み量は、切込み比率を目安に調整してください。

Note ① Please use rpm and 1/3 those of slotting cutting conditions respectively for Z plunging.
 ② Use a highly rigid and accurate machine as possible.
 ③ These conditions are for general guidance; in actual machining conditions adjust the parameters according to your actual machine and work-piece conditions.
 ④ If the rpm available is lower than that recommended please reduce the feed rate to the same ratio.
 ⑤ Please ensure that air blow or coolant is correctly positioned in order to remove the chip immediately.
 ⑥ In order to avoid clamping looseness, Please adjust cutting conditions according to type of machine center and holder.
 ⑦ Please change ratio to standard depth of cut in the application with more than 4DC tool overhang.

エポックミルス タイプR / タイプN

超幅短ミル
スクエアエンドミル

EMXR-SR-TH **EMXN-SR-TH**

4枚刃・スクエア・セミロングシャンク 4 flutes, Square, Semi long shank

溝切削 Slotting

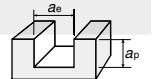

タイプR Type R

タイプN Type N

外径DC Tool dia. (mm)	L/D	切込み 比率 Ratio to standard depth of cut	鋳鉄・炭素鋼・合金鋼 Cast irons, Carbon steels, Alloy steels (150~250HB) FC, S50C, SCM		工具鋼 Tool steels (25~35HRC) SKD		プリハードン鋼 Pre-hardened steels (35~45HRC) NAK80, CENA1		焼入れ鋼 Hardened steels (45~55HRC) SKD61, SKT4		鋳鉄・炭素鋼・合金鋼 Cast irons, Carbon steels, Alloy steels (150~250HB) FC, S50C, SCM		工具鋼 Tool steels (25~35HRC) SKD		ステンレス鋼 Stainless steels SUS		プリハードン鋼 Pre-hardened steels (35~45HRC) NAK80, CENA1		焼入れ鋼 Hardened steels (45~55HRC) SKD61, SKT4		
			ap=1.0DC×切込み比率 × Ratio to standard depth of cut	ap=0.8DC×切込み比率 × Ratio to standard depth of cut	ap=0.5DC×切込み比率 × Ratio to standard depth of cut	ap=0.2DC×切込み比率 × Ratio to standard depth of cut	ap=1.0DC×切込み比率 × Ratio to standard depth of cut	ap=0.8DC×切込み比率 × Ratio to standard depth of cut	ap=0.8DC×切込み比率 × Ratio to standard depth of cut	ap=0.5DC×切込み比率 × Ratio to standard depth of cut	ap=0.2DC×切込み比率 × Ratio to standard depth of cut	ap=1.0DC×切込み比率 × Ratio to standard depth of cut	ap=0.8DC×切込み比率 × Ratio to standard depth of cut	ap=0.8DC×切込み比率 × Ratio to standard depth of cut	ap=0.5DC×切込み比率 × Ratio to standard depth of cut	ap=0.2DC×切込み比率 × Ratio to standard depth of cut					
		回転数 n min ⁻¹	送り速度 vf mm/min	回転数 n min ⁻¹	送り速度 vf mm/min	回転数 n min ⁻¹	送り速度 vf mm/min	回転数 n min ⁻¹	送り速度 vf mm/min	回転数 n min ⁻¹	送り速度 vf mm/min	回転数 n min ⁻¹	送り速度 vf mm/min	回転数 n min ⁻¹	送り速度 vf mm/min	回転数 n min ⁻¹	送り速度 vf mm/min	回転数 n min ⁻¹	送り速度 vf mm/min	回転数 n min ⁻¹	送り速度 vf mm/min
φ7	4	100%	5,900	950	5,200	670	4,500	460	3,900	320	5,500	890	4,800	620	4,800	190	4,100	420	3,400	280	
	5	70%	3,500	570	3,100	400	2,700	280	2,300	190	3,300	530	2,900	370	2,900	110	2,500	250	2,000	170	
	6	50%	1,800	290	1,600	200	1,400	140	1,200	100	1,700	270	1,400	190	1,400	60	1,200	130	1,000	80	
φ9	4	100%	4,600	1,010	4,100	720	3,500	490	3,000	340	4,200	920	3,700	650	3,700	200	3,200	450	2,700	300	
	5	70%	2,800	610	2,500	430	2,100	290	1,800	200	2,500	550	2,200	390	2,200	120	1,900	270	1,600	180	
	6	50%	1,400	300	1,200	220	1,100	150	900	100	1,300	280	1,100	200	1,100	60	1,000	140	800	90	
φ11	4	100%	3,800	1,020	3,300	710	2,900	500	2,500	340	3,500	940	3,000	640	3,000	190	2,600	450	2,200	300	
	5	70%	2,300	610	2,000	430	1,700	300	1,500	200	2,100	560	1,800	380	1,800	110	1,600	270	1,300	180	
	6	50%	1,100	310	1,000	210	900	150	800	100	1,100	280	900	190	900	60	800	140	700	90	
φ13	4	100%	3,200	960	2,800	670	2,400	460	2,100	320	2,900	870	2,600	620	2,600	190	2,200	420	1,800	280	
	5	70%	1,900	580	1,700	400	1,400	280	1,300	190	1,700	520	1,600	370	1,600	110	1,300	250	1,100	170	
	6	50%	1,000	290	800	200	700	140	600	100	900	260	800	190	800	60	700	130	500	80	

傾斜切削 Ramping

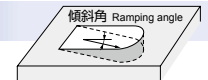

タイプR Type R

タイプN Type N

最大傾斜角 Max. ramping angle	外径DC Tool dia. (mm)	L/D	鋳鉄・炭素鋼・合金鋼 Cast irons, Carbon steels, Alloy steels (150~250HB) FC, S50C, SCM		工具鋼 Tool steels (25~35HRC) SKD		プリハードン鋼 Pre-hardened steels (35~45HRC) NAK80, CENA1		焼入れ鋼 Hardened steels (45~55HRC) SKD61, SKT4		鋳鉄・炭素鋼・合金鋼 Cast irons, Carbon steels, Alloy steels (150~250HB) FC, S50C, SCM		工具鋼 Tool steels (25~35HRC) SKD		ステンレス鋼 Stainless steels SUS		プリハードン鋼 Pre-hardened steels (35~45HRC) NAK80, CENA1		焼入れ鋼 Hardened steels (45~55HRC) SKD61, SKT4		
			30°以下 30° or less	15°以下 15° or less	15°以下 15° or less	5°以下 5° or less	20°以下 20° or less	10°以下 10° or less	5°以下 5° or less	10°以下 10° or less	5°以下 5° or less	10°以下 10° or less	5°以下 5° or less								
		回転数 n min ⁻¹	送り速度 vf mm/min	回転数 n min ⁻¹	送り速度 vf mm/min	回転数 n min ⁻¹	送り速度 vf mm/min	回転数 n min ⁻¹	送り速度 vf mm/min	回転数 n min ⁻¹	送り速度 vf mm/min	回転数 n min ⁻¹	送り速度 vf mm/min	回転数 n min ⁻¹	送り速度 vf mm/min	回転数 n min ⁻¹	送り速度 vf mm/min	回転数 n min ⁻¹	送り速度 vf mm/min	回転数 n min ⁻¹	送り速度 vf mm/min
φ7	4	5,900	740	5,200	520	4,500	360	3,900	250	5,500	690	4,800	480	4,800	140	4,100	330	3,400	220		
	5	4,100	520	3,600	360	3,200	250	2,700	180	3,900	480	3,400	340	3,400	100	2,900	230	2,400	150		
	6	3,000	370	2,600	260	2,300	180	2,000	130	2,800	350	2,400	240	2,400	70	2,100	170	1,700	110		
φ9	4	4,600	790	4,100	560	3,500	380	3,000	260	4,200	720	3,700	510	3,700	150	3,200	350	2,700	240		
	5	3,200	550	2,900	390	2,500	270	2,100	180	2,900	500	2,600	360	2,600	110	2,200	250	1,900	170		
	6	2,300	400	2,100	280	1,800	190	1,500	130	2,100	360	1,900	260	1,900	80	1,600	180	1,400	120		
φ11	4	3,800	790	3,300	550	2,900	390	2,500	270	3,500	730	3,000	500	3,000	150	2,600	350	2,200	240		
	5	2,700	550	2,300	390	2,000	270	1,800	190	2,500	510	2,100	350	2,100	110	1,800	250	1,500	170		
	6	1,900	400	1,700	280	1,500	200	1,300	140	1,800	370	1,500	250	1,500	80	1,300	180	1,100	120		
φ13	4	3,200	750	2,800	520	2,400	360	2,100	250	2,900	680	2,600	490	2,600	150	2,200	330	1,800	220		
	5	2,200	530	2,000	360	1,700	250	1,500	180	2,000	480	1,800	340	1,800	100	1,500	230	1,300	150		
	6	1,600	380	1,400	260	1,200	180	1,100	130	1,500	340	1,300	250	1,300	80	1,100	170	900	110		

※タイプRはステンレス鋼及びチタン合金に推奨できません。

【注意】

- ① Z突込み切削は「溝切削」条件の回転数で、送り速度のみ1/3程度に下げてください。
- ② できるだけ高剛性、高精度の機械をご使用ください。
- ③ この切削条件表は切削条件の目安を示すものです。実際の加工では加工形状、目的、使用機械等により条件を調整してください。
- ④ 機械の回転数が足りない場合には、回転数と送り速度を同じ比率で下げてください。
- ⑤ エアブローやクーラントの位置に十分ご注意ください。
- ⑥ 使用条件(コレット等)によっては、工具が抜ける恐れがありますので、機械・ホルダーの種類によって、条件を調整してください。
- ⑦ 突出量が4DCを超える場合の切込み量は、切込み比率を目安に調整してください。

※Type R is not recommendable for milling stainless steel or Ti alloy.

Note

- ① Please use rpm and 1/3 those of slotting cutting conditions respectively for Z plunging.
- ② Use a highly rigid and accurate machine as possible.
- ③ These conditions are for general guidance; in actual machining conditions adjust the parameters according to your actual machine and work-piece conditions.
- ④ If the rpm available is lower than that recommended please reduce the feed rate to the same ratio.
- ⑤ Please ensure that air blow or coolant is correctly positioned in order to remove the chip immediately.
- ⑥ In order to avoid clamping looseness, Please adjust cutting conditions according to type of machine center and holder.
- ⑦ Please change ratio to standard depth of cut in the application with more than 4DC tool overhang.

EMXR-SR-TH **EMXN-SR-TH** 4枚刃・スクエア・セミロングシャンク 4 flutes, Square, Semi long shank

往復倣い加工 Two-way profiling

タイプR Type R		タイプN Type N																																						
		鋳鉄・炭素鋼・合金鋼 Cast irons, Carbon steels, Alloy steels (150~250HB) FC, S50C, SCM				工具鋼 Tool steels (25~35HRC) SKD				プリハードン鋼 Pre-hardened steels (35~45HRC) NAK80, CENA1				焼入れ鋼 Hardened steels (45~55HRC) SKD61, SKT4				鋳鉄・炭素鋼・合金鋼 Cast irons, Carbon steels, Alloy steels (150~250HB) FC, S50C, SCM				工具鋼 Tool steels (25~35HRC) SKD				ステンレス鋼 Stainless steels SUS				プリハードン鋼 Pre-hardened steels (35~45HRC) NAK80, CENA1				焼入れ鋼 Hardened steels (45~55HRC) SKD61, SKT4						
切込み Depth of cut (mm)		最大max. ae=0.5DC ×切込み比率 × Ratio to standard depth of cut				最大max. ae=0.375DC ×切込み比率 × Ratio to standard depth of cut				最大max. ae=0.25DC ×切込み比率 × Ratio to standard depth of cut				最大max. ae=0.125DC ×切込み比率 × Ratio to standard depth of cut				最大max. ae=0.5DC ×切込み比率 × Ratio to standard depth of cut				最大max. ae=0.375DC ×切込み比率 × Ratio to standard depth of cut				最大max. ae=0.375DC ×切込み比率 × Ratio to standard depth of cut				最大max. ae=0.25DC ×切込み比率 × Ratio to standard depth of cut				最大max. ae=0.125DC ×切込み比率 × Ratio to standard depth of cut						
外径DC Tool dia. (mm)	L/D	切込み 比率 Ratio to standard depth of cut	回転数 n mm/min		送り速度 vf mm/min		回転数 n mm/min		送り速度 vf mm/min		回転数 n mm/min		送り速度 vf mm/min		回転数 n mm/min		送り速度 vf mm/min		回転数 n mm/min		送り速度 vf mm/min		回転数 n mm/min		送り速度 vf mm/min		回転数 n mm/min		送り速度 vf mm/min		回転数 n mm/min		送り速度 vf mm/min							
			φ7	4	100%	6,800	1,710	6,100	1,230	5,500	890	4,800	620	6,400	1,610	5,700	1,150	5,700	350	5,000	810	4,300	550	6,400	1,610	5,700	1,150	5,700	350	5,000	810	4,300	550	6,400	1,610	5,700	1,150	5,700	350	5,000
	5	70%	4,800	1,200	4,300	860	3,900	620	3,400	430	4,500	1,130	4,000	810	4,000	240	3,500	570	3,000	390	4,500	1,130	4,000	810	4,000	240	3,500	570	3,000	390	4,500	1,130	4,000	810	4,000	240	3,500	570	3,000	390
	6	50%	3,400	860	3,100	620	2,800	450	2,400	310	3,200	810	2,900	580	2,900	170	2,500	410	2,200	280	3,200	810	2,900	580	2,900	170	2,500	410	2,200	280	3,200	810	2,900	580	2,900	170	2,500	410	2,200	280
φ9	4	100%	5,300	1,810	4,800	1,310	4,200	920	3,700	650	5,000	1,710	4,400	1,200	4,400	360	3,900	850	3,400	600	5,000	1,710	4,400	1,200	4,400	360	3,900	850	3,400	600	5,000	1,710	4,400	1,200	4,400	360	3,900	850	3,400	600
	5	70%	3,700	1,270	3,400	920	2,900	640	2,600	460	3,500	1,200	3,100	840	3,100	250	2,700	600	2,400	420	3,500	1,200	3,100	840	3,100	250	2,700	600	2,400	420	3,500	1,200	3,100	840	3,100	250	2,700	600	2,400	420
	6	50%	2,700	910	2,400	660	2,100	460	1,900	330	2,500	860	2,200	600	2,200	180	2,000	430	1,700	300	2,500	860	2,200	600	2,200	180	2,000	430	1,700	300	2,500	860	2,200	600	2,200	180	2,000	430	1,700	300
φ11	4	100%	4,300	1,800	3,900	1,300	3,500	940	3,000	640	4,100	1,710	3,600	1,200	3,600	360	3,200	860	2,700	580	4,100	1,710	3,600	1,200	3,600	360	3,200	860	2,700	580	4,100	1,710	3,600	1,200	3,600	360	3,200	860	2,700	580
	5	70%	3,000	1,260	2,700	910	2,500	660	2,100	450	2,900	1,200	2,500	840	2,500	250	2,200	600	1,900	410	2,900	1,200	2,500	840	2,500	250	2,200	600	1,900	410	2,900	1,200	2,500	840	2,500	250	2,200	600	1,900	410
	6	50%	2,200	900	2,000	650	1,800	470	1,500	320	2,100	860	1,800	600	1,800	180	1,600	430	1,400	290	2,100	860	1,800	600	1,800	180	1,600	430	1,400	290	2,100	860	1,800	600	1,800	180	1,600	430	1,400	290
φ13	4	100%	3,700	1,730	3,300	1,240	2,900	870	2,600	620	3,400	1,590	3,100	1,160	3,100	350	2,700	810	2,300	550	3,400	1,590	3,100	1,160	3,100	350	2,700	810	2,300	550	3,400	1,590	3,100	1,160	3,100	350	2,700	810	2,300	550
	5	70%	2,600	1,210	2,300	870	2,000	610	1,800	430	2,400	1,110	2,200	810	2,200	240	1,900	570	1,600	390	2,400	1,110	2,200	810	2,200	240	1,900	570	1,600	390	2,400	1,110	2,200	810	2,200	240	1,900	570	1,600	390
	6	50%	1,900	870	1,700	620	1,500	440	1,300	310	1,700	800	1,600	580	1,600	170	1,400	410	1,200	280	1,700	800	1,600	580	1,600	170	1,400	410	1,200	280	1,700	800	1,600	580	1,600	170	1,400	410	1,200	280

※タイプRはステンレス鋼及びチタン合金に推奨できません。 ※Type R is not recommendable for milling stainless steel or Ti alloy.

【特長】 本工具を用いると、図①に示すような形状から、往復倣い加工を行うことが可能です。 **Features** MIRUS has the capability of two-way profiling a work from geometry as figure 1 shown. Please refer to side milling cutting conditions for previous process.

【注意】 前ページ下段を参照してください。 **Note** Please refer to the precautions in previous page.

主軸別 使用領域概念図

Cutting condition adjustment based on spindle type

標準切削条件はBT50相当の主軸での切削条件です。主軸剛性の弱い機械では右記の図を参考に切り込み量を調整してください。

Standard cutting condition is for BT50 class spindle situation. Please adjust the step according to right chart.

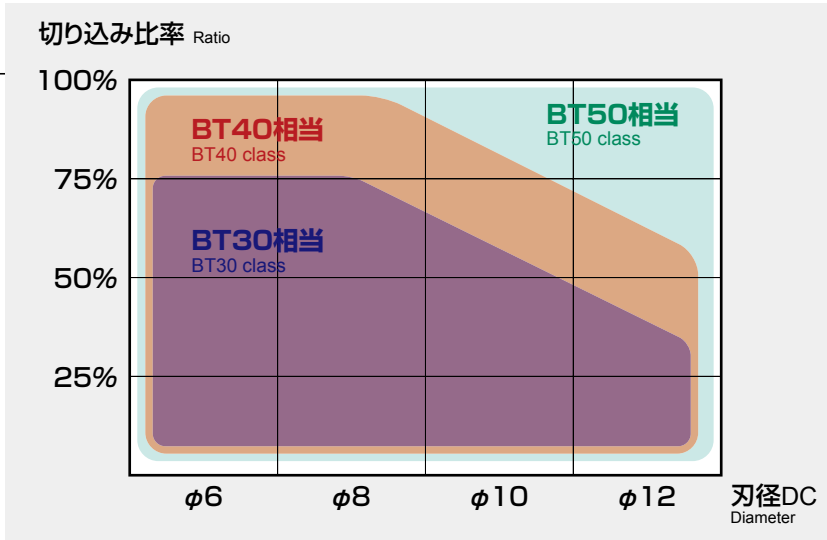

ショート刃長 Short



外径公差 Dia.tolerance 0~-0.015



(mm)

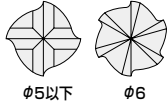

φ5以下 φ6

CEPS-TH



商品コード Item code	在庫 Stock	寸法 Size (mm)				刃数 No. of Flutes	希望小売 価格(円) Suggested retail price(¥)
		外径 Tool dia.	刃長 Flute length	全長 Overall length	シャンク径 Shank dia.		
CEPS4010-TH	●	1	2	60	6	4	13,930
CEPS4015-TH	●	1.5	3	60	6	4	13,930
CEPS4020-TH	●	2	4	60	6	4	13,390
CEPS4025-TH	●	2.5	5	60	6	4	12,440
CEPS4030-TH	●	3	6	60	6	4	10,940
CEPS4040-TH	●	4	8	60	6	4	11,680
CEPS4050-TH	●	5	10	60	6	4	13,030
CEPS6060-TH	●	6	12	60	6	6	14,030

レギュラー刃長 Regular



外径公差 Dia.tolerance φ1~φ6 : 0~-0.015
φ6.5~φ32 : 0~-0.02



(mm)

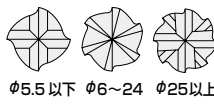

φ5.5以下 φ6~24 φ25以上

CEPR-TH



商品コード Item code	在庫 Stock	寸法 Size (mm)				刃数 No. of Flutes	希望小売 価格(円) Suggested retail price(¥)
		外径 Tool dia.	刃長 Flute length	全長 Overall length	シャンク径 Shank dia.		
CEPR4010-TH	●	1	3.5	60	6	4	13,930
CEPR4015-TH	●	1.5	5	60	6	4	13,930
CEPR4020-TH	●	2	7	60	6	4	13,390
CEPR4025-TH	●	2.5	8	60	6	4	12,440
CEPR4030-TH	●	3	10	60	6	4	10,940
CEPR4035-TH	●	3.5	12	60	6	4	11,680
CEPR4040-TH	●	4	12	60	6	4	11,680
CEPR4045-TH	●	4.5	15	60	6	4	13,030
CEPR4050-TH	●	5	15	60	6	4	13,030
CEPR4055-TH	●	5.5	15	60	6	4	14,030
CEPR6060-TH	●	6	15	60	6	6	14,030
CEPR6065-TH	●	6.5	20	75	8	6	18,520
CEPR6070-TH	●	7	20	75	8	6	18,520
CEPR6075-TH	●	7.5	20	75	8	6	20,540
CEPR6080-TH	●	8	20	75	8	6	17,180
CEPR6085-TH	●	8.5	25	80	10	6	23,690
CEPR6090-TH	●	9	25	80	10	6	23,690
CEPR6095-TH	●	9.5	25	80	10	6	27,270
CEPR6100-TH	●	10	25	80	10	6	23,130
CEPR6105-TH	●	10.5	30	100	12	6	31,310
CEPR6110-TH	●	11	30	100	12	6	31,310
CEPR6115-TH	●	11.5	30	100	12	6	34,460
CEPR6120-TH	●	12	30	100	12	6	29,180
CEPR6130-TH	●	13	35	105	16	6	46,810
CEPR6140-TH	●	14	35	105	16	6	52,560
CEPR6150-TH	●	15	40	110	16	6	55,960
CEPR6160-TH	●	16	40	110	16	6	66,750
CEPR6170-TH	●	17	40	120	20	6	91,040
CEPR6180-TH	●	18	40	120	20	6	88,690
CEPR6190-TH	●	19	45	125	20	6	110,390
CEPR6200-TH	●	20	45	125	20	6	97,020
CEPR6220-TH	●	22	45	135	20	6	129,030
CEPR6240-TH	●	24	50	140	25	6	167,740
CEPR8250-TH	●	25	50	140	25	8	187,680
CEPR8260-TH	●	26	50	140	25	8	190,030
CEPR8280-TH	●	28	55	145	25	8	208,800
CEPR8300-TH	●	30	60	165	32	8	236,950
CEPR8320-TH	●	32	70	175	32	8	265,100

ロング刃長 Long



外径公差 Dia.tolerance φ3~φ6 : 0~-0.015
φ7~φ25 : 0~-0.02



(mm)

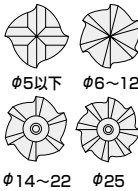

φ5以下 φ6~12 φ14~22 φ25

CEPL-TH



商品コード Item code	在庫 Stock	寸法 Size (mm)				刃数 No. of Flutes	希望小売 価格(円) Suggested retail price(¥)
		外径 Tool dia.	刃長 Flute length	全長 Overall length	シャンク径 Shank dia.		
CEPL4030-TH	●	3	15	60	6	4	17,570
CEPL4040-TH	●	4	20	65	6	4	18,330
CEPL4050-TH	●	5	25	70	6	4	20,540
CEPL6060-TH	●	6	25	70	6	6	24,920
CEPL6070-TH	●	7	35	90	8	6	28,050
CEPL6080-TH	●	8	35	90	8	6	31,310
CEPL6090-TH	●	9	45	100	10	6	36,140
CEPL6100-TH	●	10	45	100	10	6	42,200
CEPL6110-TH	●	11	55	120	12	6	46,690
CEPL6120-TH	●	12	55	120	12	6	51,620
* CEPL6140-TH	●	14	55	125	16	6	79,070
* CEPL6160-TH	●	16	65	135	16	6	120,820
* CEPL6180-TH	●	18	65	145	20	6	159,530
* CEPL6200-TH	●	20	75	155	20	6	175,950
* CEPL6220-TH	●	22	75	165	20	6	208,800
* CEPL8250-TH	●	25	90	180	25	8	294,430

●印：標準在庫品です。●：Stocked items. *：センタ穴付き *：Center eyed

超硬エンドミル スクエアエンドミル

○ CEPS-TH、CEPR-TH、CEPL-THの対応被削材

Applicable work material of CEPS-TH, CEPR-TH, CEPL-TH, CEPL-TH

炭素鋼 合金鋼 Carbon steel Alloy steel	プリハー ド鋼 Pre-hardened steel ≤ 45HRC	高硬度 Hardened steel			ステン レス鋼 Stainless steel	チタン合金 耐熱合金 (35~45HRC) Titanium alloy Heat-resistant alloy	銅合金 Copper alloy	アルミ 合金 Aluminum alloy
		> 45HRC ≤ 55HRC	> 55HRC ≤ 65HRC	> 65HRC				
○	○	○	○	○	○	○	○	

○ 再研磨対応外径範囲

Re-grinding compatibility range

商品コード Item code	外周 Outer dia. (mm)	エンド End (mm)
CEPS-TH	× (N/A)	2 ~ 6
CEPR-TH	8 ~ 32	2 ~ 32
CEPL-TH	8 ~ 25	3 ~ 25

○ 標準切削条件表 Recommended cutting conditions

CEPS-TH	CEPR-TH
ショート刃長 Short	レギュラー刃長 Regular

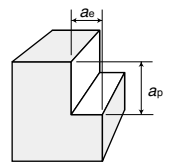

<側面切削> Side milling

被削材 Work material	工具鋼 Tool steels (25~35HRC) SKD			プリハードン鋼 Pre-hardened steels (35~45HRC) CENA1, NAK80		焼入れ鋼 Hardened steels (45~55HRC) SKD61, SKT4		焼入れ鋼 Hardened steels (55~65HRC) SKD11, SKH51		焼入れ鋼 Hardened steels (65~70HRC) SKH, HAP	
	切込み Depth of cut (mm)	ap=1.5DC	ae=0.1DC	ap=1.5DC	ae=0.05DC	ap=1.5DC	ae=0.03DC	ap=1.5DC	ae=0.02DC	ap=1.5DC	ae=0.02DC
高速条件 High speed	外径DC Tool dia. (mm)	回転数n (min ⁻¹)	送り速度vf (mm/min)	回転数n (min ⁻¹)	送り速度vf (mm/min)	回転数n (min ⁻¹)	送り速度vf (mm/min)	回転数n (min ⁻¹)	送り速度vf (mm/min)	回転数n (min ⁻¹)	送り速度vf (mm/min)
	高速条件	φ1	50,000	1,680	50,000	1,500	50,000	1,320	48,000	1,150	32,000
φ2		40,000	2,910	40,000	2,600	32,000	1,830	24,000	1,250	16,000	750
φ3		27,000	3,180	27,000	2,840	21,000	1,940	16,000	1,340	11,000	830
φ4		20,000	3,360	20,000	3,000	16,000	2,110	12,000	1,440	8,000	860
φ6		13,000	4,910	13,000	4,390	11,000	3,270	8,000	2,160	5,300	1,290
φ8		10,000	5,040	10,000	4,500	8,000	3,170	6,000	2,160	4,000	1,300
φ10		8,000	4,840	8,000	4,320	6,400	3,040	4,800	2,070	3,200	1,240
φ12		6,600	4,440	6,600	3,960	5,300	2,800	4,000	1,920	2,700	1,170
φ16		5,000	4,200	5,000	3,750	4,000	2,640	3,000	1,800	2,000	1,080
φ20		4,000	4,030	4,000	3,600	3,200	2,530	2,400	1,730	1,600	1,040
φ25		3,200	4,590	3,200	4,100	2,500	2,820	1,900	1,950	1,300	1,200
φ30	2,700	4,110	2,700	3,670	2,100	2,510	1,600	1,740	1,100	1,080	
汎用条件 General	切込み Depth of cut (mm)	ap=1.5DC	ae=0.1DC	ap=1.5DC	ae=0.1DC	ap=1.5DC	ae=0.06DC	ap=1.5DC	ae=0.04DC	ap=1.5DC	ae=0.04DC
	外径DC Tool dia. (mm)	回転数n (min ⁻¹)	送り速度vf (mm/min)	回転数n (min ⁻¹)	送り速度vf (mm/min)	回転数n (min ⁻¹)	送り速度vf (mm/min)	回転数n (min ⁻¹)	送り速度vf (mm/min)	回転数n (min ⁻¹)	送り速度vf (mm/min)
	φ1	15,000	500	15,000	320	15,000	280	15,000	250	13,000	200
	φ2	15,000	1,090	15,000	680	13,000	520	9,600	350	6,400	210
	φ3	13,000	1,530	11,000	810	8,000	520	6,400	380	4,200	220
	φ4	10,000	1,680	8,000	840	6,000	550	4,800	400	3,200	240
	φ6	6,400	2,420	5,300	1,250	4,200	870	3,200	600	2,100	360
	φ8	4,800	2,420	4,000	1,260	3,200	890	2,400	600	1,600	360
	φ10	3,800	2,300	3,200	1,210	2,500	830	1,900	570	1,300	350
	φ12	3,200	2,150	2,700	1,130	2,100	780	1,600	540	1,100	330
	φ16	2,400	2,070	2,000	1,080	1,600	760	1,200	520	800	310
φ20	1,900	1,920	1,600	1,010	1,300	720	1,000	500	600	270	
φ25	1,500	2,110	1,300	1,140	1,000	770	800	560	510	320	
φ30	1,300	2,000	1,100	1,060	800	670	600	460	420	290	

- [注意]** ①できるだけ高剛性、高精度の機械をご使用ください。
 ②被削材、加工形状に合わせて、適切なクーラントを使用してください。
 ③この切削条件表は切削条件の目安を示すものです。実際の加工では加工形状、目的、使用機械等により条件を調整してください。
 ④機械の回転数が足りない場合には、回転数と送り速度を同じ比率で下げてください。

- [Note]** ① Use a highly rigid and accurate machine as possible.
 ② Use the appropriate coolant for the work material and machining shape.
 ③ These conditions are for general guidance; in actual machining conditions adjust the parameters according to your actual machine and work-piece conditions.
 ④ If the rpm available is lower than that recommended please reduce the feed rate to the same ratio.

Epoch TH Hard エポックTHハード

CEPL-TH

ロング刃長
Long

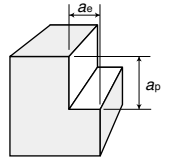

<側面仕上げ切削> Side milling (Finishing)

被削材 Work material	鋳鉄 Cast irons (150~200HB) FC250		炭素鋼 Carbon steels (180~220HB) SS400, S50C		合金鋼 Alloy steels (200~250HB) SCM440, SNCM		ステンレス鋼・工具鋼 Stainless steels, Tool steels (25~35HRC) SUS304, SKD		プリハードン鋼 Pre-hardened steels (35~45HRC) HPM1, NAK55		焼入れ鋼 Hardened steels (45~55HRC) SKD61, SKT4		焼入れ鋼 Hardened steels (55~65HRC) SKD11, SKH51	
	切込み Depth of cut (mm) $a_p=3DC$ $a_e=0.01DC$		$a_p=3DC$ $a_e=0.01DC$		$a_p=3DC$ $a_e=0.01DC$		$a_p=3DC$ $a_e=0.01DC$		$a_p=3DC$ $a_e=0.01DC$		$a_p=3DC$ $a_e=0.01DC$		$a_p=3DC$ $a_e=0.01DC$	
外径DC Tool dia. (mm)	回転数 n (min^{-1})	送り速度 V_f (mm/min)	回転数 n (min^{-1})	送り速度 V_f (mm/min)	回転数 n (min^{-1})	送り速度 V_f (mm/min)	回転数 n (min^{-1})	送り速度 V_f (mm/min)	回転数 n (min^{-1})	送り速度 V_f (mm/min)	回転数 n (min^{-1})	送り速度 V_f (mm/min)	回転数 n (min^{-1})	送り速度 V_f (mm/min)
3	7,960	960	7,960	960	6,370	760	6,370	760	5,310	420	5,310	320	4,240	250
4	5,970	1,190	5,970	1,190	4,770	950	4,770	950	3,980	400	3,980	320	3,180	250
5	4,700	1,220	4,700	1,220	3,820	990	3,820	990	3,180	380	3,180	320	2,550	260
6	3,980	1,910	3,980	1,910	3,180	1,530	3,180	1,530	2,650	640	2,650	480	2,120	380
8	2,980	1,880	2,980	1,880	2,390	1,510	2,390	1,510	1,990	600	1,990	480	1,590	380
10	2,390	1,720	2,390	1,720	1,910	1,380	1,910	1,380	1,590	570	1,590	480	1,270	380
12	1,990	1,550	1,990	1,550	1,590	1,240	1,590	1,240	1,320	550	1,320	480	1,060	380
16	1,490	1,300	1,490	1,300	1,190	1,040	1,190	1,040	990	480	990	420	800	340
20	1,190	1,140	1,190	1,140	950	910	950	910	800	430	800	380	640	310
25	950	1,200	950	1,200	760	970	760	970	640	460	640	410	510	330

- 【注意】**
- ①できるだけ高剛性、高精度の機械をご使用ください。
 - ②被削材、加工形状に合わせて、適切なクーラントを使用してください。
 - ③この切削条件表は切削条件の目安を示すものです。実際の加工では加工形状、目的、使用機械等により条件を調整してください。
 - ④機械の回転数が足りない場合には、回転数と送り速度を同じ比率で下げてください。

- 【Note】**
- ① Use a highly rigid and accurate machine as possible.
 - ② Use the appropriate coolant for the work material and machining shape.
 - ③ These conditions are for general guidance; in actual machining conditions adjust the parameters according to your actual machine and work-piece conditions.
 - ④ If the rpm available is lower than that recommended please reduce the feed rate to the same ratio.

Epoch End Mill エポックエンドミル

高硬度材加工用スクエアエンドミル。
Square end mill for machining high-hardness materials.

ラジラスはA267頁を参照してください
Please refer to page A267 for Radius

エポック21・レギュラー刃長 Epoch 21, Regular



外径公差 Dia. tolerance
φ1~φ6 : 0~-0.015
φ6.5~φ32 : 0~-0.02



(mm)

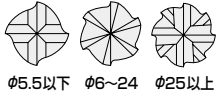

φ5.5以下 φ6~24 φ25以上



エポック21・ロング刃長 Epoch 21, Long



外径公差 Dia. tolerance
φ3~φ6 : 0~-0.015
φ7~φ32 : 0~-0.02



(mm)

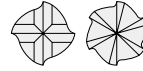

φ5以下 φ6~12



φ13~24 φ25以上



CEPR



商品コード Item code	在庫 Stock	寸法 Size (mm)				刃数 No. of Flutes	希望小売 価格(円) Suggested retail price(¥)
		外径 Tool dia.	刃長 Flute length	全長 Overall length	シャンク径 Shank dia.		
CEPR4010	●	1	3.5	60	6	4	12,010
CEPR4015	●	1.5	5	60	6	4	12,010
CEPR4020	●	2	7	60	6	4	11,470
CEPR4025	●	2.5	8	60	6	4	10,650
CEPR4030	●	3	10	60	6	4	9,490
CEPR4035	●	3.5	12	60	6	4	9,970
CEPR4040	●	4	12	60	6	4	9,970
CEPR4045	●	4.5	15	60	6	4	11,110
CEPR4050	●	5	15	60	6	4	11,110
CEPR4055	●	5.5	15	60	6	4	12,020
CEPR6060	●	6	15	60	6	6	12,020
CEPR6065	●	6.5	20	75	8	6	15,940
CEPR6070	●	7	20	75	8	6	15,940
CEPR6075	●	7.5	20	75	8	6	17,740
CEPR6080	●	8	20	75	8	6	14,820
CEPR6085	●	8.5	25	80	10	6	20,430
CEPR6090	●	9	25	80	10	6	20,430
CEPR6095	●	9.5	25	80	10	6	23,460
CEPR6100	●	10	25	80	10	6	19,870
CEPR6105	●	10.5	30	100	12	6	26,930
CEPR6110	●	11	30	100	12	6	26,930
CEPR6115	●	11.5	30	100	12	6	29,740
CEPR6120	●	12	30	100	12	6	25,140
CEPR6130	●	13	35	105	16	6	40,360
CEPR6140	●	14	35	105	16	6	45,290
CEPR6150	●	15	40	110	16	6	48,220
CEPR6160	●	16	40	110	16	6	57,610
CEPR6170	●	17	40	120	20	6	78,480
CEPR6180	●	18	40	120	20	6	76,380
CEPR6190	●	19	45	125	20	6	95,140
CEPR6200	●	20	45	125	20	6	84,000
CEPR6220	●	22	45	135	20	6	117,070
CEPR6240	●	24	50	140	25	6	152,490
CEPR8250	●	25	50	140	25	8	170,090
CEPR8260	●	26	50	140	25	8	171,260
CEPR8280	●	28	55	145	25	8	190,030
CEPR8300	●	30	60	165	32	8	215,840
CEPR8320	●	32	70	175	32	8	240,470

CEPL



商品コード Item code	在庫 Stock	寸法 Size (mm)				刃数 No. of Flutes	希望小売 価格(円) Suggested retail price(¥)
		外径 Tool dia.	刃長 Flute length	全長 Overall length	シャンク径 Shank dia.		
CEPL4030	●	3	15	60	6	4	15,960
CEPL4040	●	4	20	65	6	4	16,610
CEPL4050	●	5	25	70	6	4	18,640
CEPL6060	●	6	25	70	6	6	22,680
CEPL6070	●	7	35	90	8	6	25,480
CEPL6080	●	8	35	90	8	6	28,510
CEPL6090	●	9	45	100	10	6	32,880
CEPL6100	●	10	45	100	10	6	38,270
CEPL6110	●	11	55	120	12	6	42,420
CEPL6120	●	12	55	120	12	6	46,910
* CEPL6130	□	13	55	125	16	6	—
* CEPL6140	●	14	55	125	16	6	71,910
* CEPL6150	●	15	65	135	16	6	91,270
* CEPL6160	●	16	65	135	16	6	109,450
* CEPL6170	□	17	65	145	20	6	—
* CEPL6180	●	18	65	145	20	6	145,460
* CEPL6190	□	19	75	155	20	6	—
* CEPL6200	●	20	75	155	20	6	159,530
* CEPL6220	●	22	75	165	20	6	190,030
* CEPL6240	□	24	90	180	25	6	—
* CEPL8250	●	25	90	180	25	8	267,450
* CEPL8260	□	26	90	180	25	8	—
* CEPL8280	●	28	90	180	25	8	310,850
* CEPL8300	●	30	90	195	32	8	348,390
* CEPL8320	□	32	95	195	32	8	—

CEPR、CEPLの対応被削材 Applicable work material of CEPR, CEPL

炭素鋼 合金鋼 Carbon steel Alloy steel	プリハー ド鋼 Pre-hardened steel	高硬度 Hardened steel			ステン レス鋼 Stainless steel	チタン合金 耐熱合金 Titanium alloy Heat-resistant alloy	銅合金 Copper alloy	アルミ 合金 Aluminum alloy
◎	◎	> 45HRC ≤ 55HRC	> 55HRC ≤ 65HRC	> 65HRC	○	○	○	○

再研磨対応外径範囲 Re-grinding compatibility range

商品コード Item code	外周 Outer dia. (mm)	エンド End (mm)
CEPR	8 ~ 32	2 ~ 32
CEPL	8 ~ 32	3 ~ 32

●印：標準在庫品です。 □印：特定代理店在庫です。弊社営業へお問合せください。 *：センタ穴付き
●：Stocked items. □：Stocked by specified distributor. Contact with our sales department. *：Center eyed

Epoch End Mill エポックエンドミル

高硬度材加工用スクエアエンドミル。
Square end mill for machining high-hardness materials.

エポック21・ロングシャンク Epoch 21, Long Shank

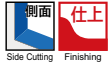

外径公差 Dia. tolerance
φ6 : 0~-0.015
φ8~φ32 : 0~-0.02



(mm)



φ12以下 φ16~22 φ25以上

CEPLS ○○○○(-○○○) 超硬 C 傾斜46° 切削条件表 A358

商品コード Item code	在庫 Stock	寸法 Size (mm)				刃数 No. of Flutes	希望小売 価格(円) Suggested retail price(¥)
		外径 Tool dia.	刃長 Flute length	全長 Overall length	シャンク径 Shank dia.		
CEPLS6060	●	6	12	70	6	6	16,500
CEPLS6080	●	8	16	90	8	6	20,760
CEPLS6100	●	10	20	100	10	6	27,720
CEPLS6120-10	●	12	24	120	10	6	33,900
CEPLS6120	●	12	24	120	12	6	33,900
* CEPLS6160-12	●	16	32	135	12	6	78,480
* CEPLS6160	●	16	32	135	16	6	78,480
* CEPLS6180	●	18	36	145	16	6	104,530
* CEPLS6200-16	●	20	40	155	16	6	114,730
* CEPLS6200	●	20	40	155	20	6	114,730
* CEPLS6220	●	22	45	165	20	6	137,250
* CEPLS8250-20	●	25	45	180	20	8	197,070
* CEPLS8250	●	25	45	180	25	8	197,070
* CEPLS8280	□	28	50	180	25	8	—
* CEPLS8300	□	30	50	195	25	8	—
* CEPLS8320-25	□	32	55	195	25	8	—
* CEPLS8320	□	32	55	195	32	8	—

エポックハード Epoch Hard



外径公差 Dia. tolerance
φ3~φ6 : 0~-0.015
φ8~φ20 : 0~-0.02



(mm)



φ5以下 φ6以上

CEPH ○○○○ 超硬 C 傾斜46° 切削条件表 A359

商品コード Item code	在庫 Stock	寸法 Size (mm)				刃数 No. of Flutes	希望小売 価格(円) Suggested retail price(¥)
		外径 Tool dia.	刃長 Flute length	全長 Overall length	シャンク径 Shank dia.		
CEPH4030	●	3	6	60	6	4	9,970
CEPH4040	●	4	8	60	6	4	10,610
CEPH4050	●	5	10	60	6	4	11,790
CEPH6060	●	6	12	60	6	6	12,690
CEPH6080	●	8	16	75	8	6	15,710
CEPH6100	●	10	20	80	10	6	20,990
CEPH6120	●	12	24	100	12	6	26,490
CEPH6160	●	16	32	110	16	6	60,660
CEPH6200	●	20	40	125	20	6	88,220

Epoch Universal エポックユニバーサル



外径公差 Dia. tolerance
φ4~φ6 : 0~-0.015
φ8~φ20 : 0~-0.02



(mm)

2段刃溝により溝切削から側面切削まで高能率加工が可能。能率重視。
2-step flute groove enables high-efficiency machining from grooving to side cutting. Focus on efficiency.



CEPU4 ○○○○ 超硬 C 傾斜52° 切削条件表 A360

商品コード Item code	在庫 Stock	寸法 Size (mm)				希望小売 価格(円) Suggested retail price(¥)
		外径 Tool dia.	刃長 Flute length	全長 Overall length	シャンク径 Shank dia.	
CEPU4040	●	4	12	60	6	11,150
CEPU4060	●	6	15	60	6	13,360
CEPU4080	●	8	20	75	8	16,390
CEPU4100	●	10	25	80	10	21,880
CEPU4120	●	12	30	100	12	27,720
CEPU4160	●	16	40	110	16	63,350
CEPU4200	●	20	45	125	20	92,670

CEPLS、CEPHの対応被削材

Applicable work material of CEPR, CEPL, CEPLS, CEPH

炭素鋼 合金鋼 Carbon steel Alloy steel	プリハー ド鋼 Pre-hardened steel	高硬度 Hardened steel			ステン レス鋼 Stainless steel	チタン合金 耐熱合金 Titanium alloy Heat-resistant alloy	銅合金 Copper alloy	アルミ 合金 Aluminum alloy
		> 45HRC ≤ 55HRC	> 55HRC ≤ 65HRC	> 65HRC				
○	○	○	○	○	○	○	○	

CEPUの対応被削材 Applicable work material of CEPU

炭素鋼 合金鋼 Carbon steel Alloy steel	プリハー ド鋼 Pre-hardened steel	高硬度 Hardened steel			ステン レス鋼 Stainless steel	チタン合金 耐熱合金 Titanium alloy Heat-resistant alloy	銅合金 Copper alloy	アルミ 合金 Aluminum alloy
		> 45HRC ≤ 55HRC	> 55HRC ≤ 65HRC	> 65HRC				
○	○	○	○	○	○	○	○	

再研磨対応外径範囲

Re-grinding compatibility range

商品コード Item code	外周 Outer dia. (mm)	エンド End (mm)
CEPLS	8 ~ 32	6 ~ 32
CEPH	8 ~ 20	3 ~ 20
CEPU	6 ~ 20	4 ~ 20

●印：標準在庫品です。 □印：特定代理店在庫です。弊社営業へお問合せください。 *：センタ穴付き
●：Stocked items. □：Stocked by specified distributor. Contact with our sales department. *：Center eyed

標準切削条件表 Recommended cutting conditions

CEPR

エポック21・レギュラー刃長
Epoch21, Regular

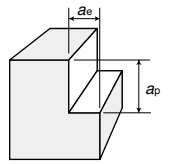

<側面切削> Side milling

被削材 Work material	鋳鉄 Cast Iron (150~200HB) FC250		炭素鋼 Carbon Steels (180~220HB) SS400, S50C		合金鋼 Alloy Steels (200~250HB) SCM440, SNCM		ステンレス鋼・工具鋼 Stainless steels, Tool steels (25~35HRC) SUS304, SKD		プリハードン鋼 Pre-hardened steels (35~45HRC) HPM1, NAK55		焼入れ鋼 Hardened Steels (45~55HRC) SKD61, SKT4		焼入れ鋼 Hardened Steels (55~65HRC) SKD11, SKH51		
	$a_p=1.5DC$ $a_e \leq 0.1DC$		$a_p=1.5DC$ $a_e \leq 0.1DC$		$a_p=1.5DC$ $a_e \leq 0.05DC$		$a_p=1.5DC$ $a_e \leq 0.05DC$		$a_p=1.5DC$ $a_e \leq 0.02DC$		$a_p=1.5DC$ $a_e \leq 0.01DC$		$a_p=1.5DC$ $a_e \leq 0.01DC$		
外径DC Tool Dia. (mm)	回転数 n (min^{-1})	送り速度 V_f (mm/min)	回転数 n (min^{-1})	送り速度 V_f (mm/min)	回転数 n (min^{-1})	送り速度 V_f (mm/min)	回転数 n (min^{-1})	送り速度 V_f (mm/min)	回転数 n (min^{-1})	送り速度 V_f (mm/min)	回転数 n (min^{-1})	送り速度 V_f (mm/min)	回転数 n (min^{-1})	送り速度 V_f (mm/min)	
高速条件 High Speed	$\phi 3$	33,300	4,660	32,000	3,200	30,000	3,000	27,600	2,200	26,500	2,120	12,700	1,000	10,600	850
	$\phi 4$	25,000	4,500	24,000	4,700	22,300	3,100	20,700	2,500	19,900	2,400	9,500	1,140	8,000	960
	$\phi 5$	20,000	5,200	19,000	4,560	17,800	4,300	16,600	3,300	16,000	3,200	7,600	1,520	6,400	1,280
	$\phi 6$	16,660	7,980	16,000	6,700	15,000	6,300	13,800	5,000	13,300	4,800	6,400	2,300	5,300	1,900
	$\phi 8$	12,500	7,860	12,000	7,200	11,100	6,700	10,300	4,330	9,950	4,180	4,800	2,000	4,000	1,680
	$\phi 10$	10,000	6,900	9,550	6,300	8,900	5,800	8,300	4,000	8,000	3,840	3,800	1,800	3,200	1,500
	$\phi 12$	8,330	6,250	8,000	5,760	7,400	5,300	6,900	4,140	6,600	3,900	3,200	1,920	2,650	1,590
	$\phi 16$	6,250	5,060	6,000	4,680	5,600	4,400	5,200	3,750	5,000	3,600	2,400	1,730	2,000	1,440
	$\phi 20$	5,000	4,200	4,770	3,720	4,460	3,500	4,140	3,000	4,000	2,880	1,900	1,400	1,600	1,150
	$\phi 25$	4,000	4,480	3,800	4,000	3,560	3,700	3,300	3,170	3,200	3,070	1,500	1,440	1,270	1,200
$\phi 30$	3,330	3,700	3,200	3,330	3,000	3,120	2,760	2,650	2,650	2,540	1,300	1,250	1,060	1,000	
汎用条件 General	$\phi 3$	16,700	2,340	16,700	1,670	12,700	1,270	11,700	940	9,500	760	4,200	340	2,700	220
	$\phi 4$	12,700	2,300	12,700	1,800	9,550	1,340	8,800	1,060	7,200	865	3,200	380	2,000	240
	$\phi 5$	10,200	2,600	10,200	2,500	7,600	1,800	7,000	1,400	5,700	1,140	2,550	510	1,600	320
	$\phi 6$	8,500	3,250	8,500	3,570	6,400	2,700	5,850	2,100	4,800	1,730	2,100	750	1,300	470
	$\phi 8$	6,400	4,000	6,400	3,840	4,770	2,860	4,400	1,850	3,600	1,500	1,600	670	1,000	420
	$\phi 10$	5,100	3,500	5,100	3,350	3,800	2,500	3,500	1,680	2,900	1,400	1,300	625	800	380
	$\phi 12$	4,200	3,150	4,200	3,000	3,200	2,300	2,920	1,750	2,400	1,440	1,060	640	660	400
	$\phi 16$	3,200	2,600	3,200	2,500	2,400	1,870	2,200	1,600	1,800	1,300	800	580	500	360
	$\phi 20$	2,550	1,800	2,550	2,000	1,900	1,500	1,750	1,260	1,450	1,040	640	460	400	290
	$\phi 25$	2,040	2,300	2,040	2,120	1,530	1,600	1,400	1,340	1,150	1,100	510	490	320	300
$\phi 30$	1,700	1,900	1,700	1,770	1,270	1,320	1,170	1,120	950	910	420	400	265	254	

【注意】

- ① 切削方法は、ダウンカットで使用ください。
- ② 一般材、とくに高速切削は、乾式（エアブロー）またはオイルミストクーラントにてご使用ください。
- ③ ステンレス鋼および超耐熱合金には、不水溶性切削油のご使用が適しています。
- ④ 安定した切削を行うため、剛性の高い機械とセットアップでご使用ください。
- ⑤ 機械の回転数が足りない場合は、主軸回転数とテーブル送り速度を同比率で下げてください。
- ⑥ 加工形状、機械の剛性、工具突き出し量等、ご使用の状況により、主軸回転数とテーブル送り速度の調整を行ってください。

【Note】

- ① Down-cutting is recommended.
- ② Use generally dry (air-blow) or oil-mist coolant, especially at the high-speed machining.
- ③ Oil base coolant is recommended for machining stainless steels and heat-resistant alloys.
- ④ Use a machine tool with rigidity and rigid set-up, to machine stably.
- ⑤ When the revolution speed is not enough, reduce the revolution speed and table speed at the same ratio.
- ⑥ Adjust the revolution speed and table speed, according to cutting conditions such as machining shape, rigidity of machine tool, over-hang and so on.

Epoch End Mill エポックエンドミル

CEPL

エポック21・ロング刃長
Epoch21, Long

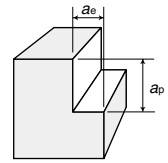

<側面仕上げ加工> Side finishing

被削材 Work material	鋳鉄 Cast irons (150~200HB) FC250		炭素鋼 Carbon steels (180~220HB) SS400, S50C		合金鋼 Alloy steels (200~250HB) SCM440, SNCM		ステンレス鋼・工具鋼 Stainless steels, Tool steels (25~35HRC) SUS304, SKD		プリハードン鋼 Pre-hardened steels (35~45HRC) HPM1, NAK55		焼入れ鋼 Hardened steels (45~55HRC) SKD61, SKT4		焼入れ鋼 Hardened steels (55~65HRC) SKD11, SKH51	
	切込み Depth of cut (mm) $a_p=3DC$ $a_e=0.01DC$		$a_p=3DC$ $a_e=0.01DC$		$a_p=3DC$ $a_e=0.01DC$		$a_p=3DC$ $a_e=0.01DC$		$a_p=3DC$ $a_e=0.01DC$		$a_p=3DC$ $a_e=0.01DC$		$a_p=3DC$ $a_e=0.01DC$	
外径DC Tool dia. (mm)	回転数 n (min^{-1})	送り速度 V_f (mm/min)	回転数 n (min^{-1})	送り速度 V_f (mm/min)	回転数 n (min^{-1})	送り速度 V_f (mm/min)	回転数 n (min^{-1})	送り速度 V_f (mm/min)	回転数 n (min^{-1})	送り速度 V_f (mm/min)	回転数 n (min^{-1})	送り速度 V_f (mm/min)	回転数 n (min^{-1})	送り速度 V_f (mm/min)
φ3	7,960	960	7,960	960	6,370	760	6,370	760	5,310	420	5,310	320	4,240	250
φ4	5,970	1,190	5,970	1,190	4,770	950	4,770	950	3,980	400	3,980	320	3,180	250
φ5	4,700	1,220	4,700	1,220	3,820	990	3,820	990	3,180	380	3,180	320	2,550	260
φ6	3,980	1,910	3,980	1,910	3,180	1,530	3,180	1,530	2,650	640	2,650	480	2,120	380
φ8	2,980	1,880	2,980	1,880	2,390	1,510	2,390	1,510	1,990	600	1,990	480	1,590	380
φ10	2,390	1,720	2,390	1,720	1,910	1,380	1,910	1,380	1,590	570	1,590	480	1,270	380
φ12	1,990	1,550	1,990	1,550	1,590	1,240	1,590	1,240	1,320	550	1,320	480	1,060	380
φ16	1,490	1,300	1,490	1,300	1,190	1,040	1,190	1,040	990	480	990	420	800	340
φ20	1,190	1,140	1,190	1,140	950	910	950	910	800	430	800	380	640	310
φ25	950	1,200	950	1,200	760	970	760	970	640	460	640	410	510	330
φ30	800	1,020	800	1,020	640	820	640	820	530	380	530	340	420	270

- [注意]** ① 切削方法は、ダウンカットで使用ください。
 ② 一般材、とくに高速切削は、乾式(エアブロー)またはオイルミストクーラントにてご使用ください。
 ③ ステンレス鋼および超耐熱鋼には、不水溶性切削油のご使用が適しています。
 ④ 安定した切削を行うため、剛性の高い機械とセットアップでご使用ください。
 ⑤ 機械の回転数が足りない場合は、主軸回転数とテーブル送り速度を同比率で下げてください。
 ⑥ 加工形状、機械の剛性、工具突き出し量等、ご使用の状況により、主軸回転数とテーブル送り速度の調整を行ってください。

- [Note]** ① Down-cutting is recommended.
 ② Use generally dry (air-blow) or oil-mist coolant, especially at the high-speed machining.
 ③ Oil base coolant is recommended for machining stainless steels and heat-resistant steels.
 ④ Use a machine tool with rigidity and rigid set-up, to machine stably.
 ⑤ When the revolution speed is not enough, reduce the revolution speed and table speed at the same ratio.
 ⑥ Adjust the revolution speed and table speed, according to cutting conditions such as machining shape, rigidity of machine tool, over-hang and so on.

CEPLS

エポック21・ロングシャンク
Epoch21, Long Shank

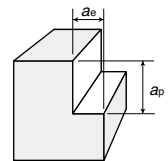

<側面切削> Side milling

被削材 Work material	鋳鉄 Cast Irons (150~200HB) FC250		炭素鋼 Carbon steels (180~220HB) SS400, S50C		合金鋼 Alloy steels (200~250HB) SCM440, SNCM		ステンレス鋼・工具鋼 Stainless steels, Tool steels (25~35HRC) SUS304, SKD		プリハードン鋼 Pre-hardened steels (35~45HRC) HPM1, NAK55		焼入れ鋼 Hardened steels (45~55HRC) SKD61, SKT4		焼入れ鋼 Hardened steels (55~65HRC) SKD11, SKH51	
	切込み Depth of cut (mm) $a_p=1.5DC$ $a_e=0.1DC$		$a_p=1.5DC$ $a_e=0.1DC$		$a_p=1.5DC$ $a_e=0.1DC$		$a_p=1.5DC$ $a_e=0.05DC$		$a_p=1.5DC$ $a_e=0.05DC$		$a_p=1.5DC$ $a_e=0.05DC$		$a_p=1.5DC$ $a_e=0.05DC$	
外径DC Tool dia. (mm)	回転数 n (min^{-1})	送り速度 V_f (mm/min)	回転数 n (min^{-1})	送り速度 V_f (mm/min)	回転数 n (min^{-1})	送り速度 V_f (mm/min)	回転数 n (min^{-1})	送り速度 V_f (mm/min)	回転数 n (min^{-1})	送り速度 V_f (mm/min)	回転数 n (min^{-1})	送り速度 V_f (mm/min)	回転数 n (min^{-1})	送り速度 V_f (mm/min)
φ6	3,980	1,910	3,980	1,910	3,180	1,530	3,180	1,530	2,650	640	2,650	480	2,120	380
φ8	2,980	1,880	2,980	1,880	2,390	1,510	2,390	1,510	1,990	600	1,990	480	1,590	380
φ10	2,390	1,720	2,390	1,720	1,910	1,380	1,910	1,380	1,590	570	1,590	480	1,270	380
φ12	1,990	1,550	1,990	1,550	1,590	1,240	1,590	1,240	1,320	550	1,320	480	1,060	380
φ16	1,490	1,300	1,490	1,300	1,190	1,040	1,190	1,040	990	480	990	420	800	340
φ20	1,190	1,140	1,190	1,140	950	910	950	910	800	430	800	380	640	310
φ25	950	1,220	950	1,220	760	970	760	970	640	460	640	410	510	330
φ30	800	1,020	800	1,020	640	820	640	820	530	380	530	340	420	270

- [注意]** ① 切削方法は、ダウンカットで使用ください。
 ② 一般材、とくに高速切削は、乾式(エアブロー)またはオイルミストクーラントにてご使用ください。
 ③ ステンレス鋼および超耐熱鋼には、不水溶性切削油のご使用が適しています。
 ④ 安定した切削を行うため、剛性の高い機械とセットアップでご使用ください。
 ⑤ 機械の回転数が足りない場合は、主軸回転数とテーブル送り速度を同比率で下げてください。
 ⑥ 加工形状、機械の剛性、工具突き出し量等、ご使用の状況により、主軸回転数とテーブル送り速度の調整を行ってください。

- [Note]** ① Down-cutting is recommended.
 ② Use generally dry (air-blow) or oil-mist coolant, especially at the high-speed machining.
 ③ Oil base coolant is recommended for machining stainless steels and heat-resistant steels.
 ④ Use a machine tool with rigidity and rigid set-up, to machine stably.
 ⑤ When the revolution speed is not enough, reduce the revolution speed and table speed at the same ratio.
 ⑥ Adjust the revolution speed and table speed, according to cutting conditions such as machining shape, rigidity of machine tool, over-hang and so on.

CEPH

ハード
Hard

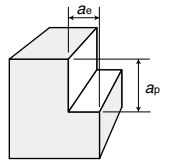

<側面切削> Side milling

被削材 Work material	炭素鋼 Carbon steels (180~220HB) SS400, S50C		合金鋼 Alloy steels (200~250HB) SCM440, SNCM		ステンレス鋼・工具鋼 Stainless steels, Tool steels (25~35HRC) SUS304, SKD		プリハードン鋼 Pre-hardened steels (35~45HRC) HPM1, NAK55		焼入れ鋼 Hardened steels (45~55HRC) SKD61, SKT4		焼入れ鋼 Hardened steels (55~65HRC) SKD11		焼入れ鋼 Hardened steels (65~70HRC) SKH, HAP		
	切込み Depth of cut (mm) $a_p=1.5DC$ $a_e \leq 0.1DC$		$a_p=1.5DC$ $a_e \leq 0.05DC$		$a_p=1.5DC$ $a_e \leq 0.05DC$		$a_p=1.5DC$ $a_e \leq 0.02DC$		$a_p=1.5DC$ $a_e \leq 0.01DC$		$a_p=1.5DC$ $a_e \leq 0.01DC$		$a_p=1.5DC$ $a_e \leq 0.01DC$		
外径DC Tool dia. (mm)	回転数 n (min^{-1})	送り速度 V_f (mm/min)	回転数 n (min^{-1})	送り速度 V_f (mm/min)	回転数 n (min^{-1})	送り速度 V_f (mm/min)	回転数 n (min^{-1})	送り速度 V_f (mm/min)	回転数 n (min^{-1})	送り速度 V_f (mm/min)	回転数 n (min^{-1})	送り速度 V_f (mm/min)	回転数 n (min^{-1})	送り速度 V_f (mm/min)	
高速条件 High speed	φ3	26,500	2,650	26,500	2,650	26,500	2,120	26,500	2,120	21,200	1,700	16,000	1,280	10,600	850
	φ4	19,900	2,790	19,900	2,790	19,900	2,400	19,900	2,400	15,900	1,900	12,000	1,440	8,000	960
	φ5	16,000	4,160	16,000	4,160	16,000	3,200	16,000	3,200	12,700	2,540	9,500	1,900	6,400	1,280
	φ6	13,300	6,400	13,300	6,400	13,300	4,800	13,300	4,800	10,600	3,800	8,000	2,880	5,300	1,900
	φ8	9,950	6,270	9,950	6,270	9,950	4,200	9,950	4,200	8,000	3,360	6,000	2,520	4,000	1,680
	φ10	8,000	5,520	8,000	5,520	8,000	3,840	8,000	3,840	6,400	3,050	4,800	2,300	3,200	1,580
	φ12	6,600	4,950	6,600	4,950	6,600	3,960	6,600	3,960	5,300	3,180	4,000	2,400	2,600	1,560
	φ16	5,000	4,000	5,000	4,000	5,000	3,600	5,000	3,600	4,000	2,880	3,000	2,160	2,000	1,440
φ20	4,000	3,360	4,000	3,360	4,000	2,880	4,000	2,880	3,200	2,300	2,400	1,730	1,600	1,150	
汎用条件 General	φ3	16,000	1,600	16,000	1,600	11,700	940	8,000	640	4,800	385	3,200	256	2,100	170
	φ4	11,200	1,570	11,200	1,570	8,800	1,060	6,000	720	3,600	430	2,400	290	1,600	190
	φ5	9,550	2,500	9,550	2,500	7,000	1,400	4,800	960	2,900	580	1,900	380	1,300	260
	φ6	8,000	3,840	8,000	3,840	5,850	2,100	3,000	1,080	2,400	860	1,600	580	1,060	380
	φ8	6,000	3,780	6,000	3,780	4,400	1,850	3,000	1,260	1,800	760	1,200	500	800	330
	φ10	4,800	3,200	4,800	3,200	3,500	1,680	2,400	1,150	1,430	690	950	220	640	300
	φ12	4,000	3,000	4,000	3,000	2,920	1,750	2,000	1,200	1,200	720	800	480	530	320
	φ16	3,000	2,400	3,000	2,400	2,200	1,580	1,500	1,080	900	650	600	430	400	290
φ20	2,400	2,000	2,400	2,000	1,750	1,260	1,200	860	720	520	480	350	320	230	

【注意】

- ① 切削方法は、ダウンカットで使用ください。
- ② 一般材、とくに高速切削は、乾式（エアブロー）またはオイルミストクーラントにてご使用ください。
- ③ ステンレス鋼および超耐熱合金には、不水溶性切削油のご使用が適しています。
- ④ 安定した切削を行うため、剛性の高い機械とセットアップでご使用ください。
- ⑤ 機械の回転数が足りない場合は、主軸回転数とテーブル送り速度を同比率で下げてください。
- ⑥ 加工形状、機械の剛性、工具突き出し量等、ご使用の状況により、主軸回転数とテーブル送り速度の調整を行ってください。

【Note】

- ① Down-cutting is recommended.
- ② Use generally dry (air-blow) or oil-mist coolant, especially at the high-speed machining.
- ③ Oil base coolant is recommended for machining stainless steels and heat-resistant alloys.
- ④ Use a machine tool with rigidity and rigid set-up, to machine stably.
- ⑤ When the revolution speed is not enough, reduce the revolution speed and table speed at the same ratio.
- ⑥ Adjust the revolution speed and table speed, according to cutting conditions such as machining shape, rigidity of machine tool, over-hang and so on.

Epoch Universal エポックユニバーサル

CEPU

ユニバーサル
Universal

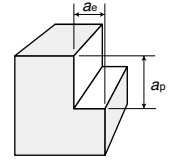

<側面切削> Side milling

被削材 Work material	鋳鉄 Cast Iron (150~200HB) FC250		炭素鋼 Carbon Steels (180~220HB) SS400, S50C		合金鋼 Alloy Steels (200~250HB) SCM440, SNCM		ステンレス鋼・工具鋼 Stainless steels, Tool steels (25~35HRC) SUS304, SKD		プリハードン鋼 Pre-hardened steels (35~45HRC) HPM1, NAK55		焼入れ鋼 Hardened Steels (45~55HRC) SKD61, SKT4		焼入れ鋼 Hardened Steels (55~65HRC) SKD11, SKH51		
	切込み Depth of cut (mm) $a_p = 1.5DC$ $a_e \leq 0.1DC$		$a_p = 1.5DC$ $a_e \leq 0.1DC$		$a_p = 1.5DC$ $a_e \leq 0.05DC$		$a_p = 1.5DC$ $a_e \leq 0.05DC$		$a_p = 1.5DC$ $a_e \leq 0.02DC$		$a_p = 1.5DC$ $a_e \leq 0.01DC$		$a_p = 1.5DC$ $a_e \leq 0.01DC$		
外径DC Tool Dia. (mm)	回転数 n (min^{-1})	送り速度 v_f (mm/min)	回転数 n (min^{-1})	送り速度 v_f (mm/min)	回転数 n (min^{-1})	送り速度 v_f (mm/min)	回転数 n (min^{-1})	送り速度 v_f (mm/min)	回転数 n (min^{-1})	送り速度 v_f (mm/min)	回転数 n (min^{-1})	送り速度 v_f (mm/min)	回転数 n (min^{-1})	送り速度 v_f (mm/min)	
高速条件 High Speed	φ4	25,000	4,500	23,900	3,350	22,300	3,100	20,700	2,400	19,900	2,400	9,500	1,140	8,000	960
	φ6	16,660	5,300	16,000	4,500	14,900	4,200	13,700	3,300	13,300	3,200	6,400	1,500	5,300	1,300
	φ8	12,500	5,250	12,000	4,800	11,100	4,400	10,350	2,900	9,950	2,800	4,800	1,350	4,000	1,120
	φ10	10,000	4,600	9,550	4,200	8,900	3,900	8,300	2,650	8,000	2,560	3,800	1,200	3,200	1,000
	φ12	8,330	4,170	8,000	3,800	7,400	3,550	6,900	2,760	6,600	2,640	3,200	1,280	2,650	1,060
	φ16	6,250	3,400	6,000	3,100	5,600	2,900	5,200	2,500	5,000	2,400	2,400	1,150	2,000	960
	φ20	5,000	2,800	4,770	2,500	4,450	2,300	4,100	1,970	4,000	1,920	1,900	910	1,600	770
汎用条件 General	φ4	12,700	2,300	12,700	1,780	9,500	1,330	8,800	1,060	7,200	865	3,200	380	2,700	240
	φ6	8,500	2,720	8,500	2,400	6,400	1,800	5,850	1,400	4,800	1,150	2,100	500	1,300	310
	φ8	6,400	2,700	6,400	2,600	4,800	1,900	4,400	1,230	3,600	1,000	1,600	450	1,000	280
	φ10	5,100	2,350	5,100	2,200	3,800	1,680	3,500	1,120	2,900	930	1,300	420	800	260
	φ12	4,200	2,100	4,200	2,000	3,200	1,500	2,920	1,170	2,400	960	1,060	420	660	260
	φ16	3,200	1,720	3,200	1,660	2,400	1,250	2,200	1,060	1,800	860	800	380	500	240
	φ20	2,550	1,400	2,500	1,300	1,900	1,000	1,750	840	1,400	670	640	300	400	190

- [注意]** ① 切削方法は、ダウンカットで使用ください。
 ② 一般材、とくに高速切削は、乾式(エアブロー)またはオイルミストクーラントにてご使用ください。
 ③ ステンレス鋼および超耐熱合金には、不水溶性切削油のご使用が適しています。
 ④ 安定した切削を行うため、剛性の高い機械とセットアップでご使用ください。
 ⑤ 機械の回転数が足りない場合は、主軸回転数とテーブル送り速度を同比率で下げてください。
 ⑥ 加工形状、機械の剛性、工具突き出し量等、ご使用の状況により、主軸回転数とテーブル送り速度の調整を行ってください。

- [Note]** ① Down-cutting is recommended.
 ② Use generally dry (air-blow) or oil-mist coolant, especially at the high-speed machining.
 ③ Oil base coolant is recommended for machining stainless steels and heat-resistant alloys.
 ④ Use a machine tool with rigidity and rigid set-up, to machine stably.
 ⑤ When the revolution speed is not enough, reduce the revolution speed and table speed at the same ratio.
 ⑥ Adjust the revolution speed and table speed, according to cutting conditions such as machining shape, rigidity of machine tool, over-hang and so on.

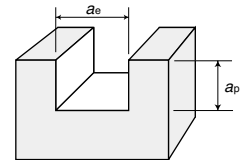

<溝切削> Slotting

被削材 Work material	鋳鉄 Cast Iron (150~200HB) FC250		炭素鋼 Carbon Steels (180~220HB) SS400, S50C		合金鋼 Alloy Steels (200~250HB) SCM440, SNCM		プリハードン鋼 Pre-hardened steels (35~45HRC) HPM1, NAK55		焼入れ鋼 Hardened Steels (45~55HRC) SKD61, SKT4	
	切込み Depth of cut (mm) $a_p \leq 1DC$, $a_e = 1DC$		$a_p \leq 1DC$, $a_e = 1DC$		$a_p \leq 1DC$, $a_e = 1DC$		$a_p \leq 0.5DC$, $a_e = 1DC$		$a_p \leq 0.2DC$, $a_e = 1DC$	
外径DC Tool dia. (mm)	回転数 n (min^{-1})	送り速度 v_f (mm/min)	回転数 n (min^{-1})	送り速度 v_f (mm/min)	回転数 n (min^{-1})	送り速度 v_f (mm/min)	回転数 n (min^{-1})	送り速度 v_f (mm/min)	回転数 n (min^{-1})	送り速度 v_f (mm/min)
高速条件 High Speed	φ4			9,550	1,530	7,960	960	3,980	400	
	φ6			6,370	1,530	5,310	1,060	2,650	420	
	φ8			4,770	1,530	3,980	1,030	1,990	400	
	φ10			3,820	1,530	3,180	1,020	1,590	380	
	φ12			3,180	1,400	2,650	950	1,330	350	
	φ16			2,390	1,150	1,990	800	990	320	
	φ20			1,910	920	1,590	640	800	260	
汎用条件 General	φ4	2,390	380	6,370	1,020	5,570	670	3,180	320	1,590
	φ6	1,590	380	4,240	1,020	3,710	740	2,120	340	1,060
	φ8	1,190	380	3,180	1,020	2,790	730	1,590	320	800
	φ10	950	380	2,550	1,020	2,230	710	1,270	300	640
	φ12	800	350	2,120	930	1,860	670	1,060	280	530
	φ16	600	290	1,590	760	1,390	560	800	260	400
	φ20	480	230	1,270	610	1,110	440	640	200	320

- [注意]** ① 一般材、とくに高速切削は、乾式(エアブロー)またはオイルミストクーラントにてご使用ください。
 ② 安定した切削を行うため、剛性の高い機械とセットアップでご使用ください。
 ③ 機械の回転数が足りない場合は、主軸回転数とテーブル送り速度を同比率で下げてください。
 ④ 加工形状、機械の剛性、工具突き出し量等、ご使用の状況により、主軸回転数とテーブル送り速度の調整を行ってください。

- [Note]** ① Use generally dry (air-blow) or oil-mist coolant, especially at the high-speed machining.
 ② Use a machine tool with rigidity and rigid set-up, to machine stably.
 ③ When the revolution speed is not enough, reduce the revolution speed and table speed at the same ratio.
 ④ Adjust the revolution speed and table speed, according to cutting conditions such as machining shape, rigidity of machine tool, over-hang and so on.

Epoch SUS Wave エポックSUSウェーブ



ロング刃長

Long

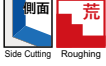

外径公差 Dia. tolerance 0~-0.05

h5 h6
φ6~12 φ16, φ20 (mm)



ステンレス鋼の低剛性マシンや・弱クランプ環境での安定加工へ対応。
For stable cutting of stainless steel in environments using low-rigidity machines and weak clamps.

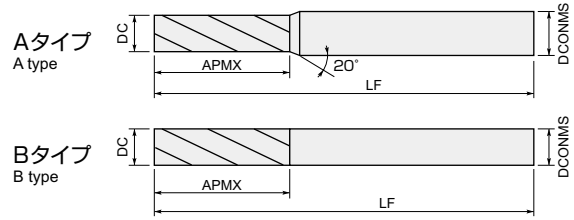

EPSWL4○○○-PN

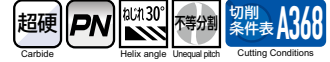

商品コード Item code	在庫 Stock	寸法 Size(mm)					刃数 No. of flutes	形状 Shape	希望小売価格(円) Suggested retail price(¥)
		外径 Tool dia.	刃長 Flute length	全長 Overall length	シャンク径 Shank dia.	コーナ 面取り幅 Corner chamfering width			
		DC	APMX	LF	DCONMS				
EPSWL4060-PN	●	6	30	70	6	0.4	4	B	22,110
EPSWL4070-PN	□	7	35	80	8	0.4	4	A	—
EPSWL4080-PN	●	8	40	80	8	0.5	4	B	25,810
EPSWL4090-PN	□	9	45	100	10	0.5	4	A	—
EPSWL4100-PN	●	10	50	100	10	0.5	4	B	29,410
EPSWL4110-PN	□	11	55	120	12	0.5	4	A	—
EPSWL4120-PN	●	12	60	120	12	0.5	4	B	35,910
EPSWL4130-PN	□	13	65	130	16	0.7	4	A	—
EPSWL4140-PN	□	14	70	130	16	0.7	4	A	—
EPSWL4150-PN	□	15	75	130	16	0.7	4	A	—
EPSWL4160-PN	●	16	80	135	16	0.7	4	B	80,360
EPSWL4170-PN	□	17	85	135	20	0.7	4	A	—
EPSWL4180-PN	□	18	90	145	20	0.7	4	A	—
EPSWL4190-PN	□	19	95	145	20	0.7	4	A	—
EPSWL4200-PN	●	20	100	155	20	0.7	4	B	116,840

○ 対応被削材 Applicable work material

炭素鋼 合金鋼 Carbon steel Alloy steel	プリハー ド鋼 Pre-hardened steel	高硬度 Hardened steel			ステン レス鋼 Stainless steel	チタン合金 耐熱合金 Titanium alloy Heat-resistant alloy	銅合金 Copper alloy	アルミ 合金 Aluminum alloy
		> 45HRC ≤ 45HRC	> 55HRC ≤ 55HRC	> 65HRC ≤ 65HRC				
○	○	○	○	○	○	○	○	

●印：標準在庫品です。 □印：特定代理店在庫です。弊社営業へお問合せください。
● : Stocked items. □ : Stocked by specified distributor. Contact with our sales department.

○ 再研磨対応外径範囲 Re-grinding compatibility range

商品コード Item code	外周 Outer dia. (mm)	エンド End (mm)
EPSWL-PN	6 ~ 20	6 ~ 20

首下3DC Under neck 3DC type

平面 Planing
 側面 Side Cutting
 溝 Slotting
 彫込み Die-sinking
 曲面 Profiling
 R Radius
 ヘリカル Helical
 座ぐり Spot Facing
 荒 Roughing
 中仕上げ Semi Finishing

外径公差 Dia.tolerance 0~-0.05
 h5 φ6~12 h6 φ16,φ20 (mm)

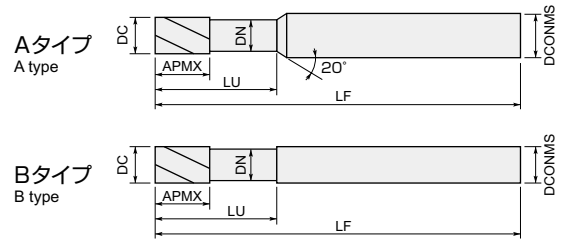

EPSW-3DC-PN

超硬 Carbide **PN** ねじり30° Helix angle 不等分削 Unequal pitch 切削条件表 A366 Cutting Conditions

商品コード Item code	在庫 Stock	寸法 Size(mm)							刃数 No. of flutes	形状 Shape	希望小売価格 (円) Suggested retail price (¥)
		外径 Tool dia. DC	刃長 Flute length APMX	首下長 Under neck length LU	首径 Neck dia. DN	全長 Overall length LF	シャンク径 Shank dia. DCONMS	コーナ 面取り幅 Corner chamfering width			
EPSW3040-12-PN	●	4	6	12	3.7	56	6	0.3	3	A	10,690
EPSW3050-15-PN	●	5	7.5	15	4.6	56	6	0.3	3	A	12,020
EPSW4060-18-PN	●	6	9	18	5.5	56	6	0.4	4	B	13,030
EPSW4070-21-PN	●	7	10.5	21	6.4	63	8	0.4	4	A	15,150
EPSW4080-24-PN	●	8	12	24	7.3	63	8	0.5	4	B	15,150
EPSW4090-27-PN	●	9	13.5	27	8.3	74	10	0.5	4	A	17,290
EPSW4100-30-PN	●	10	15	30	9.1	74	10	0.5	4	B	17,290
EPSW4110-33-PN	●	11	16.5	33	10.2	86	12	0.5	4	A	21,100
EPSW4120-36-PN	●	12	18	36	11	86	12	0.5	4	B	21,100
EPSW4160-48-PN	●	16	24	48	14.5	110	16	0.7	4	B	47,280
EPSW4200-60-PN	●	20	30	60	18.2	125	20	0.7	4	B	68,750

首下5DC Under neck 5DC

平面 Planing
 側面 Side Cutting
 溝 Slotting
 彫込み Die-sinking
 曲面 Profiling
 R Radius
 ヘリカル Helical
 座ぐり Spot Facing
 荒 Roughing
 中仕上げ Semi Finishing

外径公差 Dia.tolerance 0~-0.05
 h5 φ6~12 h6 φ16,φ20 (mm)

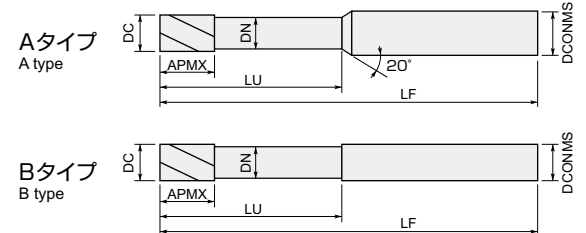

EPSW-5DC-PN

超硬 Carbide **PN** ねじり30° Helix angle 不等分削 Unequal pitch 切削条件表 A366 Cutting Conditions

商品コード Item code	在庫 Stock	寸法 Size(mm)							刃数 No. of flutes	形状 Shape	希望小売価格 (円) Suggested retail price (¥)
		外径 Tool dia. DC	刃長 Flute length APMX	首下長 Under neck length LU	首径 Neck dia. DN	全長 Overall length LF	シャンク径 Shank dia. DCONMS	コーナ 面取り幅 Corner chamfering width			
EPSW3040-20-PN	●	4	6	20	3.7	68	6	0.3	3	A	11,790
EPSW3050-25-PN	●	5	7.5	25	4.6	68	6	0.3	3	A	13,250
EPSW4060-30-PN	●	6	9	30	5.5	68	6	0.4	4	B	14,370
EPSW4070-35-PN	●	7	10.5	35	6.4	80	8	0.4	4	A	16,720
EPSW4080-40-PN	●	8	12	40	7.3	80	8	0.5	4	B	16,720
EPSW4090-45-PN	●	9	13.5	45	8.3	94	10	0.5	4	A	18,970
EPSW4100-50-PN	●	10	15	50	9.1	94	10	0.5	4	B	18,970
EPSW4110-55-PN	●	11	16.5	55	10.2	110	12	0.5	4	A	23,240
EPSW4120-60-PN	●	12	18	60	11	110	12	0.5	4	B	23,240
EPSW4160-80-PN	●	16	24	80	14.5	135	16	0.7	4	B	51,970
EPSW4200-100-PN	●	20	30	100	18.2	155	20	0.7	4	B	75,660

○ EPSW-3DC-PN、EPSW-5DC-PN の対応被削材

Applicable work material of EPSW-3DC-PN, EPSW-5DC-PN

炭素鋼 合金鋼 Carbon steel Alloy steel	プリハードン ド鋼 Pre-hardened steel	高硬度 Hardened steel			ステン レス鋼 Stainless steel	チタン合金 耐熱合金 Titanium alloy Heat-resistant alloy	銅合金 Copper alloy	アルミ 合金 Aluminum alloy
○	○	> 45HRC ≤ 55HRC	> 55HRC ≤ 65HRC	> 65HRC	○	○	○	○

○ 再研磨対応外径範囲

Re-grinding compatibility range

商品コード Item code	外周 Outer dia. (mm)	エンド End (mm)
EPSW-3DC-PN	6 ~ 20	6 ~ 20
EPSW-5DC-PN	6 ~ 20	6 ~ 20

Epoch SUS Wave エポックSUSウェーブ

標準切削条件表 Recommended cutting conditions

汎用 側面切削条件 General Side milling conditions

EPSW

レギュラー刃長・ラフィング
Regular, Roughing

EPSW-3DC

首下3DCタイプ・ラフィング
Under neck 3DC, Roughing

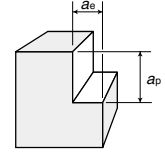

外径 DC Tool dia.	炭素鋼・合金鋼・鋳鉄 (~30HRC) Carbon steels, Alloy steels Cast irons		工具鋼・プリハードン鋼 (30~40HRC) Tool steels, Pre-hardened steels		ステンレス鋼 Stainless steels		チタン合金 Titanium alloys		超耐熱合金 Super heat-resistant alloys	
	$a_p=1DC, a_e=0.5DC$		$a_p=1DC, a_e=0.5DC$		$a_p=1DC, a_e=0.5DC$		$a_p=1DC, a_e=0.1DC$		$a_p=1DC, a_e=0.05DC$	
	回転数 n min ⁻¹	送り速度 v_f mm/min	回転数 n min ⁻¹	送り速度 v_f mm/min	回転数 n min ⁻¹	送り速度 v_f mm/min	回転数 n min ⁻¹	送り速度 v_f mm/min	回転数 n min ⁻¹	送り速度 v_f mm/min
1	31,800	760	22,300	360	19,100	310	12,700	150	9,500	76
1.5	21,200	780	14,900	370	12,700	310	8,500	160	6,400	79
2	15,900	810	11,100	380	9,500	320	6,400	160	4,800	82
2.5	12,700	830	8,900	390	7,600	330	5,100	170	3,800	83
3	10,600	860	7,400	400	6,400	350	4,200	170	3,200	86
3.5	9,100	880	6,400	410	5,500	350	3,600	170	2,700	87
4	8,000	910*	5,600	430*	4,800	360*	3,200	180*	2,400	91*
4.5	7,100	930*	5,000	440*	4,200	370*	2,800	180*	2,100	92*
5	6,400	960*	4,500	450*	3,800	380*	2,500	190*	1,900	95*
5.5	5,800	960*	4,100	450*	3,500	380*	2,300	190*	1,700	93*
6	5,300	950	3,700	440	3,200	380	2,100	190	1,600	96
6.5	4,900	960	3,400	440	2,900	380	2,000	200	1,500	97
7	4,500	940	3,200	450	2,700	380	1,800	190	1,400	98
7.5	4,200	940	3,000	450	2,500	370	1,700	190	1,300	97
8	4,000	960	2,800	450	2,400	380	1,600	190	1,200	96
8.5	3,700	940	2,600	440	2,200	370	1,500	190	1,100	93
9	3,500	940	2,500	450	2,100	380	1,400	190	1,100	99
9.5	3,400	970	2,300	440	2,000	380	1,300	190	1,000	95
10	3,200	960	2,200	440	1,900	380	1,300	200	1,000	100
10.5	3,000	920	2,100	430	1,800	370	1,200	180	900	92
11	2,900	910	2,000	420	1,700	360	1,200	190	900	94
11.5	2,800	890	1,900	400	1,700	360	1,100	170	800	85
12	2,700	870	1,900	410	1,600	350	1,100	180	800	86
13	2,400	820	1,700	390	1,500	340	1,000	170	700	80
14	2,300	840	1,600	390	1,400	340	900	160	700	85
15	2,100	810	1,500	390	1,300	340	800	150	600	77
16	2,000	820	1,400	380	1,200	330	800	160	600	82
17	1,900	800	1,300	370	1,100	310	700	150	600	85
18	1,800	800	1,200	350	1,100	320	700	150	500	74
19	1,700	780	1,200	370	1,000	310	700	160	500	77
20	1,600	770	1,100	350	1,000	320	600	140	500	80

- * $\phi 4, \phi 4.5, \phi 5, \phi 5.5$ の EPSW (エポックSUSウェーブ) は3枚刃のため、送り速度のみを75%に設定してください。
- *₂ 上表はレギュラー刃及び3DCタイプの切削条件表です。ショート刃をご使用の場合回転数・送り速度を1.1倍程度を目安に調整してください。
- * Please reduce feed rate to 75% because EPSW with dia. 4, 4.5, 5 and 5.5 are 3 flutes type.
- *₂ The table above indicates cutting parameter for regular type and 3DC type, please reduce both rotation and feed rate to 1.1 times when using short type.

[注意] 本工具のPNコーティングはその性質上、通電性が微小です。従って、通電方式の工具長測定装置をご使用の際にはご注意ください。
被削材、加工形状に合わせて、適切なクーラントを使用してください。
できるだけ高剛性、高精度の機械及びチャックをご使用ください。
この標準切削条件表は切削条件の目安を示すものです。実際の加工では、加工条件、目的、使用機械等により条件を調整してください。
ビビリや異常振動が発生する場合は条件を調整してください。

[Note] PN coating is less electro conductive. Therefore, electric transmitted measuring systems may not work.
Use the appropriate coolant for the work material and machining shape.
Use the high-rigidity and high accuracy machine as possible.
These Recommended Cutting Conditions indicate only the rule of a thumb for the cutting conditions. In actual machining, the condition should be adjusted according to the machining shape, purpose and the machine type.
Please adjust it if chatter or abnormal vibration occurs.

汎用 溝切削条件 General Slotting conditions

EPSW **EPSW-3DC**
 レギュラー刃長・ラフィング 首下3DCタイプ・ラフィング
 Regular, Roughing Under neck 3DC, Roughing

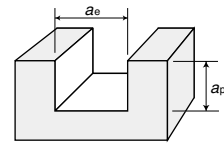

外径 DC Tool dia.	炭素鋼・合金鋼・鋳鉄 (~30HRC) Carbon steels, Alloy steels Cast irons		工具鋼・プリハードン鋼 (30~40HRC) Tool steels, Pre-hardened steels		ステンレス鋼 Stainless steels		チタン合金 Titanium alloys		超耐熱合金 Super heat-resistant alloys	
	ap=1DC		ap=1DC		ap=1DC		ap=0.5DC		ap=0.5DC	
	回転数 n min ⁻¹	送り速度 vf mm/min	回転数 n min ⁻¹	送り速度 vf mm/min	回転数 n min ⁻¹	送り速度 vf mm/min	回転数 n min ⁻¹	送り速度 vf mm/min	回転数 n min ⁻¹	送り速度 vf mm/min
1	28,600	360	19,100	190	17,500	130	11,100	60	6,400	19
1.5	19,100	390	12,700	210	11,700	140	7,400	60	4,200	21
2	14,300	430	9,500	230	8,800	160	5,600	70	3,200	23
2.5	11,500	470	7,600	250	7,000	170	4,500	70	2,500	24
3	9,500	500	6,400	270	5,800	180	3,700	80	2,100	26
3.5	8,200	540	5,500	290	5,000	200	3,200	80	1,800	28
4	7,200	580*	4,800	310*	4,400	210*	2,800	90*	1,600	31*
4.5	6,400	610*	4,200	320*	3,900	220*	2,500	100*	1,400	32*
5	5,700	640*	3,800	340*	3,500	240*	2,200	100*	1,300	35*
5.5	5,200	680*	3,500	370*	3,200	250*	2,000	100*	1,200	38*
6	4,800	720	3,200	380	2,900	260	1,900	110	1,100	40
6.5	4,400	710	2,900	380	2,700	260	1,700	110	1,000	39
7	4,100	720	2,700	380	2,500	260	1,600	110	900	38
7.5	3,800	710	2,500	370	2,300	260	1,500	110	800	36
8	3,600	720	2,400	380	2,200	260	1,400	110	800	38
8.5	3,400	720	2,200	370	2,100	270	1,300	110	700	36
9	3,200	720	2,100	380	1,900	260	1,200	110	700	38
9.5	3,000	710	2,000	380	1,800	260	1,200	110	700	40
10	2,900	730	1,900	380	1,800	270	1,100	110	600	36
10.5	2,700	690	1,800	370	1,700	260	1,100	110	600	37
11	2,600	680	1,700	360	1,600	250	1,000	100	600	38
11.5	2,500	660	1,700	360	1,500	240	1,000	110	600	38
12	2,400	650	1,600	350	1,500	240	900	100	500	32
13	2,200	630	1,500	340	1,300	220	900	100	500	34
14	2,000	610	1,400	340	1,300	240	800	100	500	37
15	1,900	610	1,300	340	1,200	230	700	90	400	31
16	1,800	610	1,200	330	1,100	220	700	100	400	33
17	1,700	600	1,100	310	1,000	210	700	100	400	34
18	1,600	590	1,100	320	1,000	220	600	90	400	35
19	1,500	580	1,000	310	900	210	600	90	300	28
20	1,400	560	1,000	320	900	220	600	100	300	29

※ φ4, φ4.5, φ5, φ5.5 の EPSW (エポック SUS ウェーブ) は3枚刃のため、送り速度のみを75%に設定してください。
 ※₂ 上表はレギュラー刃及び3DCタイプの切削条件表です。ショート刃をご使用の場合回転数・送り速度を1.1倍程度を目安に調整してください。
 ※ Please reduce feed rate to 75% because EPSW with dia. 4, 4.5, 5 and 5.5 are 3 flutes type.
 ※₂ The table above indicates cutting parameter for regular type and 3DC type, please reduce both rotation and feed rate to 1.1 times when using short type.

[注意] 本工具のPNコーティングはその性質上、通電性が微小です。従って、通電方式の工具長測定装置をご使用の際にはご注意ください。
 被削材、加工形状に合わせて、適切なクーラントを使用してください。
 できるだけ高剛性、高精度の機械及びチャックをご使用ください。
 この標準切削条件表は切削条件の目安を示すものです。実際の加工では、加工条件、目的、使用機械等により条件を調整してください。
 ビビリや異常振動が発生する場合は条件を調整してください。
 座繰り加工を行う際に、送り速度を溝条件の1/5に、0.01DCのステップに設定してください。
 傾斜進入加工を行う際に、進入角度を3°以下、送り速度を溝条件の70%送りに設定してください。

[Note] PN coating is less electro conductive. Therefore, electric transmitted measuring systems may not work.
 Use the appropriate coolant for the work material and machining shape.
 Use the high-rigidity and high accuracy machine as possible.
 These Recommended Cutting Conditions indicate only the rule of a thumb for the cutting conditions. In actual machining, the condition should be adjusted according to the machining shape, purpose and the machine type.
 Please adjust it if chatter or abnormal vibration occurs.
 Please setup feed 1/5 that of slotting parameter and step 0.01DC for drilling application.
 Please setup feed 70% of slotting parameter and ramping angle 3° for ramping application.

Epoch SUS Wave エポックSUSウェーブ

超硬エポックSUSウェーブ
エポックSUSウェーブ

汎用 側面切削条件 General Side milling conditions

EPSW-5DC

首下5DCタイプ・ラフィング
Under neck 5DC, Roughing

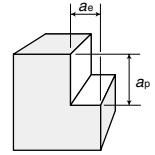

外径 DC Tool dia.	炭素鋼・合金鋼・鋳鉄 (~30HRC) Carbon steels, Alloy steels Cast irons		工具鋼・プリハードン鋼 (30~40HRC) Tool steels, Pre-hardened steels		ステンレス鋼 Stainless steels		チタン合金 Titanium alloys		超耐熱合金 Super heat-resistant alloys	
	ap=0.5DC, ae=0.25DC		ap=0.5DC, ae=0.25DC		ap=0.5DC, ae=0.25DC		ap=0.5DC, ae=0.1DC		ap=0.5DC, ae=0.05DC	
	回転数 n min ⁻¹	送り速度 vf mm/min	回転数 n min ⁻¹	送り速度 vf mm/min	回転数 n min ⁻¹	送り速度 vf mm/min	回転数 n min ⁻¹	送り速度 vf mm/min	回転数 n min ⁻¹	送り速度 vf mm/min
1	28,600	690	19,100	310	15,900	250	12,700	150	9,500	76
1.5	19,100	710	12,700	320	10,600	260	8,500	160	6,400	80
2	14,300	730	9,500	320	8,000	270	6,400	160	4,800	82
2.5	11,500	760	7,600	330	6,400	280	5,100	170	3,800	84
3	9,500	770	6,400	350	5,300	290	4,200	170	3,200	86
3.5	8,200	800	5,500	360	4,500	290	3,600	180	2,700	88
4	7,200	820*	4,800	360*	4,000	300*	3,200	180*	2,400	91*
4.5	6,400	850	4,200	370	3,500	310	2,800	190	2,100	93
5	5,700	860*	3,800	380*	3,200	320*	2,500	190*	1,900	95*
5.5	5,200	860	3,500	390	2,900	320	2,300	190	1,700	94
6	4,800	860	3,200	380	2,700	320	2,100	190	1,600	96
6.5	4,400	860	2,900	380	2,400	310	2,000	200	1,500	98
7	4,100	860	2,700	380	2,300	320	1,800	190	1,400	98
7.5	3,800	860	2,500	380	2,100	320	1,700	190	1,300	98
8	3,600	860	2,400	380	2,000	320	1,600	190	1,200	96
8.5	3,400	870	2,200	370	1,900	320	1,500	190	1,100	94
9	3,200	860	2,100	380	1,800	320	1,400	190	1,100	99
9.5	3,000	860	2,000	380	1,700	320	1,300	190	1,000	95
10	2,900	870	1,900	380	1,600	320	1,300	200	1,000	100
10.5	2,700	830	1,800	370	1,500	310	1,200	190	900	93
11	2,600	820	1,700	360	1,400	290	1,200	190	900	94
11.5	2,500	800	1,700	360	1,400	300	1,100	180	800	86
12	2,400	780	1,600	350	1,300	280	1,100	180	800	86
13	2,200	760	1,500	350	1,200	280	1,000	170	700	81
14	2,000	740	1,400	340	1,100	270	900	170	700	86
15	1,900	740	1,300	340	1,100	280	800	150	600	77
16	1,800	730	1,200	330	1,000	270	800	160	600	82
17	1,700	730	1,100	310	900	260	700	150	600	86
18	1,600	720	1,100	330	900	270	700	160	500	75
19	1,500	690	1,000	310	800	250	700	160	500	77
20	1,400	670	1,000	320	800	260	600	140	500	80

- * φ4, φ5 の EPSW (エポックSUSウェーブ) は3枚刃のため、送り速度のみを75%に設定してください。
- *4 上表は5DCタイプおよび5DC突出した際の切削条件表です。工具突出し量により条件を調整してください。
- * Please reduce feed rate to 75% because EPSW with dia. 4, and 5 are 3 flutes type.
- *4 The above table shows cutting conditions for 5DC type tools with a 5DC overhang. Adjust conditions according to the tool overhang amount.

[注意] 本工具のPNコーティングはその性質上、通電性が微小です。従って、通電方式の工具長測定装置をご使用の際にはご注意ください。
被削材、加工形状に合わせて、適切なクーラントを使用してください。
できるだけ高剛性、高精度の機械及びチャックをご使用ください。
この標準切削条件表は切削条件の目安を示すものです。実際の加工では、加工条件、目的、使用機械等により条件を調整してください。
ビビリや異常振動が発生する場合は条件を調整してください。

[Note] PN coating is less electro conductive. Therefore, electric transmitted measuring systems may not work.
Use the appropriate coolant for the work material and machining shape.
Use the high-rigidity and high accuracy machine as possible
These Recommended Cutting Conditions indicate only the rule of a thumb for the cutting conditions. In actual machining, the condition should be adjusted according to the machining shape, purpose and the machine type.
Please adjust it if chatter or abnormal vibration occurs.

汎用 溝切削条件 General Slotting conditions

EPSW-5DC

首下5Dタイプ・ラフィング
Under neck 5DC, Roughing

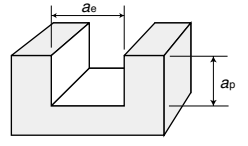

外径 DC Tool dia.	炭素鋼・合金鋼・鋳鉄 (~30HRC) Carbon steels, Alloy steels Cast irons		工具鋼・プリハードン鋼 (30~40HRC) Tool steels, Pre-hardened steels		ステンレス鋼 Stainless steels		チタン合金 Titanium alloys		超耐熱合金 Super heat-resistant alloys	
	ap=0.5DC		ap=0.5DC		ap=0.5DC		ap=0.25DC		ap=0.25DC	
	回転数 n min ⁻¹	送り速度 vf mm/min	回転数 n min ⁻¹	送り速度 vf mm/min	回転数 n min ⁻¹	送り速度 vf mm/min	回転数 n min ⁻¹	送り速度 vf mm/min	回転数 n min ⁻¹	送り速度 vf mm/min
1	25,500	320	15,900	160	14,300	110	9,500	50	4,800	14
1.5	17,000	350	10,600	170	9,500	120	6,400	50	3,200	16
2	12,700	380	8,000	190	7,200	130	4,800	60	2,400	17
2.5	10,200	410	6,400	210	5,700	140	3,800	60	1,900	19
3	8,500	450	5,300	220	4,800	150	3,200	70	1,600	20
3.5	7,300	480	4,500	240	4,100	160	2,700	70	1,400	22
4	6,400	510*	4,000	260*	3,600	170*	2,400	80*	1,200	23*
4.5	5,700	550	3,500	270	3,200	180	2,100	80	1,100	25
5	5,100	570*	3,200	290*	2,900	200*	1,900	90*	1,000	27*
5.5	4,600	600	2,900	300	2,600	200	1,700	90	900	28
6	4,200	630	2,700	320	2,400	220	1,600	100	800	29
6.5	3,900	630	2,400	310	2,200	210	1,500	100	700	27
7	3,600	630	2,300	320	2,000	210	1,400	100	700	29
7.5	3,400	640	2,100	320	1,900	210	1,300	100	600	27
8	3,200	640	2,000	320	1,800	220	1,200	100	600	29
8.5	3,000	640	1,900	320	1,700	220	1,100	90	600	31
9	2,800	630	1,800	320	1,600	220	1,100	100	500	27
9.5	2,700	640	1,700	320	1,500	210	1,000	100	500	29
10	2,500	630	1,600	320	1,400	210	1,000	100	500	30
10.5	2,400	620	1,500	310	1,400	220	900	90	500	31
11	2,300	600	1,400	290	1,300	200	900	90	400	25
11.5	2,200	590	1,400	300	1,200	190	800	90	400	26
12	2,100	570	1,300	280	1,200	190	800	90	400	26
13	2,000	580	1,200	280	1,100	190	700	80	400	28
14	1,800	550	1,100	270	1,000	180	700	90	300	22
15	1,700	550	1,100	280	1,000	190	600	80	300	23
16	1,600	540	1,000	270	900	180	600	80	300	24
17	1,500	540	900	260	800	170	600	90	300	26
18	1,400	520	900	270	800	180	500	70	300	27
19	1,300	500	800	250	800	180	500	80	300	28
20	1,300	520	800	260	700	170	500	80	200	19

※φ4、φ5のEPSW(エポックSUSウェーブ)は3枚刃のため、送り速度のみを75%に設定してください。
※Please reduce feed rate to 75% because EPSW with dia. 4, and 5 are 3 flutes type.

【注意】 本工具のPNコーティングはその性質上、通電性が微小です。従って、通電方式の工具長測定装置をご使用の際にはご注意ください。
被削材、加工形状に合わせて、適切なクーラントを使用してください。
できるだけ高剛性、高精度の機械及びチャックをご使用ください。
この標準切削条件表は切削条件の目安を示すものです。実際の加工では、加工条件、目的、使用機械等により条件を調整してください。
ビビリや異常振動が発生する場合は条件を調整してください。
座繰り加工を行う際に、送り速度を溝条件の1/5に、0.01DCのステップに設定してください。
傾斜進入加工を行う際に、進入角度を3°以下、送り速度を溝条件の70%送りに設定してください。

【Note】 PN coating is less electro conductive. Therefore, electric transmitted measuring systems may not work.
Use the appropriate coolant for the work material and machining shape.
Use the high-rigidity and high accuracy machine as possible
These Recommended Cutting Conditions indicate only the rule of a thumb for the cutting conditions. In actual machining, the condition should be adjusted according to the machining shape, purpose and the machine type.
Please adjust it if chatter or abnormal vibration occurs.
Please setup feed 1/5 that of slotting parameter and step 0.01DC for drilling application.
Please setup feed 70% of slotting parameter and ramping angle 3° for ramping application.

Epoch SUS Wave エポックSUSウェーブ

超硬合金ドリル
スクエアエンドミル

汎用 側面切削条件

General Side milling conditions

EPSWL

ロング刃長・ラフィング
Long, Roughing

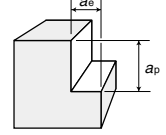

外径 DC Tool dia.	炭素鋼・合金鋼・鋳鉄 (~30HRC) Carbon steels, Alloy steels, Cast irons		工具鋼・プリハードン鋼 (30~40HRC) Tool steels, Pre-hardened steels		ステンレス鋼 Stainless steels		チタン合金 Titanium alloys		超耐熱合金 Super heat-resistant alloys	
	$a_p=3DC, a_e=0.05DC$		$a_p=3DC, a_e=0.05DC$		$a_p=3DC, a_e=0.05DC$		$a_p=3DC, a_e=0.02DC$		$a_p=3DC, a_e=0.01DC$	
	回転数 n min ⁻¹	送り速度 v_f mm/min	回転数 n min ⁻¹	送り速度 v_f mm/min	回転数 n min ⁻¹	送り速度 v_f mm/min	回転数 n min ⁻¹	送り速度 v_f mm/min	回転数 n min ⁻¹	送り速度 v_f mm/min
6	2,700	490	1,900	230	1,600	190	1,100	100	800	48
8	2,000	480	1,400	220	1,200	190	800	100	600	48
10	1,600	480	1,100	220	1,000	200	600	90	500	50
12	1,300	420	900	190	800	170	500	80	400	43
16	1,000	410	700	190	600	160	400	80	300	41
20	800	380	600	190	500	160	300	70	200	32

【注意】 本工具のPNコーティングはその性質上、通電性が微小です。従って、通電方式の工具長測定装置をご使用の際にはご注意ください。
被削材、加工形状に合わせて、適切なクーラントを使用してください。
できるだけ高剛性、高精度の機械及びチャックをご使用ください。
この標準切削条件表は切削条件の目安を示すものです。実際の加工では、加工条件、目的、使用機械等により条件を調整してください。
ビビリや異常振動が発生する場合は条件を調整してください。

【Note】 PN coating is less electro conductive. Therefore, electric transmitted measuring systems may not work.
Use the appropriate coolant for the work material and machining shape.
Use the high-rigidity and high accuracy machine as possible
These Recommended Cutting Conditions indicate only the rule of a thumb for the cutting conditions. In actual machining, the condition should be adjusted according to the machining shape, purpose and the machine type.
Please adjust it if chatter or abnormal vibration occurs.

Epoch Roughing エポックラフィング

ステンレスなどの難削材荒加工に適したラフィングエンドミル。
Ideal roughing end mill for roughing of difficult-to-cut materials such as stainless steel, etc.

レギュラー刃長 Regular

側面 Side Cutting, 溝 Slotting, 荒 Roughing

外径公差 Dia. tolerance 0~-0.05

h6

(mm)

ロング刃長 Long

側面 Side Cutting, 荒 Roughing

外径公差 Dia. tolerance 0~-0.05

h6

(mm)

4枚刃
4Flutes



4枚刃
4Flutes



Aタイプ
A type



Bタイプ
B type

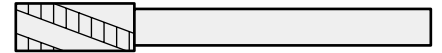

Cタイプ
C type

EPQR4-0000-CS

超硬 CS ねじり30° 切削条件表 A370
Carbide Helix angle Cutting Conditions

商品コード Item code	在庫 Stock	寸法 Size (mm)					形状 Shape	希望小売 価格(円) Suggested retail price(¥)
		外径 Tool dia.	刃長 Flute length	全長 Overall length	シャンク径 Shank dia.	コーナ 面取り幅 Corner chamfering width		
EPQR4060-CS	●	6	15	55	6	0.4	A	15,490
EPQR4070-CS	●	7	20	65	8	0.4	B	20,200
EPQR4080-CS	●	8	20	70	8	0.5	A	18,860
EPQR4090-CS	●	9	25	75	10	0.5	B	25,930
EPQR4100-CS	●	10	25	80	10	0.5	A	25,480
EPQR4110-CS	●	11	30	85	12	0.5	B	34,350
EPQR4120-CS	●	12	30	90	12	0.5	A	31,870
EPQR4130-CS	□	13	35	100	16	0.7	B	—
EPQR4140-CS	□	14	35	100	16	0.7	B	—
EPQR4150-CS	□	15	35	100	16	0.7	B	—
EPQR4160-CS	●	16	40	110	16	0.7	A	77,550
EPQR4170-CS	□	17	40	110	20	0.7	B	—
EPQR4180-CS	□	18	45	120	20	0.7	B	—
EPQR4190-CS	□	19	45	120	20	0.7	B	—
EPQR4200-CS	●	20	50	125	20	0.7	A	113,330

EPQL4-0000-CS

超硬 CS ねじり30° 切削条件表 A370
Carbide Helix angle Cutting Conditions

商品コード Item code	在庫 Stock	寸法 Size (mm)					形状 Shape	希望小売 価格(円) Suggested retail price(¥)
		外径 Tool dia.	刃長 Flute length	全長 Overall length	シャンク径 Shank dia.	コーナ 面取り幅 Corner chamfering width		
EPQL4060-CS	●	6	30	70	6	0.4	A	27,380
EPQL4070-CS	□	7	40	80	8	0.4	B	—
EPQL4080-CS	●	8	40	80	8	0.5	A	34,460
EPQL4090-CS	□	9	50	100	10	0.5	B	—
EPQL4100-CS	●	10	50	100	10	0.5	A	46,350
EPQL4110-CS	□	11	60	120	12	0.5	B	—
EPQL4120-CS	●	12	60	120	12	0.5	A	56,790
EPQL4130-CS	□	13	70	130	16	0.7	B	—
EPQL4140-CS	□	14	70	130	16	0.7	B	—
EPQL4150-CS	□	15	70	130	16	0.7	B	—
EPQL4160-CS	●	16	75	135	16	0.7	A	140,760
EPQL4170-CS	□	17	75	135	20	0.7	B	—
EPQL4180-CS	□	18	80	145	20	0.7	B	—
EPQL4190-CS	□	19	80	145	20	0.7	B	—
EPQL4200-CS	●	20	90	155	20	0.7	A	204,110

EPQR、EPQL の対応被削材

Applicable work material of EPQR, EPQL

炭素鋼 合金鋼 Carbon steel Alloy steel	プリハー ド鋼 Pre-hardened steel	高硬度 Hardened steel		ステン レス鋼 Stainless steel	チタン合金 耐熱合金 Titanium alloy Heat-resistant alloy	銅合金 Copper alloy	アルミ 合金 Aluminium alloy
○	○	> 45HRC ≤ 55HRC	> 55HRC ≤ 65HRC	> 65HRC	○	○	○

再研磨対応外径範囲

Re-grinding compatibility range

商品コード Item code	外周 Outer dia. (mm)	エンド End (mm)
EPQR-CS	6 ~ 20	6 ~ 20
EPQL-CS	6 ~ 20	6 ~ 20

●印：標準在庫品です。 □印：特定代理店在庫です。弊社営業へお問合せください。
● : Stocked items. □ : Stocked by specified distributor. Contact with our sales department.

Epoch Roughing エポックラフィング

標準切削条件表 Recommended cutting conditions

EPQR-CS	EPQL-CS	EPQS-CS	EPQM-CS	EPQLS-CS
レギュラー刃長 Regular	ロング刃長 Long	ショート刃長 Short	ミディアム刃長 Medium	ロングシャンク Long shank

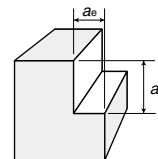

〈側面切削〉 Side milling

被削材 Work material	炭素鋼・合金鋼・鋳鉄 Carbon steels, Alloy steels, Cast irons (~30HRC)		工具鋼・プリハードン鋼 Tool steels, Pre-hardened steels (30~40HRC)		ステンレス鋼 Stainless steels		超耐熱合金 Super heat-resistant alloys	
	切込み Depth of cut (mm) $a_p \leq 1.5DC$ $a_e \leq 0.5DC$		切込み Depth of cut (mm) $a_p \leq 1.5DC$ $a_e \leq 0.5DC$		切込み Depth of cut (mm) $a_p \leq 1.5DC$ $a_e \leq 0.5DC$		切込み Depth of cut (mm) $a_p \leq 1.0DC$ $a_e \leq 0.2DC$	
外径 DC Tool dia. (mm)	回転数 n (min^{-1})	送り速度 v_f (mm/min)	回転数 n (min^{-1})	送り速度 v_f (mm/min)	回転数 n (min^{-1})	送り速度 v_f (mm/min)	回転数 n (min^{-1})	送り速度 v_f (mm/min)
φ6	6,400	800	3,700	410	3,200	330	2,100	80
φ8	4,800	820	2,800	440	2,400	380	1,600	100
φ10	3,800	830	2,200	440	1,900	380	1,300	110
φ12	3,200	830	1,900	430	1,600	330	1,100	115
φ16	2,400	810	1,400	400	1,200	340	800	115
φ20	2,000	800	1,100	390	1,000	320	600	105

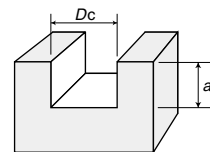

〈溝切削〉 Slotting

被削材 Work material	炭素鋼・合金鋼・鋳鉄 Carbon steels, Alloy steels, Cast irons (~30HRC)		工具鋼・プリハードン鋼 Tool steels, Pre-hardened steels (30~40HRC)		ステンレス鋼 Stainless steels		超耐熱合金 Super heat-resistant alloys	
	切込み Depth of cut (mm) $a_p \leq 1.0DC$		切込み Depth of cut (mm) $a_p \leq 1.0DC$		切込み Depth of cut (mm) $a_p \leq 1.0DC$		切込み Depth of cut (mm) $a_p \leq 0.5DC$	
外径 DC Tool dia. (mm)	回転数 n (min^{-1})	送り速度 v_f (mm/min)	回転数 n (min^{-1})	送り速度 v_f (mm/min)	回転数 n (min^{-1})	送り速度 v_f (mm/min)	回転数 n (min^{-1})	送り速度 v_f (mm/min)
φ6	5,300	590	3,500	300	2,800	210	1,100	32
φ8	4,000	610	2,600	320	2,100	230	800	37
φ10	3,200	610	2,000	320	1,700	230	600	37
φ12	2,700	610	1,700	320	1,400	230	500	41
φ16	2,000	580	1,300	330	1,000	190	400	46
φ20	1,600	560	1,100	300	800	170	300	41

【注意】

- ①上記条件は、レギュラー刃の条件を示します。
- ②ショート刃長をご使用の場合、上記条件の1.3倍の送り速度で加工してください。
- ③ミディアム刃長をご使用の場合、上記条件の回転数・送り速度の80%を目安にしてください。
- ④ロング刃長をご使用の場合、上記条件の回転数・送り速度の50%を目安とし、切込み(a_e)も0.1DC~0.2DCを目安にしてください。
また、ロング刃長は溝切削には適しません。
- ⑤ロングシャンクをご使用の場合、上記条件の回転数・送り速度の50%を目安とし、切込み(a_e)も0.1DC~0.3DCを目安にしてください。
ロングシャンクは溝切削には適しません。
- ⑥被削材、加工形状に合わせて、適切なクーラントを使用してください。
- ⑦この標準切削条件表は切削条件の目安を示すものです。実際の加工では加工形状、目的、使用機械等により条件を調整してください。

【Note】

- ①The above conditions are conditions for regular flutes.
- ②When using short-length flutes, perform machining at feed rates of 1.3 times the conditions stated above.
- ③When using medium-length flutes, in general rotation speed and feed rate should be 80% of the conditions stated above.
- ④When using long-length flutes, in general rotation speed and feed rate should be 50% of the conditions stated above, and the cutting depth (a_e) should also be 0.1DC to 0.2DC in general. Further, long-length flutes are not suitable for slotting.
- ⑤When using long shank tools, in general rotation speed and feed rate should be 50% of the conditions stated above, and the cutting depth (a_e) should also be 0.1DC to 0.3DC in general. Long shanks are not suitable for slotting.
- ⑥Use the appropriate coolant for the work material and machining shape.
- ⑦These Recommended Cutting Conditions indicate only the rule of a thumb for the cutting conditions. In actual machining, the condition should be adjusted according to the machining shape, purpose and the machine type.

Epoch Aero Power Mill エポックエアロパワーミル

耐熱鋼、チタン合金などの難削材に適しています。

ラジウスはA269頁を参照してください
Please refer to page A269 for Radius

Ideal for difficult-to-cut materials such as heat-resistant steel, titanium alloys, etc.

4枚刃・スクエア 4 flutes, Square

外径公差 Dia. tolerance 0~-0.02 **h6** (mm)

6枚刃・スクエア 6 flutes, Square

外径公差 Dia. tolerance 0~-0.02 **h6** (mm)

4枚刃
4Flutes



6枚刃
6Flutes



EAP4-TH

超硬 TH 傾斜43° 不等分削 切削条件表 A372
Carbide Helix angle Unequal pitch Cutting Conditions

商品コード Item code	在庫 Stock	寸法 Size (mm)			
		外径 Tool dia.	刃長 Flute length	全長 Overall length	シャンク径 Shank dia.
EAP4060-TH	◎	6	15	60	6
EAP4080-TH	◎	8	20	75	8
EAP4100-TH	◎	10	25	80	10
EAP4120-TH	◎	12	30	100	12
EAP4160-TH	◎	16	40	110	16
EAP4200-TH	◎	20	45	125	20

EAP6-TH

超硬 TH 傾斜43° 不等分削 切削条件表 A373
Carbide Helix angle Unequal pitch Cutting Conditions

商品コード Item code	在庫 Stock	寸法 Size (mm)			
		外径 Tool dia.	刃長 Flute length	全長 Overall length	シャンク径 Shank dia.
EAP6060-TH	◎	6	15	60	6
EAP6080-TH	◎	8	20	75	8
EAP6100-TH	◎	10	25	80	10
EAP6120-TH	◎	12	30	100	12
EAP6160-TH	◎	16	40	110	16
EAP6200-TH	◎	20	45	125	20

◎ EAP4-TH、EAP6-THの対応被削材

Applicable work material of EAP4-TH, EAP6-TH

炭素鋼 合金鋼 Carbon steel Alloy steel	プリハードン鋼 Pre-hardened steel ≤ 45HRC	高硬度 Hardened steel			ステンレス鋼 Stainless steel	チタン合金 耐熱合金 Titanium alloy Heat-resistant alloy	銅合金 Copper alloy	アルミ合金 Aluminum alloy
		> 45HRC ≤ 55HRC	> 55HRC ≤ 65HRC	> 65HRC				
○					◎	◎		

◎ 再研磨対応外径範囲

Re-grinding compatibility range

商品コード Item code	外周 Outer dia. (mm)	エンド End (mm)
EAP4-TH	6 ~ 20	6 ~ 20
EAP6-TH	8 ~ 20	6 ~ 20

◎印：メーカー在庫品です。弊社営業へお問い合わせください。○：Manufacturer stocked items. Contact with our sales department.

Epoch Aero Power Mill エポックエアロパワーミル

標準切削条件表 Recommended cutting conditions

EAP4-TH

4枚刃・レギュラー刃長
4ft, Regular

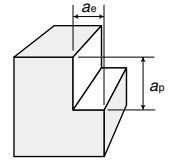

〈側面切削〉 Side milling

被削材 Work material	合金鋼 Alloy steels		ステンレス鋼・耐熱鋼 Stainless steels, Heat resistant steels		チタン・チタン合金 Titanium Titanium alloys		超耐熱合金 Super heat resistant alloys		焼入れ鋼 Hardened steels (45~55HRC) SKD61,SKT4
	SCM, SNCM		SUS, SUH		Ti-6Al-4V		Inconel718		
切込み Depth of cut (mm)	$a_p = 1.5DC$ $a_e < 0.1DC$		$a_p = 1DC$ $a_e < 0.05DC$		$a_p = 1DC$ $a_e < 0.05DC$		$a_p = 1DC$ $a_e < 0.05DC$		適していません Unsuitable for high hardness material.
外径 DC Tool dia.(mm)	回転数 n (min ⁻¹)	送り速度 v_f (mm/min)	回転数 n (min ⁻¹)	送り速度 v_f (mm/min)	回転数 n (min ⁻¹)	送り速度 v_f (mm/min)	回転数 n (min ⁻¹)	送り速度 v_f (mm/min)	
φ6	5,300	1,060	3,700	590	3,700	590	2,100	230	
φ8	4,000	1,110	2,800	560	2,800	560	1,600	220	
φ10	3,200	1,020	2,200	540	2,200	540	1,300	200	
φ12	2,700	960	1,900	520	1,850	520	1,100	170	
φ16	2,000	800	1,400	450	1,400	450	800	130	
φ20	1,600	760	1,100	450	1,100	450	640	100	

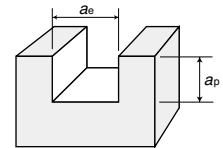

〈溝切削〉 Slotting

被削材 Work material	合金鋼 Alloy steels		ステンレス鋼・耐熱鋼 Stainless steels, Heat resistant steels		チタン・チタン合金 Titanium Titanium alloys		超耐熱合金 Super heat resistant alloys		焼入れ鋼 Hardened steels (45~55HRC) SKD61,SKT4
	SCM, SNCM		SUS, SUH		Ti-6Al-4V		Inconel718		
切込み Depth of cut (mm)	$a_p < 1DC$ $a_e = 1DC$		$a_p = 0.5DC$ $a_e = 1DC$		$a_p = 0.2DC$ $a_e = 1DC$		$a_p = 0.2DC$ $a_e = 1DC$		適していません Unsuitable for high hardness material.
外径 DC Tool dia.(mm)	回転数 n (min ⁻¹)	送り速度 v_f (mm/min)	回転数 n (min ⁻¹)	送り速度 v_f (mm/min)	回転数 n (min ⁻¹)	送り速度 v_f (mm/min)	回転数 n (min ⁻¹)	送り速度 v_f (mm/min)	
φ6	2,650	420	2,400	380	2,100	340	1,000	100	
φ8	2,000	400	1,800	360	1,600	320	720	90	
φ10	1,600	380	1,450	340	1,300	310	600	85	
φ12	1,300	370	1,200	330	1,050	300	500	70	
φ16	1,000	320	900	290	800	250	360	50	
φ20	800	320	700	290	650	250	290	40	

- 【注意】** ①被削材、加工形状に合わせて、適切なクーラントを使用してください。
 ②できるだけ高剛性、高精度の機械及びチャックをご使用ください。
 ③この標準切削条件表は切削条件の目安を示すものです。ビビリや異常振動が発生する場合は条件を調整してください。

- 【Note】** ①Use the appropriate coolant for the work material and machining shape.
 ②Use the high-rigidity and high accuracy machine as possible
 ③Cutting parameters in shown table are general recommendation. Please adjust it if chatter or abnormal vibration occurs.

EAP6-TH
6枚刃・レギュラー刃長
6ft, Regular

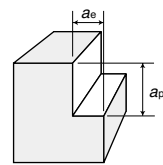

〈側面切削〉 Side milling

被削材 Work material	合金鋼 Alloy steels		ステンレス鋼・耐熱鋼 Stainless steels, Heat resistant steels		チタン・チタン合金 Titanium Titanium alloys		超耐熱合金 Super heat resistant alloys		焼入れ鋼 Hardened steels (45~55HRC) SKD61,SKT4
	SCM, SNCM		SUS, SUH		Ti-6Al-4V		Inconel718		
切込み Depth of cut (mm)	$a_p = 1.5DC$ $a_e < 0.1DC$		$a_p = 1DC$ $a_e < 0.05DC$		$a_p = 1DC$ $a_e < 0.05DC$		$a_p = 1DC$ $a_e < 0.05DC$		適していません Unsuitable for high hardness material.
外径 DC Tool dia.(mm)	回転数 n (min ⁻¹)	送り速度 v_f (mm/min)	回転数 n (min ⁻¹)	送り速度 v_f (mm/min)	回転数 n (min ⁻¹)	送り速度 v_f (mm/min)	回転数 n (min ⁻¹)	送り速度 v_f (mm/min)	
φ6	7,950	1,910	4,250	920	3,700	800	2,100	320	
φ8	6,000	1,970	3,200	900	2,800	790	1,600	300	
φ10	4,800	2,010	2,550	760	2,200	670	1,300	260	
φ12	4,000	1,910	2,100	840	1,850	740	1,100	230	
φ16	3,000	1,610	1,600	740	1,400	640	800	180	
φ20	2,400	1,430	1,300	690	1,100	600	640	150	

- 【注意】** ①被削材、加工形状に合わせて、適切なクーラントを使用してください。
 ②できるだけ高剛性、高精度の機械及びチャックをご使用ください。
 ③この標準切削条件表は切削条件の目安を示すものです。ビビリや異常振動が発生する場合は条件を調整してください。

- 【Note】** ①Use the appropriate coolant for the work material and machining shape.
 ②Use the high-rigidity and high accuracy machine as possible
 ③Cutting parameters in shown table are general recommendation. Please adjust it if chatter or abnormal vibration occurs.

加工上の注意点

Cautions

- 高硬度材の切削には不適です。硬さが45HRCを超える材料の場合には、CEPR-THあるいはEPP-THを推奨いたします。
When handling the work with hardness more than 45HRC, please use our CEPR-TH or EPP-TH.
- 必ず十分なクーラントをかけて、切削を行ってください。
Coolant is necessary for machining heat resistant materials.
- 板材のような剛性の弱いワーク形状の溝切削の場合には、トロコイド加工を推奨します。
In the case of slotting in a plate, We recommend using a trochoidal cutting.
- 耐熱鋼と超耐熱合金の穴加工には、4枚刃仕様でのヘリカル加工あるいは弊社のノンステップボーラーを推奨いたします。
When hole machining is needed on heat resistant material, We recommend performing a helical boring by Adopting EAP4, or using our NSB borer for higher efficiency.
- 耐熱鋼と超耐熱合金の切削においては、加工硬化面を切削する事を避けるために、0.1mm以上の径方向切込み量を推奨いたします。
In order to avoid constant cutting work-hardened layer, We recommend to set up width of cut more than 0.1mm.

Epoch Mirus Type A for Aluminium

エポックミルス タイプA (アルミ用)

メーカー在庫品

Manufacture stocked items

超高効率アルミ加工用エンドミル

Ultra high efficiency end mill for aluminium.

ラジウスはA272頁を参照してください
Please refer to page A272 for Radius



外径公差 0~-0.02



(mm)

3枚刃タイプ 3Flutes type

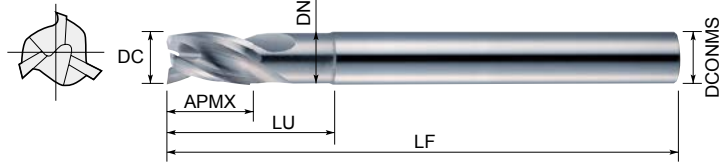

EMXA3

ノンコーティング Non Coating

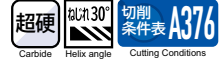

タイプ Type	商品コード Item code	在庫 Stock	寸法 Size(mm)					シャンク径 Shank dia. DCONMS
			外径 Tool dia. DC	刃長 Flute length APMX	首下長 Under neck length LU	首径 Neck dia. DN	全長 Overall length LF	
スクエア Square	EMXA3030-9	◎	3	4.5	9	2.9	60	6
	EMXA3040-12	◎	4	6	12	3.75	60	6
	EMXA3050-15	◎	5	7.5	15	4.75	80	6
	EMXA3060-18	◎	6	9	18	5.75	80	6
	EMXA3080-24	◎	8	12	24	7.5	90	8
	EMXA3100-30	◎	10	15	30	9.5	100	10
	EMXA3120-36	◎	12	18	36	11.5	120	12
	EMXA3160-45	◎	16	19	45	15.5	90	16

受注生産品(フルオーダー) Made-to-order items (Full-order)

上記以外のラインナップにつきましては、下記範囲にて受注生産品として承ります。
For the lineup of products other than above-mentioned list, made-to-order products within the following ranges are available.



ご注文方法
Ordering method

ご注文コード: EMXA - (A) - (C)
Order code

刃数 外径 首下長 コーティング
No. of flutes Tool dia. Under neck length Coating

外径・刃数 : 2枚刃タイプ : φ10~φ25
3枚刃タイプ : φ3~φ16

Mill dia., No. of flutes : 2Flutes type : φ10~φ25
: 3Flutes type : φ3~φ16

首下長 : 10DC以下
(ただし、全長によってはお受け出来ない場合があります。)

Under neck length : 10DC or less (However, orders cannot be accepted in some cases depending on the overall length.)

コーティング : ノンコーティング / PNコーティング / SDコーティング

Coating : Non Coating PN Coating / SD Coating

EMXA2、EMXA3の対応被削材

Applicable work material of EMXA2, EMXA3

炭素鋼 合金鋼 Carbon steel Alloy steel	プリハードン鋼 Pre-hardened steel ≤ 45HRC	高硬度 Hardened steel			ステンレス鋼 Stainless steel	チタン合金 耐熱合金 Titanium alloy Heat-resistant alloy	銅合金 Copper alloy	アルミ合金 Aluminum alloy
		> 45HRC ≤ 55HRC	> 55HRC ≤ 65HRC	> 65HRC				
								◎

再研磨対応外径範囲

Re-grinding compatibility range

商品コード Item code	外周 Outer dia. (mm)	エンド End (mm)
EMXA3	6 ~ 16	3 ~ 16
EMXA2	10 ~ 25	10 ~ 25

◎印 : メーカー在庫品です。弊社営業へお問い合わせください。 ○ : Manufacturer stocked items. Contact with our sales department.

受注生産品 (セミオーダー) Made-to-order items (Semi-order)



外径公差 0~-0.02



(mm)

2枚刃タイプ 2Flutes type

コーティングをご指定ください。
Please specify the desired coating.

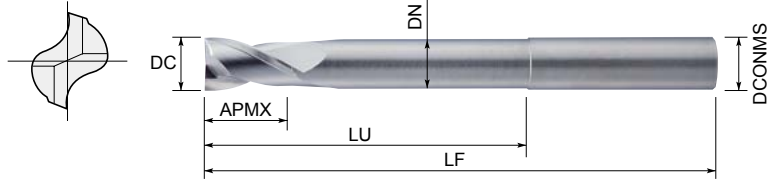

EMXA2○○○-○○○-(C)



タイプ Type	ご注文コード Order code	コーティングの種類 Kind of coating (C)	寸法 Size(mm)				全長 Overall length	シャンク径 Shank dia.
			外径 Tool dia.	刃長 Flute length	首下長 Under neck length	首径 Neck dia.		
			DC	APMX	LU	DN	LF	DCONMS
スクエア Square	EMXA2100-45-(C)	無しNon-coat/PN/SD	10	8	45	9.5	80	10
	EMXA2100-60-(C)	無しNon-coat/PN/SD		8	60	9.5	95	10
	EMXA2120-45-(C)	無しNon-coat/PN/SD	12	10	45	11.5	85	12
	EMXA2120-60-(C)	無しNon-coat/PN/SD		10	60	11.5	100	12
	EMXA2160-45-(C)	無しNon-coat/PN/SD	16	13	45	15.5	90	16
	EMXA2160-60-(C)	無しNon-coat/PN/SD		13	60	15.5	105	16
	EMXA2160-75-(C)	無しNon-coat/PN/SD		13	75	15.5	120	16
	EMXA2200-45-(C)	無しNon-coat/PN/SD	20	16	45	19.5	90	20
	EMXA2200-60-(C)	無しNon-coat/PN/SD		16	60	19.5	105	20
	EMXA2200-80-(C)	無しNon-coat/PN/SD		16	80	19.5	125	20
	EMXA2200-100-(C)	無しNon-coat/PN/SD		16	100	19.5	145	20
	EMXA2250-45-(C)	無しNon-coat/PN/SD	25	20	45	24.5	95	25
	EMXA2250-60-(C)	無しNon-coat/PN/SD		20	60	24.5	110	25
	EMXA2250-80-(C)	無しNon-coat/PN/SD		20	80	24.5	130	25
	EMXA2250-100-(C)	無しNon-coat/PN/SD		20	100	24.5	150	25

3枚刃タイプ 3Flutes type

首下長さ、コーティングをご指定ください。
Please specify the desired under neck length and coating.

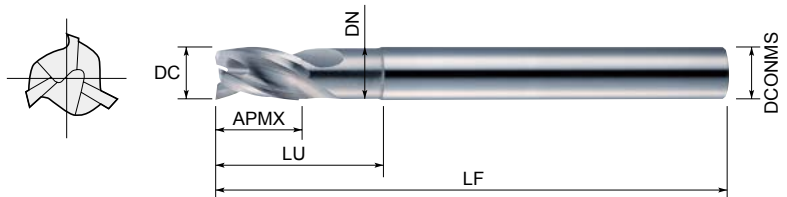

EMXA3○○○-(A)-(C)



タイプ Type	ご注文コード Order code	コーティングの種類 Kind of coating (C)	寸法 Size(mm)				全長 Overall length	シャンク径 Shank dia.
			外径 Tool dia.	刃長 Flute length	首下長 Under neck length (A)	首径 Neck dia.		
			DC	APMX	LU	DN	LF	DCONMS
スクエア Square	EMXA3030-(A)-(C)	無しNon-coat/PN/SD	3	4.5	8DC以下の長さをご指定下さい Please specify a length of 8Dc or less.	2.9	60	6
	EMXA3040-(A)-(C)	無しNon-coat/PN/SD	4	6		3.75	60	6
	EMXA3050-(A)-(C)	無しNon-coat/PN/SD	5	7.5		4.75	80	6
	EMXA3060-(A)-(C)	無しNon-coat/PN/SD	6	9		5.75	80	6
	EMXA3080-(A)-(C)	無しNon-coat/PN/SD	8	12	5DC以下の長さをご指定下さい Please specify a length of 5Dc or less.	7.5	90	8
	EMXA3100-(A)-(C)	無しNon-coat/PN/SD	10	15		9.5	100	10
	EMXA3120-(A)-(C)	無しNon-coat/PN/SD	12	18		11.5	120	12
	EMXA3160-45-(C)	無しNon-coat/PN/SD	16	19	45	15.5	90	16
	EMXA3160-75-(C)	無しNon-coat/PN/SD		19	75	15.5	120	16

Epoch Mirus Type A for Aluminium

エポックミルス タイプA (アルミ用)

参考切削条件表 Reference cutting conditions

超硬合金ミル
スクエアエンドミル

<側面切削> Side milling **2枚刃タイプ 2Flutes type**

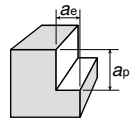

被削材 Work material			アルミ合金(A7075等) Aluminum alloys				アルミ合金鋳物(AC4A等) Cast Aluminum alloys				銅・銅合金(C1100等) Copper, Copper alloys				樹脂等 Resin etc.			
外径DC Tool dia. (mm)	首下長 Under neck length (mm)	切込み Depth of cut ap, ae (mm)	高速条件 High speed		汎用条件 General		高速条件 High speed		汎用条件 General		高速条件 High speed		汎用条件 General		高速条件 High speed		汎用条件 General	
			回転数 min ⁻¹	送り mm/min	回転数 min ⁻¹	送り mm/min	回転数 min ⁻¹	送り mm/min	回転数 min ⁻¹	送り mm/min	回転数 min ⁻¹	送り mm/min	回転数 min ⁻¹	送り mm/min	回転数 min ⁻¹	送り mm/min	回転数 min ⁻¹	送り mm/min
10	45	ap≤0.5DC ae≤0.8DC	22,000	3,300	6,000	1,600	18,500	2,300	5,100	1,200	10,000	1,500	3,500	750	10,120	1,650	3,500	800
	60		20,000	3,000	5,500	1,500	17,000	2,100	4,700	1,000	9,200	1,400	3,200	700	9,200	1,500	3,200	750
12	45		24,000	6,600	7,700	2,200	21,000	4,600	6,500	1,500	11,000	3,000	3,500	1,000	11,040	3,300	3,500	1,100
	60		22,000	6,000	7,000	2,000	18,500	4,200	5,800	1,400	10,000	2,700	3,200	920	10,120	3,000	3,200	1,000
16	45		29,000	7,200	11,000	2,400	24,500	5,000	9,200	1,700	13,000	3,300	5,000	1,100	13,340	3,600	5,000	1,200
	60		26,000	6,600	9,900	2,200	22,000	4,600	8,300	1,500	12,000	3,000	4,500	1,000	11,960	3,300	4,500	1,100
20	75		24,000	6,000	9,000	2,000	20,000	4,200	7,500	1,400	11,000	2,700	4,100	900	11,040	3,000	4,100	1,000
	45		30,000	8,000	9,300	1,300	25,000	5,600	7,800	900	14,000	3,700	4,300	600	13,800	4,000	4,300	650
	60		27,000	7,300	8,500	1,200	23,000	5,100	7,100	850	12,500	3,300	3,900	550	12,420	3,650	3,900	600
	80		24,000	6,600	7,700	1,100	20,000	4,600	6,500	750	11,000	3,000	3,500	500	11,040	3,300	3,500	550
25	100		22,000	6,000	7,000	1,000	18,500	4,200	5,800	700	10,000	2,700	3,200	450	10,120	3,000	3,200	500
	45		24,000	8,000	11,000	1,300	20,000	5,600	9,200	900	11,000	3,700	5,000	600	11,040	4,000	5,000	650
	60	22,000	7,300	10,000	1,200	18,500	5,100	8,400	850	10,000	3,300	4,600	550	10,120	3,650	4,600	600	
	80	20,000	6,600	8,800	1,100	16,800	4,600	7,400	750	9,200	3,000	4,000	500	9,200	3,300	4,000	550	
100	18,000	6,000	8,000	1,000	15,000	4,200	6,700	700	8,300	2,700	3,700	460	8,280	3,000	3,700	500		

<側面切削> Side milling **3枚刃タイプ 3Flutes type**

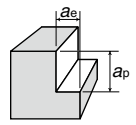

被削材 Work material			アルミ合金(A7075等) Aluminum alloys				アルミ合金鋳物(AC4A等) Cast Aluminum alloys				銅・銅合金(C1100等) Copper, Copper alloys				樹脂等 Resin etc.			
外径DC Tool dia. (mm)	首下長 Under neck length (mm)	切込み Depth of cut ap, ae (mm)	高速条件 High speed		汎用条件 General		高速条件 High speed		汎用条件 General		高速条件 High speed		汎用条件 General		高速条件 High speed		汎用条件 General	
			回転数 min ⁻¹	送り mm/min	回転数 min ⁻¹	送り mm/min	回転数 min ⁻¹	送り mm/min	回転数 min ⁻¹	送り mm/min	回転数 min ⁻¹	送り mm/min	回転数 min ⁻¹	送り mm/min	回転数 min ⁻¹	送り mm/min	回転数 min ⁻¹	送り mm/min
3	3DC以下	ap≤1.0DC ae≤0.2DC	26,000	9,000	20,800	4,500	21,000	6,000	16,800	3,000	21,000	4,000	16,800	2,000	21,000	4,400	16,800	2,200
	3DC~5DC		19,500	6,300	15,600	3,150	15,500	4,200	12,400	2,100	15,500	2,800	12,400	1,400	15,500	3,100	12,400	1,550
	5DC~8DC		14,000	3,000	11,200	1,500	12,000	2,940	9,600	1,500	12,000	2,100	9,600	1,100	12,000	2,300	9,600	1,150
4	3DC以下		24,000	8,100	19,200	4,050	19,000	6,000	15,200	3,000	18,000	4,050	14,400	2,050	18,000	4,450	14,400	2,250
	3DC~5DC		18,000	5,700	14,400	2,850	14,250	4,200	11,400	2,100	13,500	2,800	10,800	1,400	13,500	3,100	10,800	1,550
	5DC~8DC		13,500	3,900	10,800	1,950	10,500	2,940	8,400	1,500	10,125	2,100	8,100	1,100	10,125	2,300	8,100	1,150
5	3DC以下		20,000	8,500	16,000	4,250	16,000	6,000	12,800	3,000	15,000	4,200	12,000	2,100	15,000	4,600	12,000	2,300
	3DC~5DC		15,000	6,000	12,000	3,000	12,000	4,200	9,600	2,100	11,250	2,950	9,000	1,500	11,250	3,250	9,000	1,650
	5DC~8DC		11,250	4,200	9,000	2,100	9,000	2,940	7,200	1,500	8,438	2,100	6,750	1,100	8,438	2,300	6,750	1,150
6	3DC以下		20,000	9,000	16,000	4,500	13,000	6,000	10,400	3,000	12,000	4,500	9,600	2,250	12,000	4,950	9,600	2,500
	3DC~5DC		15,000	6,300	12,000	3,150	9,750	4,200	7,800	2,100	9,000	3,150	7,200	1,600	9,000	3,450	7,200	1,750
	5DC~8DC		11,250	4,400	9,000	2,200	7,300	3,000	5,850	1,500	6,750	2,200	5,400	1,100	6,750	2,400	5,400	1,200
8	3DC以下	18,000	9,000	14,400	4,500	10,000	4,300	8,000	2,150	9,600	3,800	7,700	1,900	9,600	4,200	7,680	2,100	
	3DC~5DC	13,500	6,300	10,800	3,150	7,500	3,100	6,000	1,550	7,200	2,650	5,750	1,350	7,200	2,900	5,760	1,450	
	5DC~8DC	10,125	4,400	8,100	2,200	5,650	2,300	4,500	1,150	5,400	1,850	4,350	950	5,400	2,000	4,320	1,000	
10	3DC以下	17,000	9,000	13,600	4,500	10,000	4,300	8,000	2,150	9,600	3,800	7,700	1,900	9,600	4,200	7,680	2,100	
	3DC~5DC	12,750	6,300	10,200	3,150	7,500	3,100	6,000	1,550	7,200	2,650	5,750	1,350	7,200	2,900	5,760	1,450	
	5DC~8DC	9,550	4,400	7,640	2,200	5,650	2,300	4,500	1,150	5,400	1,850	4,350	950	5,400	2,000	4,320	1,000	
12	3DC以下	17,000	9,000	13,600	4,500	10,000	4,300	8,000	2,150	9,600	3,800	7,700	1,900	9,600	4,200	7,680	2,100	
	3DC~5DC	12,750	6,300	10,200	3,150	7,500	3,100	6,000	1,550	7,200	2,650	5,750	1,350	7,200	2,900	5,760	1,450	
	5DC~8DC	9,550	4,400	7,650	2,200	5,650	2,300	4,500	1,150	5,400	1,850	4,350	950	5,400	2,050	4,320	1,050	
16	3DC以下	17,000	9,000	13,600	4,500	10,000	4,300	8,000	2,150	9,600	3,800	7,700	1,900	9,600	4,200	7,680	2,100	
	3DC~5DC	12,750	6,300	10,200	3,150	7,500	3,100	6,000	1,550	7,200	2,650	5,750	1,350	7,200	2,900	5,760	1,450	
	5DC~8DC	9,550	4,400	7,650	2,200	5,625	2,300	4,500	1,150	5,400	1,850	4,350	950	5,400	2,050	4,320	1,050	

- 【注意】**
- ①被削材、加工形状に合わせて、適切なクーラントを使用してください。
 - ②この切削条件表は切削条件の目安を示すものです。実際の加工では加工形状、目的、使用機械等により条件を調整してください。
 - ③切込み量apは目安です。機械剛性、ワーク剛性により調節してください。apを小さくすれば送りはさらに上がります。
 - ④水溶性切削液のご使用を推奨いたします。
 - ⑤機械の回転数が足りない場合は、回転数と送り速度を同じ比率で下げてください。

- 【Note】**
- ①Use the appropriate coolant for the work material and machining shape.
 - ②These conditions are for general guidance; in actual machining conditions adjust the parameters according to your actual machine and work-piece conditions.
 - ③The recommended ap (depth of cut) is a general recommend. Please adjust basing on your machine and work piece rigidity. If ap is reduced, higher feed should be possible.
 - ④Please apply water base coolant, when using EMXA series.
 - ⑤If the machine rotation speed is insufficient, reduce the rotation speed and feed rate by the same ratio.

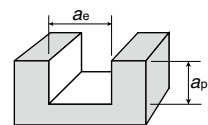

<溝切削> Slotting

2枚刃タイプ 2Flutes type



被削材 Work material			アルミ合金(A7075等) Aluminum alloys				アルミ合金鋳物(AC4A等) Cast Aluminum alloys				銅・銅合金(C1100等) Copper, Copper alloys				樹脂等 Resin etc.			
外径DC Tool dia. (mm)	首下長 Under neck length (mm)	切込み Depth of cut ap, ae (mm)	高速条件 High speed		汎用条件 General		高速条件 High speed		汎用条件 General		高速条件 High speed		汎用条件 General		高速条件 High speed		汎用条件 General	
			回転数 min ⁻¹	送り mm/min	回転数 min ⁻¹	送り mm/min	回転数 min ⁻¹	送り mm/min	回転数 min ⁻¹	送り mm/min	回転数 min ⁻¹	送り mm/min	回転数 min ⁻¹	送り mm/min	回転数 min ⁻¹	送り mm/min	回転数 min ⁻¹	送り mm/min
10	45	ap≤0.5DC ae≤1.0DC	22,000	2,640	6,000	1,280	18,500	1,840	5,100	960	10,000	1,200	3,500	600	10,120	1,320	3,500	640
	60		20,000	2,400	5,500	1,200	17,000	1,680	4,700	800	9,200	1,120	3,200	560	9,200	1,200	3,200	600
12	45		24,000	5,280	7,700	1,760	21,000	3,680	6,500	1,200	11,000	2,400	3,500	800	11,040	2,640	3,500	880
	60		22,000	4,800	7,000	1,600	18,500	3,360	5,800	1,120	10,000	2,160	3,200	736	10,120	2,400	3,200	800
16	45		29,000	5,760	11,000	1,920	24,500	4,000	9,200	1,360	13,000	2,640	5,000	880	13,340	2,880	5,000	960
	60		26,000	5,280	9,900	1,760	22,000	3,680	8,300	1,200	12,000	2,400	4,500	800	11,960	2,640	4,500	880
	75		24,000	4,800	9,000	1,600	20,000	3,360	7,500	1,120	11,000	2,160	4,100	720	11,040	2,400	4,100	800
20	45		30,000	6,400	9,300	1,040	25,000	4,480	7,800	720	14,000	2,960	4,300	480	13,800	3,200	4,300	520
	60		27,000	5,840	8,500	960	23,000	4,080	7,100	680	12,500	2,640	3,900	440	12,420	2,920	3,900	480
	80		24,000	5,280	7,700	880	20,000	3,680	6,500	600	11,000	2,400	3,500	400	11,040	2,640	3,500	440
	100		22,000	4,800	7,000	800	18,500	3,360	5,800	560	10,000	2,160	3,200	360	10,120	2,400	3,200	400
25	45		24,000	6,400	11,000	1,040	20,000	4,480	9,200	720	11,000	2,960	5,000	480	11,040	3,200	5,000	520
	60		22,000	5,840	10,000	960	18,500	4,080	8,400	680	10,000	2,640	4,600	440	10,120	2,920	4,600	480
	80		20,000	5,280	8,800	880	16,800	3,680	7,400	600	9,200	2,400	4,000	400	9,200	2,640	4,000	440
	100		18,000	4,800	8,000	800	15,000	3,360	6,700	560	8,300	2,160	3,700	370	8,280	2,400	3,700	400

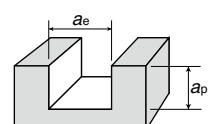

<溝切削> Slotting

3枚刃タイプ 3Flutes type



被削材 Work material			アルミ合金(A7075等) Aluminum alloys				アルミ合金鋳物(AC4A等) Cast Aluminum alloys				銅・銅合金(C1100等) Copper, Copper alloys				樹脂等 Resin etc.			
外径DC Tool dia. (mm)	首下長 Under neck length (mm)	切込み Depth of cut ap, ae (mm)	高速条件 High speed		汎用条件 General		高速条件 High speed		汎用条件 General		高速条件 High speed		汎用条件 General		高速条件 High speed		汎用条件 General	
			回転数 min ⁻¹	送り mm/min	回転数 min ⁻¹	送り mm/min	回転数 min ⁻¹	送り mm/min	回転数 min ⁻¹	送り mm/min	回転数 min ⁻¹	送り mm/min	回転数 min ⁻¹	送り mm/min	回転数 min ⁻¹	送り mm/min	回転数 min ⁻¹	送り mm/min
3	3DC以下	ap≤0.5DC ae=1.0DC	20,000	3,000	16,000	1,800	17,000	2,200	13,600	1,350	16,000	2,000	8,000	1,000	16,000	2,200	8,000	1,100
	3DC~5DC		15,000	2,300	12,000	1,350	12,750	1,700	10,200	1,050	12,000	1,500	6,000	750	12,000	1,650	6,000	850
	5DC~8DC		11,250	1,700	9,000	1,050	9,500	1,200	7,600	750	9,000	1,125	4,500	550	9,000	1,250	4,500	650
4	3DC以下		19,000	3,300	15,200	2,000	16,000	2,250	12,800	1,350	15,000	2,050	7,500	1,050	15,000	2,250	7,500	1,150
	3DC~5DC		14,250	2,400	11,400	1,450	12,000	1,700	9,600	1,050	11,250	1,500	5,650	750	11,250	1,650	5,650	850
	5DC~8DC		10,700	1,900	8,650	1,150	9,000	1,300	7,200	750	8,450	1,150	4,250	550	8,450	1,250	4,250	650
5	3DC以下		16,000	3,400	12,800	2,050	14,000	2,400	11,200	1,450	13,500	2,050	6,750	1,025	13,500	2,250	6,750	1,150
	3DC~5DC		12,000	2,500	9,600	1,500	10,500	1,800	8,400	1,050	10,125	1,500	5,050	750	10,125	1,650	5,050	850
	5DC~8DC		9,000	2,000	7,200	1,200	7,850	1,300	6,280	750	7,600	1,150	3,800	550	7,600	1,250	3,800	650
6	3DC以下		13,000	3,600	10,400	2,150	11,000	2,550	8,800	1,550	10,500	2,000	5,250	1,000	10,500	2,200	5,250	1,100
	3DC~5DC		9,750	2,700	7,800	1,600	8,250	1,900	6,600	1,150	7,900	1,500	3,950	750	7,900	1,650	3,950	850
	5DC~8DC		7,300	2,000	5,840	1,200	6,200	1,400	4,960	850	5,950	1,150	3,000	550	5,950	1,250	3,000	650
8	3DC以下		9,500	3,900	7,600	2,350	8,000	2,700	6,400	1,650	7,500	2,250	3,750	1,150	7,500	2,500	3,750	1,250
	3DC~5DC		7,150	3,000	5,700	1,800	6,000	2,000	4,800	1,200	5,650	1,700	2,850	850	5,650	1,900	2,850	950
	5DC~8DC		5,350	2,200	4,250	1,350	4,500	1,500	3,600	900	4,250	1,250	2,150	650	4,250	1,400	2,150	700
10	3DC以下		7,600	3,900	6,050	2,350	6,400	2,700	5,150	1,650	6,000	2,250	3,000	1,150	6,000	2,500	3,000	1,250
	3DC~5DC	5,700	3,000	4,550	1,800	4,800	2,000	3,850	1,200	4,500	1,700	2,250	850	4,500	1,900	2,250	950	
	5DC~8DC	4,250	2,200	3,400	1,350	3,600	1,500	2,850	900	3,400	1,250	1,700	650	3,400	1,400	1,700	700	
12	3DC以下	7,600	3,900	6,050	2,350	6,400	2,700	5,150	1,650	6,000	2,250	3,000	1,150	6,000	2,500	3,000	1,250	
	3DC~5DC	5,700	3,000	4,550	1,800	4,800	2,000	3,850	1,200	4,500	1,700	2,250	850	4,500	1,900	2,250	950	
	5DC~8DC	4,250	2,200	3,400	1,350	3,600	1,500	2,850	900	3,400	1,250	1,700	650	3,400	1,400	1,700	700	
16	3DC以下	7,600	3,900	6,050	2,350	6,400	2,700	5,150	1,650	6,000	2,250	3,000	1,150	6,000	2,500	3,000	1,250	
	3DC~5DC	5,700	3,000	4,550	1,800	4,800	2,000	3,850	1,200	4,500	1,700	2,250	850	4,500	1,900	2,250	950	
	5DC~8DC	4,250	2,200	3,400	1,350	3,600	1,500	2,850	900	3,400	1,250	1,700	650	3,400	1,400	1,700	700	

[注意] ①この切削条件表は切削条件の目安を示すものです。実際の加工では加工形状、目的、使用機械等により条件を調整してください。
 ②切込み量apは目安です。機械剛性、ワーク剛性により調節してください。apを小さくすれば送りはさらに上がります。
 ③水溶性切削液のご使用を推奨いたします。
 ④機械の回転数が足りない場合は、回転数と送り速度を同じ比率で下げてください。

[Note] ①These conditions are for general guidance; in actual machining conditions adjust the parameters according to your actual machine and work-piece conditions.
 ②The recommended ap (depth of cut) is a general recommend. Please adjust basing on your machine and work piece rigidity. If ap is reduced, higher feed should be possible.
 ③Please apply water base coolant, when using EMXA series.
 ④If the machine rotation speed is insufficient, reduce the rotation speed and feed rage by the same ratio.

Epoch SD(S-DLC) Deep Square

エポック SD(S-DLC) ディープスクエア

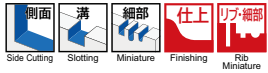

高い耐溶着性、アルミ合金・銅の加工に適しています。DLCコーティング。
High welding resistance makes it ideal for machining aluminum alloys and copper.
DLC Coating.

外径公差
DC ≤ 0.5 : 0 ~ -0.007
0.5 < DC < 1 : 0 ~ -0.010
1 ≤ DC : 0 ~ -0.015

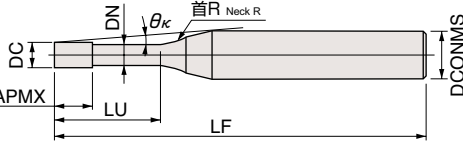

EPDS2000-SD

商品コード Item code	在庫 Stock	寸法 Size (mm)							干渉角度 Interference angle (°) θκ	勾配角に対する実有効首下長 Effective under neck length with respect to draft angle					希望小売 価格(円) Suggested retail price (¥)
		外径 Tool dia. DC	首下長 Under neck length LU	刃長 Flute length APMX	首径 Neck dia. DN	全長 Overall length LF	シャンク径 Shank dia. DCONMS	首R Neck R		0.5°	1°	1.5°	2°	3°	
EPDS2005-2-SD	●	0.5	2	0.75	0.47	50	4	10	9.64	2.89	3.18	3.44	3.69	4.14	7,920
EPDS2005-4-SD	●		4	0.75	0.47	50	4	10	8.1	5.08	5.48	5.82	6.12	6.67	7,920
EPDS2005-6-SD	●		6	0.75	0.47	50	4	10	6.98	7.27	7.72	8.12	8.47	9.09	7,920
EPDS2006-2-SD	●	0.6	2	0.9	0.57	50	4	10	9.59	2.89	3.18	3.44	3.69	4.14	7,920
EPDS2006-4-SD	●		4	0.9	0.57	50	4	10	8.02	5.08	5.48	5.82	6.12	6.67	7,920
EPDS2006-6-SD	●		6	0.9	0.57	50	4	10	6.9	7.24	7.72	8.12	8.47	9.09	7,920
EPDS2008-4-SD	●	0.8	4	1.2	0.77	50	4	10	7.86	5.08	5.48	5.82	6.12	6.67	7,920
EPDS2008-6-SD	●		6	1.2	0.77	50	4	10	6.72	7.24	7.72	8.12	8.47	9.09	7,920
EPDS2008-8-SD	●		8	1.2	0.77	50	4	10	5.86	9.38	9.93	10.37	10.76	11.45	7,920
EPDS2010-4-SD	●	1	4	1.5	0.96	50	4	10	7.67	5.13	5.52	5.85	6.15	6.69	7,920
EPDS2010-8-SD	●		8	1.5	0.96	50	4	10	5.66	9.42	9.95	10.4	10.78	11.46	7,920
EPDS2010-12-SD	●		12	1.5	0.96	55	4	10	4.48	13.66	14.3	14.82	15.28	16.06	7,920
EPDS2015-6-SD	●	1.5	6	2.25	1.44	50	4	10	5.94	7.37	7.81	8.19	8.54	9.15	7,920
EPDS2015-12-SD	●		12	2.25	1.44	55	4	10	3.97	13.72	14.35	14.86	15.31	16.11	7,920
EPDS2015-18-SD	●		18	2.25	1.44	60	4	10	2.98	20.01	20.77	21.38	21.9	干渉なし	7,920
EPDS2020-8-SD	●	2	8	3	1.92	50	4	10	4.44	9.56	10.06	10.48	10.86	11.53	7,920
EPDS2020-16-SD	●		16	3	1.92	55	4	10	2.75	17.97	18.68	19.25	19.75	干渉なし	7,920
EPDS2020-24-SD	●		24	3	1.92	60	4	10	1.99	26.3	27.16	27.84	干渉なし	干渉なし	7,920
EPDS2030-12-SD	●	3	12	4.5	2.88	60	6	10	4.44	13.89	14.48	14.97	15.4	16.3	11,150
EPDS2030-24-SD	●		24	4.5	2.88	65	6	10	2.75	26.39	27.22	27.89	29.05	干渉なし	11,150
EPDS2030-36-SD	●		36	4.5	2.88	80	6	10	1.99	38.79	39.81	41.38	干渉なし	干渉なし	14,890
EPDS2040-16-SD	●	4	16	6	3.85	60	6	10	2.72	18.14	18.81	19.36	19.84	干渉なし	11,900
EPDS2040-32-SD	●		32	6	3.85	80	6	10	1.55	34.72	35.66	36.89	干渉なし	干渉なし	11,900
EPDS2040-48-SD	●		48	6	3.85	90	6	10	1.08	51.18	52.67	干渉なし	干渉なし	干渉なし	15,430

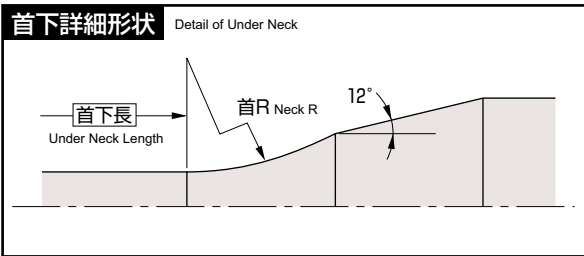

【注意】

加工物に勾配がついている場合、干渉領域は、首下長さよりも長くなります。それぞれの勾配角に対する実有効首下長をご参照ください。
また、工具が加工物に干渉する角度を干渉角度θκで表示していますので合わせてご参照ください。

【Note】

If the workpiece has draft angle, the interference length will be longer than the under-neck length. Please refer to the effective under-neck length for the various draft angles.
In addition, the angle at which the tool will interfere with the workpiece is shown as the "interference angle θκ", and should also be referred to.

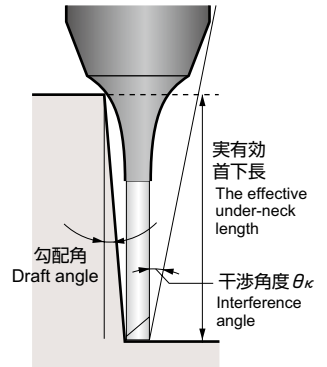

○ 対応被削材 Applicable work material

炭素鋼 合金鋼 Carbon steel Alloy steel	プリハードン ド鋼 Pre-hardened steel	高硬度 Hardened steel			ステン レス鋼 Stainless steel	チタン合金 耐熱合金 Titanium alloy Heat-resistant alloy	銅合金 Copper alloy	アルミ 合金 Aluminum alloy
	≤ 45HRC	> 45HRC ≤ 55HRC	> 55HRC ≤ 65HRC	> 65HRC			◎	◎

○ 再研磨対応外径範囲 Re-grinding compatibility range

商品コード Item code	外周 Outer dia. (mm)	エンド End (mm)
EPDS-SD	× (N/A)	2 ~ 4

【注意】首下長/外径が10DCを超える工具の再研磨可否については、弊社営業にお問い合わせください。
【Note】Contact our sales office regarding whether or not re-grinding is possible for tools where under neck length/tool diameter more than 10DC.

● : 標準在庫品です。 ● : Stocked items. 干渉なし : No interference

標準切削条件表 Recommended cutting conditions

EPDS-SD

＜溝切削＞ Slotting

被削材 Work material				1		2		3		4	
				アルミニウム合金展伸材 A5052,A7075等, etc. Expanded aluminum alloy materials		アルミニウム合金鋳物 ダイキャスト Si 10%未満 Cast aluminum alloy materials Die-casting, Si less than 10%		銅合金 C1100等, etc. Pure coppers		樹脂 アクリル等 Resin, Acrylic, etc.	
商品コード Item code	外径DC Tool dia. (mm)	首下長LU Under neck Length (mm)	軸方向切り込み量 Axial direction cutting depth (mm)	回転数 n min ⁻¹	送り速度 v_f mm/min	回転数 n min ⁻¹	送り速度 v_f mm/min	回転数 n min ⁻¹	送り速度 v_f mm/min	回転数 n min ⁻¹	送り速度 v_f mm/min
EPDS2005-2-SD	0.5	2	0.15	50,000	1,180	50,000	1,150	38,400	850	38,400	1,280
EPDS2005-4-SD		4	0.09	50,000	1,080	46,660	980	34,560	700	34,560	1,050
EPDS2005-6-SD		6	0.06	46,080	860	41,470	760	30,720	540	30,720	810
EPDS2006-2-SD	0.6	2	0.18	50,000	1,680	50,000	1,535	38,400	1,210	38,400	1,820
EPDS2006-4-SD		4	0.11	50,000	1,535	46,660	1,390	34,560	995	34,560	1,490
EPDS2006-6-SD		6	0.06	50,000	1,535	46,660	1,390	34,560	995	34,560	1,490
EPDS2008-4-SD	0.8	4	0.24	50,000	1,680	50,000	1,535	38,400	1,210	38,400	1,820
EPDS2008-6-SD		6	0.14	50,000	1,535	46,660	1,390	34,560	995	34,560	1,490
EPDS2008-8-SD		8	0.09	50,000	1,535	46,660	1,390	34,560	995	34,560	1,490
EPDS2010-4-SD	1	4	0.3	50,000	2,500	46,660	2,280	34,560	1,628	34,560	2,440
EPDS2010-8-SD		8	0.17	46,650	2,140	41,990	1,880	31,100	1,340	31,100	2,010
EPDS2010-12-SD		12	0.11	41,480	1,670	37,330	1,460	27,650	1,045	27,650	1,570
EPDS2015-6-SD	1.5	6	0.45	40,320	2,030	36,290	1,780	26,880	1,270	26,880	1,910
EPDS2015-12-SD		12	0.25	36,290	1,670	32,660	1,460	24,190	1,045	24,190	1,570
EPDS2015-18-SD		18	0.16	32,250	1,300	29,030	1,130	21,500	810	21,500	1,220
EPDS2020-8-SD	2	8	0.6	30,240	2,030	27,220	1,780	20,160	1,270	20,160	1,910
EPDS2020-16-SD		16	0.35	27,150	1,670	24,440	1,460	18,100	1,045	18,100	1,570
EPDS2020-24-SD		24	0.21	24,200	1,300	21,780	1,130	16,130	810	16,130	1,220
EPDS2030-12-SD	3	12	0.9	23,040	1,940	20,740	1,690	15,360	1,210	15,360	1,820
EPDS2030-24-SD		24	0.36	20,730	1,600	18,660	1,390	13,820	995	13,820	1,490
EPDS2030-36-SD		36	0.26	18,450	1,400	16,610	1,230	12,300	880	12,300	1,320
EPDS2040-16-SD	4	16	1.2	17,250	3,680	15,530	3,220	11,500	2,300	11,500	2,300
EPDS2040-32-SD		32	0.64	15,530	2,980	13,970	2,600	10,350	1,860	10,350	1,860
EPDS2040-48-SD		48	0.35	13,650	2,640	12,290	2,300	9,100	1,640	9,100	1,640

- 【備考】 ①樹脂の材質によってはエアブローを推奨致します。
 ②この標準切削条件表は切削条件の目安を示したものです。実際の加工形状・使用機械・加工目的により条件を調整してください。
 ③機械の回転数が足りない場合は、回転数と送り速度を同じ比率で下げてください。

- 【Note】 ① An air blower is recommended for some resin materials.
 ② The cutting conditions shown in the table above are reference cutting conditions, and should be adjusted according to the actual shape to be machined, the machine used, and purpose for machining.
 ③ If the machine rotation speed is insufficient, reduce the rotation speed and feed rate by the same ratio.

a_p : 軸方向切り込み (mm)
 DC : 外径 (mm)
 a_p : Axial direction cutting depth (mm)
 DC : Outer diameter (mm)

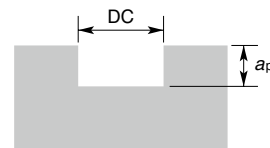

＜側面仕上げ切削＞ Side Finishing

被削材 Work material	1		2	
	アルミニウム合金展伸材 A5052,A7075等, etc. Expanded aluminum alloy materials		樹脂 アクリル等 Resin, Acrylic, etc.	
外径DC Tool dia. (mm)	回転数 n min ⁻¹	送り速度 v_f mm/min	回転数 n min ⁻¹	送り速度 v_f mm/min
0.5	50,000	2,000	50,000	2,000
0.6	48,000	1,920	48,000	1,920
0.8	44,000	2,200	44,000	2,200
1	40,000	2,400	40,000	2,400
1.5	34,000	2,400	34,000	2,400
2	30,000	2,400	30,000	2,400
3	26,000	2,080	26,000	2,080
4	24,000	1,920	24,000	1,920

切り込み Depth of Cut (mm)

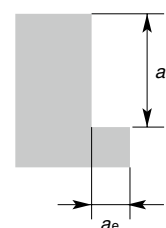

$a_p \leq 1 DC$
 $a_e \leq 0.02mm \sim 0.05mm$

Epoch SD(S-DLC) Square

エポック SD(S-DLC) スクエア



高い耐溶着性、アルミ合金・銅の加工に適しています。DLCコーティング。
High welding resistance makes it ideal for machining aluminum alloys and copper.
DLC Coating.

外径公差 Dia. tolerance
φ3~φ6 : 0~-0.015
φ7~φ12 : 0~-0.02



(mm)

2枚刃
2Flutes



EPAS2-SD

商品コード Item code	在庫 Stock	寸法 Size (mm)				希望小売 価格(円) Suggested retail price(¥)
		外径 Tool dia.	刃長 Flute length	全長 Overall length	シャンク径 Shank dia.	
EPAS2030-SD	●	3	8	60	6	10,940
EPAS2040-SD	●	4	11	60	6	11,470
EPAS2050-SD	●	5	13	60	6	12,800
EPAS2060-SD	●	6	13	70	6	14,030
EPAS2070-SD	●	7	20	70	8	18,410

商品コード Item code	在庫 Stock	寸法 Size (mm)				希望小売 価格(円) Suggested retail price(¥)
		外径 Tool dia.	刃長 Flute length	全長 Overall length	シャンク径 Shank dia.	
EPAS2080-SD	●	8	20	75	8	17,180
EPAS2090-SD	●	9	20	80	10	23,570
EPAS2100-SD	●	10	25	80	10	23,130
EPAS2110-SD	●	11	25	100	12	31,200
EPAS2120-SD	●	12	25	100	12	28,960

標準切削条件表 Recommended cutting conditions

EPAS-SD

<側面切削> Side Milling

被削材 Work material	1		2		3		4	
	回転数 n min ⁻¹	送り速度 vf mm/min	回転数 n min ⁻¹	送り速度 vf mm/min	回転数 n min ⁻¹	送り速度 vf mm/min	回転数 n min ⁻¹	送り速度 vf mm/min
アルミニウム合金展伸材 A5052,A7075等, etc. Expanded aluminum alloy materials								
アルミニウム合金鋳物 AC4A,ADC12等, etc. Cast aluminum alloy materials								
銅合金 C1100等, etc. Pure coppers								
樹脂 アクリル等 Resin, Acrylic, etc.								
外径DC Tool dia. (mm)								
4	24,000	1,800	19,000	1,300	12,000	900	12,000	1,020
6	16,000	2,000	13,000	1,400	8,000	1,000	8,000	1,120
8	12,000	2,000	9,500	1,500	6,000	1,000	6,000	1,120
10	9,500	2,000	7,600	1,500	4,700	1,000	4,700	1,120
12	8,000	2,000	6,400	1,500	4,000	1,000	4,000	1,120

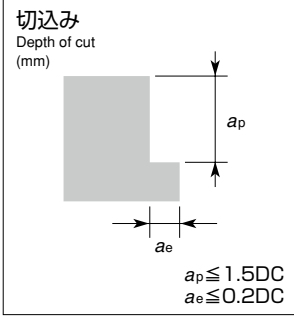

- 【注意】**
- 樹脂の材質によってはエアブローを推奨致します。
 - この標準切削条件表は切削条件の目安を示したものです。実際の加工形状・使用機械・加工目的により条件を調整して下さい。
 - 機械の回転数が足りない場合は、回転数と送り速度を同じ比率で下げてください。

- 【Note】**
- An air blower is recommended for some resin materials.
 - The cutting conditions shown in the table above are reference cutting conditions, and should be adjusted according to the actual shape to be machined, the machine used, and purpose for machining.
 - If the machine rotation speed is insufficient, reduce the rotation speed and feed rate by the same ratio.

<溝切削> Slotting

被削材 Work material	1		2		3		4	
	回転数 n min ⁻¹	送り速度 vf mm/min	回転数 n min ⁻¹	送り速度 vf mm/min	回転数 n min ⁻¹	送り速度 vf mm/min	回転数 n min ⁻¹	送り速度 vf mm/min
アルミニウム合金展伸材 A5052,A7075等, etc. Expanded aluminum alloy materials								
アルミニウム合金鋳物 AC4A,ADC12等, etc. Cast aluminum alloy materials								
銅合金 C1100等, etc. Pure coppers								
樹脂 アクリル等 Resin, Acrylic, etc.								
外径DC Tool dia. (mm)								
4	19,000	1,100	16,000	750	8,750	550	8,750	650
6	13,000	1,200	11,000	850	5,800	530	5,800	580
8	9,500	1,300	8,000	900	4,300	600	4,300	620
10	7,600	1,300	6,400	900	3,500	600	3,500	620
12	6,400	1,300	5,300	900	3,000	610	3,000	660

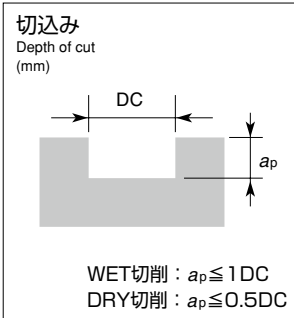

- 【注意】**
- 樹脂の材質によってはエアブローを推奨致します。
 - この標準切削条件表は切削条件の目安を示したものです。実際の加工形状・使用機械・加工目的により条件を調整して下さい。
 - 機械の回転数が足りない場合は、回転数と送り速度を同じ比率で下げてください。

- 【Note】**
- An air blower is recommended for some resin materials.
 - The cutting conditions shown in the table above are reference cutting conditions, and should be adjusted according to the actual shape to be machined, the machine used, and purpose for machining.
 - If the machine rotation speed is insufficient, reduce the rotation speed and feed rate by the same ratio.

対応被削材 Applicable work materia

炭素鋼 合金鋼 Carbon steel Alloy steel	プリハー ド鋼 Pre-hardened steel ≤45HRC	高硬度 Hardened steel			ステン レス鋼 Stainless steel	チタン合金 耐熱合金 Titanium alloy Heat-resistant alloy	銅合金 Copper alloy	アルミ 合金 Aluminum alloy
		> 45HRC ≤ 55HRC	> 55HRC ≤ 65HRC	> 65HRC				

● : 標準在庫品です。● : Stocked items.

再研磨対応外径範囲 Re-grinding compatibility range

商品コード Item code	外周 Outer dia. (mm)	エンド End (mm)
EPAS-SD	6 ~ 12	3 ~ 12

Epoch CFRP End Mill エポックCFRPエンドミル

タイプH Type H

平面 Planing 側面 Side Cutting 溝 Slotting 彫込み Die-sinking ヘルカル Helical スポット面 Spot Facing 荒 Roughing 中仕上げ Semi Finishing 仕上げ Finishing

外径公差 Dia. tolerance 0 ~ -0.025 h5 (mm)

仕上げ用工具 (面粗さ重視) (ハニカム材等)
Finishing tool (priority on surface roughness) (honeycomb materials, etc.)

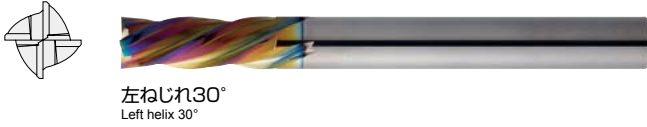

タイプX Type X

平面 Planing 側面 Side Cutting 溝 Slotting 彫込み Die-sinking ヘルカル Helical スポット面 Spot Facing 荒 Roughing 中仕上げ Semi Finishing 仕上げ Finishing

外径公差 Dia. tolerance 0 ~ -0.03 h5 (mm)

厚物材、上下面品位の重視 (ハニカム材等)
Thick materials, priority on upper and lower surface quality (honeycomb materials, etc.)

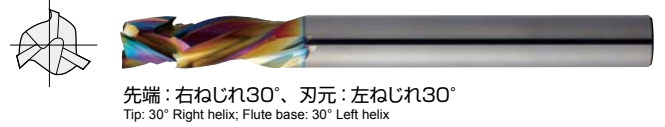

ECH ○○○○ -SD SD 切削条件表 A381 Cutting Conditions

商品コード Item code	在庫 Stock	寸法 Size (mm)					刃数 No. of flutes	希望小売 価格(円) Suggested retail price (¥)
		外径 Tool dia.	刃長 Flute length	全長 Overall length	シャンク径 Shank dia.	切削速度 Cutting speed		
ECH4060-SD	●	6	15	70	6	4	16,390	
ECH4080-SD	●	8	20	75	8	4	18,410	
ECH4100-SD	●	10	25	100	10	4	22,110	
ECH4120-SD	●	12	30	110	12	4	32,430	

ECX ○○○○ -SD SD 切削条件表 A381 Cutting Conditions

商品コード Item code	在庫 Stock	寸法 Size (mm)						刃数 No. of flutes	希望小売 価格(円) Suggested retail price (¥)
		外径 Tool dia.	刃長 Flute length	全長 Overall length	交互点 Switchover point	シャンク径 Shank dia.	切削速度 Cutting speed		
ECX3060-SD	●	6	15	70	6	6	3	18,970	
ECX3080-SD	●	8	20	75	8	8	3	22,110	
ECX3100-SD	●	10	25	100	10	10	3	28,620	
ECX3120-SD	●	12	30	110	12	12	3	38,940	

標準切削条件表 Recommended cutting conditions

ECH-SD Type H

外径 Tool dia. DC	$a_p=1.0DC, a_e=1.0DC$			
	回転数 n min ⁻¹	切削速度 v_c m/min	送り速度 v_f mm/min	1回転送り量 f mm/rev
6	8,000	100 ~ 200	840	0.04 ~ 0.15
8	6,000		840	0.05 ~ 0.17
10	4,800		756	
12	4,000		756	

ECX-SD Type X

外径 Tool dia. DC	$a_p=1.0DC, a_e=1.0DC$			
	回転数 n min ⁻¹	切削速度 v_c m/min	送り速度 v_f mm/min	1回転送り量 f mm/rev
6	8,000	100 ~ 200	600	0.03 ~ 0.12
8	6,000		600	0.04 ~ 0.15
10	4,800		540	
12	4,000		540	

- [注意]** ①この切削条件表は切削条件の目安を示すものです。実際の加工では加工形状、目的、使用機械等により条件を調整してください。
②切込み量 a_p は目安です。機械剛性、ワーク剛性により調節してください。 a_p を小さくすれば送りはさらに上がります。
③機械の回転数が足りない場合は、回転数と送り速度を同じ比率で下げてください。
- [Note]** ① These conditions are for general guidance; in actual machining conditions adjust the parameters according to your actual machine and work-piece conditions.
② The recommended a_p (depth of cut) is a general recommend. Please adjust basing on your machine and work piece rigidity. If a_p is reduced, higher feed should be possible.
③ If the machine rotation speed is insufficient, reduce the rotation speed and feed rage by the same ratio.

ECH-SD、ECX-SDの対応被削材
Applicable work material of ECH-SD, ECX-SD

炭素鋼 合金鋼 Carbon steel Alloy steel	プリハード ド鋼 Pre-hardened steel ≤ 45HRC	高硬度 Hardened steel			ステン レス鋼 Stainless steel	チタン合金 耐熱合金 Titanium alloy Heat-resistant alloy	銅合金 Copper alloy	アルミ 合金 Aluminum alloy
		> 45HRC ≤ 55HRC	> 55HRC ≤ 65HRC	> 65HRC				
CFRP、GFRPなど for CFRP, GFRP etc.								

再研磨対応外径範囲
Re-grinding compatibility range

商品コード Item code	外周 Outer dia. (mm)	エンド End (mm)
ECH-SD	6 ~ 12	6 ~ 12
ECX-SD	6 ~ 12	6 ~ 12

Epoch CFRP Trim Cutter エポックCFRPトリムカッタ

タイプN

Type N



汎用工具(粗～仕上げまでを想定)
General-purpose tools (For roughing to finishing)

タイプW

Type W



高能率工具(送り速度向上)
High-efficiency tools (Improved feed rate)

超硬合金
ステンレス
スチール



底刃2枚刃
End cutting edge
2 flutes



右ねじれ15°
Right helix 15°



底刃2枚刃
End cutting edge
2 flutes



右ねじれ25°、左ねじれ25°
Right helix 25°, Left helix 25°

ECN-○-HD



商品コード Item code	在庫 Stock	寸法 Size (mm)					刃数 No. of flutes	底刃数 No. of bottom flutes
		外径 Tool dia.	刃長 Flute length	全長 Overall length	シャンク径 Shank dia.	底刃数 No. of bottom flutes		
ECN08060-HD	◎	6	18	75	6	8	2	
ECN080635-HD	◎	6.35	18	75	6.35	8	2	
ECN10080-HD	◎	8	24	90	8	10	2	
ECN12100-HD	◎	10	30	100	10	12	2	
ECN12120-HD	◎	12	36	110	12	12	2	

ECW-○-HD



商品コード Item code	在庫 Stock	寸法 Size (mm)					刃数 No. of flutes	底刃数 No. of bottom flutes
		外径 Tool dia.	刃長 Flute length	全長 Overall length	シャンク径 Shank dia.	底刃数 No. of bottom flutes		
ECW09060-HD	◎	6	18	75	6	2	2	
ECW090635-HD	◎	6.35	18	75	6.35	2	2	
ECW11080-HD	◎	8	24	90	8	2	2	
ECW13100-HD	◎	10	30	100	10	2	2	
ECW13120-HD	◎	12	36	110	12	2	2	

標準切削条件表 Recommended cutting conditions

ECN-HD Type N

外径 Tool dia. DC	$a_p=1.0DC, a_e=1.0DC$			
	回転数 n min ⁻¹	切削速度 v_c m/min	送り速度 v_f mm/min	1回転送り量 f mm/rev
6	8,000	100 ~ 200	1,200	0.08 ~ 0.3
6.35	7,500		1,200	
8	6,000	100 ~ 200	1,080	0.1 ~ 0.32
10	4,800		1,080	
12	4,000	800	0.12 ~ 0.36	

ECW-HD Type W

外径 Tool dia. DC	$a_p=1.0DC, a_e=1.0DC$			
	回転数 n min ⁻¹	切削速度 v_c m/min	送り速度 v_f mm/min	1回転送り量 f mm/rev
6	8,000	100 ~ 200	1,600	0.15 ~ 0.5
6.35	7,500		1,600	
8	6,000	100 ~ 200	1,400	0.175 ~ 0.55
10	4,800		1,400	
12	4,000	1,200	0.2 ~ 0.6	

- [注意]** ①この切削条件表は切削条件の目安を示すものです。実際の加工では加工形状、目的、使用機械等により条件を調整してください。
②切込み量 a_p は目安です。機械剛性、ワーク剛性により調節してください。 a_p を小さくすれば送りはさらに上がります。
③機械の回転数が足りない場合は、回転数と送り速度を同じ比率で下げてください。

- [Note]** ①These conditions are for general guidance; in actual machining conditions adjust the parameters according to your actual machine and work-piece conditions.
②The recommended a_p (depth of cut) is a general recommend. Please adjust basing on your machine and work piece rigidity. If a_p is reduced, higher feed should be possible.
③If the machine rotation speed is insufficient, reduce the rotation speed and feed raga by the same ratio.

ECN-HD、ECW-HDの対応被削材

Applicable work material of ECN-HD, ECW-HD

炭素鋼 合金鋼 Carbon steel Alloy steel	炭素鋼 合金鋼 Pre-hardened steel ≤ 45HRC	高硬度 Hardened steel			ステン レス 鋼 Stainless steel	チタン合金 耐熱合金 Titanium alloy Heat-resistant alloy	銅合金 Copper alloy	アルミ 合金 Aluminum alloy
	> 45HRC ≤ 55HRC	> 55HRC ≤ 65HRC	> 65HRC					

CFRP、GFRPなど for CFRP, GFRP etc.

再研磨対応外径範囲

Re-grinding compatibility range

商品コード Item code	外周 Outer dia. (mm)	エンド End (mm)
ECN-HD	× (N/A)	× (N/A)
ECW-HD	× (N/A)	× (N/A)

◎印：メーカー在庫品です。弊社営業へお問い合わせください。 ○印：Manufacturer stocked items. Contact with our sales department.

エポックシャイニングスクエア



外径公差 Dia. tolerance 0 ~ -0.01



切れ味と刃先剛性を両立した刃形状により、鏡面加工が可能。
Flute shape that provides good cutting performance and flute tip rigidity enables mirror-surface cutting.

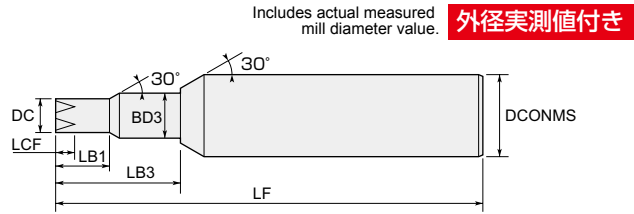

Includes actual measured mill diameter value. **外径実測値付き**

EPCDS

※外径実測値をケースに表示しています
Actual measured mill diameter value is shown on case.

再研磨は当社の営業までお問い合わせ下さい。
Please contact our sales department for regrinding.

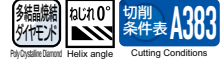

商品コード Item code	在庫 Stock	寸法 Size (mm)							刃数 No. of Flutes	希望小売価格 (円) Suggested retail price (¥)
		外径 Tool dia. DC	溝長 Flute length LCF	有効長 Effective length LB1	首下長 Under neck length LB3	首径 Neck dia. BD3	全長 Overall length LF	シャンク径 Shank dia. DCONMS		
EPCDS4001	●	0.1	0.01	0.1	3	1.3	40	4	75,410	
EPCDS4002	●	0.2	0.02	0.2	3	1.3	40	4	75,410	
EPCDS4003	●	0.3	0.04	0.3	3	1.3	40	4	64,700	
EPCDS6004	●	0.4	0.04	0.4	3	1.3	40	6	64,700	
EPCDS6005	●	0.5	0.05	0.5	3	1.3	40	6	64,700	
EPCDS6006	●	0.6	0.07	0.6	3	1.3	40	6	53,880	
EPCDS6008	●	0.8	0.1	0.8	3	1.3	40	6	53,880	
EPCDS6010	●	1.0	0.1	1.0	3	1.3	40	6	53,880	

標準切削条件表 Recommended cutting conditions EPCDS

被削材 Work material	超硬合金 Cemented carbide		
	外径DC Tool dia. (mm)	回転数 n min^{-1}	送り速度 v_f mm/min
0.1	40,000	10~30	0.0005~0.001
0.2	40,000	10~30	0.0005~0.001
0.3	40,000	10~30	0.0005~0.001
0.4	40,000	20~50	0.0005~0.002
0.5	40,000	20~50	0.0005~0.002
0.6	40,000	20~50	0.0005~0.002
0.8	40,000	20~80	0.0005~0.002
1	40,000	20~80	0.0005~0.002

- 【注意】**
- 加工精度の低下、工具の欠損または折損に繋がるため、工具の回転振れ量を最小に抑えてください。
 - 極めて微細な加工のため、機械の変位量などの機械特性を把握してから加工してください。
 - 機械の回転数が足りない場合は、主軸回転数とテーブル送り速度を同比率で下げてください。
 - 不水溶性切削液または水溶性切削液を推奨します。
 - 切りくずの詰まりを抑制するため切削油剤が工具切れ刃に供給されるようにノズルの位置を調整してください。
 - この切削条件表は切削条件の目安を示すものです。実際の加工では加工形状、機械の剛性またはご使用の目的等、ご使用の状況により、切削条件の調整を行ってください。

- 【Note】**
- Tool rotation runout should be minimized, since it could lead to reduced cutting accuracy or tool chipping or breakage.
 - For extremely detailed cutting, the machinery characteristics such as machinery displacement, etc. should be understood before performing cutting.
 - If the rpm available is lower than that recommended please reduce the feed rate to the same ratio.
 - Non-water-soluble cutting fluid or water-soluble cutting fluid is recommended.
 - To suppress chip clogging, adjust the cutting fluid nozzle so that the cutting fluid is supplied to the tool cutting flutes.
 - These conditions are for general guidance; in actual machining conditions adjust the parameters according to your actual machine and work-piece conditions.

対応被削材 Applicable work material

炭素鋼 合金鋼 Carbon steel Alloy steel	炭素鋼 合金鋼 Pre-hardened steel ≤ 45HRC	高硬度 Hardened steel > 45HRC ≤ 55HRC	> 55HRC ≤ 65HRC	ステン レス鋼 Stainless steel	チタン合金 耐熱合金 Titanium alloy Heat-resistant alloy	銅合金 Copper alloy	アルミ 合金 Aluminum alloy
---	--	---	--------------------	----------------------------------	--	------------------------	--------------------------------

超硬合金用 for Cemented carbide

再研磨対応外径範囲 Re-grinding compatibility range

商品コード Item code	外周 Outer dia. (mm)	エンド End (mm)
EPCDS	× (N/A)	0.1 ~ 1

【注意】首下長/外径が10DCを超える工具の再研磨可否については、弊社営業にお問い合わせください。
【Note】Contact our sales office regarding whether or not regrinding is possible for tools where under neck length/tool diameter more than 10DC.

● : 標準在庫品です。 ● : Stocked items.

エポックマイクロエンドミル

外径公差：右表参照
Tolerance on dia. : Right table

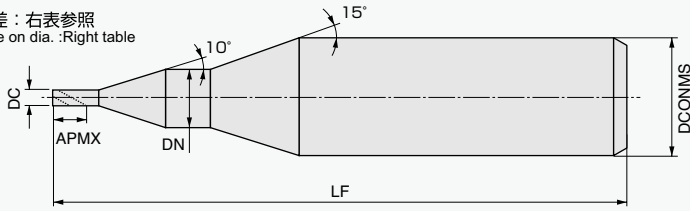

シャンク真円度：0.2 μm以下
Shank Roundness : under 0.2 μm

シャンク円筒度：0.5 μm以下
Shank Cylindrical profile : under 0.5 μm

シャンク公差：0
Tolerance on shank : -0.004

外径 Tool dia.	外径公差 Tolerance on dia.
0.03 ≤ DC ≤ 0.1	±0.002
0.2 ≤ DC	0 -0.007

EMM20000 (-TH) (Total 24 items)

Micro-TH

切削条件表 A384
Cutting Conditions

ノンコーティング Non coating		THコーティング TH Coating		寸法 Size(mm)					希望小売価格(円) Suggested retail price(¥)	
商品コード Item code	在庫 Stock	商品コード Item code	在庫 Stock	外径	刃長	首径	全長	シャンク径	ノンコーティング	THコーティング
				Tool dia. DC	Flute length APMX	Neck dia. DN	Overall length LF	Shank dia. DCONMS	Non coating	TH Coating
EMM20003	●	EMM20003-TH	●	0.03	0.045	0.5	40	4	30,110	33,100
EMM20004	●	EMM20004-TH	●	0.04	0.06	0.5	40	4	25,070	27,540
EMM20005	●	EMM20005-TH	●	0.05	0.075	0.5	40	4	22,610	24,860
EMM20006	●	EMM20006-TH	●	0.06	0.09	0.5	40	4	20,040	22,080
EMM20007		EMM20007-TH		0.07	0.105	0.5	40	4	—	—
EMM20008	●	EMM20008-TH	●	0.08	0.12	0.5	40	4	15,110	16,610
EMM20009		EMM20009-TH		0.09	0.135	0.5	40	4	—	—
EMM20010	●	EMM20010-TH	●	0.1	0.15	0.5	40	4	11,790	12,970
EMM20020	●	EMM20020-TH	●	0.2	0.3	0.625	40	4	7,480	8,240
EMM20030	●	EMM20030-TH	●	0.3	0.45	0.75	40	4	6,430	7,080
EMM20040	●	EMM20040-TH	●	0.4	0.6	0.875	40	4	6,430	7,080
EMM20050	●	EMM20050-TH	●	0.5	0.75	1	40	4	6,040	6,640

標準切削条件表 Recommended cutting conditions

EMM EMM-TH

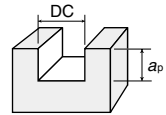

推奨領域 Recommended range	ノンコーティング Non Coating		THコーティング TH Coating			
	1		2		3	
被削材 Work material	アルミ合金、非鉄金属、樹脂等 Aluminum alloys, Non-ferrous, Resins		軟鋼材・ステンレス鋼 Mild steel material, Stainless steels		プリハードン鋼・焼入れ鋼(35HRC~) Pre-hardened steels, Hardened steels	
切込み ap (mm) Depth of cut	ap ≤ 0.1 DC		ap ≤ 0.05 DC		ap ≤ 0.05 DC	
外径 DC Tool dia. (mm)	回転数 n (min ⁻¹)	送り速度 vf (mm/min)	回転数 n (min ⁻¹)	送り速度 vf (mm/min)	回転数 n (min ⁻¹)	送り速度 vf (mm/min)
0.03, 0.04	50,000	380	50,000	190	50,000	130
0.05, 0.06	50,000	520	50,000	260	50,000	170
0.07, 0.08	50,000	660	50,000	330	50,000	220
0.09, 0.1	50,000	800	50,000	400	50,000	270
0.2	50,000	940	50,000	470	50,000	310
0.3	50,000	1,080	50,000	540	50,000	360
0.4	50,000	1,220	50,000	610	50,000	410
0.5	50,000	1,360	50,000	680	50,000	450

- [注意]** ①被削材、加工形状に合わせて、適切なクーラントを使用してください。
②この標準切削条件表は切削条件の目安を示すものです。実際の加工では加工形状、目的、使用機械等により条件を調整してください。
③機械の回転数が足りない場合は、回転数と送り速度を同じ比率で下げてください。
④溝切削でのみご使用ください。側面切削は推奨いたしません。

- [Note]** 1. Use the appropriate coolant for the work material and machining shape.
2. These Recommended Cutting Conditions indicate only the rule of a thumb for the cutting conditions. In actual machining, the condition should be adjusted according to the machining shape, purpose and the machine type.
3. If the rpm of the machine is low, lower the feed rate also to put the rpm and feed rate in the same ratio.
4. Please use slotting only. This is not recommended for side milling.

EMM、EMM-THの対応被削材 Applicable work material of EMM, EMM-TH

商品コード Item code	炭素鋼 合金鋼 Carbon steel Alloy steel	プリハー ド鋼 Pre-hardened steel ≤ 45HRC	高硬度 Hardened steel			ステン レス鋼 Stainless steel	チタン合金 耐熱合金 Titanium alloy Heat-resistant alloy	銅合金 Copper alloy	アルミ 合金 Aluminum alloy
			> 45HRC ≤ 55HRC	> 55HRC ≤ 65HRC	> 65HRC				
EMM	○	○	○	○	○	○	○	○	
EMM-TH	○	○	○	○	○	○	○	○	

再研磨対応外径範囲 Re-grinding compatibility range

商品コード Item code	外周 Outer dia. (mm)	エンド End (mm)
EMM	× (N/A)	× (N/A)
EMM-TH	× (N/A)	× (N/A)

●印：標準在庫品です。 ●：Stocked items. 無印：受注生産品です。 No Mark：Manufactured upon request only.

Epoch Precision Miniature End Mill

エポック精密小径エンドミル

小径精密加工用スクエアエンドミル。
Square end mill for small-diameter high-precision machining.

レギュラーネック Regular neck



外径公差 Dia. tolerance 0~-0.015

刃径公差 Shank tolerance 0~-0.005 (mm)

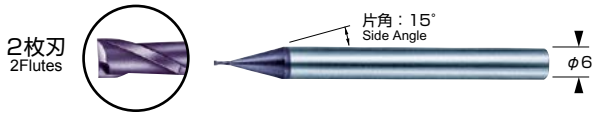

HYPS2-C

超硬 Carbide Helix angle 30° Cutting Conditions A385

商品コード Item code	在庫 Stock	寸法 Size (mm)					希望小売 価格(円) Suggested retail price(¥)
		外径 Tool dia.	刃長 Flute length	首径 Neck dia.	首下長 Under neck length	全長 Overall length	
HYPS2002-C	●	0.2	0.3	—	首ぬすみ	50	9,620
HYPS2003-C	●	0.3	0.4	—	無し	50	8,690
HYPS2004-C	●	0.4	0.5	—	Without neck escape	50	8,690
HYPS2005-C	●	0.5	0.6	0.45	1.6	50	8,240
HYPS2006-C	●	0.6	0.7	0.55	1.7	50	8,240
HYPS2008-C	●	0.8	1	0.75	2.5	50	7,830
HYPS2010-C	●	1	1.3	0.95	3.3	50	6,400
HYPS2012-C	●	1.2	1.5	1.15	3.5	50	7,000
HYPS2014-C	●	1.4	1.8	1.35	3.8	50	7,000
HYPS2015-C	●	1.5	1.9	1.45	4.9	50	6,400
HYPS2016-C	●	1.6	2	1.55	5	50	7,000
HYPS2018-C	●	1.8	2.3	1.75	5.3	50	7,000
HYPS2020-C	●	2	2.5	1.95	5.5	50	6,400
HYPS2025-C	●	2.5	3	2.4	6	50	6,400
HYPS2030-C	●	3	4	2.9	8	50	7,580
HYPS2035-C	●	3.5	4.5	3.4	8.5	50	7,880
HYPS2040-C	●	4	5	3.9	10	50	7,880
HYPS2050-C	●	5	6	4.9	11	50	8,940
HYPS2060-C	●	6	7.5	5.9	12.5	50	9,260

ロングネック Long neck

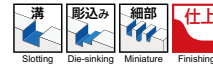

外径公差 Dia. tolerance 0~-0.015

刃径公差 Shank tolerance 0~-0.005 (mm)



HPSLN2-C

超硬 Carbide Helix angle 30° Cutting Conditions A385

商品コード Item code	在庫 Stock	寸法 Size (mm)					希望小売 価格(円) Suggested retail price(¥)
		外径 Tool dia.	刃長 Flute length	首径 Neck dia.	首下長 Under neck length	全長 Overall length	
HPSLN2005-C	●	0.5	0.6	0.45	2.5	60	9,890
HPSLN2006-C	●	0.6	0.7	0.55	3	60	9,890
HPSLN2008-C	●	0.8	1	0.75	4	60	9,390
HPSLN2010-C	●	1	1.3	0.95	5	60	7,690
HPSLN2012-C	●	1.2	1.5	1.15	6	60	8,390
HPSLN2014-C	●	1.4	1.8	1.35	7	60	8,390
HPSLN2015-C	●	1.5	1.9	1.45	7.5	60	7,690
HPSLN2016-C	●	1.6	2	1.55	8	60	8,390
HPSLN2018-C	●	1.8	2.3	1.75	9	60	8,390
HPSLN2020-C	●	2	2.5	1.95	10	60	7,690
HPSLN2025-C	●	2.5	3	2.4	12.5	60	7,690
HPSLN2030-C	●	3	4	2.9	15	80	9,080
HPSLN2035-C	●	3.5	4.5	3.4	17.5	80	9,450
HPSLN2040-C	●	4	5	3.9	20	80	9,450
HPSLN2050-C	●	5	6	4.9	25	80	10,740
HPSLN2060-C	●	6	7.5	5.9	30	80	11,100

標準切削条件表 Recommended cutting conditions

HYPS-C HPSSLN-C

レギュラーネック Regular neck ロングネック Long neck

外径DC Tool dia. (mm)	回転数 (n) Revolution min ⁻¹	送り速度 (v _f) mm/min Table speed V _f	被削材 (50HRC以下) Work material (Under 50HRC)
		スクエア刃 (HYPS) Square end (HYPS)	炭素鋼、合金鋼、工具鋼、プリハードン鋼 Carbon steels, Alloy steels, Tool steels, Pre-hardened steels S50C, SCM, SKD, HPM1, NAK55
0.2	20,000 ~50,000	100~500	切込み Depth of Cut $a_p = (0.1 \sim 0.3) \times DC$
0.4			
0.6			
1.0	10,000 ~30,000	300~800	
2.0			
3.0			
4.0	5,000 ~15,000	400~1,000	
6.0			

使用方法と注意点

- ①被削材、加工形状に合わせて、適切なクーラントを使用してください。
- ②この標準切削条件表は切削条件の目安を示すものです。実際の加工では加工形状、目的、使用機械等により条件を調整してください。
- ③自動切込みが可能な、剛性のあるNC機の利用を推奨します。切込み回数が多いので手動機は適しません。
- ④回転数が不足する場合は適当な増速装置を準備してください。増速装置は長時間耐える機種を推奨します。
- ⑤能率を問わない場合(例、夜間無人加工など)は、2000min⁻¹程度の低速でも使用できます。
- ⑥工具径が小さいため、振れはできるだけ小さく押さえてください。
- ⑦ロングネックタイプをご使用の場合は、切込み量を少なくするか、送り速度を上表の低い数値でご使用ください。

Notes on Applications

- 1) Use the appropriate coolant for the work material and machining shape.
- 2) These Recommended Cutting Conditions indicate only the rule of a thumb for the cutting conditions. In actual machining, the condition should be adjusted according to the machining shape, purpose and the machine type.
- 3) Rigid N/C with automatic depth feeder is recommended. Manual machines are not recommended for multi-feed applications.
- 4) High-revolution spindle attachments are recommended.
- 5) Lower revolutions of about 2,000 r/min are applicable, in case of operation in night without an operator, with efficiency not required.
- 6) Set-up runout of end mills as small as possible, because of miniature end mills.

HYPS-C、HPSSLN-Cの対応被削材

Applicable work material of HYPS-C, HPSSLN-C

炭素鋼 合金鋼 Carbon steel Alloy steel	プリハードン 鋼 Pre-hardened steel	高硬度 Hardened steel			ステン レス鋼 Stainless steel	チタン合金 耐熱合金 Titanium alloy Heat-resistant alloy	銅合金 Copper alloy	アルミ 合金 Aluminum alloy
		> 45HRC ≤ 55HRC	> 55HRC ≤ 65HRC	> 65HRC				
○	○	○	○	○	○	○	○	

再研磨対応外径範囲

Re-grinding compatibility range

商品コード Item code	外周 Outer dia. (mm)	エンド End (mm)
HYPS-C	6	2~6
HPSSLN-C	6	2~6

Carbide End Mills for Aluminium

超硬アルミ用エンドミル



アルミ加工用エンドミル。
End mill for machining of aluminum

外径公差
Dia. tolerance 0 ~ -0.02

h6

(mm)

2枚刃
2Flutes



超硬 Carbide 刃角 45° Helix angle 切削条件表 A386 Cutting Conditions

AES2

商品コード Item code	在庫 Stock	寸法 Size (mm)				希望小売 価格(円) Suggested retail price(¥)
		外径 Tool dia.	刃長 Flute length	全長 Overall length	シャンク径 Shank dia.	
AES2010	●	1	2.5	40	4	6,030
AES2020	●	2	6	40	4	6,030
AES2030	●	3	8	45	6	6,630
AES2040	●	4	11	45	6	7,010
AES2050	●	5	13	50	6	8,060
AES2060	●	6	13	50	6	8,790
AES2070	●	7	20	60	8	10,550
AES2080	●	8	20	60	8	11,790
AES2090	●	9	20	65	10	14,370

商品コード Item code	在庫 Stock	寸法 Size (mm)				希望小売 価格(円) Suggested retail price(¥)
		外径 Tool dia.	刃長 Flute length	全長 Overall length	シャンク径 Shank dia.	
AES2100	●	10	25	70	10	16,390
AES2110	●	11	25	75	12	17,740
AES2120	●	12	25	75	12	19,530
AES2130	●	13	25	75	12	26,170
AES2140	●	14	35	90	12	37,080
AES2150	●	15	35	90	16	38,710
AES2160	●	16	35	90	16	40,130
AES2180	●	18	40	105	16	59,370
AES2200	●	20	40	105	20	68,870

標準切削条件表 Recommended cutting conditions

AES

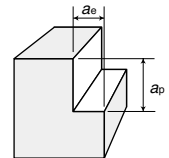

〈側面切削〉 Side milling

被削材 Work material	純アルミニウム Pure aluminums 1070	アルミ合金 Aluminum alloys Cu-Mg系 2014	アルミ合金 Aluminum alloys Si系 4032	アルミ合金 Aluminum alloys Mg系 5052	アルミ合金 Aluminum alloys Mg-Si系 6061	アルミ合金 Aluminum alloys Zn-Mg系 7075	鋳造アルミ Cast Iron aluminums AC8C							
切込み Depth of cut (mm)	ap=1.5DC ae=0.2DC	ap=1.5DC ae=0.2DC	ap=1.5DC ae=0.2DC	ap=1.5DC ae=0.2DC	ap=1.5DC ae=0.2DC	ap=1.5DC ae=0.2DC	ap=1.5DC ae=0.2DC							
外径DC Tool dia.(mm)	回転数n (min ⁻¹)	送り速度vf (mm/min)	回転数n (min ⁻¹)	送り速度vf (mm/min)	回転数n (min ⁻¹)	送り速度vf (mm/min)	回転数n (min ⁻¹)	送り速度vf (mm/min)						
φ2	48,000	800	40,000	800	8,000	200	20,000	400	9,600	250	40,000	400	24,000	500
φ3	32,000	800	27,000	800	5,300	200	13,000	400	6,400	250	27,000	400	16,000	500
φ4	24,000	1,000	20,000	1,000	4,000	250	10,000	500	4,800	300	20,000	500	12,000	600
φ6	16,000	1,000	13,500	1,000	2,650	250	6,500	500	3,200	300	13,500	500	8,000	600
φ8	12,000	1,000	10,000	1,000	2,000	300	5,000	600	2,400	350	10,000	600	6,000	700
φ10	9,600	1,200	8,000	1,200	1,600	300	4,000	600	1,900	350	8,000	600	4,800	700
φ12	8,000	1,200	6,600	1,200	1,300	350	3,300	700	1,600	400	6,600	700	4,000	800

- [注意]** ①被削材、加工形状に合わせて、適切なクーラントを使用してください。
②この標準切削条件表は切削条件の目安を示すものです。実際の加工では加工形状、目的、使用機械等により条件を調整してください。
- [Note]** ① Use the appropriate coolant for the work material and machining shape.
② These Recommended Cutting Conditions indicate only the rule of a thumb for the cutting conditions. In actual machining, the condition should be adjusted according to the machining shape, purpose and the machine type.

対応被削材 Applicable work material

炭素鋼 合金鋼 Carbon steel Alloy steel	プリハー ド鋼 Pre-hardened steel ≤ 45HRC	高硬度 Hardened steel			ステン レス鋼 Stainless steel	チタン合金 耐熱合金 Titanium alloy Heat-resistant alloy	銅合金 Copper alloy	アルミ 合金 Aluminum alloy
		> 45HRC ≤ 55HRC	> 55HRC ≤ 65HRC	> 65HRC				
							○	◎

- 印：標準在庫品です。 □印：特定代理店在庫です。弊社営業へお問合せください。
● : Stocked items. □ : Stocked by specified distributor. Contact with our sales department.

再研磨対応外径範囲 Re-grinding compatibility range

商品コード Item code	外周 Outer dia. (mm)	エンド End (mm)
AES	6 ~ 20	2 ~ 20

C Coating Carbide End Mills

超硬・Cコートエンドミル

レギュラー刃長

Regular



外径公差 Dia. tolerance
 φ0.1~φ6 : 0~-0.02
 φ6.1~φ30 : 0~-0.025



(mm)

2枚刃
2Flutes



HES2-C



商品コード Item code	在庫 Stock	寸法 Size (mm)				希望小売価格 (円) Suggested retail price(¥)
		外径 Tool dia.	刃長 Flute length	全長 Overall length	シャンク径 Shank dia.	
HES2001-C	□	0.1	0.2	38	3	—
HES2002-C	□	0.2	0.4	38	3	—
HES2003-C	□	0.3	1	38	3	—
HES2004-C	□	0.4	1	38	3	—
HES2005-C	□	0.5	1.5	38	3	—
HES2006-C	□	0.6	1.5	38	3	—
HES2007-C	□	0.7	1.5	38	3	—
HES2008-C	□	0.8	2	38	3	—
HES2009-C	□	0.9	2	38	3	—
HES2010-C	●	1	2.5	40	4	6,400
HES2011-C	□	1.1	3	40	4	—
HES2012-C	□	1.2	3	40	4	—
HES2013-C	□	1.3	4	40	4	—
HES2014-C	□	1.4	4	40	4	—
HES2015-C	●	1.5	4	40	4	6,400
HES2016-C	□	1.6	5	40	4	—
HES2017-C	□	1.7	5	40	4	—
HES2018-C	□	1.8	5	40	4	—
HES2019-C	□	1.9	6	40	4	—
HES2020-C	●	2	6	40	4	6,400
HES2021-C	□	2.1	8	40	4	—
HES2022-C	□	2.2	8	40	4	—
HES2023-C	□	2.3	8	40	4	—
HES2024-C	□	2.4	8	40	4	—
HES2025-C	●	2.5	8	40	4	6,400
HES2026-C	□	2.6	10	45	6	—
HES2027-C	□	2.7	10	45	6	—
HES2028-C	□	2.8	10	45	6	—
HES2029-C	□	2.9	10	45	6	—
HES2030-C	●	3	10	45	6	7,580
HES2031-C	□	3.1	11	45	6	—
HES2032-C	□	3.2	11	45	6	—
HES2033-C	□	3.3	11	45	6	—
HES2034-C	□	3.4	11	45	6	—
HES2035-C	●	3.5	11	45	6	7,880
HES2036-C	□	3.6	12	45	6	—
HES2037-C	□	3.7	12	45	6	—
HES2038-C	□	3.8	12	45	6	—

商品コード Item code	在庫 Stock	寸法 Size (mm)				希望小売価格 (円) Suggested retail price(¥)
		外径 Tool dia.	刃長 Flute length	全長 Overall length	シャンク径 Shank dia.	
HES2039-C	□	3.9	12	45	6	—
HES2040-C	●	4	12	45	6	7,880
HES2041-C	□	4.1	14	45	6	—
HES2042-C	□	4.2	14	45	6	—
HES2043-C	□	4.3	14	45	6	—
HES2044-C	□	4.4	14	45	6	—
HES2045-C	●	4.5	14	45	6	8,940
HES2046-C	□	4.6	15	50	6	—
HES2047-C	□	4.7	15	50	6	—
HES2048-C	□	4.8	15	50	6	—
HES2049-C	□	4.9	15	50	6	—
HES2050-C	●	5	15	50	6	8,940
HES2051-C	□	5.1	15	50	6	—
HES2052-C	□	5.2	15	50	6	—
HES2053-C	□	5.3	15	50	6	—
HES2054-C	□	5.4	15	50	6	—
HES2055-C	●	5.5	15	50	6	9,600
HES2056-C	□	5.6	15	50	6	—
HES2057-C	□	5.7	15	50	6	—
HES2058-C	□	5.8	15	50	6	—
HES2059-C	□	5.9	15	50	6	—
HES2060-C	●	6	15	50	6	9,260
HES2061-C	□	6.1	15	50	6	—
HES2062-C	□	6.2	15	50	6	—
HES2063-C	□	6.3	15	50	6	—
HES2064-C	□	6.4	15	50	6	—
HES2065-C	●	6.5	15	50	6	11,030
HES2066-C	□	6.6	20	60	8	—
HES2067-C	□	6.7	20	60	8	—
HES2068-C	□	6.8	20	60	8	—
HES2069-C	□	6.9	20	60	8	—
HES2070-C	●	7	20	60	8	11,030
HES2071-C	□	7.1	20	60	8	—
HES2072-C	□	7.2	20	60	8	—
HES2073-C	□	7.3	20	60	8	—
HES2074-C	□	7.4	20	60	8	—
HES2075-C	●	7.5	20	60	8	12,020
HES2076-C	□	7.6	20	60	8	—

商品コード Item code	在庫 Stock	寸法 Size (mm)				希望小売価格 (円) Suggested retail price(¥)
		外径 Tool dia.	刃長 Flute length	全長 Overall length	シャンク径 Shank dia.	
HES2077-C	□	7.7	20	60	8	—
HES2078-C	□	7.8	20	60	8	—
HES2079-C	□	7.9	20	60	8	—
HES2080-C	●	8	20	60	8	12,020
HES2081-C	□	8.1	20	60	8	—
HES2082-C	□	8.2	20	60	8	—
HES2083-C	□	8.3	20	60	8	—
HES2084-C	□	8.4	20	60	8	—
HES2085-C	●	8.5	20	60	8	14,480
HES2086-C	□	8.6	20	65	10	—
HES2087-C	□	8.7	20	65	10	—
HES2088-C	□	8.8	20	65	10	—
HES2089-C	□	8.9	20	65	10	—
HES2090-C	●	9	20	65	10	14,480
HES2091-C	□	9.1	20	65	10	—
HES2092-C	□	9.2	20	65	10	—
HES2093-C	□	9.3	20	65	10	—
HES2094-C	□	9.4	20	65	10	—
HES2095-C	●	9.5	20	65	10	16,160
HES2096-C	□	9.6	25	70	10	—
HES2097-C	□	9.7	25	70	10	—
HES2098-C	□	9.8	25	70	10	—
HES2099-C	□	9.9	25	70	10	—
HES2100-C	●	10	25	70	10	14,820
HES2105-C	●	10.5	25	70	10	17,740
HES2110-C	●	11	25	75	12	17,740
HES2120-C	●	12	25	75	12	20,090
HES2130-C	●	13	25	75	12	28,630
HES2140-C	●	14	35	90	16	31,920
HES2150-C	●	15	35	90	16	40,360
HES2160-C	●	16	35	90	16	40,830
HES2170-C	□	17	35	90	16	—
HES2180-C	●	18	40	105	20	63,350
HES2190-C	□	19	40	105	20	—
HES2200-C	●	20	40	105	20	69,210
HES2220-C	●	22	45	115	20	80,710
HES2250-C	●	25	50	120	25	119,650
HES2300-C	□	30	55	130	32	—

○ HES2-Cの対応被削材

Applicable work material of HES2-C

炭素鋼 合金鋼 Carbon steel Alloy steel	プリハー ド鋼 Pre-hardened steel ≤ 45HRC	高硬度 Hardened steel			ステン レス鋼 Stainless steel	チタン合金 耐熱合金 Titanium alloy Heat-resistant alloy	銅合金 Copper alloy	アルミ 合金 Aluminum alloy
○	○	> 45HRC ≤ 55HRC	> 55HRC ≤ 65HRC	> 65HRC	○	○	○	○

○ 再研磨対応外径範囲

Re-grinding compatibility range

商品コード Item code	外周 Outer dia. (mm)	エンド End (mm)
HES2-C	6 ~ 30	2 ~ 30

C Coating Carbide End Mills

超硬・Cコートエンドミル

ミディアム刃長

Medium



外径公差 Dia.tolerance
 $\phi 3 \sim \phi 6 : 0 \sim -0.02$
 $\phi 7 \sim \phi 25 : 0 \sim -0.025$



(mm)

2枚刃
2Flutes



ロング刃長

Long



外径公差 Dia.tolerance
 $\phi 1 \sim \phi 6 : 0 \sim -0.02$
 $\phi 7 \sim \phi 25 : 0 \sim -0.025$



(mm)

2枚刃
2Flutes



HESM2-C



商品コード Item code	在庫 Stock	寸法 Size (mm)				希望小売 価格(円) Suggested retail price(¥)
		外径 Tool dia.	刃長 Flute length	全長 Overall length	シャンク径 Shank dia.	
HESM2030-C	●	3	15	50	6	8,760
HESM2040-C	●	4	17	50	6	9,080
HESM2050-C	●	5	20	53	6	10,360
HESM2060-C	●	6	20	60	6	11,200
HESM2070-C	●	7	25	63	8	11,910
HESM2080-C	●	8	25	75	8	12,580
HESM2100-C	●	10	33	80	10	18,640
HESM2120-C	●	12	37	90	12	23,010
HESM2140-C	□	14	42	100	16	—
HESM2150-C	□	15	42	110	16	—
HESM2160-C	●	16	47	110	16	49,040
HESM2180-C	□	18	50	120	20	—
HESM2200-C	●	20	55	120	20	71,680
HESM2250-C	□	25	65	140	25	—

HESL2-C



商品コード Item code	在庫 Stock	寸法 Size (mm)				希望小売 価格(円) Suggested retail price(¥)
		外径 Tool dia.	刃長 Flute length	全長 Overall length	シャンク径 Shank dia.	
HESL2010-C	●	1	6	50	4	11,680
HESL2015-C	●	1.5	8	50	4	11,680
HESL2020-C	●	2	14	50	4	11,680
HESL2025-C	●	2.5	16	50	4	11,680
HESL2030-C	●	3	20	55	6	12,860
HESL2040-C	●	4	24	57	6	13,610
HESL2050-C	●	5	30	65	6	15,600
HESL2060-C	●	6	30	65	6	16,720
HESL2070-C	●	7	40	80	8	19,530
HESL2080-C	●	8	40	80	8	21,440
HESL2090-C	●	9	40	85	10	26,370
HESL2100-C	●	10	50	95	10	29,520
HESL2120-C	●	12	50	100	12	35,020
HESL2140-C	□	14	70	125	16	—
HESL2150-C	□	15	70	125	16	—
HESL2160-C	●	16	70	125	16	67,220
HESL2180-C	□	18	75	135	20	—
HESL2200-C	●	20	75	140	20	111,210
HESL2250-C	□	25	80	150	25	—

○ HESM2-C、HESL2-Cの対応被削材

Applicable work material of HES2-C, HESM2-C

炭素鋼 合金鋼 Carbon steel Alloy steel	プリハー ド鋼 Pre-hardened steel	高硬度 Hardened steel			ステン レス鋼 Stainless steel	チタン合金 耐熱合金 Titanium alloy Heat-resistant alloy	銅合金 Copper alloy	アルミ 合金 Aluminum alloy
		> 45HRC ≤ 45HRC	> 55HRC ≤ 55HRC	> 65HRC				
○	○	○	○	○	○	○	○	

○ 再研磨対応外径範囲

Re-grinding compatibility range

商品コード Item code	外周 Outer dia. (mm)	エンド End (mm)
HESM2-C	6 ~ 25	3 ~ 25
HESL2-C	6 ~ 25	2 ~ 25

●印：標準在庫品です。 □印：特定代理店在庫です。弊社営業へお問合せください。
 ● : Stocked items. □ : Stocked by specified distributor. Contact with our sales department.

標準切削条件表 Recommended cutting conditions

HES2-C 2枚刃・レギュラー刃長
2ft, Regular

HESL2-C (注②) 2枚刃・ロング刃長
2ft, Long

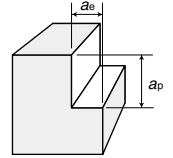

〈側面切削〉 Side milling

被削材 Work material	鋳鉄 炭素鋼 Cast irons Carbon steels (200HB以下) FC200, SS400, S45C		合金鋼 Alloy steels (200~250HB) SCM, SNCM		工具鋼 ステンレス鋼 Tool steels Stainless steels (25~35HRC) SKD, SKT, SUS304		焼入れ鋼 プリハードン鋼 Hardened steels Pre-hardened steels (35~45HRC) SKD, SKT, HPM1, NAK55		耐熱鋼 チタン合金 Heat-resistant steels Titanium alloys Inconel Ti-6Al-4V		アルミ合金 非鉄金属 Aluminum alloys Non-Ferrous	
	$a_p=1.5DC$ $a_e=0.1DC$		$a_p=1.5DC$ $a_e=0.1DC$		$a_p=1.5DC$ $a_e=0.1DC$		$a_p=1.5DC$ $a_e=0.1DC$		$a_p=1.5DC$ $a_e=0.1DC$		$a_p=1.5DC$ $a_e=0.1DC$	
外径DC Tool dia. (mm)	回転数 n (min^{-1})	送り速度 v_f (mm/min)	回転数 n (min^{-1})	送り速度 v_f (mm/min)	回転数 n (min^{-1})	送り速度 v_f (mm/min)	回転数 n (min^{-1})	送り速度 v_f (mm/min)	回転数 n (min^{-1})	送り速度 v_f (mm/min)	回転数 n (min^{-1})	送り速度 v_f (mm/min)
φ3	9,500	280	7,400	220	5,800	170	4,700	90	2,100	40	21,000	750
φ4	7,100	280	5,500	220	4,300	170	3,500	90	1,500	40	16,000	800
φ6	4,700	280	3,700	220	2,900	170	2,300	90	1,000	40	10,600	800
φ8	3,500	280	2,700	220	2,100	170	1,700	100	790	45	8,000	900
φ10	2,800	280	2,200	220	1,700	170	1,400	100	630	45	6,400	950
φ12	2,300	280	1,800	220	1,400	170	1,100	100	530	45	5,300	950
φ16	1,700	280	1,300	220	1,000	170	890	100	390	45	4,000	950
φ20	1,400	280	1,100	220	870	170	710	100	310	45	3,200	800
φ25	1,100	220	890	180	700	140	570	85	250	40	2,500	800

- 【注意】**
- ①被削材、加工形状に合わせて、適切なクーラントを使用してください。
 - ②この標準切削条件表は切削条件の目安を示すものです。実際の加工では加工形状、目的、使用機械等により条件を調整してください。
 - ③上記の切削条件は2枚刃の場合を示します。4枚刃は、送り速度を1.5倍にしてください。
 - ④ロング刃の場合は回転数、送り速度とも約50%以下にしてください。

- [Note]**
- ① Use the appropriate coolant for the work material and machining shape.
 - ② These Recommended Cutting Conditions indicate only the rule of a thumb for the cutting conditions. In actual machining, the condition should be adjusted according to the machining shape, purpose and the machine type.
 - ③ The cutting conditions given above is applied to 2-flute type end mills. As for 4-flute type, increase the feed speed by 1.5 times.
 - ④ As for the long length type end mills, decrease the revolution number and the feed speed to not more than 50%.

Carbide End Mills

超硬ソリッドエンドミル

レギュラー刃長

Regular



2枚刃
2Flutes



外径公差
φ0.1~φ6 : 0~-0.02
φ6.1~φ30 : 0~-0.025



(mm)

HES2000

超硬 Carbide 螺旋角 Helix angle 30° 切削条件表 Cutting Conditions A392

商品コード Item code	在庫 Stock	寸法 Size (mm)				希望小売価格 (円) Suggested retail price(¥)
		外径 Tool dia.	刃長 Flute length	全長 Overall length	シャンク径 Shank dia.	
HES2001	●	0.1	0.2	38	3	13,080
HES2002	●	0.2	0.4	38	3	8,100
HES2003	●	0.3	1	38	3	7,160
HES2004	●	0.4	1	38	3	7,160
HES2005	●	0.5	1.5	38	3	6,700
HES2006	●	0.6	1.5	38	3	6,700
HES2007	●	0.7	1.5	38	3	6,290
HES2008	●	0.8	2	38	3	6,290
HES2009	●	0.9	2	38	3	6,040
HES2010	●	1	2.5	40	4	4,890
HES2011	●	1.1	3	40	4	5,460
HES2012	●	1.2	3	40	4	5,460
HES2013	●	1.3	4	40	4	5,460
HES2014	●	1.4	4	40	4	5,460
HES2015	●	1.5	4	40	4	4,890
HES2016	●	1.6	5	40	4	5,460
HES2017	●	1.7	5	40	4	5,460
HES2018	●	1.8	5	40	4	5,460
HES2019	●	1.9	6	40	4	5,460
HES2020	●	2	6	40	4	4,890
HES2021	●	2.1	8	40	4	6,030
HES2022	●	2.2	8	40	4	6,030
HES2023	●	2.3	8	40	4	6,030
HES2024	●	2.4	8	40	4	6,030
HES2025	●	2.5	8	40	4	4,890
HES2026	●	2.6	10	45	6	6,030
HES2027	●	2.7	10	45	6	6,030
HES2028	●	2.8	10	45	6	6,030
HES2029	●	2.9	10	45	6	6,030
HES2030	●	3	10	45	6	6,040
HES2031	●	3.1	11	45	6	6,360
HES2032	●	3.2	11	45	6	6,360
HES2033	●	3.3	11	45	6	6,360
HES2034	●	3.4	11	45	6	6,360
HES2035	●	3.5	11	45	6	6,360
HES2036	●	3.6	12	45	6	6,360
HES2037	●	3.7	12	45	6	6,360
HES2038	●	3.8	12	45	6	6,360
HES2039	●	3.9	12	45	6	6,360
HES2040	●	4	12	45	6	6,360
HES2041	●	4.1	14	45	6	7,340
HES2042	●	4.2	14	45	6	7,340
HES2043	●	4.3	14	45	6	7,340
HES2044	●	4.4	14	45	6	7,340
HES2045	●	4.5	14	45	6	7,340
HES2046	●	4.6	15	50	6	7,340

商品コード Item code	在庫 Stock	寸法 Size (mm)				希望小売価格 (円) Suggested retail price(¥)
		外径 Tool dia.	刃長 Flute length	全長 Overall length	シャンク径 Shank dia.	
HES2047	●	4.7	15	50	6	7,340
HES2048	●	4.8	15	50	6	7,340
HES2049	●	4.9	15	50	6	7,340
HES2050	●	5	15	50	6	7,340
HES2051	●	5.1	15	50	6	8,000
HES2052	●	5.2	15	50	6	8,000
HES2053	●	5.3	15	50	6	8,000
HES2054	●	5.4	15	50	6	8,000
HES2055	●	5.5	15	50	6	8,000
HES2056	●	5.6	15	50	6	8,000
HES2057	●	5.7	15	50	6	8,000
HES2058	●	5.8	15	50	6	8,000
HES2059	●	5.9	15	50	6	8,000
HES2060	●	6	15	50	6	7,650
HES2061	●	6.1	15	50	6	9,420
HES2062	●	6.2	15	50	6	9,420
HES2063	●	6.3	15	50	6	9,420
HES2064	●	6.4	15	50	6	9,420
HES2065	●	6.5	15	50	6	9,420
HES2066	●	6.6	20	60	8	9,420
HES2067	●	6.7	20	60	8	9,420
HES2068	●	6.8	20	60	8	9,420
HES2069	●	6.9	20	60	8	9,420
HES2070	●	7	20	60	8	9,420
HES2071	□	7.1	20	60	8	-
HES2072	□	7.2	20	60	8	-
HES2073	□	7.3	20	60	8	-
HES2074	□	7.4	20	60	8	-
HES2075	●	7.5	20	60	8	10,330
HES2076	□	7.6	20	60	8	-
HES2077	□	7.7	20	60	8	-
HES2078	□	7.8	20	60	8	-
HES2079	□	7.9	20	60	8	-
HES2080	●	8	20	60	8	10,330
HES2081	□	8.1	20	60	8	-
HES2082	□	8.2	20	60	8	-
HES2083	□	8.3	20	60	8	-
HES2084	□	8.4	20	60	8	-
HES2085	●	8.5	20	60	8	12,690
HES2086	□	8.6	20	65	10	-
HES2087	□	8.7	20	65	10	-
HES2088	□	8.8	20	65	10	-
HES2089	□	8.9	20	65	10	-
HES2090	●	9	20	65	10	12,690
HES2091	□	9.1	20	65	10	-
HES2092	□	9.2	20	65	10	-

商品コード Item code	在庫 Stock	寸法 Size (mm)				希望小売価格 (円) Suggested retail price(¥)
		外径 Tool dia.	刃長 Flute length	全長 Overall length	シャンク径 Shank dia.	
HES2093	□	9.3	20	65	10	-
HES2094	□	9.4	20	65	10	-
HES2095	●	9.5	20	65	10	14,370
HES2096	□	9.6	25	70	10	-
HES2097	□	9.7	25	70	10	-
HES2098	□	9.8	25	70	10	-
HES2099	□	9.9	25	70	10	-
HES2100	●	10	25	70	10	13,030
HES2101	□	10.1	25	70	10	-
HES2102	□	10.2	25	70	10	-
HES2103	□	10.3	25	70	10	-
HES2104	□	10.4	25	70	10	-
HES2105	●	10.5	25	70	10	17,070
HES2106	□	10.6	25	75	12	-
HES2107	□	10.7	25	75	12	-
HES2108	□	10.8	25	75	12	-
HES2109	□	10.9	25	75	12	-
HES2110	●	11	25	75	12	17,070
HES2111	□	11.1	25	75	12	-
HES2112	□	11.2	25	75	12	-
HES2113	□	11.3	25	75	12	-
HES2114	□	11.4	25	75	12	-
HES2115	□	11.5	25	75	12	-
HES2116	□	11.6	25	75	12	-
HES2117	□	11.7	25	75	12	-
HES2118	□	11.8	25	75	12	-
HES2119	□	11.9	25	75	12	-
HES2120	●	12	25	75	12	17,960
HES2130	●	13	25	75	12	25,940
HES2140	●	14	35	90	16	29,210
HES2150	●	15	35	90	16	36,950
HES2160	●	16	35	90	16	37,540
HES2170	□	17	35	90	16	-
HES2180	●	18	40	105	20	59,240
HES2190	□	19	40	105	20	-
HES2200	●	20	40	105	20	64,170
HES2210	□	21	40	105	20	-
HES2220	●	22	45	115	20	75,660
HES2230	□	23	45	115	20	-
HES2240	□	24	50	120	20	-
HES2250	●	25	50	120	25	93,030
HES2260	□	26	50	120	25	-
HES2270	□	27	55	130	25	-
HES2280	□	28	55	130	25	-
HES2290	□	29	55	130	25	-
HES2300	□	30	55	130	32	-

対応被削材 Applicable work material

炭素鋼 合金鋼 Carbon steel Alloy steel	プリハー ド鋼 Pre-hardened steel	高硬度 Hardened steel			ステン レス鋼 Stainless steel	チタン合金 耐熱合金 Titanium alloy Heat-resistant alloy	銅合金 Copper alloy	アルミ 合金 Aluminum alloy
		> 45HRC ≤ 45HRC	> 55HRC ≤ 55HRC	> 65HRC				
○	○	○	○	○	○	○	○	

●印：標準在庫品です。 □印：特定代理店在庫です。弊社営業へお問合せください。
● : Stocked items. □ : Stocked by specified distributor. Contact with our sales department.

再研磨対応外径範囲 Re-grinding compatibility range

商品コード Item code	外周 Outer dia. (mm)	エンド End (mm)
HES2	6 ~ 30	2 ~ 30

ミディアム刃長 Medium

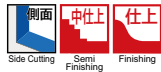

外径公差 Dia. tolerance
 $\phi 3 \sim \phi 6 : 0 \sim -0.02$
 $\phi 7 \sim \phi 30 : 0 \sim -0.025$



(mm)

2枚刃
2Flutes



ロング刃長 Long



外径公差 Dia. tolerance
 $\phi 1 \sim \phi 6 : 0 \sim -0.02$
 $\phi 7 \sim \phi 25 : 0 \sim -0.025$



(mm)

2枚刃
2Flutes



HESM2



商品コード Item code	在庫 Stock	寸法 Size (mm)				希望小売 価格(円) Suggested retail price(¥)
		外径 Tool dia.	刃長 Flute length	全長 Overall length	シャンク径 Shank dia.	
HESM2030	●	3	15	50	6	7,240
HESM2040	●	4	17	50	6	7,580
HESM2050	●	5	20	53	6	8,760
HESM2060	●	6	20	60	6	9,620
HESM2070	●	7	25	63	8	10,120
HESM2080	●	8	25	75	8	10,950
HESM2090	□	9	28	75	10	—
HESM2100	●	10	33	80	10	16,830
HESM2110	□	11	33	90	12	—
HESM2120	●	12	37	90	12	21,100
HESM2130	□	13	37	100	12	—
HESM2140	□	14	42	100	16	—
HESM2150	□	15	42	110	16	—
HESM2160	●	16	47	110	16	45,880
HESM2170	□	17	47	110	16	—
HESM2180	□	18	50	120	20	—
HESM2190	□	19	50	120	20	—
HESM2200	●	20	55	120	20	66,750
HESM2210	□	21	55	130	20	—
HESM2220	□	22	60	130	20	—
HESM2230	□	23	60	130	20	—
HESM2240	□	24	65	140	20	—
HESM2250	□	25	65	140	25	—
HESM2260	□	26	65	140	25	—
HESM2270	□	27	70	145	25	—
HESM2280	□	28	70	145	25	—
HESM2290	□	29	70	145	25	—
HESM2300	□	30	70	145	32	—

HESL2

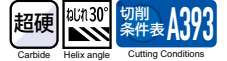

商品コード Item code	在庫 Stock	寸法 Size (mm)				希望小売 価格(円) Suggested retail price(¥)
		外径 Tool dia.	刃長 Flute length	全長 Overall length	シャンク径 Shank dia.	
HESL2010	●	1	6	50	4	10,160
HESL2015	●	1.5	8	50	4	10,160
HESL2020	●	2	14	50	4	10,160
HESL2025	●	2.5	16	50	4	10,160
HESL2030	●	3	20	55	6	11,250
HESL2040	●	4	24	57	6	12,010
HESL2050	●	5	30	65	6	13,920
HESL2060	●	6	30	65	6	15,040
HESL2070	●	7	40	80	8	17,960
HESL2080	●	8	40	80	8	20,090
HESL2090	●	9	40	85	10	24,580
HESL2100	●	10	50	95	10	27,720
HESL2110	□	11	50	95	12	—
HESL2120	●	12	50	100	12	32,990
HESL2130	□	13	50	100	12	—
HESL2140	□	14	70	125	16	—
HESL2150	□	15	70	125	16	—
HESL2160	●	16	70	125	16	63,930
HESL2170	□	17	70	135	16	—
HESL2180	□	18	75	135	20	—
HESL2190	□	19	75	140	20	—
HESL2200	●	20	75	140	20	106,290
HESL2210	□	21	75	140	20	—
HESL2220	□	22	80	150	20	—
HESL2230	□	23	80	150	20	—
HESL2240	□	24	80	150	20	—
HESL2250	□	25	80	150	25	—

○ HESM2、HESL2の対応被削材

Applicable work material of HESM2, HESL2

炭素鋼 合金鋼 Carbon steel Alloy steel	プリハー ド鋼 Pre-hardened steel	高硬度 Hardened steel			ステン レス鋼 Stainless steel	チタン合金 耐熱合金 Titanium alloy Heat-resistant alloy	銅合金 Copper alloy	アルミ 合金 Aluminum alloy
		> 45HRC ≤ 55HRC	> 55HRC ≤ 65HRC	> 65HRC				
○	○				○	○	◎	◎

○ 再研磨対応外径範囲

Re-grinding compatibility range

商品コード Item code	外周 Outer dia. (mm)	エンド End (mm)
HESM2	6 ~ 30	3 ~ 30
HESL2	6 ~ 25	2 ~ 25

超硬ソリッドエンドミル

標準切削条件表 Recommended cutting conditions

超硬ソリッドエンドミル スクエアエンドミル

HES2
2枚刃・レギュラー刃長
2ft, Regular

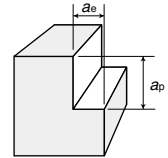

<側面切削> Side milling

被削材 Work material	鋳鉄 炭素鋼 Cast irons Carbon steels (200HB以下) FC200, SS400, S45C		合金鋼 Alloy steels (200~250HB) SCM, SNCM		工具鋼 ステンレス鋼 Tool steels Stainless steels (25~35HRC) SKD, SKT, SUS304		焼入れ鋼 プリハードン鋼 Hardened steels Pre-hardened steels (35~45HRC) SKD, SKT, HPM1, NAK55		耐熱鋼 チタン合金 Heat-resistant steels Titanium alloys Inconel Ti-6Al-4V		アルミ合金 非鉄金属 Aluminum alloys Non-ferrous	
	切込み Depth of cut (mm)	$a_p=1.5DC$ $a_e=0.1DC$	切込み Depth of cut (mm)	$a_p=1.5DC$ $a_e=0.1DC$	切込み Depth of cut (mm)	$a_p=1.5DC$ $a_e=0.1DC$	切込み Depth of cut (mm)	$a_p=1.5DC$ $a_e=0.1DC$	切込み Depth of cut (mm)	$a_p=1.5DC$ $a_e=0.1DC$	切込み Depth of cut (mm)	$a_p=1.5DC$ $a_e=0.1DC$
外径DC Tool dia.(mm)	回転数n (min ⁻¹)	送り速度vf (mm/min)	回転数n (min ⁻¹)	送り速度vf (mm/min)	回転数n (min ⁻¹)	送り速度vf (mm/min)	回転数n (min ⁻¹)	送り速度vf (mm/min)	回転数n (min ⁻¹)	送り速度vf (mm/min)	回転数n (min ⁻¹)	送り速度vf (mm/min)
φ3	4,750	140	3,700	80	3,200	60	2,650	30	1,600	20	21,000	750
φ4	3,600	140	2,750	110	2,400	60	2,000	30	1,200	25	16,000	800
φ6	2,400	150	1,850	110	1,600	60	1,320	40	800	25	10,600	800
φ8	1,800	150	1,400	110	1,200	90	1,000	50	600	30	8,000	900
φ10	1,450	150	1,100	110	950	90	800	50	480	30	6,400	950
φ12	1,200	180	930	110	800	90	660	50	400	30	5,300	950
φ16	900	180	700	110	600	90	500	50	300	30	4,000	950
φ20	720	180	560	110	480	90	400	50	240	30	3,200	800
φ25	570	140	450	100	380	90	320	50	190	30	2,500	800
φ30	480	120	370	80	320	90	270	50	160	30	2,100	650

- [注意]**
- ①被削材、加工形状に合わせて、適切なクーラントを使用してください。
 - ②この標準切削条件表は切削条件の目安を示すものです。実際の加工では加工形状、目的、使用機械等により条件を調整してください。
 - ③上記の切削条件は2枚刃の場合を示します。4枚刃は、送り速度を1.5倍にしてください。
 - ④ロング刃の場合は回転数、送り速度とも約50%以下にしてください。

- [Note]**
- ① Use the appropriate coolant for the work material and machining shape.
 - ② These Recommended Cutting Conditions indicate only the rule of a thumb for the cutting conditions. In actual machining, the condition should be adjusted according to the machining shape, purpose and the machine type.
 - ③ The cutting conditions given above is applied to 2-flute type end mills. As for 4-flute type, increase the feed speed by 1.5 times.
 - ④ As for the long length type end mills, decrease the revolution number and the feed speed to not more than 50%.

HES2 [φ0.1~φ2.0]
2枚刃
2ft

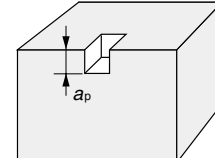

<小径サイズ> Miniature

被削材 (硬さ) Work material (Hardness)		鋳鉄・炭素鋼・合金鋼 Cast irons, Carbon steels, Alloy steels (250HB以下)	
切削方法 Conditions	切込み Depth of Cut a_p mm / 回	切削速度 Cutting speed $v_c=10 \sim 32$ m/min	1刃送り Feed rate $f_z=0.001 \sim 0.01$ mm / t
		回転数 Revolution min ⁻¹	送り速度 Table speed mm / min
0.1	0.03 ~ 0.06	32,000 ~ 102,000	40
0.2	0.03 ~ 0.06	16,000 ~ 51,000	40
0.3	0.03 ~ 0.06	10,600 ~ 34,000	40
0.4	0.04 ~ 0.08	8,000 ~ 25,500	40
0.5	0.05 ~ 0.10	6,400 ~ 20,000	50
0.6	0.05 ~ 0.12	5,300 ~ 17,000	50
0.7	0.05 ~ 0.14	4,550 ~ 14,600	50
0.8	0.05 ~ 0.20	4,000 ~ 12,700	50
0.9	0.05 ~ 0.20	3,500 ~ 11,300	50
1.0	0.05 ~ 0.20	3,200 ~ 10,000	60
1.2	0.05 ~ 0.20	2,650 ~ 8,500	60
1.5	0.05 ~ 0.30	2,100 ~ 6,800	60
2.0	0.10 ~ 0.40	1,600 ~ 5,100	80

- [注意]**
- ①被削材、加工形状に合わせて、適切なクーラントを使用してください。
 - ②この標準切削条件表は切削条件の目安を示すものです。実際の加工では加工形状、目的、使用機械等により条件を調整してください。
 - ③送り速度は、上表の切込みの大きい方で示しています。この表より大きい切込みの場合は、送り速度を落してください。
 - ④回転数はできるだけ上表の高い方でお使いください。

- [Note]**
- ① Use the appropriate coolant for the work material and machining shape.
 - ② These Recommended Cutting Conditions indicate only the rule of a thumb for the cutting conditions. In actual machining, the condition should be adjusted according to the machining shape, purpose and the machine type.
 - ③ The feed speeds in this table represent the value when the depth of cut takes the maximum value in the range. When the depth of cut is beyond the range, slow down the feed speed.
 - ④ Select as high revolution number as possible given in this table.

HES2

2枚刃・レギュラー刃長
2ft, Regular

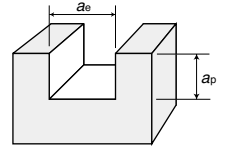

〈溝切削〉 Slotting

被削材 Work material	鋳鉄 炭素鋼 Cast irons Carbon steels (200HB以下) FC200, SS400, S45C		合金鋼 Alloy steels (200~250HB) SCM, SNCM		工具鋼 ステンレス鋼 Tool steels Stainless steels (25~35HRC) SKD, SKT, SUS304		焼入れ鋼 プリハードン鋼 Hardened steels Pre-hardened steels (35~45HRC) SKD, SKT, HPM1, NAK55		耐熱鋼 チタン合金 Heat-resistant steels Titanium alloys Inconel Ti-6Al-4V		アルミ合金 非鉄金属 Aluminum alloys Non-ferrous	
	ap=0.5DC ae=1DC		ap=0.5DC ae=1DC		ap=0.5DC ae=1DC		ap=0.5DC ae=1DC		ap=0.5DC ae=1DC		ap=0.5DC ae=1DC	
切込み Depth of cut (mm)	回転数n (min ⁻¹)	送り速度vf (mm/min)	回転数n (min ⁻¹)	送り速度vf (mm/min)	回転数n (min ⁻¹)	送り速度vf (mm/min)	回転数n (min ⁻¹)	送り速度vf (mm/min)	回転数n (min ⁻¹)	送り速度vf (mm/min)	回転数n (min ⁻¹)	送り速度vf (mm/min)
φ3	3,700	80	3,200	50	2,650	30	2,100	22	1,250	15	11,000	300
φ4	2,750	85	2,400	50	2,000	30	1,590	22	950	15	8,000	300
φ6	1,850	85	1,600	50	1,320	30	1,060	22	640	15	5,300	300
φ8	1,400	90	1,200	60	1,000	40	800	33	480	20	4,000	300
φ10	1,100	90	950	60	800	40	640	33	380	20	3,200	300
φ12	930	90	800	60	660	40	530	33	320	20	2,700	300
φ16	700	90	600	60	500	40	400	33	240	20	2,700	300
φ20	560	90	480	60	400	40	320	33	190	20	1,600	300
φ25	450	90	380	60	320	40	250	33	150	20	1,250	300
φ30	370	90	320	60	270	40	210	33	130	20	1,000	300

- 【注意】** ①被削材、加工形状に合わせて、適切なクーラントを使用してください。
 ②この標準切削条件表は切削条件の目安を示すものです。実際の加工では加工形状、目的、使用機械等により条件を調整してください。
 ③ロング刃は溝切削に適しません。

- 【Note】** ① Use the appropriate coolant for the work material and machining shape.
 ② These Recommended Cutting Conditions indicate only the rule of a thumb for the cutting conditions. In actual machining, the condition should be adjusted according to the machining shape, purpose and the machine type.
 ③ The long length type is not suited to slotting.

HESL2

2枚刃・ロング刃長
2ft, Long

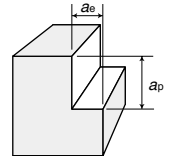

〈側面切削〉 Side milling

被削材 Work material	鋳鉄 炭素鋼 Cast irons Carbon steels (200HB以下) FC200, SS400, S45C		合金鋼 Alloy steels (200~250HB) SCM, SNCM		工具鋼 ステンレス鋼 Tool steels Stainless steels (25~35HRC) SKD, SKT, SUS304		焼入れ鋼 プリハードン鋼 Hardened steels Pre-hardened steels (35~45HRC) SKD, SKT, HPM1, NAK55		耐熱鋼 チタン合金 Heat-resistant steels Titanium alloys Inconel Ti-6Al-4V		アルミ合金 非鉄金属 Aluminum alloys Non-ferrous	
	ap=1.5DC ae=0.1DC		ap=1.5DC ae=0.1DC		ap=1.5DC ae=0.1DC		ap=1.5DC ae=0.1DC		ap=1.5DC ae=0.1DC		ap=1.5DC ae=0.1DC	
切込み Depth of cut (mm)	回転数n (min ⁻¹)	送り速度vf (mm/min)	回転数n (min ⁻¹)	送り速度vf (mm/min)	回転数n (min ⁻¹)	送り速度vf (mm/min)	回転数n (min ⁻¹)	送り速度vf (mm/min)	回転数n (min ⁻¹)	送り速度vf (mm/min)	回転数n (min ⁻¹)	送り速度vf (mm/min)
φ3	2,400	70	1,900	40	1,700	32	1,500	17	1,250	16	10,000	375
φ4	1,800	70	1,400	55	1,300	32	1,100	17	950	20	8,000	400
φ6	1,200	75	950	55	850	32	740	22	640	20	5,300	400
φ8	900	75	720	55	640	48	560	30	480	24	4,000	450
φ10	750	75	570	55	510	48	450	30	380	24	3,200	475
φ12	610	90	480	55	420	48	370	30	320	24	2,600	475
φ16	450	90	360	55	320	48	280	30	240	24	2,000	400
φ20	365	90	290	55	250	48	220	30	190	24	1,600	400
φ25	300	60	230	40	200	48	180	30	150	24	1,300	325

- 【注意】** ①被削材、加工形状に合わせて、適切なクーラントを使用してください。
 ②この標準切削条件表は切削条件の目安を示すものです。実際の加工では加工形状、目的、使用機械等により条件を調整してください。
 ③上記の切削条件は2枚刃の場合を示します。4枚刃は、送り速度を1.5倍にしてください。
 ④ロング刃は溝切削に適しません。

- 【Note】** ① Use the appropriate coolant for the work material and machining shape.
 ② These Recommended Cutting Conditions indicate only the rule of a thumb for the cutting conditions. In actual machining, the condition should be adjusted according to the machining shape, purpose and the machine type.
 ③ The cutting conditions given above is applied to 2-flute type end mills. As for 4-flute type, increase the feed speed by 1.5 times.
 ④ The long length type is not suited to slotting.

C Coating Carbide End Mills

超硬・Cコートエンドミル

レギュラー刃長 Regular

Regular



外径公差 Dia. tolerance
 $\phi 2 \sim \phi 6$: 0 ~ -0.02
 $\phi 6.5 \sim \phi 30$: 0 ~ -0.025



ミディアム刃長 Medium

Medium

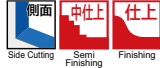

外径公差 Dia. tolerance
 $\phi 3 \sim \phi 6$: 0 ~ -0.02
 $\phi 7 \sim \phi 30$: 0 ~ -0.025



ロング刃長 Long

Long



外径公差 Dia. tolerance
 $\phi 3 \sim \phi 6$: 0 ~ -0.02
 $\phi 7 \sim \phi 25$: 0 ~ -0.025



HES4-C

商品コード Item code	在庫 Stock	寸法 Size (mm)				希望小売価格 (円) Suggested retail price (¥)
		外径 Tool dia.	刃長 Flute length	全長 Overall length	シャンク径 Shank dia.	
HES4020-C	●	2	6	40	4	8,500
HES4025-C	●	2.5	8	40	4	8,680
HES4030-C	●	3	10	45	6	8,680
HES4035-C	●	3.5	11	45	6	9,000
HES4040-C	●	4	12	45	6	9,000
HES4045-C	●	4.5	14	45	6	10,050
HES4050-C	●	5	15	50	6	10,050
HES4055-C	●	5.5	15	50	6	10,920
HES4060-C	●	6	15	50	6	10,920
HES4065-C	●	6.5	15	50	6	12,240
HES4070-C	●	7	20	60	8	12,240
HES4075-C	●	7.5	20	60	8	13,590
HES4080-C	●	8	20	60	8	13,590
HES4085-C	●	8.5	20	60	8	15,710
HES4090-C	●	9	20	65	10	15,710
HES4095-C	●	9.5	20	65	10	18,080
HES4100-C	●	10	25	70	10	18,080
HES4110-C	●	11	25	75	12	20,760
HES4120-C	●	12	25	75	12	22,790
HES4130-C	●	13	25	75	12	31,090
HES4140-C	●	14	35	90	16	34,730
HES4150-C	●	15	35	90	16	43,880
HES4160-C	●	16	35	90	16	52,330
HES4180-C	●	18	40	105	20	69,450
HES4200-C	●	20	40	105	20	76,380
HES4250-C	●	25	50	120	25	130,210
HES4300-C	□	30	55	130	32	-

HESM4-C

商品コード Item code	在庫 Stock	寸法 Size (mm)				希望小売価格 (円) Suggested retail price (¥)
		外径 Tool dia.	刃長 Flute length	全長 Overall length	シャンク径 Shank dia.	
HESM4030-C	●	3	15	50	6	9,080
HESM4040-C	●	4	17	50	6	9,890
HESM4050-C	●	5	20	53	6	11,570
HESM4060-C	●	6	20	60	6	12,470
HESM4070-C	●	7	25	63	8	13,250
HESM4080-C	●	8	25	75	8	14,150
HESM4090-C	●	9	28	75	10	18,640
HESM4100-C	●	10	33	80	10	20,650
HESM4120-C	●	12	37	90	12	25,370
HESM4130-C	□	13	37	100	12	-
HESM4140-C	□	14	42	100	16	-
HESM4150-C	□	15	42	110	16	-
HESM4160-C	●	16	47	110	16	53,730
HESM4180-C	□	18	50	120	20	-
HESM4190-C	□	19	50	120	20	-
HESM4200-C	●	20	55	120	20	78,370
HESM4250-C	□	25	65	140	25	-
HESM4300-C	□	30	70	145	32	-

HESL4-C

商品コード Item code	在庫 Stock	寸法 Size (mm)				希望小売価格 (円) Suggested retail price (¥)
		外径 Tool dia.	刃長 Flute length	全長 Overall length	シャンク径 Shank dia.	
HESL4030-C	●	3	20	55	6	14,250
HESL4040-C	●	4	24	57	6	15,000
HESL4050-C	●	5	30	65	6	17,070
HESL4060-C	●	6	30	65	6	18,300
HESL4070-C	●	7	40	80	8	21,660
HESL4080-C	●	8	40	80	8	23,690
HESL4090-C	●	9	40	85	10	28,850
HESL4100-C	●	10	50	95	10	32,430
HESL4120-C	●	12	50	100	12	38,490
HESL4130-C	□	13	50	100	12	-
HESL4140-C	□	14	70	125	16	-
HESL4150-C	□	15	70	125	16	-
HESL4160-C	●	16	70	125	16	86,460
HESL4180-C	□	18	75	135	20	-
HESL4200-C	●	20	75	140	20	125,520
HESL4250-C	□	25	80	150	25	-

○ HES4-C、HESM4-C、HESL4-Cの対応被削材

Applicable work material of HES4-C, HESM4-C, HESL4-C

炭素鋼 合金鋼 Carbon steel Alloy steel	プリハー ド鋼 Pre-hardened steel	高硬度 Hardened steel			ステン レス鋼 Stainless steel	チタン合金 耐熱合金 Titanium alloy Heat-resistant alloy	銅合金 Copper alloy	アルミ 合金 Aluminum alloy
		> 45HRC ≤ 45HRC	> 55HRC ≤ 65HRC	> 65HRC				
○	○	○	○	○	○	○	○	

○ 再研磨対応外径範囲

Re-grinding compatibility range

商品コード Item code	外周 Outer dia. (mm)	エンド End (mm)
HES4-C	6 ~ 30	2 ~ 30
HESM4-C	6 ~ 30	3 ~ 30
HESL4-C	6 ~ 25	3 ~ 35

●印：標準在庫品です。 □印：特定代理店在庫です。弊社営業へお問合せください。
 ● : Stocked items. □ : Stocked by specified distributor. Contact with our sales department.

標準切削条件表 Recommended cutting conditions

HES4-C (注①) **HESL4-C** (注①②)
 4枚刃・レギュラー刃長 4枚刃・ロング刃長
 4ft, Regular 4ft, Long

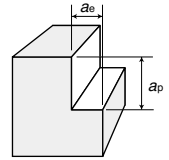

〈側面切削〉 Side milling

被削材 Work material	鋳鉄 炭素鋼 Cast irons Carbon steels (200HB以下) FC200, SS400, S45C		合金鋼 Alloy steels (200~250HB) SCM, SNCM		工具鋼 ステンレス鋼 Tool steels Stainless steels (25~35HRC) SKD, SKT, SUS304		焼入れ鋼 プリハードン鋼 Hardened steels Pre-hardened steels (35~45HRC) SKD, SKT, HPM1, NAK55		耐熱鋼 チタン合金 Heat-resistant steels Titanium alloys Inconel Ti-6Al-4V		アルミ合金 非鉄金属 Aluminum alloys Non-Ferrous	
	$a_p=1.5DC$ $a_e=0.1DC$		$a_p=1.5DC$ $a_e=0.1DC$		$a_p=1.5DC$ $a_e=0.1DC$		$a_p=1.5DC$ $a_e=0.1DC$		$a_p=1.5DC$ $a_e=0.1DC$		$a_p=1.5DC$ $a_e=0.1DC$	
切込み Depth of cut (mm)	回転数 n (min^{-1})	送り速度 v_f (mm/min)	回転数 n (min^{-1})	送り速度 v_f (mm/min)	回転数 n (min^{-1})	送り速度 v_f (mm/min)	回転数 n (min^{-1})	送り速度 v_f (mm/min)	回転数 n (min^{-1})	送り速度 v_f (mm/min)	回転数 n (min^{-1})	送り速度 v_f (mm/min)
φ3	9,500	280	7,400	220	5,800	170	4,700	90	2,100	40	21,000	750
φ4	7,100	280	5,500	220	4,300	170	3,500	90	1,500	40	16,000	800
φ6	4,700	280	3,700	220	2,900	170	2,300	90	1,000	40	10,600	800
φ8	3,500	280	2,700	220	2,100	170	1,700	100	790	45	8,000	900
φ10	2,800	280	2,200	220	1,700	170	1,400	100	630	45	6,400	950
φ12	2,300	280	1,800	220	1,400	170	1,100	100	530	45	5,300	950
φ16	1,700	280	1,300	220	1,000	170	890	100	390	45	4,000	950
φ20	1,400	280	1,100	220	870	170	710	100	310	45	3,200	800
φ25	1,100	220	890	180	700	140	570	85	250	40	2,500	800

- 【注意】**
- ①被削材、加工形状に合わせて、適切なクーラントを使用してください。
 - ②この標準切削条件表は切削条件の目安を示すものです。実際の加工では加工形状、目的、使用機械等により条件を調整してください。
 - ③上記の切削条件は2枚刃の場合を示します。4枚刃は、送り速度を1.5倍にしてください。
 - ④ロング刃の場合は回転数、送り速度とも約50%以下にしてください。

- 【Note】**
- ① Use the appropriate coolant for the work material and machining shape.
 - ② These Recommended Cutting Conditions indicate only the rule of a thumb for the cutting conditions. In actual machining, the condition should be adjusted according to the machining shape, purpose and the machine type.
 - ③ The cutting conditions given above is applied to 2-flute type end mills. As for 4-flute type, increase the feed speed by 1.5 times.
 - ④ As for the long length type end mills, decrease the revolution number and the feed speed to not more than 50%.

超硬ソリッドエンドミル

超硬ソリッドエンドミル
ステンレス用エンドミル

レギュラー刃長 Regular



外径公差 Dia. tolerance	φ2~φ6 : 0~-0.02	h6
	φ6.5~φ30 : 0~-0.025	

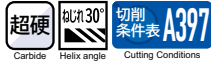

ミディアム刃長 Medium



外径公差 Dia. tolerance	φ3~φ6 : 0~-0.02	h6
	φ7~φ30 : 0~-0.025	



ロング刃長 Long

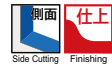

外径公差 Dia. tolerance	φ3~φ6 : 0~-0.02	h6
	φ7~φ25 : 0~-0.025	

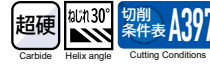

HES4

商品コード Item code	在庫 Stock	寸法 Size (mm)				希望小売価格 (円) Suggested retail price(¥)
		外径 Tool dia.	刃長 Flute length	全長 Overall length	シャンク径 Shank dia.	
HES4020	●	2	6	40	4	6,970
HES4025	●	2.5	8	40	4	7,160
HES4030	●	3	10	45	6	7,160
HES4035	●	3.5	11	45	6	7,480
HES4040	●	4	12	45	6	7,480
HES4045	●	4.5	14	45	6	8,450
HES4050	●	5	15	50	6	8,450
HES4055	●	5.5	15	50	6	9,320
HES4060	●	6	15	50	6	9,320
HES4065	●	6.5	15	50	6	10,610
HES4070	●	7	20	60	8	10,610
HES4075	●	7.5	20	60	8	12,020
HES4080	●	8	20	60	8	12,020
HES4085	●	8.5	20	60	8	13,810
HES4090	●	9	20	65	10	13,810
HES4095	●	9.5	20	65	10	16,160
HES4100	●	10	25	70	10	16,160
HES4105	□	10.5	25	70	10	-
HES4110	●	11	25	75	12	18,640
HES4115	□	11.5	25	75	12	-
HES4120	●	12	25	75	12	20,650
HES4130	●	13	25	75	12	28,280
HES4140	●	14	35	90	16	31,920
HES4150	●	15	35	90	16	40,360
HES4160	●	16	35	90	16	48,810
HES4170	□	17	35	90	16	-
HES4180	●	18	40	105	20	65,230
HES4190	□	19	40	105	20	-
HES4200	●	20	40	105	20	71,330
HES4210	□	21	40	105	20	-
HES4220	□	22	45	115	20	-
HES4230	□	23	45	115	20	-
HES4240	□	24	50	120	20	-
HES4250	●	25	50	120	25	103,000
HES4260	□	26	50	120	25	-
HES4270	□	27	55	130	25	-
HES4280	□	28	55	130	25	-
HES4290	□	29	55	130	25	-
HES4300	□	30	55	130	32	-

HESM4

商品コード Item code	在庫 Stock	寸法 Size (mm)				希望小売価格 (円) Suggested retail price(¥)
		外径 Tool dia.	刃長 Flute length	全長 Overall length	シャンク径 Shank dia.	
HESM4030	●	3	15	50	6	7,580
HESM4040	●	4	17	50	6	8,360
HESM4050	●	5	20	53	6	9,940
HESM4060	●	6	20	60	6	10,800
HESM4070	●	7	25	63	8	11,460
HESM4080	●	8	25	75	8	12,470
HESM4090	●	9	28	75	10	16,720
HESM4100	●	10	33	80	10	18,860
HESM4110	□	11	33	90	12	-
HESM4120	●	12	37	90	12	23,350
HESM4130	□	13	37	100	12	-
HESM4140	□	14	42	100	16	-
HESM4150	□	15	42	110	16	-
HESM4160	●	16	47	110	16	50,440
HESM4170	□	17	47	110	16	-
HESM4180	□	18	50	120	20	-
HESM4190	□	19	50	120	20	-
HESM4200	●	20	55	120	20	73,560
HESM4210	□	21	55	130	20	-
HESM4220	□	22	60	130	20	-
HESM4230	□	23	60	130	20	-
HESM4240	□	24	65	140	20	-
HESM4250	□	25	65	140	25	-
HESM4260	□	26	65	140	25	-
HESM4270	□	27	70	145	25	-
HESM4280	□	28	70	145	25	-
HESM4290	□	29	70	145	25	-
HESM4300	□	30	70	145	32	-

HESL4

商品コード Item code	在庫 Stock	寸法 Size (mm)				希望小売価格 (円) Suggested retail price(¥)
		外径 Tool dia.	刃長 Flute length	全長 Overall length	シャンク径 Shank dia.	
HESL4030	●	3	20	55	6	12,750
HESL4040	●	4	24	57	6	13,390
HESL4050	●	5	30	65	6	15,600
HESL4060	●	6	30	65	6	16,830
HESL4070	●	7	40	80	8	20,090
HESL4080	●	8	40	80	8	22,110
HESL4090	●	9	40	85	10	27,160
HESL4100	●	10	50	95	10	30,640
HESL4110	□	11	50	100	12	-
HESL4120	●	12	50	100	12	36,590
HESL4130	□	13	50	100	12	-
HESL4140	□	14	70	125	16	-
HESL4150	□	15	70	125	16	-
HESL4160	●	16	70	125	16	82,940
HESL4170	□	17	70	135	16	-
HESL4180	□	18	75	135	20	-
HESL4190	□	19	75	140	20	-
HESL4200	●	20	75	140	20	120,820
HESL4250	□	25	80	150	25	-

●印：標準在庫品です。

●：Stocked items.

□印：特定代理店在庫です。弊社営業へお問合せください。

□：Stocked by specified distributor. Contact with our sales department.

○ HES4、HESM4、HESL4の対応被削材

Applicable work material of HES4, HESM4, HESL4

炭素鋼 合金鋼 Carbon steel Alloy steel	プリハー ド鋼 Pre-hardened steel	高硬度 Hardened steel			ステン レス鋼 Stainless steel	チタン合金 耐熱合金 Titanium alloy Heat-resistant alloy	銅合金 Copper alloy	アルミ 合金 Aluminum alloy
		> 45HRC ≤ 55HRC	> 55HRC ≤ 65HRC	> 65HRC				
○	○				○	○	○	

○ 再研磨対応外径範囲 Re-grinding compatibility range

商品コード Item code	外周 Outer dia. (mm)	エンド End (mm)
HES4	6 ~ 30	2 ~ 30
HESM4	6 ~ 30	3 ~ 30
HESL4	6 ~ 25	3 ~ 25

標準切削条件表 Recommended cutting conditions

HES4 (注①)

4枚刃・レギュラー刃長
4ft, Regular

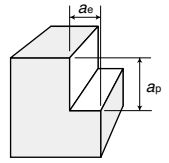

<側面切削> Side milling

被削材 Work material	鋳鉄 炭素鋼 Cast irons Carbon steels (200Hb以下) FC200, SS400, S45C		合金鋼 Alloy steels (200~250HB) SCM, SNCM		工具鋼 ステンレス鋼 Tool steels Stainless steels (25~35HRC) SKD, SKT, SUS304		焼入れ鋼 プリハードン鋼 Hardened steels Pre-hardened steels (35~45HRC) SKD, SKT, HPM1, NAK55		耐熱鋼 チタン合金 Heat-resistant steels Titanium alloys Inconel Ti-6Al-4V		アルミ合金 非鉄金属 Aluminum alloys Non-ferrous	
	切込み Depth of cut (mm)	$a_p=1.5DC$ $a_e=0.1DC$	$a_p=1.5DC$ $a_e=0.1DC$	$a_p=1.5DC$ $a_e=0.1DC$	$a_p=1.5DC$ $a_e=0.1DC$	$a_p=1.5DC$ $a_e=0.1DC$	$a_p=1.5DC$ $a_e=0.1DC$	$a_p=1.5DC$ $a_e=0.1DC$	$a_p=1.5DC$ $a_e=0.1DC$	$a_p=1.5DC$ $a_e=0.1DC$	$a_p=1.5DC$ $a_e=0.1DC$	$a_p=1.5DC$ $a_e=0.1DC$
外径DC Tool dia.(mm)	回転数n (min ⁻¹)	送り速度vf (mm/min)	回転数n (min ⁻¹)	送り速度vf (mm/min)	回転数n (min ⁻¹)	送り速度vf (mm/min)	回転数n (min ⁻¹)	送り速度vf (mm/min)	回転数n (min ⁻¹)	送り速度vf (mm/min)	回転数n (min ⁻¹)	送り速度vf (mm/min)
φ3	4,750	140	3,700	80	3,200	60	2,650	30	1,600	20	21,000	750
φ4	3,600	140	2,750	110	2,400	60	2,000	30	1,200	25	16,000	800
φ6	2,400	150	1,850	110	1,600	60	1,320	40	800	25	10,600	800
φ8	1,800	150	1,400	110	1,200	90	1,000	50	600	30	8,000	900
φ10	1,450	150	1,100	110	950	90	800	50	480	30	6,400	950
φ12	1,200	180	930	110	800	90	660	50	400	30	5,300	950
φ16	900	180	700	110	600	90	500	50	300	30	4,000	950
φ20	720	180	560	110	480	90	400	50	240	30	3,200	800
φ25	570	140	450	100	380	90	320	50	190	30	2,500	800
φ30	480	120	370	80	320	90	270	50	160	30	2,100	650

- [注意]** ①被削材、加工形状に合わせて、適切なクーラントを使用してください。
 ②この標準切削条件表は切削条件の目安を示すものです。実際の加工では加工形状、目的、使用機械等により条件を調整してください。
 ③上記の切削条件は2枚刃の場合を示します。4枚刃は、送り速度を1.5倍にしてください。
 ④ロング刃の場合は回転数、送り速度とも約50%以下にしてください。

- [Note]** ① Use the appropriate coolant for the work material and machining shape.
 ② These Recommended Cutting Conditions indicate only the rule of a thumb for the cutting conditions. In actual machining, the condition should be adjusted according to the machining shape, purpose and the machine type.
 ③ The cutting conditions given above is applied to 2-flute type end mills. As for 4-flute type, increase the feed speed by 1.5 times.
 ④ As for the long length type end mills, decrease the revolution number and the feed speed to not more than 50%.

HESL4 (注①)

4枚刃・ロング刃長
4ft, Long

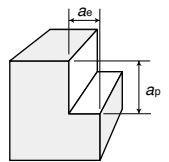

<側面切削> Side milling

被削材 Work material	鋳鉄 炭素鋼 Cast irons Carbon steels (200Hb以下) FC200, SS400, S45C		合金鋼 Alloy steels (200~250HB) SCM, SNCM		工具鋼 ステンレス鋼 Tool steels Stainless steels (25~35HRC) SKD, SKT, SUS304		焼入れ鋼 プリハードン鋼 Hardened steels Pre-hardened steels (35~45HRC) SKD, SKT, HPM1, NAK55		耐熱鋼 チタン合金 Heat-resistant steels Titanium alloys Inconel Ti-6Al-4V		アルミ合金 非鉄金属 Aluminum alloys Non-ferrous	
	切込み Depth of cut (mm)	$a_p=1.5DC$ $a_e=0.1DC$	$a_p=1.5DC$ $a_e=0.1DC$	$a_p=1.5DC$ $a_e=0.1DC$	$a_p=1.5DC$ $a_e=0.1DC$	$a_p=1.5DC$ $a_e=0.1DC$	$a_p=1.5DC$ $a_e=0.1DC$	$a_p=1.5DC$ $a_e=0.1DC$	$a_p=1.5DC$ $a_e=0.1DC$	$a_p=1.5DC$ $a_e=0.1DC$	$a_p=1.5DC$ $a_e=0.1DC$	$a_p=1.5DC$ $a_e=0.1DC$
外径DC Tool dia.(mm)	回転数n (min ⁻¹)	送り速度vf (mm/min)	回転数n (min ⁻¹)	送り速度vf (mm/min)	回転数n (min ⁻¹)	送り速度vf (mm/min)	回転数n (min ⁻¹)	送り速度vf (mm/min)	回転数n (min ⁻¹)	送り速度vf (mm/min)	回転数n (min ⁻¹)	送り速度vf (mm/min)
φ3	2,400	70	1,900	40	1,700	32	1,500	17	1,250	16	10,000	375
φ4	1,800	70	1,400	55	1,300	32	1,100	17	950	20	8,000	400
φ6	1,200	75	950	55	850	32	740	22	640	20	5,300	400
φ8	900	75	720	55	640	48	560	30	480	24	4,000	450
φ10	750	75	570	55	510	48	450	30	380	24	3,200	475
φ12	610	90	480	55	420	48	370	30	320	24	2,600	475
φ16	450	90	360	55	320	48	280	30	240	24	2,000	400
φ20	365	90	290	55	250	48	220	30	190	24	1,600	400
φ25	300	60	230	40	200	48	180	30	150	24	1,300	325

- [注意]** ①被削材、加工形状に合わせて、適切なクーラントを使用してください。
 ②この標準切削条件表は切削条件の目安を示すものです。実際の加工では加工形状、目的、使用機械等により条件を調整してください。
 ③上記の切削条件は2枚刃の場合を示します。4枚刃は、送り速度を1.5倍にしてください。
 ④ロング刃は溝切削に適しません。

- [Note]** ① Use the appropriate coolant for the work material and machining shape.
 ② These Recommended Cutting Conditions indicate only the rule of a thumb for the cutting conditions. In actual machining, the condition should be adjusted according to the machining shape, purpose and the machine type.
 ③ The cutting conditions given above is applied to 2-flute type end mills. As for 4-flute type, increase the feed speed by 1.5 times.
 ④ The long length type is not suited to slotting.



刃先形状 : エポックターボミル Head type : Epoch Turbo Mill

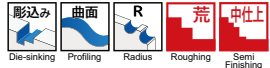

外径公差 Dia.tolerance	φ 12	: 0~-0.02
	φ 16、20	: 0~-0.03

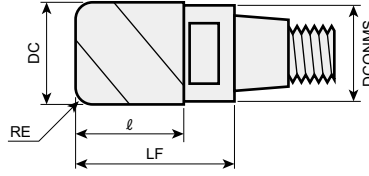

EHX-ETM4-TH

商品コード Item code	在庫 Stock	寸法 Size (mm)					刃数 No. of flutes	オイルホール Oil hole	希望小売 価格 (円) Suggested retail price (¥)
		外径 Tool dia. DC	コーナ半径 Corner radius RE	刃長 Flute length ℓ	全長 Overall length LF	首径 Neck dia. DCONMS			
EHX12-ETM4120-20-TH	●	12	2	12	19	11.7	4	—	18,860
EHX16-ETM4160-30-TH	●	16	3	16	24	15.5	4	—	30,270
EHX20-ETM4200-30-TH	●	20	3	20	30	19.5	4	—	40,130

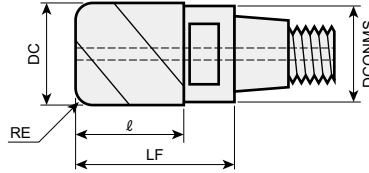

EHX-H-ETM4-TH

オイルホール付き
With oil hole

商品コード Item code	在庫 Stock	寸法 Size (mm)					刃数 No. of flutes	オイルホール Oil hole	希望小売 価格 (円) Suggested retail price (¥)
		外径 Tool dia. DC	コーナ半径 Corner radius RE	刃長 Flute length ℓ	全長 Overall length LF	首径 Neck dia. DCONMS			
EHX12H-ETM4120-20-TH	●	12	2	12	19	11.7	4	○	21,660
EHX16H-ETM4160-30-TH	●	16	3	16	24	15.5	4	○	34,850
EHX20H-ETM4200-30-TH	●	20	3	20	30	19.5	4	○	46,110

刃先形状 : エポック21

Head type : Epoch21

高硬度材の高速切削

High-speed cutting for high hardness materials is possible



外径公差 Dia.tolerance	φ 12	: 0~-0.02
	φ 16、20	: 0~-0.03

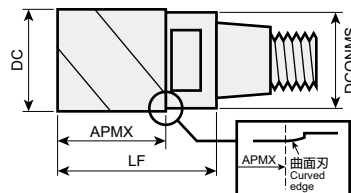

EHX-CEPR6-TH

商品コード Item code	在庫 Stock	寸法 Size (mm)					刃数 No. of flutes	オイルホール Oil hole	希望小売 価格 (円) Suggested retail price (¥)
		外径 Tool dia. DC	コーナ半径 Corner radius RE	刃長 Flute length APMX	全長 Overall length LF	首径 Neck dia. DCONMS			
EHX12-CEPR6120-TH	●	12	—	12	19	11.7	6	—	18,860
EHX16-CEPR6160-TH	●	16	—	16	24	15.5	6	—	29,330
EHX20-CEPR6200-TH	●	20	—	20	30	19.5	6	—	41,770

● : 標準在庫品です。 ● : Stocked items.

刃先形状：エポックパワーミル Head type : Epoch Power Mill



外径公差 Dia tolerance
 φ 12 : 0~-0.02
 φ 16, 20: 0~-0.03 (mm)

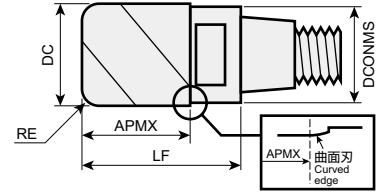
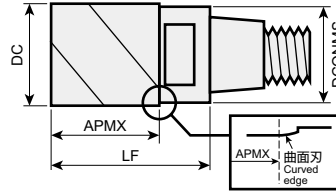

EHX○○-**EPP4**○○○○-○○-**TH**

超硬 Carbide **ATH** 傾斜14度 Helix angle 切削条件表 A404 Cutting Conditions

商品コード Item code	在庫 Stock	寸法 Size (mm)					刃数 No. of flutes	オイルホール Oil hole	希望小売 価格 (円) Suggested retail price (¥)
		外径 Tool dia.	コーナ半径 Corner radius	刃長 Flute length	全長 Overall length	首径 Neck dia.			
		DC	RE	APMX	LF	DCONMS			
EHX12-EPP4120-TH	●	12	—	9.6	19	11.7	4	—	16,390
EHX12-EPP4120-05-TH	●		0.5	9.6	19	11.7	4	—	19,530
EHX12-EPP4120-10-TH	●		1	9.6	19	11.7	4	—	19,530
EHX12-EPP4120-15-TH	●		1.5	9.6	19	11.7	4	—	19,530
EHX12-EPP4120-20-TH	●		2	9.6	19	11.7	4	—	19,530
EHX12-EPP4120-30-TH	●		3	9.6	19	11.7	4	—	19,530
EHX16-EPP4160-TH	●	16	—	12.8	24	15.5	4	—	28,510
EHX16-EPP4160-10-TH	●		1	12.8	24	15.5	4	—	30,500
EHX16-EPP4160-15-TH	●		1.5	12.8	24	15.5	4	—	30,500
EHX16-EPP4160-20-TH	●		2	12.8	24	15.5	4	—	30,500
EHX16-EPP4160-30-TH	●		3	12.8	24	15.5	4	—	30,500
EHX20-EPP4200-TH	●	20	—	16	30	19.5	4	—	39,190
EHX20-EPP4200-10-TH	●		1	16	30	19.5	4	—	41,190
EHX20-EPP4200-15-TH	●		1.5	16	30	19.5	4	—	41,190
EHX20-EPP4200-20-TH	●		2	16	30	19.5	4	—	41,190
EHX20-EPP4200-30-TH	●		3	16	30	19.5	4	—	41,190

○ EHX(H)-ETM、EHX-EPPの対応被削材

Applicable work material of EHX(H)-ETM, EHX-EPP

炭素鋼 合金鋼 Carbon steel Alloy steel	プリハー ド鋼 Pre-hardened steel	高硬度 Hardened steel			ステン レス鋼 Stainless steel	チタン合金 耐熱合金 Titanium alloy Heat-resistant alloy	銅合金 Copper alloy	アルミ 合金 Aluminum alloy
○	○	> 45HRC ≤ 55HRC	> 55HRC ≤ 65HRC	> 65HRC	○	○	○	

○ EHX-CEPRの対応被削材

Applicable work material of EHX-CEPR

炭素鋼 合金鋼 Carbon steel Alloy steel	プリハー ド鋼 Pre-hardened steel	高硬度 Hardened steel			ステン レス鋼 Stainless steel	チタン合金 耐熱合金 Titanium alloy Heat-resistant alloy	銅合金 Copper alloy	アルミ 合金 Aluminum alloy
○	○	> 45HRC ≤ 55HRC	> 55HRC ≤ 65HRC	> 65HRC	○	○	○	

○ 再研磨対応外径範囲

Re-grinding compatibility range

商品コード Item code	外周 Outer dia. (mm)	エンド End (mm)
EHX-ETM-TH	× (N/A)	12 ~ 20
EHX-H-ETM-TH	× (N/A)	12 ~ 20
EHX-CEPR-TH	12 ~ 20	12 ~ 20
EHX-EPP-TH	12 ~ 20	12 ~ 20

金型加工用ヘッド交換式エンドミル EHX エンドミルシリーズ

超硬ホルダ Carbide Holder

アンダーカットタイプ

Under cut type

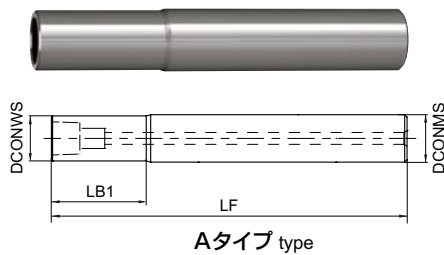

ストレートタイプ

Straight type

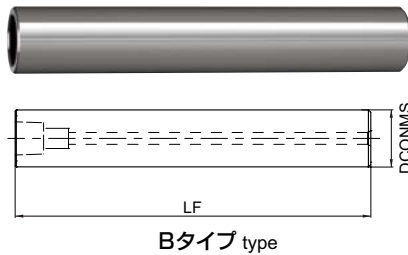

ペンシルネックタイプ

Pencil neck type

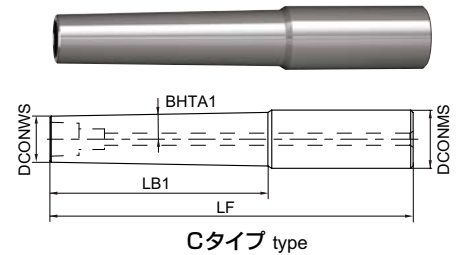

EHX○○-○○-○○-○○-ASC



商品コード Item code	在庫 Stock	対応ヘッド Head	首角度 Neck angle (°)	首下長 Under neck length (mm)	先端首径 Tip neck angle (mm)	全長 Overall length (mm)	シャンク径 Shank dia. (mm)	形状 Shape	スパナ Spanner	希望小売価格 (円) Suggested retail price (¥)
			BHTA1	LB1	DCONWS	LF	DCONMS			
EHX12-12-80-17-ASC	●	EHX12	—	17	11.7	80	12	A	EHX12-SN	67,580
EHX12-12-100-ASC	●		—	—	—	100	12	B		74,380
EHX12-12-100-41-ASC	●		—	41	11.7	100	12	A		74,380
EHX12-12-130-ASC	●		—	—	—	130	12	B		85,050
EHX12-12-130-65-ASC	●		—	65	11.7	130	12	A		85,050
EHX12-12-150-89-ASC	●		—	89	11.7	150	12	A		94,790
EHX12-16-130-65-ASC	●		1°	65	11.7	130	16	C		98,310
EHX12-16-150-91-ASC	●		1°	91	11.7	150	16	C		109,220
EHX16-16-80-24-ASC	●	EHX16	—	24	15.5	80	16	A	EHX16-SN	79,180
EHX16-16-110-ASC	●		—	—	—	110	16	B		89,390
EHX16-16-110-56-ASC	●		—	56	15.5	110	16	A		89,390
EHX16-16-150-ASC	●		—	—	—	150	16	B		101,240
EHX16-16-150-88-ASC	●		—	88	15.5	150	16	A		101,240
EHX16-20-150-88-ASC	●		1°	88	15.5	150	20	C		119,650
EHX16-20-180-116-ASC	●		1°	116	15.5	180	20	C		132,550
EHX20-20-90-30-ASC	●	EHX20	—	30	19.5	90	20	A	EHX20-SN	91,970
EHX20-20-130-ASC	●		—	—	—	130	20	B		106,520
EHX20-20-130-70-ASC	●		—	70	19.5	130	20	A		106,520
EHX20-20-180-ASC	●		—	—	—	180	20	B		126,690
EHX20-20-180-110-ASC	●		—	110	19.5	180	20	A		126,690
EHX20-25-180-110-ASC	●		1°	110	19.5	180	25	C		150,150

※超硬ホルダにはスパナが付属しています。また、スパナ単体でも販売しております。

A spanner is attached to the carbide holder. Can be sold even by spanner only.

商品コード Item code	在庫 Stock	スパナ Spanner	締付けトルク Fastening torque	希望小売価格 (円) Suggested retail price (¥)	
EHX12-SN	●		EHX12用スパナ Spanner for EHX12	15N・m	2,940
EHX16-SN	●		EHX16用スパナ Spanner for EHX16	30N・m	3,060
EHX20-SN	●		EHX20用スパナ Spanner for EHX20	50N・m	3,440

●：標準在庫品です。 ●：Stocked items.

○ ヘッド取付け要領 How to Install the Head

1 きれいなウエスなどで、ヘッド／ホルダのテーパ面／端面の油分・ほこりなどを取り除いてください。
Using a clean cloth, wipe away oil and dust from the taper and end surfaces of the head and holder.



2 締め付ける際、刃先に直接素手で触れるとけがをする可能性があるため、保護手袋など保護具を使用してください。すきまが残った状態から付属のスパナを使用して、ヘッドとホルダの端面が密着するまで締め付けてください。
Be careful to avoid the possibility of cutting hands when fastening with bare hands directly near the blade tip. Securely fasten the head and holder end surfaces using the enclosed spanner to close off any remaining gap.

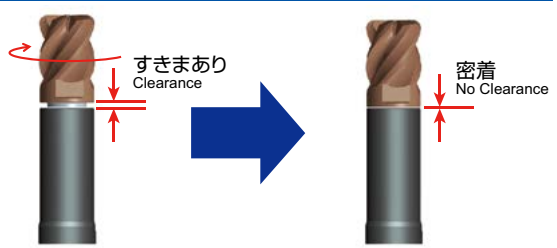

3 必要となる推奨トルクに達する角度は右表を参考にしてください。より厳密に管理する場合はトルクレンチを使って、右表のトルクで締め付けてください。
Refer to the table at right regarding angles for recommended torque when necessary. For stricter usage, refer to the table right for torque wrench fastening.

対応ヘッド Suitable head	参考締め付け角 α Reference tightening angle α	推奨締め付けトルク Recommended fastening Torque
EHX12	50°	15N·m
EHX16	50°	30N·m
EHX20	40°	50N·m

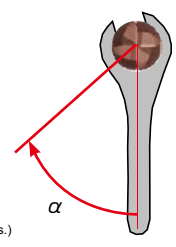

注) 付属のスパナをご使用ください。
(一般のスパナとは厚みが異なります)
(Note) Use the enclosed spanner only. (Typical spanners differ in thickness.)

○ 振れ精度・ヘッド交換精度 Run-out accuracy and head exchange accuracy

外周刃の振れ Run-out accuracy for the peripheral cutting edge	ヘッド交換精度 (軸方向) Head exchange accuracy (Axial)
0.015mm	±0.02mm

※超硬ホルダを使用した場合
ヘッド交換精度とはヘッド全長(L)の公差を表します
※Use the carbide holder
Head exchange accuracy is the tolerance of the overall length for the head (L).

○ EHX 超硬ホルダの使い分け How to Select EHX Holders

ストレートタイプ Straight type

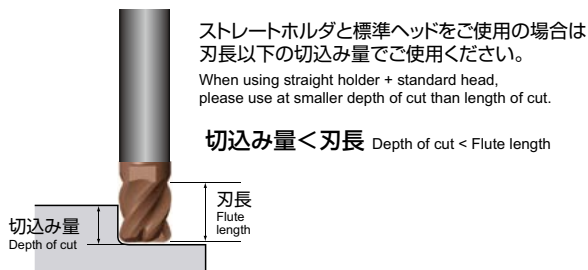

- ストレートタイプは、ホルダ径=ヘッド径のため、刃長以上の切込み量では干渉が発生します。
 - アンダーカットタイプは、首めすみが付いているので立壁の加工に適しています。
 - ペンシルネックは、首径が太くなっているため剛性が高く、深彫り加工において安定加工が可能です。
- When using straight holder + standard head, interference will occur in cases where the depth of cut is larger than the length of cut of the head.
• Under cut type with relieved neck is suitable for vertical wall machining.
• The large diameter of the pencil neck holder provides stability in long overhang applications.

アンダーカットタイプ Under cut type

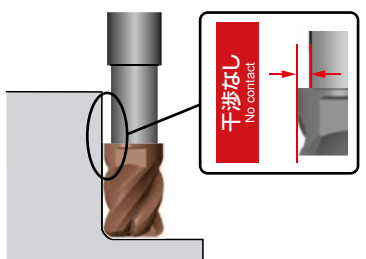

ペンシルネックタイプ Pencil neck type

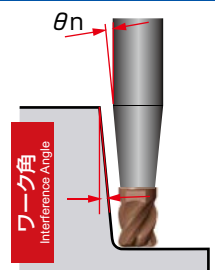

金型加工用ヘッド交換式エンドミル EHX エンドミルシリーズ

標準切削条件表 Recommended cutting conditions

EHX-ETM-TH | EHX-H-ETM-TH

一般条件 (低速・高送り) Standard condition (Low speed, High feed)

被削材 Work material	炭素鋼・合金鋼 Carbon steels, Alloy steels (180~250HB)				工具鋼 Tool steels (25~35HRC)				プリハードン鋼 Pre-hardened steels (35~45HRC)				焼入れ鋼 Hardened steels (45~55HRC)				焼入れ鋼 Hardened steels (55~60HRC)																							
切削速度 Cutting speed	vc=75m/min								vc=70m/min								vc=65m/min								vc=50m/min								vc=50m/min							
外径DC× コーナ半径RE Tool dia.(mm)	回転数 n (min ⁻¹)	送り速度 Vf (mm/min)	ap (mm)	ae (mm)	回転数 n (min ⁻¹)	送り速度 Vf (mm/min)	ap (mm)	ae (mm)	回転数 n (min ⁻¹)	送り速度 Vf (mm/min)	ap (mm)	ae (mm)	回転数 n (min ⁻¹)	送り速度 Vf (mm/min)	ap (mm)	ae (mm)	回転数 n (min ⁻¹)	送り速度 Vf (mm/min)	ap (mm)	ae (mm)	回転数 n (min ⁻¹)	送り速度 Vf (mm/min)	ap (mm)	ae (mm)																
φ12×RE2	2,000	6,380	0.48	≤6	1,900	5,540	0.48	≤6	1,700	3,880	0.48	≤6	1,300	2,960	0.34	≤6	1,300	1,190	0.24	≤6																				
φ16×RE3	1,500	5,380	0.72	≤8	1,400	4,590	0.72	≤8	1,300	3,330	0.72	≤8	1,000	2,560	0.5	≤8	1,000	1,020	0.36	≤8																				
φ20×RE3	1,200	4,370	0.72	≤10	1,100	3,660	0.72	≤10	1,000	2,600	0.72	≤10	800	2,080	0.5	≤10	800	830	0.36	≤10																				

高速条件 (高速・高送り) High speed condition (High speed, High feed)

被削材 Work material	炭素鋼・合金鋼 Carbon steels, Alloy steels (180~250HB)				工具鋼 Tool steels (25~35HRC)				プリハードン鋼 Pre-hardened steels (35~45HRC)				焼入れ鋼 Hardened steels (45~55HRC)				焼入れ鋼 Hardened steels (55~60HRC)																							
切削速度 Cutting speed	vc=125m/min								vc=110m/min								vc=100m/min								vc=80m/min								vc=70m/min							
外径DC× コーナ半径RE Tool dia.(mm)	回転数 n (min ⁻¹)	送り速度 Vf (mm/min)	ap (mm)	ae (mm)	回転数 n (min ⁻¹)	送り速度 Vf (mm/min)	ap (mm)	ae (mm)	回転数 n (min ⁻¹)	送り速度 Vf (mm/min)	ap (mm)	ae (mm)	回転数 n (min ⁻¹)	送り速度 Vf (mm/min)	ap (mm)	ae (mm)	回転数 n (min ⁻¹)	送り速度 Vf (mm/min)	ap (mm)	ae (mm)	回転数 n (min ⁻¹)	送り速度 Vf (mm/min)	ap (mm)	ae (mm)																
φ12×RE2	3,300	10,530	0.38	≤6	2,900	8,460	0.38	≤6	2,700	6,160	0.34	≤6	2,100	4,790	0.29	≤6	1,900	1,730	0.19	≤6																				
φ16×RE3	2,500	8,960	0.57	≤8	2,200	7,210	0.57	≤8	2,000	5,120	0.51	≤8	1,600	4,100	0.44	≤8	1,400	1,430	0.29	≤8																				
φ20×RE3	2,000	7,280	0.57	≤10	1,800	5,990	0.57	≤10	1,600	4,160	0.51	≤10	1,300	3,380	0.44	≤10	1,100	1,140	0.29	≤10																				

- 【注意】** ①被削材、加工形状に合わせて、適切なクーラントを使用してください。
 ②できるだけ高剛性、高精度の機械をご使用ください。
 ③この切削条件表は切削条件の目安を示すものです。実際の加工では加工形状、目的、使用機械等により条件を調整してください。
 ④機械の回転数が足りない場合は、回転数と送り速度を同じ比率で下げてください。

- 【Note】** ① Use the appropriate coolant for the work material and machining shape.
 ② Use a highly rigid and accurate machine as possible.
 ③ These Recommended Cutting Conditions indicate only the rule of a thumb for the cutting conditions. In actual machining, the condition should be adjusted according to the machining shape, purpose and the machine type.
 ④ If the rpm available is lower than that recommended please reduce the feed rate to the same ratio.

	5DC	6DC	7DC	8DC	9DC	10DC
切削速度 Cutting speed	100%	100%	100%	100%	100%	100%
1刃送り Feed per tooth	100%	100%	100%	100%	100%	100%
ap	100%	90%	83%	77%	63%	50%
ae	100%	100%	100%	100%	100%	100%

突き出し長が長いホルダをご使用の場合は、上表の補正率を加味してご使用ください。

When using a holder with a long overhang length, please use the correction factor of the above table in consideration.

EHX-CEPR-TH

側面切削 Side milling

被削材 Work material	炭素鋼・合金鋼 Carbon steels, Alloy steels (180~250HB)				工具鋼 Tool steels (25~35HRC)				プリハードン鋼 Pre-hardened steels (35~45HRC)				焼入れ鋼 Hardened steels (45~55HRC)				焼入れ鋼 Hardened steels (55~60HRC)			
切削速度 Cutting speed	$v_c=250\text{m/min}$				$v_c=250\text{m/min}$				$v_c=250\text{m/min}$				$v_c=200\text{m/min}$				$v_c=150\text{m/min}$			
外径DC Tool dia. (mm)	回転数 n (min^{-1})	送り速度 v_f (mm/min)	a_p (mm)	a_e (mm)	回転数 n (min^{-1})	送り速度 v_f (mm/min)	a_p (mm)	a_e (mm)	回転数 n (min^{-1})	送り速度 v_f (mm/min)	a_p (mm)	a_e (mm)	回転数 n (min^{-1})	送り速度 v_f (mm/min)	a_p (mm)	a_e (mm)	回転数 n (min^{-1})	送り速度 v_f (mm/min)	a_p (mm)	a_e (mm)
$\phi 12$	6,600	5,420	12	1.2	6,600	4,510	12	1.2	6,600	4,060	12	0.6	5,300	2,900	12	0.36	4,000	1,920	12	0.24
$\phi 16$	5,000	5,180	16	1.6	5,000	4,320	16	1.6	5,000	3,890	16	0.8	4,000	2,760	16	0.48	3,000	1,810	16	0.32
$\phi 20$	4,000	4,900	20	2	4,000	4,080	20	2	4,000	3,670	20	1	3,200	2,610	20	0.6	2,400	1,710	20	0.4

- 【注意】** ①被削材、加工形状に合わせて、適切なクーラントを使用してください。
 ②できるだけ高剛性、高精度の機械をご使用ください。
 ③この切削条件表は切削条件の目安を示すものです。実際の加工では加工形状、目的、使用機械等により条件を調整してください。
 ④機械の回転数が足りない場合は、回転数と送り速度を同じ比率で下げてください。

- 【Note】** ① Use the appropriate coolant for the work material and machining shape.
 ② Use a highly rigid and accurate machine as possible.
 ③ These Recommended Cutting Conditions indicate only the rule of a thumb for the cutting conditions. In actual machining, the condition should be adjusted according to the machining shape, purpose and the machine type.
 ④ If the rpm available is lower than that recommended please reduce the feed rate to the same ratio.

	4DC 以下 4DC or less	6DC 以下 6DC or less	8DC 以下 8DC or less	10DC 以下 10DC or less
切削速度 Cutting speed	100%	100~70%	70~50%	50~30%
1 刃送り Feed per tooth	100%	100~90%	90~80%	80~70%
a_p	100%	100%	100%	100%
a_e	100%	90~50%	50~30%	30~10%

突き出し長が長いホルダをご使用の場合は、上表の補正率を加味してご使用ください。
 When using a holder with a long overhang length, please use the correction factor of the above table in consideration.

金型加工用ヘッド交換式エンドミル EHX エンドミルシリーズ

EHX-EPP-TH

側面切削 Side milling

被削材 Work material	炭素鋼・合金鋼 Carbon steels, Alloy steels (180~250HB)				工具鋼 Tool steels (25~35HRC)				プリハードン鋼 Pre-hardened steels (35~45HRC)				焼入れ鋼 Hardened steels (45~55HRC)			
切削速度 Cutting speed	$v_c=180\text{m/min}$				$v_c=165\text{m/min}$				$v_c=140\text{m/min}$				$v_c=120\text{m/min}$			
外径DC Tool dia. (mm)	回転数 n (min^{-1})	送り速度 v_f (mm/min)	a_p (mm)	a_e (mm)	回転数 n (min^{-1})	送り速度 v_f (mm/min)	a_p (mm)	a_e (mm)	回転数 n (min^{-1})	送り速度 v_f (mm/min)	a_p (mm)	a_e (mm)	回転数 n (min^{-1})	送り速度 v_f (mm/min)	a_p (mm)	a_e (mm)
$\phi 12$	4,800	1,750	9.6	1.2	4,400	1,200	9.6	1.2	3,700	1,010	9.6	0.9	3,200	730	9.6	0.6
$\phi 16$	3,600	1,470	12.8	1.6	3,300	1,010	12.8	1.6	2,800	860	12.8	1.2	2,400	610	12.8	0.8
$\phi 20$	2,900	1,580	16	2	2,600	1,060	16	2	2,200	900	16	1.5	1,900	650	16	1

	4DC以下 4DC or less	6DC以下 6DC or less	8DC以下 8DC or less	10DC以下 10DC or less
切削速度 Cutting speed	100%	100 ~ 70%	70 ~ 50%	50 ~ 30%
1刃送り Feed per tooth	100%	100 ~ 90%	90 ~ 80%	80 ~ 70%
a_p	100%	100%	100%	100%
a_e	100%	90 ~ 50%	50 ~ 30%	30 ~ 10%

突き出し長が長いホルダをご使用の場合は、上表の補正率を加味してご使用ください。

When using a holder with a long overhang length, please use the correction factor of the above table in consideration.

溝切削 Slotting

被削材 Work material	炭素鋼・合金鋼 Carbon steels, Alloy steels (180~250HB)				工具鋼 Tool steels (25~35HRC)				プリハードン鋼 Pre-hardened steels (35~45HRC)				焼入れ鋼 Hardened steels (45~55HRC)			
切削速度 Cutting speed	$v_c=60\text{m/min}$				$v_c=60\text{m/min}$				$v_c=55\text{m/min}$				$v_c=50\text{m/min}$			
外径DC Tool dia. (mm)	回転数 n (min^{-1})	送り速度 v_f (mm/min)	a_p (mm)	a_e (mm)	回転数 n (min^{-1})	送り速度 v_f (mm/min)	a_p (mm)	a_e (mm)	回転数 n (min^{-1})	送り速度 v_f (mm/min)	a_p (mm)	a_e (mm)	回転数 n (min^{-1})	送り速度 v_f (mm/min)	a_p (mm)	a_e (mm)
$\phi 12$	1,600	580	6	12	1,600	440	6	12	1,500	410	4.8	12	1,300	240	2.4	12
$\phi 16$	1,200	490	8	16	1,200	370	8	16	1,100	340	6.4	16	1,000	200	3.2	16
$\phi 20$	1,000	540	10	20	1,000	410	10	20	900	370	8	20	800	220	4	20

	4DC以下 4DC or less	6DC以下 6DC or less	8DC以下 8DC or less	10DC以下 10DC or less
切削速度 Cutting speed	100%	100 ~ 70%	70 ~ 50%	50 ~ 30%
1刃送り Feed per tooth	100%	100 ~ 90%	90 ~ 80%	80 ~ 70%
a_p	100%	90 ~ 50%	50 ~ 30%	30 ~ 10%

突き出し長が長いホルダをご使用の場合は、上表の補正率を加味してご使用ください。

When using a holder with a long overhang length, please use the correction factor of the above table in consideration.

- [注意]**
- ①被削材、加工形状に合わせて、適切なクーラントを使用してください。
 - ②できるだけ高剛性、高精度の機械をご使用ください。
 - ③この切削条件表は切削条件の目安を示すものです。実際の加工では加工形状、目的、使用機械等により条件を調整してください。
 - ④機械の回転数が足りない場合は、回転数と送り速度を同じ比率で下げてください。

- [Note]**
- ① Use the appropriate coolant for the work material and machining shape.
 - ② Use a highly rigid and accurate machine as possible.
 - ③ These Recommended Cutting Conditions indicate only the rule of a thumb for the cutting conditions. In actual machining, the condition should be adjusted according to the machining shape, purpose and the machine type.
 - ④ If the rpm available is lower than that recommended please reduce the feed rate to the same ratio.

Epoch Deep Ball エポックディープボール

2枚刃
2Flutes



ストレートネック

Straight neck



RE ≤ 0.25 : ±0.003
0.25 < RE : ±0.005



(mm)

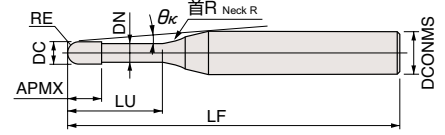

EPDB2○○○-○○(-TH)



商品コード Item code	在庫 Stock	商品コード Item code	在庫 Stock	寸法 Size(mm)							干渉角度 Interference angle θ _c	勾配角に対する実有効首下長 The effective under-neck length for the various draft angles					
				ボール半径 Ball radius RE	外径 Tool dia. DC	首下長 Under neck length LU	刃長 Flute length APMX	首径 Neck dia. DN	全長 Overall length LF	シャンク径 Shank dia. DCONMS		首R Neck R	0.5°	1°	1.5°	2°	3°
EPDB2001-0.2	<input type="checkbox"/>	EPDB2001-0.2-TH	<input type="checkbox"/>	0.05	0.1	0.2	0.08	0.08	45	4	1	11.76	0.35	0.37	0.39	0.41	0.44
EPDB2001-0.3	<input type="checkbox"/>	EPDB2001-0.3-TH	<input type="checkbox"/>			0.3	0.08	0.08	45	4	1	11.64	0.46	0.48	0.5	0.53	0.57
EPDB2001-0.5	<input type="checkbox"/>	EPDB2001-0.5-TH	<input type="checkbox"/>			0.5	0.08	0.08	45	4	1	11.4	0.67	0.7	0.73	0.76	0.81
EPDB2002-0.5	<input type="checkbox"/>	EPDB2002-0.5-TH	<input type="checkbox"/>	0.1	0.2	0.5	0.15	0.17	50	4	10	11.42	1.2	1.35	1.52	1.68	2.01
EPDB2002-1	<input type="checkbox"/>	EPDB2002-1-TH	<input type="checkbox"/>			1	0.15	0.17	50	4	10	10.86	1.76	1.97	2.17	2.37	2.74
EPDB2002-1.5	<input type="checkbox"/>	EPDB2002-1.5-TH	<input type="checkbox"/>			1.5	0.15	0.17	50	4	10	10.35	2.32	2.57	2.8	3.02	3.44
EPDB2002-2	<input type="checkbox"/>	EPDB2002-2-TH	<input type="checkbox"/>			2	0.15	0.17	50	4	10	9.88	2.88	3.16	3.42	3.66	4.11
EPDB2002-2.5	<input type="checkbox"/>	EPDB2002-2.5-TH	<input type="checkbox"/>			2.5	0.15	0.17	50	4	10	9.46	3.43	3.75	4.03	4.28	4.76
EPDB2002-3	<input type="checkbox"/>	EPDB2002-3-TH	<input type="checkbox"/>			3	0.15	0.17	50	4	10	9.07	3.98	4.33	4.62	4.9	5.4
EPDB2003-1	<input type="checkbox"/>	EPDB2003-1-TH	<input type="checkbox"/>	0.15	0.3	1	0.25	0.27	50	4	10	10.89	1.76	1.96	2.16	2.35	2.72
EPDB2003-1.5	<input type="checkbox"/>	EPDB2003-1.5-TH	<input type="checkbox"/>			1.5	0.25	0.27	50	4	10	10.36	2.32	2.56	2.79	3.01	3.42
EPDB2003-2	<input type="checkbox"/>	EPDB2003-2-TH	<input type="checkbox"/>			2	0.25	0.27	50	4	10	9.88	2.88	3.16	3.41	3.65	4.09
EPDB2003-2.5	<input type="checkbox"/>	EPDB2003-2.5-TH	<input type="checkbox"/>			2.5	0.25	0.27	50	4	10	9.45	3.43	3.74	4.02	4.27	4.74
EPDB2003-3	<input type="checkbox"/>	EPDB2003-3-TH	<input type="checkbox"/>	3	0.25	0.27	50	4	10	9.05	3.98	4.32	4.62	4.89	5.39		
EPDB2004-1	<input type="checkbox"/>	EPDB2004-1-TH	<input type="checkbox"/>	0.2	0.4	1	0.3	0.37	50	4	10	10.91	1.75	1.95	2.14	2.33	2.7
EPDB2004-1.5	<input type="checkbox"/>	EPDB2004-1.5-TH	<input type="checkbox"/>			1.5	0.3	0.37	50	4	10	10.37	2.31	2.55	2.78	2.99	3.4
EPDB2004-2	<input type="checkbox"/>	EPDB2004-2-TH	<input type="checkbox"/>			2	0.3	0.37	50	4	10	9.88	2.87	3.15	3.4	3.63	4.07
EPDB2004-2.5	<input type="checkbox"/>	EPDB2004-2.5-TH	<input type="checkbox"/>			2.5	0.3	0.37	50	4	10	9.43	3.42	3.73	4.01	4.26	4.73
EPDB2004-3	<input type="checkbox"/>	EPDB2004-3-TH	<input type="checkbox"/>			3	0.3	0.37	50	4	10	9.03	3.97	4.31	4.61	4.88	5.37
EPDB2004-3.5	<input type="checkbox"/>	EPDB2004-3.5-TH	<input type="checkbox"/>			3.5	0.3	0.37	50	4	10	8.65	4.52	4.88	5.2	5.48	6
EPDB2004-4	<input type="checkbox"/>	EPDB2004-4-TH	<input type="checkbox"/>	4	0.3	0.37	50	4	10	8.3	5.07	5.45	5.79	6.09	6.63		
EPDB2004-4.5	<input type="checkbox"/>	EPDB2004-4.5-TH	<input type="checkbox"/>	4.5	0.3	0.37	50	4	10	7.99	5.61	6.02	6.37	6.68	7.24		
EPDB2005-1	<input type="checkbox"/>	EPDB2005-1-TH	<input type="checkbox"/>	0.25	0.5	1	0.35	0.47	50	4	10	10.94	1.74	1.94	2.13	2.31	2.68
EPDB2005-2	<input type="checkbox"/>	EPDB2005-2-TH	<input type="checkbox"/>			2	0.35	0.47	50	4	10	9.88	2.86	3.14	3.39	3.62	4.06
EPDB2005-3	<input type="checkbox"/>	EPDB2005-3-TH	<input type="checkbox"/>			3	0.35	0.47	50	4	10	9	3.97	4.3	4.6	4.87	5.36
EPDB2005-4	<input type="checkbox"/>	EPDB2005-4-TH	<input type="checkbox"/>			4	0.35	0.47	50	4	10	8.27	5.06	5.45	5.78	6.08	6.61
EPDB2005-5	<input type="checkbox"/>	EPDB2005-5-TH	<input type="checkbox"/>			5	0.35	0.47	50	4	10	7.64	6.15	6.57	6.94	7.26	7.84
EPDB2005-5.5	<input type="checkbox"/>	EPDB2005-5.5-TH	<input type="checkbox"/>			5.5	0.35	0.47	50	4	10	7.36	6.69	7.13	7.51	7.85	8.45
EPDB2005-6	<input type="checkbox"/>	EPDB2005-6-TH	<input type="checkbox"/>	6	0.35	0.47	50	4	10	7.1	7.23	7.69	8.08	8.43	9.05		
EPDB2005-8	<input type="checkbox"/>	EPDB2005-8-TH	<input type="checkbox"/>	8	0.35	0.47	50	4	10	6.23	9.37	9.9	10.34	10.73	11.41		
EPDB2006-1	<input type="checkbox"/>	EPDB2006-1-TH	<input type="checkbox"/>	0.3	0.6	1	0.4	0.57	50	4	10	10.98	1.74	1.93	2.11	2.3	2.66
EPDB2006-2	<input type="checkbox"/>	EPDB2006-2-TH	<input type="checkbox"/>			2	0.4	0.57	50	4	10	9.88	2.86	3.13	3.38	3.61	4.04
EPDB2006-3	<input type="checkbox"/>	EPDB2006-3-TH	<input type="checkbox"/>			3	0.4	0.57	50	4	10	8.98	3.96	4.3	4.59	4.85	5.35
EPDB2006-4	<input type="checkbox"/>	EPDB2006-4-TH	<input type="checkbox"/>			4	0.4	0.57	50	4	10	8.22	5.06	5.44	5.77	6.07	6.6
EPDB2006-5	<input type="checkbox"/>	EPDB2006-5-TH	<input type="checkbox"/>			5	0.4	0.57	50	4	10	7.59	6.14	6.57	6.93	7.25	7.83
EPDB2006-6	<input type="checkbox"/>	EPDB2006-6-TH	<input type="checkbox"/>			6	0.4	0.57	50	4	10	7.04	7.22	7.69	8.08	8.42	9.04
EPDB2006-7	<input type="checkbox"/>	EPDB2006-7-TH	<input type="checkbox"/>			7	0.4	0.57	50	4	10	6.57	8.3	8.8	9.21	9.58	10.22
EPDB2006-8	<input type="checkbox"/>	EPDB2006-8-TH	<input type="checkbox"/>			8	0.4	0.57	50	4	10	6.16	9.36	9.9	10.34	10.72	11.4
EPDB2006-9	<input type="checkbox"/>	EPDB2006-9-TH	<input type="checkbox"/>			9	0.4	0.57	50	4	10	5.79	10.43	10.99	11.46	11.86	12.56
EPDB2006-10	<input type="checkbox"/>	EPDB2006-10-TH	<input type="checkbox"/>			10	0.4	0.57	50	4	10	5.47	11.49	12.09	12.57	12.99	13.72
EPDB2006-12	<input type="checkbox"/>	EPDB2006-12-TH	<input type="checkbox"/>			12	0.4	0.57	50	4	10	4.92	13.61	14.26	14.78	15.23	16
EPDB2008-2	<input type="checkbox"/>	EPDB2008-2-TH	<input type="checkbox"/>			0.4	0.8	2	0.5	0.77	50	4	10	9.87	2.85	3.11	3.35
EPDB2008-4	<input type="checkbox"/>	EPDB2008-4-TH	<input type="checkbox"/>	4	0.5			0.77	50	4	10	8.14	5.05	5.43	5.75	6.05	6.58
EPDB2008-5	<input type="checkbox"/>	EPDB2008-5-TH	<input type="checkbox"/>	5	0.5			0.77	50	4	10	7.48	6.13	6.56	6.91	7.24	7.81
EPDB2008-6	<input type="checkbox"/>	EPDB2008-6-TH	<input type="checkbox"/>	6	0.5			0.77	50	4	10	6.92	7.21	7.68	8.06	8.41	9.02
EPDB2008-8	<input type="checkbox"/>	EPDB2008-8-TH	<input type="checkbox"/>	8	0.5			0.77	50	4	10	6.01	9.36	9.89	10.33	10.71	11.38
EPDB2008-10	<input type="checkbox"/>	EPDB2008-10-TH	<input type="checkbox"/>	10	0.5			0.77	50	4	10	5.32	11.49	12.08	12.56	12.98	13.7
EPDB2010-2	<input type="checkbox"/>	EPDB2010-2-TH	<input type="checkbox"/>	0.5	1	2	0.8	0.96	50	4	10	9.84	2.9	3.15	3.37	3.59	4.01
EPDB2010-3	<input type="checkbox"/>	EPDB2010-3-TH	<input type="checkbox"/>			3	0.8	0.96	50	4	10	8.84	4	4.31	4.59	4.84	5.32
EPDB2010-4	<input type="checkbox"/>	EPDB2010-4-TH	<input type="checkbox"/>			4	0.8	0.96	50	4	10	8.02	5.09	5.45	5.77	6.06	6.58
EPDB2010-5	<input type="checkbox"/>	EPDB2010-5-TH	<input type="checkbox"/>			5	0.8	0.96	50	4	10	7.34	6.17	6.58	6.93	7.24	7.81
EPDB2010-6	<input type="checkbox"/>	EPDB2010-6-TH	<input type="checkbox"/>			6	0.8	0.96	50	4	10	6.77	7.25	7.7	8.08	8.41	9.02
EPDB2010-7	<input type="checkbox"/>	EPDB2010-7-TH	<input type="checkbox"/>			7	0.8	0.96	50	4	10	6.28	8.32	8.81	9.21	9.57	10.21
EPDB2010-8	<input type="checkbox"/>	EPDB2010-8-TH	<input type="checkbox"/>			8	0.8	0.96	50	4	10	5.85	9.39	9.91	10.34	10.72	11.38
EPDB2010-9	<input type="checkbox"/>	EPDB2010-9-TH	<input type="checkbox"/>			9	0.8	0.96	50	4	10	5.48	10.45	11	11.45	11.85	12.55
EPDB2010-10	<input type="checkbox"/>	EPDB2010-10-TH	<input type="checkbox"/>			10	0.8	0.96	50	4	10	5.15	11.52	12.09	12.57	12.98	13.7
EPDB2010-12	<input type="checkbox"/>	EPDB2010-12-TH	<input type="checkbox"/>			12	0.8	0.96	55	4	10	4.6	13.63	14.26	14.78	15.22	15.99
EPDB2010-14	<input type="checkbox"/>	EPDB2010-14-TH	<input type="checkbox"/>	14	0.8	0.96	55	4	10	4.16	15.74	16.42	16.97	17.44	18.54		
EPDB2010-16	<input type="checkbox"/>	EPDB2010-16-TH	<input type="checkbox"/>	16	0.8	0.96	55	4	10	3.79	17.84	18.56	19.14	19.64	21.2		
EPDB2010-18	<input type="checkbox"/>	EPDB2010-18-TH	<input type="checkbox"/>	18	0.8	0.96	60	4	10	3.49	19.93	20.7	21.31	21.83	23.85		
EPDB2010-20	<input type="checkbox"/>	EPDB2010-20-TH	<input type="checkbox"/>	20	0.8	0.96	60	4	10	3.23	22.02	22.83	23.47	24.01	26.51		
EPDB2012-8	<input type="checkbox"/>	EPDB2012-8-TH	<input type="checkbox"/>	0.6	1.2	8	1.1	1.15	50	4	10	5.67	9.42	9.93	10.35	10.72	11.38
EPDB2012-12	<input type="checkbox"/>	EPDB2012-12-TH	<input type="checkbox"/>			12	1.1	1.15	55	4	10	4.43	13.66	14.28	14.78	15.23	15.99

印：特定代理店在庫です。弊社営業へお問合せください。
：Stocked by specified distributor. Contact with our sales department.

THコーティング品を注文される場合は商品コードの末尾に-THをつけてください。
 When you want to order TH Coating items from us, please add the suffix -TH at the end of the item code.

Carbide End Mills

Stocked by Specified distributor

Epoch Deep Ball エポックディープボール

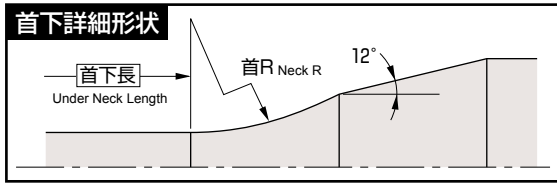
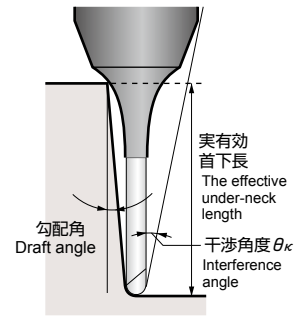

【注意】 加工物に勾配角がついている場合、干渉領域は、首下長さよりも長くなります。それぞれの勾配角に対する実有効首下長をご参照ください。
また、工具が加工物に干渉する角度を干渉角度 θ_{κ} で表示していますので合わせてご参照ください。

【Note】 If the workpiece has draft angle, the interference length will be longer than the under-neck length. Please refer to the effective under-neck length for the various draft angles.
In addition, the angle at which the tool will interfere with the workpiece is shown as the "interference angle θ_{κ} ", and should also be referred to.

EPDB2○○○-○○○(-TH)

CSコーティング CS Coating		THコーティング TH Coating		寸法 Size(mm)								干渉角度 Interference angle θ_{κ}		勾配角に対する実有効首下長 The effective under-neck length for the various draft angles						
商品コード Item code	在庫 Stock	商品コード Item code	在庫 Stock	ボール半径 Ball radius RE	外径 Tool dia. DC	首下長 Under neck length LU	刃長 Flute length APMX	首径 Neck dia. DN	全長 Overall length LF	シャンク径 Shank dia. DCONMS	首R Neck R	θ_{κ}	θ_{κ}	0.5°	1°	1.5°	2°	3°		
EPDB2014-8	<input type="checkbox"/>	EPDB2014-8-TH	<input type="checkbox"/>	0.7	1.4	8	1.3	1.34	50	4	10	5.48	9.45	9.94	10.36	10.73	11.38			
EPDB2014-12	<input type="checkbox"/>	EPDB2014-12-TH	<input type="checkbox"/>			12	1.3	1.34	55	4	10	4.24	13.68	14.29	14.79	15.23	15.99			
EPDB2014-16	<input type="checkbox"/>	EPDB2014-16-TH	<input type="checkbox"/>			16	1.3	1.34	55	4	10	3.46	17.88	18.59	19.16	19.65	21.2			
EPDB2015-4	<input type="checkbox"/>	EPDB2015-4-TH	<input type="checkbox"/>			4	1.35	1.44	50	4	10	7.68	5.16	5.49	5.79	6.06	6.57			
EPDB2015-6	<input type="checkbox"/>	EPDB2015-6-TH	<input type="checkbox"/>			6	1.35	1.44	50	4	10	6.33	7.31	7.73	8.09	8.42	9.01			
EPDB2015-8	<input type="checkbox"/>	EPDB2015-8-TH	<input type="checkbox"/>			8	1.35	1.44	50	4	10	5.39	9.45	9.94	10.35	10.72	11.37			
EPDB2015-10	<input type="checkbox"/>	EPDB2015-10-TH	<input type="checkbox"/>			10	1.35	1.44	50	4	10	4.68	11.57	12.12	12.58	12.99	13.7			
EPDB2015-12	<input type="checkbox"/>	EPDB2015-12-TH	<input type="checkbox"/>			12	1.35	1.44	55	4	10	4.14	13.68	14.29	14.79	15.23	15.98			
EPDB2015-16	<input type="checkbox"/>	EPDB2015-16-TH	<input type="checkbox"/>			16	1.35	1.44	55	4	10	3.37	17.88	18.59	19.16	19.65	21.18			
EPDB2015-20	<input type="checkbox"/>	EPDB2015-20-TH	<input type="checkbox"/>			20	1.35	1.44	60	4	10	2.84	22.06	22.85	23.48	24.01	干渉なし			
EPDB2016-8	<input type="checkbox"/>	EPDB2016-8-TH	<input type="checkbox"/>			0.8	1.6	8	1.4	1.54	50	4	10	5.28	9.44	9.93	10.35	10.71	11.37	
EPDB2016-12	<input type="checkbox"/>	EPDB2016-12-TH	<input type="checkbox"/>					12	1.4	1.54	55	4	10	4.05	13.68	14.28	14.78	15.22	15.98	
EPDB2016-16	<input type="checkbox"/>	EPDB2016-16-TH	<input type="checkbox"/>	16	1.4			1.54	55	4	10	3.28	17.88	18.58	19.15	19.64	21.16			
EPDB2016-20	<input type="checkbox"/>	EPDB2016-20-TH	<input type="checkbox"/>	20	1.4			1.54	60	4	10	2.75	22.06	22.85	23.47	24.01	干渉なし			
EPDB2018-8	<input type="checkbox"/>	EPDB2018-8-TH	<input type="checkbox"/>	0.9	1.8	8	1.6	1.73	50	4	10	5.06	9.47	9.95	10.36	10.72	11.37			
EPDB2018-12	<input type="checkbox"/>	EPDB2018-12-TH	<input type="checkbox"/>			12	1.6	1.73	55	4	10	3.83	13.7	14.3	14.79	15.22	15.98			
EPDB2018-16	<input type="checkbox"/>	EPDB2018-16-TH	<input type="checkbox"/>			16	1.6	1.73	55	4	10	3.09	17.9	18.6	19.16	19.65	21.16			
EPDB2018-20	<input type="checkbox"/>	EPDB2018-20-TH	<input type="checkbox"/>			20	1.6	1.73	60	4	10	2.58	22.08	22.86	23.48	24.01	干渉なし			
EPDB2020-3	<input type="checkbox"/>	EPDB2020-3-TH	<input type="checkbox"/>	1	2	3	1.7	1.92	50	4	10	8.26	4.16	4.4	4.64	4.86	5.29			
EPDB2020-4	<input type="checkbox"/>	EPDB2020-4-TH	<input type="checkbox"/>			4	1.7	1.92	50	4	10	7.23	5.23	5.54	5.81	6.07	6.55			
EPDB2020-6	<input type="checkbox"/>	EPDB2020-6-TH	<input type="checkbox"/>			6	1.7	1.92	50	4	10	5.78	7.38	7.77	8.11	8.43	9			
EPDB2020-8	<input type="checkbox"/>	EPDB2020-8-TH	<input type="checkbox"/>			8	1.7	1.92	50	4	10	4.81	9.5	9.97	10.37	10.73	11.37			
EPDB2020-10	<input type="checkbox"/>	EPDB2020-10-TH	<input type="checkbox"/>			10	1.7	1.92	50	4	10	4.12	11.62	12.15	12.6	12.99	13.69			
EPDB2020-12	<input type="checkbox"/>	EPDB2020-12-TH	<input type="checkbox"/>			12	1.7	1.92	55	4	10	3.61	13.73	14.31	14.8	15.23	15.98			
EPDB2020-14	<input type="checkbox"/>	EPDB2020-14-TH	<input type="checkbox"/>			14	1.7	1.92	55	4	10	3.2	15.83	16.47	16.99	17.45	18.51			
EPDB2020-16	<input type="checkbox"/>	EPDB2020-16-TH	<input type="checkbox"/>			16	1.7	1.92	55	4	10	2.88	17.92	18.61	19.17	19.65	干渉なし			
EPDB2020-18	<input type="checkbox"/>	EPDB2020-18-TH	<input type="checkbox"/>			18	1.7	1.92	60	4	10	2.62	20.01	20.74	21.33	21.84	干渉なし			
EPDB2020-20	<input type="checkbox"/>	EPDB2020-20-TH	<input type="checkbox"/>			20	1.7	1.92	60	4	10	2.4	22.1	22.87	23.49	24.02	干渉なし			
EPDB2020-22	<input type="checkbox"/>	EPDB2020-22-TH	<input type="checkbox"/>			22	1.7	1.92	60	4	10	2.22	24.18	24.99	25.63	26.35	干渉なし			
EPDB2020-25	<input type="checkbox"/>	EPDB2020-25-TH	<input type="checkbox"/>			25	1.7	1.92	65	4	10	1.99	27.3	28.16	28.84	干渉なし	干渉なし			
EPDB2020-30	<input type="checkbox"/>	EPDB2020-30-TH	<input type="checkbox"/>	30	1.7	1.92	70	4	10	1.7	32.49	33.42	34.29	干渉なし	干渉なし					
EPDB2020-35	<input type="checkbox"/>	EPDB2020-35-TH	<input type="checkbox"/>	35	1.7	1.92	75	4	10	1.48	37.65	38.67	干渉なし	干渉なし	干渉なし					
EPDB2020-40	<input type="checkbox"/>	EPDB2020-40-TH	<input type="checkbox"/>	40	1.7	1.92	80	4	10	1.31	42.81	43.89	干渉なし	干渉なし	干渉なし					
EPDB2030-8	<input type="checkbox"/>	EPDB2030-8-TH	<input type="checkbox"/>	1.5	3	8	2.5	2.88	55	6	10	6.19	9.61	10.03	10.4	10.74	11.35			
EPDB2030-10	<input type="checkbox"/>	EPDB2030-10-TH	<input type="checkbox"/>			10	2.5	2.88	55	6	10	5.41	11.72	12.21	12.63	13	13.67			
EPDB2030-13	<input type="checkbox"/>	EPDB2030-13-TH	<input type="checkbox"/>			13	2.5	2.88	60	6	10	4.56	14.87	15.44	15.92	16.35	17.15			
EPDB2030-16	<input type="checkbox"/>	EPDB2030-16-TH	<input type="checkbox"/>			16	2.5	2.88	60	6	10	3.93	18.01	18.65	19.19	19.66	21.13			
EPDB2030-20	<input type="checkbox"/>	EPDB2030-20-TH	<input type="checkbox"/>			20	2.5	2.88	65	6	10	3.33	22.18	22.91	23.51	24.02	26.44			
EPDB2030-25	<input type="checkbox"/>	EPDB2030-25-TH	<input type="checkbox"/>			25	2.5	2.88	70	6	10	2.79	27.37	28.2	28.86	29.96	干渉なし			
EPDB2030-30	<input type="checkbox"/>	EPDB2030-30-TH	<input type="checkbox"/>	30	2.5	2.88	75	6	10	2.4	32.55	33.46	34.32	35.94	干渉なし					
EPDB2030-35	<input type="checkbox"/>	EPDB2030-35-TH	<input type="checkbox"/>	35	2.5	2.88	80	6	10	2.11	37.71	38.7	40.03	41.92	干渉なし					
EPDB2040-10	<input type="checkbox"/>	EPDB2040-10-TH	<input type="checkbox"/>	2	4	10	3	3.9	55	6	10	4.42	11.63	12.11	12.53	12.9	13.57			
EPDB2040-13	<input type="checkbox"/>	EPDB2040-13-TH	<input type="checkbox"/>			13	3	3.9	60	6	10	3.59	14.79	15.36	15.84	16.26	17.01			
EPDB2040-16	<input type="checkbox"/>	EPDB2040-16-TH	<input type="checkbox"/>			16	3	3.9	60	6	10	3.03	17.93	18.58	19.11	19.58	20.91			
EPDB2040-20	<input type="checkbox"/>	EPDB2040-20-TH	<input type="checkbox"/>			20	3	3.9	65	6	10	2.5	22.11	22.84	23.44	23.96	干渉なし			
EPDB2040-25	<input type="checkbox"/>	EPDB2040-25-TH	<input type="checkbox"/>			25	3	3.9	70	6	10	2.05	27.31	28.14	28.8	29.81	干渉なし			
EPDB2040-30	<input type="checkbox"/>	EPDB2040-30-TH	<input type="checkbox"/>			30	3	3.9	75	6	10	1.74	32.49	33.4	34.2	干渉なし	干渉なし			
EPDB2040-35	<input type="checkbox"/>	EPDB2040-35-TH	<input type="checkbox"/>			35	3	3.9	80	6	10	1.51	37.66	38.65	39.9	干渉なし	干渉なし			
EPDB2040-40	<input type="checkbox"/>	EPDB2040-40-TH	<input type="checkbox"/>			40	3	3.9	80	6	10	1.34	42.82	43.87	干渉なし	干渉なし	干渉なし			
EPDB2040-45	<input type="checkbox"/>	EPDB2040-45-TH	<input type="checkbox"/>			45	3	3.9	90	6	10	1.2	47.97	49.1	干渉なし	干渉なし	干渉なし			
EPDB2040-50	<input type="checkbox"/>	EPDB2040-50-TH	<input type="checkbox"/>			50	3	3.9	100	6	10	1.09	53.11	54.55	干渉なし	干渉なし	干渉なし			
EPDB2050-20	<input type="checkbox"/>	EPDB2050-20-TH	<input type="checkbox"/>			2.5	5	20	3.5	4.9	65	6	10	1.38	22.09	22.81	干渉なし	干渉なし	干渉なし	
EPDB2050-25	<input type="checkbox"/>	EPDB2050-25-TH	<input type="checkbox"/>					25	3.5	4.9	70	6	10	1.12	27.29	28.11	干渉なし	干渉なし	干渉なし	
EPDB2050-30	<input type="checkbox"/>	EPDB2050-30-TH	<input type="checkbox"/>	30	3.5			4.9	75	6	10	0.94	32.47	干渉なし	干渉なし	干渉なし	干渉なし			
EPDB2050-40	<input type="checkbox"/>	EPDB2050-40-TH	<input type="checkbox"/>	40	3.5			4.9	80	6	10	0.71	42.8	干渉なし	干渉なし	干渉なし	干渉なし			
EPDB2060-30	<input type="checkbox"/>	EPDB2060-30-TH	<input type="checkbox"/>	3	6	30	6	5.9	75	6	10	0	干渉なし	干渉なし	干渉なし	干渉なし	干渉なし			
EPDB2060-50	<input type="checkbox"/>	EPDB2060-50-TH	<input type="checkbox"/>			50	6	5.9	100	6	10	0	干渉なし	干渉なし	干渉なし	干渉なし	干渉なし			

THコーティング品を注文される場合は商品コードの末尾に-THをつけてください。
When you want to order TH Coating items from us, please add the suffix -TH at the end of the item code.

干渉なし : No interference

- 印 : 特定代理店在庫です。弊社営業へお問合せください。
- : Stocked by specified distributor. Contact with our sales department.

● 対応被削材 Applicable work material

コーティング Coating	炭素鋼 合金鋼 Carbon steel Alloy steel	プリハー ド鋼 Pre-hardened steel ≤ 45HRC	高硬度 Hardened steel			ステン レス鋼 Stainless steel	チタン合金 耐熱合金 Titanium alloy Heat-resistant alloy	銅合金 Copper alloy	アルミ 合金 Aluminum alloy
	> 45HRC ≤ 55HRC	> 55HRC ≤ 65HRC	> 65HRC						
CS	○	○	○	○	○	○	○	○	
TH	○	○	○	○	○	○	○	○	

標準切削条件表 Recommended cutting conditions

EPDB | **EPDB-TH**

*CSシリーズは被削材グループ1~4を推奨 For details about the CS series, refer to work groups 1 - 4.
 THシリーズは被削材グループ4~6を推奨 For details about the TH series, refer to work groups 4 - 6.

推奨領域 Recommended range			CSシリーズ												THシリーズ					
被削材 Work material			1		2		3		4		5		6							
			銅 Coppers		炭素鋼・合金鋼 Carbon steels, Alloy steels (180~250HB)		ステンレス鋼・工具鋼 Stainless steels, Tool steels (25~35HRC)		プリハードン鋼 Pre-hardened steels (35~45HRC)		焼入れ鋼 Hardened steels (45~55HRC)		焼入れ鋼 Hardened steels (55~65HRC)							
切り込み比率 Ratio to standard depth of cut			120%		100%		90%		80%		65%		60%							
ボール半径RE Ball radius (mm)	外径DC Tool dia. (mm)	首下長LU Under neck length (mm)	基本切り込み Standard depth of cut (mm)	回転数 n min ⁻¹	送り速度 vf mm/min	回転数 n min ⁻¹	送り速度 vf mm/min	回転数 n min ⁻¹	送り速度 vf mm/min	回転数 n min ⁻¹	送り速度 vf mm/min	回転数 n min ⁻¹	送り速度 vf mm/min	回転数 n min ⁻¹	送り速度 vf mm/min					
0.05	0.1	0.2	0.008	50,000	300	50,000	250	50,000	250	50,000	225	50,000	200	50,000	188					
		0.3	0.006	50,000	300	50,000	250	50,000	250	50,000	225	50,000	200	50,000	188					
		0.5	0.004	50,000	300	50,000	250	50,000	250	50,000	225	50,000	200	50,000	188					
0.1	0.2	0.5	0.02	50,000	420	50,000	350	50,000	350	50,000	325	45,500	273	42,000	210					
		1	0.014	50,000	420	50,000	350	50,000	350	50,000	325	45,500	273	42,000	210					
		1.5	0.008	50,000	378	50,000	315	48,600	306	45,900	269	40,500	219	37,800	170					
		2	0.008	50,000	378	50,000	315	48,600	306	45,900	269	40,500	219	37,800	170					
		2.5	0.006	48,000	323	48,000	269	43,200	242	40,800	212	36,000	173	33,600	134					
		3	0.004	48,000	323	48,000	269	43,200	242	40,800	212	36,000	173	33,600	134					
0.15	0.3	1	0.021	50,000	600	50,000	500	50,000	500	50,000	450	45,000	383	42,000	336					
		1.5	0.016	50,000	600	50,000	500	50,000	500	50,000	450	45,000	383	42,000	336					
		2	0.012	50,000	540	50,000	450	48,600	437	45,900	372	40,500	310	37,800	272					
		2.5	0.01	50,000	540	50,000	450	48,600	437	45,900	372	40,500	310	37,800	272					
0.2	0.4	3	0.008	50,000	540	50,000	450	48,600	437	45,900	372	40,500	310	37,800	272					
		1	0.04	50,000	691	48,000	576	43,200	518	40,800	449	36,000	360	33,600	336					
		1.5	0.034	50,000	691	48,000	576	43,200	518	40,800	449	36,000	360	33,600	336					
		2	0.028	50,000	691	48,000	576	43,200	518	40,800	449	36,000	360	33,600	336					
		2.5	0.022	50,000	560	43,200	467	38,880	420	36,720	364	32,400	292	30,240	272					
		3	0.016	50,000	560	43,200	467	38,880	420	36,720	364	32,400	292	30,240	272					
0.25	0.5	3.5	0.012	50,000	560	43,200	467	38,880	420	36,720	364	32,400	292	30,240	272					
		4	0.01	50,000	560	43,200	467	38,880	420	36,720	364	32,400	292	30,240	272					
		4.5	0.008	46,080	470	38,400	392	34,560	353	32,640	305	28,800	245	26,880	228					
		1	0.045	48,000	960	40,000	800	36,000	720	34,000	612	30,000	540	28,000	476					
		2	0.035	48,000	960	40,000	800	36,000	720	34,000	612	30,000	540	28,000	476					
		3	0.03	43,200	778	36,000	648	32,400	583	30,600	496	27,000	437	25,200	386					
		4	0.02	43,200	778	36,000	648	32,400	583	30,600	496	27,000	437	25,200	386					
		5	0.018	43,200	778	36,000	648	32,400	583	30,600	496	27,000	437	25,200	386					
0.3	0.6	5.5	0.015	38,400	653	32,000	544	28,800	490	27,200	416	24,000	367	22,400	324					
		6	0.013	38,400	653	32,000	544	28,800	490	27,200	416	24,000	367	22,400	324					
		8	0.008	38,400	653	32,000	544	28,800	490	27,200	416	24,000	367	22,400	324					
		1	0.05	48,000	1,440	40,000	1,200	36,000	1,080	34,000	884	30,000	720	28,000	560					
		2	0.042	48,000	1,440	40,000	1,200	36,000	1,080	34,000	884	30,000	720	28,000	560					
		3	0.034	48,000	1,440	40,000	1,200	36,000	1,080	34,000	884	30,000	720	28,000	560					
		4	0.024	43,200	1,231	36,000	1,026	32,400	923	30,600	756	27,000	616	25,200	479					
		5	0.02	43,200	1,166	36,000	972	32,400	875	30,600	716	27,000	583	25,200	454					
		6	0.015	43,200	1,166	36,000	972	32,400	875	30,600	716	27,000	583	25,200	454					
		7	0.015	38,400	979	32,000	816	28,800	734	27,200	601	24,000	490	22,400	381					
		8	0.015	38,400	979	32,000	816	28,800	734	27,200	601	24,000	490	22,400	381					
		9	0.012	38,400	979	32,000	816	28,800	734	27,200	601	24,000	490	22,400	381					
0.4	0.8	10	0.009	33,600	857	28,000	714	25,200	643	23,800	526	21,000	428	19,600	333					
		12	0.007	28,800	691	24,000	576	21,600	518	20,400	424	18,000	346	16,800	269					
		2	0.08	48,000	1,728	40,000	1,440	36,000	1,296	34,000	1,088	30,000	900	28,000	784					
		4	0.056	48,000	1,728	40,000	1,440	36,000	1,296	34,000	1,088	30,000	900	28,000	784					
		5	0.045	43,200	1,400	36,000	1,166	32,400	1,050	30,600	881	27,000	729	25,200	635					
		6	0.032	43,200	1,400	36,000	1,166	32,400	1,050	30,600	881	27,000	729	25,200	635					
		8	0.02	38,400	1,244	32,000	1,037	28,800	933	27,200	783	24,000	648	22,400	564					
		10	0.02	38,400	1,175	32,000	979	28,800	881	27,200	740	24,000	612	22,400	533					
		0.5	1	2	0.1	43,200	2,160	36,000	1,800	32,400	1,620	30,600	1,377	27,000	1,134	25,200	1,008			
				3	0.1	43,200	2,160	36,000	1,800	32,400	1,620	30,600	1,377	27,000	1,134	25,200	1,008			
4	0.07			43,200	2,160	36,000	1,800	32,400	1,620	30,600	1,377	27,000	1,134	25,200	1,008					
5	0.06			43,200	2,160	36,000	1,800	32,400	1,620	30,600	1,377	27,000	1,134	25,200	1,008					
6	0.04			38,880	1,750	32,400	1,458	29,160	1,312	27,540	1,115	24,300	919	22,680	816					
7	0.04			38,880	1,750	32,400	1,458	29,160	1,312	27,540	1,115	24,300	919	22,680	816					
8	0.04			38,880	1,750	32,400	1,458	29,160	1,312	27,540	1,115	24,300	919	22,680	816					
9	0.03			38,880	1,750	32,400	1,458	29,160	1,312	27,540	1,115	24,300	919	22,680	816					
10	0.025			38,880	1,750	32,400	1,458	29,160	1,312	27,540	1,115	24,300	919	22,680	816					
12	0.025			34,560	1,469	28,800	1,224	25,920	1,102	24,480	936	21,600	771	20,160	685					
14	0.02			34,560	1,469	28,800	1,224	25,920	1,102	24,480	936	21,600	771	20,160	685					
16	0.015			34,560	1,469	28,800	1,224	25,920	1,102	24,480	936	21,600	771	20,160	685					
18	0.012			30,240	1,210	25,200	1,008	22,680	907	21,420	771	18,900	635	17,640	564					
20	0.01			25,920	1,037	21,600	864	19,440	778	18,360	661	16,200	544	15,120	484					
0.6	1.2	8	0.04	34,560	1,797	28,800	1,498	25,920	1,348	24,480	1,224	21,600	950	20,160	806					
		12	0.03	34,560	1,617	28,800	1,348	25,920	1,213	24,480	1,102	21,600	855	20,160	726					
		8	0.055	30,240	1,814	25,200	1,512	22,680	1,361	21,420	1,157	18,900	983	17,640	882					
0.7	1.4	12	0.035	30,240	1,633	25,200	1,361	22,680	1,225	21,420	1,041	18,900	885	17,640	794					
		16	0.035	26,880	1,371	22,400	1,142	20,160	1,028	19,040	874	16,800	743	15,680	666					
		4	0.1	33,600	2,218	28,000	1,848	25,200	1,663	23,800	1,428	21,000	1,134	19,600	980					
0.75	1.5	6	0.1	33,600	2,218	28,000	1,848	25,200	1,663	23,800	1,428	21,000	1,134	19,600	980					
		8	0.06	30,240	1,796	25,200	1,497	22,680	1,347	21,420	1,157	18,900	919	17,640	794					
		10	0.06	30,240	1,796	25,200	1,497	22,680	1,347	21,420	1,157	18,900	919	17,640	794					
		12	0.06	30,240	1,796	25,200	1,497	22,680	1,347	21,420	1,157	18,900	919	17,640	794					
		16	0.038	26,880	1,508	22,400	1,257	20,160	1,131	19,040	971	16,800	771	15,680	666					
		20	0.038	26,880	1,508															

Epoch Deep Ball エポックディープボール

EPDB EPDB-TH

※CSシリーズは被削材グループ1~4を推奨 For details about the CS series, refer to work groups 1 - 4.
THシリーズは被削材グループ4~6を推奨 For details about the TH series, refer to work groups 4 - 6.

推奨領域 Recommended range				CSシリーズ										THシリーズ					
				1		2		3		4		5		6					
被削材 Work material				銅 Coppers		炭素鋼・合金鋼 Carbon steels, Alloy steels (180~250HB)		ステンレス鋼・工具鋼 Stainless steels, Tool steels (25~35HRC)		プリハードン鋼 Pre-hardened steels (35~45HRC)		焼入れ鋼 Hardened steels (45~55HRC)		焼入れ鋼 Hardened steels (55~65HRC)					
				切り込み比率 Ratio to standard depth of cut				120%		100%		90%		80%		65%		60%	
ボール半径R Ball radius (mm)	外径DC Tool dia. (mm)	首下長LU Under neck length (mm)	※基本切り込み Standard depth of cut (mm)	回転数 n min ⁻¹	送り速度 vf mm/min	回転数 n min ⁻¹	送り速度 vf mm/min	回転数 n min ⁻¹	送り速度 vf mm/min	回転数 n min ⁻¹	送り速度 vf mm/min	回転数 n min ⁻¹	送り速度 vf mm/min	回転数 n min ⁻¹	送り速度 vf mm/min				
0.8	1.6	8	0.11	31,200	2,184	26,000	1,820	23,400	1,638	22,100	1,370	19,500	1,170	18,200	1,019				
		12	0.065	28,080	1,769	23,400	1,474	21,060	1,327	19,890	1,110	17,550	948	16,380	826				
		16	0.04	28,080	1,769	23,400	1,474	21,060	1,327	19,890	1,110	17,550	948	16,380	826				
		20	0.04	24,960	1,485	20,800	1,238	18,720	1,114	17,680	932	15,600	796	14,560	693				
0.9	1.8	8	0.13	31,200	2,496	26,000	2,080	23,400	1,872	22,100	1,547	19,500	1,287	18,200	1,092				
		12	0.07	28,080	2,022	23,400	1,685	21,060	1,516	19,890	1,253	17,550	1,042	16,380	885				
		16	0.045	28,080	2,022	23,400	1,685	21,060	1,516	19,890	1,253	17,550	1,042	16,380	885				
		20	0.045	24,960	1,697	20,800	1,414	18,720	1,273	17,680	1,052	15,600	875	14,560	743				
1	2	3	0.2	25,200	2,520	21,000	2,100	18,900	1,890	17,850	1,607	15,750	1,355	14,700	1,176				
		4	0.2	25,200	2,520	21,000	2,100	18,900	1,890	17,850	1,607	15,750	1,355	14,700	1,176				
		6	0.2	25,200	2,268	21,000	1,890	18,900	1,701	17,850	1,428	15,750	1,197	14,700	1,058				
		8	0.14	25,200	2,268	21,000	1,890	18,900	1,701	17,850	1,428	15,750	1,197	14,700	1,058				
		10	0.14	25,200	2,016	21,000	1,680	18,900	1,512	17,850	1,285	15,750	1,071	14,700	941				
		12	0.08	22,680	1,814	18,900	1,512	17,010	1,361	16,065	1,157	14,175	964	13,230	847				
		14	0.08	22,680	1,814	18,900	1,512	17,010	1,361	16,065	1,157	14,175	964	13,230	847				
		16	0.08	22,680	1,633	18,900	1,361	17,010	1,225	16,065	1,041	14,175	868	13,230	762				
		18	0.06	22,680	1,633	18,900	1,361	17,010	1,225	16,065	1,041	14,175	868	13,230	762				
		20	0.05	22,680	1,633	18,900	1,361	17,010	1,225	16,065	1,041	14,175	868	13,230	762				
		22	0.05	21,420	1,457	17,850	1,214	16,065	1,092	15,173	929	13,388	774	12,495	680				
		25	0.05	20,160	1,371	16,800	1,142	15,120	1,028	14,280	874	12,600	728	11,760	640				
		30	0.03	20,160	1,371	16,800	1,142	15,120	1,028	14,280	874	12,600	728	11,760	640				
		35	0.025	17,640	1,129	14,700	941	13,230	847	12,495	720	11,025	600	10,290	527				
		40	0.022	15,120	968	12,600	806	11,340	726	10,710	617	9,450	514	8,820	452				
		1.5	3	8	0.3	19,200	2,880	16,000	2,400	14,400	2,160	13,600	1,822	12,000	1,512	11,200	1,344		
10	0.21			19,200	2,880	16,000	2,400	14,400	2,160	13,600	1,822	12,000	1,512	11,200	1,344				
13	0.21			19,200	2,880	16,000	2,400	14,400	2,160	13,600	1,822	12,000	1,512	11,200	1,344				
16	0.21			19,200	2,592	16,000	2,160	14,400	1,944	13,600	1,640	12,000	1,361	11,200	1,210				
20	0.12			17,280	2,333	14,400	1,944	12,960	1,750	12,240	1,476	10,800	1,225	10,080	1,089				
25	0.08			17,280	2,333	14,400	1,944	12,960	1,750	12,240	1,476	10,800	1,225	10,080	1,089				
30	0.08			17,280	2,333	14,400	1,944	12,960	1,750	12,240	1,476	10,800	1,225	10,080	1,089				
35	0.08			15,360	1,958	12,800	1,632	11,520	1,469	10,880	1,239	9,600	1,028	8,960	914				
2	4	10	0.4	13,800	2,760	11,500	2,300	10,350	2,070	9,775	1,760	8,625	1,466	8,050	1,288				
		13	0.32	13,800	2,760	11,500	2,300	10,350	2,070	9,775	1,760	8,625	1,466	8,050	1,288				
		16	0.28	13,800	2,760	11,500	2,300	10,350	2,070	9,775	1,760	8,625	1,466	8,050	1,288				
		20	0.28	13,800	2,760	11,500	2,300	10,350	2,070	9,775	1,760	8,625	1,466	8,050	1,288				
		25	0.16	12,420	2,236	10,350	1,863	9,315	1,677	8,798	1,425	7,763	1,188	7,245	1,043				
		30	0.16	12,420	2,236	10,350	1,863	9,315	1,677	8,798	1,425	7,763	1,188	7,245	1,043				
		35	0.1	12,420	2,236	10,350	1,863	9,315	1,677	8,798	1,425	7,763	1,188	7,245	1,043				
		40	0.1	12,420	2,236	10,350	1,863	9,315	1,677	8,798	1,425	7,763	1,188	7,245	1,043				
		45	0.1	11,040	1,877	9,200	1,564	8,280	1,408	7,820	1,196	6,900	997	6,440	876				
		50	0.1	11,040	1,877	9,200	1,564	8,280	1,408	7,820	1,196	6,900	997	6,440	876				
2.5	5	20	0.35	10,800	2,592	9,000	2,160	8,100	1,944	7,650	1,530	6,750	1,350	6,300	1,134				
		25	0.35	10,800	2,592	9,000	2,160	8,100	1,944	7,650	1,530	6,750	1,350	6,300	1,134				
		30	0.2	9,720	2,333	8,100	1,944	7,290	1,750	6,885	1,377	6,075	1,215	5,670	1,021				
		40	0.2	9,720	2,100	8,100	1,750	7,290	1,575	6,885	1,239	6,075	1,094	5,670	919				
3	6	30	0.42	9,600	2,304	8,000	1,920	7,200	1,728	6,800	1,360	6,000	1,200	5,600	1,008				
		50	0.15	8,640	1,866	7,200	1,555	6,480	1,400	6,120	1,102	5,400	972	5,040	816				

※(1) 基本切込みは被削材グループ2での目安を示しています。その他のグループの場合は、上表の切込み比率を目安に調整して下さい。

※(2) リブ加工や止まり溝など、切りくすがつまりやすい切削の場合、切込み設定は基本切込みに切込み比率をかけて算出した切込み量を、さらにその80%まで小さくして使用して下さい。

※(1) Standard cutting depth is shown as the criteria for Group 2 workpieces. For other groups, adjust the cutting depth according to the cutting depth factors in the above table.

※(2) When performing cutting where cutting chips may cause clogging, such as for rib cutting, blind grooves, etc., cutting depth setting should be set by multiplying a cutting depth factor to calculate the cutting depth amount, and this amount should then be reduced to 80% of the calculated value.

【切込み設定例】 EPDB2020-10-THの工具で焼き入れ鋼(50HRC)をリブ溝等高線切削する場合、
切込み=0.14(基本切込み)×0.65(焼き入れ鋼グループ5の切込み比率)×0.8(閉鎖領域の切削)=0.073

Cutting depth setting example: When cutting rib groove contours in quenched steel (50HRC) using an EPDB2020-10-TH tool:

Cutting depth = 0.14 (standard cutting depth) × 0.65 (cutting depth factor for Group 5 quenched steel) × 0.8 (for closed-area cutting) = 0.073mm

- 【注意】
- ① 被削材、加工形状に合わせて、適切なクーラントを使用して下さい。
 - ② この標準切削条件表は切削条件の目安を示すものです。実際の加工では加工形状、目的、使用機械等により条件を調整して下さい。
 - ③ 機械の回転数が足りない場合は、回転数と送り速度を同じ比率で下げてください。

- 【Note】
- ① Use the appropriate coolant for the work material and machining shape.
 - ② These Recommended Cutting Conditions indicate only the rule of a thumb for the cutting conditions. In actual machining, the condition should be adjusted according to the machining shape, purpose and the machine type.
 - ③ If the rpm of the machine is low, lower the feed rate also to put the rpm and feed rate in the same ratio.

Epoch CS Power Ball エポック CS パワーボール

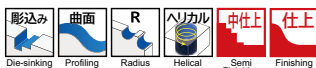

RE公差
RE0.5~RE6 : ±0.005
RE8~RE10 : ±0.01



(mm)

2枚刃
2Flutes



※首めずみ無し Without neck escape

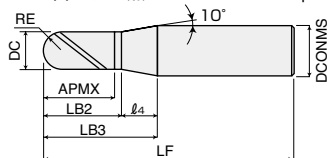

Aタイプ
A type

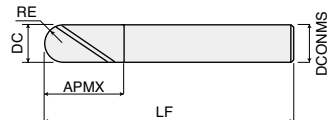

Bタイプ
B type

EPBC2○○○(-○)



商品コード Item code	在庫 Stock	寸法 Size (mm)								形状 Shape
		ボール半径 Ball radius	外径 Tool dia.	刃長 Flute length	首下長 Under neck length		首テーパ長 Neck taper length	全長 Overall length	シャンク径 Shank dia.	
		RE	DC	APMX	LB2	LB3	ℓ ₄	LF	DCONMS	
EPBC2010	<input type="checkbox"/>	0.5	1	2.5	3.5	12	8.5	50	4	A
EPBC2015	<input type="checkbox"/>	0.75	1.5	4	5	12.1	7.1	50	4	A
EPBC2020	<input type="checkbox"/>	1	2	5	6	17.3	11.3	50	6	A
EPBC2025	<input type="checkbox"/>	1.25	2.5	7	8	17.9	9.9	50	6	A
EPBC2030	<input type="checkbox"/>	1.5	3	8	9	17.5	8.5	70	6	A
EPBC2040-4	<input type="checkbox"/>	2	4	8	—	—	—	70	4	B
EPBC2040	<input type="checkbox"/>			8	9	14.7	5.7	70	6	A
EPBC2050	<input type="checkbox"/>	2.5	5	10	11	13.8	2.8	80	6	A
EPBC2060	<input type="checkbox"/>	3	6	12	—	—	—	90	6	B
EPBC2080	<input type="checkbox"/>	4	8	14	—	—	—	100	8	B
EPBC2100	<input type="checkbox"/>	5	10	18	—	—	—	100	10	B
EPBC2120	<input type="checkbox"/>	6	12	22	—	—	—	110	12	B
EPBC2160	<input type="checkbox"/>	8	16	30	—	—	—	140	16	B
EPBC2200	<input type="checkbox"/>	10	20	38	—	—	—	160	20	B

対応被削材 Applicable work material

炭素鋼 合金鋼 Carbon steel Alloy steel	プリハー ド鋼 Pre-hardened steel ≤ 45HRC	高硬度 Hardened steel			ステン レス鋼 Stainless steel	チタン合金 耐熱合金 Titanium alloy Heat-resistant alloy	銅合金 Copper alloy	アルミ 合金 Aluminum alloy
		> 45HRC ≤ 55HRC	> 55HRC ≤ 65HRC	> 65HRC				
○	○	○	○		○	○	○	

○印：特定代理店在庫です。弊社営業へお問合せください。 □：Stocked by specified distributor. Contact with our sales department.

超硬ボール

特定代理店在庫品

標準切削条件表 Recommended cutting conditions

EPBC

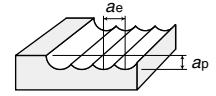

<荒加工> Roughing

被削材 Work material	鋳鉄 Cast irons (150~200HB) FC250		炭素鋼 Carbon steels (180~220HB) SS400,S50C		合金鋼 Alloy steels (200~250HB) SCM440,SNCM		工具鋼 Tool steels (25~35HRC) SKD		プリハードン鋼 Pre-hardened steels (35~45HRC) CENAI,NAK80											
	高速条件 High speed	汎用条件 General	高速条件 High speed	汎用条件 General	高速条件 High speed	汎用条件 General	高速条件 High speed	汎用条件 General	高速条件 High speed	汎用条件 General										
切込み Depth of cut (mm)	$a_p=0.1DC$ $a_e=0.3DC$		$a_p=0.1DC$ $a_e=0.3DC$		$a_p=0.1DC$ $a_e=0.3DC$		$a_p=0.1DC$ $a_e=0.3DC$		$a_p=0.1DC$ $a_e=0.3DC$											
ボール半径RE ×外径DC Tool dia.(mm)	回転数 n (min^{-1})	送り速度 v_f (mm/min)	回転数 n (min^{-1})	送り速度 v_f (mm/min)	回転数 n (min^{-1})	送り速度 v_f (mm/min)	回転数 n (min^{-1})	送り速度 v_f (mm/min)	回転数 n (min^{-1})	送り速度 v_f (mm/min)	回転数 n (min^{-1})	送り速度 v_f (mm/min)	回転数 n (min^{-1})	送り速度 v_f (mm/min)	回転数 n (min^{-1})	送り速度 v_f (mm/min)	回転数 n (min^{-1})	送り速度 v_f (mm/min)		
RE0.5×1	50,000	1,600	20,000	640	50,000	1,800	20,000	720	50,000	1,800	20,000	720	50,000	1,800	20,000	720	50,000	1,600	20,000	640
RE1×2	41,000	2,380	20,000	1,160	48,000	3,170	20,000	1,320	48,000	3,170	20,000	1,320	41,000	2,710	20,000	1,320	37,000	2,150	20,000	1,160
RE1.5×3	28,000	2,520	16,000	1,440	32,000	3,260	20,000	2,040	32,000	3,260	20,000	2,040	28,000	2,860	16,000	1,630	24,000	2,160	14,000	1,260
RE2×4	21,000	2,560	12,000	1,460	24,000	3,360	16,000	2,240	24,000	3,360	16,000	2,240	21,000	2,940	12,000	1,680	18,000	2,200	10,400	1,270
RE3×6	14,000	2,580	8,000	1,470	16,000	3,360	11,000	2,310	16,000	3,360	11,000	2,310	14,000	2,940	8,000	1,680	12,000	2,210	6,900	1,270
RE4×8	10,000	2,600	6,000	1,510	12,000	3,600	8,000	2,400	12,000	3,600	8,000	2,400	10,000	3,000	6,000	1,800	9,200	2,320	5,200	1,310
RE5×10	8,300	2,590	4,800	1,500	9,600	3,460	6,400	2,300	9,600	3,460	6,400	2,300	8,300	2,990	4,800	1,730	7,300	2,280	4,100	1,280
RE6×12	6,900	2,320	4,000	1,340	8,000	3,100	5,300	2,060	8,000	3,100	5,300	2,060	6,900	2,680	4,000	1,550	6,100	2,050	3,500	1,180
RE8×16	5,200	1,980	3,000	1,140	6,000	2,580	4,000	1,720	6,000	2,580	4,000	1,720	5,200	2,240	3,000	1,290	4,600	1,750	2,600	990
RE10×20	4,100	1,560	2,400	910	4,800	2,060	3,200	1,380	4,800	2,080	3,200	1,380	4,100	1,760	2,400	1,030	3,700	1,410	2,100	800

- [注意]** ①できるだけ高剛性、高精度の機械をご使用ください。
 ②被削材、加工形状に合わせて、適切なクーラントを使用してください。
 ③この切削条件表は切削条件の目安を示すものです。実際の加工では加工形状、目的、使用機械等により条件を調整してください。
 ④機械の回転数が足りない場合には、回転数と送り速度を同じ比率で下げてください。

- [Note]** ① Use a highly rigid and accurate machine as possible.
 ② Use the appropriate coolant for the work material and machining shape.
 ③ These conditions are for general guidance; in actual machining conditions adjust the parameters according to your actual machine and work-piece conditions.
 ④ If the rpm available is lower than that recommended please reduce the feed rate to the same ratio.

<仕上げ加工> Finishing

a_p :仕上げ代 Finishing cut amount
 a_e :ピックフィード Pick feed

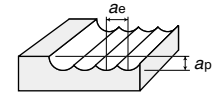

被削材 Work material	鋳鉄 Cast irons (150~200HB) FC250		炭素鋼 Carbon steels (180~220HB) SS400,S50C		合金鋼 Alloy steels (200~250HB) SCM440,SNCM		工具鋼 Tool steels (25~35HRC) SKD		プリハードン鋼 Pre-hardened steels (35~45HRC) CENAI,NAK80											
	高速条件 High speed	汎用条件 General	高速条件 High speed	汎用条件 General	高速条件 High speed	汎用条件 General	高速条件 High speed	汎用条件 General	高速条件 High speed	汎用条件 General										
切込み Depth of cut (mm)	$a_p=0.05\sim0.2$ $a_e=0.03DC$		$a_p=0.05\sim0.2$ $a_e=0.03DC$		$a_p=0.05\sim0.2$ $a_e=0.03DC$		$a_p=0.05\sim0.1$ $a_e=0.02DC$		$a_p=0.05\sim0.1$ $a_e=0.02DC$											
ボール半径RE ×外径DC Tool dia.(mm)	回転数 n (min^{-1})	送り速度 v_f (mm/min)	回転数 n (min^{-1})	送り速度 v_f (mm/min)	回転数 n (min^{-1})	送り速度 v_f (mm/min)	回転数 n (min^{-1})	送り速度 v_f (mm/min)	回転数 n (min^{-1})	送り速度 v_f (mm/min)	回転数 n (min^{-1})	送り速度 v_f (mm/min)	回転数 n (min^{-1})	送り速度 v_f (mm/min)	回転数 n (min^{-1})	送り速度 v_f (mm/min)	回転数 n (min^{-1})	送り速度 v_f (mm/min)		
RE0.5×1	50,000	5,500	20,000	2,200	50,000	5,500	20,000	2,200	50,000	5,000	20,000	2,000	50,000	5,000	20,000	2,000	50,000	5,000	20,000	2,000
RE1×2	48,000	6,340	20,000	2,640	48,000	6,340	20,000	2,640	48,000	5,760	20,000	2,400	48,000	5,760	20,000	2,400	48,000	5,760	20,000	2,400
RE1.5×3	32,000	4,930	20,000	3,080	32,000	4,930	20,000	3,080	32,000	4,480	17,000	2,380	32,000	4,480	17,000	2,380	32,000	4,480	17,000	2,380
RE2×4	24,000	4,510	15,900	2,990	24,000	4,510	15,900	2,990	24,000	4,080	13,000	2,210	24,000	4,080	13,000	2,210	24,000	4,080	13,000	2,210
RE3×6	16,000	3,870	10,600	2,570	16,000	3,870	10,600	2,570	16,000	3,520	8,500	1,870	16,000	3,520	8,500	1,870	16,000	3,520	8,500	1,870
RE4×8	12,000	3,170	8,000	2,110	12,000	3,360	8,000	2,240	12,000	2,880	6,400	1,540	12,000	2,880	6,400	1,540	12,000	2,880	6,400	1,540
RE5×10	9,600	2,750	6,400	1,830	9,600	2,980	6,400	1,980	9,600	2,600	5,100	1,330	10,000	2,600	5,100	1,330	10,000	2,600	5,100	1,330
RE6×12	8,000	2,380	5,300	1,580	8,000	2,720	5,300	1,800	8,000	2,160	4,200	1,130	8,000	2,160	4,200	1,130	8,000	2,160	4,200	1,130
RE8×16	6,000	1,870	4,000	1,250	6,000	2,100	4,000	1,400	6,000	1,680	3,200	900	6,000	1,680	3,200	900	6,000	1,680	3,200	900
RE10×20	4,800	1,500	3,200	1,000	4,800	1,680	3,200	1,120	4,800	1,340	2,500	700	4,800	1,340	2,500	700	4,800	1,340	2,500	700

- [注意]** ①できるだけ高剛性、高精度の機械をご使用ください。
 ②上表の a_e (ピックフィード)は目安です。実際にはA131頁のカスプハイトを参考に選定してください。
 ③被削材、加工形状に合わせて、適切なクーラントを使用してください。
 ④この切削条件表は切削条件の目安を示すものです。実際の加工では加工形状、目的、使用機械等により条件を調整してください。
 ⑤機械の回転数が足りない場合には、回転数と送り速度を同じ比率で下げてください。

- [Note]** ① Use a highly rigid and accurate machine as possible.
 ② The pick feed in the table is a general condition; please select the a_e according to the cusp height requested (page A131).
 ③ Use the appropriate coolant for the work material and machining shape.
 ④ These conditions are for general guidance; in actual machining conditions adjust the parameters according to your actual machine and work-piece conditions.
 ⑤ If the rpm available is lower than that recommended please reduce the feed rate to the same ratio.

Epoch Ball End Mill エポックボールエンドミル

2枚刃・レギュラー刃長 2 Flutes, Regular

RE公差 ±0.01 h6



2枚刃・ロングシャンク 2 Flutes, Long Shank

RE公差 RE0.5~RE6 : ±0.015
RE8~RE12.5 : ±0.02 h6

2枚刃ロングシャンクボールエンドミル。2-flute long-shank ball end mill



CEPB2

商品コード Item code	在庫 Stock	寸法 Size (mm)				
		ボール半径 Ball radius	外径 Tool dia.	刃長 Flute length	全長 Overall length	シャンク径 Shank dia.
CEPB2010	<input type="checkbox"/>	0.5	1	1.5	50	4
CEPB2015	<input type="checkbox"/>	0.75	1.5	2.5	50	4
CEPB2020	<input type="checkbox"/>	1	2	3	50	6
CEPB2025	<input type="checkbox"/>	1.25	2.5	4	50	6
CEPB2030	<input type="checkbox"/>	1.5	3	4.5	70	6
CEPB2040	<input type="checkbox"/>	2	4	6	70	6
CEPB2050	<input type="checkbox"/>	2.5	5	7.5	80	6
CEPB2060	<input type="checkbox"/>	3	6	9	90	6
CEPB2070	<input type="checkbox"/>	3.5	7	11	90	6
CEPB2080	<input type="checkbox"/>	4	8	12	100	8
CEPB2100	<input type="checkbox"/>	5	10	15	100	10
CEPB2120	<input type="checkbox"/>	6	12	18	110	12
CEPB2160	<input type="checkbox"/>	8	16	24	140	16
CEPB2200	<input type="checkbox"/>	10	20	30	160	20
CEPB2250	<input type="checkbox"/>	12.5	25	38	180	25

CEPBL2

商品コード Item code	在庫 Stock	寸法 Size (mm)				
		ボール半径 Ball radius	外径 Tool dia.	刃長 Flute length	全長 Overall length	シャンク径 Shank dia.
CEPBL2010	<input type="checkbox"/>	0.5	1	1.5	80	4
CEPBL2015	<input type="checkbox"/>	0.75	1.5	2.5	80	4
CEPBL2020	<input type="checkbox"/>	1	2	3	90	6
CEPBL2025	<input type="checkbox"/>	1.25	2.5	4	90	6
CEPBL2030	<input type="checkbox"/>	1.5	3	4.5	100	6
CEPBL2040	<input type="checkbox"/>	2	4	6	100	6
CEPBL2050	<input type="checkbox"/>	2.5	5	7.5	125	6
CEPBL2060	<input type="checkbox"/>	3	6	9	150	6
CEPBL2070	<input type="checkbox"/>	3.5	7	11	150	6
CEPBL2080	<input type="checkbox"/>	4	8	12	180	8
CEPBL2100	<input type="checkbox"/>	5	10	15	200	10
CEPBL2120	<input type="checkbox"/>	6	12	18	220	12
CEPBL2160	<input type="checkbox"/>	8	16	24	250	16
CEPBL2200	<input type="checkbox"/>	10	20	30	280	20
CEPBL2250	<input type="checkbox"/>	12.5	25	38	300	25

4枚刃・レギュラー刃長 4 Flutes, Regular

RE公差 ±0.02 h6



CEPB4

商品コード Item code	在庫 Stock	寸法 Size (mm)					希望小売価格 (円) Suggested retail price(¥)
		ボール半径 Ball radius	外径 Tool dia.	刃長 Flute length	全長 Overall length	シャンク径 Shank dia.	
CEPB4060	<input type="checkbox"/>	3	6	9	90	6	—
CEPB4080	△	4	8	12	100	8	23,570
CEPB4100	<input type="checkbox"/>	5	10	15	100	10	—
CEPB4120	△	6	12	18	110	12	38,940

CEPB2、CEPBL2、CEPB4の対応被削材

Applicable work material of CEPB2, CEPBL2, CEPB4

炭素鋼 合金鋼 Carbon steel Alloy steel	プリハー ド鋼 Pre-hardened steel	高硬度 Hardened steel			ステン レス鋼 Stainless steel	チタン合金 耐熱合金 Titanium alloy Heat-resistant alloy	銅合金 Copper alloy	アルミ 合金 Aluminum alloy
		> 45HRC ≤ 55HRC	> 55HRC ≤ 65HRC	> 65HRC				
○	○	○	○	○	○	○	○	

△印：在庫が無くなり次第受注生産品となるものです。 □印：特定代理店在庫です。弊社営業へお問合せください。 無印：受注生産品です。
△ : When the Stock is out, will become to produce on request. □ : Stocked by specified distributor. Contact with our sales department. No Mark: Manufactured upon request only.

Carbide End Mills
Stocked by Specified distributor

Epoch Ball End Mill

エポックボールエンドミル

標準切削条件表 Recommended cutting conditions

CEPB2

2枚刃・レギュラー刃長
2fl, Regular

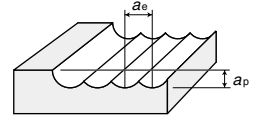

<荒加工> Roughing

被削材 Work material	鋳鉄 Cast irons (150~200HB) FC250		炭素鋼 Carbon steels (180~220HB) SS400, S50C		合金鋼 Alloy steels (200~250HB) SCM440, SNCM		工具鋼 Tool steels (25~35HRC) SKD		プリハードン鋼 Pre-hardened steels (35~45HRC) HPM1, NAK55		焼入れ鋼 Hardened steels (45~55HRC) SKD61, SKT4		焼入れ鋼 Hardened steels (55~65HRC) SKD11, SKH51		
	切込み Depth of cut (mm)	ap=0.1DC, ae=0.3DC	ap=0.1DC, ae=0.3DC	ap=0.1DC, ae=0.3DC	ap=0.1DC, ae=0.3DC	ap=0.1DC, ae=0.3DC	ap=0.1DC, ae=0.3DC	ap=0.1DC, ae=0.3DC	ap=0.1DC, ae=0.3DC	ap=0.1DC, ae=0.3DC	ap=0.1DC, ae=0.3DC	ap=0.1DC, ae=0.3DC	ap=0.1DC, ae=0.3DC	ap=0.1DC, ae=0.3DC	
ボール半径RE ×外径DC Tool dia.(mm)	回転数 n (min ⁻¹)	送り速度 vf (mm/min)	回転数 n (min ⁻¹)	送り速度 vf (mm/min)	回転数 n (min ⁻¹)	送り速度 vf (mm/min)	回転数 n (min ⁻¹)	送り速度 vf (mm/min)	回転数 n (min ⁻¹)	送り速度 vf (mm/min)	回転数 n (min ⁻¹)	送り速度 vf (mm/min)	回転数 n (min ⁻¹)	送り速度 vf (mm/min)	
High speed 高速条件	RE0.5x1	50,000	4,000	50,000	4,000	50,000	4,000	50,000	4,000	50,000	2,500	50,000	2,500	47,700	2,390
	RE1x2	47,700	5,720	47,700	5,720	39,800	4,780	39,800	4,780	39,800	3,180	31,800	2,540	23,900	1,910
	RE1.5x3	31,800	5,090	31,800	5,090	26,500	4,240	26,500	4,240	26,500	2,920	21,200	2,330	15,900	1,750
	RE2x4	23,900	4,780	23,900	4,780	19,900	3,980	19,900	3,980	19,900	2,790	15,900	2,230	11,900	1,670
	RE3x6	15,900	4,450	15,900	4,450	13,300	3,720	13,300	3,720	13,300	2,390	10,600	1,910	7,960	1,430
	RE4x8	11,900	3,810	11,900	3,810	9,950	3,180	9,950	3,180	9,950	2,190	7,960	1,750	5,970	1,310
	RE5x10	9,550	3,440	9,550	3,440	7,960	2,870	7,960	2,870	7,960	2,070	6,370	1,660	4,770	1,240
	RE6x12	7,960	3,180	7,960	3,180	6,630	2,650	6,630	2,650	6,630	1,990	5,310	1,590	3,980	1,190
	RE8x16	5,970	2,690	5,970	2,690	4,970	2,240	4,970	2,240	4,970	1,690	3,980	1,350	2,980	1,010
	RE10x20	4,770	2,150	4,770	2,150	3,980	1,790	3,980	1,790	3,980	1,350	3,180	1,080	2,390	810
	RE12.5x25	3,820	1,720	3,820	1,720	3,180	1,430	3,180	1,430	3,180	1,080	2,550	870	1,910	650
	General 汎用条件	RE0.5x1	50,000	4,000	50,000	4,000	47,700	3,820	47,700	3,820	47,700	2,390	38,200	1,910	28,700
RE1x2		31,800	3,800	31,800	3,800	23,900	2,870	23,900	2,870	23,900	1,910	19,100	1,530	14,300	1,140
RE1.5x3		21,200	3,400	21,200	3,400	15,900	2,550	15,900	2,550	15,900	1,750	12,700	1,400	9,550	1,050
RE2x4		15,900	3,200	15,900	3,200	11,900	2,390	11,900	2,390	11,900	1,670	9,550	1,340	7,170	1,000
RE3x6		10,600	2,970	10,600	2,970	7,960	2,230	7,960	2,230	7,960	1,430	6,370	1,150	4,780	860
RE4x8		7,960	2,550	7,960	2,550	5,970	1,910	5,970	1,910	5,970	1,310	4,780	1,050	3,580	790
RE5x10		6,370	2,290	6,370	2,290	4,770	1,720	4,770	1,720	4,770	1,240	3,820	990	2,870	750
RE6x12		5,310	2,120	5,310	2,120	3,980	1,590	3,980	1,590	3,980	1,190	3,180	960	2,390	720
RE8x16		3,980	1,790	3,980	1,790	2,980	1,340	2,980	1,340	2,980	1,010	2,390	810	1,790	610
RE10x20		3,180	1,430	3,180	1,430	2,390	1,070	2,390	1,070	2,390	810	1,910	650	1,430	490
RE12.5x25		2,550	1,150	2,550	1,150	1,910	860	1,910	860	1,910	650	1,530	520	1,150	390

<仕上げ加工> Finishing

被削材 Work material	鋳鉄 Cast irons (150~200HB) FC250		炭素鋼 Carbon steels (180~220HB) SS400, S50C		合金鋼 Alloy steels (200~250HB) SCM440, SNCM		工具鋼 Tool steels (25~35HRC) SKD		プリハードン鋼 Pre-hardened steels (35~45HRC) HPM1, NAK55		焼入れ鋼 Hardened steels (45~55HRC) SKD61, SKT4		焼入れ鋼 Hardened steels (55~65HRC) SKD11, SKH51		
	切込み Depth of cut (mm)	ap=0.05DC, ae=0.05DC	ap=0.05DC, ae=0.05DC	ap=0.05DC, ae=0.05DC	ap=0.05DC, ae=0.05DC	ap=0.05DC, ae=0.05DC	ap=0.05DC, ae=0.05DC	ap=0.05DC, ae=0.05DC	ap=0.05DC, ae=0.05DC	ap=0.05DC, ae=0.05DC	ap=0.05DC, ae=0.05DC	ap=0.05DC, ae=0.05DC	ap=0.05DC, ae=0.05DC	ap=0.05DC, ae=0.05DC	
ボール半径RE ×外径DC Tool dia.(mm)	回転数 n (min ⁻¹)	送り速度 vf (mm/min)	回転数 n (min ⁻¹)	送り速度 vf (mm/min)	回転数 n (min ⁻¹)	送り速度 vf (mm/min)	回転数 n (min ⁻¹)	送り速度 vf (mm/min)	回転数 n (min ⁻¹)	送り速度 vf (mm/min)	回転数 n (min ⁻¹)	送り速度 vf (mm/min)	回転数 n (min ⁻¹)	送り速度 vf (mm/min)	
High speed 高速条件	RE0.5x1	50,000	4,000	50,000	4,000	50,000	4,000	50,000	4,000	50,000	2,500	50,000	2,500	50,000	2,500
	RE1x2	47,700	5,720	47,700	5,720	47,700	5,720	47,700	5,720	47,700	3,820	39,800	3,180	31,800	2,540
	RE1.5x3	31,800	5,090	31,800	5,090	31,800	5,090	31,800	5,090	31,800	3,500	26,500	2,920	21,200	2,330
	RE2x4	23,900	4,780	23,900	4,780	23,900	4,780	23,900	4,780	23,900	3,350	19,900	2,790	15,900	2,230
	RE3x6	15,900	4,450	15,900	4,450	15,900	4,450	15,900	4,450	15,900	2,860	13,300	2,390	10,600	1,910
	RE4x8	11,900	3,810	11,900	3,810	11,900	3,810	11,900	3,810	11,900	2,620	9,950	2,190	7,960	1,750
	RE5x10	9,550	3,440	9,550	3,440	9,550	3,440	9,550	3,440	9,550	2,480	7,960	2,070	6,370	1,660
	RE6x12	7,960	3,180	7,960	3,180	7,960	3,180	7,960	3,180	7,960	2,390	6,630	1,990	5,310	1,590
	RE8x16	5,970	2,690	5,970	2,690	5,970	2,690	5,970	2,690	5,970	2,030	4,970	1,690	3,980	1,350
	RE10x20	4,770	2,150	4,770	2,150	4,770	2,150	4,770	2,150	4,770	1,620	3,980	1,350	3,180	1,080
	RE12.5x25	3,820	1,720	3,820	1,720	3,820	1,720	3,820	1,720	3,820	1,300	3,180	1,080	2,550	870
	General 汎用条件	RE0.5x1	50,000	4,000	50,000	4,000	50,000	4,000	50,000	4,000	50,000	2,500	47,700	2,390	38,200
RE1x2		31,800	3,800	31,800	3,800	31,800	3,800	31,800	3,800	31,800	2,540	23,900	1,910	19,100	1,530
RE1.5x3		21,200	3,400	21,200	3,400	21,200	3,400	21,200	3,400	21,200	2,330	15,900	1,750	12,700	1,400
RE2x4		15,900	3,200	15,900	3,200	15,900	3,200	15,900	3,200	15,900	2,230	11,900	1,670	9,550	1,340
RE3x6		10,600	2,970	10,600	2,970	10,600	2,970	10,600	2,970	10,600	1,910	7,960	1,430	6,370	1,150
RE4x8		7,960	2,550	7,960	2,550	7,960	2,550	7,960	2,550	7,960	1,750	5,970	1,310	4,780	1,050
RE5x10		6,370	2,290	6,370	2,290	6,370	2,290	6,370	2,290	6,370	1,660	4,770	1,240	3,820	990
RE6x12		5,310	2,120	5,310	2,120	5,310	2,120	5,310	2,120	5,310	1,590	3,980	1,190	3,180	960
RE8x16		3,980	1,790	3,980	1,790	3,980	1,790	3,980	1,790	3,980	1,350	2,980	1,010	2,390	810
RE10x20		3,180	1,430	3,180	1,430	3,180	1,430	3,180	1,430	3,180	1,080	2,390	810	1,910	650
RE12.5x25		2,550	1,150	2,550	1,150	2,550	1,150	2,550	1,150	2,550	870	1,910	650	1,530	520

【注意】

- ①被削材、加工形状に合わせて、適切なクーラントを使用してください。
- ②この標準切削条件表は切削条件の目安を示すものです。実際の加工では加工形状、目的、使用機械等により条件を調整してください。
- ③切削方法は、ダウンカットで使用ください。
- ④一般材、とくに高速切削は、乾式（エアブロー）またはオイルミストクーラントにてご使用ください。
- ⑤安定した切削を行うため、剛性の高い機械とセットアップでご使用ください。
- ⑥機械の回転数が足りない場合は、主軸回転数とテーブル送り速度を同比率で下げてください。
- ⑦加工形状、機械の剛性、工具突き出し量等、ご使用の状況により、主軸回転数とテーブル送り速度の調整を行ってください。

CEPBLs

2枚刃・ロングシャンク
2ft, Long Shank

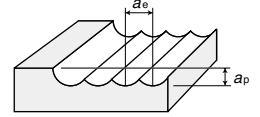

<荒加工> Roughing

被削材 Work material	鑄鉄 Cast irons (150~200HB) FC250		炭素鋼 Carbon steels (180~220HB) SS400, S50C		合金鋼 Alloy steels (200~250HB) SCM440, SNCM		工具鋼 Tool steels (25~35HRC) SKD		プリハードン鋼 Pre-hardened steels (35~45HRC) HPM1, NAK55		焼入れ鋼 Hardened steels (45~55HRC) SKD61, SKT4		焼入れ鋼 Hardened steels (55~65HRC) SKD11, SKH51	
切込み Depth of cut (mm)	ap=0.1DC, ae=0.3DC		ap=0.1DC, ae=0.3DC		ap=0.1DC, ae=0.3DC		ap=0.1DC, ae=0.3DC		ap=0.1DC, ae=0.3DC		ap=0.1DC, ae=0.3DC		ap=0.1DC, ae=0.3DC	
ボール半径RE ×外径DC Tool dia.(mm)	回転数 n (min ⁻¹)	送り速度 vf (mm/min)	回転数 n (min ⁻¹)	送り速度 vf (mm/min)	回転数 n (min ⁻¹)	送り速度 vf (mm/min)	回転数 n (min ⁻¹)	送り速度 vf (mm/min)	回転数 n (min ⁻¹)	送り速度 vf (mm/min)	回転数 n (min ⁻¹)	送り速度 vf (mm/min)	回転数 n (min ⁻¹)	送り速度 vf (mm/min)
高速条件 High speed	RE0.5×1	47,700	3,820	47,700	3,820	39,800	3,180	39,800	3,180	39,800	1,990	31,800	1,590	23,900
	RE1×2	23,900	2,870	23,900	2,870	19,900	2,390	19,900	2,390	19,900	1,590	15,900	1,270	11,900
	RE1.5×3	15,900	2,550	15,900	2,550	13,300	2,130	13,300	2,130	13,300	1,460	10,600	1,170	7,960
	RE2×4	11,900	2,390	11,900	2,390	9,950	1,990	9,950	1,990	9,950	1,390	7,960	1,110	5,970
	RE3×6	7,960	2,230	7,960	2,230	6,630	1,860	6,630	1,860	6,630	1,190	5,300	950	3,980
	RE4×8	5,970	1,910	5,970	1,910	4,980	1,590	4,980	1,590	4,980	1,100	3,980	880	2,980
	RE5×10	4,770	1,720	4,770	1,720	3,980	1,430	3,980	1,430	3,980	1,030	3,180	830	2,390
	RE6×12	3,980	1,590	3,980	1,590	3,320	1,330	3,320	1,330	3,320	1,000	2,650	800	1,990
	RE8×16	2,980	1,340	2,980	1,340	2,490	1,120	2,490	1,120	2,490	850	1,990	680	1,490
	RE10×20	2,390	1,070	2,390	1,070	1,990	900	1,990	900	1,990	680	1,590	540	1,190
	RE12.5×25	1,910	860	1,910	860	1,590	720	1,590	720	1,590	540	1,270	430	950
	汎用条件 General	RE0.5×1	31,800	2,540	31,800	2,540	23,900	1,910	23,900	1,910	23,900	1,200	19,100	960
RE1×2		15,900	1,910	15,900	1,910	11,900	1,430	11,900	1,430	11,900	950	9,550	760	7,160
RE1.5×3		10,600	1,700	10,600	1,700	7,960	1,270	7,960	1,270	7,960	880	6,370	700	4,770
RE2×4		7,960	1,590	7,960	1,590	5,970	1,190	5,970	1,190	5,970	840	4,770	670	3,580
RE3×6		5,310	1,490	5,310	1,490	3,980	1,110	3,980	1,110	3,980	720	3,180	570	2,390
RE4×8		3,980	1,270	3,980	1,270	2,980	950	2,980	950	2,980	660	2,390	530	1,790
RE5×10		3,180	1,140	3,180	1,140	2,390	860	2,390	860	2,390	620	1,910	500	1,430
RE6×12		2,650	1,060	2,650	1,060	1,990	800	1,990	800	1,990	600	1,590	480	1,190
RE8×16		1,990	900	1,990	900	1,490	670	1,490	670	1,490	510	1,190	400	900
RE10×20		1,590	720	1,590	720	1,190	540	1,190	540	1,190	400	950	320	720
RE12.5×25		1,270	570	1,270	570	950	430	950	430	950	320	760	260	570

<仕上げ加工> Finishing

被削材 Work material	鑄鉄 Cast irons (150~200HB) FC250		炭素鋼 Carbon steels (180~220HB) SS400, S50C		合金鋼 Alloy steels (200~250HB) SCM440, SNCM		工具鋼 Tool steels (25~35HRC) SKD		プリハードン鋼 Pre-hardened steels (35~45HRC) HPM1, NAK55		焼入れ鋼 Hardened steels (45~55HRC) SKD61, SKT4		焼入れ鋼 Hardened steels (55~65HRC) SKD11, SKH51	
切込み Depth of cut (mm)	ap=0.05DC, ae=0.05DC		ap=0.05DC, ae=0.05DC		ap=0.05DC, ae=0.05DC		ap=0.05DC, ae=0.05DC		ap=0.05DC, ae=0.05DC		ap=0.05DC, ae=0.05DC		ap=0.05DC, ae=0.05DC	
ボール半径RE ×外径DC Tool dia.(mm)	回転数 n (min ⁻¹)	送り速度 vf (mm/min)	回転数 n (min ⁻¹)	送り速度 vf (mm/min)	回転数 n (min ⁻¹)	送り速度 vf (mm/min)	回転数 n (min ⁻¹)	送り速度 vf (mm/min)	回転数 n (min ⁻¹)	送り速度 vf (mm/min)	回転数 n (min ⁻¹)	送り速度 vf (mm/min)	回転数 n (min ⁻¹)	送り速度 vf (mm/min)
高速条件 High speed	RE0.5×1	47,700	3,820	47,700	3,820	47,700	3,820	47,700	3,820	47,700	2,390	39,800	1,990	31,800
	RE1×2	23,900	2,870	23,900	2,870	23,900	2,870	23,900	2,870	23,900	1,910	19,900	1,590	15,900
	RE1.5×3	15,900	2,550	15,900	2,550	15,900	2,550	15,900	2,550	15,900	1,750	13,300	1,460	10,600
	RE2×4	11,900	2,390	11,900	2,390	11,900	2,390	11,900	2,390	11,900	1,670	9,950	1,390	7,960
	RE3×6	7,960	2,230	7,960	2,230	7,960	2,230	7,960	2,230	7,960	1,430	6,630	1,190	5,300
	RE4×8	5,970	1,910	5,970	1,910	5,970	1,910	5,970	1,910	5,970	1,310	4,980	1,100	3,980
	RE5×10	4,770	1,720	4,770	1,720	4,770	1,720	4,770	1,720	4,770	1,240	3,980	1,030	3,180
	RE6×12	3,980	1,590	3,980	1,590	3,980	1,590	3,980	1,590	3,980	1,190	3,320	1,000	2,650
	RE8×16	2,980	1,340	2,980	1,340	2,980	1,340	2,980	1,340	2,980	1,010	2,490	850	1,990
	RE10×20	2,390	1,070	2,390	1,070	2,390	1,070	2,390	1,070	2,390	810	1,990	680	1,590
	RE12.5×25	1,910	860	1,910	860	1,910	860	1,910	860	1,910	650	1,590	540	1,270
	汎用条件 General	RE0.5×1	31,800	2,540	31,800	2,540	31,800	2,540	31,800	2,540	31,800	1,590	23,900	1,200
RE1×2		15,900	1,910	15,900	1,910	15,900	1,910	15,900	1,910	15,900	1,270	11,900	950	9,550
RE1.5×3		10,600	1,700	10,600	1,700	10,600	1,700	10,600	1,700	10,600	1,170	7,960	880	6,370
RE2×4		7,960	1,590	7,960	1,590	7,960	1,590	7,960	1,590	7,960	1,110	5,970	840	4,770
RE3×6		5,310	1,490	5,310	1,490	5,310	1,490	5,310	1,490	5,300	950	3,980	720	3,180
RE4×8		3,980	1,270	3,980	1,270	3,980	1,270	3,980	1,270	3,980	880	2,980	660	2,390
RE5×10		3,180	1,140	3,180	1,140	3,180	1,140	3,180	1,140	3,180	830	2,980	620	1,910
RE6×12		2,650	1,060	2,650	1,060	2,650	1,060	2,650	1,060	2,650	800	1,990	600	1,590
RE8×16		1,990	900	1,990	900	1,990	900	1,990	900	1,990	680	1,490	510	1,190
RE10×20		1,590	720	1,590	720	1,590	720	1,590	720	1,590	540	1,190	400	950
RE12.5×25		1,270	570	1,270	570	1,270	570	1,270	570	1,270	430	950	320	760

[Note]

- ① Use the appropriate coolant for the work material and machining shape.
- ② These Recommended Cutting Conditions indicate only the rule of a thumb for the cutting conditions. In actual machining, the condition should be adjusted according to the machining shape, purpose and the machine type.
- ③ Down-cutting is recommended.
- ④ Use generally dry (air-blow) or oil-mist coolant, especially at the high-speed machining.
- ⑤ Use a machine tool with rigidity and rigid set-up, to machine stably.
- ⑥ When the revolution speed is not enough, reduce the revolution speed and table speed at the same ratio.
- ⑦ Adjust the revolution speed and table speed, according to cutting conditions such as machining shape, rigidity of machine tool, over-hang and so on.

Epoch Ball End Mill エポックボールエンドミル

CEPB4

4枚刃・レギュラー刃長
4ft, Regular

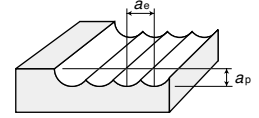

<荒加工> Roughing

被削材 Work material	鋳鉄 Cast irons (150~200HB) FC250		炭素鋼 Carbon steels (180~220HB) SS400, S50C		合金鋼 Alloy steels (200~250HB) SCM440, SNCM		工具鋼 Tool steels (25~35HRC) SKD		プリハードン鋼 Pre-hardened steels (35~45HRC) HPM1, NAK55		焼入れ鋼 Hardened steels (45~55HRC) SKD61, SKT4		焼入れ鋼 Hardened steels (55~65HRC) SKD11, SKH51		
	切込み Depth of cut (mm) ap=0.1DC ae=0.3DC		ap=0.1DC ae=0.3DC		ap=0.1DC ae=0.3DC		ap=0.1DC ae=0.3DC		ap=0.1DC ae=0.3DC		ap=0.1DC ae=0.3DC		ap=0.1DC ae=0.3DC		
ボール半径RE ×外径DC Tool dia.(mm)	回転数 n (min ⁻¹)	送り速度 vf (mm/min)	回転数 n (min ⁻¹)	送り速度 vf (mm/min)	回転数 n (min ⁻¹)	送り速度 vf (mm/min)	回転数 n (min ⁻¹)	送り速度 vf (mm/min)	回転数 n (min ⁻¹)	送り速度 vf (mm/min)	回転数 n (min ⁻¹)	送り速度 vf (mm/min)	回転数 n (min ⁻¹)	送り速度 vf (mm/min)	
高速条件 High speed	RE3×6	15,900	6,680	15,900	6,680	13,300	5,580	13,300	5,580	13,300	3,590	10,600	2,870	7,960	2,150
	RE4×8	11,900	5,720	11,900	5,720	9,950	4,770	9,950	4,770	9,950	3,290	7,960	2,630	5,970	1,970
	RE5×10	9,550	5,160	9,550	5,160	7,960	4,310	7,960	4,310	7,960	3,110	6,370	2,490	4,770	1,860
	RE6×12	7,960	4,770	7,960	4,770	6,630	3,980	6,630	3,980	6,630	2,990	5,310	2,390	3,980	1,790
汎用条件 General	RE3×6	10,600	4,460	10,600	4,460	7,960	3,350	7,960	3,350	7,960	2,150	6,370	1,730	4,780	1,290
	RE4×8	7,960	3,830	7,960	3,830	5,970	2,870	5,970	2,870	5,970	1,970	4,780	1,580	3,580	1,190
	RE5×10	6,370	3,440	6,370	3,440	4,770	2,580	4,770	2,580	4,770	1,860	3,820	1,490	2,870	1,130
	RE6×12	5,310	3,180	5,310	3,180	3,980	2,390	3,980	2,390	3,980	1,790	3,180	1,440	2,390	1,080

<仕上げ加工> Finishing

被削材 Work material	鋳鉄 Cast irons (150~200HB) FC250		炭素鋼 Carbon steels (180~220HB) SS400, S50C		合金鋼 Alloy steels (200~250HB) SCM440, SNCM		工具鋼 Tool steels (25~35HRC) SKD		プリハードン鋼 Pre-hardened steels (35~45HRC) HPM1, NAK55		焼入れ鋼 Hardened steels (45~55HRC) SKD61, SKT4		焼入れ鋼 Hardened steels (55~65HRC) SKD11, SKH51		
	切込み Depth of cut (mm) ap=0.05DC ae=0.05DC		ap=0.05DC ae=0.05DC		ap=0.05DC ae=0.05DC		ap=0.05DC ae=0.05DC		ap=0.05DC ae=0.05DC		ap=0.05DC ae=0.05DC		ap=0.05DC ae=0.05DC		
ボール半径RE ×外径DC Tool dia.(mm)	回転数 n (min ⁻¹)	送り速度 vf (mm/min)	回転数 n (min ⁻¹)	送り速度 vf (mm/min)	回転数 n (min ⁻¹)	送り速度 vf (mm/min)	回転数 n (min ⁻¹)	送り速度 vf (mm/min)	回転数 n (min ⁻¹)	送り速度 vf (mm/min)	回転数 n (min ⁻¹)	送り速度 vf (mm/min)	回転数 n (min ⁻¹)	送り速度 vf (mm/min)	
高速条件 High speed	RE3×6	15,900	6,680	15,900	6,680	15,900	6,680	15,900	6,680	15,900	4,290	13,300	3,590	10,600	2,870
	RE4×8	11,900	5,720	11,900	5,720	11,900	5,720	11,900	5,720	11,900	3,930	9,950	3,290	7,960	2,630
	RE5×10	9,550	5,160	9,550	5,160	9,550	5,160	9,550	5,160	9,550	3,720	7,960	3,110	6,370	2,490
	RE6×12	7,960	4,770	7,960	4,770	7,960	4,770	7,960	4,770	7,960	3,590	6,630	2,990	5,310	2,390
汎用条件 General	RE3×6	10,600	4,460	10,600	4,460	10,600	4,460	10,600	4,460	10,600	2,870	7,960	2,150	6,370	1,730
	RE4×8	7,960	3,830	7,960	3,830	7,960	3,830	7,960	3,830	7,960	2,630	5,970	1,970	4,780	1,580
	RE5×10	6,370	3,440	6,370	3,440	6,370	3,440	6,370	3,440	6,370	2,490	4,770	1,860	3,820	1,490
	RE6×12	5,310	3,180	5,310	3,180	5,310	3,180	5,310	3,180	5,310	2,390	3,980	1,790	3,180	1,440

【注意】

- 被削材、加工形状に合わせて、適切なクーラントを使用してください。
- この標準切削条件表は切削条件の目安を示すものです。実際の加工では加工形状、目的、使用機械等により条件を調整してください。
- 切削方法は、ダウンカットで使用ください。
- 一般材、とくに高速切削は、乾式（エアブロー）またはオイルミストクーラントにてご使用ください。
- 安定した切削を行うため、剛性の高い機械とセットアップでご使用ください。
- 機械の回転数が足りない場合は、主軸回転数とテーブル送り速度を同比率で下げてください。
- 加工形状、機械の剛性、工具突き出し量等、ご使用の状況により、主軸回転数とテーブル送り速度の調整を行ってください。

【Note】

- Use the appropriate coolant for the work material and machining shape.
- These Recommended Cutting Conditions indicate only the rule of a thumb for the cutting conditions. In actual machining, the condition should be adjusted according to the machining shape, purpose and the machine type.
- Down-cutting is recommended.
- Use generally dry (air-blow) or oil-mist coolant, especially at the high-speed machining.
- Use a machine tool with rigidity and rigid set-up, to machine stably.
- When the revolution speed is not enough, reduce the revolution speed and table speed at the same ratio.
- Adjust the revolution speed and table speed, according to cutting conditions such as machining shape, rigidity of machine tool, over-hang and so on.

C Coating Carbide Ball End Mills

超硬・Cコートボールエンドミル

強力形・ショート刃長 Powerful type, Short

膨込み Die-sinking 曲面 Profiling R Radius ヘリカル Helical 中仕上 Semi Finishing 仕上 Finishing

RE公差 RE tolerance RE0.15~RE0.4 : ±0.007
RE0.5~RE5 : ±0.005
RE5.5~RE10 : ±0.01

h6 I

(mm)

2枚刃
2Flutes



強力形・ロングシャンク Powerful type, Long shank

膨込み Die-sinking 曲面 Profiling R Radius ヘリカル Helical 取りのこし Rest Material Machining 玉抜き Corner Recessing 仕上 Finishing

RE公差 RE tolerance RE0.5~RE6 : ±0.015
RE8~RE12.5 : ±0.02

h6 I

(mm)

2枚刃
2Flutes



BEK2○○○○-C

超硬 Carbide C ねじれ30° Helix angle 切削条件表 A416 Cutting Conditions

商品コード Item code	在庫 Stock	寸法 Size (mm)				
		ボール半径 Ball radius	外径 Tool dia.	刃長 Flute length	全長 Overall length	シャンク径 Shank dia.
BEK2003-C	<input type="checkbox"/>	0.15	0.3	0.6	50	3
BEK2004-C	<input type="checkbox"/>	0.2	0.4	0.8	50	3
BEK2005-C	<input type="checkbox"/>	0.25	0.5	1	50	3
BEK2006-C	<input type="checkbox"/>	0.3	0.6	1.2	50	3
BEK2008-C	<input type="checkbox"/>	0.4	0.8	1.6	50	3
BEK2010-C	<input type="checkbox"/>	0.5	1	2.5	50	4
BEK2015-C	<input type="checkbox"/>	0.75	1.5	4	50	4
BEK2020-C	<input type="checkbox"/>	1	2	5	50	6
BEK2025-C	<input type="checkbox"/>	1.25	2.5	7	50	6
BEK2030-C	<input type="checkbox"/>	1.5	3	8	70	6
BEK2040-C	<input type="checkbox"/>	2	4	8	70	6
BEK2050-C	<input type="checkbox"/>	2.5	5	10	80	6
BEK2060-C	<input type="checkbox"/>	3	6	12	90	6
BEK2070-C	<input type="checkbox"/>	3.5	7	14	90	6
BEK2080-C	<input type="checkbox"/>	4	8	14	100	8
BEK2090-C	<input type="checkbox"/>	4.5	9	18	100	8
BEK2100-C	<input type="checkbox"/>	5	10	18	100	10
BEK2110-C	<input type="checkbox"/>	5.5	11	18	110	10
BEK2120-C	<input type="checkbox"/>	6	12	22	110	12
BEK2130-C	<input type="checkbox"/>	6.5	13	22	110	12
BEK2140-C	<input type="checkbox"/>	7	14	26	120	12
BEK2160-C	<input type="checkbox"/>	8	16	30	140	16
BEK2180-C	<input type="checkbox"/>	9	18	34	140	16
BEK2200-C	<input type="checkbox"/>	10	20	38	160	20

BEKLS2○○○○-C

超硬 Carbide C ねじれ30° Helix angle 切削条件表 A416 Cutting Conditions

商品コード Item code	在庫 Stock	寸法 Size (mm)				
		ボール半径 Ball radius	外径 Tool dia.	刃長 Flute length	全長 Overall length	シャンク径 Shank dia.
BEKLS2010-C	<input type="checkbox"/>	0.5	1	2.5	80	4
BEKLS2015-C	<input type="checkbox"/>	0.75	1.5	4	80	4
BEKLS2020-C	<input type="checkbox"/>	1	2	5	90	6
BEKLS2025-C	<input type="checkbox"/>	1.25	2.5	7	90	6
BEKLS2030-C	<input type="checkbox"/>	1.5	3	8	100	6
BEKLS2040-C	<input type="checkbox"/>	2	4	8	100	6
BEKLS2050-C	<input type="checkbox"/>	2.5	5	10	125	6
BEKLS2060-C	<input type="checkbox"/>	3	6	12	150	6
BEKLS2070-C	<input type="checkbox"/>	3.5	7	14	150	6
BEKLS2080-C	<input type="checkbox"/>	4	8	14	180	8
BEKLS2100-C	<input type="checkbox"/>	5	10	18	200	10
BEKLS2120-C	<input type="checkbox"/>	6	12	22	220	12
BEKLS2160-C	<input type="checkbox"/>	8	16	30	250	16
BEKLS2200-C	<input type="checkbox"/>	10	20	38	280	20
BEKLS2250-C	<input type="checkbox"/>	12.5	25	50	300	25

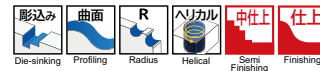

RE公差 RE tolerance ±0.01

h6 I

(mm)

2枚刃
2Flutes



BES2○○○○-C

超硬 Carbide C ねじれ30° Helix angle

商品コード Item code	在庫 Stock	寸法 Size (mm)				
		ボール半径 Ball radius	外径 Tool dia.	刃長 Flute length	全長 Overall length	シャンク径 Shank dia.
BES2010-C	<input type="checkbox"/>	0.5	1	2.5	50	4
BES2020-C	<input type="checkbox"/>	1	2	5	50	6
BES2030-C	<input type="checkbox"/>	1.5	3	8	70	6
BES2040-C	<input type="checkbox"/>	2	4	12	70	6
BES2050-C	<input type="checkbox"/>	2.5	5	15	80	6
BES2060-C	<input type="checkbox"/>	3	6	15	90	6
BES2070-C	<input type="checkbox"/>	3.5	7	20	90	6
BES2080-C	<input type="checkbox"/>	4	8	20	100	8
BES2100-C	<input type="checkbox"/>	5	10	25	100	10
BES2120-C	<input type="checkbox"/>	6	12	30	110	12
BES2140-C	<input type="checkbox"/>	7	14	35	120	12
BES2160-C	<input type="checkbox"/>	8	16	40	140	16
BES2180-C	<input type="checkbox"/>	9	18	40	140	16
BES2200-C	<input type="checkbox"/>	10	20	45	160	20
BES2250-C	<input type="checkbox"/>	12.5	25	50	180	25

BEK-C、BEKLS-C、BES-Cの対応被削材

Applicable work material of BEK-C, BEKLS-C, BES-C

炭素鋼 合金鋼 Carbon steel Alloy steel	プリハー ド鋼 Pre-hardened steel	高硬度 Hardened steel			ステン レス鋼 Stainless steel	チタン合金 耐熱合金 Titanium alloy Heat-resistant alloy	銅合金 Copper alloy	アルミ 合金 Aluminum alloy
		> 45HRC ≤ 45HRC	> 55HRC ≤ 55HRC	> 65HRC				
○	○	○	○	○	○	○	○	

○印：特定代理店在庫です。弊社営業へお問合せください。

□：Stocked by specified distributor. Contact with our sales department.

Carbide End Mills

Stocked by Specified distributor

C Coating Carbide Ball End Mills

超硬・Cコートボールエンドミル

標準切削条件表 Recommended cutting conditions

BEK-C

強力形・レギュラー刃長
Powerful type, Regular

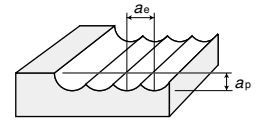

<荒加工> Roughing

被削材 Work material	鋳鉄 Cast irons (150~200HB) FC250		炭素鋼 Carbon steels (180~220HB) SS400, S50C		合金鋼 Alloy steels (200~250HB) SCM440, SNCM		工具鋼 Tool steels (25~35HRC) SKD		プリハードン鋼 Pre-hardened steels (35~45HRC) HPM1, NAK55		焼入れ鋼 Hardened steels (45~55HRC) SKD61, SKT4		
	ap=0.1DC	ae=0.3DC	ap=0.1DC	ae=0.3DC	ap=0.1DC	ae=0.3DC	ap=0.1DC	ae=0.3DC	ap=0.1DC	ae=0.3DC	ap=0.1DC	ae=0.3DC	
切込み Depth of cut (mm)	ap=0.1DC	ae=0.3DC	ap=0.1DC	ae=0.3DC	ap=0.1DC	ae=0.3DC	ap=0.1DC	ae=0.3DC	ap=0.1DC	ae=0.3DC	ap=0.1DC	ae=0.3DC	
ボール半径RE×外径DC Tool dia. (mm)	回転数n (min ⁻¹)	送り速度vf (mm/min)	回転数n (min ⁻¹)	送り速度vf (mm/min)	回転数n (min ⁻¹)	送り速度vf (mm/min)	回転数n (min ⁻¹)	送り速度vf (mm/min)	回転数n (min ⁻¹)	送り速度vf (mm/min)	回転数n (min ⁻¹)	送り速度vf (mm/min)	
高速条件 High speed	RE0.5×1	50,000	4,000	50,000	4,000	50,000	4,000	50,000	4,000	50,000	2,500	38,200	1,910
	RE1×2	47,700	5,720	47,700	5,720	39,800	4,780	39,800	4,780	39,800	3,180	19,100	1,530
	RE1.5×3	31,800	5,090	31,800	5,090	26,500	4,240	26,500	4,240	26,500	2,920	12,700	1,400
	RE2×4	23,900	4,780	23,900	4,780	19,900	3,980	19,900	3,980	19,900	2,790	9,550	1,340
	RE3×6	15,900	4,450	15,900	4,450	13,300	3,720	13,300	3,720	13,300	2,390	6,370	1,150
	RE4×8	11,900	3,810	11,900	3,810	9,950	3,180	9,950	3,180	9,950	2,190	4,780	1,050
	RE5×10	9,550	3,440	9,550	3,440	7,960	2,870	7,960	2,870	7,960	2,070	3,820	990
	RE6×12	7,960	3,180	7,960	3,180	6,630	2,650	6,630	2,650	6,630	1,990	3,180	960
	RE8×16	5,970	2,690	5,970	2,690	4,970	2,240	4,970	2,240	4,970	1,690	2,390	810
RE10×20	4,770	2,150	4,770	2,150	3,980	1,790	3,980	1,790	3,980	1,350	1,910	650	
汎用条件 General	RE0.5×1	50,000	4,000	50,000	4,000	47,700	3,820	47,700	3,820	47,700	2,390	25,500	1,280
	RE1×2	31,800	3,800	31,800	3,800	23,900	2,870	23,900	2,870	23,900	1,910	12,700	1,020
	RE1.5×3	21,200	3,400	21,200	3,400	15,900	2,550	15,900	2,550	15,900	1,750	8,490	930
	RE2×4	15,900	3,200	15,900	3,200	11,900	2,390	11,900	2,390	11,900	1,670	6,370	890
	RE3×6	10,600	2,970	10,600	2,970	7,960	2,230	7,960	2,230	7,960	1,430	4,240	760
	RE4×8	7,960	2,550	7,960	2,550	5,970	1,910	5,970	1,910	5,970	1,310	3,180	700
	RE5×10	6,370	2,290	6,370	2,290	4,770	1,720	4,770	1,720	4,770	1,240	2,550	660
	RE6×12	5,310	2,120	5,310	2,120	3,980	1,590	3,960	1,590	3,980	1,190	2,120	640
	RE8×16	3,980	1,790	3,980	1,790	2,980	1,340	2,980	1,340	2,980	1,010	1,590	540
RE10×20	3,180	1,430	3,180	1,430	2,390	1,070	2,390	1,070	2,390	810	1,270	430	

<仕上げ加工> Finishing

被削材 Work material	鋳鉄 Cast irons (150~200HB) FC250		炭素鋼 Carbon steels (180~220HB) SS400, S50C		合金鋼 Alloy steels (200~250HB) SCM440, SNCM		工具鋼 Tool steels (25~35HRC) SKD		プリハードン鋼 Pre-hardened steels (35~45HRC) HPM1, NAK55		焼入れ鋼 Hardened steels (45~55HRC) SKD61, SKT4		
	ap=0.05DC	ae=0.05DC	ap=0.05DC	ae=0.05DC	ap=0.05DC	ae=0.05DC	ap=0.05DC	ae=0.05DC	ap=0.05DC	ae=0.05DC	ap=0.05DC	ae=0.05DC	
切込み Depth of cut (mm)	ap=0.05DC	ae=0.05DC	ap=0.05DC	ae=0.05DC	ap=0.05DC	ae=0.05DC	ap=0.05DC	ae=0.05DC	ap=0.05DC	ae=0.05DC	ap=0.05DC	ae=0.05DC	
ボール半径RE×外径DC Tool dia. (mm)	回転数n (min ⁻¹)	送り速度vf (mm/min)	回転数n (min ⁻¹)	送り速度vf (mm/min)	回転数n (min ⁻¹)	送り速度vf (mm/min)	回転数n (min ⁻¹)	送り速度vf (mm/min)	回転数n (min ⁻¹)	送り速度vf (mm/min)	回転数n (min ⁻¹)	送り速度vf (mm/min)	
高速条件 High speed	RE0.5×1	50,000	4,000	50,000	4,000	50,000	4,000	50,000	4,000	50,000	2,500	47,700	2,390
	RE1×2	47,700	5,720	47,700	5,720	47,700	5,720	47,700	5,720	47,700	3,820	23,900	1,910
	RE1.5×3	31,800	5,090	31,800	5,090	31,800	5,090	31,800	5,090	31,800	3,500	15,900	1,750
	RE2×4	23,900	4,780	23,900	4,780	23,900	4,780	23,900	4,780	23,900	3,350	11,900	1,670
	RE3×6	15,900	4,450	15,900	4,450	15,900	4,450	15,900	4,450	15,900	2,860	7,960	1,430
	RE4×8	11,900	3,810	11,900	3,810	11,900	3,810	11,900	3,810	11,900	2,620	5,970	1,310
	RE5×10	9,550	3,440	9,550	3,440	9,550	3,440	9,550	3,440	9,550	2,480	4,770	1,240
	RE6×12	7,960	3,180	7,960	3,180	7,960	3,180	7,960	3,180	7,960	2,390	3,980	1,190
	RE8×16	5,970	2,690	5,970	2,690	5,970	2,690	5,970	2,690	5,970	2,030	2,980	1,010
RE10×20	4,770	2,150	4,770	2,150	4,770	2,150	4,770	2,150	4,770	1,620	2,390	810	
汎用条件 General	RE0.5×1	50,000	4,000	50,000	4,000	50,000	4,000	50,000	4,000	50,000	2,500	31,800	1,590
	RE1×2	31,800	3,800	31,800	3,800	31,800	3,800	31,800	3,800	31,800	2,540	15,900	1,270
	RE1.5×3	21,200	3,400	21,200	3,400	21,200	3,400	21,200	3,400	21,200	2,330	10,600	1,170
	RE2×4	15,900	3,200	15,900	3,200	15,900	3,200	15,900	3,200	15,900	2,230	7,960	1,110
	RE3×6	10,600	2,970	10,600	2,970	10,600	2,970	10,600	2,970	10,600	1,910	5,310	960
	RE4×8	7,960	2,550	7,960	2,550	7,960	2,550	7,960	2,550	7,960	1,750	3,980	880
	RE5×10	6,370	2,290	6,370	2,290	6,370	2,290	6,370	2,290	6,370	1,660	3,180	830
	RE6×12	5,310	2,120	5,310	2,120	5,310	2,120	5,310	2,120	5,310	1,590	2,650	800
	RE8×16	3,980	1,790	3,980	1,790	3,980	1,790	3,980	1,790	3,980	1,350	1,990	680
RE10×20	3,180	1,430	3,180	1,430	3,180	1,430	3,180	1,430	3,180	1,080	1,590	540	

- [注意]**
- 被削材、加工形状に合わせて、適切なクーラントを使用してください。
 - この標準切削条件表は切削条件の目安を示すものです。実際の加工では加工形状、目的、使用機械等により条件を調整してください。
 - 切削方法は、ダウンカットで使用ください。
 - 一般材、とくに高速切削は、乾式(エアブロー)またはオイルミストクーラントにてご使用ください。
 - 安定した切削を行うため、剛性の高い機械とセットアップでご使用ください。
 - 機械の回転数が足りない場合は、主軸回転数とテーブル送り速度を同比率で下げてください。
 - 加工形状、機械の剛性、工具突き出し量等、ご使用の状況により、主軸回転数とテーブル送り速度の調整を行ってください。

- [Note]**
- Use the appropriate coolant for the work material and machining shape.
 - These Recommended Cutting Conditions indicate only the rule of a thumb for the cutting conditions. In actual machining, the condition should be adjusted according to the machining shape, purpose and the machine type.
 - Down-cutting is recommended.
 - Use generally dry (air-blow) or oil-mist coolant, especially at the high-speed machining.
 - Use a machine tool with rigidity and rigid set-up, to machine stably.
 - When the revolution speed is not enough, reduce the revolution speed and table speed at the same ratio.
 - Adjust the revolution speed and table speed, according to cutting conditions such as machining shape, rigidity of machine tool, over-hang and so on.

BEKLS-C

強力形・ロングシャンク
Powerful type, Long Shank

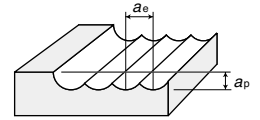

Carbide End Mills

Stocked by Specified distributor

< 荒加工 > Roughing

被削材 Work material	鋳鉄 Cast irons (150~200HB) FC250		炭素鋼 Carbon steels (180~220HB) SS400, S50C		合金鋼 Alloy steels (200~250HB) SCM440, SNCM		ステンレス鋼・工具鋼 Stainless steels, Tool steels (25~35HRC) SUS304, SKD		プリハードン鋼 Pre-hardened steels (35~45HRC) HPM1, NAK55		焼入れ鋼 Hardened steels (45~55HRC) SKD61, SKT4		
	ap=0.1DC	ae=0.3DC	ap=0.1DC	ae=0.3DC	ap=0.1DC	ae=0.3DC	ap=0.1DC	ae=0.3DC	ap=0.1DC	ae=0.3DC	ap=0.1DC	ae=0.3DC	
切込み Depth of cut (mm)	ap=0.1DC ae=0.3DC		ap=0.1DC ae=0.3DC		ap=0.1DC ae=0.3DC		ap=0.1DC ae=0.3DC		ap=0.1DC ae=0.3DC		ap=0.1DC ae=0.3DC		
ポール半径RE×外径DC Tool dia.(mm)	回転数n (min ⁻¹)	送り速度vf (mm/min)	回転数n (min ⁻¹)	送り速度vf (mm/min)	回転数n (min ⁻¹)	送り速度vf (mm/min)	回転数n (min ⁻¹)	送り速度vf (mm/min)	回転数n (min ⁻¹)	送り速度vf (mm/min)	回転数n (min ⁻¹)	送り速度vf (mm/min)	
高速条件 High speed	RE0.5×1	47,700	3,820	47,700	3,820	39,800	3,180	39,800	3,180	39,800	1,990	31,800	1,590
	RE1×2	23,900	2,870	23,900	2,870	19,900	2,390	19,900	2,390	19,900	1,590	15,900	1,270
	RE1.5×3	15,900	2,550	15,900	2,550	13,300	2,130	13,300	2,130	13,300	1,460	10,600	1,170
	RE2×4	11,900	2,390	11,900	2,390	9,950	1,990	9,950	1,990	9,950	1,390	7,960	1,110
	RE3×6	7,960	2,230	7,960	2,230	6,630	1,860	6,630	1,860	6,630	1,190	5,300	950
	RE4×8	5,970	1,910	5,970	1,910	4,980	1,590	4,980	1,590	4,980	1,100	3,980	880
	RE5×10	4,770	1,720	4,770	1,720	3,980	1,430	3,980	1,430	3,980	1,030	3,180	830
	RE6×12	3,980	1,590	3,980	1,590	3,320	1,330	3,320	1,330	3,320	1,000	2,650	800
	RE8×16	2,980	1,340	2,980	1,340	2,490	1,120	2,490	1,120	2,490	850	1,990	680
	RE10×20	2,390	1,070	2,390	1,070	1,990	900	1,990	900	1,990	680	1,590	540
RE12.5×25	1,910	860	1,910	860	1,590	720	1,590	720	1,590	540	1,270	430	
汎用条件 General	RE0.5×1	31,800	2,540	31,800	2,540	23,900	1,910	23,900	1,910	23,900	1,200	19,100	960
	RE1×2	15,900	1,910	15,900	1,910	11,900	1,430	11,900	1,430	11,900	950	9,550	760
	RE1.5×3	10,600	1,700	10,600	1,700	7,960	1,270	7,960	1,270	7,960	800	6,370	700
	RE2×4	7,960	1,590	7,960	1,590	5,970	1,190	5,970	1,190	5,970	840	4,770	670
	RE3×6	5,310	1,490	5,310	1,490	3,980	1,110	3,980	1,110	3,980	720	3,180	570
	RE4×8	3,980	1,270	3,980	1,270	2,980	950	2,980	950	2,980	660	2,390	530
	RE5×10	3,180	1,140	3,180	1,140	2,390	860	2,390	860	2,390	620	1,910	500
	RE6×12	2,650	1,060	2,650	1,060	1,990	800	1,990	800	1,990	600	1,590	480
	RE8×16	1,990	900	1,990	900	1,490	670	1,490	670	1,490	510	1,190	400
	RE10×20	1,590	720	1,590	720	1,190	540	1,190	540	1,190	400	950	320
RE12.5×25	1,270	570	1,270	570	950	430	950	430	950	320	760	260	

< 仕上げ加工 > Finishing

被削材 Work material	鋳鉄 Cast irons (150~200HB) FC250		炭素鋼 Carbon steels (180~220HB) SS400, S50C		合金鋼 Alloy steels (200~250HB) SCM440, SNCM		ステンレス鋼・工具鋼 Stainless steels, Tool steels (25~35HRC) SUS304, SKD		プリハードン鋼 Pre-hardened steels (35~45HRC) HPM1, NAK55		焼入れ鋼 Hardened steels (45~55HRC) SKD61, SKT4		
	ap=0.05DC	ae=0.05DC	ap=0.05DC	ae=0.05DC	ap=0.05DC	ae=0.05DC	ap=0.05DC	ae=0.05DC	ap=0.05DC	ae=0.05DC	ap=0.05DC	ae=0.05DC	
切込み Depth of cut (mm)	ap=0.05DC ae=0.05DC		ap=0.05DC ae=0.05DC		ap=0.05DC ae=0.05DC		ap=0.05DC ae=0.05DC		ap=0.05DC ae=0.05DC		ap=0.05DC ae=0.05DC		
ポール半径RE×外径DC Tool dia.(mm)	回転数n (min ⁻¹)	送り速度vf (mm/min)	回転数n (min ⁻¹)	送り速度vf (mm/min)	回転数n (min ⁻¹)	送り速度vf (mm/min)	回転数n (min ⁻¹)	送り速度vf (mm/min)	回転数n (min ⁻¹)	送り速度vf (mm/min)	回転数n (min ⁻¹)	送り速度vf (mm/min)	
高速条件 High speed	RE0.5×1	47,700	3,820	47,700	3,820	47,700	3,820	47,700	3,820	47,700	2,390	39,800	1,990
	RE1×2	23,900	2,870	23,900	2,870	23,900	2,870	23,900	2,870	23,900	1,910	19,900	1,590
	RE1.5×3	15,900	2,550	15,900	2,550	15,900	2,550	15,900	2,550	15,900	1,750	13,300	1,460
	RE2×4	11,900	2,390	11,900	2,390	11,900	2,390	11,900	2,390	11,900	1,670	9,950	1,390
	RE3×6	7,960	2,230	7,960	2,230	7,960	2,230	7,960	2,230	7,960	1,430	6,630	1,190
	RE4×8	5,970	1,910	5,970	1,910	5,970	1,910	5,970	1,910	5,970	1,310	4,980	1,100
	RE5×10	4,770	1,720	4,770	1,720	4,770	1,720	4,770	1,720	4,770	1,240	3,980	1,030
	RE6×12	3,980	1,590	3,980	1,590	3,980	1,590	3,980	1,590	3,980	1,190	3,320	1,000
	RE8×16	2,980	1,340	2,980	1,340	2,980	1,340	2,980	1,340	2,980	1,010	2,490	850
	RE10×20	2,390	1,070	2,390	1,070	2,390	1,070	2,390	1,070	2,390	810	1,990	680
RE12.5×25	1,910	860	1,910	860	1,910	860	1,910	860	1,910	650	1,590	540	
汎用条件 General	RE0.5×1	31,800	2,540	31,800	2,540	31,800	2,540	31,800	2,540	31,800	1,590	23,900	1,200
	RE1×2	15,900	1,910	15,900	1,910	15,900	1,910	15,900	1,910	15,900	1,270	11,900	950
	RE1.5×3	10,600	1,700	10,600	1,700	10,600	1,700	10,600	1,700	10,600	1,170	7,960	880
	RE2×4	7,960	1,590	7,960	1,590	7,960	1,590	7,960	1,590	7,960	1,110	5,970	840
	RE3×6	5,310	1,490	5,310	1,490	5,310	1,490	5,310	1,490	5,300	950	3,980	720
	RE4×8	3,980	1,270	3,980	1,270	3,980	1,270	3,980	1,270	3,980	880	2,980	660
	RE5×10	3,180	1,140	3,180	1,140	3,180	1,140	3,180	1,140	3,180	830	2,390	620
	RE6×12	2,650	1,060	2,650	1,060	2,650	1,060	2,650	1,060	2,650	800	1,990	600
	RE8×16	1,990	900	1,990	900	1,990	900	1,990	900	1,990	680	1,490	510
	RE10×20	1,590	720	1,590	720	1,590	720	1,590	720	1,590	540	1,190	400
RE12.5×25	1,270	570	1,270	570	1,270	570	1,270	570	1,270	430	950	320	

- [注意]**
- 被削材、加工形状に合わせて、適切なクーラントを使用してください。
 - この標準切削条件表は切削条件の目安を示すものです。実際の加工では加工形状、目的、使用機械等により条件を調整してください。
 - 切削方法は、ダウンカットで使用ください。
 - 一般材、とくに高速切削は、乾式(エアブロー)またはオイルミストクーラントにてご使用ください。
 - 安定した切削を行うため、剛性の高い機械とセットアップでご使用ください。
 - 機械の回転数が足りない場合は、主軸回転数とテーブル送り速度を同比率で下げてください。
 - 加工形状、機械の剛性、工具突き出し量等、ご使用の状況により、主軸回転数とテーブル送り速度の調整を行ってください。

- [Note]**
- Use the appropriate coolant for the work material and machining shape.
 - These Recommended Cutting Conditions indicate only the rule of a thumb for the cutting conditions. In actual machining, the condition should be adjusted according to the machining shape, purpose and the machine type.
 - Down-cutting is recommended.
 - Use generally dry (air-blow) or oil-mist coolant, especially at the high-speed machining.
 - Use a machine tool with rigidity and rigid set-up, to machine stably.
 - When the revolution speed is not enough, reduce the revolution speed and table speed at the same ratio.
 - Adjust the revolution speed and table speed, according to cutting conditions such as machining shape, rigidity of machine tool, over-hang and so on.

C Coating Carbide Ball End Mills for Long Reach Die Sinking

超硬・Cコート深彫り用ボールエンドミル

テーパネック Taper Neck



RE公差 ±0.02

h6

(mm)

2枚刃
2Flutes

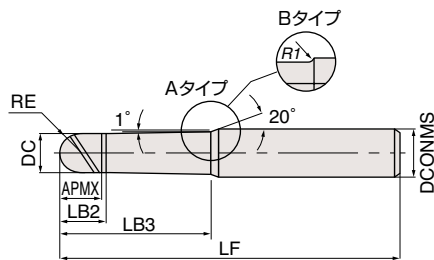

超硬 C ねじり30° 切削条件表 A419
Carbide Helix angle Cutting Conditions

BESL2-C

商品コード Item Code	在庫 Stock	寸法 Size (mm)						全長 Overall length LF	シャンク径 Flute length DCONMS	形状 shape	希望小売価格 (円) Suggested retail price(¥)
		ボール半径 Ball Radius RE	外径 Tool dia. DC	刃長 Flute length APMX	LB2	LB3	LB3				
BESL2030-C		1.5	3	4	5	35	100	6	A	—	
BESL2040-C		2	4	6	7	35	100	6	A	—	
BESL2050-C		2.5	5	7	8	40	115	8	A	—	
BESL2060-C		3	6	8	9	45	115	8	A	—	
BESL2070-C	△	3.5	7	10	11	45	125	10	A	26,040	
BESL2080-C		4	8	12	13	55	125	10	A	—	
BESL2100-C		5	10	15	16	65	140	12	B	—	
BESL2120-C		6	12	18	19	75	150	16	A	—	

ストレートネック Straight Neck



RE公差 ±0.02

h6

(mm)

2枚刃
2Flutes

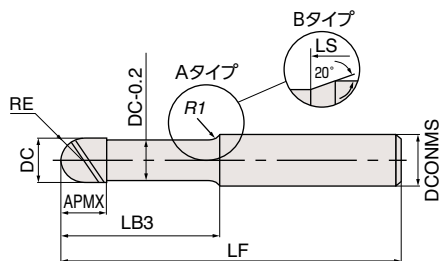

超硬 C ねじり30° 切削条件表 A420
Carbide Helix angle Cutting Conditions

BESL2-S-C

商品コード Item Code	在庫 Stock	寸法 Size (mm)						全長 Overall length LF	シャンク径 Flute length DCONMS	形状 Shape	希望小売価格 (円) Suggested retail price(¥)
		ボール半径 Ball Radius RE	外径 Tool dia. DC	刃長 Flute length APMX	LB3	LB3	LB3				
BESL2030-S-C		1.5	3	4	35	100	6	B	—		
BESL2040-S-C		2	4	6	35	100	6	B	—		
BESL2050-S-C		2.5	5	7	40	115	6	B	—		
BESL2060-S-C		3	6	8	45	115	6	A	—		
BESL2070-S-C	△	3.5	7	10	45	125	8	B	26,040		
BESL2080-S-C		4	8	12	55	125	8	A	—		
BESL2100-S-C		5	10	15	65	140	10	A	—		
BESL2120-S-C		6	12	18	75	150	12	A	—		
BESL2160-S-C	△	8	16	24	80	150	16	A	85,290		
BESL2200-S-C		10	20	30	90	150	20	A	—		
BESL2250-S-C		12.5	25	37	110	180	25	A	—		

BESL-C、BESL-S-Cの対応被削材

Applicable work material of BESL-C, BESL-S-C

炭素鋼 合金鋼 Carbon steel Alloy steel	プリハー ド鋼 Pre-hardened steel	高硬度 Hardened steel			ステン レス鋼 Stainless steel	チタン合金 耐熱合金 Titanium alloy Heat-resistant alloy	銅合金 Copper alloy	アルミ 合金 Aluminum alloy
○	○	> 45HRC ≤ 55HRC	> 55HRC ≤ 65HRC	> 65HRC	○	○	○	○

△印：在庫が無くなり次第受注生産品となるものです。

△：When the Stock is out, will become to produce on request.

無印：受注生産品です。

No Mark: Manufactured upon request only.

標準切削条件表 Recommended cutting conditions

Carbide End Mills
Stocked by Specified distributor

BESL-C テーパネック Taper neck

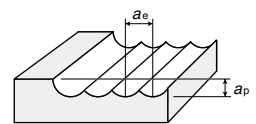

<荒加工> Roughing

被削材 Work material		鋳鉄 Cast irons (150~200HB) FC250		炭素鋼 Carbon steels (180~220HB) SS400, S50C		合金鋼 Alloy steels (200~250HB) SCM440, SNCM		ステンレス鋼・工具鋼 Stainless steels, Tool steels (25~35HRC) SUS304, SKD		プリハードン鋼 Pre-hardened steels (35~45HRC) HPM1, NAK55		焼入れ鋼 Hardened steels (45~55HRC) SKD61, SKT4	
切込み Depth of cut (mm)		ap=0.1DC ae=0.3DC		ap=0.1DC ae=0.3DC		ap=0.1DC ae=0.3DC		ap=0.1DC ae=0.3DC		ap=0.1DC ae=0.3DC		ap=0.1DC ae=0.3DC	
ボール半径RE ×外径DC Tool dia. (mm)		回転数 n (min ⁻¹)	送り速度 Vf (mm/min)	回転数 n (min ⁻¹)	送り速度 Vf (mm/min)	回転数 n (min ⁻¹)	送り速度 Vf (mm/min)	回転数 n (min ⁻¹)	送り速度 Vf (mm/min)	回転数 n (min ⁻¹)	送り速度 Vf (mm/min)	回転数 n (min ⁻¹)	送り速度 Vf (mm/min)
高速条件 High speed	RE1.5×3	15,900	2,550	15,900	2,550	13,300	2,130	13,300	2,130	13,300	1,460	10,600	1,170
	RE2×4	11,900	2,390	11,900	2,390	9,950	1,990	9,950	1,990	9,950	1,390	7,960	1,110
	RE3×6	7,960	2,230	7,960	2,230	6,630	1,860	6,630	1,860	6,630	1,190	5,300	950
	RE4×8	5,970	1,910	5,970	1,910	4,980	1,590	4,980	1,590	4,980	1,100	3,980	880
	RE5×10	4,770	1,720	4,770	1,720	3,980	1,430	3,980	1,430	3,980	1,030	3,180	830
	RE6×12	3,980	1,590	3,980	1,590	3,320	1,330	3,320	1,330	3,320	1,000	2,650	800
汎用条件 General	RE1.5×3	10,600	1,700	10,600	1,700	7,960	1,270	7,960	1,270	7,960	800	6,370	700
	RE2×4	7,960	1,590	7,960	1,590	5,970	1,190	5,970	1,190	5,970	840	4,770	670
	RE3×6	5,310	1,490	5,310	1,490	3,980	1,110	3,980	1,110	3,980	720	3,180	570
	RE4×8	3,980	1,270	3,980	1,270	2,980	950	2,980	950	2,980	660	2,390	530
	RE5×10	3,180	1,140	3,180	1,140	2,390	860	2,390	860	2,390	620	1,910	500
	RE6×12	2,650	1,060	2,650	1,060	1,990	800	1,990	800	1,990	600	1,590	480

<仕上げ加工> Finishing

被削材 Work material		鋳鉄 Cast irons (150~200HB) FC250		炭素鋼 Carbon steels (180~220HB) SS400, S50C		合金鋼 Alloy steels (200~250HB) SCM440, SNCM		ステンレス鋼・工具鋼 Stainless steels, Tool steels (25~35HRC) SUS304, SKD		プリハードン鋼 Pre-hardened steels (35~45HRC) HPM1, NAK55		焼入れ鋼 Hardened steels (45~55HRC) SKD61, SKT4	
切込み Depth of cut (mm)		ap=0.05DC ae=0.05DC		ap=0.05DC ae=0.05DC		ap=0.05DC ae=0.05DC		ap=0.05DC ae=0.05DC		ap=0.05DC ae=0.05DC		ap=0.05DC ae=0.05DC	
ボール半径RE ×外径DC Tool dia. (mm)		回転数 n (min ⁻¹)	送り速度 Vf (mm/min)	回転数 n (min ⁻¹)	送り速度 Vf (mm/min)	回転数 n (min ⁻¹)	送り速度 Vf (mm/min)	回転数 n (min ⁻¹)	送り速度 Vf (mm/min)	回転数 n (min ⁻¹)	送り速度 Vf (mm/min)	回転数 n (min ⁻¹)	送り速度 Vf (mm/min)
高速条件 High speed	RE1.5×3	15,900	2,550	15,900	2,550	15,900	2,550	15,900	2,550	15,900	1,750	13,300	1,460
	RE2×4	11,900	2,390	11,900	2,390	11,900	2,390	11,900	2,390	11,900	1,670	9,950	1,390
	RE3×6	7,960	2,230	7,960	2,230	7,960	2,230	7,960	2,230	7,960	1,430	6,630	1,190
	RE4×8	5,970	1,910	5,970	1,910	5,970	1,910	5,970	1,910	5,970	1,310	4,980	1,100
	RE5×10	4,770	1,720	4,770	1,720	4,770	1,720	4,770	1,720	4,770	1,240	3,980	1,030
	RE6×12	3,980	1,590	3,980	1,590	3,980	1,590	3,980	1,590	3,980	1,190	3,320	1,000
汎用条件 General	RE1.5×3	10,600	1,700	10,600	1,700	10,600	1,700	10,600	1,700	10,600	1,170	7,960	880
	RE2×4	7,960	1,590	7,960	1,590	7,960	1,590	7,960	1,590	7,960	1,110	5,970	840
	RE3×6	5,310	1,490	5,310	1,490	5,310	1,490	5,310	1,490	5,300	950	3,980	720
	RE4×8	3,980	1,270	3,980	1,270	3,980	1,270	3,980	1,270	3,980	880	2,980	660
	RE5×10	3,180	1,140	3,180	1,140	3,180	1,140	3,180	1,140	3,180	830	2,390	620
	RE6×12	2,650	1,060	2,650	1,060	2,650	1,060	2,650	1,060	2,650	800	1,990	600

C Coating Carbide Ball End Mills for Long Reach Die Sinking

超硬・Cコート深彫り用ボールエンドミル

超硬ボールエンドミル
特定代理店在庫品

BESL-S-C

ストレートネック
Straight neck

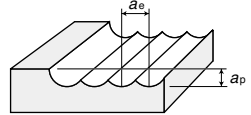

<荒加工> Roughing

被削材 Work material	鋳鉄 Cast irons (150~200HB) FC250		炭素鋼 Carbon steels (180~220HB) SS400, S50C		合金鋼 Alloy steels (200~250HB) SCM440, SNCM		ステンレス鋼・工具鋼 Stainless steels, Tool steels (25~35HRC) SUS304, SKD		プリハードン鋼 Pre-hardened steels (35~45HRC) HPM1, NAK55		焼入れ鋼 Hardened steels (45~55HRC) SKD61, SKT4		
	切込み Depth of cut (mm)	ap=0.1DC ae=0.3DC	ap=0.1DC ae=0.3DC	ap=0.1DC ae=0.3DC	ap=0.1DC ae=0.3DC	ap=0.1DC ae=0.3DC	ap=0.1DC ae=0.3DC	ap=0.1DC ae=0.3DC	ap=0.1DC ae=0.3DC	ap=0.1DC ae=0.3DC	ap=0.1DC ae=0.3DC	ap=0.1DC ae=0.3DC	
ボール半径RE×外径DC Tool dia.(mm)	回転数n (min ⁻¹)	送り速度vf (mm/min)	回転数n (min ⁻¹)	送り速度vf (mm/min)	回転数n (min ⁻¹)	送り速度vf (mm/min)	回転数n (min ⁻¹)	送り速度vf (mm/min)	回転数n (min ⁻¹)	送り速度vf (mm/min)	回転数n (min ⁻¹)	送り速度vf (mm/min)	
高速条件 High speed	RE1.5×3	15,900	2,550	15,900	2,550	13,300	2,130	13,300	2,130	13,300	1,460	10,600	1,170
	RE2×4	11,900	2,390	11,900	2,390	9,950	1,990	9,950	1,990	9,950	1,390	7,960	1,110
	RE3×6	7,960	2,230	7,960	2,230	6,630	1,860	6,630	1,860	6,630	1,190	5,300	950
	RE4×8	5,970	1,910	5,970	1,910	4,980	1,590	4,980	1,590	4,980	1,100	3,980	880
	RE5×10	4,770	1,720	4,770	1,720	3,980	1,430	3,980	1,430	3,980	1,030	3,180	830
	RE6×12	3,980	1,590	3,980	1,590	3,320	1,330	3,320	1,330	3,320	1,000	2,650	800
	RE8×16	2,980	1,340	2,980	1,340	2,490	1,120	2,490	1,120	2,490	850	1,990	680
	RE10×20	2,390	1,070	2,390	1,070	1,990	900	1,990	900	1,990	680	1,590	540
	RE12.5×25	1,910	860	1,910	860	1,590	720	1,590	720	1,590	540	1,270	430
汎用条件 General	RE1.5×3	10,600	1,700	10,600	1,700	7,960	1,270	7,960	1,270	7,960	800	6,370	700
	RE2×4	7,960	1,590	7,960	1,590	5,970	1,190	5,970	1,190	5,970	840	4,770	670
	RE3×6	5,310	1,490	5,310	1,490	3,980	1,110	3,980	1,110	3,980	720	3,180	570
	RE4×8	3,980	1,270	3,980	1,270	2,980	950	2,980	950	2,980	660	2,390	530
	RE5×10	3,180	1,140	3,180	1,140	2,390	860	2,390	860	2,390	620	1,910	500
	RE6×12	2,650	1,060	2,650	1,060	1,990	800	1,990	800	1,990	600	1,590	480
	RE8×16	1,990	900	1,990	900	1,490	670	1,490	670	1,490	510	1,190	400
	RE10×20	1,590	720	1,590	720	1,190	540	1,190	540	1,190	400	950	320
	RE12.5×25	1,270	570	1,270	570	950	430	950	430	950	320	760	260

<仕上げ加工> Finishing

被削材 Work material	鋳鉄 Cast irons (150~200HB) FC250		炭素鋼 Carbon steels (180~220HB) SS400, S50C		合金鋼 Alloy steels (200~250HB) SCM440, SNCM		ステンレス鋼・工具鋼 Stainless steels, Tool steels (25~35HRC) SUS304, SKD		プリハードン鋼 Pre-hardened steels (35~45HRC) HPM1, NAK55		焼入れ鋼 Hardened steels (45~55HRC) SKD61, SKT4		
	切込み Depth of cut (mm)	ap=0.05DC ae=0.05DC	ap=0.05DC ae=0.05DC	ap=0.05DC ae=0.05DC	ap=0.05DC ae=0.05DC	ap=0.05DC ae=0.05DC	ap=0.05DC ae=0.05DC	ap=0.05DC ae=0.05DC	ap=0.05DC ae=0.05DC	ap=0.05DC ae=0.05DC	ap=0.05DC ae=0.05DC	ap=0.05DC ae=0.05DC	
ボール半径RE×外径DC Tool dia.(mm)	回転数n (min ⁻¹)	送り速度vf (mm/min)	回転数n (min ⁻¹)	送り速度vf (mm/min)	回転数n (min ⁻¹)	送り速度vf (mm/min)	回転数n (min ⁻¹)	送り速度vf (mm/min)	回転数n (min ⁻¹)	送り速度vf (mm/min)	回転数n (min ⁻¹)	送り速度vf (mm/min)	
高速条件 High speed	RE1.5×3	15,900	2,550	15,900	2,550	15,900	2,550	15,900	2,550	15,900	1,750	13,300	1,460
	RE2×4	11,900	2,390	11,900	2,390	11,900	2,390	11,900	2,390	11,900	1,670	9,950	1,390
	RE3×6	7,960	2,230	7,960	2,230	7,960	2,230	7,960	2,230	7,960	1,430	6,630	1,190
	RE4×8	5,970	1,910	5,970	1,910	5,970	1,910	5,970	1,910	5,970	1,310	4,980	1,100
	RE5×10	4,770	1,720	4,770	1,720	4,770	1,720	4,770	1,720	4,770	1,240	3,980	1,030
	RE6×12	3,980	1,590	3,980	1,590	3,980	1,590	3,980	1,590	3,980	1,190	3,320	1,000
	RE8×16	2,980	1,340	2,980	1,340	2,980	1,340	2,980	1,340	2,980	1,010	2,490	850
	RE10×20	2,390	1,070	2,390	1,070	2,390	1,070	2,390	1,070	2,390	810	1,990	680
	RE12.5×25	1,910	860	1,910	860	1,910	860	1,910	860	1,910	650	1,590	540
汎用条件 General	RE1.5×3	10,600	1,700	10,600	1,700	10,600	1,700	10,600	1,700	10,600	1,170	7,960	880
	RE2×4	7,960	1,590	7,960	1,590	7,960	1,590	7,960	1,590	7,960	1,110	5,970	840
	RE3×6	5,310	1,490	5,310	1,490	5,310	1,490	5,310	1,490	5,300	950	3,980	720
	RE4×8	3,980	1,270	3,980	1,270	3,980	1,270	3,980	1,270	3,980	880	2,980	660
	RE5×10	3,180	1,140	3,180	1,140	3,180	1,140	3,180	1,140	3,180	830	2,390	620
	RE6×12	2,650	1,060	2,650	1,060	2,650	1,060	2,650	1,060	2,650	800	1,990	600
	RE8×16	1,990	900	1,990	900	1,990	900	1,990	900	1,990	680	1,490	510
	RE10×20	1,590	720	1,590	720	1,590	720	1,590	720	1,590	540	1,190	400
	RE12.5×25	1,270	570	1,270	570	1,270	570	1,270	570	1,270	430	950	320

- [注意]**
- ① 切削方法は、ダウンカットで使用ください。
 - ② 一般材、とくに高速切削は、乾式（エアブロー）またはオイルミストクーラントにてご使用ください。
 - ③ ステンレス鋼および超耐熱合金には、不水溶性切削油のご使用が適しています。
 - ④ 安定した切削を行うため、剛性の高い機械とセットアップでご使用ください。
 - ⑤ 機械の回転数が足りない場合は、主軸回転数とテーブル送り速度を同比率で下げてください。
 - ⑥ 加工形状、機械の剛性、工具突き出し量等、ご使用の状況により、主軸回転数とテーブル送り速度の調整を行ってください。

- [Note]**
- ① Down-cutting is recommended.
 - ② Use generally dry (air-blow) or oil-mist coolant, especially at the high-speed machining.
 - ③ Oil base coolant is recommended for machining stainless steels and heat-resistant alloys.
 - ④ Use a machine tool with rigidity and rigid set-up, to machine stably.
 - ⑤ When the revolution speed is not enough, reduce the revolution speed and table speed at the same ratio.
 - ⑥ Adjust the revolution speed and table speed, according to cutting conditions such as machining shape, rigidity of machine tool, over-hang and so on.

Carbide Ball End Mills

超硬ボールエンドミル

ミニチュア

Miniature type



RE公差 ±0.01

h6

(mm)

2枚刃
2Flutes



BESS2

超硬 傾斜30°
Carbide Helix angle

商品コード Item code	在庫 Stock	寸法 Size (mm)				
		ボール半径 Ball radius	外径 Tool dia.	刃長 Flute length	全長 Overall length	シャンク径 Shank dia.
BESS2003	<input type="checkbox"/>	0.15	0.3	0.45	50	3
BESS2004	<input type="checkbox"/>	0.2	0.4	0.6	50	3
BESS2005	<input type="checkbox"/>	0.25	0.5	0.75	50	3
BESS2006	<input type="checkbox"/>	0.3	0.6	0.9	50	3
BESS2007	<input type="checkbox"/>	0.35	0.7	1	50	3
BESS2008	<input type="checkbox"/>	0.4	0.8	1.2	50	3
BESS2009	<input type="checkbox"/>	0.45	0.9	1.3	50	3
BESS2010	<input type="checkbox"/>	0.5	1	1.5	50	4
BESS2011	<input type="checkbox"/>	0.55	1.1	1.7	50	4
BESS2012	<input type="checkbox"/>	0.6	1.2	1.8	50	4
BESS2013	<input type="checkbox"/>	0.65	1.3	2	50	4
BESS2014	<input type="checkbox"/>	0.7	1.4	2.1	50	4
BESS2015	<input type="checkbox"/>	0.75	1.5	2.3	50	4
BESS2016	<input type="checkbox"/>	0.8	1.6	2.4	50	4
BESS2017	<input type="checkbox"/>	0.85	1.7	2.6	50	4
BESS2018	<input type="checkbox"/>	0.9	1.8	2.7	50	4
BESS2019	<input type="checkbox"/>	0.95	1.9	2.9	50	4
BESS2020	<input type="checkbox"/>	1	2	3	50	4
BESS2021	<input type="checkbox"/>	1.05	2.1	3.2	50	4
BESS2022	<input type="checkbox"/>	1.1	2.2	3.3	50	4
BESS2023	<input type="checkbox"/>	1.15	2.3	3.5	50	4
BESS2024	<input type="checkbox"/>	1.2	2.4	3.6	50	4
BESS2025	<input type="checkbox"/>	1.25	2.5	3.8	50	4
BESS2026	<input type="checkbox"/>	1.3	2.6	3.9	55	6
BESS2027	<input type="checkbox"/>	1.35	2.7	4.1	55	6
BESS2028	<input type="checkbox"/>	1.4	2.8	4.2	55	6
BESS2029	<input type="checkbox"/>	1.45	2.9	4.4	55	6
BESS2030	<input type="checkbox"/>	1.5	3	4.5	55	6



RE公差 ±0.02

h6

(mm)

2枚刃
2Flutes



BES2

超硬 傾斜30°
Carbide Helix angle

商品コード Item code	在庫 Stock	寸法 Size (mm)				
		ボール半径 Ball radius	外径 Tool dia.	刃長 Flute length	全長 Overall length	シャンク径 Shank dia.
BES2010	<input type="checkbox"/>	0.5	1	2.5	50	4
BES2020	<input type="checkbox"/>	1	2	5	50	6
BES2030	<input type="checkbox"/>	1.5	3	8	70	6
BES2040	<input type="checkbox"/>	2	4	12	70	6
BES2050	<input type="checkbox"/>	2.5	5	15	80	6
BES2060	<input type="checkbox"/>	3	6	15	90	6
BES2070	<input type="checkbox"/>	3.5	7	20	90	6
BES2080	<input type="checkbox"/>	4	8	20	100	8
BES2100	<input type="checkbox"/>	5	10	25	100	10
BES2120	<input type="checkbox"/>	6	12	30	110	12
BES2140	<input type="checkbox"/>	7	14	35	120	12
BES2160	<input type="checkbox"/>	8	16	40	140	16
BES2180	<input type="checkbox"/>	9	18	40	140	16
BES2200	<input type="checkbox"/>	10	20	45	160	20
BES2250	<input type="checkbox"/>	12.5	25	50	180	25

プラ型用

for Plastic Mold



RE公差 ±0.02

h6

(mm)

2枚刃
2Flutes



BES2-M

超硬 傾斜30°
Carbide Helix angle

商品コード Item code	在庫 Stock	寸法 Size (mm)				
		ボール半径 Ball radius	外径 Tool dia.	刃長 Flute length	全長 Overall length	シャンク径 Shank dia.
BES2010M	<input type="checkbox"/>	0.5	1	2.5	50	4
BES2020M	<input type="checkbox"/>	1	2	5	50	4
BES2030M	<input type="checkbox"/>	1.5	3	8	70	6
BES2040M	<input type="checkbox"/>	2	4	12	70	6
BES2050M	<input type="checkbox"/>	2.5	5	15	80	6
BES2060M	<input type="checkbox"/>	3	6	15	80	6
BES2070M	<input type="checkbox"/>	3.5	7	20	90	8
BES2080M	<input type="checkbox"/>	4	8	20	90	8
BES2100M	<input type="checkbox"/>	5	10	25	100	10
BES2120M	<input type="checkbox"/>	6	12	30	110	12
BES2140M	<input type="checkbox"/>	7	14	35	120	12
BES2160M	<input type="checkbox"/>	8	16	40	120	16
BES2180M	<input type="checkbox"/>	9	18	40	130	16
BES2200M	<input type="checkbox"/>	10	20	45	130	20

○ BESS、BES、BES-Mの対応被削材

Applicable work material of BESS, BES, BES-M

炭素鋼 合金鋼 Carbon steel Alloy steel	プリハードン鋼 Pre-hardened steel ≤ 45HRC	高硬度 Hardened steel			ステンレス鋼 Stainless steel	チタン合金 耐熱合金 Titanium alloy Heat-resistant alloy	銅合金 Copper alloy	アルミ合金 Aluminum alloy
○	○	> 45HRC ≤ 55HRC	> 55HRC ≤ 65HRC	> 65HRC	○	○	◎	◎

○印：特定代理店在庫です。弊社営業へお問合せください。
□印：Stocked by specified distributor. Contact with our sales department.

Carbide End Mills

Stocked by Specified distributor

CS Coating Carbide End Mill Ball Jet Ball

CSコート超硬エンドミルボール ジェットボール®



RE公差 RE tolerance	RE ≤ 6: ±0.005 6 < RE: ±0.01	h5
----------------------	---------------------------------	----



YB2-○○○-CS

商品コード Item code	在庫 Stock	寸法 Size (mm)			
		ボール半径 Ball radius	刃長 Flute length	全長 Overall length	シャンク径 Shank dia.
YB2010-CS	<input type="checkbox"/>	0.5	1.5	50	4
YB2015-CS	<input type="checkbox"/>	0.75	2.3	50	4
YB2020-CS	<input type="checkbox"/>	1	3	60	6
YB2030-CS	<input type="checkbox"/>	1.5	4.5	60	6
YB2040-CS	<input type="checkbox"/>	2	6	70	6
YB2050-CS	<input type="checkbox"/>	2.5	7.5	80	6
YB2060-CS	<input type="checkbox"/>	3	9	90	6
YB2080-CS	<input type="checkbox"/>	4	12	100	8
YB2100-CS	<input type="checkbox"/>	5	15	100	10
YB2120-CS	<input type="checkbox"/>	6	18	110	12
YB2160-CS	<input type="checkbox"/>	8	24	140	16
YB2200-CS	<input type="checkbox"/>	10	30	160	20

レギュラー刃長 Regular



RE公差 RE tolerance	±0.01	h6
----------------------	-------	----

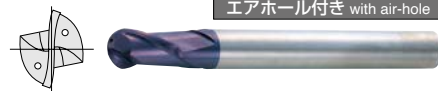

JBER2-○○○

商品コード Item code	在庫 Stock	寸法 Size (mm)			
		ボール半径 Ball radius	刃長 Flute length	全長 Overall length	シャンク径 Shank dia.
JBER2060	<input type="checkbox"/>	3	9	90	6
JBER2080	<input type="checkbox"/>	4	12	100	8
JBER2100	<input type="checkbox"/>	5	15	100	10
JBER2120	<input type="checkbox"/>	6	18	110	12
JBER2160	<input type="checkbox"/>	8	24	140	16
JBER2200	<input type="checkbox"/>	10	30	160	20

深彫り用・ストレートネック for Long-Reach Die Sinking, Straight neck



RE公差 RE tolerance	±0.015	h6
----------------------	--------	----



JBELS2-○○○

商品コード Item code	在庫 Stock	寸法 Size (mm)					
		ボール半径 Ball radius	刃長 Flute length	首径 Neck dia.	首下長 Under neck length	全長 Overall length	シャンク径 Shank dia.
		RE	APMX	DN	LU	LF	DCONMS
JBELS2060	<input type="checkbox"/>	3	8	5.8	45	115	6
JBELS2080	<input type="checkbox"/>	4	12	7.8	55	125	8
JBELS2100	<input type="checkbox"/>	5	15	9.8	65	140	10
JBELS2120	<input type="checkbox"/>	6	18	11.8	80	160	12
JBELS2160	<input type="checkbox"/>	8	24	15.8	115	200	16
JBELS2200	<input type="checkbox"/>	10	30	19.8	115	200	20

標準切削条件表 Recommended cutting conditions

YB-CS

切込み
Depth of cut (mm)

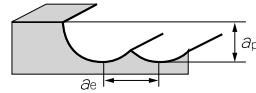

RE	a _p	a _e
RE ≤ 1.0	0.05 × RE 以下	0.2 × RE 以下
1.0 < RE	0.1 × RE 以下	0.2 × RE 以下

被削材 Work material	銅合金・アルミ合金 Copper alloys, Aluminum alloys	铸铁・炭素鋼 Cast irons, Carbon steels FC200, SS400, S50C	合金鋼・工具鋼 Alloy steels, Tool steels SCM, SKD, ARK1	プリハードン鋼・焼入れ鋼 Pre-hardened steels, Hardened steels CENA1, NAK80, SKD	焼入れ鋼 Hardened steels SKD1, HPM38, Stavax						
硬度 Hardness	—	~250HB	25~35HRC	35~45HRC	45~55HRC						
切削条件 Conditions	v _c = 150~250m/min		v _c = 150~250m/min	v _c = 125~225m/min	v _c = 100~200m/min	v _c = 75~175m/min					
	ボール半径 RE mm	外径 DC mm	回転数n Revolution min ⁻¹	送り速度v _f Table Speed mm/min	回転数n Revolution min ⁻¹	送り速度v _f Table Speed mm/min	回転数n Revolution min ⁻¹	送り速度v _f Table Speed mm/min	回転数n Revolution min ⁻¹	送り速度v _f Table Speed mm/min	
RE0.5	1.0	50,000	3,350	31,800	572	27,900	502	23,900	430	19,900	358
RE1	2	35,000	3,350	31,800	1,910	27,900	1,670	23,900	1,430	19,900	1,190
RE2	4	17,500	4,080	15,900	1,910	13,900	1,670	11,900	1,430	9,950	1,190
RE3	6	11,700	5,160	10,600	1,910	9,280	1,670	7,960	1,430	6,630	1,190
RE4	8	8,760	3,840	7,960	1,910	6,960	1,670	5,970	1,430	4,970	1,190
RE5	10	7,100	3,120	6,370	1,780	5,570	1,560	4,770	1,340	3,980	1,110
RE6	12	5,850	2,580	5,310	1,590	4,640	1,390	3,980	1,190	3,320	996
RE8	16	4,400	1,550	4,000	1,300	3,500	1,050	3,000	900	2,500	750
RE10	20	3,520	1,240	3,200	1,000	2,800	840	2,400	720	2,000	600

- 【注意】** ① 切削方法はダウンカットでご使用ください。
 ② 乾式切削の場合はエアブローを推奨いたします。
 ③ 安定した切削を行うため、剛性の高い機械とホルダでセットアップし、ご使用ください。
 ④ 突出し長さ、切込み量、機械の剛性等の使用状況により、回転数と送り速度の調整を行って下さい。
 ⑤ 回転数が不足する場合は、回転数と送り速度を同比率で下げてください。

- 【Note】** ① Please use down-cutting. Air-blow is recommended in case of dry-machining.
 ② Please use a machine with high rigidity and perfect set-up to perform stable machining.
 ③ The table shows starting conditions. Please adjust revolution speed and feed speed according to over-hang, depth of cut and conditions of machine.
 ④ Please reduce feed speed at the same rate in case of lower spindle revolution.

YB-CS の対応被削材

Applicable work material of YB-CS

炭素鋼 合金鋼 Carbon steel Alloy steel	プリハー ドンド 鋼 Pre-hardened steel ≤ 45HRC	高硬度 Hardened steel			ステン レス 鋼 Stainless steel	チタン合金 耐熱合金 Titanium alloy Heat-resistant alloy	銅合金 Copper alloy	アルミ 合金 Aluminum alloy
		> 45HRC ≤ 55HRC	> 55HRC ≤ 65HRC	> 65HRC				
○	○	○	○	○	○	○	○	

JBER、JBELS の対応被削材

Applicable work material of JBER, JBELS

炭素鋼 合金鋼 Carbon steel Alloy steel	プリハー ドンド 鋼 Pre-hardened steel ≤ 45HRC	高硬度 Hardened steel			ステン レス 鋼 Stainless steel	チタン合金 耐熱合金 Titanium alloy Heat-resistant alloy	銅合金 Copper alloy	アルミ 合金 Aluminum alloy
		> 45HRC ≤ 55HRC	> 55HRC ≤ 65HRC	> 65HRC				
○	○	○	○	○	○	○	○	

○印：特定代理店在庫です。弊社営業へお問合せください。 □：Stocked by specified distributor. Contact with our sales department.

標準切削条件表 Recommended cutting conditions

JBER

レギュラー刃長
Regular

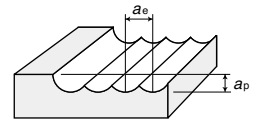

<荒加工> Roughing

被削材 Work material	鋳鉄 Cast irons (150~200HB) FC250		炭素鋼 Carbon steels (180~220HB) SS400, S50C		合金鋼 Alloy steels (200~250HB) SCM440, SNCM		工具鋼 Tool steels (25~35HRC) SKD		プリハードン鋼 Pre-hardened steels (35~45HRC) HPM1, NAK55		焼入れ鋼 Hardened steels (45~55HRC) SKD61, SKT4		焼入れ鋼 Hardened steels (55~65HRC) SKD11, SKH51		
	切込み Depth of cut (mm)		$a_p=0.1DC$ $a_e=0.3DC$		$a_p=0.1DC$ $a_e=0.3DC$		$a_p=0.1DC$ $a_e=0.3DC$		$a_p=0.1DC$ $a_e=0.3DC$		$a_p=0.1DC$ $a_e=0.3DC$		$a_p=0.1DC$ $a_e=0.3DC$		
ボール半径RE ×外径DC Tool dia.(mm)	回転数 n (min^{-1})	送り速度 V_f (mm/min)	回転数 n (min^{-1})	送り速度 V_f (mm/min)	回転数 n (min^{-1})	送り速度 V_f (mm/min)	回転数 n (min^{-1})	送り速度 V_f (mm/min)	回転数 n (min^{-1})	送り速度 V_f (mm/min)	回転数 n (min^{-1})	送り速度 V_f (mm/min)	回転数 n (min^{-1})	送り速度 V_f (mm/min)	
高速条件 High speed	RE3×6	15,900	4,450	15,900	4,450	13,300	3,720	13,300	3,720	13,300	2,390	10,600	1,910	7,960	1,430
	RE4×8	11,900	3,810	11,900	3,810	9,950	3,180	9,950	3,180	9,950	2,190	7,960	1,750	5,970	1,310
	RE5×10	9,550	3,440	9,550	3,440	7,960	2,870	7,960	2,870	7,960	2,070	6,370	1,660	4,770	1,240
	RE6×12	7,960	3,180	7,960	3,180	6,630	2,650	6,630	2,650	6,630	1,990	5,310	1,590	3,980	1,190
	RE8×16	5,970	2,690	5,970	2,690	4,970	2,240	4,970	2,240	4,970	1,690	3,980	1,350	2,980	1,010
	RE10×20	4,770	2,150	4,770	2,150	3,980	1,790	3,980	1,790	3,980	1,350	3,180	1,080	2,390	810
汎用条件 General	RE3×6	10,600	2,970	10,600	2,970	7,960	2,230	7,960	2,230	7,960	1,430	6,370	1,150	4,780	860
	RE4×8	7,960	2,550	7,960	2,550	5,970	1,910	5,970	1,910	5,970	1,310	4,780	1,050	3,580	790
	RE5×10	6,370	2,290	6,370	2,290	4,770	1,720	4,770	1,720	4,770	1,240	3,820	990	2,870	750
	RE6×12	5,310	2,120	5,310	2,120	3,980	1,590	3,980	1,590	3,980	1,190	3,180	960	2,390	720
	RE8×16	3,980	1,790	3,980	1,790	2,980	1,340	2,980	1,340	2,980	1,010	2,390	810	1,790	610
	RE10×20	3,180	1,430	3,180	1,430	2,390	1,070	2,390	1,070	2,390	810	1,910	650	1,430	490

<仕上げ加工> Finishing

被削材 Work material	鋳鉄 Cast irons (150~200HB) FC250		炭素鋼 Carbon steels (180~220HB) SS400, S50C		合金鋼 Alloy steels (200~250HB) SCM440, SNCM		工具鋼 Tool steels (25~35HRC) SKD		プリハードン鋼 Pre-hardened steels (35~45HRC) HPM1, NAK55		焼入れ鋼 Hardened steels (45~55HRC) SKD61, SKT4		焼入れ鋼 Hardened steels (55~65HRC) SKD11, SKH51		
	切込み Depth of cut (mm)		$a_p=0.05DC$ $a_e=0.05DC$		$a_p=0.05DC$ $a_e=0.05DC$		$a_p=0.05DC$ $a_e=0.05DC$		$a_p=0.05DC$ $a_e=0.05DC$		$a_p=0.05DC$ $a_e=0.05DC$		$a_p=0.05DC$ $a_e=0.05DC$		
ボール半径RE ×外径DC Tool dia.(mm)	回転数 n (min^{-1})	送り速度 V_f (mm/min)	回転数 n (min^{-1})	送り速度 V_f (mm/min)	回転数 n (min^{-1})	送り速度 V_f (mm/min)	回転数 n (min^{-1})	送り速度 V_f (mm/min)	回転数 n (min^{-1})	送り速度 V_f (mm/min)	回転数 n (min^{-1})	送り速度 V_f (mm/min)	回転数 n (min^{-1})	送り速度 V_f (mm/min)	
高速条件 High speed	RE3×6	15,900	4,450	15,900	4,450	15,900	4,450	15,900	4,450	15,900	2,860	13,300	2,390	10,600	1,910
	RE4×8	11,900	3,810	11,900	3,810	11,900	3,810	11,900	3,810	11,900	2,620	9,950	2,190	7,960	1,750
	RE5×10	9,550	3,440	9,550	3,440	9,550	3,440	9,550	3,440	9,550	2,480	7,960	2,070	6,370	1,660
	RE6×12	7,960	3,180	7,960	3,180	7,960	3,180	7,960	3,180	7,960	2,390	6,630	1,990	5,310	1,590
	RE8×16	5,970	2,690	5,970	2,690	5,970	2,690	5,970	2,690	5,970	2,030	4,970	1,690	3,980	1,350
	RE10×20	4,770	2,150	4,770	2,150	4,770	2,150	4,770	2,150	4,770	1,620	3,980	1,350	3,180	1,080
汎用条件 General	RE3×6	10,600	2,970	10,600	2,970	10,600	2,970	10,600	2,970	10,600	1,910	7,960	1,430	6,370	1,150
	RE4×8	7,960	2,550	7,960	2,550	7,960	2,550	7,960	2,550	7,960	1,750	5,970	1,310	4,780	1,050
	RE5×10	6,370	2,290	6,370	2,290	6,370	2,290	6,370	2,290	6,370	1,660	4,770	1,240	3,820	990
	RE6×12	5,310	2,120	5,310	2,120	5,310	2,120	5,310	2,120	5,310	1,590	3,980	1,190	3,180	960
	RE8×16	3,980	1,790	3,980	1,790	3,980	1,790	3,980	1,790	3,980	1,350	2,980	1,010	2,390	810
	RE10×20	3,180	1,430	3,180	1,430	3,180	1,430	3,180	1,430	3,180	1,080	2,390	810	1,910	650

- [注意]**
- ① 切削方法は、ダウンカットで使用ください。
 - ② 一般材、とくに高速切削は、乾式（エアブロー）またはオイルミストクーラントにてご使用ください。
 - ③ 安定した切削を行うため、剛性の高い機械とセットアップでご使用ください。
 - ④ 機械の回転数が足りない場合は、主軸回転数とテーブル送り速度を同比率で下げてください。
 - ⑤ 加工形状、機械の剛性、工具突き出し量等、ご使用の状況により、主軸回転数とテーブル送り速度の調整を行ってください。

- [Note]**
- ① Down-cutting is recommended.
 - ② Use generally dry (air-blow) or oil-mist coolant, especially at the high-speed machining.
 - ③ Use a machine tool with rigidity and rigid set-up, to machine stably.
 - ④ When the revolution speed is not enough, reduce the revolution speed and table speed at the same ratio.
 - ⑤ Adjust the revolution speed and table speed, according to cutting conditions such as machining shape, rigidity of machine tool, over-hang and so on.

Carbide End Mills

Stocked by Specified distributor

JBELS

深彫り用・ストレートネック
for Long-Reach Die Sinking, Straight neck

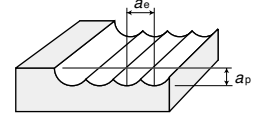

<荒加工> Roughing

被削材 Work material	鋳鉄 Cast irons (150~200HB) FC250		炭素鋼 Carbon steels (180~220HB) SS400, S50C		合金鋼 Alloy steels (200~250HB) SCM440, SNCM		ステンレス鋼・工具鋼 Stainless steel, Tool steels (25~35HRC) SUS304, SKD		プリハードン鋼 Pre-hardened steels (35~45HRC) HPM1, NAK55		焼入れ鋼 Hardened steels (45~55HRC) SKD61, SKT4		焼入れ鋼 Hardened steels (55~65HRC) SKD11, SKH51		
	切込み Depth of cut (mm) ap=0.1DC ae=0.3DC		ap=0.1DC ae=0.3DC		ap=0.1DC ae=0.3DC		ap=0.1DC ae=0.3DC		ap=0.1DC ae=0.3DC		ap=0.1DC ae=0.3DC		ap=0.1DC ae=0.3DC		
ボール半径RE ×外径DC Tool dia.(mm)	回転数 n (min ⁻¹)	送り速度 Vf (mm/min)	回転数 n (min ⁻¹)	送り速度 Vf (mm/min)	回転数 n (min ⁻¹)	送り速度 Vf (mm/min)	回転数 n (min ⁻¹)	送り速度 Vf (mm/min)	回転数 n (min ⁻¹)	送り速度 Vf (mm/min)	回転数 n (min ⁻¹)	送り速度 Vf (mm/min)	回転数 n (min ⁻¹)	送り速度 Vf (mm/min)	
高速条件 High speed	RE3×6	7,960	2,230	7,960	2,230	6,630	1,860	6,630	1,860	6,630	1,190	5,300	950	3,980	720
	RE4×8	5,970	1,910	5,970	1,910	4,980	1,590	4,980	1,590	4,980	1,100	3,980	880	2,980	660
	RE5×10	4,770	1,720	4,770	1,720	3,980	1,430	3,980	1,430	3,980	1,030	3,180	830	2,390	620
	RE6×12	3,980	1,590	3,980	1,590	3,320	1,330	3,320	1,330	3,320	1,000	2,650	800	1,990	600
	RE8×16	2,980	1,340	2,980	1,340	2,490	1,120	2,490	1,120	2,490	850	1,990	680	1,490	510
RE10×20	2,390	1,070	2,390	1,070	1,990	900	1,990	900	1,990	680	1,590	540	1,190	400	
汎用条件 General	RE3×6	5,310	1,490	5,310	1,490	3,980	1,110	3,980	1,110	3,980	720	3,180	570	2,390	430
	RE4×8	3,980	1,270	3,980	1,270	2,980	950	2,980	950	2,980	660	2,390	530	1,790	390
	RE5×10	3,180	1,140	3,180	1,140	2,390	860	2,390	860	2,390	620	1,910	500	1,430	370
	RE6×12	2,650	1,060	2,650	1,060	1,990	800	1,990	800	1,990	600	1,590	480	1,190	360
	RE8×16	1,990	900	1,990	900	1,490	670	1,490	670	1,490	510	1,190	400	900	310
RE10×20	1,590	720	1,590	720	1,190	540	1,190	540	1,190	400	950	320	720	240	

<仕上げ加工> Finishing

被削材 Work material	鋳鉄 Cast irons (150~200HB) FC250		炭素鋼 Carbon steels (180~220HB) SS400, S50C		合金鋼 Alloy steels (200~250HB) SCM440, SNCM		ステンレス鋼・工具鋼 Stainless steel, Tool steels (25~35HRC) SUS304, SKD		プリハードン鋼 Pre-hardened steels (35~45HRC) HPM1, NAK55		焼入れ鋼 Hardened steels (45~55HRC) SKD61, SKT4		焼入れ鋼 Hardened steels (55~65HRC) SKD11, SKH51		
	切込み Depth of cut (mm) ap=0.05DC ae=0.05DC		ap=0.05DC ae=0.05DC		ap=0.05DC ae=0.05DC		ap=0.05DC ae=0.05DC		ap=0.05DC ae=0.05DC		ap=0.05DC ae=0.05DC		ap=0.05DC ae=0.05DC		
ボール半径RE ×外径DC Tool dia.(mm)	回転数 n (min ⁻¹)	送り速度 Vf (mm/min)	回転数 n (min ⁻¹)	送り速度 Vf (mm/min)	回転数 n (min ⁻¹)	送り速度 Vf (mm/min)	回転数 n (min ⁻¹)	送り速度 Vf (mm/min)	回転数 n (min ⁻¹)	送り速度 Vf (mm/min)	回転数 n (min ⁻¹)	送り速度 Vf (mm/min)	回転数 n (min ⁻¹)	送り速度 Vf (mm/min)	
高速条件 High speed	RE3×6	7,960	2,230	7,960	2,230	7,960	2,230	7,960	2,230	7,960	1,430	6,630	1,190	5,300	950
	RE4×8	5,970	1,910	5,970	1,910	5,970	1,910	5,970	1,910	5,970	1,310	4,980	1,100	3,980	880
	RE5×10	4,770	1,720	4,770	1,720	4,770	1,720	4,770	1,720	4,770	1,240	3,980	1,030	3,180	830
	RE6×12	3,980	1,590	3,980	1,590	3,980	1,590	3,980	1,590	3,980	1,190	3,320	1,000	2,650	800
	RE8×16	2,980	1,340	2,980	1,340	2,980	1,340	2,980	1,340	2,980	1,010	2,490	850	1,990	680
RE10×20	2,390	1,070	2,390	1,070	2,390	1,070	2,390	1,070	2,390	810	1,990	680	1,590	540	
汎用条件 General	RE3×6	5,310	1,490	5,310	1,490	5,310	1,490	5,310	1,490	5,300	950	3,980	720	3,180	570
	RE4×8	3,980	1,270	3,980	1,270	3,980	1,270	3,980	1,270	3,980	880	2,980	660	2,390	530
	RE5×10	3,180	1,140	3,180	1,140	3,180	1,140	3,180	1,140	3,180	830	2,390	620	1,910	500
	RE6×12	2,650	1,060	2,650	1,060	2,650	1,060	2,650	1,060	2,650	800	1,990	600	1,590	480
	RE8×16	1,990	900	1,990	900	1,990	900	1,990	900	1,990	680	1,490	510	1,190	400
RE10×20	1,590	720	1,590	720	1,590	720	1,590	720	1,590	540	1,190	400	950	320	

- 【注意】**
- ① 切削方法は、ダウンカットで使用ください。
 - ② 一般材、とくに高速切削は、乾式（エアブロー）またはオイルミストクーラントにてご使用ください。
 - ③ ステンレス鋼および超耐熱合金には、不水溶性切削油のご使用が適しています。
 - ④ 安定した切削を行うため、剛性の高い機械とセットアップでご使用ください。
 - ⑤ 機械の回転数が足りない場合は、主軸回転数とテーブル送り速度を同比率で下げてください。
 - ⑥ 加工形状、機械の剛性、工具突き出し量等、ご使用の状況により、主軸回転数とテーブル送り速度の調整を行ってください。

- 【Note】**
- ① Down-cutting is recommended.
 - ② Use generally dry (air-blow) or oil-mist coolant, especially at the high-speed machining.
 - ③ Oil base coolant is recommended for machining stainless steels and heat-resistant alloys.
 - ④ Use a machine tool with rigidity and rigid set-up, to machine stably.
 - ⑤ When the revolution speed is not enough, reduce the revolution speed and table speed at the same ratio.
 - ⑥ Adjust the revolution speed and table speed, according to cutting conditions such as machining shape, rigidity of machine tool, over-hang and so on.

Carbide Ball End Mills for Mold 超硬型彫用ボールエンドミル

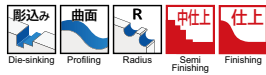

(mm)

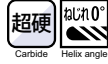

直刃 Straight flute

2枚刃
2Flutes



FE6

商品コード Item code	在庫 Stock	寸法 Size (mm)			
		ボール半径 Ball radius	刃長 Flute length	全長 Overall length	シャンク径 Shank dia.
FE604	<input type="checkbox"/>	2	20	65	4
FE606	<input type="checkbox"/>	3	25	80	6
FE608	<input type="checkbox"/>	4	25	80	8
FE610	<input type="checkbox"/>	5	25	80	10
FE612	<input type="checkbox"/>	6	30	80	12
FE614	<input type="checkbox"/>	7	30	80	14
FE616	<input type="checkbox"/>	8	35	110	16
FE618	<input type="checkbox"/>	9	35	110	18
FE620	<input type="checkbox"/>	10	35	110	20

Carbide Ball End Mills for Graphite 超硬グラファイト用ボールエンドミル

レギュラー刃長 Regular

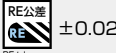
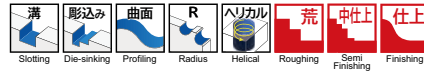

(mm)

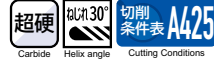

汎用機用 エアホールなし
For General without air-hole

2,4枚刃
2,4Flutes



GBR

商品コード Item code	在庫 Stock	寸法 Size (mm)				刃数 No. of flutes
		ボール半径 Ball radius	刃長 Flute length	全長 Overall length	シャンク径 Shank dia.	
GBR2020	<input type="checkbox"/>	1	10	80	6	2
GBR2025	<input type="checkbox"/>	1.25	10	80	6	2
GBR2030	<input type="checkbox"/>	1.5	15	80	6	2
GBR2040	<input type="checkbox"/>	2	20	80	6	2
GBR2045	<input type="checkbox"/>	2.25	25	100	6	2
GBR2050	<input type="checkbox"/>	2.5	25	100	6	2
GBR2060	<input type="checkbox"/>	3	30	100	6	2
GBR2065	<input type="checkbox"/>	3.25	35	100	6	2
GBR2070	<input type="checkbox"/>	3.5	35	100	6	2
GBR2080	<input type="checkbox"/>	4	40	110	8	2
GBR2085	<input type="checkbox"/>	4.25	45	110	8	2
GBR2090	<input type="checkbox"/>	4.5	45	110	8	2
GBR2100	<input type="checkbox"/>	5	50	120	10	2
GBR2105	<input type="checkbox"/>	5.25	50	120	10	2
GBR2110	<input type="checkbox"/>	5.5	50	120	10	2
GBR2120	<input type="checkbox"/>	6	55	130	12	2
GBR2125	<input type="checkbox"/>	6.25	55	130	12	2
GBR2130	<input type="checkbox"/>	6.5	55	130	12	2
GBR4140	<input type="checkbox"/>	7	60	140	12	4
GBR4150	<input type="checkbox"/>	7.5	60	140	12	4
GBR4160	<input type="checkbox"/>	8	65	150	16	4
GBR4170	<input type="checkbox"/>	8.5	65	150	16	4
GBR4180	<input type="checkbox"/>	9	65	160	16	4
GBR4200	<input type="checkbox"/>	10	75	160	20	4

ロング刃長 Long

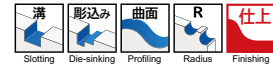

(mm)

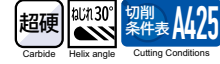

2,4枚刃
2,4Flutes



GBL

商品コード Item code	在庫 Stock	寸法 Size (mm)				刃数 No. of flutes
		ボール半径 Ball radius	刃長 Flute length	全長 Overall length	シャンク径 Shank dia.	
GBL2020	<input type="checkbox"/>	1	20	100	6	2
GBL2030	<input type="checkbox"/>	1.5	30	100	6	2
GBL2040	<input type="checkbox"/>	2	60	110	6	2
GBL2050	<input type="checkbox"/>	2.5	70	125	6	2
GBL2060	<input type="checkbox"/>	3	80	130	6	2
GBL2070	<input type="checkbox"/>	3.5	90	140	6	2
GBL2080	<input type="checkbox"/>	4	100	150	8	2
GBL2090	<input type="checkbox"/>	4.5	110	160	8	2
GBL2100	<input type="checkbox"/>	5	120	170	10	2
GBL2110	<input type="checkbox"/>	5.5	120	170	10	2
GBL2120	<input type="checkbox"/>	6	130	190	12	2
GBL2130	<input type="checkbox"/>	6.5	130	190	12	2
GBL4140	<input type="checkbox"/>	7	140	210	12	4
GBL4150	<input type="checkbox"/>	7.5	140	210	12	4
GBL4160	<input type="checkbox"/>	8	150	230	16	4
GBL4170	<input type="checkbox"/>	8.5	150	230	16	4
GBL4180	<input type="checkbox"/>	9	160	250	16	4
GBL4200	<input type="checkbox"/>	10	180	250	20	4

標準切削条件表 Recommended cutting conditions

GBR	GBL	GXB
レギュラー刃長 Regular	ロング刃長 Long	ロングシャンク Long Shank

被削材 Work material	グラファイト Graphite		鋳鉄 Cast irons FC, FCD		非鉄金属、アルミ、銅合金 Non-ferrous-metal, Aluminum, Cu-alloy		
	150~200HB		150~200HB		150~200HB		
硬さ Hardness	切削速度 Cutting speed Vc=200~250m/min		切削速度 Cutting speed Vc=50~100m/min		切削速度 Cutting speed Vc=150~100m/min		
	回転数 Revolution min ⁻¹	送り速度 Table speed mm/min	回転数 Revolution min ⁻¹	送り速度 Table speed mm/min	回転数 Revolution min ⁻¹	送り速度 Table speed mm/min	
RE1	2	44,000	800~1,000	11,000	250~300	25,000	500~600
RE2	4	22,000	1,000~1,300	5,600	300~400	12,500	600~800
RE3	6	15,000	1,200~1,500	3,700	350~450	8,500	700~900
RE4	8	11,000	1,800~2,000	2,800	550~600	6,400	1,100~1,200
RE5	10	8,800	2,000~2,500	2,200	600~700	5,100	1,200~1,400
RE6	12	7,300	2,000~2,500	1,800	600~700	4,200	1,200~1,400
RE7.5	15	5,800	1,800~2,000	1,500	550~600	3,400	1,100~1,200
RE8	16	5,500	1,600~1,800	1,400	500~600	3,200	1,000~1,200
RE9	18	4,900	1,600~1,700	1,200	400~500	2,800	800~1,000
RE10	20	4,400	1,200~1,400	1,100	350~450	2,500	700~900

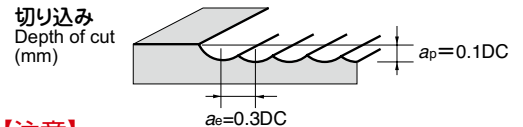

【注意】

- ①被削材、加工形状に合わせて、適切なクーラントを使用してください。
- ②上記に切削条件を示しますが、被削材の硬さ、切込み、ソーリング、機械の状態により条件を増減してください。
- ③汎用機、NCフライス盤で加工される場合は、切りくずの飛散防止のため、吸引機のご使用、または湿式切削を推奨します。乾式と湿式の寿命差はありません。
- ④回転数が不足する場合は、増速スピンドルのご使用を推奨します。

【Note】

- ①Use the appropriate coolant for the work material and machining shape.
- ②Standard cutting conditions are described above, but allowance should be made for these conditions according to hardness of work materials, depth of cut, tooling, and conditions of machines.
- ③When machining with a general purpose machine or an NC milling machine, it is recommended to use an aspirator or to perform wet cutting in order to prevent chips from scattering. There is no difference in life of end mills between dry cutting and wet cutting.
- ④In the case of insufficient revolution speed, it is recommended to use a high speed milling attachment.

FE6の対応被削材 Applicable work material of FE6

炭素鋼 合金鋼 Carbon steel Alloy steel	プリハー ド鋼 Pre-hardened steel ≤45HRC	高硬度 Hardened steel			ステン レス鋼 Stainless steel	チタン合金 耐熱合金 Titanium alloy Heat-resistant alloy	銅合金 Copper alloy	アルミ 合金 Aluminum alloy
		>45HRC ≤55HRC	>55HRC ≤65HRC	>65HRC				
<input type="checkbox"/>	<input type="checkbox"/>	<input type="checkbox"/>	<input type="checkbox"/>	<input type="checkbox"/>	<input type="checkbox"/>	<input type="checkbox"/>	<input type="checkbox"/>	

グラファイト用エンドミルの対応被削材 Applicable work material of End mill for Graphite

炭素鋼 合金鋼 Carbon steel Alloy steel	プリハー ド鋼 Pre-hardened steel ≤45HRC	高硬度 Hardened steel			ステン レス鋼 Stainless steel	チタン合金 耐熱合金 Titanium alloy Heat-resistant alloy	銅合金 Copper alloy	アルミ 合金 Aluminum alloy
		>45HRC ≤55HRC	>55HRC ≤65HRC	>65HRC				
グラファイト用 for Graphite								

印：特定代理店在庫です。弊社営業へお問合せください。 ：Stocked by specified distributor. Contact with our sales department.

Carbide Ball End Mills for Graphite

超硬グラファイト用ボールエンドミル

超硬ボールエンドミル 特約代理店在庫品

ロングシャンク Long Shank

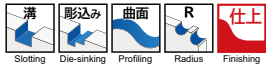

RE公差 ±0.02 h6
超硬 傾斜30° 切削条件表 A425
汎用機用 エアホールなし For General without air-hole



GXB

商品コード Item code	在庫 Stock	寸法 Size (mm)				刃数 No. of flutes
		ボール半径 Ball radius	刃長 Flute length	全長 Overall length	シャンク径 Shank dia.	
GXB2020	<input type="checkbox"/>	1	10	100	6	2
GXB2030	<input type="checkbox"/>	1.5	15	100	6	2
GXB2040	<input type="checkbox"/>	2	20	110	6	2
GXB2050	<input type="checkbox"/>	2.5	25	125	6	2
GXB2060	<input type="checkbox"/>	3	30	130	6	2
GXB2070	<input type="checkbox"/>	3.5	35	140	6	2
GXB2080	<input type="checkbox"/>	4	40	150	8	2
GXB2090	<input type="checkbox"/>	4.5	45	160	8	2
GXB2100	<input type="checkbox"/>	5	50	170	10	2
GXB2110	<input type="checkbox"/>	5.5	50	170	10	2
GXB2120	<input type="checkbox"/>	6	55	190	12	2
GXB2130	<input type="checkbox"/>	6.5	55	190	12	2
GXB4140	<input type="checkbox"/>	7	60	210	12	4
GXB4150	<input type="checkbox"/>	7.5	60	210	12	4
GXB4160	<input type="checkbox"/>	8	65	230	16	4
GXB4170	<input type="checkbox"/>	8.5	65	230	16	4
GXB4180	<input type="checkbox"/>	9	65	250	16	4
GXB4200	<input type="checkbox"/>	10	75	250	20	4

レギュラー刃長 Regular



RE公差 ±0.02 h6
超硬 傾斜15° 切削条件表 A426
専用機用 エアホール付き For Custom with air-hole



GBS

商品コード Item code	在庫 Stock	寸法 Size (mm)				刃数 No. of flutes
		ボール半径 Ball radius	刃長 Flute length	全長 Overall length	シャンク径 Shank dia.	
※ GBS2020	<input type="checkbox"/>	1	10	80	4	2
※ GBS2030	<input type="checkbox"/>	1.5	15	80	4	2
※ GBS2040	<input type="checkbox"/>	2	20	80	4	2
GBS2050	<input type="checkbox"/>	2.5	30	100	6	2
GBS2060	<input type="checkbox"/>	3	30	100	6	2
GBS2070	<input type="checkbox"/>	3.5	30	100	6	2
GBS2080	<input type="checkbox"/>	4	40	110	8	2
GBS2090	<input type="checkbox"/>	4.5	40	110	8	2
GBS2100	<input type="checkbox"/>	5	50	120	10	2
GBS2110	<input type="checkbox"/>	5.5	50	120	10	2
GBS2120	<input type="checkbox"/>	6	55	130	12	2
GBS2130	<input type="checkbox"/>	6.5	55	130	12	2
GBS4160	<input type="checkbox"/>	8	60	150	16	4
GBS4170	<input type="checkbox"/>	8.5	60	150	16	4
GBS4180	<input type="checkbox"/>	9	60	150	20	4
GBS4200	<input type="checkbox"/>	10	60	150	20	4
GBS4210	<input type="checkbox"/>	10.5	60	150	20	4
GBS4220	<input type="checkbox"/>	11	60	150	20	4
GBS4250	<input type="checkbox"/>	12.5	60	180	25	4

ロングシャンク Long Shank

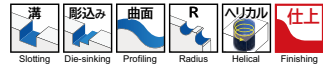

RE公差 ±0.02 h6
傾斜15° 超硬 切削条件表 A426
専用機用 エアホール付き For Custom with air-hole



GBD

商品コード Item code	在庫 Stock	寸法 Size (mm)				刃数 No. of flutes
		ボール半径 Ball radius	刃長 Flute length	全長 Overall length	シャンク径 Shank dia.	
※ GBD2020	<input type="checkbox"/>	1	10	100	4	2
※ GBD2030	<input type="checkbox"/>	1.5	15	100	4	2
※ GBD2040	<input type="checkbox"/>	2	20	100	4	2
GBD2050	<input type="checkbox"/>	2.5	30	120	6	2
GBD2060	<input type="checkbox"/>	3	30	150	6	2
GBD2070	<input type="checkbox"/>	3.5	30	150	6	2
GBD2080	<input type="checkbox"/>	4	40	150	8	2
GBD2090	<input type="checkbox"/>	4.5	40	150	8	2
GBD2100	<input type="checkbox"/>	5	50	180	10	2
GBD2110	<input type="checkbox"/>	5.5	50	180	10	2
GBD2120	<input type="checkbox"/>	6	55	200	12	2
GBD2130	<input type="checkbox"/>	6.5	55	200	12	2
GBD4160	<input type="checkbox"/>	8	60	250	16	4
GBD4170	<input type="checkbox"/>	8.5	60	250	16	4
GBD4180	<input type="checkbox"/>	9	60	250	20	4
GBD4200	<input type="checkbox"/>	10	60	250	20	4
GBD4210	<input type="checkbox"/>	10.5	60	250	20	4
GBD4220	<input type="checkbox"/>	11	60	250	20	4
GBD4250	<input type="checkbox"/>	12.5	60	250	25	4

標準切削条件表 Recommended cutting conditions

GBS レギュラー刃長 Regular

商品コード Item code	切削条件 Conditions	
	回転数 Revolution (min ⁻¹)	送り速度 Table speed (mm/min)
GBS2020	15,000	300
GBS2030	15,000	450
GBS2040	15,000	600
GBS2050	15,000	750
GBS2060	15,000	900
GBS2070	15,000	1,000
GBS2080	13,900	1,100
GBS2090	12,400	1,100
GBS2100	11,100	1,100
GBS2110	10,100	1,100
GBS2120	9,300	1,100
GBS2130	8,600	1,100
GBS4160	7,000	2,200
GBS4170	6,600	2,200
GBS4180	6,200	2,200
GBS4200	5,600	2,200
GBS4210	5,300	2,200
GBS4220	5,100	2,200
GBS4250	4,500	2,200

GBD ロングシャンク Long Shank

商品コード Item code	切削条件 Conditions	
	回転数 Revolution (min ⁻¹)	送り速度 Table speed (mm/min)
GBD2020	15,000	150
GBD2030	15,000	200
GBD2040	15,000	300
GBD2050	15,000	400
GBD2060	15,000	450
GBD2070	15,000	500
GBD2080	13,900	550
GBD2090	12,400	550
GBD2100	11,100	550
GBD2110	10,100	550
GBD2120	9,300	550
GBD2130	8,600	550
GBD4160	7,000	1,100
GBD4170	6,600	1,100
GBD4180	6,200	1,100
GBD4200	5,600	1,100
GBD4210	5,300	1,000
GBD4220	5,100	1,000
GBD4250	4,500	1,100

【注意】

- ①被削材、加工形状に合わせて、適切なクーラントを使用してください。
- ②上記に切削条件を示しますが、被削材の硬さ、切込み、ツーリング、機械の状態により条件を増減してください。
- ③汎用機、NCフライス盤で加工される場合は、切りくずの飛散防止のため、吸引機のご使用、または湿式切削を推奨します。乾式と湿式の寿命差はありません。
- ④回転数が不足する場合は、増速スピンドルのご使用を推奨します。

【Note】

- ① Use the appropriate coolant for the work material and machining shape.
- ② Standard cutting conditions are described above, but allowance should be made for these conditions according to hardness of work materials, depth of cut, tooling, and conditions of machines.
- ③ When machining with a general purpose machine or an NC milling machine, it is recommended to use an aspirator or to perform wet cutting in order to prevent chips from scattering. There is no difference in life of end mills between dry cutting and wet cutting.
- ④ In the case of insufficient revolution speed, it is recommended to use a high speed milling attachment.

※印：エアホールなしとなっています。
※：Without air-hole.

Epoch Juoh-J エポックじゅうおう-J

レギュラー刃長・コーナR付き Regular, Corner radius

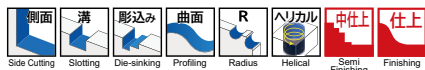

外径公差
Dia. tolerance 0~-0.02



(mm)

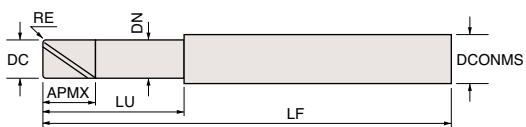

切削条件表 A428
Cutting Conditions



EPJS20000-000-J

商品コード Item code	在庫 Stock	寸法 Size (mm)							シャンク径 Shank dia.
		外径 Tool dia.	コーナ半径 Corner radius	刃長 Flute length	首径 Neck dia.	首下長 Under neck length	全長 Overall length	DC	
		DC	RE	APMX	DN	LU	LF	DCONMS	
EPJS2040-03-J	<input type="checkbox"/>	4	0.3	6	3.8	14	70	4	
EPJS2060-05-J	<input type="checkbox"/>	6	0.5	9	5.8	21	90	6	
EPJS2060-10-J	<input type="checkbox"/>		1	9	5.8	21	90	6	
EPJS2080-05-J	<input type="checkbox"/>	8	0.5	12	7.7	28	100	8	
EPJS2080-10-J	<input type="checkbox"/>		1	12	7.7	28	100	8	
EPJS2100-05-J	<input type="checkbox"/>	10	0.5	15	9.7	35	100	10	
EPJS2100-10-J	<input type="checkbox"/>		1	15	9.7	35	100	10	
EPJS2100-20-J	<input type="checkbox"/>		2	15	9.7	35	100	10	
EPJS2120-05-J	<input type="checkbox"/>	12	0.5	18	11.7	42	110	12	
EPJS2120-10-J	<input type="checkbox"/>		1	18	11.7	42	110	12	
EPJS2120-20-J	<input type="checkbox"/>		2	18	11.7	42	110	12	

ロングシャンク・コーナR付き Long Shank, Corner radius

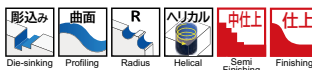

外径公差
Dia. tolerance 0~-0.02



(mm)

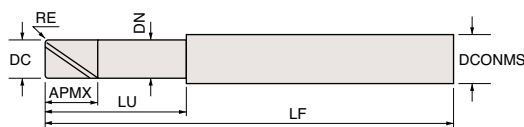

切削条件表 A428
Cutting Conditions



EPJSL20000-000-J

商品コード Item code	在庫 Stock	寸法 Size (mm)							シャンク径 Shank dia.
		外径 Tool dia.	コーナ半径 Corner radius	刃長 Flute length	首径 Neck dia.	首下長 Under neck length	全長 Overall length	DC	
		DC	RE	APMX	DN	LU	LF	DCONMS	
EPJSL2040-03-J	<input type="checkbox"/>	4	0.3	6	3.8	24	100	4	
EPJSL2060-05-J	<input type="checkbox"/>	6	0.5	9	5.8	36	120	6	
EPJSL2060-10-J	<input type="checkbox"/>		1	9	5.8	36	120	6	
EPJSL2080-05-J	<input type="checkbox"/>	8	0.5	12	7.7	48	135	8	
EPJSL2080-10-J	<input type="checkbox"/>		1	12	7.7	48	135	8	
EPJSL2100-05-J	<input type="checkbox"/>	10	0.5	15	9.7	60	150	10	
EPJSL2100-10-J	<input type="checkbox"/>		1	15	9.7	60	150	10	
EPJSL2100-20-J	<input type="checkbox"/>		2	15	9.7	60	150	10	
EPJSL2120-05-J	<input type="checkbox"/>	12	0.5	18	11.7	72	160	12	
EPJSL2120-10-J	<input type="checkbox"/>		1	18	11.7	72	160	12	
EPJSL2120-20-J	<input type="checkbox"/>		2	18	11.7	72	160	12	

EPJS-J、EPJSLJ-Jの対応被削材

Applicable work material of EPJS-J, EPJSLJ-J

炭素鋼 合金鋼 Carbon steel Alloy steel	プリハー ド鋼 Pre-hardened steel ≤ 45HRC	高硬度 Hardened steel			ステン レス鋼 Stainless steel	チタン合金 耐熱合金 Titanium alloy Heat-resistant alloy	銅合金 Copper alloy	アルミ 合金 Aluminum alloy
		> 45HRC ≤ 55HRC	> 55HRC ≤ 65HRC	> 65HRC				
○	○	○	○	○	○	○	○	

□印：特定代理店在庫です。弊社営業へお問合せください。 □：Stocked by specified distributor. Contact with our sales department.

Carbide End Mills

Stocked by Specified distributor

標準切削条件表 Recommended cutting conditions

EPJS-J

レギュラー刃長
Regular

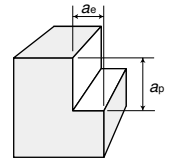

<肩切削> Side cutting レギュラー刃 OH量=3.5DC Regular Over Hang OH=3.5DC

被削材 Work material	鋳鉄 Cast irons (150~200HB) FC250		炭素鋼 Carbon steels (180~220HB) SS400, S50C		合金鋼 Alloy steels (200~250HB) SCM440, SNCM		ステンレス鋼・工具鋼 Stainless steels, Tool steels (25~35HRC) SUS304, SKD		プリハードン鋼 Pre-hardened steels (35~45HRC) HPM1, NAK55		焼入れ鋼 Hardened steels (45~55HRC) SKD61, SKT4		チタン合金 Titanium alloy Ti-6Al-4V		超耐熱合金 Super heat-resistant alloy Inconel Hasteloy		
	切込み Depth of cut (mm)	ap=0.1DC ae=0.1DC	ap=0.1DC ae=0.1DC	ap=0.1DC ae=0.1DC	ap=0.1DC ae=0.1DC	ap=0.1DC ae=0.1DC	ap=0.1DC ae=0.1DC	ap=0.1DC ae=0.1DC	ap=0.1DC ae=0.1DC	ap=0.1DC ae=0.1DC	ap=0.05DC ae=0.05DC	ap=0.05DC ae=0.05DC	ap=0.05DC ae=0.05DC	ap=0.05DC ae=0.05DC	ap=0.05DC ae=0.05DC	ap=0.05DC ae=0.05DC	
高速条件 High speed	外径DC Tool dia. (mm)	回転数 n (min ⁻¹)	送り速度 Vf (mm/min)	回転数 n (min ⁻¹)	送り速度 Vf (mm/min)	回転数 n (min ⁻¹)	送り速度 Vf (mm/min)	回転数 n (min ⁻¹)	送り速度 Vf (mm/min)	回転数 n (min ⁻¹)	送り速度 Vf (mm/min)	回転数 n (min ⁻¹)	送り速度 Vf (mm/min)	回転数 n (min ⁻¹)	送り速度 Vf (mm/min)	回転数 n (min ⁻¹)	送り速度 Vf (mm/min)
	φ4	19,900	1,190	19,900	1,190	15,900	950	11,900	600	11,900	600	11,900	600	9,550	380	2,390	95
	φ6	13,300	1,330	13,300	1,330	10,600	1,060	7,960	640	7,960	640	7,960	640	6,370	450	1,590	110
	φ8	9,950	1,390	9,950	1,390	7,960	1,110	5,970	600	5,970	600	5,970	600	4,780	430	1,190	110
	φ10	7,960	1,270	7,960	1,270	6,370	1,020	4,770	570	4,770	570	4,770	570	3,820	420	950	100
φ12	6,630	1,190	6,630	1,190	5,310	960	3,980	560	3,980	560	3,980	560	3,180	380	800	95	
汎用条件 General	切込み Depth of cut (mm)	ap=0.2DC ae=0.3DC	ap=0.2DC ae=0.3DC	ap=0.2DC ae=0.3DC	ap=0.2DC ae=0.3DC	ap=0.2DC ae=0.3DC	ap=0.2DC ae=0.3DC	ap=0.2DC ae=0.3DC	ap=0.2DC ae=0.3DC	ap=0.2DC ae=0.3DC	ap=0.1DC ae=0.15DC	ap=0.1DC ae=0.15DC	ap=0.1DC ae=0.15DC	ap=0.1DC ae=0.15DC	ap=0.1DC ae=0.15DC	ap=0.1DC ae=0.15DC	
	外径DC Tool dia. (mm)	回転数 n (min ⁻¹)	送り速度 Vf (mm/min)	回転数 n (min ⁻¹)	送り速度 Vf (mm/min)	回転数 n (min ⁻¹)	送り速度 Vf (mm/min)	回転数 n (min ⁻¹)	送り速度 Vf (mm/min)	回転数 n (min ⁻¹)	送り速度 Vf (mm/min)	回転数 n (min ⁻¹)	送り速度 Vf (mm/min)	回転数 n (min ⁻¹)	送り速度 Vf (mm/min)	回転数 n (min ⁻¹)	送り速度 Vf (mm/min)
	φ4	7,960	480	7,960	480	6,370	380	4,770	240	4,770	240	4,770	240	3,180	130	1,990	80
	φ6	5,310	530	5,310	530	4,240	420	3,180	250	3,180	250	3,180	250	2,120	150	1,330	95
	φ8	3,980	560	3,980	560	3,180	450	2,390	240	2,390	240	2,390	240	1,590	140	990	90
φ10	3,180	510	3,180	510	2,550	410	1,910	230	1,910	230	1,910	230	1,270	140	800	90	
φ12	2,650	480	2,650	480	2,120	380	1,590	220	1,590	220	1,590	220	1,060	130	660	80	

EPJSLS-J

ロングシャンク
Long Shank

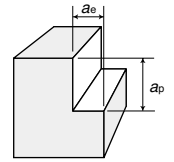

<肩切削> Side cutting ロングシャンク OH量=6DC Long shank Over Hang OH=6DC

被削材 Work material	鋳鉄 Cast irons (150~200HB) FC250		炭素鋼 Carbon steels (180~220HB) SS400, S50C		合金鋼 Alloy steels (200~250HB) SCM440, SNCM		ステンレス鋼・工具鋼 Stainless steels, Tool steels (25~35HRC) SUS304, SKD		プリハードン鋼 Pre-hardened steels (35~45HRC) HPM1, NAK55		焼入れ鋼 Hardened steels (45~55HRC) SKD61, SKT4		チタン合金 Titanium alloys Ti-6Al-4V		超耐熱合金 Super heat-resistant alloys Inconel Hasteloy		
	切込み Depth of cut (mm)	ap=0.1DC ae=0.1DC	ap=0.1DC ae=0.1DC	ap=0.1DC ae=0.1DC	ap=0.1DC ae=0.1DC	ap=0.1DC ae=0.1DC	ap=0.1DC ae=0.1DC	ap=0.1DC ae=0.1DC	ap=0.1DC ae=0.1DC	ap=0.1DC ae=0.1DC	ap=0.05DC ae=0.05DC	ap=0.05DC ae=0.05DC	ap=0.05DC ae=0.05DC	ap=0.05DC ae=0.05DC	ap=0.05DC ae=0.05DC	ap=0.05DC ae=0.05DC	
高速条件 High speed	外径DC Tool dia. (mm)	回転数 n (min ⁻¹)	送り速度 Vf (mm/min)	回転数 n (min ⁻¹)	送り速度 Vf (mm/min)	回転数 n (min ⁻¹)	送り速度 Vf (mm/min)	回転数 n (min ⁻¹)	送り速度 Vf (mm/min)	回転数 n (min ⁻¹)	送り速度 Vf (mm/min)	回転数 n (min ⁻¹)	送り速度 Vf (mm/min)	回転数 n (min ⁻¹)	送り速度 Vf (mm/min)	回転数 n (min ⁻¹)	送り速度 Vf (mm/min)
	φ4	9,550	570	9,550	570	6,370	380	4,770	240	4,770	240	4,770	240	3,980	160	1,590	65
	φ6	6,370	640	6,370	640	4,240	420	3,180	250	3,180	250	3,180	250	2,650	190	1,060	75
	φ8	4,770	670	4,770	670	3,180	450	2,390	240	2,390	240	2,390	240	1,990	180	800	70
	φ10	3,820	610	3,820	610	2,550	410	1,910	230	1,910	230	1,910	230	1,590	170	640	70
φ12	3,180	570	3,180	570	2,120	380	1,590	220	1,590	220	1,590	220	1,330	160	530	65	
汎用条件 General	切込み Depth of cut (mm)	ap=0.2DC ae=0.3DC	ap=0.2DC ae=0.3DC	ap=0.2DC ae=0.3DC	ap=0.2DC ae=0.3DC	ap=0.2DC ae=0.3DC	ap=0.2DC ae=0.3DC	ap=0.2DC ae=0.3DC	ap=0.2DC ae=0.3DC	ap=0.2DC ae=0.3DC	ap=0.1DC ae=0.15DC	ap=0.1DC ae=0.15DC	ap=0.1DC ae=0.15DC	ap=0.1DC ae=0.15DC	ap=0.1DC ae=0.15DC	ap=0.1DC ae=0.15DC	
	外径DC Tool dia. (mm)	回転数 n (min ⁻¹)	送り速度 Vf (mm/min)	回転数 n (min ⁻¹)	送り速度 Vf (mm/min)	回転数 n (min ⁻¹)	送り速度 Vf (mm/min)	回転数 n (min ⁻¹)	送り速度 Vf (mm/min)	回転数 n (min ⁻¹)	送り速度 Vf (mm/min)	回転数 n (min ⁻¹)	送り速度 Vf (mm/min)	回転数 n (min ⁻¹)	送り速度 Vf (mm/min)	回転数 n (min ⁻¹)	送り速度 Vf (mm/min)
	φ4	3,980	240	3,980	240	3,180	190	2,390	120	2,390	120	2,390	120	1,590	65	1,190	50
	φ6	2,650	270	2,650	270	2,120	210	1,590	130	1,590	130	1,590	130	1,060	75	800	55
	φ8	1,990	280	1,990	280	1,590	220	1,190	120	1,190	120	1,190	120	800	70	600	55
φ10	1,590	250	1,590	250	1,270	200	950	110	950	110	950	110	640	70	480	55	
φ12	1,330	240	1,330	240	1,060	190	800	110	800	110	800	110	530	65	400	50	

- [注意]** ①切削方法は、ダウンカットで使用ください。
 ②一般材、とくに高速切削は、乾式(エアブロー)またはオイルミストクーラントにてご使用ください。
 ③ステンレス鋼および超耐熱合金には、不水溶性切削油のご使用が適しています。
 ④安定した切削を行うため、剛性の高い機械とセットアップでご使用ください。
 ⑤機械の回転数が足りない場合は、主軸回転数とテーブル送り速度を同比率で下げてください。
 ⑥加工形状、機械の剛性、工具突き出し量等、ご使用の状況により、主軸回転数とテーブル送り速度の調整を行ってください。

- [Note]** ① Down-cutting is recommended.
 ② Use generally dry (air-blow) or oil-mist coolant, especially at the high-speed machining.
 ③ Oil base coolant is recommended for machining stainless steels and heat-resistant alloys.
 ④ Use a machine tool with rigidity and rigid set-up, to machine stably.
 ⑤ When the revolution speed is not enough, reduce the revolution speed and table speed at the same ratio.
 ⑥ Adjust the revolution speed and table speed, according to cutting conditions such as machining shape, rigidity of machine tool, over-hang and so on.

Epoch High Feed Radius エポックハイフィードラジラス

ストレートネック・コーナR付き Straight neck, Corner radius

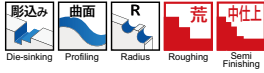

RE公差 ±0.015

h5

(mm)

3枚刃
3Flutes

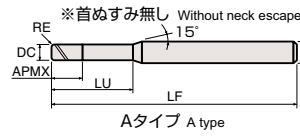

Aタイプ A type

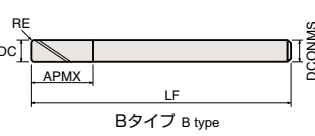

Bタイプ B type

EPR3

超硬 TH 傾斜45° 切削条件表 A429
Carbide Helix angle Cutting Conditions

商品コード Item code	在庫 Stock	寸法 Size (mm)						形状 Shape
		外径 Tool dia. DC	コーナ半径 Corner radius RE	刃長 Flute length APMX	首下長 Under neck length LU	全長 Overall length LF	シャンク径 Shank dia. DCONMS	
EPR3020-05	<input type="checkbox"/>	2	0.5	4	6	70	6	A
EPR3030-08	<input type="checkbox"/>	3	0.8	6	9	70	6	A
EPR3040-10	<input type="checkbox"/>	4	1.0	8	12	70	6	A
EPR3050-12	<input type="checkbox"/>	5	1.2	10	15	70	6	A
EPR3060-15	<input type="checkbox"/>	6	1.5	12	-	90	6	B
EPR3080-20	<input type="checkbox"/>	8	2.0	16	-	100	8	B
EPR3100-20	<input type="checkbox"/>	10	2.0	20	-	110	10	B
EPR3120-20	<input type="checkbox"/>	12	2.0	24	-	120	12	B
EPR3160-30	<input type="checkbox"/>	16	3.0	32	-	140	16	B
EPR3200-30	<input type="checkbox"/>	20	3.0	40	-	150	20	B

● EPR、EPRPNの対応被削材

Applicable work material of EPR, EPRPN

炭素鋼 合金鋼 Carbon steel Alloy steel	プリハードン 鋼 Pre-hardened steel	高硬度 Hardened steel			ステン レス鋼 Stainless steel	チタン合金 耐熱合金 Titanium alloy Heat-resistant alloy	銅合金 Copper alloy	アルミ 合金 Aluminum alloy
		> 45HRC ≤ 45HRC	> 55HRC ≤ 55HRC	> 65HRC ≤ 65HRC				
<input type="checkbox"/>	<input type="checkbox"/>	<input type="checkbox"/>	<input type="checkbox"/>	<input type="checkbox"/>	<input type="checkbox"/>	<input type="checkbox"/>	<input type="checkbox"/>	

ペンシルネック・コーナR付き Pencil neck, Corner radius

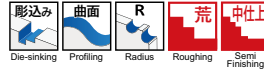

RE公差 ±0.015

h5

(mm)

3枚刃
3Flutes

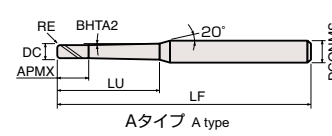

Aタイプ A type

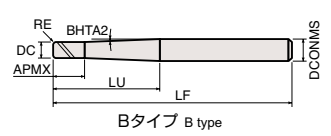

Bタイプ B type

EPRPN3

超硬 TH 傾斜45° 切削条件表 A429
Carbide Helix angle Cutting Conditions

商品コード Item code	在庫 Stock	寸法 Size (mm)						形状 Shape	
		外径 Tool dia. DC	コーナ半径 Corner radius RE	刃長 Flute length APMX	首下長 Under neck length LU	首下角 Neck angle BHTA2	全長 Overall length LF		シャンク径 Shank dia. DCONMS
EPRPN3020-12-05	<input type="checkbox"/>	2	0.5	3	12	1°	70	6	A
EPRPN3020-16-05	<input type="checkbox"/>	2	0.5	3	16	1°	70	6	A
EPRPN3020-20-05	<input type="checkbox"/>	2	0.5	3	20	1°	70	6	A
EPRPN3030-18-08	<input type="checkbox"/>	3	0.8	4.5	18	1°	80	6	A
EPRPN3030-24-08	<input type="checkbox"/>	3	0.8	4.5	24	1°	80	6	A
EPRPN3030-30-08	<input type="checkbox"/>	3	0.8	4.5	30	1°	80	6	A
EPRPN3040-24-10	<input type="checkbox"/>	4	1.0	6	24	1°	90	6	A
EPRPN3040-32-10	<input type="checkbox"/>	4	1.0	6	32	1°	90	6	A
EPRPN3040-40-10	<input type="checkbox"/>	4	1.0	6	40	1°	90	6	A
EPRPN3050-30-12	<input type="checkbox"/>	5	1.2	7.5	30	1°	90	6	A
EPRPN3050-40-12	<input type="checkbox"/>	5	1.2	7.5	40	1°	100	8	A
EPRPN3050-50-12	<input type="checkbox"/>	5	1.2	7.5	50	1°	110	8	A
EPRPN3060-40-15	<input type="checkbox"/>	6	1.5	9	40	1°	100	8	A
EPRPN3060-55-15	<input type="checkbox"/>	6	1.5	9	55	1°	110	8	A
EPRPN3060-67-15	<input type="checkbox"/>	6	1.5	9	67	1°	125	8	B
EPRPN3080-55-20	<input type="checkbox"/>	8	2.0	12	55	1°	110	10	A
EPRPN3080-70-20	<input type="checkbox"/>	8	2.0	12	70	1°	130	10	B
EPRPN3080-90-20	<input type="checkbox"/>	8	2.0	12	90	1°	145	12	A
EPRPN3100-73-20	<input type="checkbox"/>	10	2.0	15	73	1°	135	12	B
EPRPN3100-95-20	<input type="checkbox"/>	10	2.0	15	95	1°	150	16	A
EPRPN3100-115-20	<input type="checkbox"/>	10	2.0	15	115	1°	170	16	A
EPRPN3120-80-20	<input type="checkbox"/>	12	2.0	18	80	1°	135	16	A
EPRPN3120-105-20	<input type="checkbox"/>	12	2.0	18	105	1°	160	16	A
EPRPN3160-105-30	<input type="checkbox"/>	16	3.0	24	105	1°	160	20	A
EPRPN3160-140-30	<input type="checkbox"/>	16	3.0	24	140	1°	200	20	B

● 標準切削条件表 Recommended cutting conditions

EPR

EPRPN

被削材 Work material	鋳鉄・炭素鋼・合金鋼 Cast irons, Carbon steels, Alloy steels (150~250HB) FC, S50C, SCM			工具鋼 Tool steels (25~35HRC) SUS304, SKD			プリハードン鋼 Pre-hardened steels (35~45HRC) NAK80, CENA1			焼入れ鋼* Hardened steels (45~55HRC) SKD61, SKT4		
	外径DC× コーナ半径RE Tool dia.(mm)	回転数 n (min ⁻¹)	1刃送り fz (mm/t)	送り速度 vf (mm/min)	回転数 n (min ⁻¹)	1刃送り fz (mm/t)	送り速度 vf (mm/min)	回転数 n (min ⁻¹)	1刃送り fz (mm/t)	送り速度 vf (mm/min)	回転数 n (min ⁻¹)	1刃送り fz (mm/t)
2×RE0.5	12,000	0.11	3,960	11,000	0.1	3,300	10,000	0.08	2,400	8,000	0.08	1,920
3×RE0.8	8,000	0.19	4,560	7,400	0.17	3,770	6,900	0.13	2,690	5,300	0.13	2,070
4×RE1	6,000	0.27	4,860	5,600	0.25	4,200	5,200	0.19	2,960	4,000	0.19	2,280
5×RE1.2	4,800	0.33	4,750	4,500	0.3	4,050	4,100	0.24	2,950	3,200	0.24	2,300
6×RE1.5	4,000	0.42	5,040	3,700	0.38	4,220	3,500	0.3	3,150	2,700	0.3	2,430
8×RE2	3,000	0.56	5,040	2,800	0.51	4,280	2,600	0.4	3,120	2,000	0.4	2,400
10×RE2	2,400	0.7	5,040	2,200	0.64	4,220	2,100	0.5	3,150	1,600	0.5	2,400
12×RE2	2,000	0.8	4,800	1,900	0.75	4,280	1,700	0.58	2,960	1,300	0.58	2,260
16×RE3	1,500	0.85	3,830	1,400	0.8	3,360	1,300	0.66	2,570	1,000	0.66	1,980
20×RE3	1,200	0.85	3,060	1,100	0.8	2,640	1,000	0.66	1,980	800	0.66	1,580

【注意 Note】

- ① 工具突き出し比率6DC以上の加工にはペンシルネックタイプのご使用を推奨いたします。
- ② 等高加工のダウンカットにてご使用ください。Z切込みは傾斜切込み(傾斜角1°)とし、この際の送り速度は上記条件表の70~60%に下げてください。
- ③ この切削条件表は切削条件の目安を示すものです。実際の切削状態により切削条件の調整を行ってください。
- ④ 基本的に乾式切削またはセミドライ切削(共にエアブローは必要)を推奨いたします。
- ⑤ できるだけ高剛性、高精度の機械をご使用ください。

- ① In the case of cutting with overhang 6DC or over, we'll recommend pencil-neck type (EPRPN).
- ② Please use Z-constant & down cut. In the down cut processing, please process tamping (tamping angle = 1 deg) and please down the feed rate 70~60% as above condition.
- ③ Please understand above condition is only as general one. Please regulate it is each case.
- ④ We recommended dry or semidry cutting. (Please use Air-blow)
- ⑤ We recommend you to use the machining as much rigidity, accuracy as you can.

■ 切込み量と工具突き出し比率 Relation between the depth of cut and overhang.

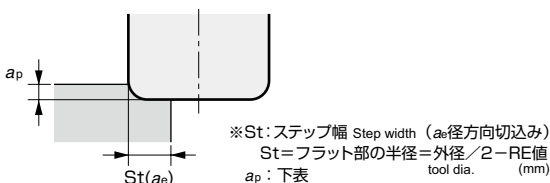

工具突き出し比率 Overhang	ap: Z切込み量 Z pick mm	工具突き出し比率 Overhang	ap: Z切込み量 Z pick mm
5DC以下	0.30×RE	8DC	0.23×RE
6DC	0.27×RE	9DC	0.19×RE
7DC	0.25×RE	10DC	0.15×RE

※焼入れ鋼(45~55HRC)の加工ではZ方向切込み量apを上記よりも30%程度小さく設定してください。
In case of hardened steel cutting, please decrease ap 0.7 times as above.

□印: 特定代理店在庫です。弊社営業へお問合せください。

□: Stocked by specified distributor. Contact with our sales department.

Carbide End Mills

Stocked by Specified distributor

Epoch Deep Square エポックディープスクエア

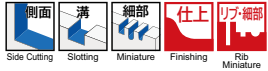

Dia tolerance
 φ0.1~φ0.5 : 0~-0.007
 φ0.6~φ0.9 : 0~-0.01
 φ1~φ4 : 0~-0.015



(mm)



2枚刃
2Flutes

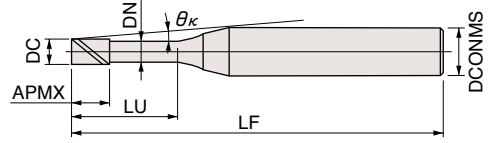

EPDS2○○○-○○(-TH)



CSコーティング CS Coating		THコーティング TH Coating		寸法 Size(mm)							干渉角度 Interference angle (°) θ _k	勾配角に対する実有効首下長 The effective under-neck length for the various draft angles				
商品コード Item code	在庫 Stock	商品コード Item code	在庫 Stock	外径 Tool dia. DC	首下長 Under neck length LU	刃長 Flute length APMX	首径 Neck dia. DN	全長 Overall length LF	シャンク径 Shank dia. DCONMS	首R Neck R	θ _k	0.5°	1°	1.5°	2°	3°
EPDS2001-0.3	<input type="checkbox"/>	EPDS2001-0.3-TH	<input type="checkbox"/>	0.1	0.3	0.15	0.08	45	4	1	11.58	0.46	0.49	0.51	0.53	0.58
EPDS2001-0.5	<input type="checkbox"/>	EPDS2001-0.5-TH	<input type="checkbox"/>	0.1	0.5	0.15	0.08	45	4	1	11.35	0.67	0.71	0.74	0.76	0.82
EPDS2001-1	<input type="checkbox"/>	EPDS2001-1-TH	<input type="checkbox"/>	0.1	1	0.15	0.08	45	4	1	10.81	1.2	1.25	1.29	1.33	1.4
EPDS2002-0.5	<input type="checkbox"/>	EPDS2002-0.5-TH	<input type="checkbox"/>	0.2	0.5	0.3	0.17	50	4	10	11.3	1.21	1.38	1.55	1.72	2.06
EPDS2002-1	<input type="checkbox"/>	EPDS2002-1-TH	<input type="checkbox"/>	0.2	1	0.3	0.17	50	4	10	10.75	1.78	1.99	2.2	2.4	2.78
EPDS2002-1.5	<input type="checkbox"/>	EPDS2002-1.5-TH	<input type="checkbox"/>	0.2	1.5	0.3	0.17	50	4	10	10.25	2.34	2.59	2.83	3.05	3.47
EPDS2003-1	<input type="checkbox"/>	EPDS2003-1-TH	<input type="checkbox"/>	0.3	1	0.45	0.27	50	4	10	10.72	1.78	1.99	2.2	2.4	2.78
EPDS2003-1.5	<input type="checkbox"/>	EPDS2003-1.5-TH	<input type="checkbox"/>	0.3	1.5	0.45	0.27	50	4	10	10.21	2.34	2.59	2.83	3.05	3.47
EPDS2003-2	<input type="checkbox"/>	EPDS2003-2-TH	<input type="checkbox"/>	0.3	2	0.45	0.27	50	4	10	9.75	2.89	3.18	3.44	3.69	4.14
EPDS2003-2.5	<input type="checkbox"/>	EPDS2003-2.5-TH	<input type="checkbox"/>	0.3	2.5	0.45	0.27	50	4	10	9.32	3.44	3.76	4.05	4.31	4.79
EPDS2003-3	<input type="checkbox"/>	EPDS2003-3-TH	<input type="checkbox"/>	0.3	3	0.45	0.27	50	4	10	8.93	3.99	4.34	4.64	4.92	5.42
EPDS2004-1	<input type="checkbox"/>	EPDS2004-1-TH	<input type="checkbox"/>	0.4	1	0.6	0.37	50	4	10	10.69	1.78	1.99	2.2	2.4	2.78
EPDS2004-1.5	<input type="checkbox"/>	EPDS2004-1.5-TH	<input type="checkbox"/>	0.4	1.5	0.6	0.37	50	4	10	10.17	2.34	2.59	2.83	3.05	3.47
EPDS2004-2	<input type="checkbox"/>	EPDS2004-2-TH	<input type="checkbox"/>	0.4	2	0.6	0.37	50	4	10	9.7	2.89	3.18	3.44	3.69	4.14
EPDS2004-2.5	<input type="checkbox"/>	EPDS2004-2.5-TH	<input type="checkbox"/>	0.4	2.5	0.6	0.37	50	4	10	9.27	3.44	3.76	4.05	4.31	4.79
EPDS2004-3	<input type="checkbox"/>	EPDS2004-3-TH	<input type="checkbox"/>	0.4	3	0.6	0.37	50	4	10	8.87	3.99	4.34	4.64	4.92	5.42
EPDS2004-3.5	<input type="checkbox"/>	EPDS2004-3.5-TH	<input type="checkbox"/>	0.4	3.5	0.6	0.37	50	4	10	8.51	4.54	4.91	5.23	5.52	6.05
EPDS2004-4	<input type="checkbox"/>	EPDS2004-4-TH	<input type="checkbox"/>	0.4	4	0.6	0.37	50	4	10	8.17	5.08	5.48	5.82	6.12	6.67
EPDS2004-5	<input type="checkbox"/>	EPDS2004-5-TH	<input type="checkbox"/>	0.4	5	0.6	0.37	50	4	10	7.58	6.17	6.6	6.97	7.3	7.89
EPDS2004-6	<input type="checkbox"/>	EPDS2004-6-TH	<input type="checkbox"/>	0.4	6	0.6	0.37	50	4	10	7.06	7.24	7.72	8.12	8.47	9.09
EPDS2005-1	<input type="checkbox"/>	EPDS2005-1-TH	<input type="checkbox"/>	0.5	1	0.75	0.47	50	4	10	10.66	1.78	1.99	2.2	2.4	2.78
EPDS2005-1.5	<input type="checkbox"/>	EPDS2005-1.5-TH	<input type="checkbox"/>	0.5	1.5	0.75	0.47	50	4	10	10.13	2.34	2.59	2.83	3.05	3.47
EPDS2005-2	<input type="checkbox"/>	EPDS2005-2-TH	<input type="checkbox"/>	0.5	2	0.75	0.47	50	4	10	9.64	2.89	3.18	3.44	3.69	4.14
EPDS2005-2.5	<input type="checkbox"/>	EPDS2005-2.5-TH	<input type="checkbox"/>	0.5	2.5	0.75	0.47	50	4	10	9.21	3.44	3.76	4.05	4.31	4.79
EPDS2005-3	<input type="checkbox"/>	EPDS2005-3-TH	<input type="checkbox"/>	0.5	3	0.75	0.47	50	4	10	8.81	3.99	4.34	4.64	4.92	5.42
EPDS2005-4	<input type="checkbox"/>	EPDS2005-4-TH	<input type="checkbox"/>	0.5	4	0.75	0.47	50	4	10	8.1	5.08	5.48	5.82	6.12	6.67
EPDS2005-5	<input type="checkbox"/>	EPDS2005-5-TH	<input type="checkbox"/>	0.5	5	0.75	0.47	50	4	10	7.5	6.17	6.6	6.97	7.3	7.89
EPDS2005-6	<input type="checkbox"/>	EPDS2005-6-TH	<input type="checkbox"/>	0.5	6	0.75	0.47	50	4	10	6.98	7.24	7.72	8.12	8.47	9.09
EPDS2005-8	<input type="checkbox"/>	EPDS2005-8-TH	<input type="checkbox"/>	0.5	8	0.75	0.47	50	4	10	6.13	9.38	9.93	10.37	10.76	11.45
EPDS2006-2	<input type="checkbox"/>	EPDS2006-2-TH	<input type="checkbox"/>	0.6	2	0.9	0.57	50	4	10	9.59	2.89	3.18	3.44	3.69	4.14
EPDS2006-4	<input type="checkbox"/>	EPDS2006-4-TH	<input type="checkbox"/>	0.6	4	0.9	0.57	50	4	10	8.02	5.08	5.48	5.82	6.12	6.67
EPDS2006-6	<input type="checkbox"/>	EPDS2006-6-TH	<input type="checkbox"/>	0.6	6	0.9	0.57	50	4	10	6.9	7.24	7.72	8.12	8.47	9.09
EPDS2006-8	<input type="checkbox"/>	EPDS2006-8-TH	<input type="checkbox"/>	0.6	8	0.9	0.57	50	4	10	6.04	9.38	9.93	10.37	10.76	11.45
EPDS2006-10	<input type="checkbox"/>	EPDS2006-10-TH	<input type="checkbox"/>	0.6	10	0.9	0.57	50	4	10	5.38	11.51	12.11	12.6	13.03	13.76
EPDS2007-2	<input type="checkbox"/>	EPDS2007-2-TH	<input type="checkbox"/>	0.7	2	1.05	0.67	50	4	10	9.53	2.89	3.18	3.44	3.69	4.14
EPDS2007-4	<input type="checkbox"/>	EPDS2007-4-TH	<input type="checkbox"/>	0.7	4	1.05	0.67	50	4	10	7.94	5.08	5.48	5.82	6.12	6.67
EPDS2007-6	<input type="checkbox"/>	EPDS2007-6-TH	<input type="checkbox"/>	0.7	6	1.05	0.67	50	4	10	6.81	7.24	7.72	8.12	8.47	9.09
EPDS2007-8	<input type="checkbox"/>	EPDS2007-8-TH	<input type="checkbox"/>	0.7	8	1.05	0.67	50	4	10	5.95	9.38	9.93	10.37	10.76	11.45
EPDS2007-10	<input type="checkbox"/>	EPDS2007-10-TH	<input type="checkbox"/>	0.7	10	1.05	0.67	50	4	10	5.29	11.51	12.11	12.6	13.03	13.76
EPDS2008-4	<input type="checkbox"/>	EPDS2008-4-TH	<input type="checkbox"/>	0.8	4	1.2	0.77	50	4	10	7.86	5.08	5.48	5.82	6.12	6.67
EPDS2008-6	<input type="checkbox"/>	EPDS2008-6-TH	<input type="checkbox"/>	0.8	6	1.2	0.77	50	4	10	6.72	7.24	7.72	8.12	8.47	9.09
EPDS2008-8	<input type="checkbox"/>	EPDS2008-8-TH	<input type="checkbox"/>	0.8	8	1.2	0.77	50	4	10	5.86	9.38	9.93	10.37	10.76	11.45
EPDS2008-10	<input type="checkbox"/>	EPDS2008-10-TH	<input type="checkbox"/>	0.8	10	1.2	0.77	50	4	10	5.2	11.51	12.11	12.6	13.03	13.76
EPDS2008-12	<input type="checkbox"/>	EPDS2008-12-TH	<input type="checkbox"/>	0.8	12	1.2	0.77	55	4	10	4.67	13.63	14.28	14.81	15.26	16.04
EPDS2009-6	<input type="checkbox"/>	EPDS2009-6-TH	<input type="checkbox"/>	0.9	6	1.35	0.86	50	4	10	6.61	7.29	7.75	8.14	8.49	9.11
EPDS2009-8	<input type="checkbox"/>	EPDS2009-8-TH	<input type="checkbox"/>	0.9	8	1.35	0.86	50	4	10	5.76	9.42	9.95	10.4	10.78	11.46
EPDS2009-10	<input type="checkbox"/>	EPDS2009-10-TH	<input type="checkbox"/>	0.9	10	1.35	0.86	50	4	10	5.1	11.55	12.14	12.62	13.04	13.78
EPDS2009-12	<input type="checkbox"/>	EPDS2009-12-TH	<input type="checkbox"/>	0.9	12	1.35	0.86	55	4	10	4.58	13.66	14.3	14.82	15.28	16.06
EPDS2010-2	<input type="checkbox"/>	EPDS2010-2-TH	<input type="checkbox"/>	1	2	1.5	0.96	50	4	10	9.31	2.95	3.23	3.48	3.72	4.17
EPDS2010-4	<input type="checkbox"/>	EPDS2010-4-TH	<input type="checkbox"/>	1	4	1.5	0.96	50	4	10	7.67	5.13	5.52	5.85	6.15	6.69
EPDS2010-6	<input type="checkbox"/>	EPDS2010-6-TH	<input type="checkbox"/>	1	6	1.5	0.96	50	4	10	6.51	7.29	7.75	8.14	8.49	9.11
EPDS2010-8	<input type="checkbox"/>	EPDS2010-8-TH	<input type="checkbox"/>	1	8	1.5	0.96	50	4	10	5.66	9.42	9.95	10.4	10.78	11.46
EPDS2010-10	<input type="checkbox"/>	EPDS2010-10-TH	<input type="checkbox"/>	1	10	1.5	0.96	50	4	10	5	11.55	12.14	12.62	13.04	13.78
EPDS2010-12	<input type="checkbox"/>	EPDS2010-12-TH	<input type="checkbox"/>	1	12	1.5	0.96	55	4	10	4.48	13.66	14.3	14.82	15.28	16.06
EPDS2010-14	<input type="checkbox"/>	EPDS2010-14-TH	<input type="checkbox"/>	1	14	1.5	0.96	55	4	10	4.06	15.76	16.46	17.01	17.49	18.7
EPDS2010-16	<input type="checkbox"/>	EPDS2010-16-TH	<input type="checkbox"/>	1	16	1.5	0.96	60	4	10	3.71	17.86	18.6	19.19	19.69	21.36
EPDS2012-6	<input type="checkbox"/>	EPDS2012-6-TH	<input type="checkbox"/>	1.2	6	1.8	1.15	50	4	10	6.29	7.33	7.78	8.17	8.51	9.13
EPDS2012-8	<input type="checkbox"/>	EPDS2012-8-TH	<input type="checkbox"/>	1.2	8	1.8	1.15	50	4	10	5.44	9.46	9.98	10.42	10.8	11.48
EPDS2012-10	<input type="checkbox"/>	EPDS2012-10-TH	<input type="checkbox"/>	1.2	10	1.8	1.15	50	4	10	4.8	11.58	12.16	12.64	13.06	13.79
EPDS2012-12	<input type="checkbox"/>	EPDS2012-12-TH	<input type="checkbox"/>	1.2	12	1.8	1.15	55	4	10	4.29	13.69	14.33	14.84	15.29	16.08
EPDS2012-16	<input type="checkbox"/>	EPDS2012-16-TH	<input type="checkbox"/>	1.2	16	1.8	1.15	55	4	10	3.53	17.89	18.62	19.2	19.7	21.39

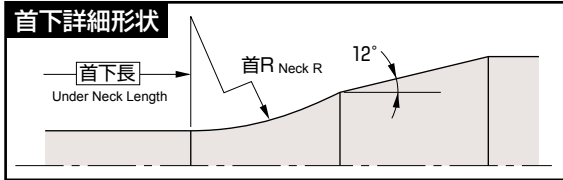

【注意】 加工物に勾配がついている場合、干渉領域は、首下長さよりも長くなります。それぞれの勾配角に対する実有効首下長をご参照ください。また、工具が加工物に干渉する角度を干渉角度 θ_k で表示していますので合わせてご参照ください。

【Note】 If the workpiece has draft angle, the interference length will be longer than the under-neck length. Please refer to the effective under-neck length for the various draft angles. In addition, the angle at which the tool will interfere with the workpiece is shown as the "interference angle θ_k ", and should also be referred to.

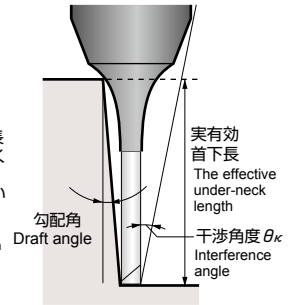

EPDS2○○○○-○○○(-TH)

CSコーティング CS Coating		THコーティング TH Coating		寸法 Size(mm)							干渉角度 Interference angle θ_k	勾配角に対する実有効首下長 The effective under-neck length for the various draft angles					
商品コード Item code	在庫 Stock	商品コード Item code	在庫 Stock	外径 Tool dia. DC	首下長 Under neck length LU	刃長 Flute length APMX	首径 Neck dia. DN	全長 Overall length LF	シャンク径 Shank dia. DCONMS	首R Neck R		0.5°	1°	1.5°	2°	3°	
EPDS2014-6	<input type="checkbox"/>	EPDS2014-6-TH	<input type="checkbox"/>	1.4	6	2.1	1.34	50	4	10	6.06	7.37	7.81	8.19	8.54	9.15	
EPDS2014-8	<input type="checkbox"/>	EPDS2014-8-TH	<input type="checkbox"/>		8	2.1	1.34	50	4	10	5.21	9.49	10.01	10.44	10.82	11.5	
EPDS2014-10	<input type="checkbox"/>	EPDS2014-10-TH	<input type="checkbox"/>		10	2.1	1.34	50	4	10	4.58	11.61	12.19	12.66	13.08	13.8	
EPDS2014-12	<input type="checkbox"/>	EPDS2014-12-TH	<input type="checkbox"/>		12	2.1	1.34	55	4	10	4.08	13.72	14.35	14.86	15.31	16.11	
EPDS2014-14	<input type="checkbox"/>	EPDS2014-14-TH	<input type="checkbox"/>		14	2.1	1.34	55	4	10	3.68	15.82	16.5	17.05	17.52	18.76	
EPDS2014-16	<input type="checkbox"/>	EPDS2014-16-TH	<input type="checkbox"/>		16	2.1	1.34	55	4	10	3.35	17.92	18.64	19.22	19.72	21.42	
EPDS2015-4	<input type="checkbox"/>	EPDS2015-4-TH	<input type="checkbox"/>	1.5	4	2.25	1.44	50	4	10	7.11	5.22	5.59	5.91	6.2	6.74	
EPDS2015-6	<input type="checkbox"/>	EPDS2015-6-TH	<input type="checkbox"/>		6	2.25	1.44	50	4	10	5.94	7.37	7.81	8.19	8.54	9.15	
EPDS2015-8	<input type="checkbox"/>	EPDS2015-8-TH	<input type="checkbox"/>		8	2.25	1.44	50	4	10	5.1	9.49	10.01	10.44	10.82	11.5	
EPDS2015-10	<input type="checkbox"/>	EPDS2015-10-TH	<input type="checkbox"/>		10	2.25	1.44	50	4	10	4.47	11.61	12.19	12.66	13.08	13.8	
EPDS2015-12	<input type="checkbox"/>	EPDS2015-12-TH	<input type="checkbox"/>		12	2.25	1.44	55	4	10	3.97	13.72	14.35	14.86	15.31	16.11	
EPDS2015-14	<input type="checkbox"/>	EPDS2015-14-TH	<input type="checkbox"/>		14	2.25	1.44	55	4	10	3.58	15.82	16.5	17.05	17.52	18.76	
EPDS2015-16	<input type="checkbox"/>	EPDS2015-16-TH	<input type="checkbox"/>	1.6	16	2.25	1.44	55	4	10	3.25	17.92	18.64	19.22	19.72	21.42	
EPDS2015-18	<input type="checkbox"/>	EPDS2015-18-TH	<input type="checkbox"/>		18	2.25	1.44	60	4	10	2.98	20.01	20.77	21.38	21.9	干渉なし	
EPDS2015-20	<input type="checkbox"/>	EPDS2015-20-TH	<input type="checkbox"/>		20	2.25	1.44	60	4	10	2.76	22.09	22.9	23.53	24.1	干渉なし	
EPDS2015-25	<input type="checkbox"/>	EPDS2015-25-TH	<input type="checkbox"/>		25	2.25	1.44	65	4	10	2.31	27.3	28.18	28.88	30.08	干渉なし	
EPDS2016-6	<input type="checkbox"/>	EPDS2016-6-TH	<input type="checkbox"/>		1.8	6	2.4	1.54	50	4	10	5.82	7.37	7.81	8.19	8.54	9.15
EPDS2016-8	<input type="checkbox"/>	EPDS2016-8-TH	<input type="checkbox"/>			8	2.4	1.54	50	4	10	4.98	9.49	10.01	10.44	10.82	11.5
EPDS2016-10	<input type="checkbox"/>	EPDS2016-10-TH	<input type="checkbox"/>	10		2.4	1.54	50	4	10	4.35	11.61	12.19	12.66	13.08	13.8	
EPDS2016-12	<input type="checkbox"/>	EPDS2016-12-TH	<input type="checkbox"/>	12		2.4	1.54	55	4	10	3.86	13.72	14.35	14.86	15.31	16.11	
EPDS2016-14	<input type="checkbox"/>	EPDS2016-14-TH	<input type="checkbox"/>	14		2.4	1.54	55	4	10	3.48	15.82	16.5	17.05	17.52	18.76	
EPDS2016-16	<input type="checkbox"/>	EPDS2016-16-TH	<input type="checkbox"/>	16		2.4	1.54	55	4	10	3.16	17.92	18.64	19.22	19.72	21.42	
EPDS2016-18	<input type="checkbox"/>	EPDS2016-18-TH	<input type="checkbox"/>	2	18	2.4	1.54	60	4	10	2.89	20.01	20.77	21.38	21.9	干渉なし	
EPDS2016-20	<input type="checkbox"/>	EPDS2016-20-TH	<input type="checkbox"/>		20	2.4	1.54	60	4	10	2.67	22.09	22.9	23.53	24.1	干渉なし	
EPDS2018-6	<input type="checkbox"/>	EPDS2018-6-TH	<input type="checkbox"/>		2.5	6	2.7	1.73	50	4	10	5.55	7.4	7.84	8.22	8.56	9.16
EPDS2018-8	<input type="checkbox"/>	EPDS2018-8-TH	<input type="checkbox"/>			8	2.7	1.73	50	4	10	4.72	9.53	10.04	10.46	10.84	11.51
EPDS2018-10	<input type="checkbox"/>	EPDS2018-10-TH	<input type="checkbox"/>			10	2.7	1.73	50	4	10	4.11	11.64	12.21	12.68	13.09	13.82
EPDS2018-12	<input type="checkbox"/>	EPDS2018-12-TH	<input type="checkbox"/>			12	2.7	1.73	55	4	10	3.63	13.75	14.37	14.88	15.32	16.14
EPDS2018-14	<input type="checkbox"/>	EPDS2018-14-TH	<input type="checkbox"/>	14		2.7	1.73	55	4	10	3.26	15.85	16.52	17.06	17.54	18.8	
EPDS2018-16	<input type="checkbox"/>	EPDS2018-16-TH	<input type="checkbox"/>	16		2.7	1.73	55	4	10	2.96	17.94	18.66	19.23	19.73	干渉なし	
EPDS2018-18	<input type="checkbox"/>	EPDS2018-18-TH	<input type="checkbox"/>	3	18	2.7	1.73	60	4	10	2.7	20.03	20.79	21.39	21.92	干渉なし	
EPDS2018-20	<input type="checkbox"/>	EPDS2018-20-TH	<input type="checkbox"/>		20	2.7	1.73	60	4	10	2.49	22.12	22.91	23.55	24.12	干渉なし	
EPDS2020-4	<input type="checkbox"/>	EPDS2020-4-TH	<input type="checkbox"/>		4	4	3	1.92	50	4	10	6.42	5.31	5.66	5.97	6.25	6.78
EPDS2020-6	<input type="checkbox"/>	EPDS2020-6-TH	<input type="checkbox"/>			6	3	1.92	50	4	10	5.25	7.44	7.87	8.24	8.58	9.18
EPDS2020-8	<input type="checkbox"/>	EPDS2020-8-TH	<input type="checkbox"/>			8	3	1.92	50	4	10	4.44	9.56	10.06	10.48	10.86	11.53
EPDS2020-10	<input type="checkbox"/>	EPDS2020-10-TH	<input type="checkbox"/>			10	3	1.92	50	4	10	3.85	11.67	12.23	12.7	13.11	13.83
EPDS2020-12	<input type="checkbox"/>	EPDS2020-12-TH	<input type="checkbox"/>	12		3	1.92	55	4	10	3.39	13.78	14.39	14.9	15.34	16.17	
EPDS2020-14	<input type="checkbox"/>	EPDS2020-14-TH	<input type="checkbox"/>	14		3	1.92	55	4	10	3.03	15.88	16.54	17.08	17.55	18.83	
EPDS2020-16	<input type="checkbox"/>	EPDS2020-16-TH	<input type="checkbox"/>	3	16	3	1.92	55	4	10	2.75	17.97	18.68	19.25	19.75	干渉なし	
EPDS2020-18	<input type="checkbox"/>	EPDS2020-18-TH	<input type="checkbox"/>		18	3	1.92	60	4	10	2.51	20.06	20.81	21.41	21.93	干渉なし	
EPDS2020-20	<input type="checkbox"/>	EPDS2020-20-TH	<input type="checkbox"/>		20	3	1.92	60	4	10	2.31	22.14	22.93	23.56	24.15	干渉なし	
EPDS2020-25	<input type="checkbox"/>	EPDS2020-25-TH	<input type="checkbox"/>		25	3	1.92	65	4	10	1.92	27.34	28.22	28.91	干渉なし	干渉なし	
EPDS2020-30	<input type="checkbox"/>	EPDS2020-30-TH	<input type="checkbox"/>		30	3	1.92	70	4	10	1.65	32.52	33.47	34.43	干渉なし	干渉なし	
EPDS2025-8	<input type="checkbox"/>	EPDS2025-8-TH	<input type="checkbox"/>		4	8	3.75	2.4	50	4	10	3.61	9.63	10.11	10.53	10.9	11.56
EPDS2025-12	<input type="checkbox"/>	EPDS2025-12-TH	<input type="checkbox"/>	12		3.75	2.4	55	4	10	2.7	13.84	14.43	14.93	15.37	干渉なし	
EPDS2025-16	<input type="checkbox"/>	EPDS2025-16-TH	<input type="checkbox"/>	16		3.75	2.4	55	4	10	2.16	18.02	18.71	19.28	19.77	干渉なし	
EPDS2025-20	<input type="checkbox"/>	EPDS2025-20-TH	<input type="checkbox"/>	20		3.75	2.4	60	4	10	1.8	22.19	22.96	23.59	干渉なし	干渉なし	
EPDS2030-8	<input type="checkbox"/>	EPDS2030-8-TH	<input type="checkbox"/>	3		8	4.5	2.88	55	6	10	5.59	9.69	10.16	10.57	10.94	11.59
EPDS2030-12	<input type="checkbox"/>	EPDS2030-12-TH	<input type="checkbox"/>			12	4.5	2.88	60	6	10	4.44	13.89	14.48	14.97	15.4	16.3
EPDS2030-16	<input type="checkbox"/>	EPDS2030-16-TH	<input type="checkbox"/>		16	4.5	2.88	60	6	10	3.68	18.07	18.75	19.31	19.8	21.61	
EPDS2030-20	<input type="checkbox"/>	EPDS2030-20-TH	<input type="checkbox"/>		20	4.5	2.88	65	6	10	3.15	22.24	23	23.62	24.26	26.92	
EPDS2030-25	<input type="checkbox"/>	EPDS2030-25-TH	<input type="checkbox"/>		25	4.5	2.88	70	6	10	2.66	27.42	28.28	28.96	30.25	干渉なし	
EPDS2030-30	<input type="checkbox"/>	EPDS2030-30-TH	<input type="checkbox"/>		30	4.5	2.88	75	6	10	2.31	32.6	33.53	34.53	36.23	干渉なし	
EPDS2030-40	<input type="checkbox"/>	EPDS2030-40-TH	<input type="checkbox"/>	4	40	4.5	2.88	90	6	10	1.82	42.91	43.98	45.94	干渉なし	干渉なし	
EPDS2040-12	<input type="checkbox"/>	EPDS2040-12-TH	<input type="checkbox"/>		12	6	3.85	60	6	10	3.36	13.97	14.54	15.02	15.45	16.39	
EPDS2040-16	<input type="checkbox"/>	EPDS2040-16-TH	<input type="checkbox"/>		16	6	3.85	60	6	10	2.72	18.14	18.81	19.36	19.84	干渉なし	
EPDS2040-20	<input type="checkbox"/>	EPDS2040-20-TH	<input type="checkbox"/>		20	6	3.85	70	6	10	2.29	22.3	23.05	23.66	24.35	干渉なし	
EPDS2040-25	<input type="checkbox"/>	EPDS2040-25-TH	<input type="checkbox"/>		25	6	3.85	70	6	10	1.91	27.49	28.32	28.99	干渉なし	干渉なし	
EPDS2040-30	<input type="checkbox"/>	EPDS2040-30-TH	<input type="checkbox"/>		30	6	3.85	80	6	10	1.64	32.65	33.57	34.61	干渉なし	干渉なし	
EPDS2040-35	<input type="checkbox"/>	EPDS2040-35-TH	<input type="checkbox"/>	4	35	6	3.85	80	6	10	1.44	37.81	38.8	干渉なし	干渉なし	干渉なし	
EPDS2040-40	<input type="checkbox"/>	EPDS2040-40-TH	<input type="checkbox"/>		40	6	3.85	90	6	10	1.28	42.96	44.01	干渉なし	干渉なし	干渉なし	

THコーティング品を注文される場合は商品コードの末尾に-THをつけてください。
When you want to order TH Coating items from us, please add the suffix -TH at the end of the item code.

干渉なし : No interference

印: 特定代理店在庫です。弊社営業へお問合せください。
 : Stocked by specified distributor. Contact with our sales department.

対応被削材 Applicable work material

コーティング Coating	炭素鋼 合金鋼 Alloy steel	プリハー ド鋼 Pre-hardened steel ≤ 45HRC	高硬度 Hardened steel > 45HRC ≤ 55HRC	> 55HRC ≤ 65HRC	> 65HRC	ステン レス鋼 Stainless steel	チタン合金 耐熱合金 Titanium alloy Heat-resistant alloy	銅合金 Copper alloy	アルミ 合金 Aluminum alloy
CS	<input type="checkbox"/>	<input type="checkbox"/>	<input type="checkbox"/>	<input type="checkbox"/>	<input type="checkbox"/>	<input type="checkbox"/>	<input type="checkbox"/>	<input type="checkbox"/>	<input type="checkbox"/>
TH	<input type="checkbox"/>	<input type="checkbox"/>	<input type="checkbox"/>	<input type="checkbox"/>	<input type="checkbox"/>	<input type="checkbox"/>	<input type="checkbox"/>	<input type="checkbox"/>	<input type="checkbox"/>

Epoch Deep Square エポックディープスクエア

標準切削条件表 Recommended cutting conditions **EPDS** **EPDS-TH**

*CSシリーズは被削材グループ1~4を推奨、 THシリーズは被削材グループ4~6を推奨 For details about the CS series, refer to work groups 1 - 4. For details about the TH series, refer to work groups 4 - 6.

推奨領域 Recommended range		CSシリーズ								THシリーズ					
被削材 Work material		1		2		3		4		5		6			
		銅 Coppers		炭素鋼・合金鋼 Carbon steels, Alloy steels (180~250HB)		ステンレス鋼・工具鋼 Stainless steels, Tool steels (25~35HRC)		プリハードン鋼 Pre-hardened steels (35~45HRC)		焼入れ鋼 Hardened steels (45~55HRC)		焼入れ鋼 Hardened steels (55~65HRC)			
切り込み比率 Ratio to standard depth of cut		120%		100%		90%		70%		50%		45%			
外径DC Tool dia. (mm)	首下長LU Under neck length (mm)	*基本切り込み Standard depth of cut (mm)	回転数		送り速度		回転数		送り速度		回転数		送り速度		
			n min ⁻¹	V_f mm/min	n min ⁻¹	V_f mm/min	n min ⁻¹	V_f mm/min	n min ⁻¹	V_f mm/min	n min ⁻¹	V_f mm/min	n min ⁻¹	V_f mm/min	
0.1	0.3	0.006	50,000	500	50,000	500	50,000	475	48,600	346	42,750	255	40,050	206	
	0.5	0.004	50,000	500	50,000	500	50,000	475	48,600	346	42,750	255	40,050	206	
	1	0.003	50,000	455	50,000	455	48,600	430	43,700	315	38,500	232	36,050	187	
0.2	0.5	0.02	50,000	708	45,000	638	40,500	574	38,250	403	33,750	301	31,500	242	
	1	0.014	50,000	708	45,000	638	40,500	574	38,250	403	33,750	301	31,500	242	
	1.5	0.008	48,600	630	40,500	525	36,450	472	34,425	362	30,375	271	28,350	218	
0.3	1	0.021	48,000	680	40,000	567	36,000	510	34,000	358	30,000	267	28,000	215	
	1.5	0.021	48,000	680	40,000	567	36,000	510	34,000	358	30,000	267	28,000	215	
	2	0.012	43,200	560	36,000	467	32,400	420	30,600	322	27,000	241	25,200	194	
	2.5	0.01	43,200	560	36,000	467	32,400	420	30,600	322	27,000	241	25,200	194	
0.4	3	0.008	43,200	560	36,000	467	32,400	420	30,600	322	27,000	241	25,200	194	
	1	0.04	38,400	847	32,000	706	28,800	635	27,200	446	24,000	333	22,400	268	
	1.5	0.028	38,400	847	32,000	706	28,800	635	27,200	446	24,000	333	22,400	268	
	2	0.028	38,400	847	32,000	706	28,800	635	27,200	446	24,000	333	22,400	268	
	2.5	0.022	34,560	697	28,800	581	25,920	523	24,480	401	21,600	299	20,160	241	
	3	0.016	34,560	697	28,800	581	25,920	523	24,480	401	21,600	299	20,160	241	
	3.5	0.012	34,560	697	28,800	581	25,920	523	24,480	401	21,600	299	20,160	241	
	4	0.01	34,560	697	28,800	581	25,920	523	24,480	401	21,600	299	20,160	241	
0.5	5	0.01	30,720	542	25,600	452	23,040	406	21,760	260	19,200	230	17,920	181	
	6	0.006	30,720	542	25,600	452	23,040	406	21,760	260	19,200	230	17,920	181	
	1	0.05	38,400	847	32,000	706	28,800	635	27,200	446	24,000	333	22,400	268	
	1.5	0.05	38,400	847	32,000	706	28,800	635	27,200	446	24,000	333	22,400	268	
	2	0.035	38,400	847	32,000	706	28,800	635	27,200	446	24,000	333	22,400	268	
	2.5	0.03	34,560	697	28,800	581	25,920	523	24,480	401	21,600	299	20,160	241	
	3	0.02	34,560	697	28,800	581	25,920	523	24,480	401	21,600	299	20,160	241	
	4	0.02	34,560	697	28,800	581	25,920	523	24,480	401	21,600	299	20,160	241	
0.6	5	0.013	34,560	697	28,800	581	25,920	523	24,480	401	21,600	299	20,160	241	
	6	0.013	30,720	542	25,600	452	23,040	406	21,760	260	19,200	230	17,920	181	
	8	0.008	30,720	464	25,600	387	23,040	348	21,760	247	19,200	194	17,920	147	
	2	0.042	38,400	1,210	32,000	1,008	28,800	907	27,200	636	24,000	475	22,400	383	
	4	0.024	34,560	995	28,800	829	25,920	746	24,480	573	21,600	428	20,160	345	
	6	0.015	34,560	995	28,800	829	25,920	746	24,480	573	21,600	428	20,160	345	
0.7	8	0.015	30,720	774	25,600	645	23,040	581	21,760	372	19,200	328	17,920	258	
	10	0.009	30,720	774	25,600	645	23,040	581	21,760	372	19,200	328	17,920	258	
	2	0.07	38,400	1,210	32,000	1,008	28,800	907	27,200	636	24,000	475	22,400	383	
	4	0.049	34,560	995	28,800	829	25,920	746	24,480	573	21,600	428	20,160	345	
	6	0.018	34,560	995	28,800	829	25,920	746	24,480	573	21,600	428	20,160	345	
0.8	8	0.018	30,720	774	25,600	645	23,040	581	21,760	372	19,200	328	17,920	258	
	10	0.018	30,720	774	25,600	645	23,040	581	21,760	372	19,200	328	17,920	258	
	4	0.056	38,400	1,210	32,000	1,008	28,800	907	27,200	636	24,000	475	22,400	383	
	6	0.032	34,560	995	28,800	829	25,920	746	24,480	573	21,600	428	20,160	345	
	8	0.02	34,560	995	28,800	829	25,920	746	24,480	573	21,600	428	20,160	345	
0.9	10	0.02	30,720	774	25,600	645	23,040	581	21,760	372	19,200	328	17,920	258	
	12	0.012	30,720	774	25,600	645	23,040	581	21,760	372	19,200	328	17,920	258	
	6	0.036	34,560	995	28,800	829	25,920	746	24,480	573	21,600	428	20,160	345	
	8	0.023	34,560	995	28,800	829	25,920	746	24,480	573	21,600	428	20,160	345	
	10	0.023	30,720	774	25,600	645	23,040	581	21,760	372	19,200	328	17,920	258	
1	12	0.023	30,720	774	25,600	645	23,040	581	21,760	372	19,200	328	17,920	258	
	2	0.1	34,560	1,628	28,800	1,356	25,920	1,220	24,480	936	21,600	699	20,160	563	
	4	0.07	34,560	1,628	28,800	1,356	25,920	1,220	24,480	936	21,600	699	20,160	563	
	6	0.04	31,104	1,344	25,920	1,120	23,328	1,008	22,032	773	19,440	577	18,144	465	
	8	0.04	31,104	1,344	25,920	1,120	23,328	1,008	22,032	773	19,440	577	18,144	465	
	10	0.025	31,104	1,344	25,920	1,120	23,328	1,008	22,032	773	19,440	577	18,144	465	
	12	0.025	27,648	1,045	23,040	871	20,736	784	19,584	502	17,280	443	16,128	348	
1.2	14	0.025	27,648	1,045	23,040	871	20,736	784	19,584	502	17,280	443	16,128	348	
	16	0.015	27,648	896	23,040	746	20,736	672	19,584	476	17,280	373	16,128	283	
	6	0.084	30,720	1,452	25,600	1,210	23,040	1,089	21,760	764	19,200	570	17,920	460	
	8	0.048	27,648	1,194	23,040	995	20,736	896	19,584	687	17,280	513	16,128	414	
	10	0.03	27,648	1,194	23,040	995	20,736	896	19,584	687	17,280	513	16,128	414	
1.4	12	0.03	27,648	1,194	23,040	995	20,736	896	19,584	687	17,280	513	16,128	414	
	16	0.02	24,576	1,061	20,480	884	18,432	796	17,408	611	15,360	456	14,336	368	
	6	0.1	26,880	1,270	22,400	1,058	20,160	953	19,040	668	16,800	499	15,680	402	
	8	0.084	24,192	1,045	20,160	871	18,144	784	17,136	601	15,120	449	14,112	362	
	10	0.056	24,192	1,045	20,160	871	18,144	784	17,136	601	15,120	449	14,112	362	
1.4	12	0.035	24,192	1,045	20,160	871	18,144	784	17,136	601	15,120	449	14,112	362	
	14	0.035	24,192	1,045	20,160	871	18,144	784	17,136	601	15,120	449	14,112	362	
	16	0.035	21,504	813	17,920	677	16,128	610	15,232	391	13,440	345	12,544	271	

超硬工具株式会社 特定代理店在庫品

※CSシリーズは被削材グループ1~4を推奨、THシリーズは被削材グループ4~6を推奨 For details about the CS series, refer to work groups 1 - 4. For details about the TH series, refer to work groups 4 - 6.

推奨領域 Recommended range			CSシリーズ												THシリーズ			
被削材 Work material			1		2		3		4		5		6					
			銅 Coppers		炭素鋼・合金鋼 Carbon steels, Alloy steels (180~250HB)		ステンレス鋼・工具鋼 Stainless steels, Tool steels (25~35HRC)		プリハードン鋼 Pre-hardened steels (35~45HRC)		焼入れ鋼 Hardened steels (45~55HRC)		焼入れ鋼 Hardened steels (55~65HRC)					
切り込み比率 Ratio to standard depth of cut			120%		100%		90%		70%		50%		45%					
外径DC Tool dia. (mm)	首下長LU Under neck length (mm)	※ 基本切り込み Standard depth of cut (mm)	回転数		送り速度		回転数		送り速度		回転数		送り速度					
			n min ⁻¹	V_f mm/min	n min ⁻¹	V_f mm/min	n min ⁻¹	V_f mm/min	n min ⁻¹	V_f mm/min	n min ⁻¹	V_f mm/min	n min ⁻¹	V_f mm/min				
1.5	4	0.11	26,880	1,270	22,400	1,058	20,160	953	19,040	668	16,800	499	15,680	402				
	6	0.11	26,880	1,270	22,400	1,058	20,160	953	19,040	668	16,800	499	15,680	402				
	8	0.06	24,192	1,045	20,160	871	18,144	784	17,136	601	15,120	449	14,112	362				
	10	0.06	24,192	1,045	20,160	871	18,144	784	17,136	601	15,120	449	14,112	362				
	12	0.06	24,192	1,045	20,160	871	18,144	784	17,136	601	15,120	449	14,112	362				
	14	0.038	24,192	1,045	20,160	871	18,144	784	17,136	601	15,120	449	14,112	362				
	16	0.038	21,504	813	17,920	677	16,128	610	15,232	391	13,440	345	12,544	271				
	18	0.038	21,504	813	17,920	677	16,128	610	15,232	391	13,440	345	12,544	271				
1.6	6	0.11	24,960	1,310	20,800	1,092	18,720	983	17,680	690	15,600	515	14,560	415				
	8	0.11	24,960	1,310	20,800	1,092	18,720	983	17,680	690	15,600	515	14,560	415				
	10	0.064	22,464	1,078	18,720	899	16,848	809	15,912	621	14,040	463	13,104	373				
	12	0.064	22,464	1,078	18,720	899	16,848	809	15,912	621	14,040	463	13,104	373				
	14	0.04	22,464	1,078	18,720	899	16,848	809	15,912	621	14,040	463	13,104	373				
	16	0.04	22,464	1,078	18,720	899	16,848	809	15,912	621	14,040	463	13,104	373				
1.8	6	0.13	24,960	1,310	20,800	1,092	18,720	983	17,680	690	15,600	515	14,560	415				
	8	0.13	24,960	1,310	20,800	1,092	18,720	983	17,680	690	15,600	515	14,560	415				
	10	0.072	22,464	1,078	18,720	899	16,848	809	15,912	621	14,040	463	13,104	373				
	12	0.072	22,464	1,078	18,720	899	16,848	809	15,912	621	14,040	463	13,104	373				
	14	0.045	22,464	1,078	18,720	899	16,848	809	15,912	621	14,040	463	13,104	373				
	16	0.045	19,968	839	16,640	699	14,976	629	14,144	403	12,480	356	11,648	280				
2	4	0.2	20,160	1,270	16,800	1,058	15,120	953	14,280	668	12,600	499	11,760	402				
	6	0.2	20,160	1,270	16,800	1,058	15,120	953	14,280	668	12,600	499	11,760	402				
	8	0.14	20,160	1,270	16,800	1,058	15,120	953	14,280	668	12,600	499	11,760	402				
	10	0.14	20,160	1,270	16,800	1,058	15,120	953	14,280	668	12,600	499	11,760	402				
	12	0.08	18,144	1,045	15,120	871	13,608	784	12,852	601	11,340	449	10,584	362				
	14	0.08	18,144	1,045	15,120	871	13,608	784	12,852	601	11,340	449	10,584	362				
	16	0.08	18,144	1,045	15,120	871	13,608	784	12,852	601	11,340	449	10,584	362				
	18	0.05	18,144	1,045	15,120	871	13,608	784	12,852	601	11,340	449	10,584	362				
	20	0.05	18,144	1,045	15,120	871	13,608	784	12,852	601	11,340	449	10,584	362				
	25	0.05	16,128	813	13,440	677	12,096	610	11,424	391	10,080	345	9,408	271				
2.5	8	0.18	17,280	1,361	14,400	1,134	12,960	1,021	12,240	716	10,800	535	10,080	431				
	12	0.18	17,280	1,361	14,400	1,134	12,960	1,021	12,240	716	10,800	535	10,080	431				
	16	0.1	15,552	1,120	12,960	933	11,664	840	11,016	644	9,720	481	9,072	388				
	20	0.1	15,552	1,120	12,960	933	11,664	840	11,016	644	9,720	481	9,072	388				
3	8	0.3	15,360	1,210	12,800	1,008	11,520	907	10,880	636	9,600	475	8,960	383				
	12	0.21	15,360	1,210	12,800	1,008	11,520	907	10,880	636	9,600	475	8,960	383				
	16	0.12	13,824	995	11,520	829	10,368	746	9,792	573	8,640	428	8,064	345				
	20	0.12	13,824	995	11,520	829	10,368	746	9,792	573	8,640	428	8,064	345				
	25	0.08	13,824	995	11,520	829	10,368	746	9,792	573	8,640	428	8,064	345				
	30	0.08	13,824	995	11,520	829	10,368	746	9,792	573	8,640	428	8,064	345				
4	12	0.4	11,500	2,300	9,400	1,880	8,460	1,523	7,990	1,358	7,050	902	6,580	727				
	16	0.28	11,500	2,300	9,400	1,880	8,460	1,523	7,990	1,358	7,050	902	6,580	727				
	20	0.28	10,350	2,070	8,460	1,692	7,614	1,371	7,191	1,222	6,345	812	5,922	654				
	25	0.16	10,350	1,863	8,460	1,523	7,614	1,233	7,191	1,100	6,345	812	5,922	654				
	30	0.16	10,350	1,863	8,460	1,523	7,614	1,233	7,191	1,100	6,345	812	5,922	654				
	35	0.1	9,137	1,645	7,614	1,371	6,853	1,110	6,472	990	5,711	731	5,330	589				
40	0.1	9,137	1,645	7,614	1,371	6,853	1,110	6,472	990	5,711	731	5,330	589					

※基本切込みは被削材グループ2での目安を示しています。その他のグループの場合は、上表の切り込み比率を目安に調整して下さい。
 ※Standard cutting depth is shown as the criteria for Group 2 workpieces. For other groups, adjust the cutting depth according to the cutting depth factors in the above table.

- 【注意】**
- ①被削材、加工形状に合わせて、適切なクーラントを使用してください。
 - ②この標準切削条件表は切削条件の目安を示すものです。実際の加工では加工形状、目的、使用機械等により条件を調整してください。
 - ③機械の回転数が足りない場合は、回転数と送り速度を同じ比率で下げてください。

- 【Note】**
- 1. Use the appropriate coolant for the work material and machining shape.
 - 2. These Recommended Cutting Conditions indicate only the rule of a thumb for the cutting conditions. In actual machining, the condition should be adjusted according to the machining shape, purpose and the machine type.
 - 3. If the rpm of the machine is low, lower the feed rate also to put the rpm and feed rate in the same ratio.

Carbide End Mills

超硬ソリッドエンドミル

ピンカド®・ショート刃長 Pinkado, Short

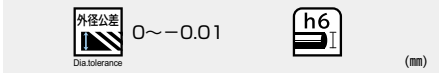

ピンカド®・レギュラー刃長 Pinkado, Regular

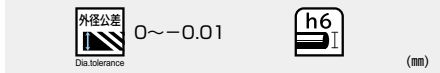

ピンカド®・レギュラー刃長 Pinkado, Regular

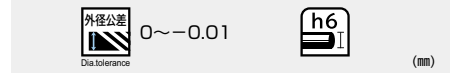

PESS2-C

商品コード Item code	在庫 Stock	寸法 Size (mm)			
		外径 Tool dia.	刃長 Flute length	全長 Overall length	シャンク径 Shank dia.
PESS2010-C	<input type="checkbox"/>	1	2	40	4
PESS2015-C	<input type="checkbox"/>	1.5	3	40	4
PESS2020-C	<input type="checkbox"/>	2	4	40	4
PESS2025-C	<input type="checkbox"/>	2.5	5	40	4
PESS2030-C	<input type="checkbox"/>	3	7	45	6
PESS2035-C	<input type="checkbox"/>	3.5	8	45	6
PESS2040-C	<input type="checkbox"/>	4	8	45	6
PESS2045-C	<input type="checkbox"/>	4.5	10	45	6
PESS2050-C	<input type="checkbox"/>	5	10	50	6
PESS2055-C	<input type="checkbox"/>	5.5	12	50	6
PESS2060-C	<input type="checkbox"/>	6	12	50	6
PESS2065-C	<input type="checkbox"/>	6.5	14	50	6
PESS2070-C	<input type="checkbox"/>	7	14	60	8
PESS2075-C	<input type="checkbox"/>	7.5	14	60	8
PESS2080-C	<input type="checkbox"/>	8	16	60	8
PESS2085-C	<input type="checkbox"/>	8.5	16	60	8
PESS2090-C	<input type="checkbox"/>	9	18	65	10
PESS2095-C	<input type="checkbox"/>	9.5	18	65	10
PESS2100-C	<input type="checkbox"/>	10	18	70	10
PESS2110-C	<input type="checkbox"/>	11	22	75	12
PESS2120-C	<input type="checkbox"/>	12	22	75	12
PESS2130-C	<input type="checkbox"/>	13	22	75	12
PESS2140-C	<input type="checkbox"/>	14	27	90	16
PESS2150-C	<input type="checkbox"/>	15	27	90	16
PESS2160-C	<input type="checkbox"/>	16	27	90	16
PESS2180-C	<input type="checkbox"/>	18	30	105	20
PESS2200-C	<input type="checkbox"/>	20	35	105	20

PESR2-C

商品コード Item code	在庫 Stock	寸法 Size (mm)			
		外径 Tool dia.	刃長 Flute length	全長 Overall length	シャンク径 Shank dia.
PESR2010-C	<input type="checkbox"/>	1	2.5	40	4
PESR2015-C	<input type="checkbox"/>	1.5	4	40	4
PESR2020-C	<input type="checkbox"/>	2	6	40	4
PESR2025-C	<input type="checkbox"/>	2.5	8	40	4
PESR2030-C	<input type="checkbox"/>	3	10	45	6
PESR2035-C	<input type="checkbox"/>	3.5	11	45	6
PESR2040-C	<input type="checkbox"/>	4	12	45	6
PESR2045-C	<input type="checkbox"/>	4.5	14	45	6
PESR2050-C	<input type="checkbox"/>	5	15	50	6
PESR2055-C	<input type="checkbox"/>	5.5	15	50	6
PESR2060-C	<input type="checkbox"/>	6	15	50	6
PESR2065-C	<input type="checkbox"/>	6.5	15	50	6
PESR2070-C	<input type="checkbox"/>	7	20	60	8
PESR2075-C	<input type="checkbox"/>	7.5	20	60	8
PESR2080-C	<input type="checkbox"/>	8	20	60	8
PESR2085-C	<input type="checkbox"/>	8.5	20	60	8
PESR2090-C	<input type="checkbox"/>	9	20	65	10
PESR2095-C	<input type="checkbox"/>	9.5	20	65	10
PESR2100-C	<input type="checkbox"/>	10	25	70	10
PESR2110-C	<input type="checkbox"/>	11	25	75	12
PESR2120-C	<input type="checkbox"/>	12	25	75	12
PESR2130-C	<input type="checkbox"/>	13	25	75	12
PESR2140-C	<input type="checkbox"/>	14	35	90	16
PESR2150-C	<input type="checkbox"/>	15	35	90	16
PESR2160-C	<input type="checkbox"/>	16	35	90	16
PESR2180-C	<input type="checkbox"/>	18	40	105	20
PESR2200-C	<input type="checkbox"/>	20	40	105	20

PESR4-C

商品コード Item code	在庫 Stock	寸法 Size (mm)			
		外径 Tool dia.	刃長 Flute length	全長 Overall length	シャンク径 Shank dia.
PESR4020-C	<input type="checkbox"/>	2	6	40	4
PESR4025-C	<input type="checkbox"/>	2.5	8	40	4
PESR4030-C	<input type="checkbox"/>	3	10	45	6
PESR4035-C	<input type="checkbox"/>	3.5	11	45	6
PESR4040-C	<input type="checkbox"/>	4	12	45	6
PESR4045-C	<input type="checkbox"/>	4.5	14	45	6
PESR4050-C	<input type="checkbox"/>	5	15	50	6
PESR4055-C	<input type="checkbox"/>	5.5	15	50	6
PESR4060-C	<input type="checkbox"/>	6	15	50	6
PESR4065-C	<input type="checkbox"/>	6.5	15	50	6
PESR4070-C	<input type="checkbox"/>	7	20	60	8
PESR4075-C	<input type="checkbox"/>	7.5	20	60	8
PESR4080-C	<input type="checkbox"/>	8	20	60	8
PESR4085-C	<input type="checkbox"/>	8.5	20	60	8
PESR4090-C	<input type="checkbox"/>	9	20	65	10
PESR4095-C	<input type="checkbox"/>	9.5	20	65	10
PESR4100-C	<input type="checkbox"/>	10	25	70	10
PESR4110-C	<input type="checkbox"/>	11	25	75	12
PESR4120-C	<input type="checkbox"/>	12	25	75	12
PESR4130-C	<input type="checkbox"/>	13	25	75	12
PESR4140-C	<input type="checkbox"/>	14	35	90	16
PESR4150-C	<input type="checkbox"/>	15	35	90	16
PESR4160-C	<input type="checkbox"/>	16	35	90	16
PESR4180-C	<input type="checkbox"/>	18	40	105	20
PESR4200-C	<input type="checkbox"/>	20	40	105	20

PESS-C、PESR2-C、PESR4-Cの対応被削材

炭素鋼 合金鋼 Carbon steel Alloy steel	炭素鋼 合金鋼 Pre-hardened steel ≤ 45HRC	高硬度 Hardened steel			ステン レス鋼 Stainless steel	チタン合金 耐熱合金 Titanium alloy Heat-resistant alloy	銅合金 Copper alloy	アルミ 合金 Aluminum alloy
		> 45HRC ≤ 55HRC	> 55HRC ≤ 65HRC	> 65HRC				
<input type="checkbox"/>	<input type="checkbox"/>	<input type="checkbox"/>	<input type="checkbox"/>	<input type="checkbox"/>	<input type="checkbox"/>	<input type="checkbox"/>	<input type="checkbox"/>	

印：特定代理店在庫です。弊社営業へお問合せください。 ：Stocked by specified distributor. Contact with our sales department.

ピンカド®・ショート刃長 Pinkado, Short



外径公差 Dia. tolerance: $-0.005 \sim -0.015$ (mm) **h6**

超硬 Carbide, ねじり30° Helix angle, 切削条件表 A436 Cutting Conditions



ピンカド®・レギュラー刃長 Pinkado, Regular



外径公差 Dia. tolerance: $-0.005 \sim -0.015$ (mm) **h6**

超硬 Carbide, ねじり30° Helix angle, 切削条件表 A436 Cutting Conditions



ピンカド®・レギュラー刃長 Pinkado, Regular



外径公差 Dia. tolerance: $-0.005 \sim -0.015$ (mm) **h6**

超硬 Carbide, ねじり30° Helix angle, 切削条件表 A436 Cutting Conditions



PESS2

商品コード Item code	在庫 Stock	寸法 Size (mm)			
		外径 Tool dia.	刃長 Flute length	全長 Overall length	シャンク径 Shank dia.
PESS2010	<input type="checkbox"/>	1	2	40	4
PESS2015	<input type="checkbox"/>	1.5	3	40	4
PESS2020	<input type="checkbox"/>	2	4	40	4
PESS2025	<input type="checkbox"/>	2.5	5	40	4
PESS2030	<input type="checkbox"/>	3	7	45	6
PESS2035	<input type="checkbox"/>	3.5	8	45	6
PESS2040	<input type="checkbox"/>	4	8	45	6
PESS2045	<input type="checkbox"/>	4.5	10	45	6
PESS2050	<input type="checkbox"/>	5	10	50	6
PESS2055	<input type="checkbox"/>	5.5	12	50	6
PESS2060	<input type="checkbox"/>	6	12	50	6
PESS2065	<input type="checkbox"/>	6.5	14	50	6
PESS2070	<input type="checkbox"/>	7	14	60	8
PESS2075	<input type="checkbox"/>	7.5	14	60	8
PESS2080	<input type="checkbox"/>	8	16	60	8
PESS2085	<input type="checkbox"/>	8.5	16	60	8
PESS2090	<input type="checkbox"/>	9	18	65	10
PESS2095	<input type="checkbox"/>	9.5	18	65	10
PESS2100	<input type="checkbox"/>	10	18	70	10
PESS2105	<input type="checkbox"/>	10.5	22	70	10
PESS2110	<input type="checkbox"/>	11	22	75	12
PESS2115	<input type="checkbox"/>	11.5	22	75	12
PESS2120	<input type="checkbox"/>	12	22	75	12
PESS2130	<input type="checkbox"/>	13	22	75	12
PESS2140	<input type="checkbox"/>	14	27	90	16
PESS2150	<input type="checkbox"/>	15	27	90	16
PESS2160	<input type="checkbox"/>	16	27	90	16
PESS2170	<input type="checkbox"/>	17	30	90	16
PESS2180	<input type="checkbox"/>	18	30	105	20
PESS2190	<input type="checkbox"/>	19	30	105	20
PESS2200	<input type="checkbox"/>	20	35	105	20

PESR2

商品コード Item code	在庫 Stock	寸法 Size (mm)			
		外径 Tool dia.	刃長 Flute length	全長 Overall length	シャンク径 Shank dia.
PESR2010	<input type="checkbox"/>	1	2.5	40	4
PESR2015	<input type="checkbox"/>	1.5	4	40	4
PESR2020	<input type="checkbox"/>	2	6	40	4
PESR2025	<input type="checkbox"/>	2.5	8	40	4
PESR2030	<input type="checkbox"/>	3	10	45	6
PESR2035	<input type="checkbox"/>	3.5	11	45	6
PESR2040	<input type="checkbox"/>	4	12	45	6
PESR2045	<input type="checkbox"/>	4.5	14	45	6
PESR2050	<input type="checkbox"/>	5	15	50	6
PESR2055	<input type="checkbox"/>	5.5	15	50	6
PESR2060	<input type="checkbox"/>	6	15	50	6
PESR2065	<input type="checkbox"/>	6.5	15	50	6
PESR2070	<input type="checkbox"/>	7	20	60	8
PESR2075	<input type="checkbox"/>	7.5	20	60	8
PESR2080	<input type="checkbox"/>	8	20	60	8
PESR2085	<input type="checkbox"/>	8.5	20	60	8
PESR2090	<input type="checkbox"/>	9	20	65	10
PESR2095	<input type="checkbox"/>	9.5	20	65	10
PESR2100	<input type="checkbox"/>	10	25	70	10
PESR2105	<input type="checkbox"/>	10.5	25	70	10
PESR2110	<input type="checkbox"/>	11	25	75	12
PESR2115	<input type="checkbox"/>	11.5	25	75	12
PESR2120	<input type="checkbox"/>	12	25	75	12

PESR4

商品コード Item code	在庫 Stock	寸法 Size (mm)			
		外径 Tool dia.	刃長 Flute length	全長 Overall length	シャンク径 Shank dia.
PESR4020	<input type="checkbox"/>	2	6	40	4
PESR4025	<input type="checkbox"/>	2.5	8	40	4
PESR4030	<input type="checkbox"/>	3	10	45	6
PESR4035	<input type="checkbox"/>	3.5	11	45	6
PESR4040	<input type="checkbox"/>	4	12	45	6
PESR4045	<input type="checkbox"/>	4.5	14	45	6
PESR4050	<input type="checkbox"/>	5	15	50	6
PESR4055	<input type="checkbox"/>	5.5	15	50	6
PESR4060	<input type="checkbox"/>	6	15	50	6
PESR4065	<input type="checkbox"/>	6.5	15	50	6
PESR4070	<input type="checkbox"/>	7	20	60	8
PESR4075	<input type="checkbox"/>	7.5	20	60	8
PESR4080	<input type="checkbox"/>	8	20	60	8
PESR4085	<input type="checkbox"/>	8.5	20	60	8
PESR4090	<input type="checkbox"/>	9	20	65	10
PESR4095	<input type="checkbox"/>	9.5	20	65	10
PESR4100	<input type="checkbox"/>	10	25	70	10
PESR4105	<input type="checkbox"/>	10.5	25	70	10
PESR4110	<input type="checkbox"/>	11	25	75	12
PESR4115	<input type="checkbox"/>	11.5	25	75	12
PESR4120	<input type="checkbox"/>	12	25	75	12

PESS、PESR2、PESR4 の対応被削材

炭素鋼 合金鋼 Carbon steel Alloy steel	炭素鋼 合金鋼 Pre-hardened steel ≤ 45HRC	高硬度 Hardened steel			ステン レス鋼 Stainless steel	チタン 合金 耐熱合金 Titanium alloy Heat-resistant alloy	銅合金 Copper alloy	アルミ 合金 Aluminum alloy
		> 45HRC ≤ 55HRC	> 55HRC ≤ 65HRC	> 65HRC				
<input type="checkbox"/>	<input type="checkbox"/>	<input type="checkbox"/>	<input type="checkbox"/>	<input type="checkbox"/>	<input type="checkbox"/>	<input type="checkbox"/>	<input type="checkbox"/>	

印：特定代理店在庫です。弊社営業へお問合せください。 ：Stocked by specified distributor. Contact with our sales department.

Carbide End Mills Stocked by Specified distributor

超硬ソリッドエンドミル

標準切削条件表 Recommended cutting conditions

PESS2-C

2枚刃・ショート刃長・ピンカド
2ft, Short, Pinkado

PESR2-C

2枚刃・レギュラー刃長・ピンカド
2ft, Regular, Pinkado

PESR4-C (注③)

4枚刃・レギュラー刃長・ピンカド
4ft, Regular, Pinkado

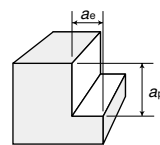

<側面切削> Side milling

被削材 Work material	鋳鉄・炭素鋼 Cast irons, Carbon steels (200HB以下) FC200, SS400, S45C		合金鋼 Alloy steels (200~250HB) SCM, SNCM		工具鋼・ステンレス鋼 Tool steels, Stainless steels (25~35HRC) SKD, SKT, SUS304		焼入れ鋼・プリハードン鋼 Hardened steels, Pre-hardened steels (35~45HRC) SKD, SKT, HPM1, NAK55		耐熱鋼・チタン合金 Heat-resistant steels, Titanium alloys Inconel Ti-6Al-4V		アルミ合金・非鉄金属 Aluminum alloys Non-Ferrous	
	切込み(mm) Depth of cut	$a_p=1.5DC, a_e=0.1DC$	$a_p=1.5DC, a_e=0.1DC$	$a_p=1.5DC, a_e=0.1DC$	$a_p=1.5DC, a_e=0.1DC$	$a_p=1.5DC, a_e=0.1DC$	$a_p=1.5DC, a_e=0.1DC$	$a_p=1.5DC, a_e=0.1DC$	$a_p=1.5DC, a_e=0.1DC$	$a_p=1.5DC, a_e=0.1DC$	$a_p=1.5DC, a_e=0.1DC$	$a_p=1.5DC, a_e=0.1DC$
外径DC Tool dia. (mm)	回転数n (min ⁻¹)	送り速度vf (mm/min)	回転数n (min ⁻¹)	送り速度vf (mm/min)	回転数n (min ⁻¹)	送り速度vf (mm/min)	回転数n (min ⁻¹)	送り速度vf (mm/min)	回転数n (min ⁻¹)	送り速度vf (mm/min)	回転数n (min ⁻¹)	送り速度vf (mm/min)
φ3	9,500	280	7,400	220	5,800	170	4,700	90	2,100	40	21,000	750
φ4	7,100	280	5,500	220	4,300	170	3,500	90	1,500	40	16,000	800
φ6	4,700	280	3,700	220	2,900	170	2,300	90	1,000	40	10,600	800
φ8	3,500	280	2,700	220	2,100	170	1,700	100	790	45	8,000	900
φ10	2,800	280	2,200	220	1,700	170	1,400	100	630	45	6,400	950
φ12	2,300	280	1,800	220	1,400	170	1,100	100	530	45	5,300	950
φ16	1,700	280	1,300	220	1,000	170	890	100	390	45	4,000	950
φ20	1,400	280	1,100	220	870	170	710	100	310	45	3,200	800
φ25	1,100	220	890	180	700	140	570	85	250	40	2,500	800

PESS2

2枚刃・ショート刃長・ピンカド

PESR2

2枚刃・レギュラー刃長・ピンカド

PESR4 (注③)

4枚刃・レギュラー刃長・ピンカド

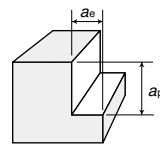

<側面切削> Side milling

被削材 Work material	鋳鉄・炭素鋼 Cast irons, Carbon steels (200HB以下) FC200, SS400, S45C		合金鋼 Alloy steels (200~250HB) SCM, SNCM		工具鋼・ステンレス鋼 Tool steels, Stainless steels (25~35HRC) SKD, SKT, SUS304		焼入れ鋼・プリハードン鋼 Hardened steels, Pre-hardened steels (35~45HRC) SKD, SKT, HPM1, NAK55		耐熱鋼・チタン合金 Heat-resistant steels, Titanium alloys Inconel Ti-6Al-4V		アルミ合金・非鉄金属 Aluminum alloy Non-Ferrous	
	切込み(mm) Depth of cut	$a_p=1.5DC, a_e=0.1DC$	$a_p=1.5DC, a_e=0.1DC$	$a_p=1.5DC, a_e=0.1DC$	$a_p=1.5DC, a_e=0.1DC$	$a_p=1.5DC, a_e=0.1DC$	$a_p=1.5DC, a_e=0.1DC$	$a_p=1.5DC, a_e=0.1DC$	$a_p=1.5DC, a_e=0.1DC$	$a_p=1.5DC, a_e=0.1DC$	$a_p=1.5DC, a_e=0.1DC$	$a_p=1.5DC, a_e=0.1DC$
外径DC Tool dia. (mm)	回転数n (min ⁻¹)	送り速度vf (mm/min)	回転数n (min ⁻¹)	送り速度vf (mm/min)	回転数n (min ⁻¹)	送り速度vf (mm/min)	回転数n (min ⁻¹)	送り速度vf (mm/min)	回転数n (min ⁻¹)	送り速度vf (mm/min)	回転数n (min ⁻¹)	送り速度vf (mm/min)
φ3	4,750	140	3,700	80	3,200	60	2,650	30	1,600	20	21,000	750
φ4	3,600	140	2,750	110	2,400	60	2,000	30	1,200	25	16,000	800
φ6	2,400	150	1,850	110	1,600	60	1,320	40	800	25	10,600	800
φ8	1,800	150	1,400	110	1,200	90	1,000	50	600	30	8,000	900
φ10	1,450	150	1,100	110	950	90	800	50	480	30	6,400	950
φ12	1,200	180	930	110	800	90	660	50	400	30	5,300	950
φ16	900	180	700	110	600	90	500	50	300	30	4,000	950
φ20	720	180	560	110	480	90	400	50	240	30	3,200	800
φ25	570	140	450	100	380	90	320	50	190	30	2,500	800
φ30	480	120	370	80	320	90	270	50	160	30	2,100	650

[注意] ①被削材、加工形状に合わせて、適切なクーラントを使用してください。
②この標準切削条件表は切削条件の目安を示すものです。実際の加工では加工形状、目的、使用機械等により条件を調整してください。
③上記の切削条件は2枚刃の場合を示します。4枚刃は送り速度を1.5倍にしてください。

[Note] ① Use the appropriate coolant for the work material and machining shape.
② These Recommended Cutting Conditions indicate only the rule of a thumb for the cutting conditions. In actual machining, the condition should be adjusted according to the machining shape, purpose and the machine type.
③ The cutting conditions given above is applied to 2-flute type end mills. As for 4-flute type, increase the feed speed by 1.5 times.

PESS2

2枚刃・ショート刃長・ピンカド
2ft, Short, Pinkado

PESR2

2枚刃・レギュラー刃長・ピンカド
2ft, Regular, Pinkado

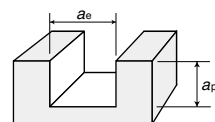

<溝切削> Slotting

被削材 Work material	鋳鉄・炭素鋼 Cast irons, Carbon steels (200HB以下) FC200, SS400, S45C		合金鋼 Alloy steels (200~250HB) SCM, SNCM		工具鋼・ステンレス鋼 Tool steels, Stainless steels (25~35HRC) SKD, SKT, SUS304		焼入れ鋼・プリハードン鋼 Hardened steels, Pre-hardened steels (35~45HRC) SKD, SKT, HPM1, NAK55		耐熱鋼・チタン合金 Heat-resistant steels, Titanium alloys Inconel Ti-6Al-4V		アルミ合金・非鉄金属 Aluminum alloy Non-Ferrous	
	切込み(mm) Depth of cut	$a_p=0.5DC, a_e=1DC$	$a_p=0.5DC, a_e=1DC$	$a_p=0.5DC, a_e=1DC$	$a_p=0.5DC, a_e=1DC$	$a_p=0.5DC, a_e=1DC$	$a_p=0.5DC, a_e=1DC$	$a_p=0.5DC, a_e=1DC$	$a_p=0.5DC, a_e=1DC$	$a_p=0.5DC, a_e=1DC$	$a_p=0.5DC, a_e=1DC$	$a_p=0.5DC, a_e=1DC$
外径DC Tool dia. (mm)	回転数n (min ⁻¹)	送り速度vf (mm/min)	回転数n (min ⁻¹)	送り速度vf (mm/min)	回転数n (min ⁻¹)	送り速度vf (mm/min)	回転数n (min ⁻¹)	送り速度vf (mm/min)	回転数n (min ⁻¹)	送り速度vf (mm/min)	回転数n (min ⁻¹)	送り速度vf (mm/min)
φ3	3,700	80	3,200	50	2,650	30	2,100	22	1,250	15	11,000	300
φ4	2,750	85	2,400	50	2,000	30	1,590	22	950	15	8,000	300
φ6	1,850	85	1,600	50	1,320	30	1,060	22	640	15	5,300	300
φ8	1,400	90	1,200	60	1,000	40	800	33	480	20	4,000	300
φ10	1,100	90	950	60	800	40	640	33	380	20	3,200	300
φ12	930	90	800	60	660	40	530	33	320	20	2,700	300
φ16	700	90	600	60	500	40	400	33	240	20	2,700	300
φ20	560	90	480	60	400	40	320	33	190	20	1,600	300
φ25	450	90	380	60	320	40	250	33	150	20	1,250	300
φ30	370	90	320	60	270	40	210	33	130	20	1,000	300

[注意] ①被削材、加工形状に合わせて、適切なクーラントを使用してください。
②この標準切削条件表は切削条件の目安を示すものです。実際の加工では加工形状、目的、使用機械等により条件を調整してください。

[Note] ① Use the appropriate coolant for the work material and machining shape.
② These Recommended Cutting Conditions indicate only the rule of a thumb for the cutting conditions. In actual machining, the condition should be adjusted according to the machining shape, purpose and the machine type.

CS Coating Carbide End Mill Squar

CSコート超硬エンドミル スクエア

ピンクアド®・ショート刃長 Pinkado, Short



外径公差
 $\phi 0.2 \sim \phi 0.9 : 0 \sim -0.015$
 $\phi 1 \sim \phi 20 : 0 \sim -0.02$



(mm)

2枚刃
2Flutes



ピンクアド®・レギュラー刃長 Pinkado, Regular



外径公差
 $0 \sim -0.02$



(mm)

4枚刃
4Flutes



YS2○○○-CS



商品コード Item code	在庫 Stock	寸法 Size (mm)			
		外径 Tool dia.	刃長 Flute length	全長 Overall length	シャンク径 Shank dia.
YS2002-CS	<input type="checkbox"/>	0.2	0.4	40	4
YS2003-CS	<input type="checkbox"/>	0.3	0.6	40	4
YS2004-CS	<input type="checkbox"/>	0.4	0.8	40	4
YS2005-CS	<input type="checkbox"/>	0.5	1	40	4
YS2006-CS	<input type="checkbox"/>	0.6	1.2	40	4
YS2007-CS	<input type="checkbox"/>	0.7	1.4	40	4
YS2008-CS	<input type="checkbox"/>	0.8	1.6	40	4
YS2009-CS	<input type="checkbox"/>	0.9	1.8	40	4
YS2010-CS	<input type="checkbox"/>	1	2	40	4
YS2015-CS	<input type="checkbox"/>	1.5	3	40	4
YS2020-CS	<input type="checkbox"/>	2	6	40	4
YS2025-CS	<input type="checkbox"/>	2.5	8	40	4
YS2030-CS	<input type="checkbox"/>	3	8	45	6
YS2035-CS	<input type="checkbox"/>	3.5	10	45	6
YS2040-CS	<input type="checkbox"/>	4	11	45	6
YS2045-CS	<input type="checkbox"/>	4.5	11	45	6
YS2050-CS	<input type="checkbox"/>	5	13	50	6
YS2055-CS	<input type="checkbox"/>	5.5	13	50	6
YS2060-CS	<input type="checkbox"/>	6	13	50	6
YS2070-CS	<input type="checkbox"/>	7	16	60	8
YS2080-CS	<input type="checkbox"/>	8	19	60	8
YS2090-CS	<input type="checkbox"/>	9	19	70	10
YS2100-CS	<input type="checkbox"/>	10	22	70	10
YS2120-CS	<input type="checkbox"/>	12	26	75	12
YS2160-CS	<input type="checkbox"/>	16	35	90	16
YS2200-CS	<input type="checkbox"/>	20	40	105	20

YR4○○○-CS



商品コード Item code	在庫 Stock	寸法 Size (mm)			
		外径 Tool dia.	刃長 Flute length	全長 Overall length	シャンク径 Shank dia.
YR4010-CS	<input type="checkbox"/>	1	2.5	40	4
YR4015-CS	<input type="checkbox"/>	1.5	4	40	4
YR4020-CS	<input type="checkbox"/>	2	6	40	4
YR4025-CS	<input type="checkbox"/>	2.5	8	40	4
YR4030-CS	<input type="checkbox"/>	3	10	45	6
YR4040-CS	<input type="checkbox"/>	4	12	45	6
YR4050-CS	<input type="checkbox"/>	5	15	50	6
YR4060-CS	<input type="checkbox"/>	6	15	50	6
YR4080-CS	<input type="checkbox"/>	8	20	60	8
YR4100-CS	<input type="checkbox"/>	10	25	70	10
YR4120-CS	<input type="checkbox"/>	12	30	75	12
YR4160-CS	<input type="checkbox"/>	16	35	90	16
YR4200-CS	<input type="checkbox"/>	20	40	105	20

YS-CS、YR-CS の対応被削材

Applicable work material of YS-CS, YR-CS

炭素鋼 合金鋼 Carbon steel Alloy steel	プリハー ド鋼 Pre-hardened steel	高硬度 Hardened steel			ステン レス鋼 Stainless steel	チタン合金 耐熱合金 Titanium alloy Heat-resistant alloy	銅合金 Copper alloy	アルミ 合金 Aluminum alloy
		> 45HRC ≤ 55HRC	> 55HRC ≤ 65HRC	> 65HRC				
◎	○				○	○	◎	◎

○印：特定代理店在庫です。弊社営業へお問合せください。 □印：Stocked by specified distributor. Contact with our sales department.

Carbide End Mills

Stocked by Specified distributor

標準切削条件表 Recommended cutting conditions

超硬エンドミル 特定代理店在庫品

YS-CS
2枚刃・ショート刃長・ピンカド
2ft, Short, Pinkado

切込み
Depth of Cut (mm)

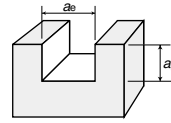

	ap
DC < φ1	0.1DC
φ1 ≤ DC < φ3	0.3DC
φ3 ≤ DC	0.5DC

<溝切削> Slotting

被削材 Work material	銅合金・アルミ合金 Copper alloys, Aluminum alloys		鋳鉄・炭素鋼 Cast irons, Carbon steels FC200, SS400, S50C		ステンレス鋼 Stainless steels SUS304, SUS316		合金鋼・工具鋼 Alloy steels, Tool steels SCM, SKD, ARK1		プリハードン鋼・焼入れ鋼 Pre-hardened steels, Hardened steels CEN11, NAK80, SKD	
	—		~250HB		—		25~35HRC		35~45HRC	
外径 DC mm	切削条件 Conditions		切削条件 Conditions		切削条件 Conditions		切削条件 Conditions		切削条件 Conditions	
	回転数n Revolution min ⁻¹	送り速度vf Table Speed mm/min	回転数n Revolution min ⁻¹	送り速度vf Table Speed mm/min	回転数n Revolution min ⁻¹	送り速度vf Table Speed mm/min	回転数n Revolution min ⁻¹	送り速度vf Table Speed mm/min	回転数n Revolution min ⁻¹	送り速度vf Table Speed mm/min
0.2	30,000		20,000		10,000		10,000		10,000	
0.5	~50,000	300~500	~50,000	100~500	~30,000	70~300	~30,000	70~300	~30,000	50~200
0.8										
1	32,000	300	14,000	100	9,000	67	9,500	70	8,000	50
1.5	20,000	300	9,500	120	5,700	76	6,000	80	5,000	50
2	16,000	300	7,100	120	4,600	76	4,800	80	4,000	50
3	11,000	300	4,700	140	2,900	86	3,100	90	2,600	55
4	8,000	300	3,500	140	2,200	86	2,300	90	1,900	55
5	6,400	300	2,800	140	1,800	86	1,900	90	1,600	55
6	5,300	300	2,300	140	1,400	86	1,500	90	1,300	55
8	4,000	300	1,700	140	1,000	86	1,100	90	990	60
10	3,200	300	1,400	140	900	90	950	95	790	60
12	2,700	300	1,100	140	750	90	790	95	660	60
16	2,000	300	800	140	500	90	550	95	450	60
20	1,600	300	650	140	400	90	450	95	350	60

[注意] ①被削材、加工形状に合わせて、適切なクーラントを使用してください。 **[Note]** ①Use the appropriate coolant for the work material and machining shape.
 ②この標準切削条件表は切削条件の目安を示すものです。実際の加工では加工形状、目的、使用機械等により条件を調整してください。 ②These Recommended Cutting Conditions indicate only the rule of a thumb for the cutting conditions. In actual machining, the condition should be adjusted according to the machining shape, purpose and the machine type.
 ③4枚刃は溝切削に適しません。 ③4-Flutes type is not suited to slotting.

YS-CS | **YR-CS**
2枚刃・ショート刃長・ピンカド | 4枚刃・レギュラー刃長・ピンカド
2ft, Short, Pinkado | 4ft, Regular, Pinkado

切込み
Depth of Cut (mm)

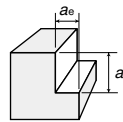

	ae	ap
DC < φ3	0.05DC以下	1.5DC以下
φ3 ≤ DC	0.1DC以下	

<側面切削> Side Milling

被削材 Work material	銅合金・アルミ合金 Copper alloys, Aluminum alloys		鋳鉄・炭素鋼 Cast irons, Carbon steels FC200, SS400, S50C		ステンレス鋼 Stainless steels SUS304, SUS316		合金鋼・工具鋼 Alloy steels, Tool steels SCM, SKD, ARK1		プリハードン鋼・焼入れ鋼 Pre-hardened steels, Hardened steels CEN11, NAK80, SKD	
	—		~250HB		—		25~35HRC		35~45HRC	
外径 DC mm	切削条件 Conditions		切削条件 Conditions		切削条件 Conditions		切削条件 Conditions		切削条件 Conditions	
	回転数n Revolution min ⁻¹	送り速度vf Table Speed mm/min	回転数n Revolution min ⁻¹	送り速度vf Table Speed mm/min	回転数n Revolution min ⁻¹	送り速度vf Table Speed mm/min	回転数n Revolution min ⁻¹	送り速度vf Table Speed mm/min	回転数n Revolution min ⁻¹	送り速度vf Table Speed mm/min
0.2	30,000		30,000		25,000		25,000		20,000	
0.5	~50,000	600~1,000	~50,000	220~1,000	~40,000	160~700	~40,000	160~700	~38,000	60~240
0.8										
1	20,000	600	20,000	220	15,200	150	16,000	160	12,000	60
2	20,000	700	12,000	250	7,600	190	8,000	200	6,500	80
3	20,000	750	9,500	280	5,500	210	5,800	220	4,700	90
4	16,000	800	7,100	280	4,100	210	4,300	220	3,500	90
5	12,500	800	5,600	280	3,300	210	3,500	220	2,800	90
6	10,600	900	4,700	280	2,800	210	2,900	220	2,300	90
8	8,000	950	3,500	280	2,000	210	2,100	220	1,700	100
10	6,400	950	2,800	280	1,600	210	1,700	220	1,400	100
12	5,300	950	2,300	280	1,300	210	1,400	220	1,100	100
16	4,000	950	1,700	280	950	210	1,000	220	800	100
20	3,200	950	1,400	280	760	210	800	220	650	100

[注意] ①被削材、加工形状に合わせて、適切なクーラントを使用してください。 **[Note]** ①Use the appropriate coolant for the work material and machining shape.
 ②この標準切削条件表は切削条件の目安を示すものです。実際の加工では加工形状、目的、使用機械等により条件を調整してください。 ②These Recommended Cutting Conditions indicate only the rule of a thumb for the cutting conditions. In actual machining, the condition should be adjusted according to the machining shape, purpose and the machine type.
 ③上記の切削条件は2枚刃の場合を示します。4枚刃は送り速度を1.5倍にしてください。 ③The cutting conditions given above is applied to 2-flute type end mills. As for 4-flute type, increase the feed by 1.5 times.

Carbide Super Helical End Mills

超硬スーパーヘリカルエンドミル

Cコーティング C Coating

側面 溝 仕上 超硬 C 傾斜60° 切削条件表 A439

Side Cutting Slotting Finishing Carbide Helix angle Cutting Conditions

外径公差 Dia. tolerance
 $\phi 2 \sim \phi 5 : 0 \sim -0.04$
 $\phi 6 \sim \phi 20 : 0 \sim -0.05$

h6 (mm)

ノンコーティング Non Coating

側面 溝 仕上 超硬 傾斜60° 切削条件表 A439

Side Cutting Slotting Finishing Carbide Helix angle Cutting Conditions

外径公差 Dia. tolerance
 $\phi 2 \sim \phi 5 : 0 \sim -0.04$
 $\phi 6 \sim \phi 30 : 0 \sim -0.05$

h6 (mm)



SES ○○○○-C 強ねじれ Super Helix

商品コード Item code	在庫 Stock	寸法 Size (mm)				刃数 No. of flutes
		外径 Tool dia.	刃長 Flute length	全長 Overall length	シャン径 Shank dia.	
SES2020-C	<input type="checkbox"/>	2	4	40	4	2
SES2030-C	<input type="checkbox"/>	3	6	45	6	2
SES2040-C	<input type="checkbox"/>	4	8	45	6	2
SES2050-C	<input type="checkbox"/>	5	10	50	6	2
SES3060-C	<input type="checkbox"/>	6	12	50	6	3
SES3070-C	<input type="checkbox"/>	7	14	60	8	3
SES3080-C	<input type="checkbox"/>	8	16	60	8	3
SES3100-C	<input type="checkbox"/>	10	25	70	10	3
SES3120-C	<input type="checkbox"/>	12	25	75	12	3
SES3140-C	<input type="checkbox"/>	14	35	90	16	3
SES3150-C	<input type="checkbox"/>	15	35	90	16	3
SES3160-C	<input type="checkbox"/>	16	35	90	16	3
SES3200-C	<input type="checkbox"/>	20	45	110	20	3

SES ○○○○ 強ねじれ Super Helix

商品コード Item code	在庫 Stock	寸法 Size (mm)				刃数 No. of flutes
		外径 Tool dia.	刃長 Flute length	全長 Overall length	シャン径 Shank dia.	
SES2020	<input type="checkbox"/>	2	4	40	4	2
SES2030	<input type="checkbox"/>	3	6	45	6	2
SES2040	<input type="checkbox"/>	4	8	45	6	2
SES2050	<input type="checkbox"/>	5	10	50	6	2
SES3060	<input type="checkbox"/>	6	12	50	6	3
SES3070	<input type="checkbox"/>	7	14	60	8	3
SES3080	<input type="checkbox"/>	8	16	60	8	3
SES3090	<input type="checkbox"/>	9	20	65	10	3
SES3100	<input type="checkbox"/>	10	25	70	10	3
SES3110	<input type="checkbox"/>	11	25	75	12	3

商品コード Item code	在庫 Stock	寸法 Size (mm)				刃数 No. of flutes
		外径 Tool dia.	刃長 Flute length	全長 Overall length	シャン径 Shank dia.	
SES3120	<input type="checkbox"/>	12	25	75	12	3
SES3130	<input type="checkbox"/>	13	25	75	12	3
SES3140	<input type="checkbox"/>	14	35	90	16	3
SES3150	<input type="checkbox"/>	15	35	90	16	3
SES3160	<input type="checkbox"/>	16	35	90	16	3
SES3180	<input type="checkbox"/>	18	40	105	20	3
SES3200	<input type="checkbox"/>	20	45	110	20	3
SES4250	<input type="checkbox"/>	25	50	120	25	4
SES4300	<input type="checkbox"/>	30	55	130	32	4

○ 対応被削材 Applicable work material

商品コード Item code	炭素鋼 合金鋼 Carbon steel Alloy steel	プリハードン 鋼 Pre-hardened steel ≤ 45HRC	高硬度 Hardened Steel			ステン レス鋼 Stainless steel	チタン合金 耐熱合金 Titanium alloy Heat-resistant alloy	銅合金 Copper alloy	アルミ 合金 Aluminum alloy
			> 45HRC ≤ 55HRC	> 55HRC ≤ 65HRC	> 65HRC				
SES-C	○	○	○	○	○	○	○	○	
SES	○	○	○	○	○	○	○	○	

○ 標準切削条件表 Recommended cutting conditions

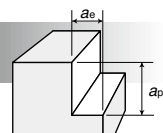

<側面切削> Side milling

コーティング Coating	被削材 Work material	鋳鉄・炭素鋼 Cast irons, Carbon steels (200HB以下) FC200, SS400, S45C		合金鋼 Alloy steels (200~250HB) SCM, SNCM		工具鋼・ステンレス鋼 Tool steels, Stainless steels (25~35HRC) SKD, SKT, SUS304		焼入れ鋼・プリハードン鋼 Hardened steels, Pre-hardened steels (35~45HRC) SKD, SKT, HPM1, NAK55		耐熱鋼・チタン合金 Heat-resistant steels, Titanium alloys Inconel Ti-6Al-4V	
		切込み (mm) Depth of cut		切込み (mm) Depth of cut		切込み (mm) Depth of cut		切込み (mm) Depth of cut		切込み (mm) Depth of cut	
		外径DC Tool dia. (mm)	回転数 n (min ⁻¹)	送り速度 vf (mm/min)	回転数 n (min ⁻¹)	送り速度 vf (mm/min)	回転数 n (min ⁻¹)	送り速度 vf (mm/min)	回転数 n (min ⁻¹)	送り速度 vf (mm/min)	回転数 n (min ⁻¹)
Cコーティング C Coating SES-C	φ3	5,000	130	4,200	100	3,700	65	2,900	50	2,600	40
	φ4	4,000	140	3,200	110	2,800	70	2,200	50	2,000	40
	φ6	2,600	180	2,100	150	1,800	100	1,500	60	1,300	55
	φ8	2,000	180	1,600	150	1,400	100	1,100	60	1,000	55
	φ10	1,600	180	1,300	150	1,100	100	900	60	800	55
	φ12	1,300	180	1,000	150	930	100	750	60	650	55
	φ16	1,000	200	800	150	700	100	550	60	500	55
ノンコーティング Non Coating SES	φ20	800	200	650	150	560	100	450	60	400	55
	φ3	4,000	100	3,400	80	3,000	50	2,300	40	2,000	30
	φ4	3,000	110	2,500	90	2,000	60	1,700	40	1,500	30
	φ6	2,000	160	1,700	120	1,400	80	1,100	50	1,000	45
	φ8	1,500	160	1,200	120	1,000	80	900	60	800	45
	φ10	1,200	160	1,000	120	900	90	700	60	650	45
	φ12	1,000	160	900	120	750	90	600	60	530	45
φ16	750	170	600	120	500	90	400	60	360	45	
φ20	630	170	500	120	450	90	350	60	300	45	
φ25	500	180	400	140	350	100	280	70	250	55	
φ30	400	160	350	130	300	90	230	60	200	45	

[注意] ① 切削油は、鋼切削の場合は油性切削液、鋳鉄・非鉄金属切削の場合は乾式または水溶性切削液をお使いください。
 ② この標準切削条件表は切削条件の目安を示すものです。実際の加工では加工形状、目的、使用機械等により条件を調整してください。
 ③ 超硬スーパーヘリカルエンドミルは溝切削には適当ではありません。

[Note] ① In cutting steel, be sure to use oily cutting fluid, and in cutting cast iron and non-iron metals, use dry or water-soluble cutting fluid.
 ② These Recommended Cutting Conditions indicate only the rule of a thumb for the cutting conditions. In actual machining, the condition should be adjusted according to the machining shape, purpose and the machine type.
 ③ Carbide Super Helical End Mill is not suited to slotting.

□印：特定代理店在庫です。弊社営業へお問合せください。 □：Stocked by specified distributor. Contact with our sales department.

Carbide End Mills

Stocked by Specified distributor

Carbide End Mills for Key-way

超硬キー溝用エンドミル

プラス公差

Plus Tolerance



外径公差 Dia. tolerance
 $\phi 2 \sim \phi 10 : +0.01 \sim 0$
 $\phi 11 \sim \phi 16 : +0.015 \sim +0.005$



(mm)

2枚刃
2Flutes



KES2



商品コード Item code	在庫 Stock	寸法 Size (mm)			
		外径 Tool dia.	刃長 Flute length	全長 Overall length	シャンク径 Shank dia.
KES2020	<input type="checkbox"/>	2	3	50	6
KES2030	<input type="checkbox"/>	3	4.5	50	6
KES2040	<input type="checkbox"/>	4	6	55	8
KES2050	<input type="checkbox"/>	5	7.5	55	8
KES2060	<input type="checkbox"/>	6	9	55	8
KES2070	<input type="checkbox"/>	7	10.5	60	10
KES2080	<input type="checkbox"/>	8	12	60	10
KES2090	<input type="checkbox"/>	9	13.5	65	12
KES2100	<input type="checkbox"/>	10	15	65	12
KES2110	<input type="checkbox"/>	11	16.5	65	12
KES2120	<input type="checkbox"/>	12	18	65	12
KES2130	<input type="checkbox"/>	13	19.5	70	16
KES2140	<input type="checkbox"/>	14	21	70	16
KES2150	<input type="checkbox"/>	15	22.5	70	16
KES2160	<input type="checkbox"/>	16	24	70	16

マイナス公差

Minus Tolerance



外径公差 Dia. tolerance
 $\phi 2 \sim \phi 3 : -0.01 \sim -0.018$
 $\phi 4 \sim \phi 6 : -0.01 \sim -0.02$
 $\phi 7 \sim \phi 10 : -0.015 \sim -0.025$
 $\phi 11 \sim \phi 16 : -0.018 \sim -0.028$



(mm)

2枚刃
2Flutes



KESU2



商品コード Item code	在庫 Stock	寸法 Size (mm)			
		外径 Tool dia.	刃長 Flute length	全長 Overall length	シャンク径 Shank dia.
KESU2020	<input type="checkbox"/>	2	3	50	6
KESU2030	<input type="checkbox"/>	3	4.5	50	6
KESU2040	<input type="checkbox"/>	4	6	55	8
KESU2050	<input type="checkbox"/>	5	7.5	55	8
KESU2060	<input type="checkbox"/>	6	9	55	8
KESU2070	<input type="checkbox"/>	7	10.5	60	10
KESU2080	<input type="checkbox"/>	8	12	60	10
KESU2090	<input type="checkbox"/>	9	13.5	65	12
KESU2100	<input type="checkbox"/>	10	15	65	12
KESU2110	<input type="checkbox"/>	11	16.5	65	12
KESU2120	<input type="checkbox"/>	12	18	65	12
KESU2130	<input type="checkbox"/>	13	19.5	70	16
KESU2140	<input type="checkbox"/>	14	21	70	16
KESU2150	<input type="checkbox"/>	15	22.5	70	16
KESU2160	<input type="checkbox"/>	16	24	70	16

Carbide End Mills for High Hardened Steel

超硬高硬度材用エンドミル



外径公差 Dia. tolerance
 $0 \sim -0.02$



(mm)

2枚刃
2Flutes



TES2



商品コード Item code	在庫 Stocks	寸法 Size (mm)			
		外径 Tool dia.	刃長 Flute length	全長 Overall length	シャンク径 Shank dia.
TES2020	<input type="checkbox"/>	2	3	40	4
TES2030	<input type="checkbox"/>	3	5	45	6
TES2040	<input type="checkbox"/>	4	7	45	6
TES2050	<input type="checkbox"/>	5	9	50	6
TES2060	<input type="checkbox"/>	6	10	50	6
TES2070	<input type="checkbox"/>	7	12	60	8
TES2080	<input type="checkbox"/>	8	14	60	8
TES2090	<input type="checkbox"/>	9	16	65	10
TES2100	<input type="checkbox"/>	10	18	70	10
TES2110	<input type="checkbox"/>	11	20	75	12
TES2120	<input type="checkbox"/>	12	22	75	12

Carbide End Mills for Mold

超硬型彫用エンドミル

スクエア刃

Square

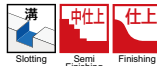

(mm)

直刃 Straight flute



FE7



商品コード Item code	在庫 Stocks	寸法 Size (mm)			
		外径 Tool dia.	刃長 Flute length	全長 Overall length	シャンク径 Shank dia.
FE704	<input type="checkbox"/>	4	20	65	4
FE706	<input type="checkbox"/>	6	25	80	6
FE708	<input type="checkbox"/>	8	25	80	8
FE710	<input type="checkbox"/>	10	30	80	10
FE712	<input type="checkbox"/>	12	30	80	12
FE714	<input type="checkbox"/>	14	35	80	14
FE716	<input type="checkbox"/>	16	35	110	16
FE718	<input type="checkbox"/>	18	40	110	18
FE720	<input type="checkbox"/>	20	40	110	20

○ KES、KESU、TES、FE7の対応被削材

Applicable work material of KES, KESU, TES, FE7

炭素鋼 合金鋼 Carbon steel Alloy steel	プリハー ド鋼 Pre-hardened steel ≤ 45HRC	高硬度 Hardened steel			ステン レス鋼 Stainless steel	チタン合金 耐熱合金 Titanium alloy Heat-resistant alloy	銅合金 Copper alloy	アルミ 合金 Aluminum alloy
		> 45HRC ≤ 55HRC	> 55HRC ≤ 65HRC	> 65HRC				
○	○				○	○	◎	◎

□印：特定代理店在庫です。弊社営業へお問合せください。

○：Stocked by specified distributor. Contact with our sales department.

Carbide End Mills for Graphite

超硬グラファイト用エンドミル

レギュラー刃長 Regular

外径公差 DC < 6 : 0 ~ -0.03
6 ≤ DC : 0 ~ -0.04

h6

超硬 Helix 30° 切削条件表 A441

汎用機用 エアホールなし
For General without air-hole



ロング刃長 Long

外径公差 DC < 6 : 0 ~ -0.03
6 ≤ DC : 0 ~ -0.04

h6

超硬 Helix 30° 切削条件表 A441

汎用機用 エアホールなし
For General without air-hole



ロングシャンク Long Shank

外径公差 0 ~ -0.03

h6

超硬 Helix 30° 切削条件表 A441

汎用機用 エアホールなし
For General without air-hole



GSR

商品コード Item code	在庫 Stock	寸法 Size (mm)				刃数 No. of flutes
		外径 Tool dia.	刃長 Flute length	全長 Overall length	シャンク径 Shank dia.	
GSR2020	□	2	10	80	6	2
GSR2030	□	3	15	80	6	2
GSR2040	□	4	20	80	6	2
GSR2050	□	5	25	100	6	2
GSR2060	□	6	30	100	6	2
GSR2070	□	7	35	100	6	2
GSR2080	□	8	40	110	8	2
GSR2090	□	9	45	110	8	2
GSR2100	□	10	50	120	10	2
GSR2110	□	11	50	120	10	2
GSR2120	□	12	55	130	12	2
GSR2130	□	13	55	130	12	2
GSR4140	□	14	60	140	12	4
GSR4150	□	15	60	140	12	4
GSR4160	□	16	65	150	16	4
GSR4170	□	17	65	150	16	4
GSR4180	□	18	65	160	16	4
GSR4200	□	20	75	160	20	4

GSL

商品コード Item code	在庫 Stock	寸法 Size (mm)				刃数 No. of flutes
		外径 Tool dia.	刃長 Flute length	全長 Overall length	シャンク径 Shank dia.	
GSL2020	□	2	20	100	6	2
GSL2030	□	3	30	100	6	2
GSL2040	□	4	60	110	6	2
GSL2050	□	5	70	125	6	2
GSL2060	□	6	80	130	6	2
GSL2070	□	7	90	140	6	2
GSL2080	□	8	100	150	8	2
GSL2090	□	9	110	160	8	2
GSL2100	□	10	120	170	10	2
GSL2110	□	11	120	170	10	2
GSL2120	□	12	130	190	12	2
GSL2130	□	13	130	190	12	2
GSL4140	□	14	140	210	12	4
GSL4150	□	15	140	210	12	4
GSL4160	□	16	150	230	16	4
GSL4170	□	17	150	230	16	4
GSL4180	□	18	160	250	16	4
GSL4200	□	20	180	250	20	4

GXR

商品コード Item code	在庫 Stock	寸法 Size (mm)				刃数 No. of flutes
		外径 Tool dia.	刃長 Flute length	全長 Overall length	シャンク径 Shank dia.	
GXR2020	□	2	10	100	6	2
GXR2030	□	3	15	100	6	2
GXR2040	□	4	20	110	6	2
GXR2050	□	5	25	125	6	2
GXR2060	□	6	30	130	6	2
GXR2070	□	7	35	140	6	2
GXR2080	□	8	40	150	8	2
GXR2090	□	9	45	160	8	2
GXR2100	□	10	50	170	10	2
GXR2110	□	11	50	170	10	2
GXR2120	□	12	55	190	12	2
GXR2130	□	13	55	190	12	2
GXR4140	□	14	60	210	12	4
GXR4150	□	15	60	210	12	4
GXR4160	□	16	65	230	16	4
GXR4170	□	17	65	230	16	4
GXR4180	□	18	65	250	16	4
GXR4200	□	20	75	250	20	4

標準切削条件表 Recommended cutting conditions

GSR	GSL	GXR
レギュラー刃長 Regular	ロング刃長 Long	ロングシャンク Long Shank

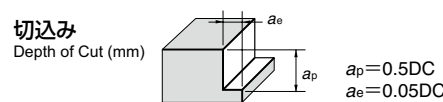

被削材 Work material	グラファイト Graphite	鋳鉄 Cast irons FC, FCD	非鉄金属、アルミ、銅合金 Non-ferrous-metals, Aluminium, Cu-alloys			
硬度 Hardness	150 ~ 200HB					
切削条件 Cutting Conditions	切削速度 Cutting speed $v_c=200 \sim 250$ m/min	切削速度 Cutting speed $v_c=50 \sim 100$ m/min	切削速度 Cutting speed $v_c=150 \sim 100$ m/min			
	回転数 Revolution min^{-1}	送り速度 Table Speed mm/min	回転数 Revolution min^{-1}			
外径DC Tool dia. (mm)	送り速度 Table Speed mm/min	回転数 Revolution min^{-1}	送り速度 Table Speed mm/min			
2	36,000	1,000 ~ 1,200	11,000	300 ~ 350	25,000	600 ~ 700
4	18,000	1,200 ~ 1,500	5,600	350 ~ 450	12,000	700 ~ 900
6	12,000	1,400 ~ 1,800	3,700	400 ~ 500	8,500	800 ~ 1,000
8	9,000	2,000 ~ 2,500	2,800	600 ~ 700	6,400	1,200 ~ 1,400
10	7,200	2,500 ~ 3,000	2,200	700 ~ 800	5,100	1,400 ~ 1,600
12	6,000	2,500 ~ 3,000	1,800	700 ~ 800	4,200	1,400 ~ 1,600
15	4,800	2,000 ~ 2,500	1,500	600 ~ 700	3,400	1,200 ~ 1,400
16	4,500	2,000 ~ 2,500	1,400	600 ~ 700	3,200	1,200 ~ 1,400
18	4,000	1,600 ~ 2,000	1,200	500 ~ 600	2,800	1,000 ~ 1,200
20	3,600	1,400 ~ 1,700	1,100	400 ~ 500	2,500	800 ~ 1,000

[注意] ①上記に切削条件を示しますが、被削材の硬さ、切込み、ツーリング、機械の状態により条件を増減してください。
②汎用機、NCフライス盤で加工される場合は、切りくずの飛散防止のため、吸引機のご使用、または湿式切削を推奨します。乾式と湿式の寿命差はありません。
③回転数が不足する場合は、増速スピンドルのご使用を推奨します。

[Note] ①Standard cutting conditions are described above, but allowance should be made for these conditions according to hardness of work materials, depth of cut, tooling, and conditions of machines.
②When machining with a general purpose machine or an NC milling machine, it is recommended to use an aspirator or to perform wet cutting in order to prevent chips from scattering. There is no difference in life of end mills between dry cutting and wet cutting.
③In the case of insufficient revolution speed, it is recommended to use a high speed milling attachment.

GSR, GSL, GXRの対応被削材

Applicable work material of GSR, GSL, GXR

炭素鋼 合金鋼 Carbon steel Alloy steel	プリハードン ド鋼 Pre-hardened steel	高硬度 Hardened steel	ステン レス鋼 Stainless steel	チタン合金 耐熱合金 Titanium alloy Heat-resistant alloy	銅合金 Copper alloy	アルミ 合金 Aluminum alloy
> 45HRC ≤ 45HRC	> 55HRC ≤ 55HRC	> 65HRC				

グラファイト用 For Graphite

Carbide End Mills
Stocked by Specified distributor

Carbide End Mills for Graphite

超硬グラファイト用エンドミル

レギュラー刃長 Regular



専用機用 エアホール付き
For Custom with air-hole

外径公差
DC < 6 : 0 ~ -0.03
6 ≤ DC : 0 ~ -0.04



(mm)

4枚刃
4Flutes



ロングシャंक Long Shank



専用機用 エアホール付き
For Custom with air-hole

外径公差
DC < 6 : 0 ~ -0.03
6 ≤ DC : 0 ~ -0.04



(mm)

4枚刃
4Flutes



GSE4

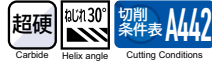

商品コード Item code	在庫 Stock	寸法 Size (mm)			
		外径 Tool dia.	刃長 Flute length	全長 Overall length	シャंक径 Shank dia.
※ GSE4020	<input type="checkbox"/>	2	10	80	4
※ GSE4030	<input type="checkbox"/>	3	15	80	4
※ GSE4040	<input type="checkbox"/>	4	20	80	4
GSE4050	<input type="checkbox"/>	5	30	100	6
GSE4060	<input type="checkbox"/>	6	30	100	6
GSE4070	<input type="checkbox"/>	7	30	100	6
GSE4080	<input type="checkbox"/>	8	40	110	8
GSE4090	<input type="checkbox"/>	9	40	110	8
GSE4100	<input type="checkbox"/>	10	50	120	10
GSE4110	<input type="checkbox"/>	11	50	120	10
GSE4120	<input type="checkbox"/>	12	55	130	12
GSE4130	<input type="checkbox"/>	13	55	130	12
GSE4160	<input type="checkbox"/>	16	60	150	16
GSE4200	<input type="checkbox"/>	20	60	150	20
GSE4210	<input type="checkbox"/>	21	60	150	20
GSE4250	<input type="checkbox"/>	25	60	180	25
GSE4300	<input type="checkbox"/>	30	60	200	32

GSD4

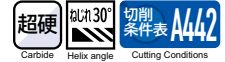

商品コード Item code	在庫 Stock	寸法 Size (mm)			
		外径 Tool dia.	刃長 Flute length	全長 Overall length	シャंक径 Shank dia.
※ GSD4020	<input type="checkbox"/>	2	10	100	4
※ GSD4030	<input type="checkbox"/>	3	15	100	4
※ GSD4040	<input type="checkbox"/>	4	20	100	4
GSD4050	<input type="checkbox"/>	5	30	120	6
GSD4060	<input type="checkbox"/>	6	30	150	6
GSD4070	<input type="checkbox"/>	7	30	150	6
GSD4080	<input type="checkbox"/>	8	40	150	8
GSD4090	<input type="checkbox"/>	9	40	150	8
GSD4100	<input type="checkbox"/>	10	50	180	10
GSD4110	<input type="checkbox"/>	11	50	180	10
GSD4120	<input type="checkbox"/>	12	55	200	12
GSD4130	<input type="checkbox"/>	13	55	200	12
GSD4160	<input type="checkbox"/>	16	60	250	16
GSD4200	<input type="checkbox"/>	20	60	250	20
GSD4210	<input type="checkbox"/>	21	60	250	20
GSD4250	<input type="checkbox"/>	25	60	250	25
GSD4300	<input type="checkbox"/>	30	60	250	32

標準切削条件表 Recommended cutting conditions

GSE レギュラー刃長 Regular

商品コード Item Code	切削条件 Conditions	
	回転数 Revolution (min ⁻¹)	送り速度 Table speed (mm/min)
GSE4020	15,000	600
GSE4030	15,000	900
GSE4040	15,000	1,200
GSE4050	15,000	1,500
GSE4060	15,000	1,800
GSE4070	15,000	2,100
GSE4080	13,900	2,200
GSE4090	12,400	2,200
GSE4100	11,100	2,200
GSE4110	10,100	2,200
GSE4120	9,300	2,200
GSE4130	8,600	2,200
GSE4160	7,000	2,200
GSE4200	5,600	2,200
GSE4210	5,300	2,200
GSE4250	4,500	2,200
GSE4300	3,700	2,200

GSD ロングシャंक Long Shank

商品コード Item Code	切削条件 Conditions	
	回転数 Revolution (min ⁻¹)	送り速度 Table speed (mm/min)
GSD4020	15,000	300
GSD4030	15,000	450
GSD4040	15,000	600
GSD4050	15,000	750
GSD4060	15,000	900
GSD4070	15,000	1,000
GSD4080	13,900	1,100
GSD4090	12,400	1,100
GSD4100	11,100	1,100
GSD4110	10,100	1,100
GSD4120	9,300	1,100
GSD4130	8,600	1,100
GSD4160	7,000	1,100
GSD4200	5,600	1,100
GSD4210	5,300	1,100
GSD4250	4,500	1,100
GSD4300	3,700	1,100

GSE、GSDの対応被削材 Applicable work material of GSE, GSD

炭素鋼 合金鋼 Carbon steel Alloy steel	プリハー ド鋼 Pre-hardened steel	高硬度 Hardened steel	ステン レス鋼 Stainless steel	チタン合金 耐熱合金 Titanium alloy Heat-resistant alloy	銅合金 Copper alloy	アルミ 合金 Aluminum alloy
	> 45HRC ≤ 45HRC	> 55HRC ≤ 65HRC	> 65HRC			

グラファイト用 for Graphite

□印：特定代理店在庫です。弊社営業へお問合せください。
□ : Stocked by specified distributor. Contact with our sales department.

※印：エアホールなしとなっています。
※ : Without air hole.

Epoch Taper エポックテーパ

2枚刃 2 Flutes

テーパー 仕上げ 超硬 C ねじり30° 切削条件表 A443

外径公差 0 -0.03 h6 (mm)

片角公差: ± 5' Tolerance on angle



4枚刃 4 Flutes

テーパー 仕上げ 超硬 C ねじり30° 切削条件表 A443

外径公差 0 -0.03 h6 (mm)

片角公差: ± 5' Tolerance on Angle



HTE2-C

商品コード Item code	在庫 Stock	寸法 Size (mm)					
		外径 Tool dia.	ねじり角 Taper angle on side	刃長 Flute length	大端径 Large side dia.	全長 Overall length	シャンク径 Shank dia.
HTE2010-05-C	□	1	30'	4	1.07	50	4
HTE2010-10-C	□	1	1°	4	1.14	50	4
HTE2010-15-C	□	1	1°30'	4	1.21	50	4
HTE2010-20-C	□	1	2°	4	1.28	50	4
HTE2010-30-C	□	1	3°	4	1.42	50	4
HTE2010-50-C	□	1	5°	4	1.7	50	4
HTE2015-05-C	□	1.5	30'	5	1.59	50	4
HTE2015-10-C	□	1.5	1°	5	1.67	50	4
HTE2015-15-C	□	1.5	1°30'	5	1.76	50	4
HTE2015-20-C	□	1.5	2°	5	1.85	50	4
HTE2015-30-C	□	1.5	3°	5	2.02	50	4
HTE2015-50-C	□	1.5	5°	5	2.37	50	4
HTE2020-05-C	□	2	30'	6	2.1	50	4
HTE2020-10-C	□	2	1°	6	2.21	50	4
HTE2020-15-C	□	2	1°30'	6	2.31	50	4
HTE2020-20-C	□	2	2°	6	2.42	50	4
HTE2020-30-C	□	2	3°	6	2.63	50	4
HTE2020-50-C	□	2	5°	6	3.05	50	4
HTE2025-05-C	□	2.5	30'	8	2.64	50	4
HTE2025-10-C	□	2.5	1°	8	2.78	50	4
HTE2025-15-C	□	2.5	1°30'	8	2.92	50	4
HTE2025-20-C	□	2.5	2°	8	3.06	50	4
HTE2025-30-C	□	2.5	3°	8	3.34	50	4
HTE2025-50-C	□	2.5	5°	8	3.9	50	4
HTE2030-05-C	□	3	30'	13	3.23	60	6
HTE2030-10-C	□	3	1°	13	3.45	60	6
HTE2030-15-C	□	3	1°30'	13	3.68	60	6
HTE2030-20-C	□	3	2°	18	4.26	60	6
HTE2030-30-C	□	3	3°	18	4.89	60	6
HTE2030-50-C	□	3	5°	17.1	6	60	6

HTE4-C

商品コード Item code	在庫 Stock	寸法 Size (mm)					
		外径 Tool dia.	ねじり角 Taper angle on side	刃長 Flute length	大端径 Large side dia.	全長 Overall length	シャンク径 Shank dia.
HTE4030-05-C	□	3	30'	13	3.23	60	6
HTE4030-10-C	□	3	1°	13	3.45	60	6
HTE4030-15-C	□	3	1°30'	13	3.68	60	6
HTE4030-20-C	□	3	2°	18	4.26	60	6
HTE4030-30-C	□	3	3°	18	4.89	60	6
HTE4030-50-C	□	3	5°	17.1	6	60	6
HTE4040-05-C	□	4	30'	16	4.28	60	6
HTE4040-10-C	□	4	1°	16	4.56	60	6
HTE4040-15-C	□	4	1°30'	16	4.84	60	6
HTE4040-20-C	□	4	2°	21	5.47	60	6
HTE4040-30-C	□	4	3°	21	6.2	70	6
HTE4040-50-C	□	4	5°	21	7.67	70	6
HTE4050-05-C	□	5	30'	19	5.33	70	6
HTE4050-10-C	□	5	1°	19	5.66	70	6
HTE4050-15-C	□	5	1°30'	19.1	6	70	6
HTE4050-20-C	□	5	2°	25	6.75	70	6
HTE4050-30-C	□	5	3°	25	7.62	70	6
HTE4050-50-C	□	5	5°	25	9.37	75	8
HTE4060-05-C	□	6	30'	19	6.33	70	6
HTE4060-10-C	□	6	1°	19	6.66	70	6
HTE4060-15-C	□	6	1°30'	19	6.99	70	6
HTE4060-20-C	□	6	2°	25	7.75	70	6
HTE4060-30-C	□	6	3°	25	8.62	75	8
HTE4060-50-C	□	6	5°	25	10.37	90	10
HTE4080-05-C	□	8	30'	22	8.38	75	8
HTE4080-10-C	□	8	1°	22	8.77	75	8
HTE4080-15-C	□	8	1°30'	22	9.15	75	8
HTE4080-20-C	□	8	2°	30	10.1	90	10
HTE4080-30-C	□	8	3°	30	11.14	90	10
HTE4080-50-C	□	8	5°	30	13.25	90	12
HTE2100-05-C	□	10	30'	22	10.38	90	10
HTE2100-10-C	□	10	1°	22	10.77	90	10
HTE2100-15-C	□	10	1°30'	22	11.15	90	10
HTE2100-20-C	□	10	2°	30	12.1	90	10
HTE2100-30-C	□	10	3°	30	13.14	90	12
HTE2100-50-C	□	10	5°	30	15.25	90	12
HTE4100-05-C	□	10	30'	22	10.38	90	10
HTE4100-10-C	□	10	1°	22	10.77	90	10
HTE4100-15-C	□	10	1°30'	22	11.15	90	10
HTE4100-20-C	□	10	2°	30	12.1	90	10
HTE4100-30-C	□	10	3°	30	13.14	90	12
HTE4100-50-C	□	10	5°	30	15.25	90	12

○ HTE2-C、HTE4-Cの対応被削材 Applicable work material of HTE2-C, HTE4-C

炭素鋼 合金鋼 Carbon steel Alloy steel	プリハードン鋼 Pre-hardened steel ≤ 45HRC	高硬度 Hardened steel			ステンレス鋼 Stainless steel	チタン合金 耐熱合金 Titanium alloy Heat-resistant alloy	銅合金 Copper alloy	アルミ合金 Aluminum alloy
		> 45HRC ≤ 55HRC	> 55HRC ≤ 65HRC	> 65HRC				
○	○	○	○	○	○	○	○	

○ 標準切削条件表 Recommended cutting conditions

HTE2-C

HTE4-C (注①)

<側面切削> Side milling

被削材 Work material	炭素鋼・合金鋼 Carbon steels, Alloy steels (~30HRC)		工具鋼・プリハードン鋼 Tool steels, Pre-hardened steels (30~40HRC)		プリハードン鋼・焼入れ鋼 Pre-hardened steels, Hardened steels (40~50HRC)	
	切込み Depth of cut (mm)	ap=2.5DC以下 or less	ae=0.05DC以下 or less	ap=2.5DC以下 or less	ae=0.05DC以下 or less	ap=2.5DC以下 or less
外径DC Tool dia.(mm)	回転数 n (min ⁻¹)	送り速度 vf (mm/min)	回転数 n (min ⁻¹)	送り速度 vf (mm/min)	回転数 n (min ⁻¹)	送り速度 vf (mm/min)
φ1	13,000	65	9,500	50	6,400	30
φ2	6,400	65	4,800	50	3,200	30
φ3	4,200	65	3,200	50	2,100	30
φ4	3,200	65	2,400	50	1,600	30
φ5	2,500	75	1,900	55	1,300	35
φ6	2,100	80	1,600	60	1,100	40
φ8	1,600	80	1,200	60	800	35
φ10	1,300	75	950	55	640	30

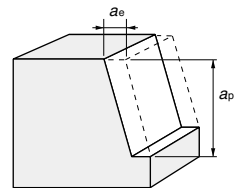

[注意]

- ① 上表は2枚刃、側面仕上げ切削時の条件表です。4枚刃の場合は、送り速度を2倍にしてください。
- ② 被削材、加工形状に合わせて、適切なクーラントを使用してください。
- ③ 機械剛性等により、びびり等が発生する場合は、回転数と送り速度を同じ比率で下げてください。

[Note]

- ① The above table shows the cutting conditions for side finish milling using 2 flutes. For 4 flutes, the feed rate should be doubled.
- ② Use the appropriate coolant for the work material and machining shape.
- ③ Depending on the machine rigidity, etc., if chattering occurs, reduce both the rotation speed and feed rate by the same ratio.

Carbide End Mills

Stocked by Specified distributor

Carbide Taper End Mills

超硬テーパエンドミル

レギュラー刃長 Regular

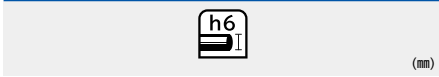

ロング刃長 Long



テーパボール Taper Ball



超硬エンドミル
特定代理店在庫品

HTS

商品コード Item code	在庫 Stock	寸法 Size (mm)					刃数 No. of flutes
		外径 Tool dia.	テーパ角 Taper angle on side	刃長 Flute length	全長 Overall length	シャンク径 Shank dia.	
HTS2030-1	<input type="checkbox"/>	3	30'	8	45	4	2
HTS2030-2	<input type="checkbox"/>	3	1°	8	45	4	2
HTS2030-3	<input type="checkbox"/>	3	1°30'	8	45	4	2
HTS2030-4	<input type="checkbox"/>	3	2°	8	45	4	2
HTS2030-5	<input type="checkbox"/>	3	2°30'	8	45	4	2
HTS2030-6	<input type="checkbox"/>	3	3°	8	45	4	2
HTS2040-1	<input type="checkbox"/>	4	30'	12	45	4	2
HTS2040-2	<input type="checkbox"/>	4	1°	12	45	4	2
HTS2040-3	<input type="checkbox"/>	4	1°30'	12	45	4	2
HTS2040-4	<input type="checkbox"/>	4	2°	12	45	4	2
HTS2040-5	<input type="checkbox"/>	4	2°30'	12	45	4	2
HTS2040-6	<input type="checkbox"/>	4	3°	12	45	4	2
HTS2050-1	<input type="checkbox"/>	5	30'	15	50	6	2
HTS2050-2	<input type="checkbox"/>	5	1°	15	50	6	2
HTS2050-3	<input type="checkbox"/>	5	1°30'	15	50	6	2
HTS2050-4	<input type="checkbox"/>	5	2°	15	50	6	2
HTS2050-5	<input type="checkbox"/>	5	2°30'	15	50	6	2
HTS2050-6	<input type="checkbox"/>	5	3°	15	50	6	2
HTS2060-1	<input type="checkbox"/>	6	30'	18	60	6	2
HTS2060-2	<input type="checkbox"/>	6	1°	18	60	6	2
HTS2060-3	<input type="checkbox"/>	6	1°30'	18	60	6	2
HTS2060-4	<input type="checkbox"/>	6	2°	18	60	6	2
HTS2060-5	<input type="checkbox"/>	6	2°30'	18	60	6	2
HTS2060-6	<input type="checkbox"/>	6	3°	18	60	6	2
HTS2080-1	<input type="checkbox"/>	8	30'	24	70	8	2
HTS2080-2	<input type="checkbox"/>	8	1°	24	70	8	2
HTS2080-3	<input type="checkbox"/>	8	1°30'	24	70	8	2
HTS2080-4	<input type="checkbox"/>	8	2°	24	70	8	2
HTS2080-5	<input type="checkbox"/>	8	2°30'	24	70	10	2
HTS2080-6	<input type="checkbox"/>	8	3°	24	70	10	2
HTS4100-1	<input type="checkbox"/>	10	30'	30	75	10	4
HTS4100-2	<input type="checkbox"/>	10	1°	30	75	10	4
HTS4100-3	<input type="checkbox"/>	10	1°30'	30	75	10	4
HTS4100-4	<input type="checkbox"/>	10	2°	30	75	10	4
HTS4100-5	<input type="checkbox"/>	10	2°30'	30	75	12	4
HTS4100-6	<input type="checkbox"/>	10	3°	30	75	12	4
HTS4120-1	<input type="checkbox"/>	12	30'	36	90	12	4
HTS4120-2	<input type="checkbox"/>	12	1°	36	90	12	4
HTS4120-3	<input type="checkbox"/>	12	1°30'	36	90	12	4
HTS4120-4	<input type="checkbox"/>	12	2°	36	90	12	4
HTS4120-5	<input type="checkbox"/>	12	2°30'	36	90	12	4
HTS4120-6	<input type="checkbox"/>	12	3°	36	90	12	4

HTSL

商品コード Item code	在庫 Stock	寸法 Size (mm)					シャンク径 Shank dia.
		外径 Tool dia.	テーパ角 Taper angle on side	刃長 Flute length	全長 Overall length		
HTSL2010-1	<input type="checkbox"/>	1	30'	7	55	4	
HTSL2010-2	<input type="checkbox"/>	1	1°	7	55	4	
HTSL2010-3	<input type="checkbox"/>	1	1°30'	7	55	4	
HTSL2010-4	<input type="checkbox"/>	1	2°	7	55	4	
HTSL2010-5	<input type="checkbox"/>	1	2°30'	7	55	4	
HTSL2010-6	<input type="checkbox"/>	1	3°	7	55	4	
HTSL2015-1	<input type="checkbox"/>	1.5	30'	10	55	4	
HTSL2015-2	<input type="checkbox"/>	1.5	1°	10	55	4	
HTSL2015-3	<input type="checkbox"/>	1.5	1°30'	10	55	4	
HTSL2015-4	<input type="checkbox"/>	1.5	2°	10	55	4	
HTSL2015-5	<input type="checkbox"/>	1.5	2°30'	10	55	4	
HTSL2015-6	<input type="checkbox"/>	1.5	3°	10	55	4	
HTSL2020-1	<input type="checkbox"/>	2	30'	14	55	4	
HTSL2020-2	<input type="checkbox"/>	2	1°	14	55	4	
HTSL2020-3	<input type="checkbox"/>	2	1°30'	14	55	4	
HTSL2020-4	<input type="checkbox"/>	2	2°	14	55	4	
HTSL2020-5	<input type="checkbox"/>	2	2°30'	14	55	4	
HTSL2020-6	<input type="checkbox"/>	2	3°	14	55	4	
HTSL2025-1	<input type="checkbox"/>	2.5	30'	17	60	4	
HTSL2025-2	<input type="checkbox"/>	2.5	1°	17	60	4	
HTSL2025-3	<input type="checkbox"/>	2.5	1°30'	17	60	4	
HTSL2025-4	<input type="checkbox"/>	2.5	2°	17	60	4	
HTSL2025-5	<input type="checkbox"/>	2.5	2°30'	17	60	4	
HTSL2025-6	<input type="checkbox"/>	2.5	3°	17	60	6	
HTSL2030-1	<input type="checkbox"/>	3	30'	20	65	4	
HTSL2030-2	<input type="checkbox"/>	3	1°	20	65	4	
HTSL2030-3	<input type="checkbox"/>	3	1°30'	20	65	6	
HTSL2030-4	<input type="checkbox"/>	3	2°	20	65	6	
HTSL2030-5	<input type="checkbox"/>	3	2°30'	20	65	6	
HTSL2030-6	<input type="checkbox"/>	3	3°	20	65	6	

HTSB

商品コード Item code	在庫 Stock	寸法 Size (mm)					刃数 No. of flutes
		外径 Tool dia.	テーパ角 Taper angle on side	刃長 Flute length	全長 Overall length	シャンク径 Shank dia.	
HTSB2030-1	<input type="checkbox"/>	3	30'	8	45	4	2
HTSB2030-2	<input type="checkbox"/>	3	1°	8	45	4	2
HTSB2030-3	<input type="checkbox"/>	3	1°30'	8	45	4	2
HTSB2030-4	<input type="checkbox"/>	3	2°	8	45	4	2
HTSB2030-5	<input type="checkbox"/>	3	2°30'	8	45	4	2
HTSB2030-6	<input type="checkbox"/>	3	3°	8	45	4	2
HTSB2040-1	<input type="checkbox"/>	4	30'	12	45	4	2
HTSB2040-2	<input type="checkbox"/>	4	1°	12	45	4	2
HTSB2040-3	<input type="checkbox"/>	4	1°30'	12	45	4	2
HTSB2040-4	<input type="checkbox"/>	4	2°	12	45	4	2
HTSB2040-5	<input type="checkbox"/>	4	2°30'	12	45	4	2
HTSB2040-6	<input type="checkbox"/>	4	3°	12	45	4	2
HTSB2050-1	<input type="checkbox"/>	5	30'	15	50	6	2
HTSB2050-2	<input type="checkbox"/>	5	1°	15	50	6	2
HTSB2050-3	<input type="checkbox"/>	5	1°30'	15	50	6	2
HTSB2050-4	<input type="checkbox"/>	5	2°	15	50	6	2
HTSB2050-5	<input type="checkbox"/>	5	2°30'	15	50	6	2
HTSB2050-6	<input type="checkbox"/>	5	3°	15	50	6	2
HTSB2060-1	<input type="checkbox"/>	6	30'	18	60	6	2
HTSB2060-2	<input type="checkbox"/>	6	1°	18	60	6	2
HTSB2060-3	<input type="checkbox"/>	6	1°30'	18	60	6	2
HTSB2060-4	<input type="checkbox"/>	6	2°	18	60	6	2
HTSB2060-5	<input type="checkbox"/>	6	2°30'	18	60	6	2
HTSB2060-6	<input type="checkbox"/>	6	3°	18	60	6	2
HTSB2080-1	<input type="checkbox"/>	8	30'	24	70	8	2
HTSB2080-2	<input type="checkbox"/>	8	1°	24	70	8	2
HTSB2080-3	<input type="checkbox"/>	8	1°30'	24	70	8	2
HTSB2080-4	<input type="checkbox"/>	8	2°	24	70	8	2
HTSB2080-5	<input type="checkbox"/>	8	2°30'	24	70	10	2
HTSB2080-6	<input type="checkbox"/>	8	3°	24	70	10	2
HTSB4100-1	<input type="checkbox"/>	10	30'	30	75	10	4
HTSB4100-2	<input type="checkbox"/>	10	1°	30	75	10	4
HTSB4100-3	<input type="checkbox"/>	10	1°30'	30	75	10	4
HTSB4100-4	<input type="checkbox"/>	10	2°	30	75	10	4
HTSB4100-5	<input type="checkbox"/>	10	2°30'	30	75	12	4
HTSB4100-6	<input type="checkbox"/>	10	3°	30	75	12	4
HTSB4120-1	<input type="checkbox"/>	12	30'	36	90	12	4
HTSB4120-2	<input type="checkbox"/>	12	1°	36	90	12	4
HTSB4120-3	<input type="checkbox"/>	12	1°30'	36	90	12	4
HTSB4120-4	<input type="checkbox"/>	12	2°	36	90	12	4
HTSB4120-5	<input type="checkbox"/>	12	2°30'	36	90	12	4
HTSB4120-6	<input type="checkbox"/>	12	3°	36	90	12	4

HTS、HTSL、HTSB、FE4の対応被削材

Applicable work material of HTS, HTSL, HTSB, FE4

炭素鋼 合金鋼 Carbon steel Alloy steel	プリハー ド鋼 Pre-hardened steel ≤ 45HRC	高硬度 Hardened steel			ステン レス鋼 Stainless steel	チタン合金 耐熱合金 Titanium alloy Heat-resistant alloy	銅合金 Copper alloy	アルミ 合金 Aluminum alloy
		> 45HRC ≤ 55HRC	> 55HRC ≤ 65HRC	> 65HRC				
<input type="checkbox"/>	<input type="checkbox"/>	<input type="checkbox"/>	<input type="checkbox"/>	<input type="checkbox"/>	<input type="checkbox"/>	<input type="checkbox"/>	<input type="checkbox"/>	

□印：特定代理店在庫です。弊社営業へお問合せください。○：Stocked by specified distributor. Contact with our sales department.

GTBの対応被削材

Applicable work material of GTB

炭素鋼 合金鋼 Carbon steel Alloy steel	プリハー ド鋼 Pre-hardened steel ≤ 45HRC	高硬度 Hardened steel			ステン レス鋼 Stainless steel	チタン合金 耐熱合金 Titanium alloy Heat-resistant alloy	銅合金 Copper alloy	アルミ 合金 Aluminum alloy
		> 45HRC ≤ 55HRC	> 55HRC ≤ 65HRC	> 65HRC				
グラファイト用 for Graphite								

Carbide End Mills for Mold 超硬型彫用エンドミル

Carbide End Mills for Graphite 超硬グラファイト用エンドミル

テーパボール刃 Taper Ball End

超硬 Carbide ねじり角 Helix angle

半径テーパ RADIUS TAPER 中仕上げ SEMI FINISHING 仕上げ FINISHING

h7 (mm)

ショート刃長 Short

超硬 Carbide ねじり角 Helix angle 切削条件表 A445 Cutting Conditions

溝 Slotting 彫込み Die-sinking 曲面 Profiling R Radius ヘリカル Helical 荒荒 Roughing 中仕上げ SEMI FINISHING 仕上げ FINISHING

h6 (mm)



汎用機用 エアホールなし
For General without air-hole

FE4 (°)

商品コード Item code	在庫 Stock	寸法 Size (mm)				
		ボール半径 Ball radius	ねじり角 Taper angle on side	刃長 Flute length	全長 Overall length	シャンク径 Shank dia.
FE406-2(5°)	□	1	5°	22	70	6
FE406-3(5°)	□	1.5	5°	18	70	6
FE406-4(5°)	□	2	5°	12	70	6
FE408-2(5°)	□	1	5°	34	70	8
FE408-3(5°)	□	1.5	5°	29	70	8
FE408-4(5°)	□	2	5°	24	70	8
FE410-3(5°)	□	1.5	5°	40	80	10
FE410-4(5°)	□	2	5°	36	80	10
FE410-5(5°)	□	2.5	5°	30	80	10
FE412-3(5°)	□	1.5	5°	50	100	12
FE412-4(5°)	□	2	5°	45	100	12
FE412-6(5°)	□	3	5°	36	100	12
FE406-2(7°)	□	1	7°	16	70	6
FE406-3(7°)	□	1.5	7°	13	70	6
FE406-4(7°)	□	2	7°	9	70	6
FE408-2(7°)	□	1	7°	24	70	8
FE408-3(7°)	□	1.5	7°	21	70	8
FE408-4(7°)	□	2	7°	17	70	8
FE410-3(7°)	□	1.5	7°	29	80	10
FE410-4(7°)	□	2	7°	25	80	10
FE410-5(7°)	□	2.5	7°	22	80	10
FE412-3(7°)	□	1.5	7°	37	100	12
FE412-4(7°)	□	2	7°	33	100	12
FE412-6(7°)	□	3	7°	26	100	12

GTB2 (°)

商品コード Item code	在庫 Stock	寸法 Size (mm)				
		外径 Tool dia.	ねじり角 Taper angle on side	刃長 Flute length	全長 Overall length	シャンク径 Shank dia.
GTB2020-05	□	2	30'	12	100	4
GTB2020-10	□	2	1°	12	100	4
GTB2020-15	□	2	1°30'	12	100	4
GTB2020-20	□	2	2°	12	100	4
GTB2020-25	□	2	2°30'	12	100	4
GTB2020-30	□	2	3°	12	100	4
GTB2020-50	□	2	5°	12	100	4
GTB2020-70	□	2	7°	12	100	4
GTB2030-05	□	3	30'	18	100	4
GTB2030-10	□	3	1°	18	100	4
GTB2030-15	□	3	1°30'	18	100	4
GTB2030-20	□	3	2°	18	100	4
GTB2030-25	□	3	2°30'	18	100	4
GTB2030-30	□	3	3°	18	100	4
GTB2030-50	□	3	5°	18	100	6
GTB2030-70	□	3	7°	18	100	6
GTB2040-05	□	4	30'	25	120	4
GTB2040-10	□	4	1°	25	120	4
GTB2040-15	□	4	1°30'	25	120	4
GTB2040-20	□	4	2°	25	120	4
GTB2040-25	□	4	2°30'	25	120	6
GTB2040-30	□	4	3°	25	120	6
GTB2040-50	□	4	5°	25	120	8
GTB2040-70	□	4	7°	25	120	8
GTB2050-05	□	5	30'	30	140	6
GTB2050-10	□	5	1°	30	140	6
GTB2050-15	□	5	1°30'	30	140	6
GTB2050-20	□	5	2°	30	140	6
GTB2050-25	□	5	2°30'	30	140	6
GTB2050-30	□	5	3°	30	140	6
GTB2050-50	□	5	5°	30	140	10
GTB2050-70	□	5	7°	30	140	12
GTB2060-05	□	6	30'	35	140	6
GTB2060-10	□	6	1°	35	140	6
GTB2060-15	□	6	1°30'	35	140	6
GTB2060-20	□	6	2°	35	140	8
GTB2060-25	□	6	2°30'	35	140	8
GTB2060-30	□	6	3°	35	140	8
GTB2060-50	□	6	5°	35	140	10
GTB2060-70	□	6	7°	35	140	12

商品コード Item code	在庫 Stock	寸法 Size (mm)				
		外径 Tool dia.	ねじり角 Taper angle on side	刃長 Flute length	全長 Overall length	シャンク径 Shank dia.
GTB2080-05	□	8	30'	40	150	8
GTB2080-10	□	8	1°	40	150	8
GTB2080-15	□	8	1°30'	40	150	8
GTB2080-20	□	8	2°	40	150	10
GTB2080-25	□	8	2°30'	40	150	10
GTB2080-30	□	8	3°	40	150	10
GTB2080-50	□	8	5°	40	150	12
GTB2080-70	□	8	7°	40	150	16
GTB2100-05	□	10	30'	50	180	10
GTB2100-10	□	10	1°	50	180	10
GTB2100-15	□	10	1°30'	50	180	12
GTB2100-20	□	10	2°	50	180	12
GTB2100-25	□	10	2°30'	50	180	12
GTB2100-30	□	10	3°	50	180	12
GTB2100-50	□	10	5°	50	180	16
GTB2100-70	□	10	7°	50	180	20
GTB2120-05	□	12	30'	60	200	12
GTB2120-10	□	12	1°	60	200	12
GTB2120-15	□	12	1°30'	60	200	12
GTB2120-20	□	12	2°	60	200	16
GTB2120-25	□	12	2°30'	60	200	16
GTB2120-30	□	12	3°	60	200	16
GTB2120-50	□	12	5°	60	200	20
GTB2120-70	□	12	7°	60	200	25
GTB2140-05	□	14	30'	70	220	12
GTB2140-10	□	14	1°	70	220	16
GTB2140-15	□	14	1°30'	70	220	16
GTB2140-20	□	14	2°	70	220	16
GTB2140-25	□	14	2°30'	70	220	16
GTB2140-30	□	14	3°	70	220	20
GTB2140-50	□	14	5°	70	220	25
GTB2140-70	□	14	7°	70	220	25
GTB2160-05	□	16	30'	80	230	16
GTB2160-10	□	16	1°	80	230	16
GTB2160-15	□	16	1°30'	80	230	16
GTB2160-20	□	16	2°	80	230	20
GTB2160-25	□	16	2°30'	80	230	20
GTB2160-30	□	16	3°	80	230	20
GTB2160-50	□	16	5°	80	230	25
GTB2160-70	□	16	7°	80	230	32

標準切削条件表 Recommended cutting conditions

GTB

被削材 Work material	グラファイト Graphite		鋳鉄 Cast irons FC, FCD		非鉄金属、アルミ、銅合金 Non-ferrous-metal, Aluminium, Cu-alloys		
	切削速度 Cutting speed Vc=200~250m/min		切削速度 Cutting speed Vc=50~100m/min		切削速度 Cutting speed Vc=150~100m/min		
ボール半径 RE(mm)	外径 DC(mm)	回転数 Revolution min ⁻¹	送り速度 Table Speed mm/min	回転数 Revolution min ⁻¹	送り速度 Table Speed mm/min	回転数 Revolution min ⁻¹	送り速度 Table Speed mm/min
		RE1	2	44,000	800~1,000	11,000	250~300
RE2	4	22,000	1,000~1,300	5,600	300~400	12,500	600~800
RE3	6	15,000	1,200~1,500	3,700	350~450	8,500	700~900
RE4	8	11,000	1,800~2,000	2,800	550~600	6,400	1,100~1,200
RE5	10	8,800	2,000~2,500	2,200	600~700	5,100	1,200~1,400
RE6	12	7,300	2,000~2,500	1,800	600~700	4,200	1,200~1,400
RE7.5	15	5,800	1,800~2,000	1,500	550~600	3,400	1,100~1,200
RE8	16	5,500	1,600~1,800	1,400	500~600	3,200	1,000~1,200
RE9	18	4,900	1,600~1,700	1,200	400~500	2,800	800~1,000
RE10	20	4,400	1,200~1,400	1,100	350~450	2,500	700~900



【注意】

- 被削材、加工形状に合わせて、適切なクーラントを使用してください。
- 上記に切削条件を示しますが、被削材の硬さ、切込み、ツーリング、機械の状態により条件を増減してください。
- 汎用機、NCフライス盤で加工される場合は、切りくずの飛散防止のため、吸引機のご使用、または湿式切削を推奨します。乾式と湿式の寿命差はありません。
- 回転数が不足する場合は、増速スピンドルのご使用を推奨します。

【Note】

- Use the appropriate coolant for the work material and machining shape.
- Standard cutting conditions are described above, but allowance should be made for these conditions according to hardness of work materials, depth of cut, tooling, and conditions of machines.
- When machining with a general purpose machine or an NC milling machine, it is recommended to use an aspirator or to perform wet cutting in order to prevent chips from scattering. There is no difference in life of end mills between dry cutting and wet cutting.
- In the case of insufficient revolution speed, it is recommended to use a high speed milling attachment.

Epoch Rib Ball エポック リブボール

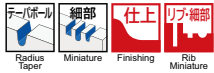

(mm)



EPRB○○○○○-○○○-C



超硬コーティング仕様の在庫品

商品コード Item code	在庫 Stock	寸法 Size (mm)						
		ボール半径 Ball radius	外径 Tool dia.	刃部テーパ半角 Taper angle on side	刃長 Flute length	大端径 Large edge dia.	全長 Overall length	シャンク径 Shank dia.
EPRB0604-05-C	<input type="checkbox"/>	0.3	0.6	30°	4	0.67	50	4
EPRB0606-05-C	<input type="checkbox"/>			30°	6	0.7	50	4
EPRB0604-07-C	<input type="checkbox"/>			45°	4	0.7	50	4
EPRB0606-07-C	<input type="checkbox"/>			45°	6	0.75	50	4
EPRB0604-10-C	<input type="checkbox"/>			1°	4	0.73	50	4
EPRB0606-10-C	<input type="checkbox"/>			1°	6	0.8	50	4
EPRB0604-15-C	<input type="checkbox"/>			1° 30'	4	0.79	50	4
EPRB0606-15-C	<input type="checkbox"/>			1° 30'	6	0.9	50	4
EPRB0604-20-C	<input type="checkbox"/>			2°	4	0.86	50	4
EPRB0606-20-C	<input type="checkbox"/>			2°	6	1	50	4
EPRB0806-05-C	<input type="checkbox"/>	0.4	0.8	30°	6	0.9	50	4
EPRB0808-05-C	<input type="checkbox"/>			30°	8	0.93	50	4
EPRB0810-05-C	<input type="checkbox"/>			30°	10	0.97	50	4
EPRB0806-07-C	<input type="checkbox"/>			45°	6	0.95	50	4
EPRB0808-07-C	<input type="checkbox"/>			45°	8	1	50	4
EPRB0810-07-C	<input type="checkbox"/>			45°	10	1.05	50	4
EPRB0806-10-C	<input type="checkbox"/>			1°	6	1	50	4
EPRB0808-10-C	<input type="checkbox"/>			1°	8	1.07	50	4
EPRB0810-10-C	<input type="checkbox"/>			1°	10	1.14	50	4
EPRB0806-15-C	<input type="checkbox"/>			1° 30'	6	1.09	50	4
EPRB0808-15-C	<input type="checkbox"/>	1° 30'	8	1.2	50	4		
EPRB0810-15-C	<input type="checkbox"/>	1° 30'	10	1.3	50	4		
EPRB0806-20-C	<input type="checkbox"/>	2°	6	1.19	50	4		
EPRB0808-20-C	<input type="checkbox"/>	2°	8	1.33	50	4		
EPRB0810-20-C	<input type="checkbox"/>	2°	10	1.47	50	4		
EPRB1008-05-C	<input type="checkbox"/>	0.5	1	30°	8	1.13	50	4
EPRB1010-05-C	<input type="checkbox"/>			30°	10	1.17	50	4
EPRB1012-05-C	<input type="checkbox"/>			30°	12	1.2	50	4
EPRB1016-05-C	<input type="checkbox"/>			30°	16	1.27	50	4
EPRB1008-07-C	<input type="checkbox"/>			45°	8	1.2	50	4
EPRB1010-07-C	<input type="checkbox"/>			45°	10	1.25	50	4
EPRB1012-07-C	<input type="checkbox"/>			45°	12	1.3	50	4
EPRB1008-10-C	<input type="checkbox"/>			1°	8	1.26	50	4
EPRB1010-10-C	<input type="checkbox"/>			1°	10	1.33	50	4
EPRB1012-10-C	<input type="checkbox"/>			1°	12	1.4	50	4
EPRB1016-10-C	<input type="checkbox"/>	1°	16	1.54	50	4		
EPRB1008-15-C	<input type="checkbox"/>	1° 30'	8	1.39	50	4		
EPRB1010-15-C	<input type="checkbox"/>	1° 30'	10	1.5	50	4		
EPRB1012-15-C	<input type="checkbox"/>	1° 30'	12	1.6	50	4		
EPRB1016-15-C	<input type="checkbox"/>	1° 30'	16	1.81	50	4		
EPRB1008-20-C	<input type="checkbox"/>	2°	8	1.53	50	4		
EPRB1010-20-C	<input type="checkbox"/>	2°	10	1.66	50	4		
EPRB1012-20-C	<input type="checkbox"/>	2°	12	1.8	50	4		
EPRB1016-20-C	<input type="checkbox"/>	2°	16	2.08	50	4		
EPRB1206-05-C	<input type="checkbox"/>	0.6	1.2	30°	6	1.29	50	4
EPRB1208-05-C	<input type="checkbox"/>			30°	8	1.33	50	4
EPRB1210-05-C	<input type="checkbox"/>			30°	10	1.37	50	4
EPRB1212-05-C	<input type="checkbox"/>			30°	12	1.4	50	4
EPRB1216-05-C	<input type="checkbox"/>			30°	16	1.47	50	4
EPRB1220-05-C	<input type="checkbox"/>			30°	20	1.54	60	4
EPRB1208-07-C	<input type="checkbox"/>			45°	8	1.39	50	4
EPRB1210-07-C	<input type="checkbox"/>			45°	10	1.45	50	4
EPRB1212-07-C	<input type="checkbox"/>			45°	12	1.5	50	4
EPRB1216-07-C	<input type="checkbox"/>			45°	16	1.6	50	4
EPRB1206-10-C	<input type="checkbox"/>	1°	6	1.39	50	4		
EPRB1208-10-C	<input type="checkbox"/>	1°	8	1.46	50	4		
EPRB1210-10-C	<input type="checkbox"/>	1°	10	1.53	50	4		
EPRB1212-10-C	<input type="checkbox"/>	1°	12	1.6	50	4		
EPRB1216-10-C	<input type="checkbox"/>	1°	16	1.74	50	4		
EPRB1220-10-C	<input type="checkbox"/>	1°	20	1.88	60	4		
EPRB1206-15-C	<input type="checkbox"/>	1° 30'	6	1.48	50	4		
EPRB1208-15-C	<input type="checkbox"/>	1° 30'	8	1.59	50	4		
EPRB1210-15-C	<input type="checkbox"/>	1° 30'	10	1.69	50	4		
EPRB1212-15-C	<input type="checkbox"/>	1° 30'	12	1.8	50	4		

商品コード Item code	在庫 Stock	寸法 Size (mm)								
		ボール半径 Ball radius	外径 Tool dia.	刃部テーパ半角 Taper angle on side	刃長 Flute length	大端径 Large edge dia.	全長 Overall length	シャンク径 Shank dia.		
EPRB1216-15-C	<input type="checkbox"/>	0.6	1.2	1° 30'	16	2.01	50	4		
EPRB1206-20-C	<input type="checkbox"/>			2°	6	1.58	50	4		
EPRB1208-20-C	<input type="checkbox"/>			2°	8	1.72	50	4		
EPRB1210-20-C	<input type="checkbox"/>			2°	10	1.86	50	4		
EPRB1212-20-C	<input type="checkbox"/>			2°	12	2	50	4		
EPRB1216-20-C	<input type="checkbox"/>			2°	16	2.28	50	4		
EPRB1220-20-C	<input type="checkbox"/>			2°	20	2.56	60	4		
EPRB1508-05-C	<input type="checkbox"/>			0.75	1.5	30°	8	1.63	50	4
EPRB1510-05-C	<input type="checkbox"/>					30°	10	1.66	50	4
EPRB1512-05-C	<input type="checkbox"/>					30°	12	1.7	50	4
EPRB1516-05-C	<input type="checkbox"/>	30°	16			1.77	50	4		
EPRB1520-05-C	<input type="checkbox"/>	30°	20			1.84	60	4		
EPRB1508-07-C	<input type="checkbox"/>	45°	8			1.69	50	4		
EPRB1510-07-C	<input type="checkbox"/>	45°	10			1.74	50	4		
EPRB1512-07-C	<input type="checkbox"/>	45°	12			1.8	50	4		
EPRB1516-07-C	<input type="checkbox"/>	45°	16			1.9	50	4		
EPRB1520-07-C	<input type="checkbox"/>	45°	20			2	60	4		
EPRB1508-10-C	<input type="checkbox"/>	1°	8	1.75	50	4				
EPRB1510-10-C	<input type="checkbox"/>	1°	10	1.82	50	4				
EPRB1512-10-C	<input type="checkbox"/>	1°	12	1.9	50	4				
EPRB1516-10-C	<input type="checkbox"/>	1°	16	2.03	50	4				
EPRB1520-10-C	<input type="checkbox"/>	1°	20	2.17	60	4				
EPRB1508-15-C	<input type="checkbox"/>	1° 30'	8	1.88	50	4				
EPRB1510-15-C	<input type="checkbox"/>	1° 30'	10	1.99	50	4				
EPRB1512-15-C	<input type="checkbox"/>	1° 30'	12	2.09	50	4				
EPRB1516-15-C	<input type="checkbox"/>	1° 30'	16	2.3	50	4				
EPRB1520-15-C	<input type="checkbox"/>	1° 30'	20	2.51	60	4				
EPRB1508-20-C	<input type="checkbox"/>	2°	8	2.01	50	4				
EPRB1510-20-C	<input type="checkbox"/>	2°	10	2.15	50	4				
EPRB1512-20-C	<input type="checkbox"/>	2°	12	2.29	50	4				
EPRB1516-20-C	<input type="checkbox"/>	2°	16	2.57	50	4				
EPRB1520-20-C	<input type="checkbox"/>	2°	20	2.85	60	4				
EPRB1608-05-C	<input type="checkbox"/>	0.8	1.6	30°	8	1.73	50	4		
EPRB1610-05-C	<input type="checkbox"/>			30°	10	1.76	50	4		
EPRB1612-05-C	<input type="checkbox"/>			30°	12	1.8	50	4		
EPRB1616-05-C	<input type="checkbox"/>			30°	16	1.87	50	4		
EPRB1620-05-C	<input type="checkbox"/>			30°	20	1.94	60	4		
EPRB1608-07-C	<input type="checkbox"/>			45°	8	1.79	50	4		
EPRB1610-07-C	<input type="checkbox"/>			45°	10	1.84	50	4		
EPRB1612-07-C	<input type="checkbox"/>			45°	12	1.89	50	4		
EPRB1616-07-C	<input type="checkbox"/>			45°	16	2	50	4		
EPRB1620-07-C	<input type="checkbox"/>			45°	20	2.1	60	4		
EPRB1608-10-C	<input type="checkbox"/>	1°	8	1.85	50	4				
EPRB1610-10-C	<input type="checkbox"/>	1°	10	1.92	50	4				
EPRB1612-10-C	<input type="checkbox"/>	1°	12	1.99	50	4				
EPRB1616-10-C	<input type="checkbox"/>	1°	16	2.13	50	4				
EPRB1620-10-C	<input type="checkbox"/>	1°	20	2.27	60	4				
EPRB1608-15-C	<input type="checkbox"/>	1° 30'	8	1.98	50	4				
EPRB1610-15-C	<input type="checkbox"/>	1° 30'	10	2.08	50	4				
EPRB1612-15-C	<input type="checkbox"/>	1° 30'	12	2.19	50	4				
EPRB1616-15-C	<input type="checkbox"/>	1° 30'	16	2.4	50	4				
EPRB1620-15-C	<input type="checkbox"/>	1° 30'	20	2.61	60	4				
EPRB1608-20-C	<input type="checkbox"/>	2°	8	2.1	50	4				
EPRB1610-20-C	<input type="checkbox"/>	2°	10	2.24	50	4				
EPRB1612-20-C	<input type="checkbox"/>	2°	12	2.38	50	4				
EPRB1616-20-C	<input type="checkbox"/>	2°	16	2.66	50	4				
EPRB1620-20-C	<input type="checkbox"/>	2°	20	2.94	60	4				
EPRB1808-05-C	<input type="checkbox"/>	0.9	1.8	30°	8	1.92	50	4		
EPRB1810-05-C	<input type="checkbox"/>			30°	10	1.96	50	4		
EPRB1812-05-C	<input type="checkbox"/>			30°	12	1.99	50	4		
EPRB1816-05-C	<input type="checkbox"/>			30°	16	2.06	50	4		
EPRB1820-05-C	<input type="checkbox"/>			30°	20	2.13	60	4		
EPRB1808-07-C	<input type="checkbox"/>			45°	8	1.99	50	4		
EPRB1810-07-C	<input type="checkbox"/>	45°	10	2.04	50	4				

□印：特定代理店在庫です。弊社営業へお問合せください。□：Stocked by specified distributor. Contact with our sales department.

EPRB○○○○-○○-C

商品コード Item code	在庫 Stock	寸法 Size (mm)						
		ボール半径 Ball radius	外径 Tool dia.	刃部テーパ半角 Taper angle on side	刃長 Flute length	大端径 Large edge dia.	全長 Overall length	シャンク径 Shank dia.
EPRB1812-07-C	<input type="checkbox"/>	0.9	1.8	45°	12	2.09	50	4
EPRB1816-07-C	<input type="checkbox"/>			45°	16	2.2	50	4
EPRB1820-07-C	<input type="checkbox"/>			45°	20	2.3	60	4
EPRB1808-10-C	<input type="checkbox"/>			1°	8	2.05	50	4
EPRB1810-10-C	<input type="checkbox"/>			1°	10	2.12	50	4
EPRB1812-10-C	<input type="checkbox"/>			1°	12	2.19	50	4
EPRB1816-10-C	<input type="checkbox"/>			1°	16	2.34	50	4
EPRB1820-10-C	<input type="checkbox"/>			1°	20	2.47	60	4
EPRB1808-15-C	<input type="checkbox"/>			1° 30'	8	2.17	50	4
EPRB1810-15-C	<input type="checkbox"/>			1° 30'	10	2.28	50	4
EPRB1812-15-C	<input type="checkbox"/>			1° 30'	12	2.38	50	4
EPRB1816-15-C	<input type="checkbox"/>			1° 30'	16	2.59	50	4
EPRB1820-15-C	<input type="checkbox"/>			1° 30'	20	2.8	60	4
EPRB1808-20-C	<input type="checkbox"/>			2°	8	2.3	50	4
EPRB1810-20-C	<input type="checkbox"/>			2°	10	2.44	50	4
EPRB1812-20-C	<input type="checkbox"/>			2°	12	2.58	50	4
EPRB1816-20-C	<input type="checkbox"/>			2°	16	2.86	50	4
EPRB1820-20-C	<input type="checkbox"/>			2°	20	3.14	60	4
EPRB2010-05-C	<input type="checkbox"/>	1	2	30°	10	2.16	50	4
EPRB2012-05-C	<input type="checkbox"/>			30°	12	2.19	50	4
EPRB2016-05-C	<input type="checkbox"/>			30°	16	2.26	50	4
EPRB2020-05-C	<input type="checkbox"/>			30°	20	2.33	60	4
EPRB2025-05-C	<input type="checkbox"/>			30°	25	2.42	60	4
EPRB2010-07-C	<input type="checkbox"/>			45°	10	2.24	50	4
EPRB2012-07-C	<input type="checkbox"/>			45°	12	2.29	50	4
EPRB2016-07-C	<input type="checkbox"/>			45°	16	2.39	50	4
EPRB2020-07-C	<input type="checkbox"/>			45°	20	2.5	60	4
EPRB2025-07-C	<input type="checkbox"/>			45°	25	2.63	60	4
EPRB2010-10-C	<input type="checkbox"/>			1°	10	2.31	50	4
EPRB2012-10-C	<input type="checkbox"/>			1°	12	2.38	50	4
EPRB2016-10-C	<input type="checkbox"/>			1°	16	2.52	50	4
EPRB2020-10-C	<input type="checkbox"/>			1°	20	2.66	60	4
EPRB2025-10-C	<input type="checkbox"/>			1°	25	2.84	60	4
EPRB2010-15-C	<input type="checkbox"/>			1° 30'	10	2.47	50	4
EPRB2012-15-C	<input type="checkbox"/>			1° 30'	12	2.58	50	4
EPRB2016-15-C	<input type="checkbox"/>			1° 30'	16	2.79	50	4
EPRB2020-15-C	<input type="checkbox"/>			1° 30'	20	3	60	4
EPRB2025-15-C	<input type="checkbox"/>			1° 30'	25	3.26	60	4
EPRB2010-20-C	<input type="checkbox"/>			2°	10	2.63	50	4
EPRB2012-20-C	<input type="checkbox"/>			2°	12	2.77	50	4
EPRB2016-20-C	<input type="checkbox"/>			2°	16	3.05	50	4
EPRB2020-20-C	<input type="checkbox"/>			2°	20	3.33	60	4
EPRB2025-20-C	<input type="checkbox"/>	2°	25	3.68	60	4		

商品コード Item code	在庫 Stock	寸法 Size (mm)						
		ボール半径 Ball radius	外径 Tool dia.	刃部テーパ半角 Taper angle on side	刃長 Flute length	大端径 Large edge dia.	全長 Overall length	シャンク径 Shank dia.
EPRB2510-05-C	<input type="checkbox"/>	1.25	2.5	30°	10	2.65	50	4
EPRB2512-05-C	<input type="checkbox"/>			30°	12	2.69	50	4
EPRB2516-05-C	<input type="checkbox"/>			30°	16	2.76	50	4
EPRB2520-05-C	<input type="checkbox"/>			30°	20	2.83	60	6
EPRB2525-05-C	<input type="checkbox"/>			30°	25	2.91	60	6
EPRB2530-05-C	<input type="checkbox"/>			30°	30	3	75	6
EPRB2510-07-C	<input type="checkbox"/>			45°	10	2.73	50	4
EPRB2512-07-C	<input type="checkbox"/>			45°	12	2.78	50	4
EPRB2516-07-C	<input type="checkbox"/>			45°	16	2.89	50	4
EPRB2520-07-C	<input type="checkbox"/>			45°	20	2.99	60	6
EPRB2525-07-C	<input type="checkbox"/>			45°	25	3.12	60	6
EPRB2530-07-C	<input type="checkbox"/>			45°	30	3.25	75	6
EPRB2510-10-C	<input type="checkbox"/>			1°	10	2.81	50	4
EPRB2512-10-C	<input type="checkbox"/>			1°	12	2.88	50	4
EPRB2516-10-C	<input type="checkbox"/>			1°	16	3.02	50	4
EPRB2520-10-C	<input type="checkbox"/>			1°	20	3.16	60	6
EPRB2525-10-C	<input type="checkbox"/>			1°	25	3.33	60	6
EPRB2530-10-C	<input type="checkbox"/>			1°	30	3.5	75	6
EPRB2510-15-C	<input type="checkbox"/>			1° 30'	10	2.96	50	4
EPRB2512-15-C	<input type="checkbox"/>			1° 30'	12	3.06	50	4
EPRB2516-15-C	<input type="checkbox"/>			1° 30'	16	3.27	50	4
EPRB2520-15-C	<input type="checkbox"/>			1° 30'	20	3.48	60	6
EPRB2525-15-C	<input type="checkbox"/>			1° 30'	25	3.74	60	6
EPRB2530-15-C	<input type="checkbox"/>			1° 30'	30	4.01	75	6
EPRB2510-20-C	<input type="checkbox"/>	2°	10	3.11	50	4		
EPRB2512-20-C	<input type="checkbox"/>	2°	12	3.25	50	4		
EPRB2516-20-C	<input type="checkbox"/>	2°	16	3.53	50	4		
EPRB2520-20-C	<input type="checkbox"/>	2°	20	3.81	60	6		
EPRB2525-20-C	<input type="checkbox"/>	2°	25	4.16	60	6		
EPRB2530-20-C	<input type="checkbox"/>	2°	30	4.51	75	6		
EPRB2520-30-C	<input type="checkbox"/>	3°	20	4.47	60	6		
EPRB2530-30-C	<input type="checkbox"/>	3°	30	5.51	75	6		
EPRB3025-05-C	<input type="checkbox"/>	1.5	3	30°	25	3.41	60	6
EPRB3040-05-C	<input type="checkbox"/>			30°	40	3.67	75	6
EPRB3025-07-C	<input type="checkbox"/>			45°	25	3.61	60	6
EPRB3025-10-C	<input type="checkbox"/>			1°	25	3.81	60	6
EPRB3040-10-C	<input type="checkbox"/>			1°	40	4.34	75	6
EPRB3025-15-C	<input type="checkbox"/>			1° 30'	25	4.23	60	6
EPRB3040-15-C	<input type="checkbox"/>			1° 30'	40	5.02	75	6
EPRB3025-20-C	<input type="checkbox"/>			2°	25	4.64	60	6
EPRB3040-20-C	<input type="checkbox"/>			2°	40	5.69	75	6
EPRB3025-30-C	<input type="checkbox"/>			3°	25	5.46	60	6
EPRB3040-30-C	<input type="checkbox"/>			3°	40	7.04	80	8

Carbide End Mills
Stocked by Specified distributor

標準切削条件表 Recommended cutting conditions EPRB-C

切削条件 Cutting conditions ボール半径R ×外径DC mm	切込み(a _p) Depth of cut mm/pass	切削速度(v _c) 50~75m/min Cutting speed		送り速度(v _f) Feed speed mm/min
		回転数(n) min ⁻¹ Revolution		
RE0.3×0.6	0.01~0.05	20,000~30,000		200~ 800
RE0.4×0.8	0.01~0.06	12,000~28,000		200~1,000
RE0.5×1.0	0.03~0.08	10,000~22,000		300~1,000
RE0.6×1.2	0.04~0.09	8,000~19,000		300~1,000
RE0.75×1.5	0.06~0.12	6,400~15,000		300~1,000
RE0.8×1.6	0.06~0.13	6,000~14,000		300~1,000
RE0.9×1.8	0.07~0.15	5,300~12,400		400~1,000
RE1×2.0	0.07~0.2	4,800~11,000		400~1,000
RE1.25×2.5	0.08~0.25	3,800~ 8,900		400~1,000
RE1.5×3.0	0.09~0.3	3,200~ 7,400		400~1,000

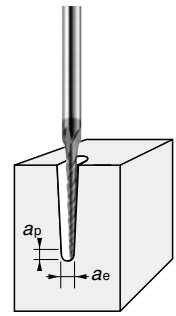

- [注意]**
- ①溝深さの浅い場合は刃長の短いエンドミルをご使用ください。
 - ②コーナー部の加工は送り速度を約1/2に、軸方向送りは1/5以下を目安にしてください。
 - ③この標準切削条件表は切削条件の目安を示すものです。実際の加工では加工形状、目的、使用機械等により条件を調整してください。
 - ④切削油(できるだけ油性切削油)をご使用ください。

- [Note]**
- ① Use short length for shallow slots.
 - ② Reduce the feed speed at the table to 50% at the corner and 1/5 at plunging.
 - ③ These Recommended Cutting Conditions indicate only the rule of a thumb for the cutting conditions. In actual machining, the condition should be adjusted according to the machining shape, purpose and the machine type.
 - ④ Oil base coolant is recommended.

対応被削材 Applicable work material

炭素鋼 合金鋼 Carbon steel Alloy steel	プリハー ド鋼 Pre-hardened steel	高硬度 耐熱鋼 Hardened steel			ステン レス鋼 Stainless steel	チタン合金 耐熱合金 Titanium alloy Heat-resistant alloy	銅合金 Copper alloy	アルミ 合金 Aluminum alloy
		> 45HRC ≤ 55HRC	> 55HRC ≤ 65HRC	> 65HRC				
○	○	○	○		○	○	○	

C Coating Carbide End Mills "RIB-CUT Ball" 超硬Cコートエンドミル"リブカットボール"

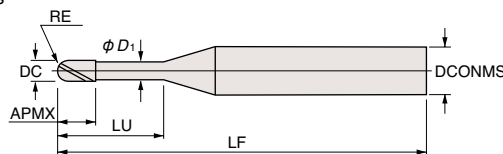
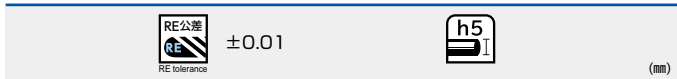
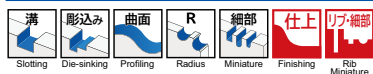

DEB2006-6-C



商品コード Item code	在庫 Stock	寸法 Size (mm)						
		ボール半径 Ball radius	外径 Tool dia.	刃長 Flute length	首径 Neck dia.	首下長 Under neck length	全長 Overall length	シャンク径 Shank dia.
		RE	DC	APMX	DN	LU	LF	DCONMS
DEB2006-6-C	<input type="checkbox"/>	0.3	0.6	1.2	0.58	6	55	4
DEB2008-6-C	<input type="checkbox"/>	0.4	0.8	1.2	0.77	6	55	4
DEB2008-8-C	<input type="checkbox"/>			1.2	0.77	8	55	4
DEB2010-8-C	<input type="checkbox"/>	0.5	1	1.5	0.95	8	55	4
DEB2010-12-C	<input type="checkbox"/>			1.5	0.95	12	55	4
DEB2012-8-C	<input type="checkbox"/>	0.6	1.2	1.6	1.15	8	55	4
DEB2012-12-C	<input type="checkbox"/>			1.6	1.15	12	55	4
DEB2014-12-C	<input type="checkbox"/>	0.7	1.4	1.6	1.34	12	55	4
DEB2015-8-C	<input type="checkbox"/>	0.75	1.5	1.8	1.44	8	55	4
DEB2015-12-C	<input type="checkbox"/>			1.8	1.44	12	55	4
DEB2015-16-C	<input type="checkbox"/>			1.8	1.44	16	55	4
DEB2016-16-C	<input type="checkbox"/>	0.8	1.6	1.8	1.54	16	55	4
DEB2018-16-C	<input type="checkbox"/>	0.9	1.8	2	1.73	16	55	4
DEB2020-8-C	<input type="checkbox"/>	1	2	2	1.92	8	55	4
DEB2020-12-C	<input type="checkbox"/>			2	1.92	12	55	4
DEB2020-16-C	<input type="checkbox"/>			2	1.92	16	55	4
DEB2020-20-C	<input type="checkbox"/>			2	1.92	20	55	4

標準切削条件表 Recommended cutting conditions

DEB-C リブカットボール Rib Cut Ball

<溝切削> Slotting 被削材：一般構造用炭素鋼、合金鋼 Carbon steels, Alloy steels

切削条件 Cutting conditions ボール半径RE × 外径DC (mm)	切込み (ap) Depth of cut mm/pass	切削速度 (vc) 30~50m/min		送り速度 (vf) mm/min
		回転数 (n) min ⁻¹		
RE0.3 × 0.6	0.01 ~ 0.02	16,000 ~ 26,000		150 ~ 300
RE0.4 × 0.8	0.03 ~ 0.05	12,000 ~ 20,000		150 ~ 300
RE0.5 × 1.0	0.05 ~ 0.08	9,500 ~ 16,000		150 ~ 300
RE0.6 × 1.2	0.06 ~ 0.10	8,000 ~ 13,000		150 ~ 300
RE0.7 × 1.4	0.07 ~ 0.12	7,000 ~ 11,000		150 ~ 300
RE0.75 × 1.5	0.08 ~ 0.12	6,500 ~ 10,000		150 ~ 300
RE0.8 × 1.6	0.10 ~ 0.15	6,000 ~ 10,000		150 ~ 300
RE0.9 × 1.8	0.15 ~ 0.20	5,000 ~ 9,000		150 ~ 300
RE1.0 × 2.0	0.15 ~ 0.30	5,000 ~ 8,000		150 ~ 300

- [注意]** ①被削材、加工形状に合わせて、適切なクーラントを使用してください。
②この標準切削条件表は切削条件の目安を示すものです。実際の加工では加工形状、目的、使用機械等により条件を調整してください。
- [Note]** ① Use the appropriate coolant for the work material and machining shape.
② These Recommended Cutting Conditions indicate only the rule of a thumb for the cutting conditions. In actual machining, the condition should be adjusted according to the machining shape, purpose and the machine type.

対応被削材 Applicable work material

炭素鋼 合金鋼 Carbon steel Alloy steel	炭素鋼 合金鋼 Pre-hardened steel ≤ 45HRC	高硬度 Hardened steel			ステン レス鋼 Stainless steel	チタン合金 耐熱合金 Titanium alloy Heat-resistant alloy	銅合金 Copper alloy	アルミ 合金 Aluminum alloy
		> 45HRC ≤ 55HRC	> 55HRC ≤ 65HRC	> 65HRC				
○	○	○	○	○	○	○	○	

○印：特定代理店在庫です。弊社営業へお問合せください。 □：Stocked by specified distributor. Contact with our sales department.

C Coating Carbide End Mills "RIB STAR" 超硬Cコートエンドミル"リブスター"

コーナR付き

Corner radius

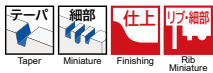

外径公差
Dia. tolerance 0 ~ -0.05



(mm)



6枚刃
6Flutes

片角公差：
Tolerance on angle 0
 $-15'$



RIB6-0000-000CR-C



商品コード Item code	在庫 Stock	寸法 Size (mm)						
		外径 Tool dia.	刃部テーパ半角 Taper angle on side	コーナ半径 Corner radius	刃長 Flute length	大端径 Large edge dia.	全長 Overall length	シャンク径 Shank dia.
RIB61012-05CR-C	<input type="checkbox"/>	1	30'	0.3	12	1.21	45	4
RIB61012-10CR-C	<input type="checkbox"/>		1°		12	1.42	45	4
RIB61012-15CR-C	<input type="checkbox"/>		1°30'		12	1.63	45	4
RIB61012-20CR-C	<input type="checkbox"/>		2°		12	1.84	45	4
RIB61012-30CR-C	<input type="checkbox"/>		3°		12	2.26	45	4
RIB61216-05CR-C	<input type="checkbox"/>	1.2	30'	0.3	16	1.48	45	4
RIB61216-10CR-C	<input type="checkbox"/>		1°		16	1.76	45	4
RIB61216-15CR-C	<input type="checkbox"/>		1°30'		16	2.04	45	4
RIB61216-20CR-C	<input type="checkbox"/>		2°		16	2.32	45	4
RIB61216-30CR-C	<input type="checkbox"/>		3°		16	2.88	45	4
RIB61520-05CR-C	<input type="checkbox"/>	1.5	30'	0.4	20	1.85	50	4
RIB61520-10CR-C	<input type="checkbox"/>		1°		20	2.20	50	4
RIB61520-15CR-C	<input type="checkbox"/>		1°30'		20	2.55	50	4
RIB61520-20CR-C	<input type="checkbox"/>		2°		20	2.90	50	4
RIB61520-30CR-C	<input type="checkbox"/>		3°		20	3.60	50	4
RIB61820-05CR-C	<input type="checkbox"/>	1.8	30'	0.4	20	2.15	50	4
RIB61820-10CR-C	<input type="checkbox"/>		1°		20	2.50	50	4
RIB61820-15CR-C	<input type="checkbox"/>		1°30'		20	2.85	50	4
RIB61820-20CR-C	<input type="checkbox"/>		2°		20	3.20	50	4
RIB61820-30CR-C	<input type="checkbox"/>		3°		20	3.90	50	4

商品コード Item code	在庫 Stock	寸法 Size (mm)						
		外径 Tool dia.	刃部テーパ半角 Taper angle on side	コーナ半径 Corner radius	刃長 Flute length	大端径 Large edge dia.	全長 Overall length	シャンク径 Shank dia.
RIB62025-05CR-C	<input type="checkbox"/>	2	30'	0.5	25	2.44	50	4
RIB62025-10CR-C	<input type="checkbox"/>		1°		25	2.87	50	4
RIB62025-15CR-C	<input type="checkbox"/>		1°30'		25	3.31	50	4
RIB62025-20CR-C	<input type="checkbox"/>		2°		25	3.75	50	4
RIB62025-30CR-C	<input type="checkbox"/>		3°		25	4.62	70	6
RIB62530-05CR-C	<input type="checkbox"/>	2.5	30'	0.5	30	3.02	70	6
RIB62530-10CR-C	<input type="checkbox"/>		1°		30	3.55	70	6
RIB62530-15CR-C	<input type="checkbox"/>		1°30'		30	4.07	70	6
RIB62530-20CR-C	<input type="checkbox"/>		2°		30	4.60	70	6
RIB62530-30CR-C	<input type="checkbox"/>		3°		30	5.64	70	6
RIB63040-05CR-C	<input type="checkbox"/>	3	30'	0.5	40	3.70	70	6
RIB63040-10CR-C	<input type="checkbox"/>		1°		40	4.40	70	6
RIB63040-15CR-C	<input type="checkbox"/>		1°30'		40	5.09	70	6
RIB63040-20CR-C	<input type="checkbox"/>		2°		40	5.79	70	6

標準切削条件表 Recommended cutting conditions

RIB-CR-C

<溝切削> Slotting

被削材 Work material		一般構造用炭素鋼 Mild carbon Steels		合金鋼 Alloy steels		アルミ合金 Aluminum alloys	
外径 Tool dia. mm	切込み (ap) Depth of cut mm/pass	回転数 min ⁻¹	送り速度 mm/min	回転数 min ⁻¹	送り速度 mm/min	回転数 min ⁻¹	送り速度 mm/min
0.6	0.01 ~ 0.02	32,000	400	22,000	250	50,000	500
0.8	0.01 ~ 0.03	24,000	400	16,000	300	32,000	600
1.0	0.03 ~ 0.05	19,000	450	13,000	300	28,000	600
1.5	0.03 ~ 0.08	12,700	500	8,500	300	24,000	600
2.0	0.05 ~ 0.15	9,600	500	6,400	400	19,000	800
2.5	0.07 ~ 0.20	7,600	600	5,000	400	12,000	800
3.0	0.09 ~ 0.25	6,300	600	4,200	400	10,000	800

- [注意]** ①被削材、加工形状に合わせて、適切なクーラントを使用してください。
②この標準切削条件表は切削条件の目安を示すものです。実際の加工では加工形状、目的、使用機械等により条件を調整してください。
- [Note]** ① Use the appropriate coolant for the work material and machining shape.
② These Recommended Cutting Conditions indicate only the rule of a thumb for the cutting conditions. In actual machining, the condition should be adjusted according to the machining shape, purpose and the machine type.

対応被削材 Applicable work material

炭素鋼 合金鋼 Carbon steel Alloy steel	プリハー ド鋼 Pre-hardened steel ≤ 45HRC	高硬度 Hardened steel			ステン レス鋼 Stainless steel	チタン 合金 耐熱合金 Titanium alloy Heat-resistant alloy	銅合金 Copper alloy	アルミ 合金 Aluminum alloy
		> 45HRC ≤ 55HRC	> 55HRC ≤ 65HRC	> 65HRC				
○	○	○	○	○	○	○	○	

○印：特定代理店在庫です。弊社営業へお問合せください。 □：Stocked by specified distributor. Contact with our sales department.

Carbide End Mills

Stocked by Specified distributor

Epoch Rib エポックリブ

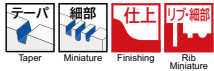

片角公差: ± 5°
Tolerance on angle



4枚刃
4Flutes



0~-0.03



(mm)

EPRI○○○○○-○○○-C



商品コード Item code	在庫 Stock	寸法 Size (mm)					
		外径 Tool dia.	溝角 Taper angle on side	刃長 Flute length	大端径 Large side dia.	全長 Overall length	シャンク径 Shank dia.
EPRI0504-05-C	<input type="checkbox"/>	30'	4°	0.57	50	4	
EPRI0506-05-C	<input type="checkbox"/>	30'	6°	0.6	50	4	
EPRI0504-07-C	<input type="checkbox"/>	45'	4°	0.6	50	4	
EPRI0506-07-C	<input type="checkbox"/>	45'	6°	0.66	50	4	
EPRI0504-10-C	<input type="checkbox"/>	1°	4°	0.64	50	4	
EPRI0506-10-C	<input type="checkbox"/>	1°	6°	0.71	50	4	
EPRI0504-15-C	<input type="checkbox"/>	1° 30'	4°	0.71	50	4	
EPRI0506-15-C	<input type="checkbox"/>	1° 30'	6°	0.81	50	4	
EPRI0504-20-C	<input type="checkbox"/>	2°	4°	0.78	50	4	
EPRI0506-20-C	<input type="checkbox"/>	2°	6°	0.92	50	4	
EPRI0504-30-C	<input type="checkbox"/>	3°	4°	0.92	50	4	
EPRI0604-05-C	<input type="checkbox"/>	30'	4°	0.67	50	4	
EPRI0606-05-C	<input type="checkbox"/>	30'	6°	0.7	50	4	
EPRI0604-07-C	<input type="checkbox"/>	45'	4°	0.7	50	4	
EPRI0606-07-C	<input type="checkbox"/>	45'	6°	0.76	50	4	
EPRI0604-10-C	<input type="checkbox"/>	1°	4°	0.74	50	4	
EPRI0606-10-C	<input type="checkbox"/>	1°	6°	0.81	50	4	
EPRI0604-15-C	<input type="checkbox"/>	1° 30'	4°	0.81	50	4	
EPRI0606-15-C	<input type="checkbox"/>	1° 30'	6°	0.91	50	4	
EPRI0604-20-C	<input type="checkbox"/>	2°	4°	0.88	50	4	
EPRI0606-20-C	<input type="checkbox"/>	2°	6°	1.02	50	4	
EPRI0604-30-C	<input type="checkbox"/>	3°	4°	1.02	50	4	
EPRI0704-05-C	<input type="checkbox"/>	30'	4°	0.77	50	4	
EPRI0706-05-C	<input type="checkbox"/>	30'	6°	0.8	50	4	
EPRI0708-05-C	<input type="checkbox"/>	30'	8°	0.84	50	4	
EPRI0706-07-C	<input type="checkbox"/>	45'	6°	0.86	50	4	
EPRI0708-07-C	<input type="checkbox"/>	45'	8°	0.91	50	4	
EPRI0704-10-C	<input type="checkbox"/>	1°	4°	0.84	50	4	
EPRI0706-10-C	<input type="checkbox"/>	1°	6°	0.91	50	4	
EPRI0708-10-C	<input type="checkbox"/>	1°	8°	0.98	50	4	
EPRI0704-15-C	<input type="checkbox"/>	1° 30'	4°	0.91	50	4	
EPRI0706-15-C	<input type="checkbox"/>	1° 30'	6°	1.01	50	4	
EPRI0708-15-C	<input type="checkbox"/>	1° 30'	8°	1.12	50	4	
EPRI0704-20-C	<input type="checkbox"/>	2°	4°	0.98	50	4	
EPRI0706-20-C	<input type="checkbox"/>	2°	6°	1.12	50	4	
EPRI0708-20-C	<input type="checkbox"/>	2°	8°	1.26	50	4	
EPRI0706-30-C	<input type="checkbox"/>	3°	6°	1.33	50	4	
EPRI0806-05-C	<input type="checkbox"/>	30'	6°	0.91	50	4	
EPRI0808-05-C	<input type="checkbox"/>	30'	8°	0.94	50	4	
EPRI0810-05-C	<input type="checkbox"/>	30'	10°	0.98	50	4	
EPRI0806-07-C	<input type="checkbox"/>	45'	6°	0.96	50	4	
EPRI0808-07-C	<input type="checkbox"/>	45'	8°	1.01	50	4	
EPRI0810-07-C	<input type="checkbox"/>	45'	10°	1.06	50	4	
EPRI0806-10-C	<input type="checkbox"/>	1°	6°	1.01	50	4	
EPRI0808-10-C	<input type="checkbox"/>	1°	8°	1.08	50	4	
EPRI0810-10-C	<input type="checkbox"/>	1°	10°	1.15	50	4	
EPRI0806-15-C	<input type="checkbox"/>	1° 30'	6°	1.11	50	4	
EPRI0808-15-C	<input type="checkbox"/>	1° 30'	8°	1.22	50	4	
EPRI0810-15-C	<input type="checkbox"/>	1° 30'	10°	1.32	50	4	
EPRI0806-20-C	<input type="checkbox"/>	2°	6°	1.22	50	4	
EPRI0808-20-C	<input type="checkbox"/>	2°	8°	1.36	50	4	
EPRI0810-20-C	<input type="checkbox"/>	2°	10°	1.5	50	4	
EPRI0806-30-C	<input type="checkbox"/>	3°	6°	1.43	50	4	
EPRI0810-30-C	<input type="checkbox"/>	3°	10°	1.85	50	4	
EPRI0906-05-C	<input type="checkbox"/>	30'	6°	1	50	4	
EPRI0908-05-C	<input type="checkbox"/>	30'	8°	1.04	50	4	
EPRI0910-05-C	<input type="checkbox"/>	30'	10°	1.07	50	4	
EPRI0906-07-C	<input type="checkbox"/>	45'	6°	1.06	50	4	
EPRI0908-07-C	<input type="checkbox"/>	45'	8°	1.11	50	4	
EPRI0910-07-C	<input type="checkbox"/>	45'	10°	1.16	50	4	
EPRI0906-10-C	<input type="checkbox"/>	1°	6°	1.11	50	4	
EPRI0908-10-C	<input type="checkbox"/>	1°	8°	1.18	50	4	
EPRI0910-10-C	<input type="checkbox"/>	1°	10°	1.25	50	4	

商品コード Item code	在庫 Stock	寸法 Size (mm)					
		外径 Tool dia.	溝角 Taper angle on side	刃長 Flute length	大端径 Large side dia.	全長 Overall length	シャンク径 Shank dia.
EPRI0906-15-C	<input type="checkbox"/>	1° 30'	6°	1.21	50	4	
EPRI0908-15-C	<input type="checkbox"/>	1° 30'	8°	1.32	50	4	
EPRI0910-15-C	<input type="checkbox"/>	1° 30'	10°	1.42	50	4	
EPRI0906-20-C	<input type="checkbox"/>	2°	6°	1.32	50	4	
EPRI0908-20-C	<input type="checkbox"/>	2°	8°	1.46	50	4	
EPRI0910-20-C	<input type="checkbox"/>	2°	10°	1.6	50	4	
EPRI0908-30-C	<input type="checkbox"/>	3°	8°	1.74	50	4	
EPRI1006-05-C	<input type="checkbox"/>	30'	6°	1.11	50	4	
EPRI1008-05-C	<input type="checkbox"/>	30'	8°	1.14	50	4	
EPRI1010-05-C	<input type="checkbox"/>	30'	10°	1.17	50	4	
EPRI1012-05-C	<input type="checkbox"/>	30'	12°	1.21	50	4	
EPRI1016-05-C	<input type="checkbox"/>	30'	16°	1.28	50	4	
EPRI1008-07-C	<input type="checkbox"/>	45'	8°	1.21	50	4	
EPRI1010-07-C	<input type="checkbox"/>	45'	10°	1.26	50	4	
EPRI1012-07-C	<input type="checkbox"/>	45'	12°	1.31	50	4	
EPRI1006-10-C	<input type="checkbox"/>	1°	6°	1.21	50	4	
EPRI1008-10-C	<input type="checkbox"/>	1°	8°	1.28	50	4	
EPRI1010-10-C	<input type="checkbox"/>	1°	10°	1.35	50	4	
EPRI1012-10-C	<input type="checkbox"/>	1°	12°	1.42	50	4	
EPRI1016-10-C	<input type="checkbox"/>	1°	16°	1.56	50	4	
EPRI1006-15-C	<input type="checkbox"/>	1° 30'	6°	1.31	50	4	
EPRI1008-15-C	<input type="checkbox"/>	1° 30'	8°	1.42	50	4	
EPRI1010-15-C	<input type="checkbox"/>	1° 30'	10°	1.52	50	4	
EPRI1012-15-C	<input type="checkbox"/>	1° 30'	12°	1.63	50	4	
EPRI1016-15-C	<input type="checkbox"/>	1° 30'	16°	1.84	50	4	
EPRI1006-20-C	<input type="checkbox"/>	2°	6°	1.42	50	4	
EPRI1008-20-C	<input type="checkbox"/>	2°	8°	1.56	50	4	
EPRI1010-20-C	<input type="checkbox"/>	2°	10°	1.7	50	4	
EPRI1012-20-C	<input type="checkbox"/>	2°	12°	1.84	50	4	
EPRI1016-20-C	<input type="checkbox"/>	2°	16°	2.12	50	4	
EPRI1008-30-C	<input type="checkbox"/>	3°	8°	1.84	50	4	
EPRI1012-30-C	<input type="checkbox"/>	3°	12°	2.26	50	4	
EPRI1206-05-C	<input type="checkbox"/>	30'	6°	1.31	50	4	
EPRI1208-05-C	<input type="checkbox"/>	30'	8°	1.34	50	4	
EPRI1210-05-C	<input type="checkbox"/>	30'	10°	1.38	50	4	
EPRI1212-05-C	<input type="checkbox"/>	30'	12°	1.41	50	4	
EPRI1216-05-C	<input type="checkbox"/>	30'	16°	1.48	50	4	
EPRI1220-05-C	<input type="checkbox"/>	30'	20°	1.55	60	4	
EPRI1208-07-C	<input type="checkbox"/>	45'	8°	1.41	50	4	
EPRI1210-07-C	<input type="checkbox"/>	45'	10°	1.46	50	4	
EPRI1212-07-C	<input type="checkbox"/>	45'	12°	1.51	50	4	
EPRI1216-07-C	<input type="checkbox"/>	45'	16°	1.62	50	4	
EPRI1206-10-C	<input type="checkbox"/>	1°	6°	1.41	50	4	
EPRI1208-10-C	<input type="checkbox"/>	1°	8°	1.48	50	4	
EPRI1210-10-C	<input type="checkbox"/>	1°	10°	1.55	50	4	
EPRI1212-10-C	<input type="checkbox"/>	1°	12°	1.62	50	4	
EPRI1216-10-C	<input type="checkbox"/>	1°	16°	1.76	50	4	
EPRI1220-10-C	<input type="checkbox"/>	1°	20°	1.9	60	4	
EPRI1206-15-C	<input type="checkbox"/>	1° 30'	6°	1.51	50	4	
EPRI1208-15-C	<input type="checkbox"/>	1° 30'	8°	1.62	50	4	
EPRI1210-15-C	<input type="checkbox"/>	1° 30'	10°	1.72	50	4	
EPRI1212-15-C	<input type="checkbox"/>	1° 30'	12°	1.83	50	4	
EPRI1216-15-C	<input type="checkbox"/>	1° 30'	16°	2.04	50	4	
EPRI1206-20-C	<input type="checkbox"/>	2°	6°	1.62	50	4	
EPRI1208-20-C	<input type="checkbox"/>	2°	8°	1.76	50	4	
EPRI1210-20-C	<input type="checkbox"/>	2°	10°	1.9	50	4	
EPRI1212-20-C	<input type="checkbox"/>	2°	12°	2.04	50	4	
EPRI1216-20-C	<input type="checkbox"/>	2°	16°	2.32	50	4	
EPRI1210-30-C	<input type="checkbox"/>	3°	10°	2.25	50	4	
EPRI1216-30-C	<input type="checkbox"/>	3°	16°	2.88	50	4	
EPRI1508-05-C	<input type="checkbox"/>	30'	8°	1.64	50	4	
EPRI1510-05-C	<input type="checkbox"/>	30'	10°	1.67	50	4	
EPRI1512-05-C	<input type="checkbox"/>	30'	12°	1.71	50	4	

商品コード Item code	在庫 Stock	寸法 Size (mm)					
		外径 Tool dia.	溝角 Taper angle on side	刃長 Flute length	大端径 Large side dia.	全長 Overall length	シャンク径 Shank dia.
EPRI1516-05-C	<input type="checkbox"/>	30'	16°	1.78	50	4	
EPRI1520-05-C	<input type="checkbox"/>	30'	20°	1.85	60	4	
EPRI1508-07-C	<input type="checkbox"/>	45'	8°	1.71	50	4	
EPRI1510-07-C	<input type="checkbox"/>	45'	10°	1.76	50	4	
EPRI1512-07-C	<input type="checkbox"/>	45'	12°	1.81	50	4	
EPRI1516-07-C	<input type="checkbox"/>	45'	16°	1.92	50	4	
EPRI1520-07-C	<input type="checkbox"/>	45'	20°	2.02	60	4	
EPRI1508-10-C	<input type="checkbox"/>	1°	8°	1.78	50	4	
EPRI1510-10-C	<input type="checkbox"/>	1°	10°	1.85	50	4	
EPRI1512-10-C	<input type="checkbox"/>	1°	12°	1.92	50	4	
EPRI1516-10-C	<input type="checkbox"/>	1°	16°	2.06	50	4	
EPRI1520-10-C	<input type="checkbox"/>	1°	20°	2.2	60	4	
EPRI1508-15-C	<input type="checkbox"/>	1° 30'	8°	1.92	50	4	
EPRI1510-15-C	<input type="checkbox"/>	1° 30'	10°	2.02	50	4	
EPRI1512-15-C	<input type="checkbox"/>	1° 30'	12°	2.13	50	4	
EPRI1516-15-C	<input type="checkbox"/>	1° 30'	16°	2.34	50	4	
EPRI1520-15-C	<input type="checkbox"/>	1° 30'	20°	2.55	60	4	
EPRI1508-20-C	<input type="checkbox"/>	2°	8°	2.06	50	4	
EPRI1510-20-C	<input type="checkbox"/>	2°	10°	2.2	50	4	
EPRI1512-20-C	<input type="checkbox"/>	2°	12°	2.34	50	4	
EPRI1516-20-C	<input type="checkbox"/>	2°	16°	2.62	50	4	
EPRI1520-20-C	<input type="checkbox"/>	2°	20°	2.9	60	4	
EPRI1512-30-C	<input type="checkbox"/>	3°	12°	2.76	50	4	
EPRI1520-30-C	<input type="checkbox"/>	3°	20°	3.6	60	4	
EPRI1608-05-C	<input type="checkbox"/>	30'	8°	1.74	50	4	
EPRI1610-05-C	<input type="checkbox"/>	30'	10°	1.77	50	4	
EPRI1612-05-C	<input type="checkbox"/>	30'	12°	1.81	50	4	
EPRI1616-05-C	<input type="checkbox"/>	30'	16°	1.88	50	4	
EPRI1620-05-C	<input type="checkbox"/>	30'	20°	1.95	60	4	
EPRI1608-07-C	<input type="checkbox"/>	45'	8°	1.81	50	4	
EPRI1610-07-C	<input type="checkbox"/>	45'	10°	1.86	50	4	
EPRI1612-07-C	<input type="checkbox"/>	45'	12°	1.91	50	4	
EPRI1616-07-C	<input type="checkbox"/>	45'	16°	2.02	50	4	
EPRI1620-07-C	<input type="checkbox"/>	45'	20°	2.12	60	4	
EPRI1608-10-C	<input type="checkbox"/>	1°	8°	1.88	50	4	
EPRI1610-10-C	<input type="checkbox"/>	1°	10°	1.95	50	4	
EPRI1612-10-C	<input type="checkbox"/>	1°	12°	2.02	50	4	
EPRI1616-10-C	<input type="checkbox"/>	1°	16°	2.16	50	4	
EPRI1620-10-C	<input type="checkbox"/>	1°	20°	2.3	60	4	
EPRI1608-15-C	<input type="checkbox"/>	1° 30'	8°	2.02	50	4	
EPRI1610-15-C	<input type="checkbox"/>	1° 30'	10°	2.12	50	4	
EPRI1612-15-C	<input type="checkbox"/>	1° 30'	12°	2.23	50	4	
EPRI1616-15-C	<input type="checkbox"/>	1° 30'	16°	2.44	50	4	
EPRI1620-15-C	<input type="checkbox"/>	1° 30'	20°	2.65	60	4	
EPRI1608-20-C	<input type="checkbox"/>	2°	8°	2.16	50</		

EPRI○○○○○-○○○-C

商品コード Item code	在庫 Stock	寸法 Size (mm)					
		外径 Tool dia.	溝角 Taper angle on side	刃長 Flute length	大端径 Large side dia.	全長 Overall length	シャンク径 Shank dia.
EPRI1812-10-C	□	1°	12	2.22	50	4	
EPRI1816-10-C	□	1°	16	2.36	50	4	
EPRI1820-10-C	□	1°	20	2.5	60	4	
EPRI1808-15-C	□	1° 30'	8	2.22	50	4	
EPRI1810-15-C	□	1° 30'	10	2.32	50	4	
EPRI1812-15-C	□	1° 30'	12	2.43	50	4	
EPRI1816-15-C	□	1° 30'	16	2.64	50	4	
EPRI1820-15-C	□	1° 30'	20	2.85	60	4	
EPRI1808-20-C	□	2°	8	2.36	50	4	
EPRI1810-20-C	□	2°	10	2.5	50	4	
EPRI1812-20-C	□	2°	12	2.64	50	4	
EPRI1816-20-C	□	2°	16	2.92	50	4	
EPRI1820-20-C	□	2°	20	3.2	60	4	
EPRI1812-30-C	□	3°	12	3.06	50	4	
EPRI1820-30-C	□	3°	20	3.9	60	4	
EPRI2010-05-C	□	30'	10	2.17	50	4	
EPRI2012-05-C	□	30'	12	2.21	50	4	
EPRI2016-05-C	□	30'	16	2.28	50	4	
EPRI2020-05-C	□	30'	20	2.35	60	4	
EPRI2025-05-C	□	30'	25	2.44	60	4	
EPRI2010-07-C	□	45'	10	2.26	50	4	
EPRI2012-07-C	□	45'	12	2.31	50	4	
EPRI2016-07-C	□	45'	16	2.42	50	4	
EPRI2020-07-C	□	45'	20	2.52	60	4	
EPRI2025-07-C	□	45'	25	2.65	60	4	
EPRI2010-10-C	□	1°	10	2.35	50	4	
EPRI2012-10-C	□	1°	12	2.42	50	4	
EPRI2016-10-C	□	1°	16	2.56	50	4	
EPRI2020-10-C	□	1°	20	2.7	60	4	
EPRI2025-10-C	□	1°	25	2.87	60	4	
EPRI2010-15-C	□	1° 30'	10	2.52	50	4	

商品コード Item code	在庫 Stock	寸法 Size (mm)					
		外径 Tool dia.	溝角 Taper angle on side	刃長 Flute length	大端径 Large side dia.	全長 Overall length	シャンク径 Shank dia.
EPRI2012-15-C	□	1° 30'	12	2.63	50	4	
EPRI2016-15-C	□	1° 30'	16	2.84	50	4	
EPRI2020-15-C	□	1° 30'	20	3.05	60	4	
EPRI2025-15-C	□	1° 30'	25	3.31	60	4	
EPRI2010-20-C	□	2°	10	2.7	50	4	
EPRI2012-20-C	□	2°	12	2.87	50	4	
EPRI2016-20-C	□	2°	16	3.12	50	4	
EPRI2020-20-C	□	2°	20	3.4	60	4	
EPRI2025-20-C	□	2°	25	3.75	60	4	
EPRI2016-30-C	□	3°	16	3.68	50	4	
EPRI2025-30-C	□	3°	25	4.62	60	6	
EPRI2510-05-C	□	30'	10	2.67	50	4	
EPRI2512-05-C	□	30'	12	2.71	50	4	
EPRI2516-05-C	□	30'	16	2.78	50	4	
EPRI2520-05-C	□	30'	20	2.85	60	6	
EPRI2525-05-C	□	30'	25	2.94	60	6	
EPRI2530-05-C	□	30'	30	3.02	75	6	
EPRI2510-07-C	□	45'	10	2.76	50	4	
EPRI2512-07-C	□	45'	12	2.81	50	4	
EPRI2516-07-C	□	45'	16	2.92	50	4	
EPRI2520-07-C	□	45'	20	3.02	60	6	
EPRI2525-07-C	□	45'	25	3.15	60	6	
EPRI2530-07-C	□	45'	30	3.29	75	6	
EPRI2510-10-C	□	1°	10	2.85	50	4	
EPRI2512-10-C	□	1°	12	2.92	50	4	
EPRI2516-10-C	□	1°	16	3.06	50	4	
EPRI2520-10-C	□	1°	20	3.2	60	6	
EPRI2525-10-C	□	1°	25	3.37	60	6	
EPRI2530-10-C	□	1°	30	3.55	75	6	
EPRI2510-15-C	□	1° 30'	10	3.02	50	4	

商品コード Item code	在庫 Stock	寸法 Size (mm)					
		外径 Tool dia.	溝角 Taper angle on side	刃長 Flute length	大端径 Large side dia.	全長 Overall length	シャンク径 Shank dia.
EPRI2512-15-C	□	1° 30'	12	3.13	50	4	
EPRI2516-15-C	□	1° 30'	16	3.34	50	4	
EPRI2520-15-C	□	1° 30'	20	3.55	60	6	
EPRI2525-15-C	□	1° 30'	25	3.81	60	6	
EPRI2530-15-C	□	1° 30'	30	4.12	75	6	
EPRI2510-20-C	□	2°	10	3.2	50	4	
EPRI2512-20-C	□	2°	12	3.34	50	4	
EPRI2516-20-C	□	2°	16	3.62	50	4	
EPRI2520-20-C	□	2°	20	3.9	60	6	
EPRI2525-20-C	□	2°	25	4.25	60	6	
EPRI2530-20-C	□	2°	30	4.6	75	6	
EPRI2520-30-C	□	3°	20	4.6	60	6	
EPRI2525-30-C	□	3°	25	5.12	60	6	
EPRI2530-30-C	□	3°	30	5.64	75	6	
EPRI3025-05-C	□	30'	25	3.44	60	6	
EPRI3030-05-C	□	30'	30	3.52	75	6	
EPRI3040-05-C	□	30'	40	3.7	75	6	
EPRI3025-07-C	□	45'	25	3.65	60	6	
EPRI3040-07-C	□	45'	40	4.05	75	6	
EPRI3020-10-C	□	1°	20	3.7	60	6	
EPRI3025-10-C	□	1°	25	3.87	60	6	
EPRI3030-10-C	□	1°	30	4.05	75	6	
EPRI3040-10-C	□	1°	40	4.4	75	6	
EPRI3025-15-C	□	1° 30'	25	4.31	60	6	
EPRI3040-15-C	□	1° 30'	40	5.09	75	6	
EPRI3025-20-C	□	2°	25	4.75	60	6	
EPRI3030-20-C	□	2°	30	5.1	75	6	
EPRI3040-20-C	□	2°	40	5.79	75	6	
EPRI3025-30-C	□	3°	25	5.62	60	6	
EPRI3040-30-C	□	3°	40	7.19	80	8	

Carbide End Mills Stocked by Specified distributor

標準切削条件表 Recommended cutting conditions EPRI-C

外径DC Tool dia. mm	切削条件 Cutting conditions	切込み (ap) Depth of cut mm/pass	切削速度 (vc) 50~75m/min	
			回転数 (n) min ⁻¹	送り速度 (vi) mm/min
0.5		0.01~0.02	30,000~32,000	400~ 600
0.6		0.01~0.02	26,000~30,000	400~ 800
0.7		0.01~0.03	23,000~30,000	400~ 800
0.8		0.01~0.03	20,000~30,000	400~1,000
0.9		0.02~0.04	18,000~27,000	400~1,000
1.0		0.03~0.05	16,000~24,000	400~1,200
1.2		0.03~0.06	13,000~20,000	400~1,200
1.5		0.03~0.08	10,000~16,000	400~1,200
1.6		0.04~0.10	10,000~15,000	400~1,200
1.8		0.04~0.12	9,000~13,000	400~1,200
2.0		0.05~0.15	8,000~12,000	400~1,200
2.5		0.07~0.20	6,500~ 9,500	400~1,200
3.0		0.09~0.25	5,500~ 8,000	400~1,200



ae = DC
ap = 表参照

- [注意]**
- ① 溝深さの浅い場合は刃長の短いエンドミルをご使用ください。
 - ② コーナ部の加工は送り速度を約1/2に、軸方向送りは1/5以下を目安にしてください。
 - ③ この標準切削条件表は切削条件の目安を示すものです。実際の加工では加工形状、目的、使用機械等により条件を調整してください。
 - ④ 切削油（できるだけ油性切削油）をご使用ください。
- [Note]**
- ① Use short length for shallow slots.
 - ② Reduce the feed speed at the table to 50% at the corner and 1/5 at plunging.
 - ③ These Recommended Cutting Conditions indicate only the rule of a thumb for the cutting conditions. In actual machining, the condition should be adjusted according to the machining shape, purpose and the machine type.
 - ④ Oil base coolant is recommended.

対応被削材 Applicable work material		高硬度 Hardened steel			ステンレス鋼 Stainless steel	チタン合金耐熱合金 Titanium alloy Heat-resistant alloy	銅合金 Copper alloy	アルミ合金 Aluminum alloy
炭素鋼合金鋼 Carbon steel Alloy steel	プリハードン鋼 Pre-hardened steel	> 45HRC ≤ 55HRC	> 55HRC ≤ 65HRC	> 65HRC	○	○	○	○

C Coating Carbide End Mills "RIB-CUT"

超硬Cコートエンドミル"リブカット"

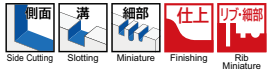

外径公差 Dia. tolerance 0~-0.02

h5

2枚刃
2Flutes

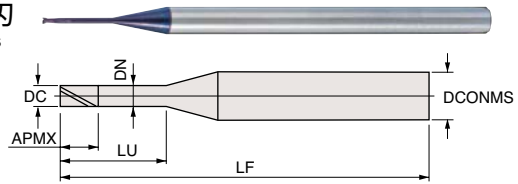

DES2○○○-○○○-C

超硬 Carbide C 刃角 30° Helix angle 切削条件表 A452 Cutting Conditions

商品コード Item code	在庫 Stock	寸法 Size (mm)					
		外径 Tool dia. DC	刃長 Flute length APMX	首径 Neck dia. DN	首下長 Under neck length LU	全長 Overall length LF	シャンク径 Shank dia. DCONMS
DES2005-4-C	<input type="checkbox"/>		0.8	0.48	2	55	4
DES2005-7-C	<input type="checkbox"/>	0.5	0.8	0.48	3.5	55	4
DES2005-10-C	<input type="checkbox"/>		0.8	0.48	5	55	4
DES2006-4-C	<input type="checkbox"/>		1	0.58	2.4	55	4
DES2006-7-C	<input type="checkbox"/>	0.6	1	0.58	4.2	55	4
DES2006-10-C	<input type="checkbox"/>		1	0.58	6	55	4
DES2007-4-C	<input type="checkbox"/>		1.1	0.67	2.8	55	4
DES2007-7-C	<input type="checkbox"/>	0.7	1.1	0.67	4.9	55	4
DES2007-10-C	<input type="checkbox"/>		1.1	0.67	7	55	4
DES2008-5-C	<input type="checkbox"/>		1.3	0.77	4	55	4
DES2008-6-C	<input type="checkbox"/>		1.3	0.77	4.8	55	4
DES2008-7-C	<input type="checkbox"/>	0.8	1.3	0.77	5.6	55	4
DES2008-8.5-C	<input type="checkbox"/>		1.3	0.77	6.8	65	4
DES2008-10-C	<input type="checkbox"/>		1.3	0.77	8	65	4
DES2009-7-C	<input type="checkbox"/>		1.4	0.86	6.3	55	4
DES2009-8.5-C	<input type="checkbox"/>	0.9	1.4	0.86	7.7	55	4
DES2009-10-C	<input type="checkbox"/>		1.4	0.86	9	55	4
DES2010-5-C	<input type="checkbox"/>		1.6	0.95	5	55	4
DES2010-6-C	<input type="checkbox"/>		1.6	0.95	6	55	4
DES2010-7-C	<input type="checkbox"/>	1	1.6	0.95	7	55	4
DES2010-8.5-C	<input type="checkbox"/>		1.6	0.95	8.5	65	4
DES2010-10-C	<input type="checkbox"/>		1.6	0.95	10	65	4
DES2012-5-C	<input type="checkbox"/>		1.9	1.15	6	55	4
DES2012-6-C	<input type="checkbox"/>		1.9	1.15	7.2	55	4
DES2012-7-C	<input type="checkbox"/>	1.2	1.9	1.15	8.4	55	4
DES2012-8.5-C	<input type="checkbox"/>		1.9	1.15	10.2	65	4
DES2012-10-C	<input type="checkbox"/>		1.9	1.15	12	65	4
DES2014-5-C	<input type="checkbox"/>		2.2	1.34	7	55	4
DES2014-6-C	<input type="checkbox"/>	1.4	2.2	1.34	8.4	55	4

商品コード Item code	在庫 Stock	寸法 Size (mm)					
		外径 Tool dia. DC	刃長 Flute length APMX	首径 Neck dia. DN	首下長 Under neck length LU	全長 Overall length LF	シャンク径 Shank dia. DCONMS
DES2014-7-C	<input type="checkbox"/>		2.2	1.34	9.8	55	4
DES2014-8.5-C	<input type="checkbox"/>	1.4	2.2	1.34	11.9	65	4
DES2014-10-C	<input type="checkbox"/>		2.2	1.34	14	65	4
DES2015-5-C	<input type="checkbox"/>		2.4	1.44	7.5	55	4
DES2015-6-C	<input type="checkbox"/>		2.4	1.44	9	55	4
DES2015-7-C	<input type="checkbox"/>	1.5	2.4	1.44	10.5	55	4
DES2015-8.5-C	<input type="checkbox"/>		2.4	1.44	12.75	65	4
DES2015-10-C	<input type="checkbox"/>		2.4	1.44	15	65	4
DES2016-5-C	<input type="checkbox"/>		2.6	1.54	8	55	4
DES2016-6-C	<input type="checkbox"/>		2.6	1.54	9.6	55	4
DES2016-7-C	<input type="checkbox"/>	1.6	2.6	1.54	11.2	55	4
DES2016-8.5-C	<input type="checkbox"/>		2.6	1.54	13.6	65	4
DES2016-10-C	<input type="checkbox"/>		2.6	1.54	16	65	4
DES2018-5-C	<input type="checkbox"/>		2.9	1.73	9	55	4
DES2018-6-C	<input type="checkbox"/>		2.9	1.73	10.8	55	4
DES2018-7-C	<input type="checkbox"/>	1.8	2.9	1.73	12.6	55	4
DES2018-8.5-C	<input type="checkbox"/>		2.9	1.73	15.3	65	4
DES2018-10-C	<input type="checkbox"/>		2.9	1.73	18	65	4
DES2020-3-C	<input type="checkbox"/>		3.2	1.92	6	55	4
DES2020-4-C	<input type="checkbox"/>		3.2	1.92	8	55	4
DES2020-5-C	<input type="checkbox"/>		3.2	1.92	10	55	4
DES2020-6-C	<input type="checkbox"/>	2	3.2	1.92	12	55	4
DES2020-7-C	<input type="checkbox"/>		3.2	1.92	14	55	4
DES2020-8.5-C	<input type="checkbox"/>		3.2	1.92	17	65	4
DES2020-10-C	<input type="checkbox"/>		3.2	1.92	20	65	4
DES2025-3-C	<input type="checkbox"/>		4	2.40	7.5	55	4
DES2025-5-C	<input type="checkbox"/>	2.5	4	2.40	12.5	55	4
DES2025-6-C	<input type="checkbox"/>		4	2.40	15	55	4
DES2025-7-C	<input type="checkbox"/>		4	2.40	17.5	55	4

商品コード Item code	在庫 Stock	寸法 Size (mm)					
		外径 Tool dia. DC	刃長 Flute length APMX	首径 Neck dia. DN	首下長 Under neck length LU	全長 Overall length LF	シャンク径 Shank dia. DCONMS
DES2025-8.5-C	<input type="checkbox"/>	2.5	4	2.40	21.3	55	4
DES2030-3-C	<input type="checkbox"/>		4.8	2.88	9	80	6
DES2030-4-C	<input type="checkbox"/>		4.8	2.88	12	80	6
DES2030-5-C	<input type="checkbox"/>	3	4.8	2.88	15	80	6
DES2030-6-C	<input type="checkbox"/>		4.8	2.88	18	80	6
DES2030-7-C	<input type="checkbox"/>		4.8	2.88	21	80	6
DES2030-8.5-C	<input type="checkbox"/>		4.8	2.88	25.5	80	6
DES2035-3-C	<input type="checkbox"/>		5.6	3.36	10.5	80	6
DES2035-5-C	<input type="checkbox"/>		5.6	3.36	17.5	80	6
DES2035-6-C	<input type="checkbox"/>	3.5	5.6	3.36	21	80	6
DES2035-7-C	<input type="checkbox"/>		5.6	3.36	24.5	80	6
DES2035-8.5-C	<input type="checkbox"/>		5.6	3.36	29.8	80	6
DES2040-3-C	<input type="checkbox"/>		6.4	3.84	12	80	6
DES2040-4-C	<input type="checkbox"/>		6.4	3.84	16	80	6
DES2040-5-C	<input type="checkbox"/>	4	6.4	3.84	20	80	6
DES2040-6-C	<input type="checkbox"/>		6.4	3.84	24	80	6
DES2040-7-C	<input type="checkbox"/>		6.4	3.84	28	80	6
DES2040-8.5-C	<input type="checkbox"/>		6.4	3.84	34	80	6
DES2045-7-C	<input type="checkbox"/>	4.5	7.2	4.32	31.5	80	6
DES2050-3-C	<input type="checkbox"/>		8	4.80	15	80	6
DES2050-4-C	<input type="checkbox"/>		8	4.80	20	90	6
DES2050-5-C	<input type="checkbox"/>	5	8	4.80	25	90	6
DES2050-6-C	<input type="checkbox"/>		8	4.80	30	90	6
DES2050-7-C	<input type="checkbox"/>		8	4.80	35	90	6
DES2050-8.5-C	<input type="checkbox"/>		8	4.80	42.5	90	6
DES2055-7-C	<input type="checkbox"/>	5.5	8.8	5.28	38.5	90	6
DES2060-7-C	<input type="checkbox"/>	6	9.6	5.76	42	90	6

標準切削条件表 Recommended cutting conditions DES-C

<溝切削> Slotting 被削材：一般構造用炭素鋼、合金鋼 Carbon steels, Alloy steels

外径DC (mm)	切削条件 Cutting conditions	切込み (ap) Depth of cut mm/pass	切削速度 (vc) 30~50m/min	
			回転数 (n) min ⁻¹	送り速度 (vf) mm/min
0.6		0.01 ~ 0.02	16,000 ~ 26,000	150 ~ 300
0.8		0.03 ~ 0.05	12,000 ~ 20,000	150 ~ 300
1.0		0.05 ~ 0.08	9,500 ~ 16,000	150 ~ 300
1.2		0.06 ~ 0.10	8,000 ~ 13,000	150 ~ 300
1.4		0.07 ~ 0.12	7,000 ~ 11,000	150 ~ 300
1.5		0.08 ~ 0.12	6,500 ~ 10,000	150 ~ 300
1.6		0.10 ~ 0.15	6,000 ~ 10,000	150 ~ 300
1.8		0.15 ~ 0.20	5,000 ~ 9,000	150 ~ 300
2.0		0.15 ~ 0.30	5,000 ~ 8,000	150 ~ 300

[注意] ①被削材、加工形状に合わせて、適切なクーラントを使用してください。
②この標準切削条件表は切削条件の目安を示すものです。実際の加工では加工形状、目的、使用機械等により条件を調整してください。

[Note] ① Use the appropriate coolant for the work material and machining shape.
② These Recommended Cutting Conditions indicate only the rule of a thumb for the cutting conditions. In actual machining, the condition should be adjusted according to the machining shape, purpose and the machine type.

対応被削材 Applicable work material

炭素鋼 合金鋼 Carbon steel Alloy steel	プリハー ド鋼 Pre-hardened steel	高硬度 Hardened steel			ステン レス鋼 Stainless steel	チタン合金 耐熱合金 Titanium alloy Heat-resistant alloy	銅合金 Copper alloy	アルミ 合金 Aluminum alloy
		> 45HRC ≤ 45HRC	> 55HRC ≤ 55HRC	> 65HRC				
○	○	○	○	○	○	○	○	

○印：特定代理店在庫です。弊社営業へお問合せください。 □：Stocked by specified distributor. Contact with our sales department.

C Coating Carbide End Mills "RIB STAR" 超硬Cコートエンドミル"リブスター"

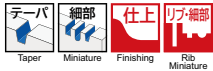

外径公差 Dia.tolerance 0~-0.05



(mm)



6枚刃
6Flutes



片角公差：
Tolerance on angle 0
 $-15'$

RIB6○○○○○-○○○-C



商品コード Item code	在庫 Stock	寸法 Size (mm)					
		外径 Tool dia.	刃部テーパ半角 Taper angle on side	刃長 Flute length	大端径 Large edge dia.	全長 Overall length	シャンク径 Shank dia.
RIB60504-05-C	<input type="checkbox"/>	0.5	30'	4	0.57	45	4
RIB60504-10-C	<input type="checkbox"/>		1°	4	0.64	45	4
RIB60504-15-C	<input type="checkbox"/>		1° 30'	4	0.71	45	4
RIB60504-20-C	<input type="checkbox"/>		2°	4	0.78	45	4
RIB60504-30-C	<input type="checkbox"/>		3°	4	0.92	45	4
RIB60604-05-C	<input type="checkbox"/>	0.6	30'	4	0.67	45	4
RIB60604-10-C	<input type="checkbox"/>		1°	4	0.74	45	4
RIB60604-15-C	<input type="checkbox"/>		1° 30'	4	0.81	45	4
RIB60604-20-C	<input type="checkbox"/>		2°	4	0.88	45	4
RIB60604-30-C	<input type="checkbox"/>		3°	4	1.02	45	4
RIB60706-05-C	<input type="checkbox"/>	0.7	30'	6	0.80	45	4
RIB60706-10-C	<input type="checkbox"/>		1°	6	0.91	45	4
RIB60706-15-C	<input type="checkbox"/>		1° 30'	6	1.01	45	4
RIB60706-20-C	<input type="checkbox"/>		2°	6	1.12	45	4
RIB60706-30-C	<input type="checkbox"/>		3°	6	1.33	45	4
RIB60804-02-C	<input type="checkbox"/>	0.8	15'	4	0.83	45	4
RIB60806-05-C	<input type="checkbox"/>		30'	6	0.90	45	4
RIB60810-05-C	<input type="checkbox"/>		30'	10	0.97	45	4
RIB60806-10-C	<input type="checkbox"/>		1°	6	1.01	45	4
RIB60810-10-C	<input type="checkbox"/>		1°	10	1.15	45	4
RIB60806-15-C	<input type="checkbox"/>		1° 30'	6	1.11	45	4
RIB60810-15-C	<input type="checkbox"/>		1° 30'	10	1.32	45	4
RIB60806-20-C	<input type="checkbox"/>		2°	6	1.22	45	4
RIB60810-20-C	<input type="checkbox"/>		2°	10	1.50	45	4
RIB60806-30-C	<input type="checkbox"/>		3°	6	1.43	45	4
RIB60810-30-C	<input type="checkbox"/>	3°	10	1.85	45	4	
RIB60908-05-C	<input type="checkbox"/>	0.9	30'	8	1.04	45	4
RIB60908-10-C	<input type="checkbox"/>		1°	8	1.18	45	4
RIB60908-15-C	<input type="checkbox"/>		1° 30'	8	1.32	45	4
RIB60908-20-C	<input type="checkbox"/>		2°	8	1.46	45	4
RIB60908-30-C	<input type="checkbox"/>		3°	8	1.74	45	4
RIB61005-02-C	<input type="checkbox"/>	1	15'	5	1.04	45	4
RIB61005-05-C	<input type="checkbox"/>		30'	5	1.09	45	4
RIB61008-05-C	<input type="checkbox"/>		30'	8	1.14	45	4
RIB61012-05-C	<input type="checkbox"/>		30'	12	1.21	45	4
RIB61005-10-C	<input type="checkbox"/>		1°	5	1.17	45	4
RIB61008-10-C	<input type="checkbox"/>		1°	8	1.28	45	4
RIB61012-10-C	<input type="checkbox"/>		1°	12	1.42	45	4
RIB61005-15-C	<input type="checkbox"/>		1° 30'	5	1.26	45	4
RIB61008-15-C	<input type="checkbox"/>		1° 30'	8	1.42	45	4
RIB61012-15-C	<input type="checkbox"/>		1° 30'	12	1.63	45	4
RIB61005-20-C	<input type="checkbox"/>		2°	5	1.35	45	4
RIB61008-20-C	<input type="checkbox"/>		2°	8	1.56	45	4
RIB61012-20-C	<input type="checkbox"/>	2°	12	1.84	45	4	
RIB61005-30-C	<input type="checkbox"/>	3°	5	1.52	45	4	
RIB61008-30-C	<input type="checkbox"/>	3°	8	1.84	45	4	
RIB61012-30-C	<input type="checkbox"/>	3°	12	2.26	45	4	

商品コード Item code	在庫 Stock	寸法 Size (mm)					
		外径 Tool dia.	刃部テーパ半角 Taper angle on side	刃長 Flute length	大端径 Large edge dia.	全長 Overall length	シャンク径 Shank dia.
RIB61110-05-C	<input type="checkbox"/>	1.1	30'	10	1.27	45	4
RIB61110-10-C	<input type="checkbox"/>		1°	10	1.45	45	4
RIB61110-15-C	<input type="checkbox"/>		1° 30'	10	1.62	45	4
RIB61110-20-C	<input type="checkbox"/>		2°	10	1.80	45	4
RIB61110-30-C	<input type="checkbox"/>		3°	10	2.15	45	4
RIB61206-02-C	<input type="checkbox"/>	1.2	15'	6	1.25	45	4
RIB61206-05-C	<input type="checkbox"/>		30'	6	1.30	45	4
RIB61210-05-C	<input type="checkbox"/>		30'	10	1.37	45	4
RIB61216-05-C	<input type="checkbox"/>		30'	16	1.48	45	4
RIB61206-10-C	<input type="checkbox"/>		1°	6	1.41	45	4
RIB61210-10-C	<input type="checkbox"/>		1°	10	1.55	45	4
RIB61216-10-C	<input type="checkbox"/>		1°	16	1.76	45	4
RIB61206-15-C	<input type="checkbox"/>		1° 30'	6	1.51	45	4
RIB61210-15-C	<input type="checkbox"/>		1° 30'	10	1.72	45	4
RIB61216-15-C	<input type="checkbox"/>		1° 30'	16	2.04	45	4
RIB61206-20-C	<input type="checkbox"/>	2°	6	1.62	45	4	
RIB61210-20-C	<input type="checkbox"/>	2°	10	1.90	45	4	
RIB61216-20-C	<input type="checkbox"/>	2°	16	2.32	45	4	
RIB61206-30-C	<input type="checkbox"/>	3°	6	1.83	45	4	
RIB61210-30-C	<input type="checkbox"/>	3°	10	2.25	45	4	
RIB61216-30-C	<input type="checkbox"/>	3°	16	2.88	45	4	
RIB61312-05-C	<input type="checkbox"/>	1.3	30'	12	1.51	45	4
RIB61312-10-C	<input type="checkbox"/>		1°	12	1.72	45	4
RIB61312-15-C	<input type="checkbox"/>		1° 30'	12	1.93	45	4
RIB61312-20-C	<input type="checkbox"/>		2°	12	2.14	45	4
RIB61312-30-C	<input type="checkbox"/>		3°	12	2.56	45	4
RIB61412-05-C	<input type="checkbox"/>	1.4	30'	12	1.61	45	4
RIB61412-10-C	<input type="checkbox"/>		1°	12	1.82	45	4
RIB61412-15-C	<input type="checkbox"/>		1° 30'	12	2.03	45	4
RIB61412-20-C	<input type="checkbox"/>		2°	12	2.24	45	4
RIB61412-30-C	<input type="checkbox"/>		3°	12	2.66	45	4
RIB61508-02-C	<input type="checkbox"/>	1.5	15'	8	1.57	45	4
RIB61508-05-C	<input type="checkbox"/>		30'	8	1.64	45	4
RIB61508-10-C	<input type="checkbox"/>		1°	8	1.78	45	4
RIB61508-15-C	<input type="checkbox"/>		1° 30'	8	1.92	45	4
RIB61508-20-C	<input type="checkbox"/>		2°	8	2.06	45	4
RIB61508-30-C	<input type="checkbox"/>		3°	8	2.34	45	4
RIB61512-05-C	<input type="checkbox"/>		30'	12	1.71	45	4
RIB61512-10-C	<input type="checkbox"/>		1°	12	1.92	45	4
RIB61512-15-C	<input type="checkbox"/>		1° 30'	12	2.13	45	4
RIB61512-20-C	<input type="checkbox"/>		2°	12	2.34	45	4
RIB61512-30-C	<input type="checkbox"/>		3°	12	2.76	45	4
RIB61520-05-C	<input type="checkbox"/>		30'	20	1.85	50	4
RIB61520-10-C	<input type="checkbox"/>	1°	20	2.20	50	4	
RIB61520-15-C	<input type="checkbox"/>	1° 30'	20	2.55	50	4	
RIB61520-20-C	<input type="checkbox"/>	2°	20	2.90	50	4	
RIB61520-30-C	<input type="checkbox"/>	3°	20	3.60	50	4	

□印：特定代理店在庫です。弊社営業へお問合せください。□：Stocked by specified distributor. Contact with our sales department.

超硬Cコートエンドミル"リブスター"

RIB6○○○○-○○-C

超硬Cコートエンドミル 特定代理店在庫品

商品コード Item code	在庫 Stock	寸法 Size (mm)					
		外径 Tool dia.	刃部テーパ半角 Taper angle on side	刃長 Flute length	大端径 Large edge dia.	全長 Overall length	シャンク径 Shank dia.
RIB61616-05-C	<input type="checkbox"/>	1.6	30'	16	1.88	50	4
RIB61616-10-C	<input type="checkbox"/>		1°	16	2.16	50	4
RIB61616-15-C	<input type="checkbox"/>		1° 30'	16	2.44	50	4
RIB61616-20-C	<input type="checkbox"/>		2°	16	2.72	50	4
RIB61616-30-C	<input type="checkbox"/>		3°	16	3.28	50	4
RIB61716-05-C	<input type="checkbox"/>	1.7	30'	16	1.98	50	4
RIB61716-10-C	<input type="checkbox"/>		1°	16	2.26	50	4
RIB61716-15-C	<input type="checkbox"/>		1° 30'	16	2.54	50	4
RIB61716-20-C	<input type="checkbox"/>		2°	16	2.82	50	4
RIB61716-30-C	<input type="checkbox"/>		3°	16	3.38	50	4
RIB61810-02-C	<input type="checkbox"/>	1.8	15'	10	1.89	50	4
RIB61810-05-C	<input type="checkbox"/>		30'	10	1.97	50	4
RIB61816-05-C	<input type="checkbox"/>		30'	16	2.08	50	4
RIB61820-05-C	<input type="checkbox"/>		30'	20	2.15	50	4
RIB61810-10-C	<input type="checkbox"/>		1°	10	2.15	50	4
RIB61816-10-C	<input type="checkbox"/>		1°	16	2.36	50	4
RIB61820-10-C	<input type="checkbox"/>		1°	20	2.50	50	4
RIB61810-15-C	<input type="checkbox"/>		1° 30'	10	2.32	50	4
RIB61816-15-C	<input type="checkbox"/>		1° 30'	16	2.64	50	4
RIB61820-15-C	<input type="checkbox"/>		1° 30'	20	2.85	50	4
RIB61810-20-C	<input type="checkbox"/>		2°	10	2.50	50	4
RIB61816-20-C	<input type="checkbox"/>		2°	16	2.92	50	4
RIB61820-20-C	<input type="checkbox"/>		2°	20	3.20	50	4
RIB61810-30-C	<input type="checkbox"/>		3°	10	2.85	50	4
RIB61816-30-C	<input type="checkbox"/>		3°	16	3.48	50	4
RIB61820-30-C	<input type="checkbox"/>	3°	20	3.90	50	4	
RIB61920-05-C	<input type="checkbox"/>	1.9	30'	20	2.25	50	4
RIB61920-10-C	<input type="checkbox"/>		1°	20	2.60	50	4
RIB61920-15-C	<input type="checkbox"/>		1° 30'	20	2.95	50	4
RIB61920-20-C	<input type="checkbox"/>		2°	20	3.30	50	4
RIB61920-30-C	<input type="checkbox"/>		3°	20	4.00	50	4
RIB62012-02-C	<input type="checkbox"/>	2	15'	12	2.10	50	4
RIB62012-05-C	<input type="checkbox"/>		30'	12	2.21	50	4

商品コード Item code	在庫 Stock	寸法 Size (mm)					
		外径 Tool dia.	刃部テーパ半角 Taper angle on side	刃長 Flute length	大端径 Large edge dia.	全長 Overall length	シャンク径 Shank dia.
RIB62020-05-C	<input type="checkbox"/>	2	30'	20	2.35	50	4
RIB62025-05-C	<input type="checkbox"/>		30'	25	2.44	50	4
RIB62012-10-C	<input type="checkbox"/>		1°	12	2.42	50	4
RIB62020-10-C	<input type="checkbox"/>		1°	20	2.70	50	4
RIB62025-10-C	<input type="checkbox"/>		1°	25	2.87	50	4
RIB62012-15-C	<input type="checkbox"/>		1° 30'	12	2.63	50	4
RIB62020-15-C	<input type="checkbox"/>		1° 30'	20	3.05	50	4
RIB62025-15-C	<input type="checkbox"/>		1° 30'	25	3.31	50	4
RIB62012-20-C	<input type="checkbox"/>		2°	12	2.84	50	4
RIB62020-20-C	<input type="checkbox"/>		2°	20	3.40	50	4
RIB62025-20-C	<input type="checkbox"/>	2°	25	3.75	50	4	
RIB62012-30-C	<input type="checkbox"/>	2.5	3°	12	3.26	50	4
RIB62020-30-C	<input type="checkbox"/>		3°	20	4.10	70	6
RIB62025-30-C	<input type="checkbox"/>		3°	25	4.62	70	6
RIB62520-05-C	<input type="checkbox"/>		30'	20	2.85	70	6
RIB62530-05-C	<input type="checkbox"/>		30'	30	3.02	70	6
RIB62520-10-C	<input type="checkbox"/>		1°	20	3.20	70	6
RIB62530-10-C	<input type="checkbox"/>		1°	30	3.55	70	6
RIB62520-15-C	<input type="checkbox"/>		1° 30'	20	3.55	70	6
RIB62530-15-C	<input type="checkbox"/>		1° 30'	30	4.07	70	6
RIB62520-20-C	<input type="checkbox"/>		2°	20	3.90	70	6
RIB62530-20-C	<input type="checkbox"/>	2°	30	4.60	70	6	
RIB62520-30-C	<input type="checkbox"/>	3	3°	20	4.60	70	6
RIB62530-30-C	<input type="checkbox"/>		3°	30	5.64	70	6
RIB63025-05-C	<input type="checkbox"/>		30'	25	3.44	70	6
RIB63040-05-C	<input type="checkbox"/>		30'	40	3.70	70	6
RIB63025-10-C	<input type="checkbox"/>	3	1°	25	3.87	70	6
RIB63040-10-C	<input type="checkbox"/>		1°	40	4.40	70	6
RIB63025-15-C	<input type="checkbox"/>		1° 30'	25	4.31	70	6
RIB63040-15-C	<input type="checkbox"/>		1° 30'	40	5.09	70	6
RIB63025-20-C	<input type="checkbox"/>		2°	25	4.75	70	6
RIB63040-20-C	<input type="checkbox"/>		2°	40	5.79	70	6
RIB63025-30-C	<input type="checkbox"/>		3°	25	5.62	70	6

標準切削条件表 Recommended cutting conditions RIB-C

<溝切削> Slotting

外径 DC mm	切込み (ap) Depth of cut mm / pass	一般構造用炭素鋼 Mild carbon steels		合金鋼 Alloy steels		アルミ合金 Aluminum alloys	
		回転数 min ⁻¹	送り速度 mm / min	回転数 min ⁻¹	送り速度 mm / min	回転数 min ⁻¹	送り速度 mm / min
0.6	0.01 ~ 0.02	32,000	400	22,000	250	50,000	500
0.8	0.01 ~ 0.03	24,000	400	16,000	300	32,000	600
1.0	0.03 ~ 0.05	19,000	450	13,000	300	28,000	600
1.5	0.03 ~ 0.08	12,700	500	8,500	300	24,000	600
2.0	0.05 ~ 0.15	9,600	500	6,400	400	19,000	800
2.5	0.07 ~ 0.20	7,600	600	5,000	400	12,000	800
3.0	0.09 ~ 0.25	6,300	600	4,200	400	10,000	800

【注意】

- ①被削材、加工形状に合わせて、適切なクーラントを使用してください。
- ②この標準切削条件表は切削条件の目安を示すものです。実際の加工では加工形状、目的、使用機械等により条件を調整してください。

【Note】

- ① Use the appropriate coolant for the work material and machining shape.
- ② These Recommended Cutting Conditions indicate only the rule of a thumb for the cutting conditions. In actual machining, the condition should be adjusted according to the machining shape, purpose and the machine type.

対応被削材 Applicable work material

炭素鋼 合金鋼 Carbon steel Alloy steel	プリハードン鋼 Pre-hardened steel ≤ 45HRC	高硬度 Hardened steel			ステンレス鋼 Stainless steel	チタン合金 耐熱合金 Titanium alloy Heat-resistant alloy	銅合金 Copper alloy	アルミ合金 Aluminum alloy
		> 45HRC ≤ 55HRC	> 55HRC ≤ 65HRC	> 65HRC				
○	○	○	○	○	○	○	○	

○印：特定代理店在庫です。弊社営業へお問合せください。□：Stocked by specified distributor. Contact with our sales department.

Epoch Roughing エポックラフィング

ステンレスなどの難削材荒加工に適したラフィングエンドミル。
Ideal roughing end mill for roughing of difficult-to-cut materials such as stainless steel, etc.

ショート刃長 Short

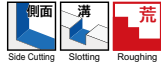

外径公差 0~-0.05



(mm)

4枚刃
4Flutes



ミディウム刃長 Medium

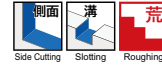

外径公差 0~-0.05



(mm)

4枚刃
4Flutes



EPQS4--CS

超硬 CS ねじり30° 切削条件表 A370
Carbide Helix angle Cutting Conditions

商品コード Item code	在庫 Stock	寸法 Size (mm)					形状 Shape
		外径 Tool dia.	刃長 Flute length	全長 Overall length	シャンク径 Shank dia.	コーナ 面取り幅 Corner chamfering width	
EPQS4060-CS	<input type="checkbox"/>	6	12	50	6	0.4	A
EPQS4080-CS	<input type="checkbox"/>	8	16	60	8	0.5	A
EPQS4100-CS	<input type="checkbox"/>	10	18	70	10	0.5	A
EPQS4120-CS	<input type="checkbox"/>	12	22	75	12	0.5	A
EPQS4160-CS	<input type="checkbox"/>	16	27	90	16	0.7	A
EPQS4200-CS	<input type="checkbox"/>	20	35	100	20	0.7	A

EPQM4--CS

超硬 CS ねじり30° 切削条件表 A370
Carbide Helix angle Cutting Conditions

商品コード Item code	在庫 Stock	寸法 Size (mm)					形状 Shape
		外径 Tool dia.	刃長 Flute length	全長 Overall length	シャンク径 Shank dia.	コーナ 面取り幅 Corner chamfering width	
EPQM4060-CS	<input type="checkbox"/>	6	20	60	6	0.4	A
EPQM4070-CS	<input type="checkbox"/>	7	30	80	8	0.4	B
EPQM4080-CS	<input type="checkbox"/>	8	30	80	8	0.5	A
EPQM4090-CS	<input type="checkbox"/>	9	35	90	10	0.5	B
EPQM4100-CS	<input type="checkbox"/>	10	35	90	10	0.5	A
EPQM4110-CS	<input type="checkbox"/>	11	45	110	12	0.5	B
EPQM4120-CS	<input type="checkbox"/>	12	45	110	12	0.5	A
EPQM4130-CS	<input type="checkbox"/>	13	50	120	16	0.7	B
EPQM4140-CS	<input type="checkbox"/>	14	50	120	16	0.7	B
EPQM4150-CS	<input type="checkbox"/>	15	50	120	16	0.7	B
EPQM4160-CS	<input type="checkbox"/>	16	55	125	16	0.7	A
EPQM4170-CS	<input type="checkbox"/>	17	55	125	20	0.7	B
EPQM4180-CS	<input type="checkbox"/>	18	65	135	20	0.7	B
EPQM4190-CS	<input type="checkbox"/>	19	65	135	20	0.7	B
EPQM4200-CS	<input type="checkbox"/>	20	70	145	20	0.7	A

ロングシャンク Long Shank



外径公差 0~-0.05



(mm)

4枚刃
4Flutes



EPQLS4--CS

超硬 CS ねじり30° 切削条件表 A370
Carbide Helix angle Cutting Conditions

商品コード Item code	在庫 Stock	寸法 Size (mm)					形状 Shape
		外径 Tool dia.	刃長 Flute length	全長 Overall length	シャンク径 Shank dia.	コーナ 面取り幅 Corner chamfering width	
EPQLS4060-CS	<input type="checkbox"/>	6	9	120	5	0.4	C
EPQLS4070-CS	<input type="checkbox"/>	7	9	120	6	0.4	C
EPQLS4080-CS	<input type="checkbox"/>	8	12	135	7	0.5	C
EPQLS4090-CS	<input type="checkbox"/>	9	12	135	8	0.5	C
EPQLS4100-CS	<input type="checkbox"/>	10	15	150	9	0.5	C
EPQLS4110-CS	<input type="checkbox"/>	11	15	150	10	0.5	C
EPQLS4120-CS	<input type="checkbox"/>	12	18	160	11	0.5	C
EPQLS4130-CS	<input type="checkbox"/>	13	18	160	12	0.7	C
EPQLS4140-CS	<input type="checkbox"/>	14	18	160	13	0.7	C
EPQLS4150-CS	<input type="checkbox"/>	15	22	180	14	0.7	C
EPQLS4160-CS	<input type="checkbox"/>	16	24	180	15	0.7	C
EPQLS4170-CS	<input type="checkbox"/>	17	24	180	16	0.7	C
EPQLS4180-CS	<input type="checkbox"/>	18	27	180	16	0.7	C
EPQLS4190-CS	<input type="checkbox"/>	19	30	200	18	0.7	C
EPQLS4200-CS	<input type="checkbox"/>	20	30	200	18	0.7	C

エポックラフィングの工具形状 Tool shape of Epoch Roughing

Aタイプ A type

Bタイプ B type

Cタイプ C type

EPQS-CS、EPQM-CS、EPQLS-CSの対応被削材

Applicable work material of EPQS-CS, EPQM-CS, EPQLS-CS

炭素鋼 合金鋼 Carbon steel Alloy steel	プリハー ド鋼 Pre-hardened steel	高硬度 Hardened steel			ステン レス鋼 Stainless steel	チタン合金 耐熱合金 Titanium alloy Heat-resistant alloy	銅合金 Copper alloy	アルミ 合金 Aluminum alloy
		> 45HRC ≤ 55HRC	> 55HRC ≤ 65HRC	> 65HRC				
◎	◎	○			◎	◎	◎	

□印：特定代理店在庫です。弊社営業へお問合せください。 □：Stocked by specified distributor. Contact with our sales department.

Carbide End Mills

Stocked by Specified distributor

CBN Miniature End Mills

CBN小径エンドミル

超硬ミニエンドミル
特定代理店在庫品

■ スクエア刃 Square End

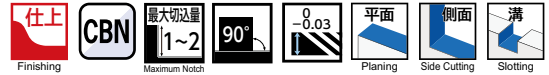

商品コード Item code	在庫 Stock	寸法 Size(mm)			刃数 No. of Flutes
		外径 Tool dia.	刃長 Flute length	首下長 Under neck length	
		DC	APMX	LU	
BHS2010	<input type="checkbox"/>	1.0	0.5	2.5	2
BHS2015	<input type="checkbox"/>	1.5	0.75	2.5	2
BHS2020	<input type="checkbox"/>	2.0	1.0	2.5	2

■ コーナR付 Radius End

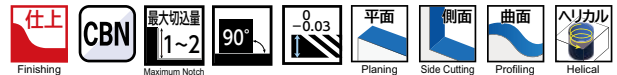

商品コード Item code	在庫 Stock	寸法 Size(mm)			刃数 No. of Flutes	
		外径 Tool dia.	刃長 Flute length	首下長 Under neck length		
		DC	APMX	RE		
BHSR2010-0.1	<input type="checkbox"/>	1.0	0.5	0.1	2.5	2
BHSR2010-0.2	<input type="checkbox"/>	1.0	0.5	0.2	2.5	2
BHSR2010-0.3	<input type="checkbox"/>	1.0	0.5	0.3	2.5	2
BHSR2015-0.1	<input type="checkbox"/>	1.5	0.75	0.1	2.5	2
BHSR2015-0.2	<input type="checkbox"/>	1.5	0.75	0.2	2.5	2
BHSR2015-0.3	<input type="checkbox"/>	1.5	0.75	0.3	2.5	2
BHSR2020-0.1	<input type="checkbox"/>	2.0	1.0	0.1	2.5	2
BHSR2020-0.2	<input type="checkbox"/>	2.0	1.0	0.2	2.5	2
BHSR2020-0.3	<input type="checkbox"/>	2.0	1.0	0.3	2.5	2
BHSR2020-0.5	<input type="checkbox"/>	2.0	1.0	0.5	2.5	2

■ ボール刃 Ball End



商品コード Item code	在庫 Stock	寸法 Size(mm)			刃数 No. of Flutes	
		ボール半径 Ball radius	外径 Tool dia.	刃長 Flute length		
		RE	DC	APMX		
BHB2010	<input type="checkbox"/>	0.5	1.0	0.5	2.5	2
BHB2015	<input type="checkbox"/>	0.75	1.5	0.75	2.5	2
BHB2020	<input type="checkbox"/>	1.0	2.0	1.0	2.5	2

[注意] 先端刃部のCBNはシャンクにろう付されていますので、焼ばめ式のツーリングを使用される場合は先端が500℃以上にならないよう注意下さい。

[Note] CBN tip is brazed on a body. Please be careful to use shrink tooling not to heat up over 500°C.

○ BHS、BHSR、BHBの対応被削材

Applicable work material of BHS, BHSR, BHB

炭素鋼 合金鋼 Carbon steel Alloy steel	プリハードン鋼 Pre-hardened steel ≤ 45HRC	高硬度 Hardened steel			ステンレス鋼 Stainless steel	チタン合金 耐熱合金 Titanium alloy Heat-resistant alloy	銅合金 Copper alloy	アルミ合金 Aluminum alloy
		> 45HRC ≤ 55HRC	> 55HRC ≤ 65HRC	> 65HRC				
	○	○						

○印：特定代理店在庫です。弊社営業へお問合せください。 □：Stocked by specified distributor. Contact with our sales department.

ソリッドエンドミル用コーティング材種

PVD Technology **ATHコーティング** ATH Coating

特長と機能 Features and characteristics

- THコーティングの硬度と耐酸化性をさらに改善。高硬度材切削加工の長寿命化、高能率が可能になりました。
(結晶粒子がさらに微細化したSi系ナノコンポジットコーティングです)
- 高硬度材料(55HRC以上)の切削加工に良好な性能を発揮します。
冷間ダイス鋼、高速度鋼、工具鋼
- ドライでもウェットでも長寿命。
- Hardness and oxidation resistance of TH coatings is further improved. Enables longer life and higher efficient when cutting high-hardness materials.
(Si nano composite coating with finer crystal particles)
- Exhibits amazing performance when cutting high-hardness materials (55HRC or higher)
Cold-worked die steel, HSS, tool steel.
- Long life for both dry cutting and wet cutting

PVD Technology **TH3コーティング** TH3 Coating

特長と機能 Features and characteristics

- 優れた耐摩耗性・耐熱性を有する高硬度皮膜
- 優れた耐衝撃性を有し、突発的な欠損を抑制
- 焼入れ鋼など50HRCを超える高硬度鋼の加工領域において長寿命
 - ・ High hardness coating with excellent wear resistance and heat resistance
 - ・ Has excellent thermal shock resistance enables to suppress sudden chipping
 - ・ Long tool life when cutting high-hardness materials (50HRC or higher) such as hardened steel

ターゲットとなる鋼種 Target steel grade

- 焼入れ鋼などの高硬度鋼(特に50HRC以上)、ハイス鋼
 - ・ Hardened steel (especially 50HRC or higher), high-speed steel

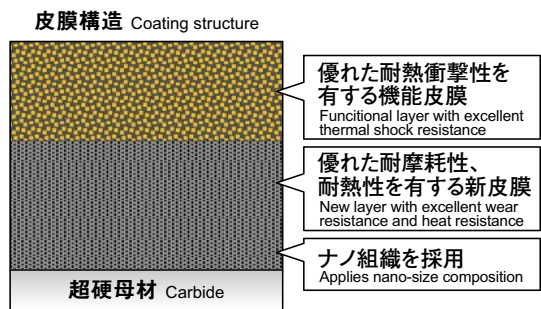

● 新皮膜は“ナノ組織”の適用により、皮膜の破壊単位を小さくする事に成功! New coating achieves to reduce destruction unit of layer by applying "nano-size composition".

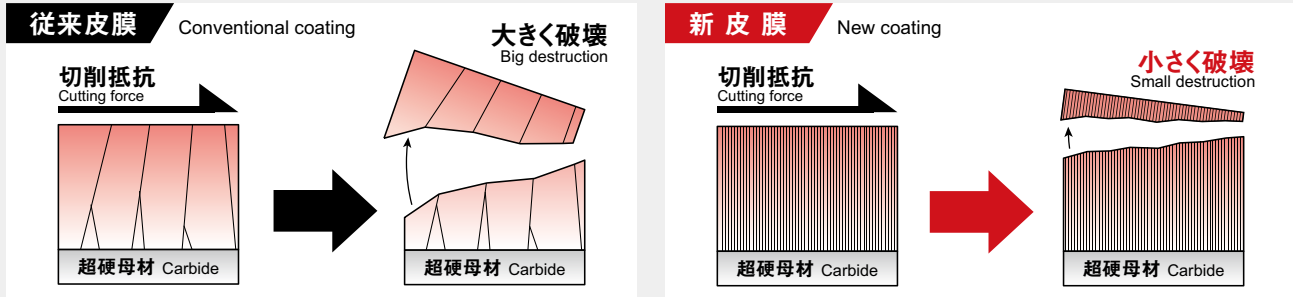

PVD Technology **PNコーティング** PN Coating

特長と機能 Features and characteristics

- Al含有量の調整により、特に工具母材との密着性に優れた耐熱コーティング材料です。
 - プラスチック金型等の工具への溶着が起りやすい材料の切削に対して、良好な切削寿命を示します。(従来対比切削寿命2倍)
HPM-MAGICをはじめとしたプリハードン鋼、炭素鋼、合金鋼、SUS系、SKD61、SKD11等の切削加工で長寿命です。
 - 耐熱性の向上により、ウェット切削及びドライ切削においても長寿命化が可能です。
- 注) 本工具のPNコーティングはその性質上、通電性が微小です。従って、通電方式の工具長測定装置をご使用の際にはご注意ください。
- ・ A heat-resistant coating material with excellent adhesion to the tool substrate was achieved by optimizing the Al content.
 - ・ Exhibits excellent cutting life for cutting materials such as plastic molds, etc. where tool seizure often occurs. (2x the cutting life compared to conventional products.)
 - ・ Provides the long life in cutting processing of materials starting with HPM-MAGIC and including prehardened steel, carbon steel, alloy steel, SUS, SKD61, SKD11, etc.
 - ・ By improving heat resistance, long life are possible for both wet cutting and dry cutting.
- Note) This product obtains less electric conductivity. Therefore, Please caution of using electric transmitted measuring systems.

PNコーティングの密着性 Adhesion of PN coating 母材：超硬合金 Substrate: Carbide alloy

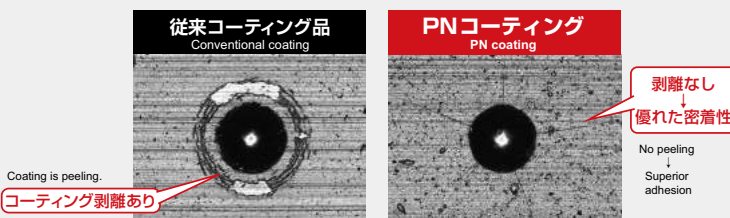

PNコーティングの皮膜断面組織と特性
Cross-sectional structure and characteristics of PN coating membrane

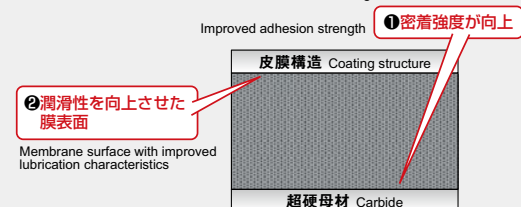

PVD Technology **SDコーティング SD Coating**

○ 特長と機能 Features and characteristics

- **高硬度**
ダイヤモンドに限りなく近い、水素フリーDLCコーティングです。
- **高耐熱温度**
不純物が少なく高耐熱性、高能率加工が可能です。
- **高能率切削加工**
アルミ合金や樹脂の切削加工に効果を発揮、発熱が少なくドライ切削に向いています。
- **High hardness**
The hydrogen-free DLC coating infinitely close to that of diamond.
- **High heat-resistance temperature**
Impurities are low, providing high heat resistance and enabling high-efficiency machining.
- **High-efficiency cutting machining**
Cutting machining of aluminum alloys or resins showcases the effects, with low heat generation making it ideal for dry cutting.

■ **超硬インサート工具の表面異常粒子の比較**
Comparison of abnormal surface particles on carbide insert tools

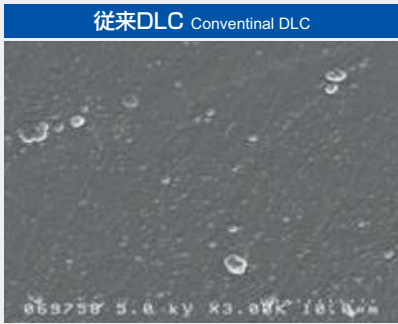

High adhesion **ダイヤモンドコーティング Diamond Coating HD**

○ 機能 Characteristics

- 結晶性のよいダイヤモンドを採用。グラファイトや高Siアルミニウム合金、繊維強化プラスチック(FRP)の切削加工に適します。
- 独自の前処理技術を採用。アンカー効果により密着性向上
- 母材にはダイヤモンドコーティング専用材種を採用
- Uses diamond with good crystallization. Ideal for cutting of graphite, high-silicon aluminum alloys and fiber-reinforced plastics (FRP).
- Our exclusive pre-treatment technology is used to provide higher adhesion due to anchor effect.
- Special material for diamond coating is adopted for base metal.

表面状態
Surface condition

HD
コーティング
HD Coating

5μm

ダイヤモンド皮膜
Diamond layer

コーティング断面
Cross section of coating

専用母材
Special base metal

異形工具 **GALLEA**

Special Shape Tools



高能率仕上げ加工用 異形工具(ソリッドタイプ)

High Efficiency Finishing Special Shape Tool Series (Solid type)

GS4TNB2

高能率仕上げ加工用 刃先交換式異形工具シリーズ

High Efficiency Finishing Indexable Special Shape Tool Series

GF1B4

GF2TB6

GF3LB8

GP1LBB10

GP1TB12

環境負荷低減への配慮により、既に一部の製品についてはドライバー、ねじ焼き付け防止剤は別売りとさせていただきます。今後、従来品についても一部製品を除き、同梱を取りやめ、別売りとさせていただきます。

In consideration of reducing our environmental burden, we have already stopped bundling the screw driver and screw anti-seizure agent with certain products. They will no longer be supplied with conventional products (with certain exceptions), and will instead be sold separately.

GALLEA GS4TN

- 外周のパレルR刃は勾配面を高能率・高品位に！
 - 先端R刃は曲面の接続面を高品位に！
 - 独特な強ねじれ刃形状を採用、低抵抗化を実現！
- ・ Barrel R achieves high-efficiency and high-quality machining for tilted section
 ・ Tip R can finish curved connecting faces to high quality
 ・ Employs unique high helix shape and realizes low cutting force.

超硬 Carbide TH3 Helix angle ねじれ45° h5 Form tolerance フォーム公差：±0.01 切削条件表 B3 Cutting Conditions

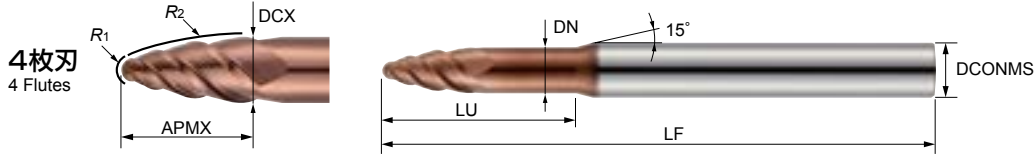

GS4TN R-TH3 ソリッドタイプ Solid type

商品コード Item code	在庫 Stock	寸法 Size (mm)							
		先端R Tip R R1	パレルR Barrel R R2	外径 Tool dia. DCX	刃長 Flute length APMX	首下長 Under neck length LU	首径 Neck dia. DN	全長 Overall length LF	シャンク径 Shank dia. DCONMS
GS4TN2.5-12.5R-TH3	◎	0.5	12.5	2.5	4.68	10	2.4	50	4
GS4TN3.75-18.75R-TH3	◎	0.75	18.75	3.75	7.01	15	3.65	50	4
GS4TN5-25R-TH3	◎	1	25	5	9.35	20	4.8	60	6
GS4TN7.5-37.5R-TH3	◎	1.5	37.5	7.5	14.03	30	7.3	75	8
GS4TN10-50R-TH3	◎	2	50	10	18.70	40	9.5	100	12

- ・ 本工具は再研磨対応しておりません。There is no regrinding compatibility for this tool.
- ・ 大径サイズは刃先交換式エンドミル「GP1T」をご使用ください。For the large diameter in size, use the indexable end mill "GP1T".

※工具の詳細形状についてはMOLDINOホームページよりDXFデータをダウンロードしてください。
 (MOLDINO工具選定データベース TOOL SEARCH : <https://data.moldino.com/toolsearch/>)

※For information on the detailed tool shape, download the DXF data from the MOLDINO Tool Engineering home page. (MOLDINO Tool Engineering tool selection database TOOL SEARCH: <https://data.moldino.com/toolsearch/>)

GS4TNの加工方法 Machining method of GS4TN

5軸加工機で使用する場合 When using with 5-axis machine

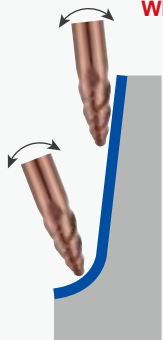

工具軸を傾斜し加工することでパレルR部を使用し、勾配面がピッチを大きく加工できます。
 更に先端R部を使用することで加工段差の少ない切削が可能です。

By using the barrel R with tilted tool axis, tilted section can be cut with large pitch.
 Furthermore, it is possible to cut with less machining steps by using the tip R.

GS4TNで加工可能 Processable with GS4TN

3軸加工機で使用する場合 When using with 3-axis machine

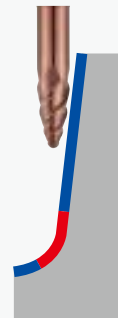

パレルR部を使用し、立ち壁に近い勾配面をピッチを大きく加工できます。
 但し、底部(隅部)等は別工具で加工する必要があります。

Barrel R enables to cut steep face with large pitch.
 However, it is necessary to process the bottom corner section with a separate tool.

別工具が必要 Needs separate tool

対応被削材 Applicable work material

炭素鋼 合金鋼 Carbon steel Alloy steel	炭素鋼 合金鋼 Pre-hardened steel	高硬度 Hardened steel			ステン レス鋼 Stainless steel	チタン合金 耐熱合金 Titanium alloy Heat-resistant alloy	銅合金 Copper alloy	アルミ 合金 Aluminum alloy
		> 45HRC ≤ 45HRC	> 55HRC ≤ 55HRC	> 65HRC ≤ 65HRC				
○	◎	◎	◎	◎				

再研磨対応外径範囲 Re-grinding compatibility range

商品コード Item code	外周 Outer dia. (mm)	エンド End (mm)
GS4TN	× (N/A)	× (N/A)

◎印：メーカー在庫品です。弊社営業へお問い合わせください。 ○印：Manufacturer stocked items. Contact with our sales office.

標準切削条件表 Recommended cutting conditions

● バレルR部 加工条件 Barrel R cutting conditions

被削材 Work material		炭素鋼・合金鋼 Carbon steels, Alloy steels ($<35\text{HRC}$)				プリハードン鋼 Pre-hardened steels ($35\sim45\text{HRC}$)				焼入れ鋼 Hardened steels ($45\sim55\text{HRC}$)				焼入れ鋼 Hardened steels ($55\sim65\text{HRC}$)				焼入れ鋼 Hardened steels ($65\sim72\text{HRC}$)			
先端R Tip R R1 (mm)	バレルR Barrel R R2 (mm)	回転数 n min ⁻¹	送り速度 v_f mm/min	a_p mm	a_e mm	回転数 n min ⁻¹	送り速度 v_f mm/min	a_p mm	a_e mm	回転数 n min ⁻¹	送り速度 v_f mm/min	a_p mm	a_e mm	回転数 n min ⁻¹	送り速度 v_f mm/min	a_p mm	a_e mm	回転数 n min ⁻¹	送り速度 v_f mm/min	a_p mm	a_e mm
0.5	12.5	23,550	3,060	0.22	0.05~0.1	19,100	2,480	0.22	0.05~0.1	17,830	1,960	0.22	0.05~0.1	16,550	1,820	0.22	0.01~0.05	12,730	1,400	0.22	0.01~0.05
0.75	18.75	15,700	2,670	0.27	0.05~0.1	13,840	2,460	0.27	0.05~0.1	11,880	1,780	0.27	0.05~0.1	11,370	1,640	0.27	0.01~0.05	8,570	1,230	0.27	0.01~0.05
1	25	11,780	2,540	0.32	0.05~0.1	10,500	2,260	0.32	0.05~0.1	9,130	1,670	0.32	0.05~0.1	7,040	1,440	0.32	0.01~0.05	6,490	1,100	0.32	0.01~0.05
1.5	37.5	7,850	1,990	0.39	0.05~0.1	6,930	1,780	0.39	0.05~0.1	6,190	1,390	0.39	0.05~0.1	4,460	1,230	0.39	0.01~0.05	4,290	920	0.39	0.01~0.05
2	50	5,890	1,680	0.45	0.05~0.1	5,100	1,460	0.45	0.05~0.1	4,510	1,130	0.45	0.05~0.1	3,520	1,000	0.45	0.01~0.05	3,190	770	0.45	0.01~0.05

● 先端R部 加工条件 Tip R cutting conditions

被削材 Work material		炭素鋼・合金鋼 Carbon steels, Alloy steels ($<35\text{HRC}$)				プリハードン鋼 Pre-hardened steels ($35\sim45\text{HRC}$)				焼入れ鋼 Hardened steels ($45\sim55\text{HRC}$)				焼入れ鋼 Hardened steels ($55\sim65\text{HRC}$)				焼入れ鋼 Hardened steels ($65\sim72\text{HRC}$)			
先端R Tip R R1 (mm)	バレルR Barrel R R2 (mm)	回転数 n min ⁻¹	送り速度 v_f mm/min	a_p mm	a_e mm	回転数 n min ⁻¹	送り速度 v_f mm/min	a_p mm	a_e mm	回転数 n min ⁻¹	送り速度 v_f mm/min	a_p mm	a_e mm	回転数 n min ⁻¹	送り速度 v_f mm/min	a_p mm	a_e mm	回転数 n min ⁻¹	送り速度 v_f mm/min	a_p mm	a_e mm
0.5	12.5	34,320	2,580	0.09	0.29	28,600	2,060	0.08	0.24	26,000	1,870	0.06	0.18	24,700	1,600	0.06	0.18	20,800	1,120	0.05	0.15
0.75	18.75	25,680	2,890	0.10	0.31	21,400	2,310	0.09	0.26	19,500	2,110	0.07	0.21	18,500	1,800	0.07	0.21	15,600	1,260	0.06	0.18
1	25	22,080	3,310	0.19	0.58	18,400	2,650	0.16	0.48	16,700	2,400	0.13	0.39	15,900	2,060	0.12	0.36	13,400	1,450	0.10	0.30
1.5	37.5	20,400	3,280	0.28	0.86	17,000	2,620	0.24	0.72	15,400	1,850	0.20	0.60	14,300	1,720	0.19	0.57	11,000	1,320	0.15	0.45
2	50	15,600	3,040	0.38	1.15	13,000	2,430	0.32	0.96	11,000	1,760	0.27	0.81	10,560	1,580	0.25	0.75	7,920	1,190	0.20	0.60

● バレルR部・先端R部 共通加工条件 Cutting conditions for using both barrel R and tip R

被削材 Work material		炭素鋼・合金鋼 Carbon steels, Alloy steels ($<35\text{HRC}$)		プリハードン鋼 Pre-hardened steels ($35\sim45\text{HRC}$)		焼入れ鋼 Hardened steels ($45\sim55\text{HRC}$)		焼入れ鋼 Hardened steels ($55\sim65\text{HRC}$)		焼入れ鋼 Hardened steels ($65\sim72\text{HRC}$)	
先端R Tip R R1 (mm)	バレルR Barrel R R2 (mm)	回転数 n min ⁻¹	送り速度 v_f mm/min	回転数 n min ⁻¹	送り速度 v_f mm/min	回転数 n min ⁻¹	送り速度 v_f mm/min	回転数 n min ⁻¹	送り速度 v_f mm/min	回転数 n min ⁻¹	送り速度 v_f mm/min
0.5	12.5	28,940	2,820	23,850	2,270	21,920	1,920	20,630	1,710	16,770	1,260
0.75	18.75	20,690	2,780	17,620	2,390	15,690	1,950	14,940	1,720	12,090	1,250
1	25	16,930	2,930	14,450	2,460	12,920	2,040	11,470	1,750	9,950	1,280
1.5	37.5	14,130	2,640	11,970	2,200	10,800	1,620	9,380	1,480	7,650	1,120
2	50	10,750	2,360	9,050	1,950	7,760	1,450	7,040	1,290	5,560	980

※切込み (a_p , a_e) については上記各部の条件をご参照ください
For cutting depth (a_p , a_e), refer to the above conditions for each section.

■ バレルRと先端Rの角度範囲

Angle range of barrel R and tip R

加工形状によって接触部がバレルR部・先端R部に分かれます。接触する箇所をご確認頂き、各箇所に応じた切削条件をご選択下さい。

Depending on the cutting shape, the contact section is divided into barrel R and tip R. Check the contact section and select the appropriate cutting conditions according to each section.

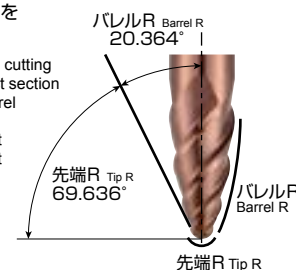

ap 値は所望のカスパイトにより下記表より選択してください。

Determine the a_p value based on the desired cusp height by selecting it from the table below.

使用工具 Tool		カスパイト Cusp height (mm)					
商品コード Item code	バレルR Barrel R	0.0001	0.0003	0.0005	0.001	0.003	0.005
GS4TN2.5-12.5R-TH3	12.5	0.10	0.17	0.22	0.32	0.55	0.71
GS4TN3.75-18.75R-TH3	18.75	0.12	0.21	0.27	0.39	0.67	0.87
GS4TN5-25R-TH3	25	0.14	0.24	0.32	0.45	0.77	1.00
GS4TN7.5-37.5R-TH3	37.5	0.17	0.30	0.39	0.55	0.95	1.22
GS4TN10-50R-TH3	50	0.20	0.35	0.45	0.63	1.10	1.41

■ GS4TN 工具形状について

About tool shape

GS4TNの「バレルR」は「先端R」と「外径」を2接円弧で結んだ形状になっています。

右図をご確認ください。
"Barrel R" of GS4TN has a shape that connects "tip R" and "tool diameter" with double arc. See the figure on the right.

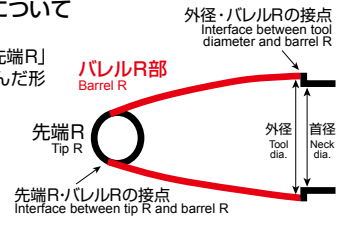

【注意】

- 被削材、加工形状に合わせて、適切なクーラントを使用してください。
- できるだけ高剛性、高精度の機械をご使用ください
- この切削条件表は切削条件の目安を示すものです。実際の加工では加工形状、目的、使用機械等により条件を調整してください。
- 機械の回転数が足りない場合は、回転数と送り速度を同じ比率で下げてください。

【Note】

- Use the appropriate coolant for the work material and machining shape.
- Use a machine having as high rigidity and high accuracy as possible.
- These conditions are for general guidance; in actual machining conditions adjust the parameters according to your actual machine and work-piece conditions.
- If the rpm of the machine is low, lower the feed rate also to put the rpm and feed rate in the same ratio.

- 仕上げ加工時間短縮に新提案。
- 等高線Zピッチを大きく設定できる
- ・ A new proposal for reducing finishing time.
- ・ Contour Z pitch can be set to larger values.



○は数字、□は英文字が入ります。Numeric figure in a circle ○ and Alphabetical character comes in a square □

GF1□20○○M-○-M○○ モジュラータイプ Modular type

モジュラーミル用シャンクはD2頁を、締め付けトルクについてはD5頁を参照ください。Refer page D2 about the shanks for Modular Mill, Refer page D5 about tightening torque

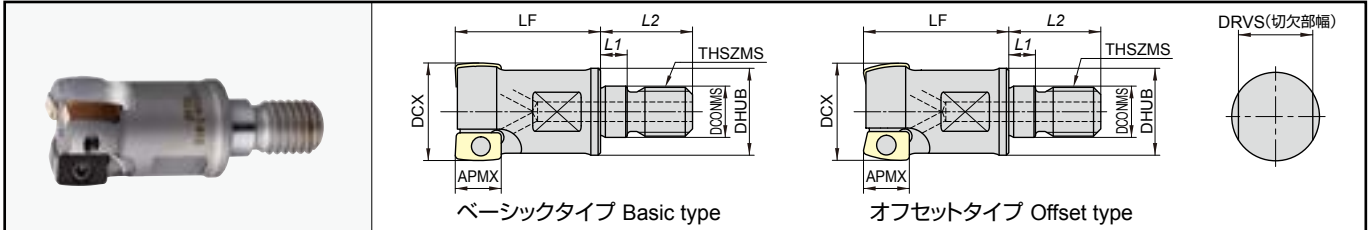

タイプ Type	商品コード Item code	在庫 Stock	刃数 No. of flutes	寸法 Size (mm)									使用インサート Insert	希望小売 価格(円) Suggested retail price(¥)
				DCX	LF	APMX	DCONMS	THSZMS	DHUB	L1	L2	DRVS		
ベーシック タイプ Basic type	GF1G2016M-2-M8	●	2	16	25	9.5	8.5	M8	14	5.5	17	10	XPHW0903R-20 XPHW0903R-30	36,950
	GF1G2020M-3-M10	●	3	20	30	9.5	10.5	M10	17.8	5.5	19	15		47,640
	※1 GF1G2025M-4-M10	●	4	25	30	9.5	10.5	M10	17.8	5.5	19	15		57,480
	GF1G2025M-4-M12	●	4	25	35	9.5	12.5	M12	22.5	5.5	22	17		57,480
オフセット タイプ Offset type	GF1T2016M-2-M8	●	2	16	25	9.5	8.5	M8	14	5.5	17	10	YPHW0903R-20 YPHW0903R-30	36,950
	GF1T2020M-3-M10	●	3	20	30	9.5	10.5	M10	17.8	5.5	19	15		47,640
	GF1T2025M-4-M12	●	4	25	35	9.5	12.5	M12	22.5	5.5	22	17		57,480

【注意】※1と超硬シャンクをセットで使用すると干渉がありません。
モジュラーミル及び専用シャンク、専用アーバの「工具端面」「モジュラーネジ部」にグリースなどの潤滑剤は塗布しないでください。

【Note】When ※1 and carbide shank are used together as a set, there is no interference.
Do not apply lubricants such as grease, etc. to the "contact faces" and "modular screws" of the "modular mill", "dedicated shanks" and "dedicated arbor".

※工具の詳細形状についてはMOLDINOホームページよりDXFデータをダウンロードしてください。(MOLDINO工具選定データベース TOOL SEARCH: <https://data.moldino.com/toolsearch/>)
※For information on the detailed tool shape, download the DXF data from the MOLDINO Tool Engineering home page. (MOLDINO Tool Engineering tool selection database TOOL SEARCH: <https://data.moldino.com/toolsearch/>)

インサート Inserts

タイプ Type	商品コード Item code	精度 Tolerance class	PN215		TH315		寸法 Size (mm) R	希望小売価格(円) Suggested retail price(¥)
			●	●	●	●		
ベーシックタイプ Basic type	XPHW0903R-20	H	●	●	20	1,430		
	XPHW0903R-30		●	●	30	1,430		
オフセットタイプ Offset type	YPHW0903R-20		●	●	20	1,430		
	YPHW0903R-30		●	●	30	1,430		

※工具の詳細形状についてはMOLDINOホームページよりDXFデータをダウンロードしてください。(MOLDINO工具選定データベース TOOL SEARCH: <https://data.moldino.com/toolsearch/>)
※For information on the detailed tool shape, download the DXF data from the MOLDINO Tool Engineering home page. (MOLDINO Tool Engineering tool selection database TOOL SEARCH: <https://data.moldino.com/toolsearch/>)

部品番号 Parts

形状 Shape	クランプねじ Clamp screw	ドライバー Screw driver	ねじ焼き付き防止剤 Screw anti-seizure agent
適用カット Cutter body			
GF1□20○○M-○-M○○	250-141	104-T8	P-37
	締め付けトルク Fastening torque (N·m)	希望小売価格(円) Suggested retail price (¥)	希望小売価格(円) Suggested retail price (¥)
	1.1	1,800	1,010

【注意】クランプねじは消耗品です。使用環境により交換寿命は変化しますので早めの交換をお願い致します。
【Note】The clamp screw is a consumable part. Since replacement life depends on the use environment, it is recommended that it be replaced at an early stage.

●印：標準在庫品です。 ●：Stocked items.

標準切削条件表 Recommended cutting conditions

※赤字は第一推奨材種です。Red indicates primary recommended grade.

被削材 Work material	推奨材種 Recommended grade	切削条件 Cutting condition	φ16	φ20	φ25
炭素鋼 Carbon steels 合金鋼 Alloy steels (<30HRC)	※PN215	n (min ⁻¹)	11,950	9,560	7,650
		vc (m/min)	600	600	600
		vf (mm/min)	4,780	5,740	6,120
		fz (mm/t)	0.2	0.2	0.2
		ap (mm)	右表を参照ください。Refer right table		
		ae (mm)	~0.1	~0.1	~0.1
炭素鋼 Carbon steels 合金鋼 Alloy steels (30~45HRC)	PN215 TH315	n (min ⁻¹)	7,970	6,370	5,100
		vc (m/min)	400	400	400
		vf (mm/min)	3,190	3,830	4,080
		fz (mm/t)	0.2	0.2	0.2
		ap (mm)	右表を参照ください。Refer right table		
		ae (mm)	~0.1	~0.1	~0.1
ステンレス鋼 Stainless steels SUS	PN215	n (min ⁻¹)	9,960	7,970	6,370
		vc (m/min)	500	500	500
		vf (mm/min)	3,990	4,790	5,100
		fz (mm/t)	0.2	0.2	0.2
		ap (mm)	右表を参照ください。Refer right table		
		ae (mm)	~0.1	~0.1	~0.1
鋳鉄 Cast irons FC FCD	TH315 PN215	n (min ⁻¹)	11,950	9,560	7,650
		vc (m/min)	600	600	600
		vf (mm/min)	5,980	7,170	7,650
		fz (mm/t)	0.25	0.25	0.25
		ap (mm)	右表を参照ください。Refer right table		
		ae (mm)	~0.1	~0.1	~0.1
焼入れ鋼 Hardened steels (45~55HRC)	TH315 PN215	n (min ⁻¹)	4,980	3,990	3,190
		vc (m/min)	250	250	250
		vf (mm/min)	1,500	1,800	1,920
		fz (mm/t)	0.15	0.15	0.15
		ap (mm)	右表を参照ください。Refer right table		
		ae (mm)	~0.08	~0.08	~0.08

ap値は所望のカスプハイトにより下記表より選択または下記計算式より算出してください

Determine the ap value based on the desired cusp height by selecting it from the table below or by calculating it using the equation below.

インサート Insert	カスプハイト (mm) Cusp height						
	商品コード Item code	R	0.001	0.002	0.003	0.004	0.005
XPHW0903R-20	20	0.4	0.57	0.69	0.8	0.89	1.26
XPHW0903R-30	30	0.49	0.69	0.85	0.98	1.1	1.55

$$a_p = 2 \sqrt{(R^2 - (R - H)^2)}$$

R: 工具R
Tool R

H: カスプハイト
Cusp height

※突き出し長さ3DCX以上の場合は、左記の表をもとに下記表を参考に調整してください。

When overhang length is 3DCX or greater, adjust the values shown in the table at left according to the table below.

突き出し比率 Overhang ratio	vc (m/min)	vf (mm/min)
<3DCX	100%	100%
3DCX ~ 5DCX	70%	70%
5DCX ~ 6DCX	60%	60%
6DCX ~ 7DCX	50%	50%
7DCX ~	45%	45%

- [注意]**
- ①被削材、加工形状に合わせて、適切なクーラントを使用してください。
 - ②この切削条件表は切削条件の目安を示すものです。実際の加工では加工形状、目的、使用機械等により条件を調整してください。
 - ③切りくず噛み込みによる工具損傷防止のため、必ずエアブロー等による切りくず除去を行ってください。
 - ④インサートの交換は早めに行い、過度の使用による破損を防止してください。

- [Note]**
- ①Use the appropriate coolant for the work material and machining shape.
 - ②These conditions are for general guidance; in actual machining conditions adjust the parameters according to your actual machine and work-piece conditions.
 - ③To prevent tool breakage due to chips clogging tool flutes, always be sure to use an air blower, etc. to remove chips.
 - ④Ensure to index the insert at the correct time to ensure safety of the tool-body.

プログラム上の刃先形状定義 Flute tip shape definitions for programing

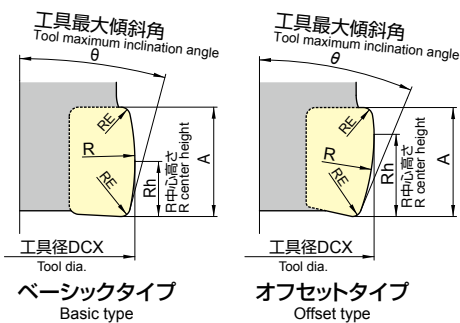

インサートと工具径の組み合わせにより回転軌跡形状が異なります。下記表を参照ください。
Rotation locus shape will be different depending on the combination of insert and tool diameter. Refer to the table below.

インサート型番 Insert item code	ベーシックタイプ Basic type						オフセットタイプ Offset type					
	XPHW0903R-20			XPHW0903R-30			YPHW0903R-20			YPHW0903R-30		
工具径 DCX (mm) Tool dia.	φ16	φ20	φ25	φ16	φ20	φ25	φ16	φ20	φ25	φ16	φ20	φ25
R (mm)	20.14	20	19.93	30.38	30	29.82	20.18	20	19.91	30.33	30	29.81
Rh (mm)	4.75	4.75	4.75	4.75	4.75	4.75	7.25	7.25	7.25	7.25	7.25	7.25
RE (mm)	0.8	0.8	0.8	0.8	0.8	0.8	0.8	0.8	0.8	0.8	0.8	0.8
A (mm)	9.5	9.5	9.5	9.5	9.5	9.5	9.5	9.5	9.5	9.5	9.5	9.5
θ	11°	11°	11°	7°	7°	7°	19°	19°	19°	12°	12°	12°

[注意] 小数点第三位以下を四捨五入した数値です。パラメトリックで形状定義する場合はDXFデータより必要寸法をご確認ください。

[Note] The numbers after the third decimal point are rounded off. When defining the shape parametrically, check the required dimensions from the DXF data.

GALLEA GF2T

- 高効率な傾斜壁面の仕上げ加工! ボールエンドミル、ラジラスエンドミルに比べ大ピッチで加工可能です。
 - 大径側にシリーズ展開しました!
 - 経済的な2コーナ仕様! ユニークなインサート拘束面により2コーナ仕様を実現しました。
- ・ High-performance tilted wall finishing! Enables machining at a larger pitch than ball end mills or radius end mills.
 ・ Series expansion toward larger diameters
 ・ Economical 2-corner specification. Unique insert holding surface enables realization of 2-corner specification



GF2T 30 M-0 モジュラータイプ Modular type

○は数字、□は英文字が入ります。Numeric figure in a circle ○ and Alphabetical character comes in a square □

モジュラーミル用シャンクはD2頁を、締め付けトルクについてはD5頁を参照ください。
Refer page D2 about the shanks for Modular Mill, Refer page D5 about tightening torque

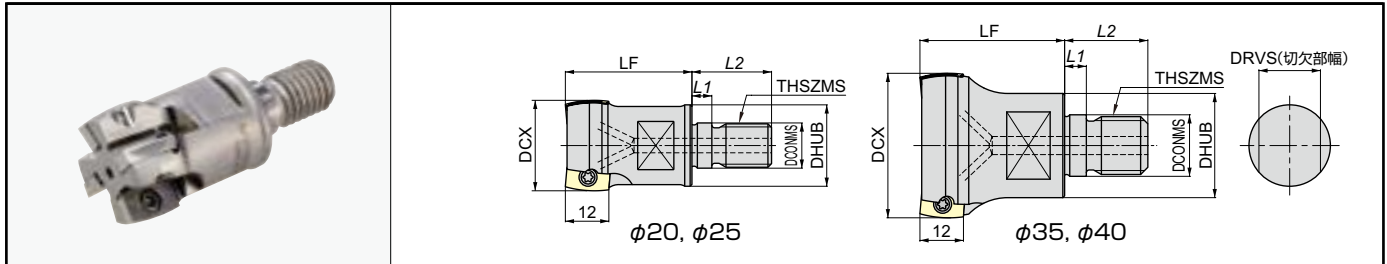

タイプ Type	商品コード Item code	在庫 Stock	刃数 No. of flutes	寸法 Size (mm)								使用インサート Insert	希望小売 価格(円) Suggested retail price(¥)
				DCX	LF	DCONMS	THSZMS	DHUB	L1	L2	DRVS		
オフセット タイプ Offset type	GF2T3020M-3	●	3	20	30	10.5	M10	17.8	5.5	19	15	YPHW1203R-30	47,640
	GF2T3025M-4	●	4	25	35	12.5	M12	22.5	5.5	22	17		57,480
	※1 GF2T3035M-5	●	5	35	40	17	M16	28.8	6	23	22		68,750
	※1 GF2T3040M-6	●	6	40	40	17	M16	28.8	6	23	22		79,310

【注意】※1と超硬シャンクをセットで使用すると干渉がありません。

モジュラーミル及び専用シャンク、専用アーバの「工具端面」「モジュラーネジ部」にグリースなどの潤滑剤は塗布しないでください。

【Note】When ※1 and carbide shank are used together as a set, there is no interference.

Do not apply lubricants such as grease, etc. to the "contact faces" and "modular screws" of the "modular mill", "dedicated shanks" and "dedicated arbor".

※工具の詳細形状についてはMOLDINOホームページよりDXFデータをダウンロードしてください。(MOLDINO工具選定データベース TOOL SEARCH: <https://data.moldino.com/toolsearch/>)

※For information on the detailed tool shape, download the DXF data from the MOLDINO Tool Engineering home page. (MOLDINO Tool Engineering tool selection database TOOL SEARCH: <https://data.moldino.com/toolsearch/>)

インサート Inserts

	P 炭素鋼・合金鋼 Carbon steels Alloy steels	■	□	■ : 一般切削・第一推奨 General cutting, First recommended □ : 一般切削・第二推奨 General cutting, Second recommended	
	M SUS等 SUS, etc.	■			
	K FC・FCD Cast irons	□	■		
	H 高硬度材 Hardened steels		■		
商品コード Item code	精度 Tolerance class	材種 Grade		寸法 Size (mm)	希望小売価格(円) Suggested retail price(¥)
YPHW1203R-30	H	PN215	TH315	R	1,920

※工具の詳細形状についてはMOLDINOホームページよりDXFデータをダウンロードしてください。(MOLDINO工具選定データベース TOOL SEARCH: <https://data.moldino.com/toolsearch/>)

※For information on the detailed tool shape, download the DXF data from the MOLDINO Tool Engineering home page. (MOLDINO Tool Engineering tool selection database TOOL SEARCH: <https://data.moldino.com/toolsearch/>)

部品番号 Parts

○は数字が入ります。 Numeric figure in a circle ○

	クランプねじ Clamp screw	ドライバー Screw driver	ねじ焼き付き防止剤 Screw anti-seizure agent
形状 Shape			
適用カット Cutter body	締め付けトルク Fastening torque (N·m)	希望小売価格(円) Suggested retail price (¥)	希望小売価格(円) Suggested retail price (¥)
GF2T30 M-0	265-143	2.0	870
		104-T10	1,920
			P-37
			1,010

【注意】クランプねじは消耗品です。使用環境により交換寿命は変化しますので早めの交換をお願い致します。

【Note】The clamp screw is a consumable part. Since replacement life depends on the use environment, it is recommended that it be replaced at an early stage.

●印：標準在庫品です。 ●：Stocked items.

標準切削条件表 Recommended cutting conditions

※赤字は第一推奨材種です。Red indicates primary recommended grade.

被削材 Work material	推奨材種 Recommended grade	切削条件 Cutting conditions	φ20	φ25	φ35	φ40
炭素鋼 合金鋼 Carbon steels Alloy steels (<30HRC)	PN215	n (min ⁻¹)	9,560	7,650	5,460	4,780
		vc (m/min)	600	600	600	600
		vf (mm/min)	5,740	6,120	5,460	5,740
		fz (mm/t)	0.2	0.2	0.2	0.2
		ap (mm)	右表を参照ください。Refer to the table at right.			
		ae (mm)	<0.1	<0.1	<0.1	<0.1
炭素鋼 合金鋼 Carbon steels Alloy steels (30~45HRC)	PN215 TH315	n (min ⁻¹)	6,370	5,100	3,640	3,190
		vc (m/min)	400	400	400	400
		vf (mm/min)	3,830	4,080	3,640	3,830
		fz (mm/t)	0.2	0.2	0.2	0.2
		ap (mm)	右表を参照ください。Refer to the table at right.			
		ae (mm)	<0.1	<0.1	<0.1	<0.1
ステンレス鋼 Stainless steels SUS	PN215	n (min ⁻¹)	7,970	6,370	4,550	3,990
		vc (m/min)	500	500	500	500
		vf (mm/min)	4,790	5,100	4,550	4,790
		fz (mm/t)	0.2	0.2	0.2	0.2
		ap (mm)	右表を参照ください。Refer to the table at right.			
		ae (mm)	<0.1	<0.1	<0.1	<0.1
鋳鉄 Cast irons FC FCD	TH315 PN215	n (min ⁻¹)	9,560	7,650	5,460	4,780
		vc (m/min)	600	600	600	600
		vf (mm/min)	7,170	7,650	6,830	7,170
		fz (mm/t)	0.25	0.25	0.25	0.25
		ap (mm)	右表を参照ください。Refer to the table at right.			
		ae (mm)	<0.1	<0.1	<0.1	<0.1
焼入れ鋼 Hardened steels (45~55HRC)	TH315 PN215	n (min ⁻¹)	3,990	3,190	2,280	2,000
		vc (m/min)	250	250	250	250
		vf (mm/min)	1,800	1,920	1,710	1,800
		fz (mm/t)	0.15	0.15	0.15	0.15
		ap (mm)	右表を参照ください。Refer to the table at right.			
		ae (mm)	<0.08	<0.08	<0.08	<0.08

ap値は所望のカスプハイトにより下記表より選択または下記計算式より算出してください

Determine the ap value based on the desired cusp height by selecting it from the table below or by calculating it using the equation below.

インサート Insert		カスプハイト Cusp height (mm)					
商品コード Item code	R	0.001	0.002	0.003	0.004	0.005	0.01
YPHW1203R-30	30	0.49	0.69	0.85	0.98	1.1	1.55

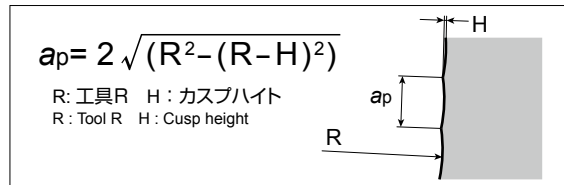

※突き出し長さ3DCX以上の場合は、左記の表をもとに下記表を参考に調整してください。

When overhang length is 3DCX or more, adjust the values shown in the table at left according to the table below.

突き出し比率 Overhang ratio	vc (m/min)	vf (mm/min)
<3DCX	100%	100%
3DCX ~ 5DCX	70%	70%
5DCX ~ 6DCX	60%	60%
6DCX ~ 7DCX	50%	50%
7DCX ~	45%	45%

【注意】

- 被削材、加工形状に合わせて、適切なクーラントを使用してください。
- この切削条件表は切削条件の目安を示すものです。実際の加工では加工形状、目的、使用機械等により条件を調整してください。
- 切りくず噛み込みによる工具損傷防止のため、必ずエアブロー等による切りくず除去を行ってください。
- インサートの交換は早めに行い、過度の使用による破損を防止してください。

【Note】

- Use the appropriate coolant for the work material and machining shape.
- These conditions are for general guidance; in actual machining conditions adjust the parameters according to your actual machine and work-piece conditions.
- To prevent tool breakage due to chips clogging tool flutes, always be sure to use an air blower, etc. to remove chips.
- Ensure to index the insert at the correct time to ensure safety of the tool-body.

プログラム上の刃先形状定義 Flute tip shape definitions for programming

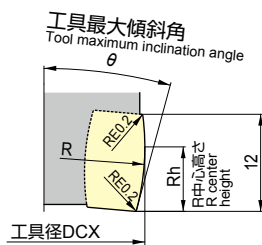

オフセットタイプ Offset type

インサートと工具径の組み合わせにより回転軌跡形状が異なります。下記表を参照ください。

Rotation locus shape will be different depending on the combination of insert and tool diameter. Refer to the table below.

インサート型番 Insert item code	オフセットタイプ Offset type			
	YPHW1203-R30			
工具径 Tool dia. DCX (mm)	φ20	φ25	φ35	φ40
R (mm)	30.24	30	29.84	29.78
Rh (mm)	7.92	8	8	8
θ	14.9°	15°	15.2°	15.3°

【注意】 小数点第三位以下を四捨五入した数値です。パラメトリックで形状定義する場合はDXFデータより必要寸法をご確認ください。

【Note】 The numbers after the third decimal point are rounded off. When defining the shape parametrically, check the required dimensions from the DXF data.

GALLEA GF3L

- GF3Lは緩曲面・緩斜面の中仕上げ～仕上げ加工用途のレンズ工具です。
- GALLEA シリーズ (GF3LとGP1LB) を合わせて使用することで中仕上げ～仕上げ加工の高能率化が図れます。
- 経済的な3コーナ仕様インサートを採用
 - ・ Lens tool for semi-finishing to finishing machining on gentle curved surfaces and gentle sloped surfaces.
 - ・ Using GALLEA series together it is possible to process from semi-finishing to finishing with high efficiency
 - ・ Economical three corner specification insert tip



GF3L M-3-M モジュラータイプ Modular type

モジュラーミル用シャンクはD2頁を、締め付けトルクについてはD5頁を参照ください。
Refer page D2 about the shanks for Modular Mill, Refer page D5 about tightening torque

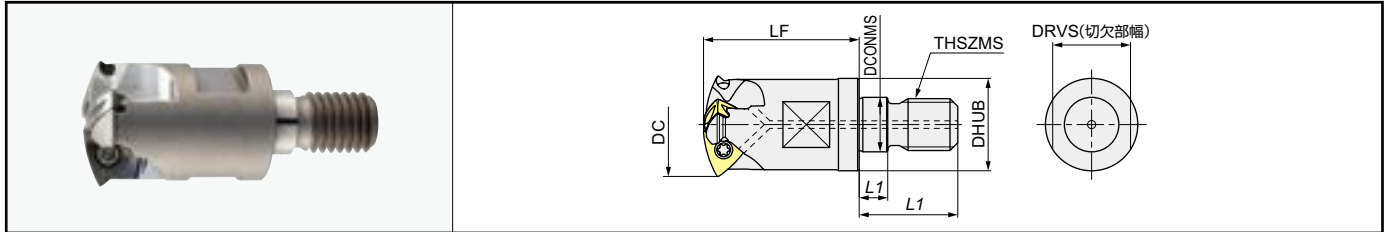

商品コード Item code	在庫 Stock	刃数 No. of flutes	寸法 Size (mm)								使用インサート Insert	希望小売価格(円) Suggested retail price(¥)
			DC	LF	DCONMS	THSZMS	DHUB	L1	L2	DRVS		
GF3L20M-3-M10	●	3	20	30	10.5	M10	17.8	5.5	19	15	TPHW0902-20	50,100
GF3L25M-3-M12	●	3	25	35	12.5	M12	23	5.5	22	17	TPHW1303-25	51,390
GF3L30M-3-M16	●	3	30	40	17	M16	28.8	6	23	22	TPHW1403-30	53,150

[注意] モジュラーミル及び専用シャンク、専用アーバの「工具端面」「モジュラーネジ部」にグリースなどの潤滑剤は塗布しないでください。
[Note] Do not apply lubricants such as grease, etc. to the "contact faces" and "modular screws" of the "modular mill", "dedicated shanks" and "dedicated arbor".
 ※工具の詳細形状についてはMOLDINOホームページよりDXFデータをダウンロードしてください。(MOLDINO工具選定データベース TOOL SEARCH: <https://data.moldino.com/toolsearch/>)
 ※For information on the detailed tool shape, download the DXF data from the MOLDINO Tool Engineering home page. (MOLDINO Tool Engineering tool selection database TOOL SEARCH: <https://data.moldino.com/toolsearch/>)

インサート Inserts

商品コード Item code	精度 Tolerance class	材種 Grade			寸法 Size (mm)			希望小売価格 (円) Suggested retail price(¥)
		PN215	TH315	IC	S	R		
TPHW0902-20	H	●	●	6.5	2.6	20	2,120	
TPHW1303-25		●	●	8.2	3.0	25	2,800	
TPHW1403-30		●	●	9.8	3.2	30	3,150	

部品番号 Parts

部品名 Parts	クランプねじ Clamp screw	レンチ Wrench	ねじ焼き付き 防止剤 Screw anti-seizure agent				
形状 Shape							
適用カッター Cutter body	締付けトルク Fastening torque (N·m)	希望小売 価格(円) Suggested retail price(¥)	希望小売 価格(円) Suggested retail price(¥)				
GF3L20M-3-M10	251-141	1.1	870	104-T8	1,800	P-37	1,010
GF3L25M-3-M12	265-143	2.0	870	104-T10	1,920		
GF3L30M-3-M16	412-141	2.9	540	104-T15	2,060		

[注意] クランプねじは消耗品です。使用環境により交換寿命は変化しますので早めの交換をお願い致します。
[Note] The clamp screw is a consumable part. Since replacement life depends on the use environment, it is recommended that it be replaced at an early stage.

GF3L形 切れ刃の切削可能範囲

Usable range of cutting edge for GF3L type

中仕上げ加工 Semi-finishing 仕上げ加工 Finishing

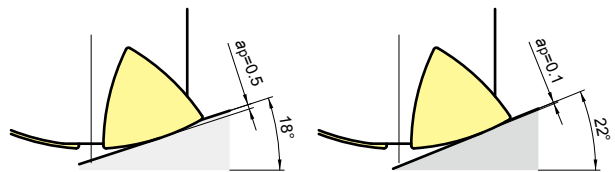

	最大ap(仕上げ代) ap max finishing allowance	切削可能範囲 Available cutting range
中仕上げ加工 Semi-finishing	0.5mm	18°
仕上げ加工 Finishing	0.1mm	22°

GF3L形は外周刃がないので、切削可能な範囲が切込量(ap値)によって変化します。
Because of GF3L type does not have a peripheral cutting edge, cutting range changes according to cutting depth (ap).

●印：標準在庫品です。 ●： Stocked items.

工具長測定値の補正

Correction of tool length measurement value

GF3L形には工具中心に切れ刃がありません。レンズ工具定義でツールパスを作成する場合、工具長測定値を補正してください。本工具形状の定義が可能なCAM及びDXFデータで工具定義が可能なCAMを使用する場合は工具長測定値の補正は不要です。
GF3L type does not have cutting edge in the tool center. When create toolpath with lens tool definition, correct the measurement value of tool length. When using a CAM that can define a tool shape with CAM and DXF data that can define a tool shape, it is unnecessary to correct the tool length measurement value.

	補正值 Correction (mm)	先端径 Tip dia. (mm)
GF3L20M-3-M10	0.058	3.0
GF3L25M-3-M12	0.056	3.3
GF3L30M-3-M16	0.062	3.9

標準切削条件表 Recommended cutting conditions

※赤字は第一推奨材種です。Red indicates primary recommended grade.

被削材 Work material	推奨材種 Recommended grade	切削条件 Cutting condition	仕上げ加工 Finishing			中仕上げ加工 Semi-finishing		
			φ20	φ25	φ30	φ20	φ25	φ30
炭素鋼 Carbon steels 合金鋼 Alloy steels (<30HRC)	PN215	n (min ⁻¹)	11,470	9,180	7,650	4,780	3,830	3,190
		vc (m/min)	720	720	720	300	300	300
		vf (mm/min)	6,890	5,510	4,590	7,170	5,750	4,790
		fz (mm/t)	0.2	0.2	0.2	0.5	0.5	0.5
		ap (mm)	0.1	0.1	0.1	0.5	0.5	0.5
		ae (mm)	下記別表を参照ください。Refer below table			下記別表を参照ください。Refer below table		
		ae (mm)	下記別表を参照ください。Refer below table			下記別表を参照ください。Refer below table		
炭素鋼 Carbon steels 合金鋼 Alloy steels (30~45HRC)	PN215 TH315	n (min ⁻¹)	8,290	6,630	5,530	3,190	2,550	2,130
		vc (m/min)	520	520	520	200	200	200
		vf (mm/min)	4,980	3,980	3,320	4,790	3,830	3,200
		fz (mm/t)	0.2	0.2	0.2	0.5	0.5	0.5
		ap (mm)	0.1	0.1	0.1	0.5	0.5	0.5
		ae (mm)	下記別表を参照ください。Refer below table			下記別表を参照ください。Refer below table		
		ae (mm)	下記別表を参照ください。Refer below table			下記別表を参照ください。Refer below table		
ステンレス鋼 Stainless steels SUS	PN215	n (min ⁻¹)	7,970	6,370	5,310	4,780	3,830	3,190
		vc (m/min)	500	500	500	300	300	300
		vf (mm/min)	4,790	3,830	3,190	7,170	5,750	4,790
		fz (mm/t)	0.2	0.2	0.2	0.5	0.5	0.5
		ap (mm)	0.1	0.1	0.1	0.5	0.5	0.5
		ae (mm)	下記別表を参照ください。Refer below table			下記別表を参照ください。Refer below table		
		ae (mm)	下記別表を参照ください。Refer below table			下記別表を参照ください。Refer below table		
鋳鉄 Cast irons FC FCD	TH315 PN215	n (min ⁻¹)	10,360	8,290	6,910	6,370	5,100	4,250
		vc (m/min)	650	650	650	400	400	400
		vf (mm/min)	9,330	7,470	6,220	9,560	7,650	6,380
		fz (mm/t)	0.3	0.3	0.3	0.5	0.5	0.5
		ap (mm)	0.1	0.1	0.1	0.5	0.5	0.5
		ae (mm)	下記別表を参照ください。Refer below table			下記別表を参照ください。Refer below table		
		ae (mm)	下記別表を参照ください。Refer below table			下記別表を参照ください。Refer below table		
焼入れ鋼 Hardened steels (45~55HRC)	TH315	n (min ⁻¹)	3,990	3,190	2,660	1,920	1,530	1,280
		vc (m/min)	250	250	250	120	120	120
		vf (mm/min)	2,400	1,920	1,600	580	460	390
		fz (mm/t)	0.2	0.2	0.2	0.15	0.15	0.15
		ap (mm)	0.08	0.08	0.08	0.2	0.2	0.2
		ae (mm)	下記別表を参照ください。Refer below table			下記別表を参照ください。Refer below table		
		ae (mm)	下記別表を参照ください。Refer below table			下記別表を参照ください。Refer below table		

aeの算出方法 How to calculate "ae"

ae 値は所望のカスプハイトにより下記表より選択、または下記計算式より算出してください。

Determine the ae value based on the desired cusp height by selecting it from the table below or by calculating it using the equation below.

使用インサート Insert	R	カスプハイト Cusp height (mm)						
		0.001	0.002	0.003	0.004	0.005	0.01	0.02
TPHW0902-20	20	0.4	0.57	0.69	0.8	0.89	1.26	1.79
TPHW1303-25	25	0.45	0.63	0.77	0.89	1	1.41	2
TPHW1403-30	30	0.49	0.69	0.85	0.98	1.1	1.55	2.19

$$ae = 2 \sqrt{(R^2 - (R - H)^2)}$$

R: 工具R Tool R
H: カスプハイト Cusp height

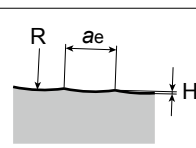

- 【注意】**
- ①被削材、加工形状に合わせて、適切なクーラントを使用してください。
 - ②この切削条件表は切削条件の目安を示すものです。実際の加工では加工形状、目的、使用機械等により条件を調整してください。
 - ③切りくず噛み込みによる工具損傷防止のため、必ずエアブロー等による切りくず除去を行ってください。
 - ④インサートの交換は早めに行い、過度の使用による破損を防止してください。

- 【Note】**
- ①Use the appropriate coolant for the work material and machining shape.
 - ②These conditions are for general guidance; in actual machining conditions adjust the parameters according to your actual machine and work-piece conditions.
 - ③To prevent tool breakage due to chips clogging tool flutes, always be sure to use an air blower, etc. to remove chips.
 - ④Ensure to index the insert at the correct time to ensure safety of the tool-body.

突き出し長さに伴う標準切削条件の調整率 Adjustment ratio of cutting conditions by overhang length.

突き出し長さが3DC以上の場合は上記切削条件表の数値を右表を参考に調整してください。

When overhang length is 3DC or more, please adjust the values in the above cutting condition table referring to the right table.

突き出し比率 Overhang ratio	Vc (m/min)	Vf (mm/min)
<3DC	100%	100%
3DC ~ 5DC	70%	70%
5DC ~ 6DC	60%	60%
6DC ~ 7DC	50%	50%
7DC ~	45%	45%

GALLEA GP1LB

- レンズ工具とバレル工具の融合、プレジジョンタイプ
- なららかな曲面と壁面を1本で加工可能
- ・ Combination of lens tool and barrel tool. Precision type
- ・ Can be machined with a single tool for gently curved surface and wall surface.

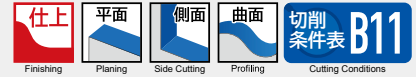

GP1LB M-M モジュラータイプ Modular type

○は数字が入ります。
Numeric figure in a circle ○.

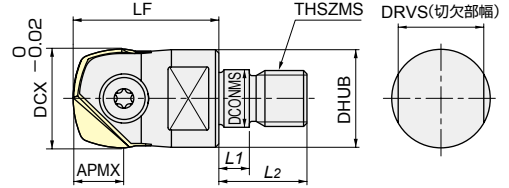

モジュラーミル用シャンクはD2頁を、締め付けトルクについてはD5頁を参照ください。
Refer page D2 about the shanks for Modular Mill, Refer page D5 about tightening torque

商品コード Item code	在庫 Stock	インサート数 No. of Inserts	寸法 Size (mm)									使用インサート Insert	希望小売価格(円) Suggested retail price(¥)
			DCX	LF	APMX	DCONMS	THSZMS	DHUB	L1	L2	DRVS		
GP1LB16M-M8	●	1	16	32	8	8.5	M8	12.8	5.5	17	10	ZPHW160-LB16	23,350
GP1LB20M-M10	●	1	20	38	10	10.5	M10	17.8	5.5	19	15	ZPHW200-LB20	26,870
GP1LB25M-M12	●	1	25	38	12.5	12.5	M12	20.8	5.5	22	17	ZPHW250-LB25	41,060
GP1LB30M-M16	●	1	30	43	15	17	M16	28.8	6	23	22	ZPHW300-LB30	41,060

【注意】モジュラーミル及び専用シャンク、専用アーバの「工具端面」「モジュラーネジ部」にグリースなどの潤滑剤は塗布しないでください。

【Note】Do not apply lubricants such as grease, etc. to the "contact faces" and "modular screws" of the "modular mill", "special shanks" and "special arbor".

※工具の詳細形状についてはMOLDINOホームページよりDXFデータをダウンロードしてください。(MOLDINO工具選定データベース TOOL SEARCH: <https://data.moldino.com/toolsearch/>)

※For information on the detailed tool shape, download the DXF data from the MOLDINO Tool Engineering home page. (MOLDINO Tool Engineering tool selection database TOOL SEARCH: <https://data.moldino.com/toolsearch/>)

インサート Insert

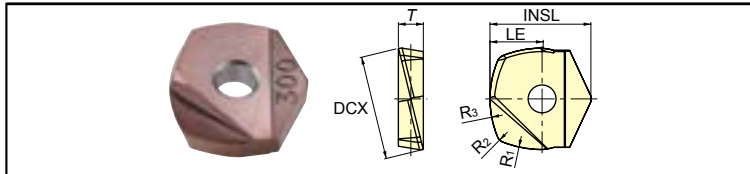

P 炭素鋼 合金鋼 Carbon steels Alloy steels	■	□
M SUS等 SUS, etc.	■	□
K FC・FCD Cast irons	□	■
H 高硬度材 Hardened steels	■	□

■ : 一般切削・第一推奨
General cutting, First recommended

□ : 一般切削・第二推奨
General cutting, Second recommended

商品コード Item code	精度 Tolerance class	材種 Grade	寸法 Size (mm)								希望小売 価格(円) Suggested retail price(¥)
			PN16	TH308	R1	R2	R3	LE	INSL	DCX	
ZPHW160-LB16	H	●●	16	1.5	16	8	16.6	16	4.2	11,460	
ZPHW160-LB16-R5	H	●●	16	5	16	8	16.6	16	4.2	11,460	
ZPHW200-LB20	H	●●	20	1.9	20	10	20.3	20	5.2	12,130	
ZPHW200-LB20-R6	H	●●	20	6	20	10	20.3	20	5.2	12,130	
ZPHW250-LB25	H	●●	25	2.38	25	12.5	24.1	25	6.2	13,250	
ZPHW250-LB25-R8	H	●●	25	8	25	12.5	24.1	25	6.2	13,250	
ZPHW300-LB30	H	●●	30	2.85	30	15	29.1	30	7.2	16,610	
ZPHW300-LB30-R10	H	●●	30	10	30	15	29.1	30	7.2	16,610	

【注意】小数点第三位以下を四捨五入した数値です。パラメトリックで形状定義する場合はDXFデータより必要寸法をご確認ください。

【Note】The numbers after the third decimal point are rounded off. When defining the shape parametrically, check the required dimensions from the DXF data.

- 印: 標準在庫品です。
- : Stocked items.

GP1LB形のインサートは最大2回までの再研磨が可能です。Insert of GP1LB, regrinding can be performed up to a maximum of 2 times.

インサートの再研磨&再コーティングも承っております。詳しくは弊社営業所までお問い合わせください。Please inquire insert re-grinding / re-coating to sales office.

部品番号 Parts

部品名 Parts	クランプねじ Clamp screw	レンチ Wrench	ねじ焼き付き 防止剤 Screw anti-seizure agent
形状 Shape			
適用カット Cutter body	締付けトルク Fastening torque (N·m)	希望小売 価格(円) Suggested retail price(¥)	希望小売 価格(円) Suggested retail price(¥)
GP1LB16M-M8	581-144 4.9	1,490	105-T20 2,120
GP1LB20M-M10	581-145 6.9	1,490	101-T25S 1,440
GP1LB25M-M12	581-146 9.8	1,710	105-T30A 2,120
GP1LB30M-M16	581-147 9.8	1,710	105-T30A 2,120

※インサートはアルファボールプレジジョンF「ABPF形」ホルダに取り付け可能です。

※工具の詳細形状についてはMOLDINOホームページよりDXFデータをダウンロードしてください。(MOLDINO工具選定データベース TOOL SEARCH: <https://data.moldino.com/toolsearch/>)

※The insert can be attached to Ball Precision F (ABPF type) holders.

※For information on the detailed tool shape, download the DXF data from the MOLDINO Tool Engineering home page. (MOLDINO Tool Engineering tool selection database TOOL SEARCH: <https://data.moldino.com/toolsearch/>)

【注意】クランプねじは消耗品です。使用環境により交換寿命は変化しますので早めの交換をお願い致します。

【Note】The clamp screw is a consumable part. Since replacement life depends on the use environment, it is recommended that it be replaced at an early stage.

GP1LBインサートの使い分け How to select GP1LB inserts

φ30工具による3軸加工の加工効率の比較 ※バレルR刃、レンズR刃、コーナ接続R刃のカスプハイトをボールエンドミルと同一に設定
Comparison of cutting efficiency of 3-axis machining with φ30 tool. ※Set the cusp-height of each edge of barrel R, lens R and corner-connected R same as ball end mill

φ30ボールエンドミル

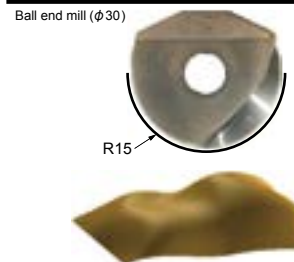

起伏が大きい形状では
ボールエンドミルで加工

Ball end mill is recommended for shapes with large undulations

GP1LB ZPHW300-LB30-R10

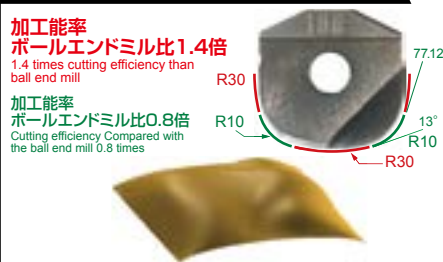

加工効率
ボールエンドミル比1.4倍
1.4 times cutting efficiency than ball end mill

加工効率
ボールエンドミル比0.8倍
Cutting efficiency compared with the ball end mill 0.8 times

起伏のある曲面で高効率加工!!
High efficiency machining on undulating curved surface.

バレルR刃+レンズR刃が加工全体の47%以上
使用できれば同一刃径のボールエンドミルより高効率
If the barrel R and lens R can be used more than 47% of the whole machining, more efficient than ball end mill of same diameter.

GP1LB ZPHW300-LB30

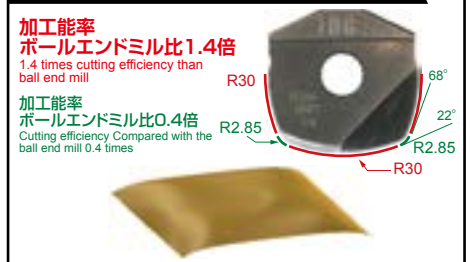

加工効率
ボールエンドミル比1.4倍
1.4 times cutting efficiency than ball end mill

加工効率
ボールエンドミル比0.4倍
Cutting efficiency compared with the ball end mill 0.4 times

起伏の少ない緩曲面で高効率加工!!
High efficiency machining with gentle curved surface with less undulation.

バレルR刃+レンズR刃が加工全体の84%以上
使用できれば同一刃径のボールエンドミルより高効率
If the barrel R and lens R can be used more than 84% of the whole machining, more efficient than ball end mill of same diameter.

※加工するモデル形状のバレルR刃とレンズR刃の使用率を確認しインサートを使い分けることで、より高効率な加工が可能です。
Checking the usage rate of barrel R edge and lens R edge in model shape to be processed and choosing an insert, possible more efficient machining.

標準切削条件表 Recommended cutting conditions

※赤字は第一推奨材種です。Red indicates primary recommended grade.

被削材 Work material	推奨材種 Recommended grade	切削条件 Cutting condition	レンズ部 Lens part				バレル部 Barrel part			
			φ16	φ20	φ25	φ30	φ16	φ20	φ25	φ30
炭素鋼 Carbon steels 合金鋼 Alloy steels (<30HRC)	PN215	n (min ⁻¹)	14,340	11,470	9,180	7,650	11,950	9,560	7,650	6,370
		vc (m/min)	720	720	720	720	600	600	600	600
		vf (mm/min)	7,170	5,740	4,590	3,830	4780	3,830	3,060	2,550
		fz (mm/t)	0.25	0.25	0.25	0.25	0.2	0.2	0.2	0.2
		ap (mm)	0.1	0.1	0.1	0.1	下表を参照ください。 Refer below table			
		ae (mm)	下表を参照ください。 Refer below table				0.1	0.1	0.1	0.1
炭素鋼 Carbon steels 合金鋼 Alloy steels (30~45HRC)	PN215 TH308	n (min ⁻¹)	10,360	8,290	6,630	5,530	7,970	6,370	5,100	4,250
		vc (m/min)	520	520	520	520	400	400	400	400
		vf (mm/min)	5,180	4,150	3,320	2,770	3,190	2,550	2,040	1,700
		fz (mm/t)	0.25	0.25	0.25	0.25	0.2	0.2	0.2	0.2
		ap (mm)	0.1	0.1	0.1	0.1	下表を参照ください。 Refer below table			
		ae (mm)	下表を参照ください。 Refer below table				0.1	0.1	0.1	0.1
ステンレス鋼 Stainless steels SUS	PN215	n (min ⁻¹)	12,940	10,360	8,290	6,910	9,960	7,970	6,370	5,310
		vc (m/min)	650	650	650	650	500	500	500	500
		vf (mm/min)	6,470	5,180	4,150	3,460	3,990	3,190	2,550	2,130
		fz (mm/t)	0.25	0.25	0.25	0.25	0.2	0.2	0.2	0.2
		ap (mm)	0.1	0.1	0.1	0.1	下表を参照ください。 Refer below table			
		ae (mm)	下表を参照ください。 Refer below table				0.1	0.1	0.1	0.1
鋳鉄 Cast irons FC FCD	TH308 PN215	n (min ⁻¹)	14,340	11,470	9,180	7,650	11,950	9,560	7,650	6,370
		vc (m/min)	720	720	720	720	600	600	600	600
		vf (mm/min)	11,480	9,180	7,350	6,120	5,980	4,780	3,830	3,190
		fz (mm/t)	0.4	0.4	0.4	0.4	0.25	0.25	0.25	0.25
		ap (mm)	0.1	0.1	0.1	0.1	下表を参照ください。 Refer below table			
		ae (mm)	下表を参照ください。 Refer below table				0.1	0.1	0.1	0.1
焼入れ鋼 Hardened steels (45~55HRC)	TH308	n (min ⁻¹)	6,370	5,100	4,080	3,400	4,980	3,990	3,190	2,660
		vc (m/min)	320	320	320	320	250	250	250	250
		vf (mm/min)	2,550	2,040	1,640	1,360	1,500	1,200	960	800
		fz (mm/t)	0.20	0.20	0.20	0.20	0.15	0.15	0.15	0.15
		ap (mm)	0.08	0.08	0.08	0.08	下表を参照ください。 Refer below table			
		ae (mm)	下表を参照ください。 Refer below table				0.08	0.08	0.08	0.08
焼入れ鋼 Hardened steels (55~62HRC)	TH308	n (min ⁻¹)	5,580	4,460	3,570	2,980	4,380	3,510	2,810	2,340
		vc (m/min)	280	280	280	280	220	220	220	220
		vf (mm/min)	2,240	1,790	1,430	1,200	1,320	1,060	850	710
		fz (mm/t)	0.20	0.20	0.20	0.20	0.15	0.15	0.15	0.15
		ap (mm)	0.05	0.05	0.05	0.05	下表を参照ください。 Refer below table			
		ae (mm)	下表を参照ください。 Refer below table				0.05	0.05	0.05	0.05



- ・レンズRを多用する加工形状では上記表の「レンズ部切削条件」を参照してください。
- ・バレルRを多用する加工形状では上記表の「バレル部切削条件」を参照してください。
- ・レンズR、バレルR両方使用する加工形状では割合の多い方の条件で設定してください。
- ・For machining shapes that make heavy use of lens R, refer to the "Lens part cutting conditions" in the above table.
- ・For machining shapes that make heavy use of barrel R, refer to the "Barrel part cutting conditions" in the above table.
- ・For machining shapes that use both lens R and barrel R, refer to the conditions for the higher usage ratio.

突き出し長さ3DCX以上の場合は、上記の表をもとに下記表を参考に調整してください。

When overhang length is 3DCX or more, adjust the values shown in the below table according to the above table.

突き出し比率 Overhang ratio	Vc (m/min)	Vf (mm/min)
<3DCX	100%	100%
3DCX ~ 5DCX	70%	70%
5DCX ~ 6DCX	60%	60%
6DCX ~ 7DCX	50%	50%
7DCX ~	45%	45%

ap または ae 値は所望のカスプハイトにより下記表より選択、または下記計算式より算出してください。

Determine the ap or ae value based on the desired cusp height by selecting it from the table below or by calculating it using the equation below.

インサート Insert		カスプハイト Cusp height (mm)					
商品コード Item code	R	0.001	0.002	0.003	0.004	0.005	0.01
ZPHW160-LB16	16	0.36	0.51	0.62	0.72	0.8	1.13
ZPHW200-LB20	20	0.4	0.57	0.69	0.8	0.89	1.26
ZPHW250-LB25	25	0.45	0.63	0.77	0.89	1	1.41
ZPHW300-LB30	30	0.49	0.69	0.85	0.98	1.1	1.55

$$ap = 2 \sqrt{(R^2 - (R-H)^2)}$$

(ae)

R: 工具R
Tool R

H: カスプハイト
Cusp height

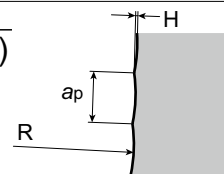

- [注意]**
- ①被削材、加工形状に合わせて、適切なクーラントを使用してください。
 - ②この切削条件表は切削条件の目安を示すものです。実際の加工では加工形状、目的、使用機械等により条件を調整してください。
 - ③切りくず噛み込みによる工具損傷防止のため、必ずエアブロー等による切りくず除去を行ってください。
 - ④インサートの交換は早めに行い、過度の使用による破損を防止してください。

- [Note]**
- ① Use the appropriate coolant for the work material and machining shape.
 - ② These conditions are for general guidance; in actual machining conditions adjust the parameters according to your actual machine and work-piece conditions.
 - ③ To prevent tool breakage due to chips clogging tool flutes, always be sure to use an air blower, etc. to remove chips.
 - ④ Ensure to index the insert at the correct time to ensure safety of the tool-body.

インサート取り付け手順はB14ページを参照ください。Refer B14 for set-up procedures of inserts.

- 5軸加工のメリットを最大限活かす1つの工具で2種類の加工
 - 工具交換無しで加工できるので、加工段差が最小限に。
- ・ Two types of process are possible with one tool that can fully utilize the merit of 5-axis machining
 ・ Since it can work for 2 types of process without tool change, machining surface steps can be minimized.



GP1T M-M モジュラータイプ Modular type

モジュラールミル用シャンクはD2頁を、締め付けトルクについてはD5頁を参照ください。
 Refer page D2 about the shanks for Modular Mill, Refer page D5 about tightening torque

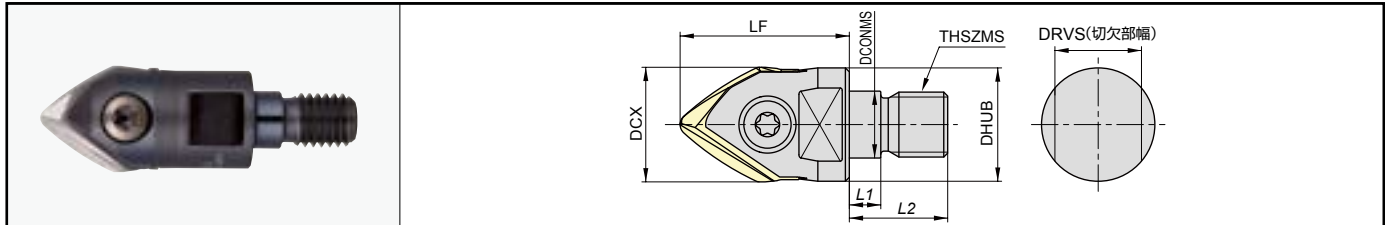

商品コード Item code	在庫 Stock	インサート数 No. of Inserts	寸法 Size (mm)									使用インサート Insert	希望小売価格(円) Suggested retail price(¥)
			DCX	LF	DCONMS	THSZMS	DHUB	L1	L2	DRVS			
GP1T12M-M6	●	1	12	26	6.5	M6	9.8	5.5	14.5	7	ZDHW120-T43R1.2-30	22,060	
GP1T16M-M8	●	1	16	32	8.5	M8	12.8	5.5	17	10	ZDHW160-T43R1.6-40	25,700	
GP1T20M-M10	●	1	20	38	10.5	M10	17.8	5.5	19	15	ZDHW200-T43R2-50	29,570	
GP1T25M-M12	●	1	25	38	12.5	M12	20.8	5.5	22	17	ZDHW250-T43R2.5-62.5	45,170	
GP1T30M-M16	●	1	30	43	17	M16	28.8	6	23	22	ZDHW300-T43R3-75	45,170	

【注意】モジュラールミル及び専用シャンク、専用アーバの「工具端面」「モジュラースネジ部」にグリースなどの潤滑剤は塗布しないでください。
 【Note】Do not apply lubricants such as grease, etc. to the "contact faces" and "modular screws" of the "modular mill", "deductaed shanks" and "deductaed arbor".
 ※工具の詳細形状についてはMOLDINOホームページよりDXFデータをダウンロードしてください。(MOLDINO工具選定データベース TOOL SEARCH: <https://data.moldino.com/toolsearch/>)
 ※For information on the detailed tool shape, download the DXF data from the MOLDINO Tool Engineering home page. (MOLDINO Tool Engineering tool selection database TOOL SEARCH: <https://data.moldino.com/toolsearch/>)

インサート Inserts

商品コード Item code	精度 Tolerance class	材種 Grade	寸法 Size (mm)							希望小売価格(円) Suggested retail price(¥)
			R1	R2	R3	LE	INSL	DCX	T	
ZDHW120-T43R1.2-30	H	● ●	1.2	30	0.98	8.6	17.6	12	3.2	11,150
ZDHW160-T43R1.6-40		● ●	1.6	40	1.3	11.3	20.6	16	4.2	11,460
ZDHW200-T43R2-50		● ●	2.0	50	1.63	14.3	25.4	20	5.2	12,130
ZDHW250-T43R2.5-62.5		● ●	2.5	62.5	2.04	17.9	30.1	25	6.2	13,250
ZDHW300-T43R3-75		● ●	3.0	75	2.45	21.6	36.3	30	7.2	16,610

・ インサートはアルファボールプレジジョンF「ABPF形」ホルダに取り付け可能です。
 ・ The insert can be set with "ABPF-type" cutter body
 ・ 小径サイズはソリッドバレルエンドミル GS4TN をご使用ください。
 ・ Use solid barrel end mill, "GS4TN-type" for smaller diameter in size

【注意】小数点第三位以下を四捨五入した数値です。パラメトリックで形状定義する場合はDXFデータより必要寸法をご確認ください。
 【Note】The numbers after the third decimal point are rounded off. When defining the shape parametrically, check the required dimensions from the DXF data.

※工具の詳細形状についてはMOLDINOホームページよりDXFデータをダウンロードしてください。(MOLDINO工具選定データベース TOOL SEARCH: <https://data.moldino.com/toolsearch/>)
 ※For information on the detailed tool shape, download the DXF data from the MOLDINO Tool Engineering home page. (MOLDINO Tool Engineering tool selection database TOOL SEARCH: <https://data.moldino.com/toolsearch/>)

部品番号 Parts

部品名 Parts	クランプねじ Clamp screw		レンチ Wrench	ねじ焼き付き防止剤 Screw anti-seizure agent						
形状 Shape 適用カッタ Cutter body		締め付けトルク Fastening torque (N·m)		希望小売価格(円) Suggested retail price (¥)						
						希望小売価格(円) Suggested retail price (¥)	希望小売価格(円) Suggested retail price (¥)			
						581-143	4.9	1,490	105-T20	2,120
						581-144	4.9	1,710	101-T25S	1,440
						581-145	6.9		105-T30A	2,120
581-146	9.8				P-37	1,010				
581-147	9.8									

【注意】クランプねじは消耗品です。使用環境により交換寿命は変化しますので早めの交換をお願い致します。
 【Note】The clamp screw is a consumable part. Since replacement life depends on the use environment, it is recommended that it be replaced at an early stage.

●印：標準在庫品です。 ●：Stocked items.

標準切削条件表 Recommended cutting conditions

※赤字は第一推奨材種です。Red indicates primary recommended grade.

被削材 Work material	推奨材種 Recommended grade	切削条件 Cutting conditions	先端 R Tip R					バレル R Barrel R				
			φ12(R1.2)	φ16(R1.6)	φ20(R2)	φ25(R2.5)	φ30(R3)	φ12	φ16	φ20	φ25	φ30
炭素鋼 合金鋼 Carbon steels Alloy steels (<30HRC)	PN215	n (min ⁻¹)	19,910	14,930	11,950	9,560	7,970	19,110	14,340	11,470	9,180	7,650
		vc (m/min)	750(150)	750(150)	750(150)	750(150)	750(150)	720	720	720	720	720
		vf (mm/min)	1,600	1,500	1,440	1,340	1,280	5,740	4,310	3,450	2,760	2,300
		fz (mm/t)	0.04	0.05	0.06	0.07	0.08	0.15	0.15	0.15	0.15	0.15
		ap (mm)	0.1	0.1	0.1	0.1	0.1	下表を参照ください。Refer below table				
		ae (mm)	下表を参照ください。Refer below table					0.1	0.1	0.1	0.1	0.1
炭素鋼 合金鋼 Carbon steels Alloy steels (30~45HRC)	PN215 TH308	n (min ⁻¹)	18,580	13,940	11,150	8,920	7,440	13,810	10,360	8,290	6,630	5,530
		vc (m/min)	700(140)	700(140)	700(140)	700(140)	700(140)	520	520	520	520	520
		vf (mm/min)	1,490	1,400	1,340	1,250	1,200	4,150	3,110	2,490	1,990	1,660
		fz (mm/t)	0.04	0.05	0.06	0.07	0.08	0.15	0.15	0.15	0.15	0.15
		ap (mm)	0.1	0.1	0.1	0.1	0.1	下表を参照ください。Refer below table				
		ae (mm)	下表を参照ください。Refer below table					0.1	0.1	0.1	0.1	0.1
ステンレス鋼 Stainless steels SUS	PN215	n (min ⁻¹)	19,910	14,930	11,950	9,560	7,970	17,260	12,940	10,360	8,290	6,910
		vc (m/min)	750(150)	750(150)	750(150)	750(150)	750(150)	650	650	650	650	650
		vf (mm/min)	1,600	1,500	1,440	1,340	1,280	5,180	3,890	3,110	2,490	2,080
		fz (mm/t)	0.04	0.05	0.06	0.07	0.08	0.15	0.15	0.15	0.15	0.15
		ap (mm)	0.1	0.1	0.1	0.1	0.1	下表を参照ください。Refer below table				
		ae (mm)	下表を参照ください。Refer below table					0.1	0.1	0.1	0.1	0.1
鋳鉄 Cast irons FC FCD	TH308 PN215	n (min ⁻¹)	19,910	14,930	11,950	9,560	7,970	19,110	14,340	11,470	9,180	7,650
		vc (m/min)	750(150)	750(150)	750(150)	750(150)	750(150)	720	720	720	720	720
		vf (mm/min)	1,600	1,500	1,440	1,340	1,280	7,650	5,740	4,590	3,680	3,060
		fz (mm/t)	0.04	0.05	0.06	0.07	0.08	0.2	0.2	0.2	0.2	0.2
		ap (mm)	0.1	0.1	0.1	0.1	0.1	下表を参照ください。Refer below table				
		ae (mm)	下表を参照ください。Refer below table					0.1	0.1	0.1	0.1	0.1
焼入れ鋼 Hardened steels (45~55HRC)	TH308	n (min ⁻¹)	13,270	9,960	7,970	6,370	5,310	8,500	6,370	5,100	4,080	3,400
		vc (m/min)	500(100)	500(100)	500(100)	500(100)	500(100)	320	320	320	320	320
		vf (mm/min)	1,070	1,000	960	900	850	1,700	1,280	1,020	820	680
		fz (mm/t)	0.04	0.05	0.06	0.07	0.08	0.1	0.1	0.1	0.1	0.1
		ap (mm)	0.08	0.08	0.08	0.08	0.08	下表を参照ください。Refer below table				
		ae (mm)	下表を参照ください。Refer below table					0.08	0.08	0.08	0.08	0.08
焼入れ鋼 Hardened steels (55~62HRC)	TH308	n (min ⁻¹)	11,950	8,960	7,170	5,740	4,780	7,440	5,580	4,460	3,570	2,980
		vc (m/min)	450(90)	450(90)	450(90)	450(90)	450(90)	280	280	280	280	280
		vf (mm/min)	960	900	870	810	770	1,490	1,120	900	720	600
		fz (mm/t)	0.04	0.05	0.06	0.07	0.08	0.1	0.1	0.1	0.1	0.1
		ap (mm)	0.05	0.05	0.05	0.05	0.05	下表を参照ください。Refer below table				
		ae (mm)	下表を参照ください。Refer below table					0.05	0.05	0.05	0.05	0.05

※vcの()値は先端小R部の切削速度を示します。The () values of vc indicate the cutting speed of the tip R part.

突き出し長さ3DCX以上の場合は、上記の表をもとに右記表を参考に調整してください。

When overhang length is 3DCX or more, adjust the values shown in the table at right according to the above table.

突き出し比率 Overhang ratio	Vc (m/min)	Vf (mm/min)	突き出し比率 Overhang ratio	Vc (m/min)	Vf (mm/min)
<3DCX	100%	100%	6DCX ~ 7DCX	50%	50%
3DCX ~ 5DCX	70%	70%	7DCX ~	45%	45%
5DCX ~ 6DCX	60%	60%			

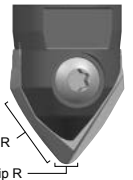

バレル R Barrel R
先端 R Tip R

apまたはae値は所望のカスプハイトにより下記表より選択、または下記計算式より算出してください。
Determine the ap or ae value based on the desired cusp height by selecting it from the table below or by calculating it using the equation below.

インサート Insert 商品コード Item code	バレル R の切込み Cutting depth using barrel R ap (mm)							先端 R の切込み Cutting depth using tip R ae (mm)								
	バレル R Barrel R	カスプハイト Cusp height (mm)						先端 R Tip R	カスプハイト Cusp height (mm)							
		0.0005	0.001	0.002	0.003	0.004	0.005	0.01		0.0005	0.001	0.002	0.003	0.004	0.005	0.01
ZDHW120-T43R1.2-30	30	0.35	0.49	0.69	0.85	0.98	1.1	1.55	1.2	0.07	0.11	0.14	0.17	0.2	0.22	0.31
ZDHW160-T43R1.6-40	40	0.4	0.57	0.8	0.98	1.13	1.26	1.79	1.6	0.08	0.11	0.16	0.2	0.23	0.25	0.36
ZDHW200-T43R2-50	50	0.45	0.63	0.89	1.1	1.26	1.41	2	2	0.09	0.13	0.18	0.22	0.25	0.28	0.4
ZDHW250-T43R2.5-62.5	62.5	0.5	0.71	1	1.22	1.41	1.58	2.24	2.5	0.1	0.14	0.2	0.24	0.28	0.32	0.45
ZDHW300-T43R3-75	75	0.55	0.77	1.1	1.34	1.55	1.73	2.45	3	0.11	0.15	0.22	0.27	0.31	0.35	0.49

$$ap = 2 \sqrt{(R^2 - (R-H)^2)} \quad (ae)$$

R: 工具R
H: カスプハイト
R: Tool R
H: Cusp height

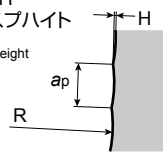

- [注意]**
- 被削材、加工形状に合わせて、適切なクーラントを使用してください。
 - この切削条件表は切削条件の目安を示すものです。実際の加工では加工形状、目的、使用機械等により条件を調整してください。
 - 切りくず噛み込みによる工具損傷防止のため、必ずエアブロー等による切りくず除去を行ってください。
 - インサートの交換は早めに行い、過度の使用による破損を防止してください。

- [Note]**
- Use the appropriate coolant for the work material and machining shape.
 - These conditions are for general guidance; in actual machining conditions adjust the parameters according to your actual machine and work-piece conditions.
 - To prevent tool breakage due to chips clogging tool flutes, always be sure to use an air blower, etc. to remove chips.
 - Ensure to index the insert at the correct time to ensure safety of the tool-body.

バレル R と先端 R の角度範囲 Angle range of barrel R and tip R

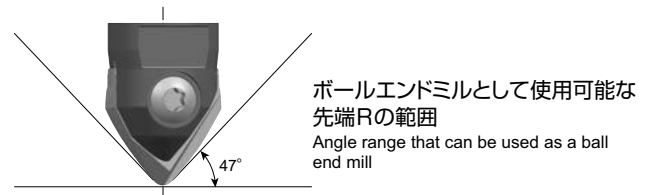
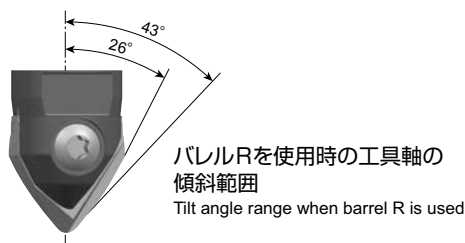

インサート取り付け手順はB14ページを参照ください。Refer B14 for set-up procedures of inserts.

GALLEA GP1LB/GP1T

○ インサート取付け手順 Set-up Procedures of Inserts

- 1** インサート座面の清掃
エアブローなどで、インサート座面を清掃ください。
Clean the insert seat:
Using air-blow or alike, clean the seat.
- 2** インサートは、上面を工具本体のねじ締め付け側に合わせ、挿入する。
Put in the insert with its top positioned to the screw-tightening side of the tool body.
- 3** 専用レンチにてクランプねじを締め付ける。
この時インサートは押さえつけないでください。
Tighten the clamp screw with the special wrench.
Please do not press down the insert during this tightening process.
- 4** 締め付け完了。
This is the end of insert set-up.

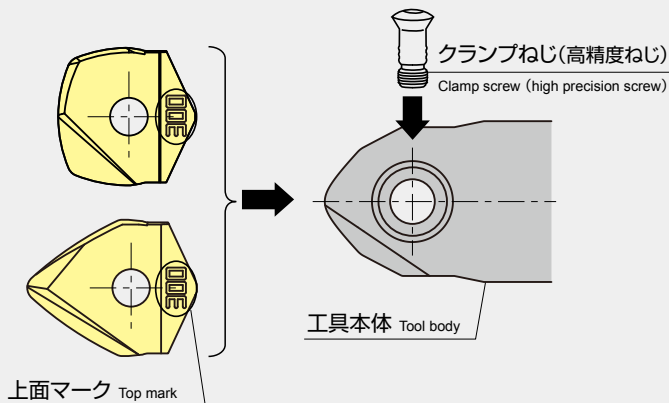

ご注意 Attention

インサートを挿入しない状態でのクランプねじ締結は、ホルダー本体の変形に繋がる恐れがあり、インサートの取り付け不良や取付精度の劣化につながる可能性があるため決して行わないでください。
Never tighten the clamp screw without putting the insert. The tool body may be deformed, resulting in improper insert mounting or deterioration of mounting accuracy.



**インサート未挿入での
空締め禁止**
Do not tighten the screw
without putting insert

刃先交換式工具 フライス切削用インサート

Indexable Tools, Milling Inserts



刃先交換式工具一覧表C2
Table of Indexable Tools

フライス切削用インサートC236
Milling Inserts

刃先交換式工具 種類別(カタログ掲載順) Indexable tools, by type (catalog listing order)

高送りラジアスマル High Feed Radius End Mills

TR4F.....C10
TD6N.....C22
TD4N.....C28
ASR.....C32
ASRT.....C38
ASRF.....C44
ASRF mini.....C50
ASR多刃.....C54

ラジアスエンドミル Radius End Mills

RH2P.....C64
AHR.....C66
AR.....C72
RD16B.....C82
RV.....C86
ARPF.....C92

ボールエンドミル Ball End Mills

BR2P.....C100
BCF.....C110
ASB.....C120
BCU.....C124
ABPF.....C126
ABPFN.....C134
ABP4F.....C136

スクエアエンドミル Square End Mills

ASM.....C140
AHU.....C146
SS4P.....C154
SE90(シャンク Shank) ..C156
UEX.....C158
AHJ.....C160
ASJ.....C168
ASV.....C174
AME.....C180
ASPV mini.....C184
ASPV.....C192
ASPV-Z.....C206
MX.....C208

フェースミル Face Mills

ASDF.....C210
ASDH.....C212
ASF.....C216
AFE45.....C220
A45E.....C222
A45D.....C224
SE90(ボア Bore).....C226

その他の工具 Other Tools

CPC.....C228
EP.....C230
AJU.....C232
SP.....C234

刃先交換式工具 商品コード別(アルファベット順) Indexable tools, by item code (alphabetical order)

A45D.....C224	ARPF.....C92	ASRF mini.....C50	RV.....C86
A45E.....C222	ASB.....C120	ASRT.....C38	SE90(シャンク Shank) ..C156
ABP4F.....C136	ASDF.....C210	ASR多刃.....C54	SE90(ボア Bore).....C226
ABPF.....C126	ASDH.....C212	ASV.....C174	SP.....C234
ABPFN.....C134	ASF.....C216	BCF.....C110	SS4P.....C154
AFE45.....C220	ASJ.....C168	BCU.....C124	TD4N.....C28
AHJ.....C160	ASM.....C140	BR2P.....C100	TD6N.....C22
AHR.....C66	ASPV.....C192	CPC.....C228	TR4F.....C10
AHU.....C146	ASPV-Z.....C206	EP.....C230	UEX.....C158
AJU.....C232	ASPV mini.....C184	MX.....C208	
AME.....C180	ASR.....C32	RD16B.....C82	
AR.....C72	ASRF.....C44	RH2P.....C64	

環境負荷低減への配慮により、既に一部の製品についてはドライバー、ねじ焼き付け防止剤は別売りとさせていただきます。今後、従来品についても一部製品を除き、同梱を取りやめ、別売りとさせていただきます。

In consideration of reducing our environmental burden, we have already stopped bundling the screw driver and screw anti-seizure agent with certain products. They will no longer be supplied with conventional products (with certain exceptions), and will instead be sold separately.

刃先交換式工具一覧表

タイプ Type	名称・形番 Name/Item code	形状・外径(mm) Shape, Tool dia.	切込み角 最大切込み量(mm) Cutting edge angle Max. depth of cut	仕上げ 区分 Finishing group	加工用途 Cutting applications	掲載頁 Page
高送りラジASMIL High Feed Radius End Mills	TR4F アルファ 高送りラジASMIL Radius Mill TR4F ポデー単体 0.1 / 0.2 インサート 0.12 / 0.24 4000形 5000形	 φ32~φ125	4000形 type +1.2 5000形 type +2.0	荒 Roughing	平面 Planing 溝 Slotting バリカル Vertical 彫込み Die-sinking 曲面 Profiling ヘリカル Helical	C10
	TD6N アルファ 高送りラジASMIL Radius Mill TD6N ポデー単体 0.15 / 0.25 インサート M	 φ50~φ125	+1.5 +3.0	荒 Roughing	平面 Planing 彫込み Die-sinking 曲面 Profiling ヘリカル Helical	C22
	TD4N アルファ 高送りラジASMIL Radius Mill TD4N ポデー単体 0.06 / 0.11 インサート M	 φ16~φ42	+1.0	荒 Roughing	平面 Planing 溝 Slotting 彫込み Die-sinking 曲面 Profiling ヘリカル Helical	C28
	ASR アルファ 高送りラジASMIL Radius Mill ASR ポデー単体 0 / 0.2 インサート M, N, E	 φ20~φ100	R15 (R10) 2.0°	荒 Roughing	平面 Planing 溝 Slotting 彫込み Die-sinking 曲面 Profiling ヘリカル Helical	C32
	ASRT アルファ 高送りラジASMIL 3コーナ Radius Mill 3 Corners ASRT ポデー単体 0 / 0.2 インサート N	 φ25~φ100	+2.0	荒 Roughing	平面 Planing 溝 Slotting 彫込み Die-sinking 曲面 Profiling ヘリカル Helical	C38
	ASRF アルファ 高送りラジASMIL 4コーナ Radius Mill 4 Corners ASRF ポデー単体 0 / 0.2 インサート M, N	 φ32~φ100	R15 +2.0	荒 Roughing	平面 Planing 溝 Slotting 彫込み Die-sinking 曲面 Profiling ヘリカル Helical	C44
	ASRF mini アルファ 高送りラジASMIL 4コーナ ASRF mini Radius Mill 4 Corners ASRF mini ポデー単体 0 / 0.1 / 0.2 インサート M, N	 φ20~φ63	+1.2	荒 Roughing	平面 Planing 溝 Slotting 彫込み Die-sinking 曲面 Profiling ヘリカル Helical	C50
	ASR多刃 アルファ 高送りラジASMIL ASR多刃タイプ Radius Mill ASR Multi-flutes type ポデー単体 0 / 0.2 インサート M, N	 φ16~φ66	R8 (R10) +1.5 (2.0)	荒 Roughing	平面 Planing 溝 Slotting 彫込み Die-sinking 曲面 Profiling ヘリカル Helical	C54

刃先交換式工具

高送りラジASMIL

タイプ Type	名称・形番 Name/Item code	形状・外径(mm) Shape, Tool dia.	切込み角 最大切込み量(mm) Cutting edge angle Max. depth of cut	仕上げ 区分 Finishing group	加工用途 Cutting applications	掲載頁 Page
ラジウスエンドミル Radius End Mills	RH2P アルファ 高硬度ラジウスミル High Hard Radius Mill RH2P ボデー単体 $\begin{matrix} 0 \\ -0.046 \\ -0.096 \end{matrix}$ インサート $\begin{matrix} \text{M} \\ \text{H} \end{matrix}$	 $\phi 8 \sim \phi 32$	 0.5 R=2	荒 中仕上 仕上	平面 側面 彫込み ヘリカル	C64
	AHR アルファ ヘビーラジウスミル Radius Mill AHR(Heavy radius mill) ボデー単体 $\begin{matrix} 0 \\ -0.2 \end{matrix}$ インサート $\begin{matrix} \text{M} \\ \text{N} \end{matrix}$	 $\phi 40 \sim \phi 125$	 18 R8, R10	荒	平面 溝 彫込み 曲面 ヘリカル	C66
	AR 快削形アルファラジウスミル Easy Cut Radius Mill AR ボデー単体 $\begin{matrix} 0 \\ -0.2 \end{matrix}$ インサート $\begin{matrix} \text{M} \\ \text{H} \end{matrix}$ インサート $\begin{matrix} \text{M} \\ \text{H} \end{matrix}$	 $\phi 12 \sim \phi 141$	 R2.5 R8	荒	平面 溝 彫込み 曲面 ヘリカル	C72
	RD16B アルファラジウスミル Radius Mill RD16B ボデー単体 $\begin{matrix} 0 \\ -0.16 \\ -0.3 \end{matrix}$ インサート $\begin{matrix} \text{M} \\ \text{H} \end{matrix}$	 $\phi 32 \sim \phi 100$	 R6 R8	荒 中仕上	平面 溝 彫込み 曲面 ヘリカル	C82
	RV アルファ ラジウスミルRV Radius Mill RV ボデー単体 $\begin{matrix} 0 \\ -0.2 \end{matrix}$ インサート $\begin{matrix} \text{M} \\ \text{E} \\ \text{H} \end{matrix}$	 $\phi 25 \sim \phi 80$	 R5 R6	荒 中仕上	平面 溝 彫込み 曲面 ヘリカル	C86
	ARPF アルファ ラジウスプレジジョン Radius Precision ARPF ボデー単体 $\begin{matrix} 0 \\ -0.02 \end{matrix}$ インサート $\begin{matrix} \text{F} \\ \text{H} \end{matrix}$	 $\phi 6 \sim \phi 32$	 2.5~10 R±0.015	中仕上 仕上	平面 側面 彫込み 曲面 ヘリカル	C92
	ボールエンドミル Ball End Mills	BR2P アルファ ボールエンドミル Ball End Mill BR2P ボデー単体 $\begin{matrix} 0 \\ -0.05 \\ -0.15 \end{matrix}$ インサート $\begin{matrix} \text{M} \\ \text{E} \end{matrix}$	 $\phi 16 \sim \phi 50$	 R8 R25	荒 中仕上	溝 彫込み 曲面 R ヘリカル
BCF アルファ ボールエンドミル Ball End Mill BCF ボデー単体 $\begin{matrix} 0 \\ -0.15 \end{matrix}$ ボデー単体 $\begin{matrix} \pm 0.1 \end{matrix}$ インサート $\begin{matrix} \text{E} \\ \text{H} \end{matrix}$		 $\phi 16 \sim \phi 40$	 R8 R20	荒 中仕上	溝 彫込み 曲面 R ヘリカル	C110

刃先交換式工具一覧表

タイプ Type	名称・形番 Name/Item code	形状・外径(mm) Shape, Tool dia.	切込み角 最大切込み量(mm) Cutting edge angle Max. depth of cut	仕上げ 区分 Finishing group	加工用途 Cutting applications	掲載頁 Page
ボールエンドミル Ball End Mills	ASB アルファ スーパーボールエンドミル Ball End Mill for Heavy Duty ASB ボデー単体 公差 ±0.1 インサート ⑧E	 φ40~φ50	 50~63 R20 R25	荒 Roughing	溝 Slotting 彫込み Die-sinking 曲面 Profiling ヘリカル Helical	C120
	BCU アルファ ボールエンドミル Ball End Mill BCU ボデー単体 公差 ±0.1 インサート ⑧E	 φ50	 63 R25	荒 Roughing	溝 Slotting 彫込み Die-sinking 曲面 Profiling R Radius ヘリカル Helical	C124
	ABPF アルファ ボールプレジジョンF Ball Precision F ABPF ボデー単体 公差 ±0.01 インサート ⑧F	 φ6~φ32	 R±0.01	仕上 Finishing	平面 Planing 側面 Side Cutting 彫込み Die-sinking 曲面 Profiling R Radius ヘリカル Helical	C126
	ABPFN アルファ ボールプレジジョンF Ball Precision F ABPFN ボデー単体 公差 ±0.01 インサート ⑧F	 φ6~φ30	 R±0.01	仕上 Finishing	平面 Planing 側面 Side Cutting 彫込み Die-sinking 曲面 Profiling R Radius ヘリカル Helical	C134
	ABP4F アルファ ボールプレジジョンマルチフルート Ball Precision Multi Flutes ABP4F ボデー単体 公差 ±0.01 インサート ⑧F	 φ20~φ30	 R±0.01	中仕上 Semi Finishing 仕上 Finishing	平面 Planing 側面 Side Cutting 彫込み Die-sinking 曲面 Profiling R Radius	C136
	スクエアエンドミル Square End Mills	ASM アルファ スーパーエクセレントミニ Super Excellent Mini ASM ボデー単体 公差 -0.1/-0.2 インサート ⑧M	 φ8~φ32	 5 R2 ±0.3	荒 Roughing 中仕上 Semi Finishing	平面 Planing 側面 Side Cutting 溝 Slotting 彫込み Die-sinking 曲面 Profiling ヘリカル Helical
AHU アルファ 超快削エンドミル High Feed End Mill AHU ボデー単体 公差 -0.1/-0.2 インサート ⑧M ⑧E		 φ16~φ40 φ50~φ100	 5~14	荒 Roughing 中仕上 Semi Finishing	平面 Planing 側面 Side Cutting 溝 Slotting 彫込み Die-sinking 曲面 Profiling ヘリカル Helical	C146
SS4P アルファ 快削ショルダーミル4コーナ Easy Cut 4 Corners Shoulder Mill SS4P ボデー単体 公差 0/-0.25 インサート ⑧M		 φ25~φ40	 8	荒 Roughing 中仕上 Semi Finishing	平面 Planing 側面 Side Cutting 溝 Slotting	C154

刃先交換式工具

ボールエンドミル
Ball End Mills

スクエアエンドミル
Square End Mills

タイプ Type	名称・形番 Name/Item code	形状・外径(mm) Shape, Tool dia.	切込み角 最大切込み量(mm) Cutting edge angle Max. depth of cut	仕上げ 区分 Finishing group	加工用途 Cutting applications	掲載頁 Page
スクエアエンドミル Square End Mills	SE90 アルファ 90(シャンク) SE90(shank) ポデー単体 0.1 0.3 インサート K インサート E	 φ50, φ63	 17	荒 仕上げ	平面 側面 溝	C156
	UEX 快削エンドミル Easy Cut Square Mill UEX ポデー単体 0.1 0.3 インサート N インサート E	 φ16~φ50	 12 15	荒 仕上げ	平面 側面 溝	C158
	AHJ アルファ 快削じゅうおう Easy Cut Multi Function Mill AHJ ポデー単体 0.1 0.2 インサート M	 φ16~φ50	 8.5~50	荒 中仕上げ	平面 側面 溝 彫込み 曲面 ヘリカル 穴あけ	C160
	ASJ アルファ スーパーじゅうおう Super Juoh ASJ ポデー単体 0.1 0.2 インサート M	 φ16~φ50	 16~50	荒 中仕上げ	平面 側面 溝 彫込み 曲面 ヘリカル 穴あけ	C168
	ASV アルファ スーパーバーチカルミル Super Vertical Mill ASV ポデー単体 0.1 0.2 インサート M インサート H	 φ25~φ125	 1.5 3.0 12 18	荒 仕上げ	平面 側面 彫込み バーチカル	C174
	AME アルファ ラフィングエンドミル Roughing End Mill AME ポデー単体 0.1 0.3 インサート M	 φ32~φ63	 32~115	荒 中仕上げ	側面	C180
	ASPV mini アルファ ポリッシュミルVタイプ ASPV mini Polish Mill V type ASPVmini ポデー単体 0.046 0.096 インサート H	 φ10~φ32	 2.0	仕上げ	平面 側面 溝 彫込み 曲面 ヘリカル バーチカル	C184
	ASPV アルファ ポリッシュミルVタイプ Polish Mill V type ASPV ポデー単体 0.03 0.1 インサート N インサート H	 φ16~φ63	 3.0 5	荒 中仕上げ 仕上げ	平面 側面 溝 彫込み 曲面 ヘリカル バーチカル	C192

刃先交換式工具一覧表

タイプ Type	名称・形番 Name/Item code	形状・外径(mm) Shape, Tool dia.	切込み角 最大切込み量(mm) Cutting edge angle Max. depth of cut	仕上げ 区分 Finishing group	加工用途 Cutting applications	掲載頁 Page
スクエアエンドミル Square End Mills	ASPVZ ザグリ加工用 ASPV-Z ASPV-Z for Z plunging	 φ16~φ26		荒 Roughing	座ぐり Spot Facing	C206
	MX Max1 刃先交換式エンドミル Max1 Indexable End Mill MX	 φ10~φ40		中仕上げ Semi Finishing 仕上げ Finishing	平面 Planing 側面 Side Cutting 溝 Slotting	C208
フェースミル Face Mills	ASDF アルファ デュアルフェースミル Dual Face Mill ASDF	 φ42~φ139		荒 Roughing	平面 Planing	C210
	ASDH アルファ デュアルフェースミル Dual Face Mill ASDH	 φ63~φ160		荒 Roughing 仕上げ Finishing	平面 Planing	C212
	ASF アルファ 高送り正面フライス Face Mill ASF	 φ63~φ315		荒 Roughing 中仕上げ Semi Finishing	平面 Planing	C216
	AFE45 アルファ 正面フライス Face Mill AFE45	 φ50~φ160		荒 Roughing 仕上げ Finishing	平面 Planing	C220
	A45E アルファ 45フェースミル 45 Face Mill A45E	 φ80~φ315		荒 Roughing 仕上げ Finishing	平面 Planing	C222
	A45D アルファ 45フェースミル 45 Face Mill A45D	 φ80~φ315		荒 Roughing 中仕上げ Semi Finishing	平面 Planing	C224

刃先交換式工具

タイプ Type	名称・形番 Name/Item Code	形状・外径(mm) Shape, Tool dia.	切込み角 最大切込み量(mm) Cutting edge angle Max. depth of cut	仕上げ 区分 Finishing group	加工用途 Cutting applications	掲載頁 Page
フェースミル Face Mills	SE90 アルファ 90フェースミル 90 Face Mill SE90 ボデー単体: 0.1 / 0.3, インサート: K, E	 φ80~φ250		荒 Roughing 中仕上げ Semi Finishing	平面 Planing 側面 Side Cutting	C226
	CPC アルファ 面取りカッタ Chamfering Mill CPC ボデー単体: 0.1 / 0.2, インサート: M	 φ5~φ35		荒 Roughing 中仕上げ Semi Finishing	平面 Planing 面取り Chamfering	C228
	EP 刃先交換式エンドミル Indexable End Mill EP ボデー単体: 0.1 / 0.3, インサート: C, K, G, E, M	 φ20~φ50		荒 Roughing 中仕上げ Semi Finishing	平面 Planing 側面 Side Cutting 溝 Slotting	C230
	AJU アルファ エンドミルじゅうおう End Mill Juoh AJU ボデー単体: 0.1 / 0.2, インサート: M	 φ16~φ50		荒 Roughing 中仕上げ Semi Finishing	平面 Planing 側面 Side Cutting 溝 Slotting 影込み Die-sinking 曲面 Profiling ヘリカル Helical 穴あけ Drilling	C232
	SP ショルダーミル Sholder Mill SP ボデー単体: 0.1 / 0.3, インサート: M, C, K, E	 φ50~φ160		荒 Roughing 中仕上げ Semi Finishing	平面 Planing 側面 Side Cutting	C234

その他の工具
Other Tools

Indexable Tools

形状 Shape	商品コード Item code	インサート Inserts									コーナ 数 No. of corners	精度 Tolerance class	内接円 記号 Inscribed circle symbol	プログ ラミング R Programming R	最大 ap APMX	掲載 ページ Page	
		材種 Grades															
		JP4105	JP4120	JM4160	GX2140	JS4045	JS4060	JS4030	CY250	GF30							
	ENMU0603ER-C		●	●	●	●					4	M級 M	06	2.0	1.0	C28	
	ENMU0603ER-B		●	●	●	●						G級 G					
	EMGU0603ER-C	●															
	EPNW0603TN-8	●	●	●	●	●	●				2	N級 N	06	2.0	1.5	C54	
	EPMT0603TN-8	●	●	●	●	●	●					M級 M					
	EPMT0603EN-8LF			●								N級 N					
	EDNW12T3TN-10	●	●	●	●	●	●					M級 M					
	EDMT12T3TN-10	●	●	●	●	●	●										
	SPNW07T2TR	●	●	●	●	●					4	N級 N	07	2.0	1.2	C50	
	SPMT07T2TR		●	●		●						M級 M					
	SPMT07T2ER-LF		●	●													
	EPNW0803TN-10	●	●	●	●	●	●		●		2	N級 N	08	3.0	2.0	C32	
	EDNW10T3TN-10	●	●	●	●	●	●		●	●		N級 N					10
	EDNW13T4TN-10	●	●		●	●	●		●			N級 N	13				
	EDNW13T4TN-15	●	●	●	●	●	●		●	●		E級 E					
	EDEW13T4TN-10					●			●			N級 N					
	EDEW13T4TN-15					●			●			E級 E	15				
	EDNW13T4TN-15Z		●	●		●	●					N級 N					
	EDMT13T4TN-15			●	●	●	●		●			M級 M					
	EDNW15T4TN-10	●	●		●	●	●		●			N級 N					
	EDNW15T4TN-15	●	●	●	●	●	●		●	●		E級 E					
	EDEW15T4TN-10					●			●			N級 N	15				
	EDEW15T4TN-15					●			●			E級 E					
	EDNW15T4TN-15Z		●	●		●	●			●		N級 N					
EDMT15T4TN-15			●	●	●	●		●		M級 M							
	WDNW09T320	●	●	●	●	●	●				3	N級 N	09	3.0	2.0	C38	
	WDNT09T320				●	●	●					N級 N					
	WDNT09T320-B		●	●	●	●	●					N級 N					12
	WDNT09T320ZH			●			●					N級 N					
	WDNW120420	●	●	●	●	●	●					N級 N	14				
	WDNT120420				●	●	●					N級 N					
	WDNT120420-B		●	●	●	●	●					N級 N					
	WDNW120420Z		●	●		●						N級 N	14				
	WDNT120420ZH			●			●					N級 N					
	WDNW140520	●	●	●	●	●	●					N級 N					
	WDNT140520				●	●	●					N級 N	14				
	WDNT140520-B		●	●	●	●	●					N級 N					
	WDNW140520Z		●	●		●						N級 N					
WDNT140520ZH			●			●				N級 N							
	SDNW1205ZDTN-R15	●	●	●	●	●	●		●		4	N級 N	12	4.5	2.0	C44	
	SDMT1205ZDTN-R15	●	●	●	●	●	●		●			M級 M					
	WOMU140620ER-FC		●	●	●		●	●			6	M級 M	14	3.0	1.5	C22	
	WOMU140620ER-FB		●	●	●		●	●				M級 M					
	WOMU140630ER-HC		●	●	●		●	●				M級 M			3.0		
	SDNW120520TR	●	●	●	●		●				4	N級 N	12	3.0	1.2	C10	
	SDNW120520TR-P		●									N級 N					
	SDMT120520TR		●	●	●		●					M級 M					
	SDNW150525ZTR	●	●	●	●		●					N級 N					15
	SDMT150525ZTR		●	●	●		●					M級 M					
		JP4105	JP4120	JM4160	GX2140	JS4045	JS4060	JS4030	CY250	GF30							

●印：標準在庫品です。 ●：Stocked items. 無印：弊社営業へお問合せください。 No mark：Contact with our sales department.



●独自のインサート形状とボディ形状が導く、ひと味違う高効率加工。
 · Exclusive high-efficiency cutting, resulting from unique insert and body shapes

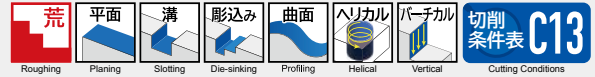

TR4F40 32- シャンクタイプ Shank type

○は数字、□は英文字が入ります。
 Numeric figure in a circle ○ and Alphabetical character comes in a square □



Fig.1 (一般形) (Standard type)

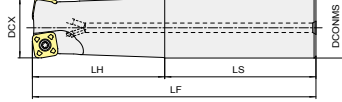
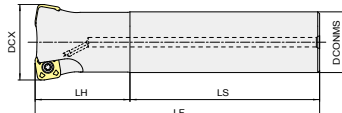

Fig.2 (アンダーカット形) (Undercut type)



エアーク付き
With air hole

タイプ Type	商品コード Item code	在庫 Stock	刃数 No. of flutes	寸法 Size (mm)					形状 Shape	適用インサート Recommended insert	希望小売価格(円) Suggested retail price (¥)
				DCX	LF	LH	LS	DCONMS			
レギュラー Regular	TR4F4032S32-2	●	2	32	150	70	80	32	Fig.1	SDNW120520TR(-P) SDMT120520TR	47,500
	TR4F4040S32-3	●	3	40	150	50	100	32	Fig.2		54,970
ロング Long	TR4F4032L32-2	●	2	32	200	120	80	32	Fig.1		50,030
	TR4F4040L32-3	●	3	40	250	50	200	32	Fig.2		64,400

TR4F40 M- モジュラータイプ Modular type

○は数字が入ります。Numeric figure comes in a circle ○。
 モジュラーミル用シャンクはD2頁を、締め付けトルクについてはD5頁を参照ください。
 Refer page D2 about the shanks for Modular Mill, Refer page D5 about tightening torque



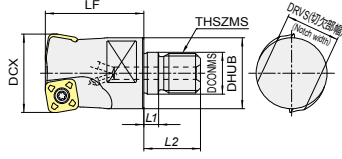

エアーク付き
With air hole

商品コード Item code	在庫 Stock	刃数 No. of flutes	寸法 Size (mm)							適用インサート Recommended Insert	希望小売価格(円) Suggested Retail Price (¥)	
			DCX	LF	L1	L2	DCONMS	DHUB	THSZMS			DRVS
TR4F4032M-2	●	2	32	40	6	23	17	28.8	M16	22	SDNW120520TR(-P) SDMT120520TR	45,170
TR4F4040M-3	●	3	40	40	6	23	17	28.8	M16	22	SDMT120520TR	51,620

[注意] モジュラーミル及び専用シャンク、専用アーバの「工具端面」「モジュラーねじ部」にグリースなどの潤滑剤は塗布しないでください。
[Note] When ※ and carbide shank are used together as a set, there is no interference.
 Do not apply lubricants such as grease, etc. to the "contact faces" and "modular screws" of the "modular mill", "dedicated shanks" and "dedicated arbor".

部品番号 Parts

部品名 Parts	クランプねじ Clamp screw		レンチ Wrench		ねじ焼き付き防止剤 Screw anti-seizure agent		アーバ用ねじ Arbor screw								
	形状 Shape	適用カッタ Cutter body	締付 トルク (N·m)	希望小売価格 (円) Suggested retail price (¥)	希望小売価格 (円) Suggested retail price (¥)	希望小売価格 (円) Suggested retail price (¥)	a	φb	c	d	f	希望小売価格 (円) Suggested retail price (¥)			
TR4F40 S/L/M (32)-○		262-141	2.9	870	105-T15	2,120	P-37	1,010	—	—	—	—	—		
TR4F4050 B-○									100-178	M10×1.5	16	35	25	8	1,760
TR4F4063 B-○									100-179	M12×1.75	18	42	30	10	1,760
TR4F4080 BM-○									100-180	M16×2.0	24	51	35	14	1,760
TR4F4080 B-○									100-178	M10×1.5	16	35	25	8	1,760
TR4F4100 B-○	555-141	4.9	690	105-T20	2,120	P-37	1,010	100-179	M12×1.75	18	42	30	10	1,760	
TR4F5063 B-4								100-180	M16×2.0	24	51	35	14	1,760	
TR4F5080 BM-5								100-178	M10×1.5	16	35	25	8	1,760	
TR4F5080 B-5	555-141	4.9	690	105-T20	2,120	P-37	1,010	100-179	M12×1.75	18	42	30	10	1,760	
TR4F5100 B-6								100-180	M16×2.0	24	51	35	14	1,760	
TR4F5125 B-○	—	—	—	—	—	—	—	—	—	—	—	—			

[注意] クランプねじは消耗品です。使用環境により交換寿命は変化しますので早めの交換をお願い致します。クランプねじは予備がシャンクタイプとモジュラータイプは1本、ボアタイプは2本付属します。

[Note] The clamp screw is a consumable part. Since replacement life depends on the use environment, it is recommended that it be replaced at an early stage. Includes one spare clamp screw for shank type and modular, two spare clamp screws for bore type.

○は数字、□は英文字が入ります。
 Numeric figure in a circle ○ and Alphabetical character comes in a square □.

TR4F○○○○B□-○ ボアタイプ Bore type

ボアタイプ用アーバはD11頁を参照ください。
 Refer page D11 about the bore type arbor

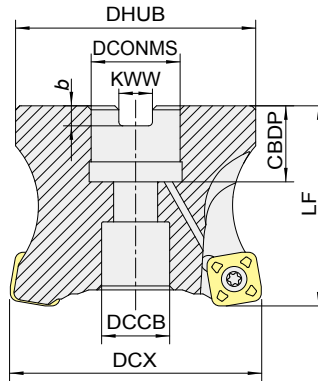

Fig.1 (エア穴付き)
With air hole

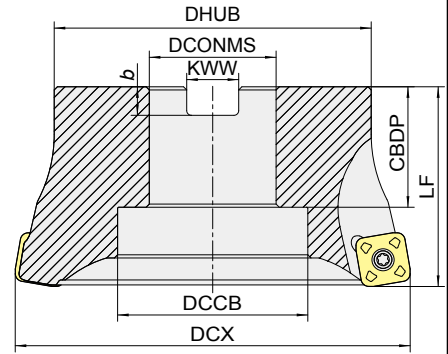

Fig.2 (エア穴無し)
Without air hole

タイプ Type	商品コード Item code	在庫 Stock	刃数 No. of flutes	寸法 Size (mm)								形状 Shape	適用インサート Recommended insert	希望小売価格(円) Suggested retail price (¥)	
				DCX	DHUB	LF	CBDP	KWW	b	DCONMS	DCCB				
ボアタイプ Bore type	内径インチサイズ Internal diameter inch size	●	3	50	47	50	19	8.4	5	22.225	17	Fig.1	SDNW120520TR(-P) SDMT120520TR	●	56,190
		●	4											68,400	
		●	5											78,640	
		●	4											71,100	
		●	5											78,010	
		●	6											90,640	
		●	5											95,600	
		●	7											111,210	
		●	6											125,520	
		●	8											145,490	
		●	4											71,100	
		●	5											95,600	
	●	6	125,520												
	●	6	131,380												
	●	7	148,980												
	内径ミリサイズ Internal diameter mm size	●	3	50	47	50	20	10.4	6.3	22	17	Fig.1	SDNW120520TR(-P) SDMT120520TR	●	56,190
		●	4											68,400	
		●	5											78,640	
		●	4											71,100	
		●	5											78,010	
		●	6											90,640	
		●	5											95,600	
		●	7											111,210	
		●	6											125,520	
●		8	145,490												
●		4	71,100												
●		5	95,600												
●	6	125,520													
●	6	131,380													
●	7	148,980													

【注意】アーバ用ねじは付属しません。

【Note】Arbor screw is not included.

●印：標準在庫品です。 ●：Stocked items.

アルファ高送りラジアスマイル TR4F

■ インサート Inserts

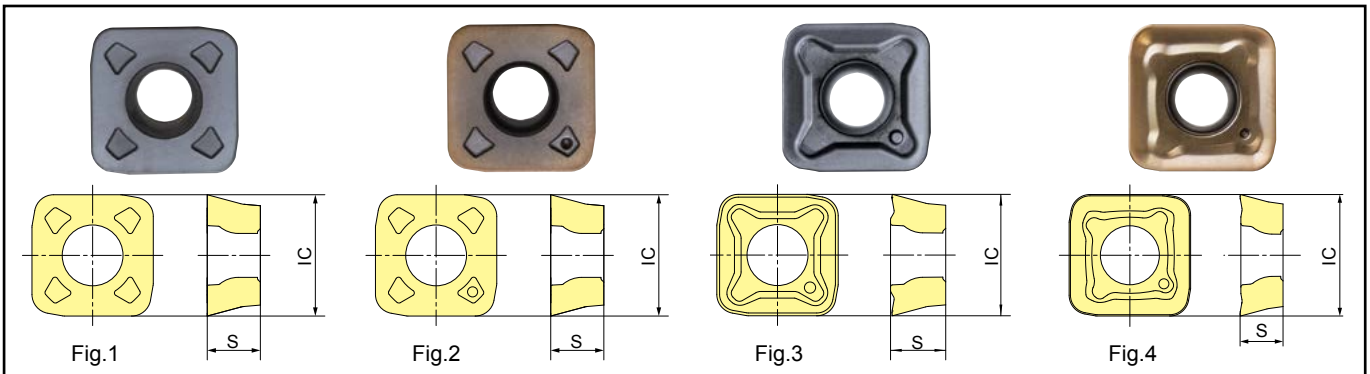

P 鋼 Carbon steels									■ : 一般切削・第一推奨 General cutting, First recommendation □ : 一般切削・第二推奨 General cutting, Second recommendation	
M SUS等 SUS, etc.										
K FC・FCD Cast irons										
H 高硬度材 Hardened steels										
商品コード Item code	精度 Tolerance class	AJコーティング AJ Coating					寸法 Size (mm)		形状 Shape	希望小売価(円) Suggested Retail Price (¥)
		JP4105	JP4120	JM4160	JS4060	GX2140	IC	S		
SDNW120520TR	N級 N	●	●	●	●	●	12.7	5.56	Fig.1	1,500
SDNW120520TR-P		●	●※1						Fig.2	1,500
SDNW150525ZTR		●	●	●	●	●	15.875		Fig.1	1,960
SDMT120520TR	M級 M		●	●	●	●	12.7	5.76	Fig.3	1,500
SDMT150525ZTR			●	●	●	●	15.875	5.61	Fig.4	1,960

※1: 析出硬化系ステンレス鋼の加工にもご使用頂けます。 ※1: Can be used to process the precipitation hardening stainless steel.

【注意】 GXコーティング、JSコーティングは通電式タッチセンサーに反応しませんのでご注意ください。

【Note】 Please note that the GX Coating and JS Coating do not cause a reaction in conductive touch sensors.

材種マップ(35HRC未満の鋼材)

Grade map for less than 35HRC

耐チッピング性 Chipping resistance	耐摩耗性 Wear resistance
JS4060	GX2140
湿式加工 Wet cutting	乾式加工 Dry cutting
JS4060	GX2140

被削材別推奨材種マップ

Grade map for work materials

被削材硬度 Work Hardness					被削材硬度 Work Hardness		被削材硬度 Work Hardness	
低い Low		High 高い			低い Low	High 高い	低い Low	High 高い
不安定加工 Unstable machining	安定加工 Stable machining	不安定加工 Unstable machining	安定加工 Stable machining	安定加工 Stable machining	不安定加工 Unstable machining	安定加工 Stable machining	不安定加工 Unstable machining	安定加工 Stable machining
JS4060	GX2140	JP4120	JP4105	JP4120	JM4160	JP4120	JS4060	GX2140
JP4105								JP4120
一般構造用鋼 (200HB以下) Mild steels (200HB or less)	炭素鋼・合金鋼 (30HRC以下) Carbon steels, Alloy steels (30HRC or less)	炭素鋼・合金鋼 (30~45HRC) Carbon steels Alloy steels	焼入れ鋼 (45~50HRC) Hardened steels	焼入れ鋼 (50~60HRC) Hardened steels	ステンレス鋼系材料 SUS Stainless steel materials			鋳鉄 FC,FCD Cast irons

○ インサートの使い分け Proper use of inserts

<p>SDNW120520TR SDNW150525ZTR</p> <p>刃先強度に優れた第一推奨インサート 一般的の高送り加工に適します The recommended default insert offers superior cutting edge strength. Ideal for general high-feed cutting.</p>	<p>SDNW120520TR-P</p> <p>突き出し量が短く、断続の少ない加工に推奨 特にプリハードン鋼(P20、P21材)に適します Recommended for relatively continuous (uninterrupted) cutting with short overhangs. Ideal for pre-hardened steels (P20 and P21 materials).</p>	<p>SDMT120520TR SDMT150525ZTR</p> <p>ブレーカ付きインサート 低剛性なワークや低馬力なM/Cでの荒加工に適します Breaker type insert. Ideal for rough machining with low-rigidity work materials and low-horsepower M/C.</p>
--	---	--

●印: 標準在庫品です。 ●: Stocked items. 無印: 弊社営業へお問合せください。 No mark: Contact with our sales department.

① シャンクタイプ・モジュラータイプ

Shank type / Modular type

TR4F4000形 (TR4F4000 S/M/L(32)-○)

○は数字が入ります。Numeric figure in a circle ○

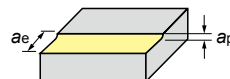

○ 等高線荒加工標準切削条件 Standard cutting conditions for contour roughing

タイプ Type		シャンクタイプ Shank Type				モジュラータイプ Modular Type								
被削材 Work material	推奨材種 Recommended inserts grade	工具径 DCX Tool dia.		φ32(2枚刃) (2 Flutes)		φ40(3枚刃) (3 Flutes)		φ32(2枚刃) (2 Flutes)			φ40(3枚刃) (3 Flutes)			
		突出し量 Overhang		<3DCX		<3DCX		<3DCX		3DCX-5DCX	<3DCX		3DCX-5DCX	
		汎用 General purpose	高速加工 High-speed Cutting	汎用 General purpose	高速加工 High-speed Cutting	汎用 General purpose	高速加工 High-speed Cutting	汎用 General purpose	高速加工 High-speed Cutting	3DCX-5DCX	汎用 General purpose	高速加工 High-speed Cutting	3DCX-5DCX	
一般構造用鋼 Mild steels (200HB以下) (200HB or less)	GX2140 JS4060	n (min ⁻¹)	1490	1990	1190	1590	1490	1990	1490	1990	1490	1190	1590	1190
		Vc(m/min)	150	200	150	200	150	200	150	200	150	200	150	200
		Vf(mm/min)	5360	7960	6430	9540	5360	7960	5360	7960	5360	6430	9540	6430
		fz(mm/t)	1.8	2.0	1.8	2.0	1.8	2.0	1.8	2.0	1.8	1.8	2.0	1.8
		ap(mm)	1.0	1.0	1.0	1.0	1.0	1.0	1.0	1.0	1.0	1.0	1.0	1.0
		ae(mm)	14	14	22	22	14	14	14	14	14	22	22	22
		Q(cm ³ /min)	75	111	141	210	75	111	75	111	75	141	210	141
炭素鋼合金鋼 Carbon steels Alloy steels (35HRC以下) (35HRC or less)	GX2140 JS4060	n (min ⁻¹)	1490	1990	1190	1590	1490	1990	1490	1990	1490	1190	1590	1190
		Vc(m/min)	150	200	150	200	150	200	150	200	150	200	150	200
		Vf(mm/min)	5360	7960	6430	9540	5360	7960	5360	7960	5360	6430	9540	6430
		fz(mm/t)	1.8	2.0	1.8	2.0	1.8	2.0	1.8	2.0	1.8	1.8	2.0	1.8
		ap(mm)	1.0	1.0	1.0	1.0	1.0	1.0	1.0	1.0	1.0	1.0	1.0	1.0
		ae(mm)	14	14	22	22	14	14	14	14	14	22	22	22
		Q(cm ³ /min)	75	111	141	210	75	111	75	111	75	141	210	141
炭素鋼合金鋼 Carbon steels Alloy steels (35~45HRC)	JP4120 JS4060	n (min ⁻¹)	1290	1490	1030	1190	1290	1490	1290	1490	1290	1030	1190	1030
		Vc(m/min)	130	150	130	150	130	150	130	150	130	130	150	130
		Vf(mm/min)	4640	5960	5560	7140	4640	5960	4640	5960	4640	5560	7140	5560
		fz(mm/t)	1.8	2.0	1.8	2.0	1.8	2.0	1.8	2.0	1.8	1.8	2.0	1.8
		ap(mm)	1.0	1.0	1.0	1.0	1.0	1.0	1.0	1.0	1.0	1.0	1.0	1.0
		ae(mm)	14	14	22	22	14	14	14	14	14	22	22	22
		Q(cm ³ /min)	65	83	122	157	65	83	65	83	65	122	157	122
ステンレス鋼 Stainless steels SUS	JM4160	n (min ⁻¹)	990	1990	800	1590	990	1990	990	1990	990	800	1590	800
		Vc(m/min)	100	200	100	200	100	200	100	200	100	100	200	100
		Vf(mm/min)	1980	3980	2400	4770	1980	3980	1980	3980	1980	2400	4770	2400
		fz(mm/t)	1.0	1.0	1.0	1.0	1.0	1.0	1.0	1.0	1.0	1.0	1.0	1.0
		ap(mm)	1.0	1.0	1.0	1.0	1.0	1.0	1.0	1.0	1.0	1.0	1.0	1.0
		ae(mm)	14	14	22	22	14	14	14	14	14	22	22	22
		Q(cm ³ /min)	28	56	53	105	28	56	28	56	28	53	105	53
鋳鉄 Cast irons FC FCD	JP4120 GX2140	n (min ⁻¹)	1490	1990	1190	1590	1490	1990	1490	1990	1490	1190	1590	1190
		Vc(m/min)	150	200	150	200	150	200	150	200	150	150	200	150
		Vf(mm/min)	5960	7960	7140	9540	5960	7960	5960	7960	5960	7140	9540	7140
		fz(mm/t)	2.0	2.0	2.0	2.0	2.0	2.0	2.0	2.0	2.0	2.0	2.0	2.0
		ap(mm)	1.0	1.0	1.0	1.0	1.0	1.0	1.0	1.0	1.0	1.0	1.0	1.0
		ae(mm)	14	14	22	22	14	14	14	14	14	22	22	22
		Q(cm ³ /min)	83	111	157	210	83	111	83	111	83	157	210	157
焼入れ鋼 Hardened steels (45~50HRC)	JP4120 JP4105	n (min ⁻¹)	800	900	640	720	800	900	800	900	800	640	720	640
		Vc(m/min)	80	90	80	90	80	90	80	90	80	80	90	80
		Vf(mm/min)	800	1440	960	1730	800	1440	800	1440	800	960	1730	960
		fz(mm/t)	0.5	0.8	0.5	0.8	0.5	0.8	0.5	0.8	0.5	0.5	0.8	0.5
		ap(mm)	0.8	0.8	0.8	0.8	0.8	0.8	0.8	0.8	0.8	0.8	0.8	0.8
		ae(mm)	14	14	22	22	14	14	14	14	14	22	22	22
		Q(cm ³ /min)	9	16	17	30	9	16	9	16	9	17	30	17
焼入れ鋼 Hardened steels (50~60HRC)	JP4105 JP4120	n (min ⁻¹)	800	900	640	720	800	900	800	900	800	640	720	640
		Vc(m/min)	80	90	80	90	80	90	80	90	80	80	90	80
		Vf(mm/min)	~ 640	~ 1080	~ 770	~ 1300	~ 640	~ 1080	~ 640	~ 1080	~ 640	~ 770	~ 1300	~ 770
		fz(mm/t)	~ 0.4	~ 0.6	~ 0.4	~ 0.6	~ 0.4	~ 0.6	~ 0.4	~ 0.6	~ 0.4	~ 0.4	~ 0.6	~ 0.4
		ap(mm)	~ 0.8	~ 0.8	~ 0.8	~ 0.8	~ 0.8	~ 0.8	~ 0.8	~ 0.8	~ 0.8	~ 0.8	~ 0.8	~ 0.8
		ae(mm)	14	14	22	22	14	14	14	14	14	22	22	22
		Q(cm ³ /min)	~ 7	~ 12	~ 14	~ 23	~ 7	~ 12	~ 7	~ 12	~ 7	~ 14	~ 23	~ 14

○ パーチカル荒加工標準切削条件 Standard cutting conditions for vertical roughing

被削材 Work material	推奨材種 Recommended inserts grade	工具径 DCX Tool dia.		φ 32(2枚刃) (2 Flutes)		φ 40(3枚刃) (3 Flutes)	
		突出し量 Overhang		<3DCX	3DCX-5DCX	<3DCX	3DCX-5DCX
鋳鉄 Cast irons FC FCD	JP4120 GX2140	n (min ⁻¹)		1990	1990	1590	1590
		Vc(m/min)		200	200	200	200
		Vf(mm/min)		600	600	720	720
		fz(mm/t)		0.15	0.15	0.15	0.15
		ap(mm)		≤ 0.5DCX		≤ 0.5DCX	
		ae(mm)		≤ 9.0		≤ 9.0	

【注意】①本表は切削条件の目安を示すものです。機械剛性やツーリング、加工物の状態に合わせて調整してください。

特に、溝切削を伴う、またはそれに近い切込み幅の加工などで、切りくずの噛み込みやヒビリ振動が発生し、トラブルに至る場合がありますので下記を参考に調整してください。

・回転数、テーブル送り量を50~70%下げる。

・切込み深さ ap を50~70%下げる。

・切込み幅 ae を50~70%下げる。

② GXコーティング、JSコーティングは通電式タッチセンサーに反応しませんのでご注意ください。

③ 「JP4105」は高硬度鋼専用材種で、生材には適しません。

④ 焼入れ鋼(50~60HRC)は、鋼種や工具突き出し量によって被削性が大きく異なる場合があります。加工状況に合わせて、テーブル送り量と切込み深さ ap を調整してください。

⑤ 強断続切削、突出しが長い場合及び湿式切削には「JM4160」を推奨します。

⑥ 切りくず噛み込みによる工具損傷防止のため、必ずエアブロー等による切りくず除去を行ってください。

⑦ 排出した切りくずは、飛散し作業者を切傷させ、火傷あるいは目に入って負傷させる恐れがありますので、ご使用に際してはその周囲に安全カバーを取付け、保護メガネ等の保護具を着用し、安全な環境で作業されることをお願い致します。

⑧ インサートの交換は早めに行い、過度の使用による破損を防止してください。

⑨ 突出し量 5DCX 以上の場合は、弊社防振アーハの適用を推奨致します。

⑩ 右記に単位時間当たりの切りくず排出量 Q を示します。 $Q(\text{cm}^3/\text{min}) = ap(\text{mm}) \times ae(\text{mm}) \times Vf(\text{mm}/\text{min}) / 1000$

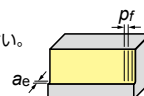

アルファ高送りラジアスマイル TR4F

② ボアタイプ

Bore type **TR4F4000形**(TR4F4050B \square 、TR4F4063B \square) ○は数字、□は英文字が入ります。 Numeric figure in a circle ○ and Alphabetical character comes in a square □.

◎ 等高線荒加工標準切削条件 Standard cutting conditions for contour roughing

被削材 Work material	推奨 材種 Recommended inserts grade	工具径 DCX Tool dia.	φ 50(3枚刃) (3 Flutes)			φ 50(4枚刃) (4 Flutes)			φ 50(5枚刃) (5 Flutes)		
			<3DCX		3DCX-5DCX	<3DCX		3DCX-5DCX	<3DCX		3DCX-5DCX
			汎用 General purpose	高速加工 High-speed Cutting		汎用 General purpose	高速加工 High-speed Cutting		汎用 General purpose	高速加工 High-speed Cutting	
一般構造用鋼 Mild steels (200HB 以下) (200HB or less)	GX2140 JS4060	n (min ⁻¹)	950	1270	950	950	1270	950	950	1270	950
		Vc(m/min)	150	200	150	150	200	150	150	200	150
		Vf(mm/min)	5130	7620	5130	6840	10160	6840	8550	12700	8550
		fz(mm/t)	1.8	2.0	1.8	1.8	2.0	1.8	1.8	2.0	1.8
		ap(mm)	1.0	1.0	1.0	1.0	1.0	1.0	1.0	1.0	1.0
		ae(mm)	30	30	30	30	30	30	30	30	30
		Q(cm ³ /min)	154	229	154	205	305	205	257	381	257
炭素鋼 合金鋼 Alloy steels (35HRC 以下) (35HRC or less)	GX2140 JS4060	n (min ⁻¹)	950	1270	950	950	1270	950	950	1270	950
		Vc(m/min)	150	200	150	150	200	150	150	200	150
		Vf(mm/min)	5130	7620	5130	6840	10160	6840	8550	12700	8550
		fz(mm/t)	1.8	2.0	1.8	1.8	2.0	1.8	1.8	2.0	1.8
		ap(mm)	1.0	1.0	1.0	1.0	1.0	1.0	1.0	1.0	1.0
		ae(mm)	30	30	30	30	30	30	30	30	30
		Q(cm ³ /min)	154	229	154	205	305	205	257	381	257
炭素鋼 合金鋼 Alloy steels (35 ~ 45HRC)	JP4120 JS4060	n (min ⁻¹)	830	950	830	830	950	830	830	950	830
		Vc(m/min)	130	150	130	130	150	130	130	150	130
		Vf(mm/min)	4480	5700	4480	5980	7600	5980	7470	9500	7470
		fz(mm/t)	1.8	2.0	1.8	1.8	2.0	1.8	1.8	2.0	1.8
		ap(mm)	1.0	1.0	1.0	1.0	1.0	1.0	1.0	1.0	1.0
		ae(mm)	30	30	30	30	30	30	30	30	30
		Q(cm ³ /min)	134	171	134	179	228	179	224	285	224
ステンレス鋼 Stainless steels SUS	JM4160	n (min ⁻¹)	640	1270	640	640	1270	640	640	1270	640
		Vc(m/min)	100	200	100	100	200	100	100	200	100
		Vf(mm/min)	1920	3810	1920	2560	5080	2560	3200	6350	3200
		fz(mm/t)	1.0	1.0	1.0	1.0	1.0	1.0	1.0	1.0	1.0
		ap(mm)	1.0	1.0	1.0	1.0	1.0	1.0	1.0	1.0	1.0
		ae(mm)	30	30	30	30	30	30	30	30	30
		Q(cm ³ /min)	58	114	58	77	152	77	96	191	96
鋳鉄 Cast irons FC FCD	JP4120 GX2140	n (min ⁻¹)	950	1270	950	950	1270	950	1270	950	
		Vc(m/min)	150	200	150	150	200	150	150	200	150
		Vf(mm/min)	5700	7620	5700	7600	10160	7600	9500	12700	9500
		fz(mm/t)	2.0	2.0	2.0	2.0	2.0	2.0	2.0	2.0	2.0
		ap(mm)	1.0	1.0	1.0	1.0	1.0	1.0	1.0	1.0	1.0
		ae(mm)	30	30	30	30	30	30	30	30	30
		Q(cm ³ /min)	171	229	171	228	305	228	285	381	285
焼入れ鋼 Hardened steels (45 ~ 50HRC)	JP4120 JP4105	n (min ⁻¹)	510	570	510	510	570	510	510	570	510
		Vc(m/min)	80	90	80	80	90	80	80	90	80
		Vf(mm/min)	770	1370	770	1020	1820	1020	1280	2280	1280
		fz(mm/t)	0.5	0.8	0.5	0.5	0.8	0.5	0.5	0.8	0.5
		ap(mm)	0.8	0.8	0.8	0.8	0.8	0.8	0.8	0.8	0.8
		ae(mm)	30	30	30	30	30	30	30	30	30
		Q(cm ³ /min)	18	33	18	24	44	24	31	55	31
焼入れ鋼 Hardened steels (50 ~ 60HRC)	JP4105 JP4120	n (min ⁻¹)	510	570	510	510	570	510	510	570	510
		Vc(m/min)	80	90	80	80	90	80	80	90	80
		Vf(mm/min)	~ 610	~ 1030	~ 610	~ 820	~ 1370	~ 820	~ 1020	~ 1710	~ 1020
		fz(mm/t)	~ 0.4	~ 0.6	~ 0.4	~ 0.4	~ 0.6	~ 0.4	~ 0.4	~ 0.6	~ 0.4
		ap(mm)	~ 0.8	~ 0.8	~ 0.8	~ 0.8	~ 0.8	~ 0.8	~ 0.8	~ 0.8	~ 0.8
		ae(mm)	30	30	30	30	30	30	30	30	30
		Q(cm ³ /min)	~ 15	~ 25	~ 15	~ 20	~ 33	~ 20	~ 24	~ 41	~ 24

刃先交換式工具 高送りラジアスマイル

◎ バーチカル荒加工標準切削条件 Standard cutting conditions for vertical roughing

被削材 Work material	推奨 材種 Recommended inserts grade	工具径 DCX Tool dia.	φ 50(3枚刃) (3 Flutes)		φ 50(4枚刃) (4 Flutes)		φ 50(5枚刃) (5 Flutes)	
			<3DCX	3DCX-5DCX	<3DCX	3DCX-5DCX	<3DCX	3DCX-5DCX
鋳鉄 Cast irons FC FCD	JP4120 GX2140	n (min ⁻¹)	1270	1270	1270	1270	1270	1270
		Vc(m/min)	200	200	200	200	200	200
		Vf(mm/min)	760	760	1020	1020	1270	1270
		fz(mm/t)	0.2	0.2	0.2	0.2	0.2	0.2
		ap(mm)	≤ 0.5DCX		≤ 0.5DCX		≤ 0.5DCX	
		ae(mm)	≤ 9.0		≤ 9.0		≤ 9.0	

- 【注意】**
- ①本表は切削条件の目安を示すものです。機械剛性やツーリング、加工物の状態に合わせて調整してください。特に、溝切削を伴う、またはそれに近い切込み幅の加工などで、切りくずの噛み込みやビビリ振動が発生し、トラブルに至る場合がありますので下記を参考に調整してください。
 - ・回転数、テーブル送り量を50~70%下げる。
 - ・切込み深さ ap を50~70%下げる。
 - ・切込み幅 ae を50~70%下げる。
 - ② GXコーティング、JSコーティングは通電式タッチセンサーに反応しませんのでご注意ください。
 - ③ 「JP4105」は高硬度鋼専用材種で、生材には適しません。
 - ④ 焼入れ鋼(50~60HRC)は、鋼種や工具突き出し量によって被削性が大きく異なる場合があります。加工状況に合わせて、テーブル送り量と切込み深さ ap を調整してください。
 - ⑤ 強断続切削、突出しなが長い場合及び湿式切削には「JM4160」推奨します。
 - ⑥ 切りくず噛み込みによる工具損傷防止のため、必ずエアブロー等による切りくず除去を行ってください。
 - ⑦ 排出した切りくずは、飛散し作業者を切傷させ、火傷あるいは目に入って負傷させる恐れがありますので、ご使用に際してはその周囲に安全カバーを取付け、保護メガネ等の保護具を着用し、安全な環境で作業されることをお願いします。
 - ⑧ インサートの交換は早めに行い、過度の使用による破損を防止してください。
 - ⑨ 突出し量 5DCX 以上の場合は、弊社防振アーバの適用を推奨致します。
 - ⑩ 右記に単位時間当たりの切りくず排出量 Q を示します。 $Q(\text{cm}^3/\text{min}) = \text{ap}(\text{mm}) \times \text{ae}(\text{mm}) \times \text{Vf}(\text{mm}/\text{min}) / 1000$

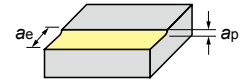

φ 63(4 枚刃) (4 Flutes)			φ 63(5 枚刃) (5 Flutes)			φ 63(6 枚刃) (6 Flutes)			被削材 Work material
<3DCX		3DCX-5DCX	<3DCX		3DCX-5DCX	<3DCX		3DCX-5DCX	
汎用 General purpose	高速加工 High-speed Cutting		汎用 General purpose	高速加工 High-speed Cutting		汎用 General purpose	高速加工 High-speed Cutting		
760	1010	760	760	1010	760	760	1010	760	一般構造用鋼 Mild steels (200HB 以下) (200HB or less)
150	200	150	150	200	150	150	200	150	
5470	8080	5470	6840	10100	6840	8210	12120	8210	
1.8	2.0	1.8	1.8	2.0	1.8	1.8	2.0	1.8	
1.0	1.0	1.0	1.0	1.0	1.0	1.0	1.0	1.0	
44	44	44	44	44	44	44	44	44	
241	356	241	301	444	301	361	533	361	
760	1010	760	760	1010	760	760	1010	760	
150	200	150	150	200	150	150	200	150	
5470	8080	5470	6840	10100	6840	8210	12120	8210	
1.8	2.0	1.8	1.8	2.0	1.8	1.8	2.0	1.8	
1.0	1.0	1.0	1.0	1.0	1.0	1.0	1.0	1.0	
44	44	44	44	44	44	44	44	44	
241	356	241	301	444	301	361	533	361	
660	760	660	660	760	660	660	760	660	
130	150	130	130	150	130	130	150	130	
4750	6080	4750	5940	7600	5940	7130	9120	7130	
1.8	2.0	1.8	1.8	2.0	1.8	1.8	2.0	1.8	
1.0	1.0	1.0	1.0	1.0	1.0	1.0	1.0	1.0	
44	44	44	44	44	44	44	44	44	
209	268	209	261	334	261	314	401	314	
510	1010	510	510	1010	510	510	1010	510	
100	200	100	100	200	100	100	200	100	
2040	4040	2040	2550	5050	2550	3060	6060	3060	
1.0	1.0	1.0	1.0	1.0	1.0	1.0	1.0	1.0	
1.0	1.0	1.0	1.0	1.0	1.0	1.0	1.0	1.0	
44	44	44	44	44	44	44	44	44	
90	178	90	112	222	112	135	267	135	
760	1010	760	760	1010	760	760	1010	760	
150	200	150	150	200	150	150	200	150	
6080	8080	6080	7600	10100	7600	9120	12120	9120	
2.0	2.0	2.0	2.0	2.0	2.0	2.0	2.0	2.0	
1.0	1.0	1.0	1.0	1.0	1.0	1.0	1.0	1.0	
44	44	44	44	44	44	44	44	44	
268	356	268	334	444	334	401	533	401	
400	450	400	400	450	400	400	450	400	
80	90	80	80	90	80	80	90	80	
800	1440	800	1000	1800	1000	1200	2160	1200	
0.5	0.8	0.5	0.5	0.8	0.5	0.5	0.8	0.5	
0.8	0.8	0.8	0.8	0.8	0.8	0.8	0.8	0.8	
44	44	44	44	44	44	44	44	44	
28	51	28	35	63	35	42	76	42	
400	450	400	400	450	400	400	450	400	
80	90	80	80	90	80	80	90	80	
~ 640	~ 1080	~ 640	~ 800	~ 1350	~ 800	~ 960	~ 1620	~ 960	
~ 0.4	~ 0.6	~ 0.4	~ 0.4	~ 0.6	~ 0.4	~ 0.4	~ 0.6	~ 0.4	
~ 0.8	~ 0.8	~ 0.8	~ 0.8	~ 0.8	~ 0.8	~ 0.8	~ 0.8	~ 0.8	
44	44	44	44	44	44	44	44	44	
~ 23	~ 38	~ 23	~ 28	~ 48	~ 28	~ 34	~ 57	~ 34	

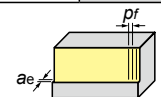

φ 63(4 枚刃) (4 Flutes)		φ 63(5 枚刃) (5 Flutes)		φ 63(6 枚刃) (6 Flutes)		被削材 Work material
<3DCX	3DCX-5DCX	<3DCX	3DCX-5DCX	<3DCX	3DCX-5DCX	
1010	1010	1010	1010	1010	1010	鋳鉄 Cast irons FC FCD
200	200	200	200	200	200	
810	810	1010	1010	1210	1210	
0.2	0.2	0.2	0.2	0.2	0.2	
≤ 0.5DCX ≤ 9.0		≤ 0.5DCX ≤ 9.0		≤ 0.5DCX ≤ 9.0		

- [Note]**
- This table provides general guidelines for cutting conditions; in actual machining conditions adjust the parameters according to your actual machine and work-piece conditions. In particular, when performing shoulder milling in combination with slotting or machining of cutting widths close to slots, etc., chattering vibrations may occur, which can lead to trouble. Therefore, please consider the following when adjusting the conditions;
 - Reduce rotation speed and table feed rate by 50 to 70%
 - Reduce cutting depth a_p by 50 to 70%
 - Reduce cutting width a_e by 50 to 70%
 - Please note that the GX Coating and JS Coating do not cause a reaction in conductive touch sensors.
 - JP4105 is for the high-hardness steels. It is not suitable for Non-heat-treated steel material.
 - The machinability of hardened steels (50 - 60HRC) can vary significantly depending on the particular steel type and tool overhang. Adjust the table feed rate and cutting depth a_p to suit machining conditions.
 - For strongly interrupted cutting, when unsupported length is long, or for wet cutting, JM4160 is recommended.
 - To prevent tool damage due to chip clogging, always use a chip removal method such as an air blower, etc.
 - Since there is a danger of the removed chips flying out and causing injury to workers, fire, or damage to eyes, during use be sure to cover the work area with a safety cover and have workers wear protective equipment such as glasses, etc. to make the work area safe.
 - Perform insert replacement at an early stage to prevent chipping due to excessive use.
 - Use of the MOLDINO anti-vibration arbor is recommended for overhang of 5DCX or more.
 - The following equation can be used to determine the metal removal rate per unit time Q ; $Q(\text{cm}^3/\text{min}) = a_p(\text{mm}) \times a_e(\text{mm}) \times V_f(\text{mm}/\text{min}) / 1000$

アルファ高送りラジアスマイル TR4F

② ボアタイプ

Bore type **TR4F4000形**(TR4F4080B \square 、TR4F4100B \square) ○は数字、□は英文字が入ります。 Numeric figure in a circle ○ and Alphabetical character comes in a square □.

◎ 等高線荒加工標準切削条件 Standard cutting conditions for contour roughing

被削材 Work material	推奨 材種 Recommended inserts grade	工具径 DCX Tool dia.	φ 80(5枚刃) (5 Flutes)			φ 80(7枚刃) (7 Flutes)		
			<3DCX		3DCX-5DCX	<3DCX		3DCX-5DCX
			汎用 General purpose	高速加工 High-speed Cutting		汎用 General purpose	高速加工 High-speed Cutting	
一般構造用鋼 Mild steels (200HB 以下) (200HB or less)	GX2140 JS4060	n (min ⁻¹)	600	800	600	600	800	600
		Vc(m/min)	150	200	150	150	200	150
		Vf(mm/min)	5400	8000	5400	7560	11200	7560
		fz(mm/t)	1.8	2.0	1.8	1.8	2.0	1.8
		ap(mm)	1.0	1.0	1.0	1.0	1.0	1.0
		ae(mm)	60	60	60	60	60	60
		Q(cm ³ /min)	324	480	324	454	672	454
炭素鋼 合金鋼 Alloy steels (35HRC 以下) (35HRC or less)	GX2140 JS4060	n (min ⁻¹)	600	800	600	600	800	600
		Vc(m/min)	150	200	150	150	200	150
		Vf(mm/min)	5400	8000	5400	7560	11200	7560
		fz(mm/t)	1.8	2.0	1.8	1.8	2.0	1.8
		ap(mm)	1.0	1.0	1.0	1.0	1.0	1.0
		ae(mm)	60	60	60	60	60	60
		Q(cm ³ /min)	324	480	324	454	672	454
炭素鋼 合金鋼 Alloy steels (35 ~ 45HRC)	JP4120 JS4060	n (min ⁻¹)	520	600	520	520	600	520
		Vc(m/min)	130	150	130	130	150	130
		Vf(mm/min)	4680	6000	4680	6550	8400	6550
		fz(mm/t)	1.8	2.0	1.8	1.8	2.0	1.8
		ap(mm)	1.0	1.0	1.0	1.0	1.0	1.0
		ae(mm)	60	60	60	60	60	60
		Q(cm ³ /min)	281	360	281	393	504	393
ステンレス鋼 Stainless steels SUS	JM4160	n (min ⁻¹)	400	800	400	400	800	400
		Vc(m/min)	100	200	100	100	200	100
		Vf(mm/min)	2000	4000	2000	2800	5600	2800
		fz(mm/t)	1.0	1.0	1.0	1.0	1.0	1.0
		ap(mm)	1.0	1.0	1.0	1.0	1.0	1.0
		ae(mm)	60	60	60	60	60	60
		Q(cm ³ /min)	120	240	120	168	336	168
鋳鉄 Cast irons FC FCD	JP4120 GX2140	n (min ⁻¹)	600	800	600	600	800	600
		Vc(m/min)	150	200	150	150	200	150
		Vf(mm/min)	6000	8000	6000	8400	11200	8400
		fz(mm/t)	2.0	2.0	2.0	2.0	2.0	2.0
		ap(mm)	1.0	1.0	1.0	1.0	1.0	1.0
		ae(mm)	60	60	60	60	60	60
		Q(cm ³ /min)	360	480	360	504	672	504
焼入れ鋼 Hardened steels (45 ~ 50HRC)	JP4120 JP4105	n (min ⁻¹)	320	360	320	320	360	320
		Vc(m/min)	80	90	80	80	90	80
		Vf(mm/min)	800	1440	800	1120	2020	1120
		fz(mm/t)	0.5	0.8	0.5	0.5	0.8	0.5
		ap(mm)	0.8	0.8	0.8	0.8	0.8	0.8
		ae(mm)	60	60	60	60	60	60
		Q(cm ³ /min)	38	69	38	54	97	54
焼入れ鋼 Hardened steels (50 ~ 60HRC)	JP4105 JP4120	n (min ⁻¹)	320	360	320	320	360	320
		Vc(m/min)	80	90	80	80	90	80
		Vf(mm/min)	~ 640	~ 1080	~ 640	~ 900	~ 1510	~ 900
		fz(mm/t)	~ 0.4	~ 0.6	~ 0.4	~ 0.4	~ 0.6	~ 0.4
		ap(mm)	~ 0.8	~ 0.8	~ 0.8	~ 0.8	~ 0.8	~ 0.8
		ae(mm)	60	60	60	60	60	60
		Q(cm ³ /min)	~ 31	~ 52	~ 31	~ 43	~ 72	~ 43

刃先交換式工具 高送りラジアスマイル

◎ バーチカル荒加工標準切削条件 Standard cutting conditions for vertical roughing

被削材 Work material	推奨 材種 Recommended inserts grade	工具径 DCX Tool dia.	φ 80(5枚刃) (5 Flutes)		φ 80(7枚刃) (7 Flutes)		
			<3DCX		3DCX-5DCX	<3DCX	3DCX-5DCX
			突出し量 Overhang				
鋳鉄 Cast irons FC FCD	JP4120 GX2140	n (min ⁻¹)	800		800	800	
		Vc(m/min)	200		200	200	
		Vf(mm/min)	800		800	1120	
		fz(mm/t)	0.2		0.2	0.2	
		ap(mm)	≤ 0.5DCX			≤ 0.5DCX	
		≤ 9.0			≤ 9.0		

- 【注意】** ①本表は切削条件の目安を示すものです。機械剛性やツーリング、加工物の状態に合わせて調整してください。特に、溝切削を伴う、またはそれに近い切込み幅の加工などで、切りくずの噛み込みやビビリ振動が発生し、トラブルに至る場合がありますので下記を参考に調整してください。
- ・回転数、テーブル送り量を50~70%下げる。
 - ・切込み深さapを50~70%下げる。
 - ・切込み幅aeを50~70%下げる。
- ② GXコーティング、JSコーティングは通電式タッチセンサーに反応しませんのでご注意ください。
- ③ 「JP4105」は高硬度鋼専用材種で、生材には適しません。
- ④ 焼入れ鋼(50~60HRC)は、鋼種や工具突出し量によって被削性が大きく異なる場合があります。加工状況に合わせて、テーブル送り量と切込み深さapを調整してください。
- ⑤ 強断続切削、突出しが長い場合及び湿式切削には「JM4160」を推奨します。
- ⑥ 切りくず噛み込みによる工具損傷防止のため、必ずエアブロー等による切りくず除去を行ってください。
- ⑦ 排出した切りくずは、飛散し作業者を切傷させ、火傷あるいは目に入って負傷させる恐れがありますので、ご使用に際してはその周囲に安全カバーを取付け、保護メガネ等の保護具を着用し、安全な環境で作業されることを願います。
- ⑧ インサートの交換は早めに行い、過度の使用による破損を防止してください。
- ⑨ 突出し量5DCX以上の場合は、弊社防振アーバの適用を推奨致します。
- ⑩ 右記に単位時間当たりの切りくず排出量Qを示します。 $Q(\text{cm}^3/\text{min}) = ap(\text{mm}) \times ae(\text{mm}) \times Vf(\text{mm}/\text{min}) / 1000$

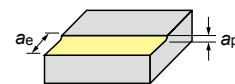

φ 100(6枚刃) (6 Flutes)			φ 100(8枚刃) (8 Flutes)			被削材 Work material
<3DCX		3DCX-5DCX	<3DCX		3DCX-5DCX	
汎用 General purpose	高速加工 High-speed Cutting		汎用 General purpose	高速加工 High-speed Cutting		
480	640	480	480	640	480	一般構造用鋼 Mild steels (200HB 以下) (200HB or less)
150	200	150	150	200	150	
5180	7680	5180	6910	10240	6910	
1.8	2.0	1.8	1.8	2.0	1.8	
1.0	1.0	1.0	1.0	1.0	1.0	
80	80	80	80	80	80	
414	614	414	553	819	553	炭素鋼 合金鋼 Carbon steels Alloy steels (35HRC 以下) (35HRC or less)
480	640	480	480	640	480	
150	200	150	150	200	150	
5180	7680	5180	6910	10240	6910	
1.8	2.0	1.8	1.8	2.0	1.8	
1.0	1.0	1.0	1.0	1.0	1.0	
80	80	80	80	80	80	炭素鋼 合金鋼 Carbon steels Alloy steels (35 ~ 45HRC)
414	614	414	553	819	553	
410	480	410	410	480	410	
130	150	130	130	150	130	
4430	5760	4430	5900	7680	5900	
1.8	2.0	1.8	1.8	2.0	1.8	
1.0	1.0	1.0	1.0	1.0	1.0	
80	80	80	80	80	80	
354	461	354	472	614	472	ステンレス鋼 Stainless steels SUS
320	640	320	320	640	320	
100	200	100	100	200	100	
1920	3840	1920	2560	5120	2560	
1.0	1.0	1.0	1.0	1.0	1.0	
1.0	1.0	1.0	1.0	1.0	1.0	
80	80	80	80	80	80	鋳鉄 Cast irons FC FCD
154	307	154	205	410	205	
480	640	480	480	640	480	
150	200	150	150	200	150	
5760	7680	5760	7680	10240	7680	
2.0	2.0	2.0	2.0	2.0	2.0	
1.0	1.0	1.0	1.0	1.0	1.0	
80	80	80	80	80	80	
461	614	461	614	819	614	焼入れ鋼 Hardened steels (45 ~ 50HRC)
250	290	250	250	290	250	
80	90	80	80	90	80	
750	1390	750	1000	1860	1000	
0.5	0.8	0.5	0.5	0.8	0.5	
0.8	0.8	0.8	0.8	0.8	0.8	
80	80	80	80	80	80	
48	89	48	64	119	64	焼入れ鋼 Hardened steels (50 ~ 60HRC)
250	290	250	250	290	250	
80	90	80	80	90	80	
~ 600	~ 1040	~ 600	~ 800	~ 1390	~ 800	
~ 0.4	~ 0.6	~ 0.4	~ 0.4	~ 0.6	~ 0.4	
~ 0.8	~ 0.8	~ 0.8	~ 0.8	~ 0.8	~ 0.8	
80	80	80	80	80	80	
~ 38	~ 67	~ 38	~ 51	~ 89	~ 51	

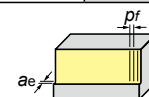

φ 100(6枚刃) (6 Flutes)		φ 100(8枚刃) (8 Flutes)		被削材 Work material
<3DCX	3DCX-5DCX	<3DCX	3DCX-5DCX	
640	640	640	640	鋳鉄 Cast irons FC FCD
200	200	200	200	
770	770	1020	1020	
0.2	0.2	0.2	0.2	
≦ 0.5DCX		≦ 0.5DCX		
≦ 9.0		≦ 9.0		

- [Note] ① This table provides general guidelines for cutting conditions; in actual machining conditions adjust the parameters according to your actual machine and work-piece conditions. In particular, when performing shoulder milling in combination with slotting or machining of cutting widths close to slots, etc., chattering vibrations may occur, which can lead to trouble. Therefore, please consider the following when adjusting the conditions;
- Reduce rotation speed and table feed rate by 50 to 70%
 - Reduce cutting depth a_p by 50 to 70%
 - Reduce cutting width a_e by 50 to 70%
- ② Please note that the GX Coating and JS Coating do not cause a reaction in conductive touch sensors.
- ③ JP4105 is for the high-hardness steels. It is not suitable for Non-heat-treated steel material.
- ④ The machinability of hardened steels (50 - 60HRC) can vary significantly depending on the particular steel type and tool overhang. Adjust the table feed rate and cutting depth a_p to suit machining conditions.
- ⑤ For strongly interrupted cutting, when unsupported length is long, or for wet cutting, JM4160 is recommended.
- ⑥ To prevent tool damage due to chip clogging, always use a chip removal method such as an air blower, etc.
- ⑦ Since there is a danger of the removed chips flying out and causing injury to workers, fire, or damage to eyes, during use be sure to cover the work area with a safety cover and have workers wear protective equipment such as glasses, etc. to make the work area safe.
- ⑧ Perform insert replacement at an early stage to prevent chipping due to excessive use.
- ⑨ Use of the MOLDINO anti-vibration arbor is recommended for overhang of 5DCX or more.
- ⑩ The following equation can be used to determine the metal removal rate per unit time Q : $Q(\text{cm}^3/\text{min}) = a_p(\text{mm}) \times a_e(\text{mm}) \times Vf(\text{mm}/\text{min}) / 1000$

アルファ高送りラジアスマイル TR4F

② ボアタイプ

Bore type **TR4F5000形**(TR4F5 **B**) ○は数字、□は英文字が入ります。 Numeric figure in a circle ○ and Alphabetical character comes in a square □.

◎ 等高線荒加工標準切削条件 Standard cutting conditions for contour roughing

被削材 Work material	推奨 材種 Recommended inserts grade	工具径 DCX Tool dia. 突出し量 Overhang	φ 63(4 枚刃) (4 Flutes)			φ 80(5 枚刃) (5 Flutes)		
			<3DCX		3DCX-5DCX	<3DCX		3DCX-5DCX
			汎用 General purpose	高能率 High efficiency		汎用 General purpose	高能率 High efficiency	
一般構造用鋼 Mild steels (200HB 以下) (200HB or less)	GX2140 JS4060	n (min ⁻¹)	760	910	760	600	720	600
		Vc(m/min)	150	180	150	150	180	150
		Vf(mm/min)	4560	7280	5470	4500	7200	5400
		fz(mm/t)	1.5	2.0	1.8	1.5	2.0	1.8
		a _p (mm)	2.0	2.0	1.0	2.0	2.0	1.0
		a _e (mm)	38	38	38	56	56	56
		Q(cm ³ /min)	347	553	208	504	806	302
炭素鋼 合金鋼 Carbon steels Alloy steels (35HRC 以下) (35HRC or less)	GX2140 JS4060	n (min ⁻¹)	760	910	760	600	720	600
		Vc(m/min)	150	180	150	150	180	150
		Vf(mm/min)	4560	7280	5470	4500	7200	5400
		fz(mm/t)	1.5	2.0	1.8	1.5	2.0	1.8
		a _p (mm)	2.0	2.0	1.0	2.0	2.0	1.0
		a _e (mm)	38	38	38	56	56	56
		Q(cm ³ /min)	347	553	208	504	806	302
炭素鋼 合金鋼 Carbon steels Alloy steels (35 ~ 45HRC)	JP4120 JS4060	n (min ⁻¹)	660	760	660	520	600	520
		Vc(m/min)	130	150	130	130	150	130
		Vf(mm/min)	4750	6080	4750	4680	6000	4680
		fz(mm/t)	1.8	2.0	1.8	1.8	2.0	1.8
		a _p (mm)	1.5	1.5	1.0	1.5	1.5	1.0
		a _e (mm)	38	38	38	56	56	56
		Q(cm ³ /min)	271	347	181	393	504	262
ステンレス鋼 Stainless steels SUS	JM4160	n (min ⁻¹)	510	1010	510	400	800	400
		Vc(m/min)	100	200	100	100	200	100
		Vf(mm/min)	2040	4040	2040	2000	4000	2000
		fz(mm/t)	1.0	1.0	1.0	1.0	1.0	1.0
		a _p (mm)	1.5	1.5	1.0	1.5	1.5	1.0
		a _e (mm)	38	38	38	56	56	56
		Q(cm ³ /min)	116	230	78	168	336	112
鋳鉄 Cast irons FC FCD	JP4120 GX2140	n (min ⁻¹)	760	910	760	600	720	600
		Vc(m/min)	150	180	150	150	180	150
		Vf(mm/min)	6080	8370	6080	6000	8280	6000
		fz(mm/t)	2.0	2.3	2.0	2.0	2.3	2.0
		a _p (mm)	2.0	2.0	2.0	2.0	2.0	2.0
		a _e (mm)	38	38	38	56	56	56
		Q(cm ³ /min)	462	636	462	672	927	672
焼入れ鋼 Hardened steels (45 ~ 50HRC)	JP4120 JP4105	n (min ⁻¹)	400	450	400	320	360	320
		Vc(m/min)	80	90	80	80	90	80
		Vf(mm/min)	800	1440	800	800	1440	800
		fz(mm/t)	0.5	0.8	0.5	0.5	0.8	0.5
		a _p (mm)	1.0	1.0	1.0	1.0	1.0	1.0
		a _e (mm)	38	38	38	56	56	56
		Q(cm ³ /min)	30	55	30	45	81	45
焼入れ鋼 Hardened steels (50 ~ 60HRC)	JP4105 JP4120	n (min ⁻¹)	400	450	400	320	360	320
		Vc(m/min)	80	90	80	80	90	80
		Vf(mm/min)	~ 640	~ 1080	~ 640	~ 640	~ 1080	~ 640
		fz(mm/t)	~ 0.4	~ 0.6	~ 0.4	~ 0.4	~ 0.6	~ 0.4
		a _p (mm)	~ 1.0	~ 1.0	~ 1.0	~ 1.0	~ 1.0	~ 1.0
		a _e (mm)	38	38	38	56	56	56
		Q(cm ³ /min)	~ 24	~ 41	~ 24	~ 36	~ 60	~ 36

刃先交換式工具 高送りラジアスマイル

◎ パーチカル荒加工標準切削条件 Standard cutting conditions for vertical roughing

被削材 Work material	推奨 材種 Recommended inserts grade	工具径 DCX Tool dia. 突出し量 Overhang	φ 63(4 枚刃) (4 Flutes)		φ 80(5 枚刃) (5 Flutes)	
			<3DCX	3DCX-5DCX	<3DCX	3DCX-5DCX
			鋳鉄 Cast irons FC FCD	JP4120 GX2140	n (min ⁻¹)	1010
Vc(m/min)	200	200			200	200
Vf(mm/min)	810	810			800	800
fz(mm/t)	0.2	0.2			0.2	0.2
pf(mm)	≤ 0.5DCX				≤ 0.5DCX	
a _e (mm)	≤ 11.0				≤ 11.0	

- 【注意】** ①本表は切削条件の目安を示すものです。機械剛性やツーリング、加工物の状態に合わせて調整してください。
特に、溝切削を伴う、またはそれに近い切込み幅の加工などで、切りくずの噛み込みやビビリ振動が発生し、トラブルに至る場合がありますので下記を参考に調整してください。
・回転数、テーブル送り量を 50 ~ 70% 下げる。
・切込み深さ a_p を 50 ~ 70% 下げる。
・切込み幅 a_e を 50 ~ 70% 下げる。
②機械動力が不足する場合は、まず切込み深さを下げてください。次いで回転数およびテーブル送り量を下げてください。
③ GXコーティング、JSコーティングは通電式タッチセンサーに反応しませんのでご注意ください。
④ 「JP4105」は高硬度鋼専用材種で、生材には適しません。
⑤ 焼入れ鋼 (50~60HRC) は、鋼種や工具突き出し量によって被削性が大きく異なる場合があります。加工状況に合わせて、テーブル送り量と切込み深さ a_p を調整してください。
⑥ 強断続切削、突出しが長い場合及び湿式切削には「JM4160」を推奨します。
⑦ 切りくず噛み込みによる工具排屑防止のため、必ずエアブロー等による切りくず除去を行ってください。
⑧ 排出した切りくずは、飛散し作業者を切傷させ、火傷あるいは目に入って負傷させる恐れがありますので、ご使用に際してはその周囲に安全カバーを取付け、保護メガネ等の保護具を着用し、安全な環境で作業されることをお願い致します。
⑨ インサートの交換は早めに行い、過度の使用による破損を防止してください。
⑩ 突出し量 5DCX 以上の場合は、弊社防振アーバの適用を推奨致します。
⑪ 右記に単位時間当たりの切りくず排出量 Q を示します。 $Q(\text{cm}^3/\text{min}) = a_p(\text{mm}) \times a_e(\text{mm}) \times V_f(\text{mm}/\text{min}) / 1000$

※高効率条件は、ご使用の機械の動力・トルク線図をご確認いただき、主軸の定格動力を確保できる回転数での適用を推奨いたします。
 ※ To ensure high-efficiency conditions, we recommend checking the machine's power/torque chart and using a rotation speed that can maintain the rated power of the spindle.

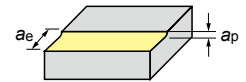

φ 100(6枚刃) (6 Flutes)			φ 125(6枚刃) (6 Flutes)			φ 125(7枚刃) (7 Flutes)			被削材 Work material
<3DCX		3DCX-5DCX	<3DCX		3DCX-5DCX	<3DCX		3DCX-5DCX	
汎用 General purpose	高効率 High efficiency		汎用 General purpose	高効率 High efficiency		汎用 General purpose	高効率 High efficiency		
480	570	480	380	460	380	380	460	380	一般構造用鋼 Mild steels (200HB 以下) (200HB or less)
150	180	150	150	180	150	150	180	150	
4320	6840	5180	3420	5520	4100	3990	6440	4790	
1.5	2.0	1.8	1.5	2.0	1.8	1.5	2.0	1.8	
2.0	2.0	1.0	2.0	2.0	1.0	2.0	2.0	1.0	
75	75	75	100	100	100	100	100	100	
648	1026	389	684	1104	410	798	1288	479	
480	570	480	380	460	380	380	460	380	
150	180	150	150	180	150	150	180	150	
4320	6840	5180	3420	5520	4100	3990	6440	4790	
1.5	2.0	1.8	1.5	2.0	1.8	1.5	2.0	1.8	
2.0	2.0	1.0	2.0	2.0	1.0	2.0	2.0	1.0	
75	75	75	100	100	100	100	100	100	
648	1026	389	684	1104	410	798	1288	479	
410	480	410	330	380	330	330	380	330	
130	150	130	130	150	130	130	150	130	
4430	5760	4430	3560	4560	3560	4160	5320	4160	
1.8	2.0	1.8	1.8	2.0	1.8	1.8	2.0	1.8	
1.5	1.5	1.0	1.5	1.5	1.0	1.5	1.5	1.0	
75	75	75	100	100	100	100	100	100	
498	648	332	534	684	356	624	798	416	
320	640	320	250	510	250	250	510	250	
100	200	100	100	200	100	100	200	100	
1920	3840	1920	1500	3060	1500	1750	3570	1750	
1.0	1.0	1.0	1.0	1.0	1.0	1.0	1.0	1.0	
1.5	1.5	1.0	1.5	1.5	1.0	1.5	1.5	1.0	
75	75	75	100	100	100	100	100	100	
216	432	144	225	459	150	263	536	175	
480	570	480	380	460	380	380	460	380	
150	180	150	150	180	150	150	180	150	
5760	7870	5760	4560	6350	4560	5320	7410	5320	
2.0	2.3	2.0	2.0	2.3	2.0	2.0	2.3	2.0	
2.0	2.0	2.0	2.0	2.0	2.0	2.0	2.0	2.0	
75	75	75	100	100	100	100	100	100	
864	1181	864	912	1270	912	1064	1482	1064	
250	290	250	200	230	200	200	230	200	
80	90	80	80	90	80	80	90	80	
750	1390	750	600	1100	600	700	1290	700	
0.5	0.8	0.5	0.5	0.8	0.5	0.5	0.8	0.5	
1.0	1.0	1.0	1.0	1.0	1.0	1.0	1.0	1.0	
75	75	75	100	100	100	100	100	100	
56	104	56	60	110	60	70	129	70	
250	290	250	200	230	200	200	230	200	
80	90	80	80	90	80	80	90	80	
~ 600	~ 1040	~ 600	~ 480	~ 830	~ 480	~ 560	~ 970	~ 560	
~ 0.4	~ 0.6	~ 0.4	~ 0.4	~ 0.6	~ 0.4	~ 0.4	~ 0.6	~ 0.4	
~ 1.0	~ 1.0	~ 1.0	~ 1.0	~ 1.0	~ 1.0	~ 1.0	~ 1.0	~ 1.0	
75	75	75	100	100	100	100	100	100	
~ 45	~ 78	~ 45	~ 48	~ 83	~ 48	~ 56	~ 97	~ 56	

φ 100(6枚刃) (6 Flutes)		φ 125(6枚刃) (6 Flutes)		φ 125(7枚刃) (7 Flutes)		被削材 Work material
<3DCX	3DCX-5DCX	<3DCX	3DCX-5DCX	<3DCX	3DCX-5DCX	
640	640	510	510	510	510	
200	200	200	200	200	200	
770	770	610	610	710	710	
0.2	0.2	0.2	0.2	0.2	0.2	
≤ 0.5DCX		≤ 0.5DCX		≤ 0.5DCX		
≤ 11.0		≤ 11.0		≤ 11.0		

[Note] ① This table provides general guidelines for cutting conditions; in actual machining conditions adjust the parameters according to your actual machine and work-piece conditions. In particular, when performing shoulder milling in combination with slotting or machining of cutting widths close to slots, etc., chattering vibrations may occur, which can lead to trouble. Therefore, please consider the following when adjusting the conditions:
 ・ Reduce rotation speed and table feed rate by 50 to 70%
 ・ Reduce cutting depth a_p by 50 to 70%
 ・ Reduce cutting width a_e by 50 to 70%

② If the machine has insufficient power, first try reducing the cutting depth. Next, try reducing the rotation speed and table feed rate.
 ③ Please note that the GX Coating and JS Coating do not cause a reaction in conductive touch sensors.
 ④ JP4105 is for the high-hardness steels. It is not suitable for Non-heat-treated steel material.
 ⑤ The machinability of hardened steels (50 - 60HRC) can vary significantly depending on the particular steel type and tool overhang. Adjust the table feed rate and cutting depth a_p to suit machining conditions.
 ⑥ For strongly interrupted cutting, when unsupported length is long, or for wet cutting, JM4160 is recommended.
 ⑦ To prevent tool damage due to chip clogging, always use a chip removal method such as an air blower, etc.
 ⑧ Since there is a danger of the removed chips flying out and causing injury to workers, fire, or damage to eyes, during use be sure to cover the work area with a safety cover and have workers wear protective equipment such as glasses, etc. to make the work area safe.
 ⑨ Perform insert replacement at an early stage to prevent chipping due to excessive use.
 ⑩ Use of the MOLDINO anti-vibration arbor is recommended for overhang of 5DCX or more.
 ⑪ The following equation can be used to determine the metal removal rate per unit time Q ; $Q(\text{cm}^3/\text{min}) = a_p(\text{mm}) \times a_e(\text{mm}) \times Vf(\text{mm}/\text{min}) \div 1000$

Indexable Tools High Feed Radius End Mills

アルファ高送りラジアスマイル TR4F

○ プログラミング R と最大切込み深さ Programming R and maximum cutting depth

● 下記の表を参考に、CAM 上の工具形状を定義してください。

・ Please define the tool shape in the CAM as indicated in the following table:

使用インサート Insert	プログラミング R Programming R	削り残し量 (mm) Remains	最大切込み深さ (mm) Maximum cutting depth
SDNW120520TR(-P) SDMT120520TR	R3.0	1.0	1.2
SDNW150525ZTR SDMT150525ZTR	R3.0	1.47	2.0
	R4.0	1.32	

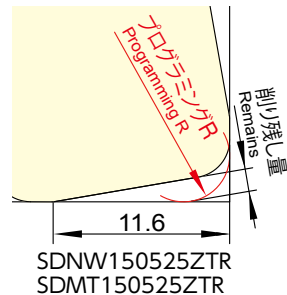
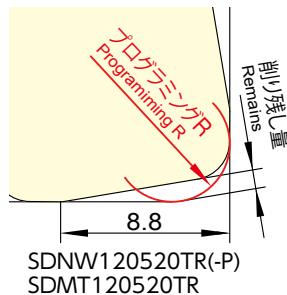

○ 最大傾斜角とヘリカル穴径 Maximum ramp angle and helical hole diameter

● 中心まで切れ刃がないため傾斜角度と穴径は制限されますが、下図に示すように傾斜切削やヘリカル切削にて、下穴がなくてもダイレクトに彫り込み加工が可能です。

・ Since the cutting flute do not extend to the center, there are limitations on the ramp angle and hole diameter, but as shown below, cutting by direct milling without a pilot hole is possible for ramping and helical milling.

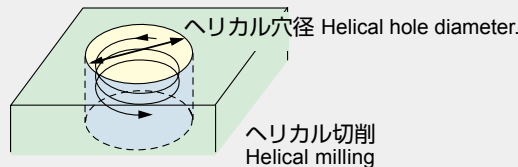
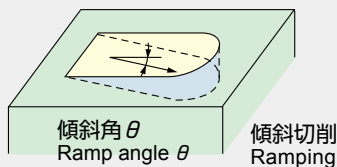

● 傾斜切削・ヘリカル切削の場合、テーブル送り量は標準切削条件の 50% 程度としてください。

・ For ramping and helical cutting, please set the "Vf" to around 50% of recommended cutting condition.

使用インサート Inserts		モジュラー / シャンクタイプ Modular/Shank Type		ボアタイプ Bore Type							
		SDNW120520TR(-P) SDMT120520TR				SDNW150525ZTR / SDMT150525ZTR					
工具径 (DCX) Tool dia. (mm)		φ 32	φ 40	φ 50	φ 63	φ 80	φ 100	φ 63	φ 80	φ 100	φ 125
傾斜切削 Ramping	最大傾斜角 (θ) Maximum ramp angle θ	1°	1.4°	2°	2°	1.5°	1°	3°	2°	1.5°	1°
	推奨設定値 Recommendation	1°						2°	1°		0.5°
ヘリカル切削 Helical milling	ヘリカル穴径 Helical hole diameter	46~60	62~76	82~96	108~122	142~156	182~196	102~121	136~155	176~195	226~245

[注意] ① 傾斜角 θ は上記範囲を超えないように設定して下さい。推奨設定値以下での使用を推奨いたします。

② 穴径が上記範囲以外の場合は下穴を開けて加工して下さい。

③ エアブロー（センタースルー）による、切りくず除去を十分行い、異常な振動が無いことを確認の上、加工することをお勧めいたします。

[Note] ① The ramp angle θ should be set within the ranges listed above. Do not exceed the recommended value.

② For hole diameters outside the ranges listed above, a pilot hole should be drilled before milling.

③ It is recommended that the tool be used while performing sufficient chip removal and checking that there are no abnormal vibrations.

○ コーナチェンジ時のお願い Attention for the corner change

● コーナチェンジを行う際には、インサートを反時計回りに回転させてください。

・ Turn the insert counterclockwise upon corner change.

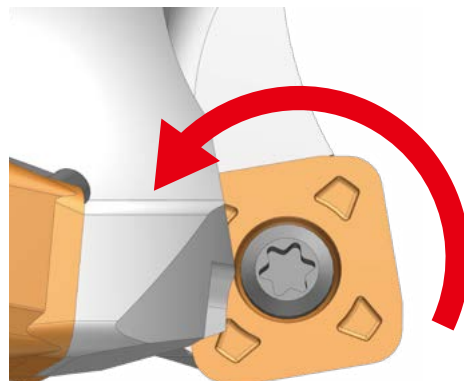

プリハードン鋼(40HRC)での寿命曲線 Tool life curve with pre-hardened steels (40 HRC)

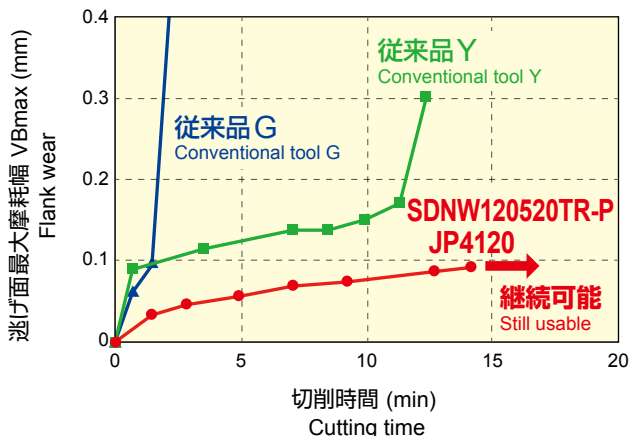

切削条件 Cutting conditions

被削材 Work material	プリハードン鋼 (40HRC) Pre-hardened steels (40HRC)
工具型番 Tool	TR4F4063BM-5
インサート型番 Insert model	SDNW120520TR-P : JP4120
切削速度 Cutting speed	$V_c = 140\text{m/min}$
1刃当りの送り量 Feed per tooth	$f_z = 2.0\text{mm/t}$
切込み量 Cutting depth	$a_p \times a_e = 1.0 \times 45\text{mm}$
突出し量 Overhang	200mm
エアブロー、単一刃切削 Air-blow Single flute cutting	

$f_z = 2.0\text{mm/t}$ の高送り加工において従来品を超える長寿命
Surpasses life of conventional tools for high-feed cutting at $f_z=2.0\text{mm/t}$.

焼入れ焼戻し鋼(52HRC)での寿命曲線 Tool life curve with quench-tempered steels (52 HRC)

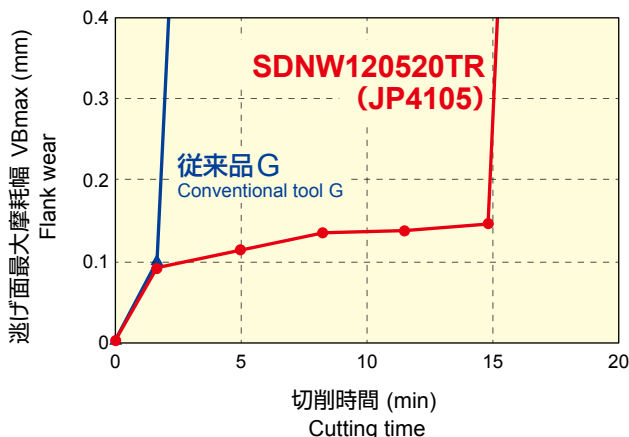

切削条件 Cutting conditions

被削材 Work material	焼入れ焼戻し鋼 (52HRC) Quench-tempered steels (52 HRC) ※SUS420J2相当材 *Equivalent to SUS420J2
工具型番 Tool	TR4F4063BM-5
インサート型番 Insert model	SDNW120520TR : JP4105
切削速度 Cutting speed	$V_c = 90\text{m/min}$
1刃当りの送り量 Feed per tooth	$f_z = 1.0\text{mm/t}$
切込み量 Cutting depth	$a_p \times a_e = 1.0 \times 35\text{mm}$
突出し量 Overhang	200mm
エアブロー、単一刃切削 Air-blow Single flute cutting	

高硬度材の高効率加工において従来品を超える長寿命
Surpasses life of conventional tools for more efficient cutting of high-hardness materials

切削抵抗比較 Comparison of cutting force

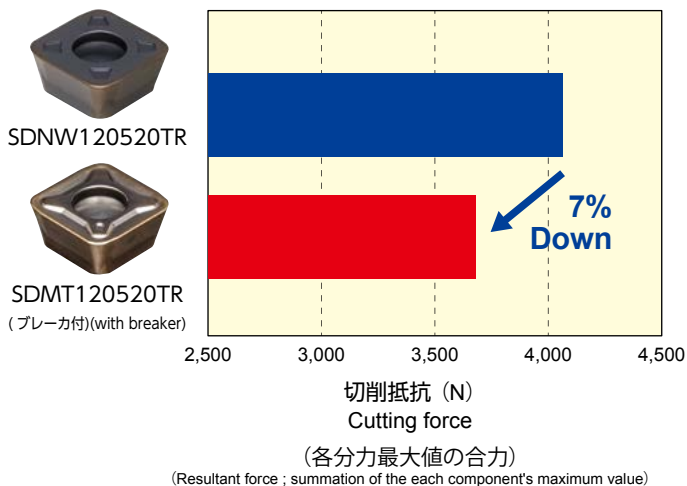

切削条件 Cutting conditions

被削材 Work material	プリハードン鋼 (32HRC) Pre-hardened steels (32HRC)
工具型番 Tool	TR4F4063BM-5
インサート型番 Insert model	SDNW120520TR : JP4120 SDMT120520TR : JP4120
切削速度 Cutting speed	$V_c = 150\text{m/min}$
1刃当りの送り量 Feed per tooth	$f_z = 1.5\text{mm/t}$
切込み量 Cutting depth	$a_p \times a_e = 1.0 \times 42\text{mm}$
突出し量 Overhang	200mm
エアブロー、単一刃切削 Air-blow Single flute cutting	



●独自のR状刃形が進化、更なる高能率加工を実現します。
 ・Unique R-shaped cutting edge has evolved to realize further high- efficiency machining.

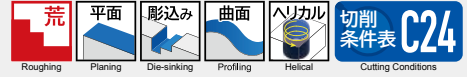

○は数字、□は英文字が入ります。Numeric figure in a circle ○ and Alphabetical character comes in a square □.

TD6N5○○○B□-○ ボアタイプ Bore type

ボアタイプ用アーバはD11頁を参照ください。
 Refer page D11 about the bore type arbor

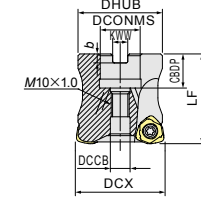

Fig.1 (エア穴付き)
With air hole

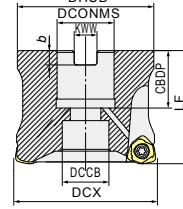

Fig.2 (エア穴付き)
With air hole

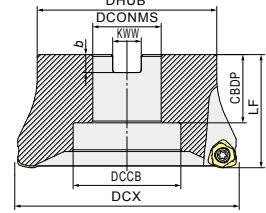

Fig.3 (エア穴無し)
Without air hole

タイプ Type	商品コード Item code	在庫 Stock	刃数 No. of flutes	寸法 Size (mm)								形状 Shape	適用インサート Recommended insert	希望小売価格(円) Suggested retail price (¥)								
				DCX	DHUB	LF	CBDP	KWW	b	DCONMS	DCCB											
ボアタイプ Bore type	TD6N5050B-3 ^{※1※2}	●	3	50	47	50	19	8.4	5	22.225	11	Fig.1	【高送りインサート】 High-feed type insert WOMU140620ER-FB WOMU140620ER-FC	56,190								
	TD6N5050B-4 ^{※1※2※3}	●	4											68,400								
	TD6N5063B-4	●	4											71,100								
	TD6N5063B-5	●	5	63	60	50	19	8.4	5	22.225	17	Fig.2		78,010								
	TD6N5080B-6	●	6											95,600								
	TD6N5100B-7	●	7	100	96	63	32	12.7	8	31.75	26	Fig.3		125,520								
	TD6N5125B-6	●	6	125	100									63	38	15.9	10	38.1	60	131,380		
	TD6N5125B-8	●	8	125	100									63	38	16.4	9	40	60	148,980		
	ボアタイプ Bore type	TD6N5050BM-3 ^{※1}	●	3	50	47	50	20	10.4	6.3	22	11		Fig.1	【高切込みインサート】 High depth type insert WOMU140630ER-HC	56,190						
		TD6N5050BM-4 ^{※1※3}	●	4												68,400						
		TD6N5063BM-4	●	4												71,100						
		TD6N5063BM-5	●	5	63	60	50	20	10.4	6.3	22	17		Fig.2		78,010						
		TD6N5080BM-6	●	6												95,600						
		TD6N5100BM-7	●	7	100	96	63	22	12.4	7	27	20		Fig.3		125,520						
		TD6N5125BM-6	●	6	125	100										63	38	16.4	9	40	60	131,380
		TD6N5125BM-8	●	8	125	100										63	38	16.4	9	40	60	148,980

※1: センタースルーをご使用の場合、アーバ側接続端面にクーラントの供給口を持つアーバをご使用ください。アーバーへの取付については、「φ50 ボディ取付説明」をご参照ください。
 ※2: 当社アーバ「BT50-22.225-○○○-50」との組み合わせではセンタースルーをご使用いただけません。
 ※3: ap=1mm以下でのご使用を推奨いたします。
 ※1: When using center through, please use Arbor with Coolant supply port. Regarding body installation to arbor, please check "How to install φ50 body" on next page.
 ※2: Center through can not be used when using TD6N in combination with our "BT50-22.225-○○○-50"
 ※3: Recommended to use with ap=1mm or less.

全てのボディに「高送り」「高切込み」インサートを装着することができます。 High-feed type and high depth type inserts can be set on all bodies.

インサート Inserts

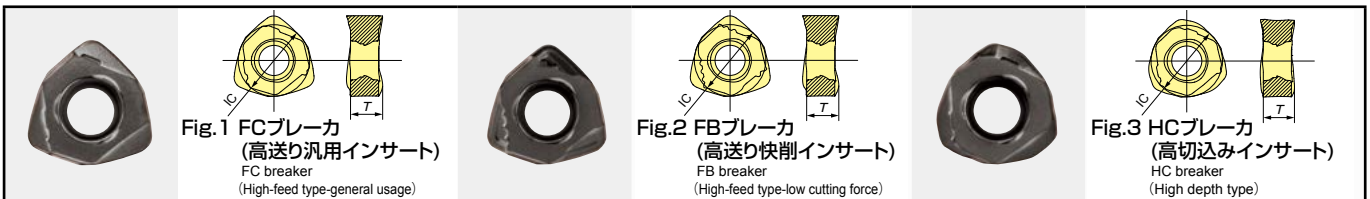

P 鋼 Carbon steels	M SUS等 SUS, etc.	K FC・FCD Cast irons	プリハードン鋼 Pre-hardened steels				炭素鋼・合金鋼・一般構造用鋼 Carbon steels・Alloy steels・Mild steels				■: 安定切削・第一推奨 Stable cutting・First Recommended	
			■	□	■	□	■	□	■	□	□	■
■	■	■	■	□	■	□	■	□	■	□	■	□
■	■	■	■	□	■	□	■	□	■	□	■	□
■	■	■	■	□	■	□	■	□	■	□	■	□

商品コード Item code	精度 Tolerance class	AJ コーティング AJ-Coating			JS コーティング JS-Coating		GX コーティング GX-Coating	寸法 Size (mm)		形状 Shape	希望小売価格(円) Suggested retail price (¥)
		JP4120	JM4160	JS4030	JS4060	GX2140	IC	T			
WOMU140620ER-FC	M級 M	●	●	●	●	●	14	-FC/-FB -HC	6.36 6.21	Fig.1	2,030
WOMU140620ER-FB		● ^{※1}	●	●	●	●				Fig.2	2,030
WOMU140630ER-HC		●	●	●	●	●				Fig.3	2,030

※1: 析出硬化系ステンレス鋼の加工にもご使用頂けます。 ※1: Can be used to process the precipitation hardening stainless steel. 析出硬化系=precipitation hardend

【注意】GX コーティング、JS コーティングは通電式タッチセンサーに反応しませんので、ご注意ください。

【Note】 Please note that the GX Coating and JS Coating do not cause a reaction in conductive touch sensors.

●印: 標準在庫品です。 ●: Stocked items.

コーティング材種使い分け MAP Matrix; insert grade selection

被削材別推奨材種マップ Recommended insert grade by work material

	被削材硬度 Work Hardness				被削材硬度 Work Hardness		被削材硬度 Work Hardness	
	低い Low			High 高い	低い Low	High 高い	低い Low	High 高い
不安定加工 Unstable machining								
一般構造用鋼 (200HB以下) Mild steels (200HB or less)	炭素鋼・合金鋼 (35HRC以下) Carbon steels, Alloy steels (30HRC or less)	炭素鋼・合金鋼 (35~45HRC) Carbon steels Alloy steels	焼入れ鋼 (45~50HRC) Hardened steels	ステンレス鋼系材料 SUS Stainless steel materials	鋳鉄 FC, FCD Cast irons			

部品番号 Parts

部品名 Parts	クランプねじ Clamp screw			アーバ用ねじ (双頭ねじ) Arbor screw (Double-headed screw)										
形状 Shape														
適用カッタ Cutter body	締付トルク (N・m) Fastening torque	希望小売価格 (円) Suggested retail price (¥)		a	a'	b	c	d	e	締付トルク (N・m) Fastening torque	希望小売価格 (円) Suggested retail price (¥)			
TD6N5050B □-○	555-141	4.9	690	W50-1031	M10 × 1.0	M10 × 1.5	31	14	12	5	9.0	2,090		
TD6N5063B □-○				-	-	-	-	-	-	-	-	-	-	
TD6N5080BM-6				-	-	-	-	-	-	-	-	-	-	-
TD6N5080B-6				-	-	-	-	-	-	-	-	-	-	-
TD6N5100B □-7				-	-	-	-	-	-	-	-	-	-	-
TD6N5125B □-○				-	-	-	-	-	-	-	-	-	-	-

部品名 Parts	アーバ用ねじ (エア穴付き) Arbor screw (With Air hole)							レンチ Wrench	ねじ焼き付き防止剤 Screw anti-seizure agent		
形状 Shape											
適用カッタ Cutter body	a	φb	c	d	f	希望小売価格 (円) Suggested retail price (¥)	希望小売価格 (円) Suggested retail price (¥)		希望小売価格 (円) Suggested retail price (¥)		
TD6N5050B □-○	-	-	-	-	-	-	-	105-T20	2,120	P-37	1,010
TD6N5063B □-○	100-178	M10 × 1.5	16	35	25	8	1,760				
TD6N5080BM-6	100-179	M12 × 1.75	18	42	30	10	1,760				
TD6N5080B-6	100-180	M16 × 2.0	24	51	35	14	1,760				
TD6N5100B □-7	-	-	-	-	-	-	-				
TD6N5125B □-○	-	-	-	-	-	-	-				

[注意] クランプねじは消耗品です。使用環境により交換寿命は変化しますので早めの交換をお願い致します。
[Note] The clamp screw is a consumable part. Since replacement life depends on the use environment, it is recommended that it be replaced at an early stage.

φ50ボディ取付説明 How to install φ50 body to arbor

● φ50ボディは、下記要領に従い、取り付けください。Please set φ50 body to Arbor as follows.



付属のアーバ用ねじをボディに止まる位置まで締め込んでください。
Tighten the Arbor-screw to the body until it stops.

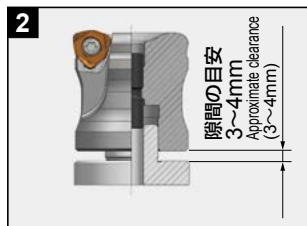

キー溝を合せボディをアーバに挿入し、ボディを手で押さえながらアーバ用ねじを締め込んでください。(締め込み開始時の隙間の目安は3~4mm程度です)
Align the key groove and insert the body into the arbor, and while holding the body with hand, tighten the arbor screw. (The indication of clearance at the start of tightening is about 3 to 4 mm)



アーバ用ねじが止まるまで強く締め込み、ボディがアーバと密着している事をご確認ください。
Firmly tighten the arbor screw until it stops and make sure that the body is in close contact with arbor.

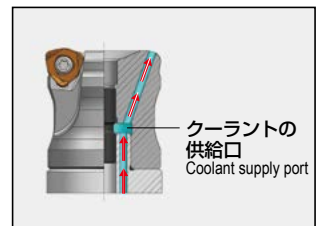

センタースルーをご使用する場合、アーバ側接続端面にクーラントの供給口を持つアーバをご使用ください。
When using a center through, use an arbor with coolant supply port on the arbor side connection end.

アルファ高送りラジアスマイル TD6N

標準切削条件表 Recommended cutting conditions

■ 高送りインサート For high-feed type insert (-FC/-FB) ※4 赤字は第1推奨材種です。 Red indicates primary recommended insert grade.

被削材 Work material	推奨材種 Recommended inserts grade	工具径 DCX Tool dia.	φ 50		φ 50		φ 63	
		刃数 flutes	3枚刃 flutes		4枚刃※1※2 flutes		4枚刃 flutes	
		突出し量 Overhang	~3DCX (150mm以下 or less)	3DCX~5DCX (150~250mm)	~3DCX (150mm以下 or less)	3DCX~5DCX (150~250mm)	~3DCX (200mm以下 or less)	3DCX~5DCX (200~300mm)
一般構造用鋼 Mild steels (200HB以下 or less)	GX2140 JS4060 JS4030 JM4160	n (min ⁻¹)	950	950	950	950	760	760
		Vc(m/min)	150	150	150	150	150	150
		Vf(mm/min)	4,300	4,300	5,700	5,700	4,550	4,550
		fz(mm/t)	1.5	1.5	1.5	1.5	1.5	1.5
		ap(mm)	1.5	1.0	1.0	1.0	1.5	1.0
		ae(mm) 形状加工 Shaping (ae/DCX) 平面加工 Face milling	35 (0.7DCX) ↑	35 (0.7DCX) ↑	35 (0.7DCX) ↑	35 (0.7DCX) ↑	45 (0.7DCX) ↑	45 (0.7DCX) ↑
		Q (cm³/min) ※形状加工※ Shaping	226	151	200	200	307	205
		炭素鋼・合金鋼 Carbon steels Alloy steels (35HRC以下 or less)	GX2140 JS4060 JS4030 JM4160	n (min ⁻¹)	760	760	760	760
Vc(m/min)	120			120	120	120	120	120
Vf(mm/min)	2,750			2,750	3,650	3,650	2,950	2,950
fz(mm/t)	1.2			1.2	1.2	1.2	1.2	1.2
ap(mm)	1.5			1.0	1.0	1.0	1.5	1.0
ae(mm) 形状加工 Shaping (ae/DCX) 平面加工 Face milling	35 (0.7DCX) ↑			35 (0.7DCX) ↑	35 (0.7DCX) ↑	35 (0.7DCX) ↑	45 (0.7DCX) ↑	45 (0.7DCX) ↑
Q (cm³/min) ※形状加工※ Shaping	144			96	128	128	199	133
プリハードン鋼 合金鋼 Pre-hardened steels Alloy steels (35~45HRC)	JP4120			n (min ⁻¹)	640	640	640	640
		Vc(m/min)	100	100	100	100	100	100
		Vf(mm/min)	1,920	1,920	2,560	2,560	2,040	2,040
		fz(mm/t)	1.0	1.0	1.0	1.0	1.0	1.0
		ap(mm)	1.2	0.8	0.8	0.8	1.2	0.8
		ae(mm) 形状加工 Shaping (ae/DCX) 平面加工 Face milling	35 (0.7DCX) ↑	35 (0.7DCX) ↑	35 (0.7DCX) ↑	35 (0.7DCX) ↑	45 (0.7DCX) ↑	45 (0.7DCX) ↑
		Q (cm³/min) ※形状加工※ Shaping	81	54	72	72	110	73
		ステンレス鋼 Stainless-steels (WET加工) (Wet cutting) SUS	JM4160	n (min ⁻¹)	640	640	640	640
Vc(m/min)	100			100	100	100	100	100
Vf(mm/min)	1,550			1,550	2,050	2,050	1,650	1,650
fz(mm/t)	0.8			0.8	0.8	0.8	0.8	0.8
ap(mm)	1.5			1.0	1.0	1.0	1.5	1.0
ae(mm) 形状加工 Shaping (ae/DCX) 平面加工 Face milling	35 (0.7DCX) ↑			35 (0.7DCX) ↑	35 (0.7DCX) ↑	35 (0.7DCX) ↑	45 (0.7DCX) ↑	45 (0.7DCX) ↑
Q (cm³/min) ※形状加工※ Shaping	81			54	72	72	111	74
鋳鉄 Cast irons FC FCD	JP4120 GX2140 JS4030			n (min ⁻¹)	950	950	950	950
		Vc(m/min)	150	150	150	150	150	150
		Vf(mm/min)	4,300	4,300	5,700	5,700	4,550	4,550
		fz(mm/t)	1.5	1.5	1.5	1.5	1.5	1.5
		ap(mm)	1.5	1.0	1.0	1.0	1.5	1.0
		ae(mm) 形状加工 Shaping (ae/DCX) 平面加工 Face milling	35 (0.7DCX) ↑	35 (0.7DCX) ↑	35 (0.7DCX) ↑	35 (0.7DCX) ↑	45 (0.7DCX) ↑	45 (0.7DCX) ↑
		Q (cm³/min) ※形状加工※ Shaping	226	151	200	200	307	205
		焼入れ鋼 Hardened steels (45~50HRC)	JP4120	n (min ⁻¹)	510	510	510	510
Vc(m/min)	80			80	80	80	80	80
Vf(mm/min)	1,200			1,200	1,650	1,650	1,300	1,300
fz(mm/t)	0.8			0.8	0.8	0.8	0.8	0.8
ap(mm)	1.0			0.7	0.7	0.7	1.0	0.7
ae(mm) 形状加工 Shaping (ae/DCX) 平面加工 Face milling	35 (0.7DCX) ↑			35 (0.7DCX) ↑	35 (0.7DCX) ↑	35 (0.7DCX) ↑	45 (0.7DCX) ↑	45 (0.7DCX) ↑
Q (cm³/min) ※形状加工※ Shaping	42			29	40	40	59	41

■ 高切込みインサート For high depth type insert (-HC) ※3 ※4 赤字は第1推奨材種です。 Red indicates primary recommended insert grade.

被削材 Work material	推奨材種 Recommended inserts grade	工具径 DCX Tool dia.	φ 50	φ 63	φ 80	φ 100	φ 125	φ 125
		刃数 flutes	3枚刃 flutes	4枚刃 flutes	6枚刃 flutes	7枚刃 flutes	6枚刃 flutes	8枚刃 flutes
		突出し量 Overhang	~3DCX (150mm以下 or less)	~3DCX (189mm以下 or less)	~3DCX (240mm以下 or less)	~3DCX (300mm以下 or less)	~3DCX (375mm以下 or less)	~3DCX (375mm以下 or less)
一般構造用鋼 Mild steels (200HB以下 or less)	GX2140 JS4060 JS4030 JM4160	n (min ⁻¹)	950	760	600	480	380	380
		Vc(m/min)	150	150	150	150	150	150
		Vf(mm/min)	2,300	2,450	2,900	2,700	1,800	2,450
		fz(mm/t)	0.8	0.8	0.8	0.8	0.8	0.8
		ap(mm)	3.0	3.0	3.0	3.0	3.0	3.0
		ae(mm) 形状加工 Shaping (ae/DCX) 平面加工 Face milling	35 (0.7DCX) ↑	45 (0.7DCX) ↑	50 (0.6DCX) 60 (0.75DCX)	50 (0.5DCX) 80 (0.8DCX)	50 (0.4DCX) 100 (0.8DCX)	50 (0.4DCX) 100 (0.8DCX)
		Q (cm³/min) ※形状加工※ Shaping	242	331	435	405	270	368
		鋳鉄 Cast irons FC FCD	JP4120 GX2140 JS4030	n (min ⁻¹)	950	760	600	480
Vc(m/min)	150			150	150	150	150	150
Vf(mm/min)	2,850			3,050	3,600	3,350	2,300	3,050
fz(mm/t)	1.0			1.0	1.0	1.0	1.0	1.0
ap(mm)	3.0			3.0	3.0	3.0	3.0	3.0
ae(mm) 形状加工 Shaping (ae/DCX) 平面加工 Face milling	35 (0.7DCX) ↑			45 (0.7DCX) ↑	50 (0.6DCX) 60 (0.75DCX)	50 (0.5DCX) 80 (0.8DCX)	50 (0.4DCX) 100 (0.8DCX)	50 (0.4DCX) 100 (0.8DCX)
Q (cm³/min) ※形状加工※ Shaping	299			412	540	503	345	458

φ 63		φ 80		φ 100		φ 125		φ 125		被削材 Work material
5枚刃※1 flutes		6枚刃 flutes		7枚刃 flutes		6枚刃 flutes		8枚刃 flutes		
~3DCX (200mm以下 or less)	3DCX~5DCX (200~300mm)	~3DCX (240mm以下 or less)	3DCX~5DCX (240~400mm)	~3DCX (300mm以下 or less)	3DCX~5DCX (300~500mm)	~3DCX (400mm以下 or less)	3DCX~5DCX (400~600mm)	~3DCX (400mm以下 or less)		
760	760	600	600	480	480	380	380	380		一般構造用鋼 Mild steels (200HB以下 or less)
150	150	150	150	150	150	150	150	150		
5,700	5,700	5,400	5,400	5,050	5,050	3,400	3,400	4,550		
1.5	1.5	1.5	1.5	1.5	1.5	1.5	1.5	1.5		
1.5	1.0	1.5	1.0	1.5	1.0	1.5	1.0	1.5		
45 (0.7DCX)	45 (0.7DCX)	50 (0.6DCX)	50 (0.6DCX)	50 (0.5DCX)	50 (0.5DCX)	50 (0.4DCX)	50 (0.4DCX)	50 (0.4DCX)		炭素鋼・合金鋼 Carbon steels Alloy steels (35HRC以下 or less)
↑	↑	60 (0.75DCX)	60 (0.75DCX)	80 (0.8DCX)	80 (0.8DCX)	100 (0.8DCX)	100 (0.8DCX)	100 (0.8DCX)		
385	257	405	270	379	253	255	170	341		
610	610	480	480	380	380	310	310	310		
120	120	120	120	120	120	120	120	120		
3,650	3,650	3,450	3,450	3,200	3,200	2,250	2,250	3,000		プリハードン鋼 合金鋼 Pre-hardened steels Alloy steels (35~45HRC)
1.2	1.2	1.2	1.2	1.2	1.2	1.2	1.2	1.2		
1.5	1.0	1.5	1.0	1.5	1.0	1.5	1.0	1.5		
45 (0.7DCX)	45 (0.7DCX)	50 (0.6DCX)	50 (0.6DCX)	50 (0.5DCX)	50 (0.5DCX)	50 (0.4DCX)	50 (0.4DCX)	50 (0.4DCX)		
↑	↑	60 (0.75DCX)	60 (0.75DCX)	80 (0.8DCX)	80 (0.8DCX)	100 (0.8DCX)	100 (0.8DCX)	100 (0.8DCX)		
246	164	259	173	240	160	169	113	225		ステンレス鋼 Stainless steels (WET加工) (Wet cutting) SUS
510	510	400	400	320	320	250	250	250		
100	100	100	100	100	100	100	100	100		
2,550	2,550	2,400	2,400	2,240	2,240	1,500	1,500	2,000		
1.0	1.0	1.0	1.0	1.0	1.0	1.0	1.0	1.0		
1.2	0.8	1.2	0.8	1.2	0.8	1.2	0.8	1.2		鋳鉄 Cast irons FC FCD
45 (0.7DCX)	45 (0.7DCX)	50 (0.6DCX)	50 (0.6DCX)	50 (0.5DCX)	50 (0.5DCX)	50 (0.4DCX)	50 (0.4DCX)	50 (0.4DCX)		
↑	↑	60 (0.75DCX)	60 (0.75DCX)	80 (0.8DCX)	80 (0.8DCX)	100 (0.8DCX)	100 (0.8DCX)	100 (0.8DCX)		
138	92	144	96	134	90	90	60	120		
510	510	400	400	320	320	250	250	250		
100	100	100	100	100	100	100	100	100		焼入れ鋼 Hardened steels (45~50HRC)
2,050	2,050	1,900	1,900	1,800	1,800	1,200	1,200	1,600		
0.8	0.8	0.8	0.8	0.8	0.8	0.8	0.8	0.8		
1.5	1.0	1.5	1.0	1.5	1.0	1.5	1.0	1.5		
45 (0.7DCX)	45 (0.7DCX)	50 (0.6DCX)	50 (0.6DCX)	50 (0.5DCX)	50 (0.5DCX)	50 (0.4DCX)	50 (0.4DCX)	50 (0.4DCX)		
↑	↑	60 (0.75DCX)	60 (0.75DCX)	80 (0.8DCX)	80 (0.8DCX)	100 (0.8DCX)	100 (0.8DCX)	100 (0.8DCX)		
385	257	405	270	379	253	255	170	341		
400	400	320	320	250	250	200	200	200		
80	80	80	80	80	80	80	80	80		
1,600	1,600	1,550	1,550	1,400	1,400	950	950	1,300		
0.8	0.8	0.8	0.8	0.8	0.8	0.8	0.8	0.8		
1.0	0.7	1.0	0.7	1.0	0.7	1.0	0.7	1.0		
45 (0.7DCX)	45 (0.7DCX)	50 (0.6DCX)	50 (0.6DCX)	50 (0.5DCX)	50 (0.5DCX)	50 (0.4DCX)	50 (0.4DCX)	50 (0.4DCX)		
↑	↑	60 (0.75DCX)	60 (0.75DCX)	80 (0.8DCX)	80 (0.8DCX)	100 (0.8DCX)	100 (0.8DCX)	100 (0.8DCX)		
72	50	78	54	70	49	48	33	65		

- ※ 1 高切込みインサート (HC プレーカ) との組み合わせは推奨いたしません。 ※ 1 : Not recommended combination with high depth type insert (HC).
- ※ 2 φ 50-4 枚刃については、 $a_p=1\text{mm}$ 以下での使用を推奨いたします。 ※ 2 : Regarding φ50-4flutes, recommended to use with $a_p = 1\text{mm}$ or less.
- ※ 3 高切込みインサートは $L/D=3$ 以下での使用を推奨いたします。 ※ 3 : Regarding high depth type insert recommended to use $L / D = 3$ or less.
- ※ 4 高送りインサート (FC/FB) と高切込みインサート (HC) を同時に装着して使用する ※ 4 : Impossible to use with the high-feed type insert (FC / FB) and the high depth type insert (HC) installed at the same time.

【注意】

- ① 本表は肩削り時の一般的な切削条件です。機械剛性やツール、加工物の状態に合わせて調整してください。
特に、溝切削の伴う、またはそれに近い切り込み幅の加工などで、切りくずの噛み込みやびびり振動が発生し、トラブルに至る場合がありますので下記を参考に調整してください。
・回転数、テーブル送り量を 50~70% 下げる。
・切り込み深さ a_p を 50~70% 下げる。
・切り込み幅 a_e を 50~70% 下げる。
- ② GXコーティング、JSコーティングは、通電式タッチセンサーに反応しませんのでご注意ください。
- ③ 強断続切削、突出しが長い場合及び湿式切削には「JM4160」をご推奨します。
- ④ 切りくず噛み込みによる工具損傷防止のため、必ずエアブロー等による切りくず除去を行ってください。
- ⑤ 排出した切りくずは、飛散し作業者を切傷させ、火傷あるいは目に入って負傷させる恐れがありますので、ご使用に際してはその周囲に安全カバーを取付け、保護メガネ等の保護具を着用し、安全な環境で作業されることをお願い致します。
- ⑥ インサートの交換は早めに行い、過度の破損を防止してください。
- ⑦ 下記に単位時間当たりの切りくず排出量 Q を示します。
 $Q(\text{cm}^3/\text{min})=a_p(\text{mm}) \times a_e(\text{mm}) \times Vf(\text{mm}/\text{min}) / 1000$

【Note】

- ① These conditions are for general guidance for shoulder milling; in actual machining conditions adjust the parameters according to your actual machine and work-piece conditions. In particular, when performing shoulder milling in combination with slotting or machining of cutting widths close to slots, etc., chattering vibrations may occur, which can lead to trouble. Therefore, please consider the following when adjusting the conditions:
・ Reduce rotation speed and table feed rate by 50 to 70%
・ Reduce cutting depth a_p by 50 to 70%
・ Reduce cutting width a_e by 50 to 70%
- ② GX Coating and JS Coating could not be used with conductive touch sensors.
- ③ For strongly interrupted cutting, when unsupported length is long, or for wet cutting, JM4160 is recommended.
- ④ To prevent tool damage due to chip clogging, always use a chip removal method such as an air blower, etc.
- ⑤ Since there is a danger of the removed chips flying out and causing injury to workers, fire, or damage to eyes, during use be sure to cover the work area with a safety cover and have workers wear protective equipment such as glasses, etc. to make the work area safe.
- ⑥ Perform insert replacement at an early stage to prevent chipping due to excessive use.
- ⑦ The following equation can be used to determine the metal removal rate per unit time Q ;
 $Q(\text{cm}^3/\text{min})=a_p(\text{mm}) \times a_e(\text{mm}) \times Vf(\text{mm}/\text{min}) / 1000$

アルファ高送りラジアスミル TD6N

○ 傾斜切削とヘリカル切削について Regarding ramping and helical milling

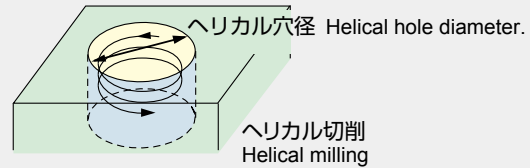
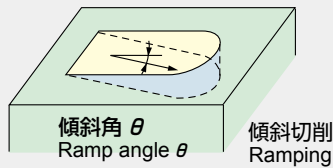

加工内容 Process	使用インサート Insert	設定値 Parameter	工具径 DCX Tool dia. (mm)				
			φ 50	φ 63	φ 80	φ 100	φ 125
傾斜切削 Ramping	【高送りインサート】 High-feed type insert WOMU140620ER-FC WOMU140620ER-FB	最大傾斜角 (θ) Maximum ramp angle θ	2.6°	1.8°	1.2°	0.9°	0.7°
		推奨設定値 ^{*1} Recommendation	1°			0.5°	
	【高切込みインサート】 High depth type insert WOMU140630ER-HC	最大傾斜角 (θ) Maximum ramp angle θ	2.2°	1.5°	1.1°	0.8°	0.6°
		推奨設定値 ^{*1} Recommendation	1°		0.5°		0.4°
ヘリカル切削 Helical milling	【高送りインサート】 High-feed type insert WOMU140620ER-FC WOMU140620ER-FB 【高切込みインサート】 High depth type insert WOMU140630ER-HC	穴径 Hole diameter	φ84~98	φ110~124	φ144~158	φ184~198	φ234~248
		ヘリカルピッチ ^{*2} (mm) Helical pitch	0.5~1.5				

【注意】エアブロー（センタースルー）による、切り屑除去を十分行い、異常な振動が無いことを確認の上、加工することをお勧めいたします。

【Note】It is recommended that the tool be used while performing sufficient chip removal and checking that there are no abnormal vibrations.

※ 1：傾斜角 (θ) は最大傾斜角を超えないように設定してください。推奨設定値以下でのご使用を推奨いたします。

※ 2：ヘリカル切削の場合、テーブル送り量は標準切削条件の 50% 程度としてください。

※ 1：Please set the ramp angle within the "maximum ramp angle θ" on the table above. Recommend using below the recommended value.

※ 2：For helical cutting, please set the table feed rate to around 50% of recommended cutting condition.

○ CAMにおけるプログラミングRの定義について About define the programming R on the CAM

下記の表を参考に、CAM上の工具形状を定義してください。
Please define the tool shape on the CAM with reference as below table.

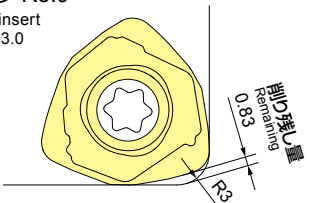
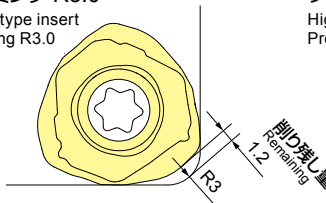
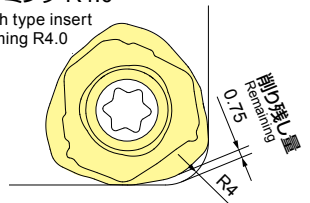
【高送りインサート】 High-feed type insert WOMU140620ER-FC WOMU140620ER-FB		【高切込みインサート】 High depth type insert WOMU140630ER-HC			
プログラミング R Programming R	R3.0	プログラミング R Programming R	R3.0	R4.0	
削り残し量 (mm) Remains	0.83	削り残し量 (mm) Remains	1.2	0.75	
高送りインサート プログラミング R3.0 High-feed type insert Programming R3.0		高切込みインサート プログラミング R3.0 High depth type insert Programming R3.0		高切込みインサート プログラミング R4.0 High depth type insert Programming R4.0	

○ ポケット加工での壁面の段差量について Correlation table of ap and steps when standing wall cutting

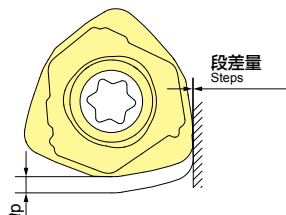
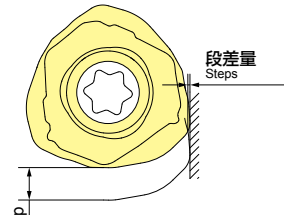
【高送りインサート】 High-feed type insert WOMU140620ER-FC WOMU140620ER-FB			【高切込みインサート】 High depth type insert WOMU140630ER-HC		
	ap (mm)	段差量 (mm) Steps(mm)		ap (mm)	段差量 (mm) Steps(mm)
	0.5	0.01		1.0	0.04
	1.0	0.03		2.0	0.10
	1.5	0.05		3.0	0.20

○ 切削性能 Cutting performance

炭素鋼 (S50C、220HB) での寿命曲線 Tool life on carbon steels (220HB).

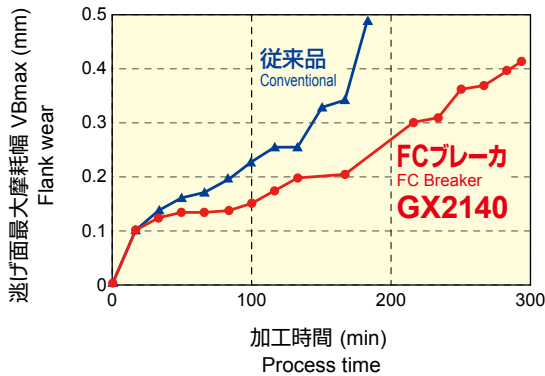

切削条件 Cutting Conditions

被削材 Work Material	炭素鋼 S50C(220HB)
工具型番 Tool	TD6N5063B-5
インサート型番 Insert Model	WOMU140620ER-FC ; GX2140
切削速度 Cutting Speed	$v_c = 120\text{m/min}$
1刃当りの送り量 Speed per flute	$f_z = 1.5\text{mm/t}$
切込み量 Cutting depth	$a_p \times a_e = 1.0 \times 45\text{mm}$
突出し量 Overhang	200mm
エアブロー、単一刃切削 Air-blow Single edge cutting	

合金鋼 (SKD61、45HRC) での寿命曲線 Tool life on alloy steels (SKD61, 45HRC).

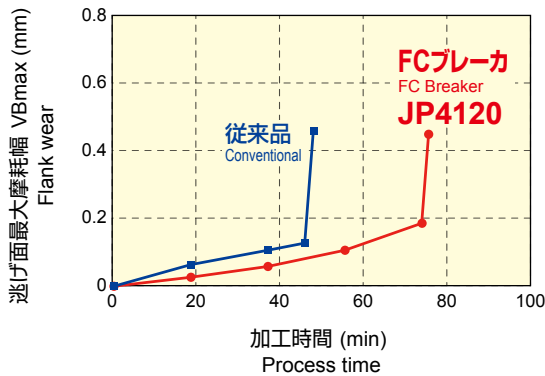

切削条件 Cutting Conditions

被削材 Work Material	合金鋼 SKD61(45HRC)
工具型番 Tool	TD6N5063B-5
インサート型番 Insert Model	WOMU140620ER-FC ; JP4120
切削速度 Cutting Speed	$v_c = 100\text{m/min}$
1刃当りの速度 Speed per flute	$f_z = 0.8\text{mm/t}$
切込み量 Cutting depth	$a_p \times a_e = 1.0 \times 40\text{mm}$
突出し量 Overhang	200mm
エアブロー、単一刃切削 Air-blow Single edge cutting	



- 「高能率」「低抵抗」「経済的4コーナ仕様」に加え、高送り工具の常識とされていた「削り残し」を削減!! 次工程の負担を軽減します。
- ・ High efficiency, low cutting force, and economical 4-corner specification leaves less of the uncut remnants. Reduces the load on the next process.

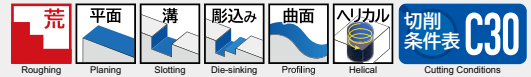

TD4N20○○□(32)-○ シャンクタイプ Shank type

○は数字、□は英文字が入ります。
Numeric figure in a circle ○ and Alphabetical character comes in a square □.

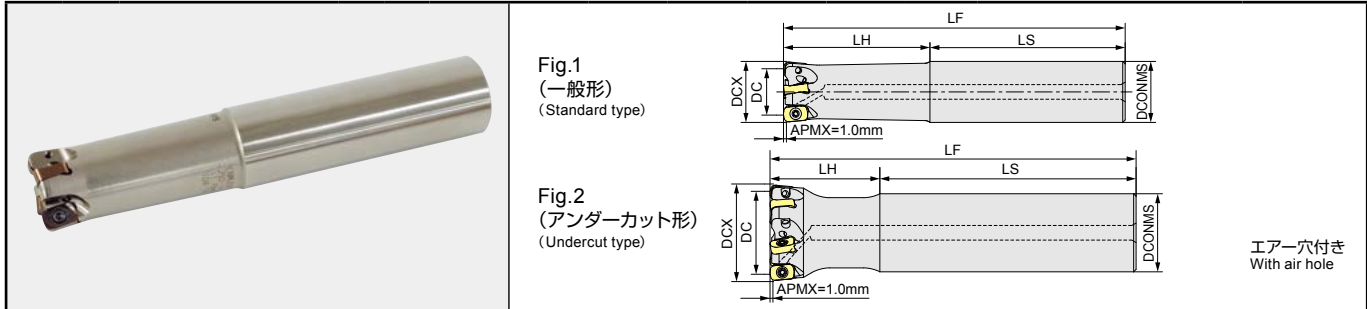

タイプ Type	商品コード Item code	在庫 Stock	刃数 No. of flutes	寸法 Size (mm)						形状 Shape	適用インサート Recommended insert	希望小売価格(円) Suggested retail price (¥)
				DCX	DC	LF	LH	LS	DCONMS			
Shank type レギュラー Long	TD4N2016S-2	●	2	16	10	100	30	70	16	Fig.1	ENMU0603ER-B/C ENGU0603ER-C	36,950
	TD4N2020S-3	●	3	20	14	130	50	80	20			47,640
	TD4N2025S-4	●	4	25	19	140	60	80	25			57,480
	TD4N2032S-5	●	5	32	26	150	70	80	32			68,400
	TD4N2040S32-6	●	6	40	34	150	45	105	32			78,720
	TD4N2016L-2	●	2	16	10	150	50	100	16	Fig.1		42,120
	TD4N2018L-2	●	2	18	12	150	25	125	16	Fig.2		36,950
	TD4N2020L-3	●	3	20	14	160	80	80	20	Fig.1		54,200
	TD4N2022L-3	●	3	22	16	160	30	130	20	Fig.2		47,640
	TD4N2025L-4	●	4	25	19	180	100	80	25	Fig.1		60,660
	TD4N2028L-4	●	4	28	22	180	35	145	25	Fig.2		57,480
	TD4N2032L-5	●	5	32	26	200	120	80	32	Fig.1		70,860
	TD4N2035L-5	●	5	35	29	200	40	160	32	Fig.2		71,800
	TD4N2040L32-6	●	6	40	34	220	45	175	32	Fig.2		82,590

○は数字が入ります。Numeric figure comes in a circle ○.

TD4N20○○M-○ モジュラータイプ Modular type

モジュラーミル用シャンクはD2頁を、締め付けトルクについてはD5頁を参照ください。
Refer page D2 about the shanks for Modular Mill, Refer page D5 about tightening torque

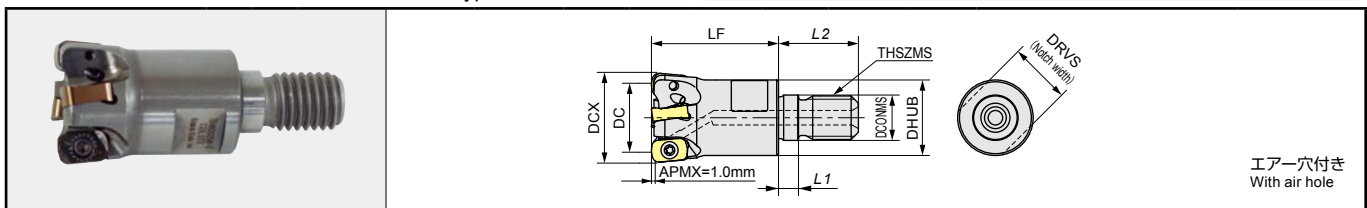

商品コード Item code	在庫 Stock	刃数 No. of flutes	寸法 Size (mm)									適用インサート Recommended insert	希望小売価格(円) Suggested retail price (¥)
			DCX	DC	LF	L1	L2	DCONMS	DHUB	THSZMS	DRVS		
TD4N2016M-2	●	2	16	10	25	5.5	17	8.5	12.8	M8	10	ENMU0603ER-B/C ENGU0603ER-C	36,950
※TD4N2018M-2	●	2	18	12	25	5.5	17	8.5	12.8	M8	10		36,950
TD4N2020M-3	●	3	20	14	30	5.5	19	10.5	17.8	M10	15		47,640
※TD4N2022M-3	●	3	22	16	30	5.5	19	10.5	17.8	M10	15		47,640
TD4N2025M-4	●	4	25	19	35	5.5	22	12.5	20.8	M12	17		57,480
※TD4N2028M-4	●	4	28	22	35	5.5	22	12.5	20.8	M12	17		57,480
TD4N2032M-5	●	5	32	26	40	6	23	17	28.8	M16	22		68,400
※TD4N2035M-5	●	5	35	29	40	6	23	17	28.8	M16	22		71,800
※TD4N2040M-6	●	6	40	34	40	6	23	17	28.8	M16	22		78,720
※TD4N2042M-6	●	6	42	36	40	6	23	17	28.8	M16	22		82,700

【注意】※と超硬シャンクをセットで使用すると干渉がありません。
モジュラーミル専用シャンク/アーバとの接続端面及びねじ部に潤滑剤は塗布しないでください。

【Note】 When ※ and carbide shank are used together as a set, there is no interference.
Do not apply lubricants to the threaded section or end surface sections in contact with the dedicated shank/arbor for modular mills.

●印：標準在庫品です。 ●：Stocked items. 無印：弊社営業へお問合せください。 No mark：Contact with our sales department.

アルファ高送りラジアスミル TD4N

標準切削条件表 Recommended cutting conditions

*赤字は第1推奨材種です。 * Red indicates primary recommended insert grade.

被削材 Work material	推奨材種 Recommended inserts grade	工具径 DCX Tool dia.	φ16(2枚刃 flutes)		φ20(3枚刃 flutes)		φ25(4枚刃 flutes)		φ32(5枚刃 flutes)		φ40(6枚刃 flutes)	
			突出し量 Overhang	~3DCX	4DCX~7DCX	~3DCX	4DCX~7DCX	~3DCX	4DCX~7DCX	~3DCX	4DCX~7DCX	~3DCX
炭素鋼・合金鋼 Carbon steels Alloy steels <30HRC	※ GX2140 JS4045	<i>n</i> (min ⁻¹)	3380	2990	2710	2390	2170	1910	1690	1490	1350	1190
		Vc(m/min)	170	150	170	150	170	150	170	150	170	150
		Vf(mm/min)	6760	4780	8130	5730	10410	9160	10140	8940	9720	8560
		fz(mm/t)	1	0.8	1	0.8	1.2	1.2	1.2	1.2	1.2	1.2
		ap(mm)	0.6	0.6	0.6	0.6	0.6	0.6	0.5	0.5	0.5	0.5
		ae(mm)	10	10	14	14	19	19	22	22	22	28
		Q (cm ³ /min)	41	29	68	48	158	104	112	98	136	160
		Q (cm ³ /min)	2990	2590	2390	2070	1910	1660	1490	1290	1190	1040
合金鋼・工具鋼 Alloy steels Tool steels 30 ~ 40HRC	JP4120 JS4045	<i>n</i> (min ⁻¹)	150	130	150	130	150	130	150	130	150	130
		Vc(m/min)	5980	4140	7170	4960	7640	6640	7450	6450	7140	6240
		Vf(mm/min)	1	0.8	1	0.8	1	1	1	1	1	1
		fz(mm/t)	0.6	0.6	0.6	0.6	0.6	0.5	0.5	0.5	0.5	0.5
		ap(mm)	10	10	14	14	19	19	22	22	22	28
		ae(mm)	36	25	60	42	116	76	82	71	100	87
		Q (cm ³ /min)	1990	1790	1590	1430	1270	1150	1000	900	800	720
		Q (cm ³ /min)	100	90	100	90	100	90	100	90	100	90
プリハードン鋼 合金鋼 Pre-Hardened steels Alloy steels 40 ~ 50HRC	JP4120 JS4045	<i>n</i> (min ⁻¹)	3980	2860	4770	3430	5080	3680	5000	3600	4800	3450
		Vc(m/min)	1	0.8	1	0.8	1	0.8	1	0.8	1	0.8
		Vf(mm/min)	0.6	0.5	0.6	0.5	0.6	0.5	0.5	0.5	0.5	0.5
		fz(mm/t)	10	10	14	14	19	19	22	22	22	28
		ap(mm)	24	14	40	24	58	35	55	40	67	48
		ae(mm)	1990	1790	1590	1430	1270	1150	1000	900	800	720
		Q (cm ³ /min)	100	90	100	90	100	90	100	90	100	90
		Q (cm ³ /min)	3980	2860	4770	3430	5080	3680	5000	3600	4800	3450
ステンレス鋼 Stainless steels SUS	JM4160	<i>n</i> (min ⁻¹)	1	0.8	1	0.8	1	0.8	1	0.8	1	0.8
		Vc(m/min)	3980	2860	4770	3430	5080	3680	5000	3600	4800	3450
		Vf(mm/min)	1	0.8	1	0.8	1	0.8	1	0.8	1	0.8
		fz(mm/t)	0.6	0.5	0.6	0.5	0.6	0.5	0.5	0.5	0.5	0.5
		ap(mm)	10	10	14	14	19	19	22	22	22	28
		ae(mm)	24	14	40	24	58	35	55	40	67	48
		Q (cm ³ /min)	1990	1790	1590	1430	1270	1150	1000	900	800	720
		Q (cm ³ /min)	100	90	100	90	100	90	100	90	100	90
鋳鉄 Cast irons FC FCD	JP4120 GX2140	<i>n</i> (min ⁻¹)	3980	3580	3180	2870	2550	2290	1990	1790	1590	1430
		Vc(m/min)	200	180	200	180	200	180	200	180	200	180
		Vf(mm/min)	9550	7160	11440	8610	12240	9160	11940	8950	11440	8580
		fz(mm/t)	1.2	1	1.2	1	1.2	1	1.2	1	1.2	1
		ap(mm)	0.8	0.6	0.8	0.6	0.8	0.6	0.8	0.6	0.8	0.6
		ae(mm)	10	10	14	14	19	19	22	22	22	28
		Q (cm ³ /min)	76	43	128	72	186	104	210	118	256	144
		Q (cm ³ /min)	1590	1390	1270	1110	1020	890	800	700	640	560
焼入れ鋼 High-hardened steels 50 ~ 55HRC	JP4105 JP4120	<i>n</i> (min ⁻¹)	80	70	80	70	80	70	80	70	80	70
		Vc(m/min)	1270	890	1530	1070	1630	1140	1590	1110	1530	1070
		Vf(mm/min)	0.4	0.32	0.4	0.32	0.4	0.32	0.4	0.32	0.4	0.32
		fz(mm/t)	0.3	0.2	0.3	0.2	0.3	0.2	0.3	0.2	0.3	0.2
		ap(mm)	10	10	14	14	19	19	24	24	30	30
		ae(mm)	4	2	6	3	9	5	11	6	14	7
		Q (cm ³ /min)	1190	1190	950	950	760	760	600	600	480	480
		Q (cm ³ /min)	60	60	60	60	60	60	60	60	60	60
焼入れ鋼 High-hardened steels 55 ~ 62HRC	JP4105	<i>n</i> (min ⁻¹)	~ 720	~ 570	~ 860	~ 690	~ 920	~ 730	~ 900	~ 720	~ 860	~ 690
		Vc(m/min)	~ 0.3	~ 0.24	~ 0.3	~ 0.24	~ 0.3	~ 0.24	~ 0.3	~ 0.24	~ 0.3	~ 0.24
		Vf(mm/min)	~ 0.3	~ 0.15	~ 0.3	~ 0.15	~ 0.3	~ 0.15	~ 0.3	~ 0.15	~ 0.3	~ 0.15
		fz(mm/t)	55~57HRC	~ 0.2	~ 0.1	~ 0.2	~ 0.1	~ 0.2	~ 0.1	~ 0.2	~ 0.1	~ 0.2
		ap(mm)	58~62HRC	10	10	14	14	19	19	24	24	30
		ae(mm)	~ 2	~ 1	~ 4	~ 2	~ 5	~ 3	~ 6	~ 4	~ 8	~ 4
		Q (cm ³ /min)	~ 2	~ 1	~ 4	~ 2	~ 5	~ 3	~ 6	~ 4	~ 8	~ 4
		Q (cm ³ /min)	~ 2	~ 1	~ 4	~ 2	~ 5	~ 3	~ 6	~ 4	~ 8	~ 4

- 【注意】**
- 被削材、加工形状に合わせて、適切なクーラントを使用してください。
 - この切削条件表は肩削り時における切削条件の目安を示すものです。実際の加工では加工形状、目的、使用機械等により条件を調整してください。特に、溝切削を伴う、またはそれに近い加工などで切りくず排出や振動が問題となる際には下記を参考に切削条件を調整してください。
 - 切り込み深さ ap を 50 ~ 70% に下げる。
 - 回転数 n とテーブル送り量 Vf を 50 ~ 70% に下げる。
 - GXコーティング、JSコーティングは通電式タッチセンサーに反応しませんのでご注意ください。
 - 「JP4105」は高硬度鋼専用材種で、生材には適しません。
 - 焼入れ鋼(55~62HRC)は、鋼種や工具突き出し量によって被削性が大きく異なる場合があります。加工状況に合わせて、テーブル送り量と切り込み深さ ap を調整してください。
 - 強断続切削、突出しが長い場合及び湿式切削には「JM4160」を推奨します。
 - GX2140 は乾式切削で使用してください。
 - 切りくず噛み込みによる工具損傷防止のため、必ずエアブロー等による切りくず除去を行ってください。
 - インサートの交換は早めに行い、過度の使用による破損を防止してください。
 - 下記に単位時間当たりの切りくず排出量 Q を示します。
 $Q(\text{cm}^3/\text{min}) = \text{ap}(\text{mm}) \times \text{ae}(\text{mm}) \times \text{Vf}(\text{mm}/\text{min}) / 1000$
- 【Note】**
- Use the appropriate coolant for the work material and machining shape.
 - Conditions are for general guidance on shoulder face milling. In actual machining conditions please adjust the parameters according to your actual machine and work-piece conditions. Especially when the chip discharge or vibration is a problem in slotting or near machining, please adjust the cutting conditions as follows.
 - Reduce depth of cut(ap) to 50 to 70%.
 - Reduce number of revolution(n) and feed rate(vf) to 50 to 70%.
 - Please note that the GX Coating and JS Coating do not cause a reaction in conductive touch sensors.
 - JP4105 is for the high-hardness steels. It is not suitable for Non-heat-treated steel material.
 - The machinability of hardened steels (55 - 62HRC) can vary significantly depending on the particular steel type and tool overhang. Adjust the table feed rate and cutting depth ap to suit machining conditions.
 - For strongly interrupted cutting, when unsupported length is long, or for wet cutting, JM4160 is recommended.
 - GX2140 should be used for dry cutting.
 - To prevent tool damage due to chip clogging, always use a chip removal method such as an air blower, etc.
 - Ensure to exchange the insert at the correct time to ensure safety of the tool-body.
 - The following equation can be used to determine the metal removal rate per unit time Q:
 $Q(\text{cm}^3/\text{min}) = \text{ap}(\text{mm}) \times \text{ae}(\text{mm}) \times \text{Vf}(\text{mm}/\text{min}) / 1000$

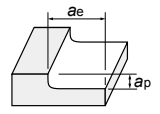

傾斜切削とヘリカル加工径について Regarding ramping and helical milling diameter

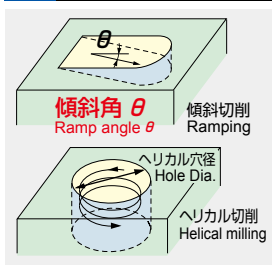

工具径 DCX Tool dia.	φ 16	φ 18	φ 20	φ 22	φ 25	φ 28	φ 32	φ 35	φ 40	φ 42	(mm)
最大傾斜角 θ Maximum ramp angle θ	0.8	0.8	0.8	0.8	0.8	0.6	0.5	0.5	0.3	0.3	
ヘリカル穴径 Hole Dia.	24 ~ 30	28 ~ 34	32 ~ 38	36 ~ 42	42 ~ 48	48 ~ 54	56 ~ 62	62 ~ 68	72 ~ 78	76 ~ 82	

- 1周あたりの切り込み深さは ap = 1mm 以下としてください。 Cutting depth per rotation should be set to ap = 1 mm or less.
- 【注意】**
- 十分な切りくず排除を行い、異常な振動がないことを確認のうえ、使用することをお勧め致します。
 - 傾斜角 θ は上記範囲を超えない様に設定してください。0.5° 以下での使用を推奨します。
 - 穴径が上記範囲外の場合は下穴をあけて加工してください。
- 【Note】**
- It is recommended that the tool be used while performing sufficient chip removal and checking that there are no abnormal vibrations.
 - The ramp angle θ should be set within the ranges listed above. Use at ramp angles of 0.5° or less is recommended.
 - For hole diameters outside the ranges listed above, a pilot hole should be drilled before milling.

加工プログラム作成上の注意点 Points requiring care when creating the machining program

- CAMではR2.0のラジウス形状として工具形状を定義してください。
- In CAM, define the tool shape as an R2.0 radius shape.

プログラミング R Programming R (mm)	削り残し量 Remains (mm)	食い込み量 Over Cut (mm)
R3.0	0	0.4
推奨 Recommended R2.0	0.2	0
R1.5	0.3	0

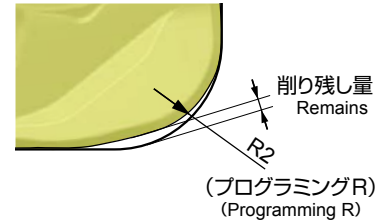

インサートブレーカの特長 Features of insert breaker

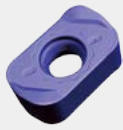

Cブレーカ C Breaker

当社の標準的な高送りインサート (EDNW, EPNW, WDNW, SDNW) に相当し、切りくずの噛み込み、振動、クレータ摩耗に強い。
Corresponds to our general high-feed-type inserts (EDNW, EPNW, WDNW, SDNW), and is resistant to chip jamming, vibrations, and crater wear.

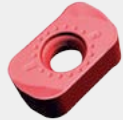

Bブレーカ B Breaker

ステンレス鋼などの切れ味が必要な被削材に適し、切削抵抗の低減が可能。
Enables reduced cutting force when cutting work materials such as stainless steel, etc. that require free-cutting performance.

● 切削抵抗比較 Comparison of cutting force

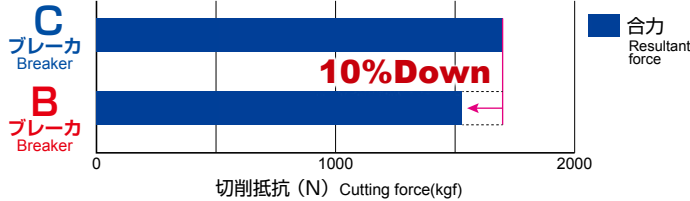

ポジティブ(正)のスキュー角 Positive rake angle

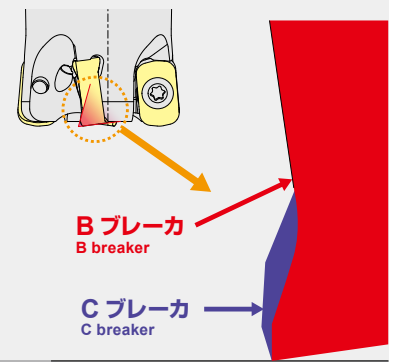

切れ刃部拡大断面
Magnified view of cutting edge cross section

切削事例 Field data

01 加工時間短縮 Shortened machining time

断続加工 Interrupted machining

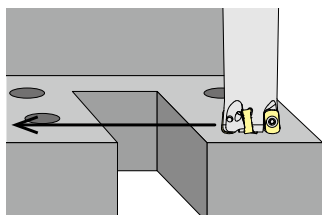

30min加工後 Cutting edge condition after 30 minutes of cutting



【被削材】プリハードン鋼(40HRC)
Work material Pre-hardened steel

【使用工具】TD4N2032S-5 (φ32-5枚刃)
Tool 5 flutes

ENMU0603ER-B (JP4120)

【切削条件】Vc=100m/min
Cutting conditions

Vf=9000mm/min (fz=1.8mm/t)

ap×ae=0.6×20mm

エアブロー Air-blow

- 1h30minの加工時間を約30minに短縮 90-minute machining time shortened to approx. 30 minutes.

02 工具寿命改善 Improved tool life

ポケット加工 Pocketing

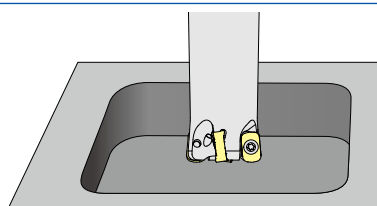

100min加工後 Cutting edge condition after 100 minutes of cutting



【被削材】炭素鋼
Work material Carbon steel

【使用工具】TD4N2020S-3 (φ20-3枚刃)
Tool 3 flutes

ENMU0603ER-B (JP4120)

【切削条件】Vc=140m/min
Cutting conditions

Vf=5000mm/min (fz=0.75mm/t)

ap×ae=0.8×10mm

水溶性切削液 Emulsion oil

- 大きな欠損無く、損傷が改善 There is no major chipping and damage is improved.

アルファ高送りラジアスマイル ASR

- 常識を超えた切削送り速度で、従来品に比較し3~5倍の深彫り加工ができ、加工時間短縮、加工費削減ができます。
- インサートは独特のR形状で最大切込み深さは2mmです。
- ・ At higher-than-normal cutting feed rates, offers 3 to 5 times the deep-cutting of conventional products, reducing cutting time and processing costs.
- ・ Insert has a unique R shape to enable maximum cutting depth of 2mm.



ASR () (-42) シャンクタイプ Shank type

○は数字、□は英文字が入ります。
Numeric figure in a circle ○ and Alphabetical character comes in a square □

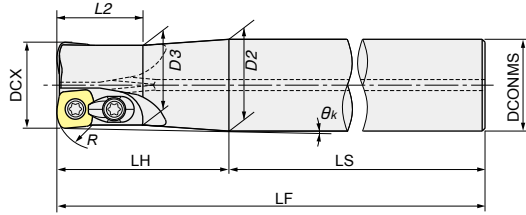

エア穴付き
With air hole

商品コード Item code	在庫 Stock	刃数 No. of flutes	寸法 Size(mm)											適用インサート Inserts	希望小売価格(円) Suggested retail price (¥)
			DCX	LF	DCONMS	R	LH	LS	L2	θk	D2	D3			
ASRS0020	●	2	20	130	20	10	50	80	20	-	20	18	EPNW0803TN-10	39,890	
ASRS0025	●	2	25	140	25		60	80	25	-	25	22.3	EDNW10T3TN-10	42,000	
ASRS4030	●	2	30	150	32		70	80	29	1.1°	32	27.8	ED 13T4TN-15(Z) ED W13T4TN-10	45,170	
ASRS4032	●	2	32	150	32		70	80	29	-	32	29.6		45,170	
ASRS4040	●	3	40	150	42	15 (10)	50	100	40	1.5°	42	35	ED 15T4TN-15(Z) ED W15T4TN-10	51,620	
ASRS5050	●	3	50	110	25※		50	60	50	-	47	47		53,850	
ASRS5050-42		3	50	150	42		50	100	50	-	43	43	-		
ASRS5063	●	4	63	120	32※		50	70	50	-	60	60	ED W15T4TN-10	70,970	
ASRS5063-42		4	63	150	42	50	100	50	-	52	52	-			
ASRL0020	●	2	20	180	20	10	100	80	20	-	20	18	EPNW0803TN-10	45,410	
ASRL0025	●	2	25	200	25		120	80	25	-	25	22.3	EDNW10T3TN-10	46,110	
ASRL4030	●	2	30	200	32	15 (10)	120	80	30	0.7°	32	27.8	ED 13T4TN-15(Z) ED W13T4TN-10	47,640	
ASRL4032	●	2	32	200	32		120	80	30	-	32	29.6		47,640	
ASRL4040	●	3	40	250	42		50	200	40	1.5°	42	35	68,630		
ASRL5050	●	3	50	250	42		50	200	50	-	47	47	ED 15T4TN-15(Z)	74,260	
ASRL5063	●	4	63	250	42	50	200	50	-	60	60	ED W15T4TN-10	87,280		
ASRE0020	●	2	20	250	20	10	130	120	20	-	20	18	EPNW0803TN-10	51,970	
ASRE0025	●	2	25	300	25		180	120	25	-	25	22.3	EDNW10T3TN-10	57,610	
ASRE4030	●	2	30	300	32	15 (10)	180	120	30	0.5°	32	27.8	ED 13T4TN-15(Z) ED W13T4TN-10	62,060	
ASRE4032	●	2	32	300	32		180	120	30	-	32	29.6		62,060	
ASRE4040	●	2	40	300	42		50	250	40	1.5°	42	35	77,080		

【注意】 ※印のシャンクはBT40, BT50のツーリングでご使用できます。
【Note】 ※Marked Shanks are available for both milling chucks of BT40 & BT50.

●印：標準在庫品です。 ●：Stocked items. 無印：弊社営業へお問合せください。 No mark：Contact with our sales department.

ASR○○○○(M)-○ ボアタイプ Bore type

○は数字が入ります。 Numeric figure in a circle ○

ボアタイプ用アーバはD11頁を参照ください。
Refer page D11 about the bore type arbor

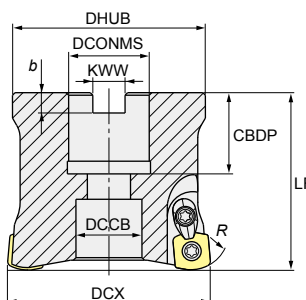

商品コード Item code	在庫 Stock	刃数 No. of flutes	寸法 Size(mm)								適用インサート Inserts	希望小売価格 (円) Suggested retail price (¥)			
			DCX	DHUB	LF	CBDP	R	KWW	b	DCONMS			DCCB		
ボアタイプ Bore type	内径インチサイズ Internal diameter inch size	ASR4050-3	●	3	50	47	50	19	15 (10)	8.4	5	22.225	17	ED○○13T4TN-15(Z) ED○○W13T4TN-10	56,190
		ASR4050-4	●	4	50	47	50	19		8.4	5	22.225	17		68,400
		ASR5060-3		3	60	57	50	19		8.4	5	22.225	17		-
		ASR5060-4	●	4	60	57	50	19		8.4	5	22.225	17		71,100
		ASR5063-3		3	63	60	50	19		8.4	5	22.225	17		-
		ASR5063-4	●	4	63	60	50	19		8.4	5	22.225	17	ED○○15T4TN-15(Z) ED○○W15T4TN-10	71,100
		ASR5080-4		4	80	76	70	32		12.7	8	31.75	26		-
		ASR5080-5	●	5	80	76	70	32		12.7	8	31.75	26		107,810
		ASR5100-5	●	5	100	96	70	32		12.7	8	31.75	26		127,860
		ASR5100-6	●	6	100	96	70	32		12.7	8	31.75	26		145,460
内径ミリサイズ Internal diameter mm size	ASR4050M-4	●	4	50	47	50	20	10.4	6.3	22	17	ED○○13T4TN-15(Z) ED○○W13T4TN-10	68,400		
	ASR5060M-4	●	4	60	57	50	20	10.4	6.3	22	17		71,100		
	ASR5063M-4	●	4	63	60	50	20	10.4	6.3	22	17	ED○○15T4TN-15(Z) ED○○W15T4TN-10	71,100		
	ASR5080M-5	●	5	80	76	70	22	12.4	7	27	20		107,810		
	ASR5100M-6	●	6	100	96	70	25	14.4	8	32	26		145,460		

【注意】 アーバ用ねじは付属しません。
【Note】 Arbor screw is not included.

アルファ高送りラジアスマル ASR

○は数字が入ります。 Numeric figure in a circle ○

ASRM00○-○ モジュラータイプ Modular type

モジュラーミル用シャンクはD2頁を、締め付けトルクについてはD5頁を参照ください。
Refer page D2 about the shanks for Modular Mill, Refer page D5 about tightening torque

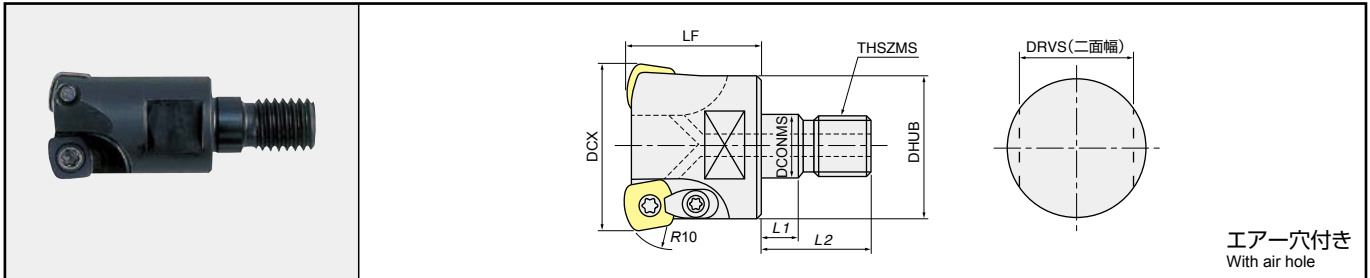

エア穴付き
With air hole

商品コード Item code	在庫 Stock	刃数 No. of flutes	寸法 Size(mm)								適用インサート Inserts	希望小売価格(円) Suggested retail price (¥)
			DCX	LF	DCONMS	THSZMS	DHUB	L1	L2	DRVS		
ASRM0020-2	●	2	20	30	10.5	M10	17.8	5.5	19	15	EPNW0803TN-10	39,890
ASRM0025-2	●	2	25	35	12.5	M12	20.8	5.5	22	17	EDNW10T3TN-10	42,000
ASRM0030-3	●	3	30	40	17	M16	28.8	6	23	22		52,920
ASRM0032-3	●	3	32	40	17	M16	28.8	6	23	22		52,920
※1 ASRM0035-3	●	3	35	40	17	M16	28.8	6	23	22		52,920
※1 ASRM0040-4	●	4	40	40	17	M16	28.8	6	23	22		60,660

【注意】※1と超硬シャンクをセットで使用すると干渉がありません。
モジュラーミル及び専用シャンク、専用アーバの「工具端面」「モジュラーねじ部」にグリースなどの潤滑剤は塗布しないでください。

【Note】When ※1 and carbide shank are used together as a set, there is no interference.
Do not apply lubricants such as grease, etc. to the "contact faces" and "modular screws" of the "modular mill", "dedicated shanks" and "dedicated arbor".

部品番号 Parts

○は数字が入ります。 Numeric figure in a circle ○

部品名 Parts	クランプねじ Clamp screw	クランプ駒セット Clamp piece set	ドライバー/レンチ Screw driver / Wrench	ねじ焼き付き防止剤 Screw anti-seizure agent	
形状 Shape					
適用カッター Cutter body	締めトルク Fastening torque (N·m)	希望小売 価格(円) Suggested retail price (¥)	希望小売 価格(円) Suggested retail price (¥)	形状 Shape	
ASR S/L/E0020	242-141	2.9	540	—	—
ASRM0020-2					
ASR S/L/E0025	412-141	2.9	540	CM3.5-141	2,030
ASRM ○○○○-○					
ASR S/L/E4	555-141	4.9	690	CM5-147	2,030
ASR S/L5					
ASR ○○○○-○					
ASR ○○○○M-○					
				形状 Shape	希望小売 価格(円) Suggested retail price (¥)
					希望小売 価格(円) Suggested retail price (¥)

【注意】クランプねじは消耗品です。使用環境により交換寿命は変化しますので早めの交換をお願い致します。

【Note】The clamp screw is a consumable part. Since replacement life depends on the use environment, it is recommended that it be replaced at an early stage.

■ インサート Inserts

○は数字が入ります。 Numeric figure in a circle ○

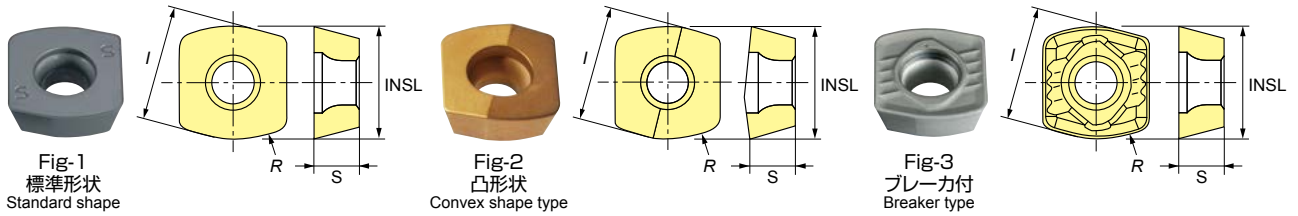

商品コード Item code	種類 Tolerance class	コーティング Coating						寸法 Size(mm)				形状 Shape	適用カッタ Cutter body	希望小売価格(円) Suggested retail price(¥)	
		AJコーティング AJ Coating	GXコーティング GX Coating	JSコーティング JS Coating	Cコーティング C Coating	Gコーティング G Coating	R	l	S	INSL	AJコーティング GXコーティング JSコーティング AJ, GX, JS Coating			CY250 GF30	
EPNW0803TN-10	N級 N	●	●	●	●	●	●	10	8.1	3.18	7.94	Fig-1	ASR S/L/E 0020 ASRM0020-2	1,100	1,010
EDNW10T3TN-10		●	●	●	●	●	●	10	10	3.97	10		ASR S/L/E 0025 ASRM○○○○-○	1,310	1,190
EDNW13T4TN-10		●	●	●	●	●	●	10	13.5	5.56	12.7		ASR S/L/E 4○○○○(-○○) ASR4050M-4	1,640	1,500
EDNW13T4TN-15		●	●	●	●	●	●	15	13.5	5.56	12.7			1,640	1,500
EDNW15T4TN-10		●	●	●	●	●	●	10	15	5.56	14		ASR S/L 5○○○○(-○○) ASR5○○○M-○	1,900	1,730
EDNW15T4TN-15		●	●	●	●	●	●	15	15	5.56	14			1,900	1,730
EDEW13T4TN-10	E級 E				●		●	10	13.5	5.56	12.7	Fig-1	ASR S/L/E 4○○○○(-○○) ASR4050M-4	2,830	2,570
EDEW13T4TN-15					●		●	15	13.5	5.56	12.7			2,830	2,570
EDEW15T4TN-10					●		●	10	15	5.56	14		ASR S/L 5○○○○(-○○) ASR5000M-○	3,000	2,720
EDEW15T4TN-15					●		●	15	15	5.56	14			3,000	2,720
EDNW13T4TN-15Z	N級 N	●	●	●	●	●		15	13.5	5.56	12.7	Fig-2	ASR S/L/E 4○○○○(-○○) ASR4050M-4	1,640	—
EDNW15T4TN-15Z		●	●	●	●	●		15	15	5.56	14		ASR S/L 5○○○○(-○○) ASR5○○○M-○	1,900	—
EDMT13T4TN-15	M級 M		●	●	●	●	●	15	13.5	5.56	12.7	Fig-3	ASR S/L/E 4○○○○(-○○) ASR4050M-4	1,640	1,500
EDMT15T4TN-15			●	●	●	●	●	15	15	5.56	14		ASR S/L 5○○○○(-○○) ASR5○○○M-○	1,900	1,730

[注意] 使い分け: R15は、突き出し量5DCX以下、R10は突き出し量4~5DCX以上を推奨致します。
GXコーティング、JSコーティングは通電式タッチセンサーに反応しませんのでご注意ください。
インサート取付けは右図を参考に、正しい向きで取付けてください。

[Note] We recommend, R15 for overhang 5DCX or less; R10 for overhang 4~5DCX or more.
Please note that the GX Coating and JS Coating do not cause a reaction in conductive touch sensors.
Mount the insert in the correct orientation as shown in the figure on the right.

インサート取付け方法 Insert mounting

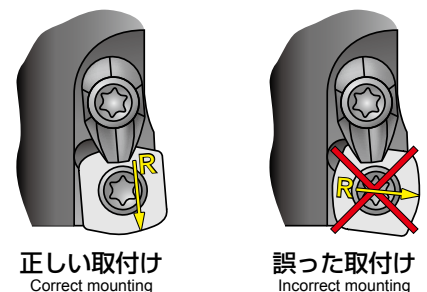

正しい取付け
Correct mounting

誤った取付け
Incorrect mounting

アルファ高送りラジアスマイル ASR

標準切削条件表 Recommended cutting conditions

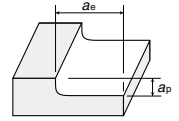

※赤字は第一推奨材種です。※Red indicates primary recommended grade.

被削材 Work material	推奨材種 Recommended grade	切削速度 Cutting speed vc (m/min)	一刃当りの送り fz (mm/t) Feed rate	φ20(2枚刃 Flutes)			φ25(2枚刃 Flutes)			φ30(2枚刃 Flutes)			φ40(3枚刃 Flutes)		
				回転数 min ⁻¹	送り速度 mm/min	Q値 cm ³ /min	回転数 min ⁻¹	送り速度 mm/min	Q値 cm ³ /min	回転数 min ⁻¹	送り速度 mm/min	Q値 cm ³ /min	回転数 min ⁻¹	送り速度 mm/min	Q値 cm ³ /min
一般構造用鋼 (200HB以下) General structural steel	※GX2140 JS4060 JS4045	180~200	0.6~1.5	2,860	3,430	69	2,290	2,750	69	1,900	5,700	171	1,430	6,400	256
		vc=180m/min fz=0.6mm/t ap=1.0mm ae=1.0DCX	90~150	0.6~2.0	1,430	1,720	34	1,150	1,380	34	960	2,880	86	720	3,240
炭素鋼 合金鋼 (30HRC以下) Carbon steels Alloy steels	GX2140 JS4045 JS4060	180~200	0.6~1.5	2,860	3,430	69	2,290	2,750	69	1,900	5,700	171	1,430	6,400	256
		vc=180m/min fz=0.6mm/t ap=1.0mm ae=1.0DCX	90~150	0.6~2.0	1,430	1,720	34	1,150	1,380	34	960	2,880	86	720	3,240
炭素鋼 合金鋼 (30~45HRC) Carbon steels Alloy steels	JP4120 JS4045 JS4060	80~120	0.4~0.8	1,430	1,430	29	1,150	1,150	29	960	1,500	45	720	1,730	69
		vc=90m/min fz=0.5mm/t ap=1.0mm ae=1.0DCX	80~130	0.5~1.0	1,592	1,910	38	1,274	1,528	38	1,061	1,273	38	796	1,433
ステンレス鋼 SUS	JM4160	150~200	0.5~1.0		vc=100m/min fz=0.6mm/t ap=1.0mm ae=1.0DCX			vc=100m/min fz=0.6mm/t ap=1.0mm ae=1.0DCX			vc=100m/min fz=0.6mm/t ap=1.0mm ae=1.0DCX			vc=100m/min fz=0.6mm/t ap=1.0mm ae=1.0DCX	
		1,430		1,430	29	1,150	1,150	29	960	1,500	45	720	1,730	69	
焼入れ鋼 (45~50HRC) Hardened steels Pre-Hardened steels	JP4120 JS4045	70~120	0.2~0.6	1,110	440	9	890	350	9	740	300	9	550	330	13
		vc=70m/min fz=0.2mm/t ap=1.0mm ae=1.0DCX	1,110	440	5	890	350	5	740	300	5	550	330	7	
焼入れ鋼(50~55HRC) Hardened steels	JP4105	70~100	0.05~0.2	vc=70m/min fz=0.2mm/t ap=0.5mm ae=1.0DCX			vc=70m/min fz=0.2mm/t ap=0.5mm ae=1.0DCX			vc=70m/min fz=0.2mm/t ap=0.5mm ae=1.0DCX			vc=70m/min fz=0.2mm/t ap=0.5mm ae=1.0DCX		
		790		80	1	630	60	1	530	53	0.8	400	60	1	
焼入れ鋼(55~60HRC) Hardened steels	JP4105	50~100	0.05~0.2	vc=50m/min fz=0.05mm/t ap=0.5mm ae=1.0DCX			vc=50m/min fz=0.05mm/t ap=0.5mm ae=1.0DCX			vc=50m/min fz=0.05mm/t ap=0.5mm ae=1.0DCX			vc=50m/min fz=0.05mm/t ap=0.5mm ae=1.0DCX		

被削材 Work material	推奨材種 Recommended grade	切削速度 Cutting speed vc (m/min)	一刃当りの送り fz (mm/t) Feed rate	φ50(4枚刃 Flutes)			φ63(4枚刃 Flutes)			φ80(5枚刃 Flutes)			φ100(6枚刃 Flutes)		
				回転数 min ⁻¹	送り速度 mm/min	Q値 cm ³ /min	回転数 min ⁻¹	送り速度 mm/min	Q値 cm ³ /min	回転数 min ⁻¹	送り速度 mm/min	Q値 cm ³ /min	回転数 min ⁻¹	送り速度 mm/min	Q値 cm ³ /min
一般構造用鋼 (200HB以下) General structural steel	※GX2140 JS4060 JS4045	180~200	0.6~1.5	1,150	6,900	510	910	5,500	520	720	5,400	650	570	5,130	770
		vc=180m/min fz=1.5mm/t ap=1.5mm ae=1.0DCX	90~150	0.6~2.0	570	3,420	257	455	2,730	258	360	2,700	325	290	2,610
炭素鋼 合金鋼 (30HRC以下) Carbon steels Alloy steels	GX2140 JS4045 JS4060	180~200	0.6~1.5	1,150	6,900	510	910	5,500	520	720	5,400	650	570	5,130	770
		vc=180m/min fz=1.5mm/t ap=1.5mm ae=1.0DCX	90~150	0.6~2.0	570	3,420	257	455	2,730	258	360	2,700	325	290	2,610
炭素鋼 合金鋼 (30~45HRC) Carbon steels Alloy steels	JP4120 JS4045 JS4060	80~120	0.4~0.8	570	1,820	130	455	1,450	140	360	1,440	170	290	1,400	210
		vc=90m/min fz=0.8mm/t ap=1.5mm ae=1.0DCX	80~130	0.5~1.0	637	1,528	76	505	1,213	76	398	1,194	96	319	1,146
ステンレス鋼 SUS	JM4160	150~200	0.5~1.0		vc=100m/min fz=0.6mm/t ap=1.0mm ae=1.0DCX			vc=100m/min fz=0.6mm/t ap=1.0mm ae=1.0DCX			vc=100m/min fz=0.6mm/t ap=1.0mm ae=1.0DCX			vc=100m/min fz=0.6mm/t ap=1.0mm ae=1.0DCX	
		1,274		3,056	122	1,011	2,426	122	796	2,388	153	637	2,292	184	
焼入れ鋼 (45~50HRC) Hardened steels Pre-Hardened steels	JP4120 JS4045	70~120	0.2~0.6	440	360	18	350	280	18	280	280	22	220	260	26
		vc=70m/min fz=0.2mm/t ap=1.0mm ae=1.0DCX	1,150	9,200	920	910	7,280	920	720	7,200	1,150	570	6,840	1,370	
焼入れ鋼(50~55HRC) Hardened steels	JP4105	70~100	0.05~0.2	vc=180m/min fz=2.0mm/t ap=2.0mm ae=1.0DCX			vc=180m/min fz=2.0mm/t ap=2.0mm ae=1.0DCX			vc=180m/min fz=2.0mm/t ap=2.0mm ae=1.0DCX			vc=180m/min fz=2.0mm/t ap=2.0mm ae=1.0DCX		
		570		4,560	456	455	3,640	459	360	3,600	576	290	3,480	696	
焼入れ鋼(55~60HRC) Hardened steels	JP4105	50~100	0.05~0.2	vc=90m/min fz=2.0mm/t ap=2.0mm ae=1.0DCX			vc=90m/min fz=2.0mm/t ap=2.0mm ae=1.0DCX			vc=90m/min fz=2.0mm/t ap=2.0mm ae=1.0DCX			vc=90m/min fz=2.0mm/t ap=2.0mm ae=1.0DCX		
		630		760	38	500	600	38	400	600	48	320	576	58	
焼入れ鋼(50~55HRC) Hardened steels	JP4105	70~100	0.05~0.2	vc=100m/min fz=0.3mm/t ap=1.0mm ae=1.0DCX			vc=100m/min fz=0.3mm/t ap=1.0mm ae=1.0DCX			vc=100m/min fz=0.3mm/t ap=1.0mm ae=1.0DCX			vc=100m/min fz=0.3mm/t ap=1.0mm ae=1.0DCX		
		440		350	9	350	280	9	270	270	11	220	260	13	
焼入れ鋼(55~60HRC) Hardened steels	JP4105	50~100	0.05~0.2	vc=70m/min fz=0.2mm/t ap=0.5mm ae=1.0DCX			vc=70m/min fz=0.2mm/t ap=0.5mm ae=1.0DCX			vc=70m/min fz=0.2mm/t ap=0.5mm ae=1.0DCX			vc=70m/min fz=0.2mm/t ap=0.5mm ae=1.0DCX		
		310		62	1.5	250	50	1.5	200	50	2.0	160	48	2.4	
焼入れ鋼(55~60HRC) Hardened steels	JP4105	50~100	0.05~0.2	vc=50m/min fz=0.05mm/t ap=0.5mm ae=1.0DCX			vc=50m/min fz=0.05mm/t ap=0.5mm ae=1.0DCX			vc=50m/min fz=0.05mm/t ap=0.5mm ae=1.0DCX			vc=50m/min fz=0.05mm/t ap=0.5mm ae=1.0DCX		

刃先交換式工具 高送りラジアスマイル

- [注意]**
- ① モジュラーミル用BT30アーバご使用の際は、標準切削条件表を目安に加工条件を決定して下さい。加工状況により振動が懸念される場合は、**1.切り込み深さを低減する 2.一刃当りの送り(fz)を低減する方法**で調整下さい。
 - ② この標準切削条件表は切削条件の目安を示すものです。実際の加工では、加工形状、目的、使用機械等により条件を調整して下さい。
 - ③ GXコーティング、JSコーティングは通電式タッチセンサーに反応しませんのでご注意ください。
 - ④ 「JP4105」は高硬度鋼専用材種で、生材には適しません。
 - ⑤ 強断続切削、突出しが長い場合及び湿式切削には「JM4160」を推奨します。
 - ⑥ この工具は、厚く重い切りくずが排出されます。よって、切りくず噛み込みによる工具損傷防止のため、必ずエアによる切りくず除去を行ってください。エアの掛けかたは、スピンドル・センタスルー方式を推奨します。(縦型マシニングセンタによるキャビティ加工時の切りくず処理には、十分ご注意ください)
 - ⑦ 無人加工の場合、事前に十分な切りくず排除を行い、安定な切削が可能であることを確認のうえ、使用することをお勧めいたします。
 - ⑧ 排出した切りくずは、飛散し作業者を切傷させ、火傷あるいは目に入って負傷させる恐れがありますので、ご使用に際してはその周囲に安全カバーを取付け、保護めがね等の保護具を着用して、安全な環境で作業されることをお願い致します。
 - ⑨ インサートの交換は、早めに行い過度の使用による破損を防止して下さい。
 - ⑩ **切り込み深さは、最大2mm以下でご使用ください。(右図参照下さい。)**
 - ⑪ 不水溶性切削油は、火災の恐れがありますので使用しないで下さい。

- [Note]**
- ① When using the BT30 arbor for modular mills, determine the cutting conditions using the standard cutting conditions table as a general guide. If vibrations are a concern due to the cutting conditions, adjust conditions by **1.reducing cutting depth (ap) or 2.reducing per-flute feed rate (fz)**.
 - ② The cutting conditions in this catalog shown in the table above are reference cutting conditions, and should be adjusted according to the actual shape to be machined, the machine used, and purpose for machining.
 - ③ Please note that the GX Coating and JS Coating do not cause a reaction in conductive touch sensors.
 - ④ JP4105 is for the high-hardness steels. It is not suitable for Non-heat-treated steel material.
 - ⑤ For strongly interrupted cutting, when unsupported length is long, or for wet cutting, JM4160 is recommended.
 - ⑥ Please use an air-blast to remove the thick and heavy swarf created by this tool, through spindle air is recommended if available. Pay particular attention for vertical operations.
 - ⑦ For man-less machining be sure to take care of swarf evacuation to create safe working conditions.
 - ⑧ The evacuation of swarf can cause burns, cuts or damage to the eyes please ensure the correct safety cover is fitted around the machine, and necessary personal protection equipment is worn by the machine operator.
 - ⑨ Ensure to index the insert at the correct time to ensure safety of the tool-body.
 - ⑩ **Ensure that the depth of cut is no greater than 2mm (Right figure).**
 - ⑪ Due to fire risks do not use neat cutting oil as a coolant.

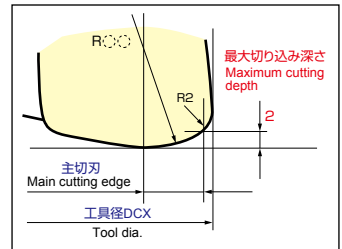

■ ダイレクトに彫り込み加工も可能 Cutting by direct milling possible:

中心まで切れ刃がないため傾斜角度は制限されますが、下図に示しますように傾斜切削やヘリカル切削にて、下穴がなくてもダイレクトに彫り込み加工が可能です。

・ Although Ramp angle is limited due to cutting edge design, direct milling is possible without pre-cutting with Ramping and helical milling methods like next pictures.

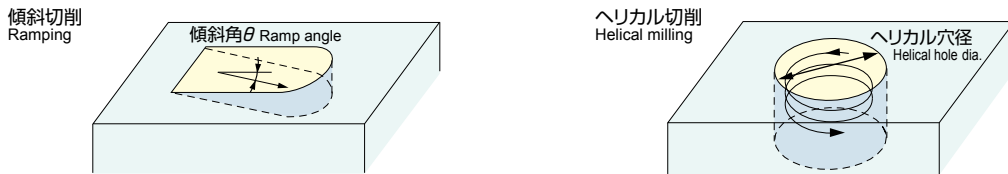

工具径DCX Tool dia.	φ20	φ25	φ30	φ32	φ40	φ50	φ60	φ63	φ80	φ100
最大傾斜角θ Maximum ramp angle	2°	2°	3°	2.5°	2°	1.5°	1°	1°	0.5°	0.5°
ヘリカル穴径 Helical hole dia.	27~38	37~48	38~58	42~62	58~78	78~98	98~118	101~124	136~158	176~198

- [注意]**
- ① 傾斜角θは上記範囲を超えない様に設定して下さい。0.5°以下での使用を推奨します。
 - ② 穴径が上記範囲以下の場合は下穴をあけて加工して下さい。
- [Note]**
- ① The ramp angle θ should be set within the ranges listed above. Use at ramp angles of 0.5° or less is recommended.
 - ② For hole diameters outside the ranges listed above, a pilot hole should be drilled before milling.

■ プログラム上の刃先形状定義方法 To define cutting edge shape for programming:

荒取り加工時は、ラジASMIL、プログラミングR (R3) としてインプットすれば下図のインサートR別の削り残し量で加工できます。

・ By inputting Radius Mill programming R (R3), insert R cutting remains cutting as shown below is possible for roughing procedures.

インサート刃先形状略図 Insert shape rough sketch

プログラミングR : R3
Programming R : R3

EDW00T0TN-15
削り残し量χ=約0.6mm
(R15 : 突き出し量5DCX以下用)
Remains χ = approx. 0.6mm
R15 : Overhang 5DCX or less recommended

EDW00T0TN-10
削り残し量χ=約0.5mm
(R10 : 突き出し量4~5DCX以上用)
Remains χ = approx. 0.5mm
R10 : Overhang 4~5DCX or more recommended

Radius Mill 3 Corners ASRT

アルファ高送りラジアスマイル3コーナ ASRT

- 超高効率！アルファ高送りラジアスマイルに3コーナ仕様追加！
- 難削金型材加工に威力を発揮する新材種JP4120登場！
- 低切削抵抗のB形ブレーカ追加！
- ・ Ultra-high efficiency! 3-corner specification added for high feed radius end mill.
- ・ Introducing new material JP4120. Show it's potential for difficult to cut die and mold materials.
- ・ B type breaker of low cutting force is added.



ASRT R- シャンクタイプ Shank type

は数字、 は英文字が入ります。
Numeric figure in a circle and Alphabetical character comes in a square

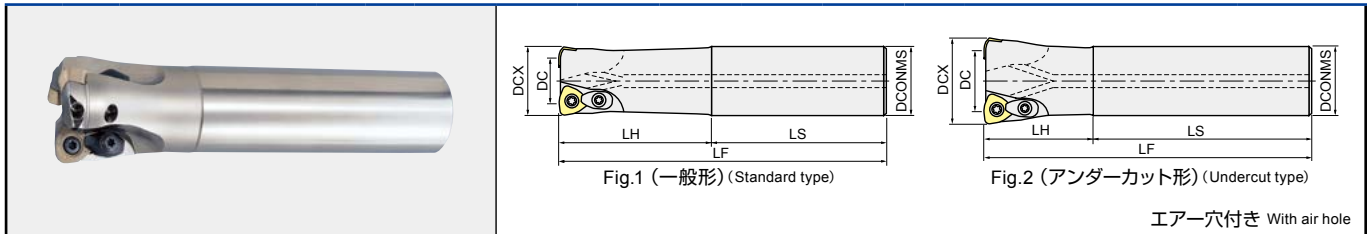

商品コード Item code	在庫 Stock	刃数 No. of flutes	寸法 Size (mm)							形状 Shape	適用インサート Inserts	希望小売価格(円) Suggested retail price (¥)
			DCX	DC	LF	DCONMS	LH	LS				
Shank type Regular レギュラー	ASRTS3025R-2	●	2	25	14	140	25	60	80	Fig1	WDNW09T320	42,000
	ASRTS3028R-2	●	2	28	17	140	25	40	100	Fig2	WDNT09T320 (-B/ZH)	45,170
	ASRTS4032R-2	●	2	32	20	150	32	70	80	Fig1	WDNW120420(Z) WDNT120420(-B/ZH)	45,170
	ASRTS4035R-2	●	2	35	23	150	32	50	100	Fig2		45,170
	ASRTS4040R-3	●	3	40	28	150	32	50	100	Fig2	51,620	
Shank type Long ロング	ASRTL3025R-2	●	2	25	14	200	25	120	80	Fig1	WDNW09T320	46,110
	ASRTL3028R-2	●	2	28	17	200	25	40	160	Fig2	WDNT09T320(-B/ZH)	47,640
	ASRTL4032R-2	●	2	32	20	200	32	120	80	Fig1	WDNW120420(Z) WDNT120420(-B/ZH)	47,640
	ASRTL4035R-2	●	2	35	23	200	32	50	150	Fig2		47,640
	ASRTL4040R-3	●	3	40	28	250	32	50	200	Fig2	68,630	

は数字が入ります。 Numeric figure in a circle

ASRT R(M)- ボアタイプ Bore type

ボアタイプ用アーバはD11頁を参照ください。
Refer page D11 about the bore type arbor

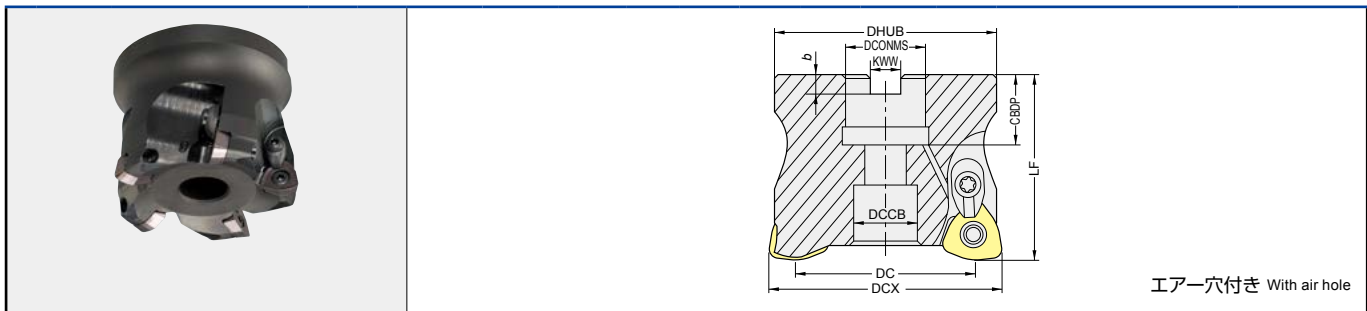

商品コード Item code	在庫 Stock	刃数 No. of flutes	寸法 Size (mm)										適用インサート Inserts	希望小売価格(円) Suggested retail price (¥)
			DCX	DC	DHUB	LF	CDBP	KWW	b	DCONMS	DCCB			
ボアタイプ Internal diameter inch size	ASRT4050R-3	●	3	50	38	47	50	19	8.4	5	22.225	16.5	WDNW120420(Z) WDNT120420(-B/ZH)	56,190
	ASRT4050R-4	●	4	50	38	47	50	19	8.4	5	22.225	16.5	WDNT120420(-B/ZH)	68,400
	ASRT5063R-4	●	4	63	50	60	50	19	8.4	5	22.225	17	WDNW140520(Z) WDNT140520(-B/ZH)	71,100
	ASRT5080R-5	●	5	80	67	76	63	32	12.7	8	31.75	26		107,810
	ASRT5100R-6	●	6	100	87	96	63	32	12.7	8	31.75	26	145,460	
	ボアタイプ Internal diameter mm size	ASRT4050RM-3	●	3	50	38	47	50	20	10.4	6.3	22	16.5	WDNW120420(Z) WDNT120420(-B/ZH)
ASRT4050RM-4		●	4	50	38	47	50	20	10.4	6.3	22	16.5	WDNT120420(-B/ZH)	68,400
ASRT5063RM-4		●	4	63	50	60	50	20	10.4	6.3	22	17	WDNW140520(Z) WDNT140520(-B/ZH)	71,100
ASRT5080RM-5		●	5	80	67	76	63	22	12.4	7	27	20		107,810
ASRT5100RM-6		●	6	100	87	96	63	25.5	14.4	8	32	26	145,460	

【注意】アーバ用ねじは付属しません。 【Note】 Arbor screw is not included.

●印：標準在庫品です。 ●：Stocked items. 無印：弊社営業へお問合せください。 No mark：Contact with our sales department.

ASRTM30○○R-○ モジュラータイプ Modular type

○は数字が入ります。 Numeric figure in a circle ○

モジュラーミル用シャンクはD2頁を、締め付けトルクについてはD5頁を参照ください。
Refer page D2 about the shanks for Modular Mill, Refer page D5 about tightening torque

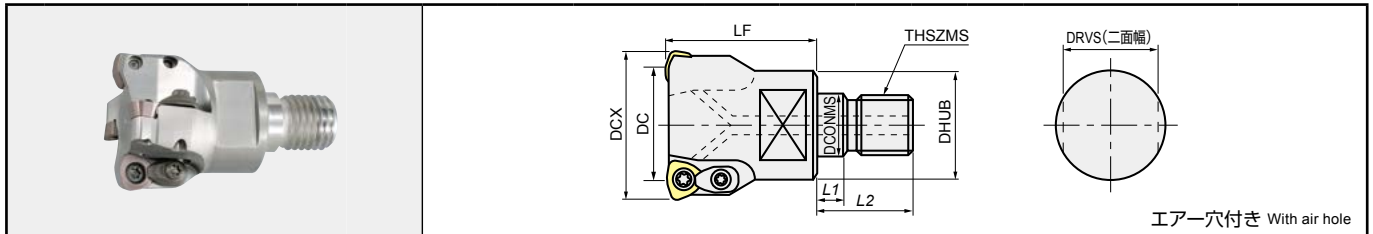

エア穴付き With air hole

商品コード Item code	在庫 Stock	刃数 No. of flutes	寸法 Size (mm)									適用インサート Inserts	希望小売価格(円) Suggested retail price (¥)
			DCX	DC	LF	DCONMS	THSZMS	DHUB	L1	L2	DRVS		
ASRTM3025R-2	●	2	25	14	35	12.5	M12	20.8	5.5	22	17	WDNW09T320 WDNT09T320 WDNT09T320-B WDNT09T320ZH	42,000
*1 ASRTM3028R-2	●	2	28	17	35	12.5	M12	23	5.5	22	17		45,170
ASRTM3030R-2		2	30	19	40	17	M16	28.8	6	23	22		—
ASRTM3030R-3	●	3	30	19	40	17	M16	28.8	6	23	22		52,920
ASRTM3032R-2		2	32	21	40	17	M16	28.8	6	23	22		—
ASRTM3032R-3	●	3	32	21	40	17	M16	28.8	6	23	22		52,920
*1 ASRTM3035R-2		2	35	24	40	17	M16	28.8	6	23	22		—
*1 ASRTM3035R-3	●	3	35	24	40	17	M16	28.8	6	23	22		52,920
*1 ASRTM3040R-3		3	40	29	40	17	M16	28.8	6	23	22		—
*1 ASRTM3040R-4	●	4	40	29	40	17	M16	28.8	6	23	22		60,660

[注意] ※1と超硬シャンクをセットで使用すると干渉がありません。
モジュラーミル及び専用シャンク、専用アーバの「工具端面」「モジュラーねじ部」にグリースなどの潤滑剤は塗布しないでください。
[Note] When ※1 and carbide shank are used together as a set, there is no interference.
Do not apply lubricants such as grease, etc. to the "contact faces" and "modular screws" of the "modular mill", "dedicated shanks" and "dedicated arbor".

部品番号 Parts

○は数字が入ります。 Numeric figure in a circle ○

部品名 Parts	クランプねじ Clamp screw			クランプ駒セット Clamp piece set		ドライバー／レンチ Screw driver / Wrench			ねじ焼き付き防止剤 Screw anti-seizure agent	
形状 Shape						A B				
適用カッタ Cutter body	締付トルク Fastening torque (N·m)	希望小売 価格(円) Suggested retail price (¥)	希望小売 価格(円) Suggested retail price (¥)	希望小売 価格(円) Suggested retail price (¥)	希望小売 価格(円) Suggested retail price (¥)	形状 Shape	希望小売 価格(円) Suggested retail price (¥)	希望小売 価格(円) Suggested retail price (¥)		
ASRT M/S/L30○○R-○	242-141	2.9	540	CM3.5-141	2,030	104-T15	A	2,060	P-37	1,010
ASRT S/L40○○R(M)-○	262-142	2.9	870	CM4-141	2,030	105-T15	B	2,120		
ASRT5○○○R(M)-○	555-141	4.9	690	CM5-147	2,030	105-T20	B	2,120		

[注意] クランプねじは消耗品です。使用環境により交換寿命は変化しますので早めの交換をお願い致します。クランプねじは予備が1本付属します。
[Note] The clamp screw is a consumable part. Since replacement life depends on the use environment, it is recommended that it be replaced at an early stage.
One spare clamp screw is provided.

■ インサート Inserts

○は数字が入ります。 Numeric figure in a circle ○

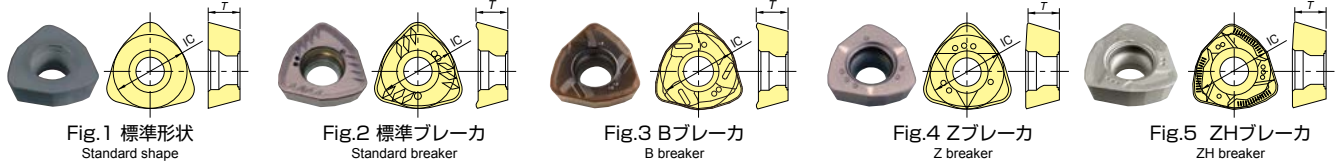

商品コード Item code	精度 Tolerance class	AJコーティング AJ Coating		GXコーティング GX Coating	JSコーティング JS Coating		寸法 Size (mm)		形状 Shape	適用カッタ Cutter body	希望小売 価格(円) Suggested retail price (¥)	
		JP4105	JP4120	JM4160	GX2140	JS4045	JS4060	IC				T
WDNW09T320	N級 N	●	●	●	●	●	●	9.525	3.97	Fig.1	ASRT M/S/L30○R○	1,070
WDNW120420		●	●	●	●	●	●	12	4.76		ASRT S/L40○R(M)-○	1,310
WDNW140520		●	●	●	●	●	●	14	5.56		ASRT 5○R(M)-○	1,500
WDNT09T320					●	●	●	9.525	3.97	Fig.2	ASRT M/S/L30○R○	1,070
WDNT120420					●	●	●	12	4.76		ASRT S/L40○R(M)-○	1,310
WDNT140520					●	●	●	14	5.56		ASRT 5○R(M)-○	1,500
WDNT09T320-B			●	●	●	●	●	9.525	3.97	Fig.3	ASRT M/S/L30○R○	1,070
WDNT120420-B			●	●	●	●	●	12	4.76		ASRT S/L40○R(M)-○	1,310
WDNT140520-B			●	●	●	●	●	14	5.56		ASRT 5○R(M)-○	1,500
WDNW120420Z				●	●		●	12	4.76	Fig.4	ASRT S/L40○R(M)-○	1,310
WDNW140520Z				●	●		●	14	5.56		ASRT 5○R(M)-○	1,500
WDNT09T320ZH					●		●	9.525	3.97	Fig.5	ASRT M/S/L30○R○	1,070
WDNT120420ZH					●		●	12	4.76		ASRT S/L40○R(M)-○	1,310
WDNT140520ZH					●		●	14	5.56		ASRT 5○R(M)-○	1,500

[注意] GXコーティング、JSコーティングは通電式タッチセンサーに反応しませんのでご注意ください。
[Note] Please note that the GX Coating and JS Coating do not cause a reaction in conductive touch sensors.

●印：標準在庫品です。 ●：Stocked items. 無印：弊社営業へお問合せください。 No mark：Contact with our sales department.

実績は語る Field data

No	被削材 Work material	工具径 DCX Tool dia.	インサート材種 Grade	使用条件 Cutting conditions					結果 Result
				V_c (m/min) [n (min ⁻¹)]	f_z (mm/t) [V_f (mm/min)]	$a_p \times a_e$ (mm)	切削油剤 Coolant	突出し量(mm) Overhang	
1	P21 (40HRC)	40	JP4120相当 Equivalent to JP4120	75 [600]	1.1 [1,980]	$a_p=0.5$ $a_e=24$	エア Air	50	従来品に比べ1.5倍の長寿命。 1.5× the tool life of conventional products
2	SKD61 (45HRC)	63	JP4120相当 Equivalent to JP4120	70 [350]	0.6 [840]	$a_p=0.5$ $a_e=36$	エア Air	100	従来品より欠け少なく長寿命。 Long tool life with less chipping than conventional products
3	SKD61 (43HRC)	40	JP4120相当 Equivalent to JP4120	70 [560]	0.7 [1,180]	$a_p=1.0$ $a_e=24$	エア Air	40	従来品に比べ1.5倍の長寿命。 1.5× the tool life of conventional products
4	S55C (220HB)	63	JS4060	130 [567]	1.5 [3,400]	$a_p=1$ $a_e=50$	エア Air	200	従来品に比べ2倍の長寿命。 2× the tool life of conventional products
5	SKD11 (≤ 255 HB)	50	JS4060	188 [1,200]	1.0 [4,800]	$a_p=1.5$ $a_e=40$	エア Air	150	従来品に比べ2倍の長寿命。 2× the tool life of conventional products
6	P20	80	GX2140	180 [720]	1.1 [4,000]	$a_p=0.8$ $a_e=56$	エア Air	150	従来品に比べ2倍の長寿命。 2× the tool life of conventional products

プログラム上の刃先形状定義 Flute tip shape definition method in program

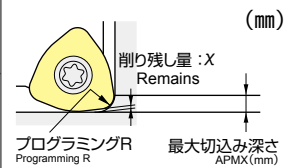
商品コード Item code	プログラミングR Programming R	削り残し量 : X Remains	最大切込み深さ Maximum cut depth	(mm)
WDN W/T09T320	3	0.47	2	 <p>CAMプログラムを製作する場合、コーナーR3のラジাসカッタとして製作してください。 When creating the CAM program, create the program as if a corner R3 radius cutter was being used.</p>
WDN W/T120420(Z)	3	0.63	2	
WDN W/T140520(Z)	3	0.64	2	

ダイレクトに彫り込み加工も可能 Cutting by direct milling is also possible.

中心まで切れ刃がないため傾斜角度と穴径は制限されますが、下図に示すように傾斜切削やヘリカル切削にて、下穴がなくてもダイレクトに彫り込み加工が可能です。
Since the cutting flute do not extend to the center, there are limitations on the ramp angle and hole diameter, but as shown below, cutting by direct milling without a pilot hole is possible for ramping and helical milling.

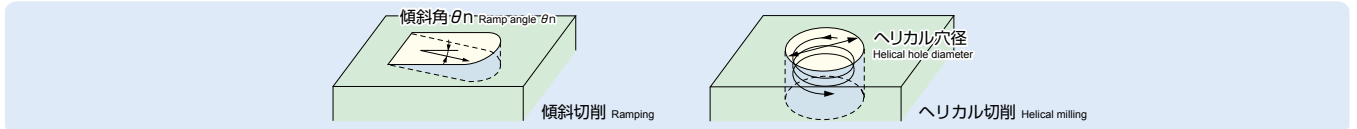

インサート Inserts	モジュラータイプ / シャンクタイプ Modular type/Shank type							ボアタイプ Bore type					
	WDN W/T09T320							WDN W/T120420(Z)			WDN W/T140520(Z)		
工具径DCX Tool dia.	$\phi 25$	$\phi 28$	$\phi 30$	$\phi 32$	$\phi 35$	$\phi 40$	$\phi 32$	$\phi 35$	$\phi 40$	$\phi 50$	$\phi 63$	$\phi 80$	$\phi 100$
最大傾斜角 θ_n Maximum ramp angle θ_n	4°	3°	2.5°	2.5°	2°	1.5°	4°	3.5°	3°	2°	2.5°	1.5°	1°
ヘリカル穴径 Hole dia.	33~46	39~52	43~56	47~60	53~66	63~76	41~60	47~66	57~76	77~96	98~122	132~156	172~196

【注意】 ① 傾斜角 θ は上記範囲を超えない様に設定して下さい。1°以下での使用を推奨します。② 穴径が上記範囲以外の場合は下穴を開けて加工して下さい。

【Note】 ① The ramp angle θ should be set within the ranges listed above. Use at ramp angles of 1° or less is recommended.

② For hole diameters outside the ranges listed above, a pilot hole should be drilled before milling.

標準切削条件表 Recommended cutting conditions

※赤字は第一推奨材種です。Red indicates primary recommended grade.

被削材 Work material	推奨材種 Recommended grade	工具径DCX Tool dia. φ25(2枚刃) 2 flutes φ32(2枚刃) 2 flutes φ40(3枚刃) 3 flutes	ストレートシャンクタイプ Straight shank type									モジュラー超硬シャンクタイプ Modular carbide shank Type								
			<3DCX		<3DCX		<3DCX		φ25(2枚刃) 2 flutes			φ32(3枚刃) 3 flutes			φ40(4枚刃) 4 flutes					
			汎用 General purpose	高速加工 High speed processing	汎用 General purpose	高速加工 High speed processing	汎用 General purpose	高速加工 High speed processing	3DCX 5DCX	5DCX 7DCX	>7DCX	3DCX 5DCX	5DCX 7DCX	>7DCX	3DCX 5DCX	5DCX 7DCX	>7DCX			
突出し量 Overhang																				
一般構造用鋼 Mild steels (200HB以下)	※ GX2140 JS4060 JS4045	n (min ⁻¹)	1,910	2,550	1,500	1,990	1,200	1,600	1,910	1,660	1,150	1,500	1,300	900	1,200	1,040	720			
		vc (m/min)	150	200	150	200	150	200	150	130	90	150	130	90	150	130	90			
		vf (mm/min)	3,820	6,120	3,000	5,970	3,600	7,200	4,590	3,320	1,840	5,400	3,900	2,160	5,760	4,160	2,310			
		fz (mm/t)	1.0	1.2	1.0	1.5	1.0	1.5	1.2	1.0	0.8	1.2	1.0	0.8	1.2	1.0	0.8			
		ap (mm)	1.0	0.8	1.2	1.0	1.2	1.0	0.8	0.5	0.3	0.8	0.5	0.3	0.8	0.5	0.3			
		ae (mm)	20	20	25	25	32	32	18	18	18	25	25	25	32	32	32			
Q (cm ³ /min)	76	98	90	149	138	230	66	30	10	108	49	16	147	67	22					
炭素鋼・合金鋼 Carbon steels Alloy steels (35HRC以下)	GX2140 JS4060 JS4045	n (min ⁻¹)	1,910	2,550	1,500	1,990	1,200	1,600	1,910	1,660	1,150	1,500	1,300	900	1,200	1,040	720			
		vc (m/min)	150	200	150	200	150	200	150	130	90	150	130	90	150	130	90			
		vf (mm/min)	3,820	6,120	3,000	5,970	3,600	7,200	4,590	3,320	1,840	5,400	3,900	2,160	5,760	4,160	2,310			
		fz (mm/t)	1.0	1.2	1.0	1.5	1.0	1.5	1.2	1.0	0.8	1.2	1.0	0.8	1.2	1.0	0.8			
		ap (mm)	1.0	0.8	1.2	1.0	1.2	1.0	0.8	0.5	0.3	0.8	0.5	0.3	0.8	0.5	0.3			
		ae (mm)	20	20	25	25	32	32	18	18	18	25	25	25	32	32	32			
Q (cm ³ /min)	76	98	90	149	138	230	66	30	10	108	49	16	147	67	22					
炭素鋼・合金鋼 Carbon steels Alloy steels (35~45HRC)	JP4120 JS4045 JS4060	n (min ⁻¹)	1,280	1,910	1,000	1,500	800	1,200	1,280	1,150	1,150	1,000	900	900	800	720	720			
		vc (m/min)	100	150	100	150	100	150	100	90	90	100	90	90	100	90	90			
		vf (mm/min)	2,050	3,060	1,600	2,400	1,920	2,880	2,050	1,380	1,150	2,400	1,620	1,350	2,560	1,730	1,440			
		fz (mm/t)	0.8	0.8	0.8	0.8	0.8	0.8	0.8	0.6	0.5	0.8	0.6	0.5	0.8	0.6	0.5			
		ap (mm)	1.0	0.8	1.2	1.0	1.2	1.0	0.8	0.5	0.3	0.8	0.5	0.3	0.8	0.5	0.3			
		ae (mm)	20	20	25	25	32	32	18	18	18	25	25	25	32	32	32			
Q (cm ³ /min)	41	49	48	60	74	92	30	12	6	48	20	10	66	28	14					
ステンレス鋼 Stainless steels SUS	JM4160	n (min ⁻¹)	1,280	2,550	1,000	1,990	800	1,600	1,280	1,280	1,150	1,000	1,000	900	800	800	720			
		vc (m/min)	100	200	100	200	100	200	100	100	90	100	100	90	100	100	90			
		vf (mm/min)	2,050	4,080	1,600	3,190	1,920	3,840	2,050	2,050	1,380	2,400	2,400	1,620	2,560	2,560	1,730			
		fz (mm/t)	0.8	0.8	0.8	0.8	0.8	0.8	0.8	0.8	0.6	0.8	0.8	0.6	0.8	0.8	0.6			
		ap (mm)	1.0	0.8	1.2	1.0	1.2	1.0	0.8	0.5	0.3	0.8	0.5	0.3	0.8	0.5	0.3			
		ae (mm)	20	20	25	25	32	32	18	18	18	25	25	25	32	32	32			
Q (cm ³ /min)	41	65	48	80	74	123	30	18	7	48	30	12	66	41	17					
鋳鉄 Cast irons FC, FCD	GX2140 JS4045 JP4120	n (min ⁻¹)	1,910	2,550	1,500	1,990	1,200	1,600	1,910	1,660	1,150	1,500	1,300	900	1,200	1,040	720			
		vc (m/min)	150	200	150	200	150	200	150	130	90	150	130	90	150	130	90			
		vf (mm/min)	5,730	7,650	4,500	5,970	5,400	7,200	5,350	3,990	2,300	6,300	4,680	2,700	6,720	5,000	2,880			
		fz (mm/t)	1.5	1.5	1.5	1.5	1.5	1.5	1.4	1.2	1.0	1.4	1.2	1.0	1.4	1.2	1.0			
		ap (mm)	1.0	0.8	1.2	1.0	1.2	1.0	1.0	0.8	0.6	1.0	0.8	0.6	1.0	0.8	0.6			
		ae (mm)	20	20	25	25	32	32	18	18	18	25	25	25	32	32	32			
Q (cm ³ /min)	115	122	135	149	207	230	96	57	25	158	94	41	215	128	55					
焼入れ鋼 Hardened steels Pre-Hardened steels (45~55HRC)	JP4120	n (min ⁻¹)	1,020	1,530	800	1,200	640	960	1,020	1,020	1,020	800	800	800	640	640	640			
		vc (m/min)	80	120	80	120	80	120	80	80	80	80	80	80	80	80	80			
		vf (mm/min)	410	620	320	480	390	580	410	410	410	480	480	480	520	520	520			
		fz (mm/t)	0.2	0.2	0.2	0.2	0.2	0.2	0.2	0.2	0.2	0.2	0.2	0.2	0.2	0.2	0.2			
		ap (mm)	1.0	0.8	1.2	1.0	1.2	1.0	0.8	0.5	0.3	0.8	0.5	0.3	0.8	0.5	0.3			
		ae (mm)	20	20	25	25	32	32	18	18	18	25	25	25	32	32	32			
Q (cm ³ /min)	8	10	10	12	15	19	6	4	2	10	6	4	13	8	5					
焼入れ鋼 Hardened steels (55~62HRC)	JP4105	n (min ⁻¹)	770	1,280	600	1,000	480	800	770	770	770	600	600	600	480	480	480			
		vc (m/min)	60	100	60	100	60	100	60	60	60	60	60	60	60	60	60			
		vf (mm/min)	80	130	60	100	80	120	80	80	80	90	90	90	100	100	100			
		fz (mm/t)	0.05	0.05	0.05	0.05	0.05	0.05	0.05	0.05	0.05	0.05	0.05	0.05	0.05	0.05	0.05			
		ap (mm)	0.5	0.5	0.5	0.5	0.5	0.5	0.5	0.5	0.3	0.5	0.5	0.3	0.5	0.5	0.3			
		ae (mm)	20	20	25	25	32	32	18	18	18	25	25	25	32	32	32			
Q (cm ³ /min)	1	1	1	1	1	2	1	1	0	1	1	1	2	2	1					

【注意】①本表は肩削り時の一般的な条件です。機械剛性やツーリング、加工物の状況に合わせて調整してください。特に、溝切削の伴う、またはそれに近い切り込み幅の加工などでびり振動が発生し、トラブルに至る場合がありますので下記を参考に調整してください。

・ブレーカ付きインサートを使用する。・回転数、テーブル送り量を50~70%下げる。・切り込み深さを50~70%下げる。

②GXコーティング、JSコーティングは通電式タッチセンサーに反応しませんのでご注意ください。

③「JP4105」は高硬度鋼専用材種で、生材には適しません。

④強断続切削、突出しが長い場合及び湿式切削には「JM4160」を推奨します。

⑤切りくず噛み込みによる工具損傷防止のため、必ずエアブロー等による切りくず除去を行ってください。

⑥排出した切りくずは、飛散し作業者を切傷させ、火傷あるいは目に入って負傷させる恐れがありますので、ご使用に際してはその周囲に安全カバーを取付け、保護メガネ等の保護具を着用し、安全な環境で作業されることをお願い致します。

⑦インサートの交換は早めに行い、過度の使用による破損を防止してください。

⑧下記に単位時間当たりの切りくず排出量Qを示します。

$$Q(\text{cm}^3/\text{min}) = a_p(\text{mm}) \times a_e(\text{mm}) \times v_f(\text{mm}/\text{min}) / 1000$$

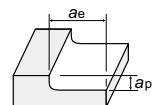

ボアタイプ Bore type																				被削材 Work material
φ50(4枚刃) 4 flutes					φ63(4枚刃) 4 flutes					φ80(5枚刃) 5 flutes					φ100(6枚刃) 6 flutes					
<3DCX		3DCX	5DCX	>7DCX	<3DCX		3DCX	5DCX	>7DCX	<3DCX		3DCX	5DCX	>7DCX	<3DCX		3DCX	5DCX	>7DCX	
汎用 General purpose	高速加工 High speed processing	5DCX	7DCX		汎用 General purpose	高速加工 High speed processing	5DCX	7DCX		汎用 General purpose	高速加工 High speed processing	5DCX	7DCX		汎用 General purpose	高速加工 High speed processing	5DCX	7DCX		
960	1,280	960	830	580	760	1,020	760	660	460	600	800	600	520	360	480	640	480	420	290	一般構造用鋼 Mild steels (200HB以下)
150	200	150	130	90	150	200	150	130	90	150	200	150	130	90	150	200	150	130	90	
5,760	7,680	5,760	4,980	3,480	4,560	6,120	4,560	3,960	2,760	4,500	6,000	4,500	3,900	2,700	4,320	5,760	4,320	3,780	2,610	
1.5	1.5	1.5	1.5	1.5	1.5	1.5	1.5	1.5	1.5	1.5	1.5	1.5	1.5	1.5	1.5	1.5	1.5	1.5	1.5	
1.5	1.25	1.0	0.7	0.7	1.5	1.25	1.0	0.7	0.7	1.5	1.25	1.0	0.7	0.7	1.5	1.25	1.0	0.7	0.7	
40	40	40	40	40	50	50	50	50	50	65	65	65	65	65	80	80	80	80	80	
346	384	230	139	97	342	383	228	139	97	439	488	293	177	123	518	576	346	212	146	
960	1,280	960	830	580	760	1,020	760	660	460	600	800	600	520	360	480	640	480	420	290	炭素鋼・合金鋼 Carbon steels Alloy steels (35HRC以下)
150	200	150	130	90	150	200	150	130	90	150	200	150	130	90	150	200	150	130	90	
5,760	7,680	5,760	4,980	3,480	4,560	6,120	4,560	3,960	2,760	4,500	6,000	4,500	3,900	2,700	4,320	5,760	4,320	3,780	2,610	
1.5	1.5	1.5	1.5	1.5	1.5	1.5	1.5	1.5	1.5	1.5	1.5	1.5	1.5	1.5	1.5	1.5	1.5	1.5	1.5	
1.5	1.25	1.0	0.7	0.7	1.5	1.25	1.0	0.7	0.7	1.5	1.25	1.0	0.7	0.7	1.5	1.25	1.0	0.7	0.7	
40	40	40	40	40	50	50	50	50	50	65	65	65	65	65	80	80	80	80	80	
346	384	230	139	97	342	383	228	139	97	439	488	293	177	123	518	576	346	212	146	
640	960	640	580	580	510	760	510	460	460	400	600	400	360	360	320	480	320	290	290	
100	150	100	90	90	100	150	100	90	90	100	150	100	90	90	100	150	100	90	90	炭素鋼・合金鋼 Carbon steels Alloy steels (35~45HRC)
2,050	3,080	2,050	1,860	1,860	1,640	2,440	1,640	1,480	1,480	1,600	2,400	1,600	1,440	1,440	1,540	2,310	1,540	1,400	1,400	
0.8	0.8	0.8	0.8	0.8	0.8	0.8	0.8	0.8	0.8	0.8	0.8	0.8	0.8	0.8	0.8	0.8	0.8	0.8	0.8	
1.5	1.5	1.0	0.7	0.7	1.5	1.5	1.0	0.7	0.7	1.5	1.5	1.0	0.7	0.7	1.5	1.5	1.0	0.7	0.7	
40	40	40	40	40	50	50	50	50	50	65	65	65	65	65	80	80	80	80	80	
123	185	82	52	52	123	183	82	52	52	156	234	104	66	66	185	277	123	78	78	
640	1,280	640	640	580	510	1,020	510	460	460	400	800	400	360	360	320	640	320	320	290	
100	200	100	100	90	100	200	100	100	90	100	200	100	100	90	100	200	100	100	90	
2,050	4,100	2,050	2,050	1,860	1,640	3,270	1,640	1,640	1,480	1,600	3,200	1,600	1,600	1,440	1,540	3,080	1,540	1,540	1,400	ステンレス鋼 Stainless steels SUS
0.8	0.8	0.8	0.8	0.8	0.8	0.8	0.8	0.8	0.8	0.8	0.8	0.8	0.8	0.8	0.8	0.8	0.8	0.8	0.8	
1.5	1.5	1.0	0.7	0.7	1.5	1.5	1.0	0.7	0.7	1.5	1.5	1.0	0.7	0.7	1.5	1.5	1.0	0.7	0.7	
40	40	40	40	40	50	50	50	50	50	65	65	65	65	65	80	80	80	80	80	
123	246	82	57	52	123	245	82	57	52	156	312	104	73	66	185	370	123	86	78	
960	1,280	960	830	580	760	1,020	760	660	460	600	800	600	520	360	480	640	480	420	290	鑄鉄 Cast irons FC, FCD
150	200	150	130	90	150	200	150	130	90	150	200	150	130	90	150	200	150	130	90	
5,760	7,680	5,760	4,980	3,480	6,080	8,160	6,080	3,960	2,760	6,000	8,000	6,000	3,900	2,700	5,760	7,680	5,760	3,780	2,610	
1.5	1.5	1.5	1.5	1.5	2.0	2.0	2.0	1.5	1.5	2.0	2.0	2.0	1.5	1.5	2.0	2.0	2.0	1.5	1.5	
1.5	1.5	1.5	1.0	0.7	1.5	1.5	1.5	1.0	0.7	1.5	1.5	1.5	1.0	0.7	1.5	1.5	1.5	1.0	0.7	
40	40	40	40	40	50	50	50	50	50	65	65	65	65	65	80	80	80	80	80	
346	461	346	199	97	456	612	456	198	97	585	780	585	254	123	691	922	691	302	146	
510	770	510	510	510	410	610	410	410	410	320	480	320	320	320	260	390	260	260	260	
80	120	80	80	80	80	120	80	80	80	80	120	80	80	80	80	120	80	80	80	
410	620	410	410	410	330	490	330	330	330	320	480	320	320	320	320	470	320	320	320	焼入れ鋼 Hardened steels Pre-Hardened steels (45~55HRC)
0.2	0.2	0.2	0.2	0.2	0.2	0.2	0.2	0.2	0.2	0.2	0.2	0.2	0.2	0.2	0.2	0.2	0.2	0.2	0.2	
1.5	1.5	1.0	0.7	0.7	1.5	1.5	1.0	0.7	0.7	1.5	1.5	1.0	0.7	0.7	1.5	1.5	1.0	0.7	0.7	
40	40	40	40	40	50	50	50	50	50	65	65	65	65	65	80	80	80	80	80	
25	37	16	11	11	25	37	17	12	12	31	47	21	15	15	38	56	26	18	18	
390	640	390	390	390	310	510	310	310	310	240	400	240	240	240	200	320	200	200	200	焼入れ鋼 Hardened steels (55~62HRC)
60	100	60	60	60	60	100	60	60	60	60	100	60	60	60	60	100	60	60	60	
80	130	80	80	80	70	110	70	70	70	60	100	60	60	60	60	100	60	60	60	
0.05	0.05	0.05	0.05	0.05	0.05	0.05	0.05	0.05	0.05	0.05	0.05	0.05	0.05	0.05	0.05	0.05	0.05	0.05	0.05	
0.5	0.5	0.5	0.5	0.5	0.5	0.5	0.5	0.5	0.5	0.5	0.5	0.5	0.5	0.5	0.5	0.5	0.5	0.5	0.5	
40	40	40	40	40	50	50	50	50	50	65	65	65	65	65	80	80	80	80	80	
2	3	2	2	2	2	3	2	2	2	2	3	2	2	2	2	4	2	2	2	

[Note] ① This table shows the general conditions for shoulder milling. The conditions should be adjusted according to the machine rigidity, tooling, condition of object to be milled, etc. In particular, when performing shoulder milling in combination with slotting or machining of cutting widths close to slots, etc., chattering vibrations may occur, which can lead to trouble. Therefore, please consider the following when adjusting the conditions:

② Use inserts equipped with breakers. ③ Reduce rotation speed and table feed rate by 50 to 70%. ④ Reduce cutting depth a_p by 50 to 70%.

⑤ Please note that the GX Coating and JS Coating do not cause a reaction in conductive touch sensors.

⑥ JP4105 is a special high-hardness steels, and is not suitable for Non-heat-treated steels material.

⑦ For strongly interrupted cutting, when unsupported length is long, or for wet cutting, JM4160 is recommended.

⑧ As a measure to prevent tool damage due to chip jamming, always use an air blower, etc. to remove chips.

⑨ Since there is a danger of the removed chips flying out and causing injury to workers, fire, or damage to eyes, during use be sure to cover the work area with a safety cover and have workers wear protective equipment such as glasses, etc. to make the work area safe.

⑩ Perform insert replacement at an early stage to prevent chipping due to excessive use.

⑪ The following equation expresses the chip removal amount per unit time:

$$Q(\text{cm}^3/\text{min.}) = a_p(\text{mm}) \times a_e(\text{mm}) \times v_f(\text{mm}/\text{min.})/1000$$

Radius Mill 4 Corners ASRF

アルファ高送りラジアスマル4コーナ ASRF

- ASRの4コーナタイプで経済的です。
 - 常識を超えた切削送り速度で、従来品に比較し3~5倍の深彫り加工ができ、加工時間短縮、加工費削減ができます。
 - インサートは独特のR形状で最大切込み深さは2mmです。
- ・ Economical ASR 4-corner type.
 ・ At higher-than-normal cutting feed rates, offers 3 to 5 times the deep-cutting of conventional products, reducing cutting time and processing costs.
 ・ Insert has a unique R shape to enable maximum cutting depth of 2mm.



ASRF 40 R シャンクタイプ Shank type

○は数字、□は英文字が入ります。
 Numeric figure in a circle ○ and Alphabetical character comes in a square □



Fig.1
 (一般形)
 (Standard type)

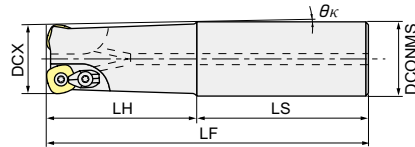
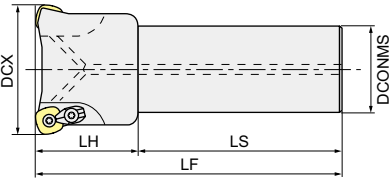

Fig.2
 (アンダーカット形)
 (Undercut type)



エア穴付き
 With air hole

商品コード Item code	在庫 Stock	刃数 No. of flutes	寸法 Size(mm)						形状 Shape	適用インサート Inserts	希望小売 価格(円) Suggested retail price (¥)
			DCX	LF	DCONMS	LH	LS	θ_k			
レギュラー Regular	●	2	32	150	32	70	80	—	Fig.1	SDNW1205ZDTN-R15 SDMT1205ZDTN-R15	45,170
	●	3	40	150	42	70	80	1.4°			51,620
	●	4	50	150	42	50	100	—	Fig.2		65,930
	●	4	63	150	42	50	100	—			70,970
ロング Long	●	2	32	200	32	120	80	—	Fig.1	47,640	
	●	3	40	220	42	120	100	0.6°		68,630	
	●	3	50	250	42	50	200	—	Fig.2	74,260	
	●	4	63	250	42	50	200	—		87,280	
エキストラロング Extra Long	●	2	32	300	32	180	120	—	Fig.1	62,060	
	●	2	40	300	42	180	120	0.4°		77,080	

●印：標準在庫品です。 ●：Stocked items.

○は数字が入ります。 Numeric figure in a circle ○

ASRF4○○○R(M)-○ ボアタイプ Bore type

ボアタイプ用アーバはD11頁を参照ください。
Refer page D11 about the bore type arbor

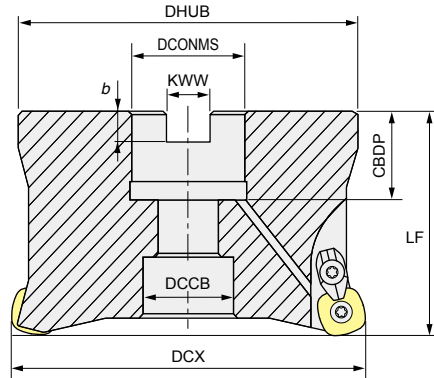

エア穴付き
With air hole

商品コード Item code	在庫 Stock	刃数 No. of flutes	寸法 Size(mm)								適用インサート Inserts	希望小売 価格(円) Suggested retail price (¥)	
			DCX	DHUB	LF	CBDP	KWW	b	DCONMS	DCCB			
ボアタイプ 内径インチ サイズ Internal diameter inch size	ASRF4050R-3	●	3	50	47	50	19	8.4	5	22.225	17	SDNW1205ZDTN-R15 SDMT1205ZDTN-R15	56,190
	ASRF4050R-4	●	4	50	47	50	19	8.4	5	22.225	17		68,400
	ASRF4063R-3	●	3	63	60	50	19	8.4	5	22.225	17		58,780
	ASRF4063R-4	●	4	63	60	50	19	8.4	5	22.225	17		71,100
	ASRF4080R-4	●	4	80	76	70	32	12.7	8	31.75	26		92,800
	ASRF4080R-5	●	5	80	76	70	32	12.7	8	31.75	26		107,810
	ASRF4100R-5	●	5	100	96	70	32	12.7	8	31.75	26		127,860
	ASRF4100R-6	●	6	100	96	70	32	12.7	8	31.75	26		145,460
ボアタイプ 内径ミリ サイズ Internal diameter mm size	ASRF4050RM-3	●	3	50	47	50	20	10.4	6.3	22	17		56,190
	ASRF4050RM-4	●	4	50	47	50	20	10.4	6.3	22	17		68,400
	ASRF4063RM-3	●	3	63	60	50	20	10.4	6.3	22	17		58,780
	ASRF4063RM-4	●	4	63	60	50	20	10.4	6.3	22	17		71,100
	ASRF4080RM-5	●	5	80	76	70	22	12.4	7	27	20		107,810
	ASRF4100RM-6	●	6	100	96	70	25.5	14.4	8	32	26		145,460

【注意】 アーバ用ねじは付属しません。 **【Note】** Arbor screw is not included.

■ インサート Inserts

○は数字が入ります。 Numeric figure in a circle ○

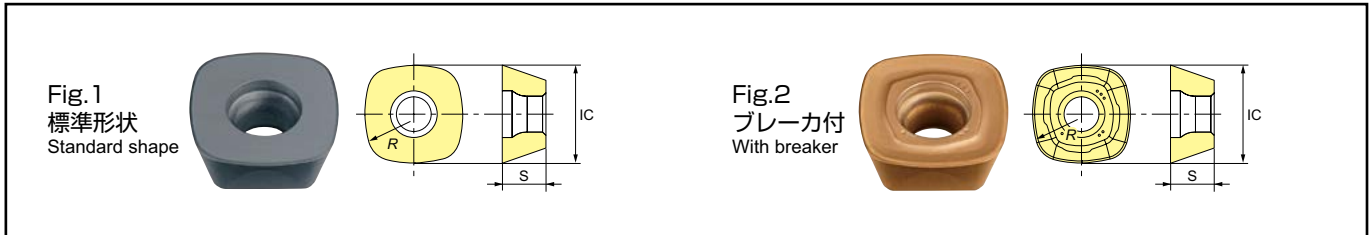

商品コード Item code	精度 Tolerance class	コーティング Coating					寸法 Size(mm)			形状 Shape	適用カッタ Cutter body	希望小売価格(円) Suggested retail price(¥)			
		AJ AJ Coating	GX GX Coating	JS JS Coating	C C Coating	R	S	IC	AJコーティング GXコーティング JSコーティング AJ, GX, JS Coating			CY250			
SDNW1205ZDTN-R15	N級 N	●	●	●	●	●	●	●	15	5.56	12.7	Fig.1	ASRF S/L/E 4○○○R	1,450	1,310
SDMT1205ZDTN-R15	M級 M	●	●	●	●	●	●	●				Fig.2	ASRF 4○○○R-○ ASRF 4○○○RM-○	1,450	1,310

【注意】 GXコーティング、JSコーティングは通電式タッチセンサーに反応しませんのでご注意ください。
 【Note】 Please note that the GX Coating and JS Coating do not cause a reaction in conductive touch sensors.

■ 部品番号 Parts

○は数字が入ります。 Numeric figure in a circle ○

部品名 Parts	クランプねじ Clamp screw		クランプ駒セット Clamp piece set		レンチ Wrench		ねじ焼き付き防止剤 Screw anti-seizure agent		
形状 Shape									
適用カッタ Cutter body	締付トルク fastening torque (N・m)	希望小売 価格(円) Suggested retail price (¥)	希望小売 価格(円) Suggested retail price (¥)	希望小売 価格(円) Suggested retail price (¥)	希望小売 価格(円) Suggested retail price (¥)	希望小売 価格(円) Suggested retail price (¥)	希望小売 価格(円) Suggested retail price (¥)	希望小売 価格(円) Suggested retail price (¥)	
ASRF S/L/E 4○○○R ASRF 4○○○R-○ ASRF 4○○○RM-○	262-142	2.9	870	CM4-141	2,030	105-T15	2,120	P-37	1,010

【注意】 クランプねじは消耗品です。使用環境により交換寿命は変化しますので早めの交換をお願い致します。クランプねじは予備が2本付属します。
 【Note】 The clamp screw is a consumable part. Since replacement life depends on the use environment, it is recommended that it be replaced at an early stage. Includes two spare clamp screws.

●印：標準在庫品です。 ●：Stocked items.

■ ダイレクトに彫り込み加工も可能 Cutting by direct milling is also possible.

- 中心まで切れ刃がないため傾斜角度と穴径は制限されますが、右図に示しますように傾斜切削やヘリカル切削にて、下穴がなくてもダイレクトに彫り込み加工が可能です。

Since the cutting flute do not extend to the center, the ramp angle and hole diameter were limited, but as shown below, cutting by direct milling without a pilot hole is possible by ramping and helical milling.

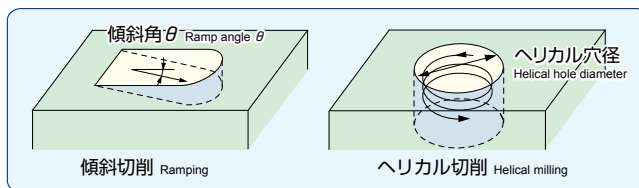

工具径DCX Tool dia.	φ32	φ40	φ50	φ63	φ80	φ100
最大傾斜角θ Maximum ramp angle θ	7°	4.5°	3°	1.7°	1°	1°
ヘリカル穴径 Hole Dia.	φ44~61	φ61~76	φ80~96	φ107~122	φ142~156	φ179~195

- [注意] ① 傾斜角θは上記範囲を超えない様に設定してください。1°以下での使用を推奨します。② 穴径が上記範囲以外の場合は下穴を開けて加工してください。
 [Note] ① The ramp angle θ should be set within the ranges listed above. Use at ramp angles of 1° or less is recommended. ② In case of hole diameters outside the ranges listed above, a pilot hole should be drilled before milling.

■ プログラム上の刃先形状定義方法 Method for defining conditions of insert tip programmatically

- 荒取り加工時は下記を参考に近似のコーナーRとしてプログラムを作成下さい。
 For roughing, please create a program with corner R values close to those shown as references below.

コーナーR4.5で設定した場合

When corner R is set to 4.5:

次工程の取り代 Surplus for next process
削り残し量 Remainder
最大0.83mm Maximum of 0.83mm

プログラミングR4.5 Programming R4.5

通常は近似インプットコーナーR4.5でプログラムを製作して下さい。近似インプットコーナーR4.5の場合食い込みは有りません。
Normally, you should create a program with an input corner R of approximately 4.5. At an approximate input corner R of 4.5, there is no overcutting.

コーナーRを大きく設定した場合

When corner R is set larger:

次工程の取り代 Surplus for next process
食い込み量 Over Cut
削り残し量 Remains

プログラミングR Programming R

近似Rを大きく設定する事で食い込みが発生しますが、食い込み量が次工程の取り代以内であれば加工形状には問題なく、削り残し量を少なく抑える事が出来ます。
Although overcutting occurs when the approximate R is set to higher values, if the overcutting is within the surplus for the next process, there is no problem with the cutting shape and the amount of remainder can be suppressed.

実際の加工面 Actual cutting surface
削り残し Remainder
θ₁
プログラム上の加工面 Cutting surface in program
θ₂

削り残し Remainder
θ₁
食い込み Overcutting
削り残し Remainder
θ₂

プログラミングR Programming R	R4.5	R5	R5.5	R6	R6.5
削り残し量 Remainder	0.83以下 0.83 or less (θ ₁ =22.1°)	0.69以下 0.69 or less (θ ₁ =20.6°)	0.55以下 0.55 or less (θ ₁ =19°)	0.42以下 0.42 or less (θ ₁ =17.1°)	0.3以下 0.3 or less (θ ₁ =14.9°)
食い込み量 Overcutting	なし No overcutting	0.07以下 0.07 or less (θ ₂ =75.3°)	0.2以下 0.2 or less (θ ₂ =67.7°)	0.37以下 0.37 or less (θ ₂ =63.1°)	0.55以下 0.55 or less (θ ₂ =60°)

- [注意] ① 食い込み、削り残し量は加工形状により異なります。上記表は各最大値を示します。
 ② θの値は、食い込み、削り残し量がそれぞれ最大になる時の、加工面の勾配を示します。
 [Note] ① Overcutting and remainder vary according to the processing shape. The values in the table above are maximum values.
 ② The values of θ shown are the slopes of the processing surfaces when overcutting and remainder are at their maximum respective values.

例えばプログラミングR5でプログラムを製作した場合

For example, when a program is created with an programming R of 5:

加工面の勾配が20.6°付近の所では0.69mm程度の削り残しが出て、加工面の勾配が75.3°付近の所では0.07mm程度の食い込みが発生します。これ以外の勾配の箇所ではそれぞれこの値以下の削り残し、食い込み量になります。

Remainder of around 0.69mm is left when the slope of the processing surface is approximately 20.6°, and when the slope of the cutting surface is approximately 75.3°, about 0.07mm of overcutting occurs. At areas with other slopes, the overcutting and remainder values are below these values.

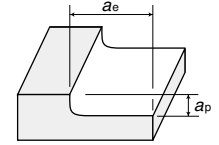

標準切削条件表 Recommended cutting conditions

※赤字は第一推奨材種です。Red indicates primary recommended grade.

被削材 Work material	推奨材種 Recommended grade	工具径DCX Tool dia.	φ32(2枚刃)2 flutes					φ40(3枚刃)3 flutes					φ50(4枚刃)4 flutes				
			<3DCX		3DCX	5DCX	>7DCX	<3DCX		3DCX	5DCX	>7DCX	<3DCX		3DCX	5DCX	>7DCX
			汎用 General purpose	高速加工 High speed processing	5DCX	7DCX		汎用 General purpose	高速加工 High speed processing	5DCX	7DCX		汎用 General purpose	高速加工 High speed processing	5DCX	7DCX	
突出し量 Overhang																	
一般構造用鋼 Mild steels (200HB以下)	※ GX2140 JS4060 JS4045	n (min ⁻¹)	1,490	1,990	1,490	1,290	900	1,190	1,590	1,190	1,030	720	950	1,270	950	830	570
		vc (m/min)	150	200	150	130	90	150	200	150	130	90	150	200	150	130	90
		vf (mm/min)	4,470	7,160	4,470	3,870	2,700	5,360	8,590	5,360	4,640	3,240	5,700	9,140	5,700	4,980	3,420
		fz (mm/t)	1.5	1.8	1.5	1.5	1.5	1.5	1.8	1.5	1.5	1.5	1.5	1.8	1.5	1.5	1.5
		ap (mm)	1.0	0.8	0.7	0.5	0.5	1.0	0.8	0.7	0.5	0.5	1.5	1.2	1.1	0.8	0.8
		ae (mm)	26	26	26	26	26	32	32	32	32	32	40	40	40	40	40
		Q (cm ³ /min)	116	149	81	50	35	172	220	120	74	52	342	439	251	159	109
炭素鋼・合金鋼 Carbon steels Alloy steels (35HRC以下)	GX2140 JS4060 JS4045	n (min ⁻¹)	1,490	1,990	1,490	1,290	900	1,190	1,590	1,190	1,030	720	950	1,270	950	830	570
		vc (m/min)	150	200	150	130	90	150	200	150	130	90	150	200	150	130	90
		vf (mm/min)	2,980	4,780	2,980	2,580	1,800	3,570	5,720	3,570	3,090	2,160	5,700	9,140	5,700	4,980	3,420
		fz (mm/t)	1.0	1.2	1.0	1.0	1.0	1.0	1.2	1.0	1.0	1.0	1.5	1.8	1.5	1.5	1.5
		ap (mm)	1.0	0.8	0.7	0.5	0.5	1.0	0.8	0.7	0.5	0.5	1.5	1.2	1.1	0.8	0.8
		ae (mm)	26	26	26	26	26	32	32	32	32	32	40	40	40	40	40
		Q (cm ³ /min)	77	99	54	34	23	114	146	80	49	35	342	439	251	159	109
炭素鋼・合金鋼 Carbon steels Alloy steels (35~45HRC)	JP4120 JS4045 JS4060	n (min ⁻¹)	900	1,190	900	780	540	720	950	720	620	430	570	760	570	500	340
		vc (m/min)	90	120	90	78	54	90	120	90	78	54	90	120	90	78	54
		vf (mm/min)	1,440	2,380	1,440	1,250	860	1,730	2,850	1,730	1,490	1,030	1,820	3,040	1,820	1,600	1,090
		fz (mm/t)	0.8	1.0	0.8	0.8	0.8	0.8	1.0	0.8	0.8	0.8	0.8	1.0	0.8	0.8	0.8
		ap (mm)	1.0	0.8	0.7	0.5	0.5	1.0	0.8	0.7	0.5	0.5	1.5	1.2	1.1	0.8	0.8
		ae (mm)	26	26	26	26	26	32	32	32	32	32	40	40	40	40	40
		Q (cm ³ /min)	37	50	26	16	11	55	73	39	24	16	109	146	80	51	35
ステンレス鋼 Stainless steels SUS	JM4160	n (min ⁻¹)	990	1,320	990	870	600	800	1,060	800	690	480	640	850	640	550	380
		vc (m/min)	100	133	100	87	60	100	133	100	87	60	100	133	100	87	60
		vf (mm/min)	1,580	2,640	1,580	1,390	960	1,920	3,180	1,920	1,660	1,150	2,050	3,400	2,050	1,760	1,220
		fz (mm/t)	0.8	1.0	0.8	0.8	0.8	0.8	1.0	0.8	0.8	0.8	0.8	1.0	0.8	0.8	0.8
		ap (mm)	1.2	1.0	0.8	0.6	0.6	1.2	1.0	0.8	0.6	0.6	1.5	1.2	1.1	0.8	0.8
		ae (mm)	26	26	26	26	26	32	32	32	32	32	40	40	40	40	40
		Q (cm ³ /min)	49	69	33	22	15	74	102	49	32	22	123	163	90	56	39
鋳鉄 Cast irons FC, FCD	GX2140 JS4045 JP4120	n (min ⁻¹)	1,490	1,990	1,490	1,290	900	1,190	1,590	1,190	1,030	720	950	1,270	950	830	570
		vc (m/min)	150	200	150	130	90	150	200	150	130	90	150	200	150	130	90
		vf (mm/min)	4,470	7,160	4,470	3,870	2,700	7,140	11,450	7,140	6,180	4,320	7,600	12,190	7,600	6,640	4,560
		fz (mm/t)	1.5	1.8	1.5	1.5	1.5	2.0	2.4	2.0	2.0	2.0	2.0	2.4	2.0	2.0	2.0
		ap (mm)	1.5	1.2	1.1	0.8	0.8	1.5	1.2	1.1	0.8	0.8	2.0	1.6	1.4	1.0	1.0
		ae (mm)	26	26	26	26	26	32	32	32	32	32	40	40	40	40	40
		Q (cm ³ /min)	174	223	128	80	56	343	440	251	158	111	608	780	426	266	182
焼入れ鋼 Hardened steels (45~55HRC)	JP4120	n (min ⁻¹)	900	1,190	900	780	540	720	950	720	620	430	570	760	570	500	340
		vc (m/min)	90	120	90	78	54	90	120	90	78	54	90	120	90	78	54
		vf (mm/min)	360	480	360	310	220	430	570	430	370	260	460	610	460	400	270
		fz (mm/t)	0.20	0.20	0.20	0.20	0.20	0.20	0.20	0.20	0.20	0.20	0.20	0.20	0.20	0.20	0.20
		ap (mm)	1.0	0.8	0.7	0.5	0.5	1.0	0.8	0.7	0.5	0.5	1.0	0.8	0.7	0.5	0.5
		ae (mm)	26	26	26	26	26	32	32	32	32	32	40	40	40	40	40
		Q (cm ³ /min)	9	10	7	4	3	14	15	10	6	4	18	20	13	8	5
焼入れ鋼 Hardened steels (55~60HRC)	JP4105	n (min ⁻¹)	600	800	600	520	360	480	640	480	410	290	380	510	380	330	230
		vc (m/min)	60	80	60	52	36	60	80	60	52	36	60	80	60	52	36
		vf (mm/min)	60	160	120	100	70	70	190	140	120	90	80	200	150	130	90
		fz (mm/t)	0.05	0.10	0.10	0.10	0.10	0.05	0.10	0.10	0.10	0.10	0.05	0.10	0.10	0.10	0.10
		ap (mm)	0.5	0.4	0.4	0.3	0.3	0.5	0.4	0.4	0.3	0.3	0.5	0.4	0.4	0.3	0.3
		ae (mm)	26	26	26	26	26	32	32	32	32	32	40	40	40	40	40
		Q (cm ³ /min)	1	2	1	1	1	1	2	2	1	1	2	3	2	2	1

【注意】

- この切削条件表は切削条件の目安を示すものです。実際の加工では加工形状、目的、使用機械等により条件を調整してください。
(切削速度は突出し長さ3D以下の場合、vc=180~200m/min、突出し長さ3DCX以上の場合、vc=90~130m/minを目安にご使用ください。)
- GXコーティング、JSコーティングは通電式タッチセンサーに反応しませんのでご注意ください。
- 「JP4105」は高硬度鋼専用材種で、生材には適しません。
- 強断続切削、突出しが長い場合及び湿式切削には「JM4160」を推奨します。
- この工具は、厚く重い切りくずが排出されます。よって、切りくず噛み込みによる工具損傷防止のため、必ずエアによる切りくず除去を行ってください。
エアの掛けかたは、スピンドル・センタスルー方式を推奨します。(縦型マシニングセンタによるキャビティ加工時の切りくず処理には、十分ご注意ください)
- 無人加工の場合、事前に十分な切りくず排除を行い、安定な切削が可能であることを確認のうえ、使用することをお勧めいたします。
- 排出した切りくずは、飛散し作業者を切傷させ、火傷あるいは目に入って負傷させる恐れがありますので、ご使用に際してはその周囲に安全カバーを取付け、保護めがね等の保護具を着用して、安全な環境で作業されることをお願い致します。
- インサートの交換は、早めに行い過度の使用による破損を防止してください。
- 下記に単位時間当たりの切りくず排出量Qを示します。
Q(cm³/min)=ap(mm)×ae(mm)×vf(mm/min)/1000

被削材 Work material	推奨材種 Recommended grade	工具径DCX Tool dia.	φ63(4枚刃)4 flutes					φ80(5枚刃)5 flutes					φ100(6枚刃)6 flutes								
			突出し量 Overhang		汎用 General purpose	高速加工 High speed processing	3DCX 5DCX	5DCX 7DCX	>7DCX	汎用 General purpose		高速加工 High speed processing	3DCX 5DCX	5DCX 7DCX	>7DCX	汎用 General purpose		高速加工 High speed processing	3DCX 5DCX	5DCX 7DCX	>7DCX
			汎用 General purpose	高速加工 High speed processing						汎用 General purpose	高速加工 High speed processing					汎用 General purpose	高速加工 High speed processing				
一般構造用鋼 Mild steels (200HB以下)	※ GX2140 JS4060 JS4045	n (min ⁻¹)	760	1,010	760	660	450	600	800	600	520	360	480	640	480	410	290				
		vc (m/min)	150	200	150	130	90	150	200	150	130	90	150	200	150	130	90				
		vf (mm/min)	4,560	7,270	4,560	3,960	2,700	4,500	7,200	4,500	3,900	2,700	4,320	6,910	4,320	3,690	2,610				
		fz (mm/t)	1.5	1.8	1.5	1.5	1.5	1.5	1.8	1.5	1.5	1.5	1.5	1.8	1.5	1.5	1.5				
		ap (mm)	1.5	1.2	1.1	0.8	0.8	1.5	1.2	1.1	0.8	0.8	1.5	1.2	1.1	0.8	0.8				
		ae (mm)	50	50	50	50	50	64	64	64	64	64	80	80	80	80	80				
		Q (cm ³ /min)	342	436	251	158	108	432	553	317	200	138	518	663	380	236	167				
炭素鋼・合金鋼 Carbon steels Alloy steels (35HRC以下)	GX2140 JS4060 JS4045	n (min ⁻¹)	760	1,010	760	660	450	600	800	600	520	360	480	640	480	410	290				
		vc (m/min)	150	200	150	130	90	150	200	150	130	90	150	200	150	130	90				
		vf (mm/min)	4,560	7,270	4,560	3,960	2,700	4,500	7,200	4,500	3,900	2,700	4,320	6,910	4,320	3,690	2,610				
		fz (mm/t)	1.5	1.8	1.5	1.5	1.5	1.5	1.8	1.5	1.5	1.5	1.5	1.8	1.5	1.5	1.5				
		ap (mm)	1.5	1.2	1.1	0.8	0.8	1.5	1.2	1.1	0.8	0.8	1.5	1.2	1.1	0.8	0.8				
		ae (mm)	50	50	50	50	50	64	64	64	64	64	80	80	80	80	80				
		Q (cm ³ /min)	342	436	251	158	108	432	553	317	200	138	518	663	380	236	167				
炭素鋼・合金鋼 Carbon steels Alloy steels (35~45HRC)	JP4120 JS4045 JS4060	n (min ⁻¹)	450	610	450	390	270	360	480	360	310	210	290	380	290	220	170				
		vc (m/min)	90	120	90	78	54	90	120	90	78	54	90	120	90	68	54				
		vf (mm/min)	1,440	2,440	1,440	1,250	860	1,440	2,400	1,440	1,240	840	1,390	2,280	1,390	1,060	820				
		fz (mm/t)	0.8	1.0	0.8	0.8	0.8	0.8	1.0	0.8	0.8	0.8	0.8	1.0	0.8	0.8	0.8				
		ap (mm)	1.5	1.2	1.1	0.8	0.8	1.5	1.2	1.1	0.8	0.8	1.5	1.2	1.1	0.8	0.8				
		ae (mm)	50	50	50	50	50	64	64	64	64	64	80	80	80	80	80				
		Q (cm ³ /min)	108	146	79	50	34	138	184	101	63	43	167	219	122	68	52				
ステンレス鋼 Stainless steels SUS	JM4160	n (min ⁻¹)	510	670	510	440	300	400	530	400	350	240	320	420	320	280	190				
		vc (m/min)	100	133	100	87	60	100	133	100	87	60	100	133	100	87	60				
		vf (mm/min)	1,630	2,680	1,630	1,410	960	1,600	2,650	1,600	1,400	960	1,540	2,520	1,540	1,340	910				
		fz (mm/t)	0.8	1.0	0.8	0.8	0.8	0.8	1.0	0.8	0.8	0.8	0.8	1.0	0.8	0.8	0.8				
		ap (mm)	1.5	1.2	1.1	0.8	0.8	1.5	1.2	1.1	0.8	0.8	1.5	1.2	1.1	0.8	0.8				
		ae (mm)	50	50	50	50	50	64	64	64	64	64	80	80	80	80	80				
		Q (cm ³ /min)	122	161	90	56	38	154	204	113	72	49	185	242	136	86	58				
鋳鉄 Cast irons FC, FCD	GX2140 JS4045 JP4120	n (min ⁻¹)	760	1,010	760	660	450	600	800	600	520	360	480	640	480	410	290				
		vc (m/min)	150	200	150	130	90	150	200	150	130	90	150	200	150	130	90				
		vf (mm/min)	6,080	9,700	6,080	5,280	3,600	6,000	9,600	6,000	5,200	3,600	5,760	9,220	5,760	4,920	3,480				
		fz (mm/t)	2.0	2.4	2.0	2.0	2.0	2.0	2.4	2.0	2.0	2.0	2.0	2.4	2.0	2.0	2.0				
		ap (mm)	2.0	1.6	1.4	1.0	1.0	2.0	1.6	1.4	1.0	1.0	2.0	1.6	1.4	1.0	1.0				
		ae (mm)	50	50	50	50	50	64	64	64	64	64	80	80	80	80	80				
		Q (cm ³ /min)	608	776	426	264	180	768	983	538	333	230	922	1180	645	394	278				
焼入れ鋼 Hardened steels (45~55HRC)	JP4120	n (min ⁻¹)	450	610	450	390	270	360	480	360	310	210	290	380	290	250	170				
		vc (m/min)	90	120	90	78	54	90	120	90	78	54	90	120	90	78	54				
		vf (mm/min)	360	490	360	310	220	360	480	360	310	210	350	460	350	300	200				
		fz (mm/t)	0.20	0.20	0.20	0.20	0.20	0.20	0.20	0.20	0.20	0.20	0.20	0.20	0.20	0.20	0.20				
		ap (mm)	1.0	0.8	0.7	0.5	0.5	1.0	0.8	0.7	0.5	0.5	1.0	0.8	0.7	0.5	0.5				
		ae (mm)	50	50	50	50	50	64	64	64	64	64	80	80	80	80	80				
		Q (cm ³ /min)	18	20	13	8	6	23	25	16	10	7	28	29	20	12	8				
焼入れ鋼 Hardened steels (55~60HRC)	JP4105	n (min ⁻¹)	300	400	300	260	180	240	320	240	210	140	190	250	190	170	110				
		vc (m/min)	60	80	60	52	36	60	80	60	52	36	60	80	60	52	36				
		vf (mm/min)	60	160	120	100	70	60	160	120	110	70	60	150	110	100	70				
		fz (mm/t)	0.05	0.10	0.10	0.10	0.10	0.05	0.10	0.10	0.10	0.10	0.05	0.10	0.10	0.10	0.10				
		ap (mm)	0.5	0.4	0.4	0.3	0.3	0.5	0.4	0.4	0.3	0.3	0.5	0.4	0.4	0.3	0.3				
		ae (mm)	50	50	50	50	50	64	64	64	64	64	80	80	80	80	80				
		Q (cm ³ /min)	2	3	2	2	1	2	4	3	2	1	2	5	4	2	2				

[Note]

- These conditions are for general guidance; in actual machining conditions adjust the parameters according to your actual machine and work-piece conditions.
(If the overhang is 3D or less, the recommended cutting speed is $v_c=180\sim200$ m/min; 3DCX or more: $v_c=90\sim130$ m/min.)
- Please note that the GX Coating and JS Coating do not cause a reaction in conductive touch sensors.
- [JP4105] insert's grade specialized in High hardened steels is not suitable for Non-heat-treated steel material.
- For strongly interrupted cutting, when unsupported length is long, or for wet cutting, JM4160 is recommended.
- The thick and heavy chips are generated by using this tool. Be sure to remove them with air blow in order to avoid any breakage by blocking with chips.
The recommended method is "Spindle center through" when blowing air. (Pay attention when removing chips in cavity work with the machining center <vertical type>.)
- Before carrying out the work without any workers, be sure to remove the chips and confirm the safe condition for cutting.
- The steel chips may cause cuts, burns or damages to eyes. Be sure to install the safety cover around the tool and wear the safety glasses when carrying out any works.
- Replace the insert in good time to avoid any breakage of the tools because of wear and tear.
- The following formula shows the metal removal rate (Q) per unit time.
 $Q(\text{cm}^3/\text{min})=a_p(\text{mm})\times a_e(\text{mm})\times v_f(\text{mm}/\text{min})/1000$

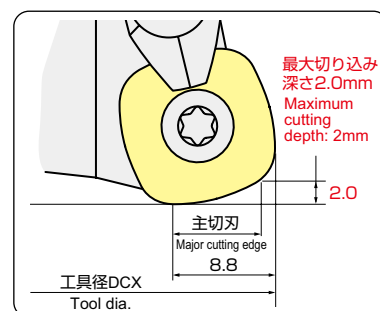

Radius Mill 4 Corners ASRF mini

アルファ高送りラジアスマイル4コーナ ASRF mini

- 高送り加工の切削抵抗低減とコスト低減に新提案。
- 経済性に優れた4コーナタイプインサート。
3種のブレーカ形状で、用途に合わせてインサート選定が可能。
- ・ New proposal to reduce cost and cutting force during high-feed-rate processing
- ・ The economical four corner inserts.
- ・ Three kinds of breaker can be selected according to applications.

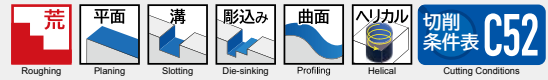

ASRF 30 R- シャンクタイプ Shank type

○は数字、□は英文字が入ります。
Numeric figure in a circle ○ and Alphabetical character comes in a square □

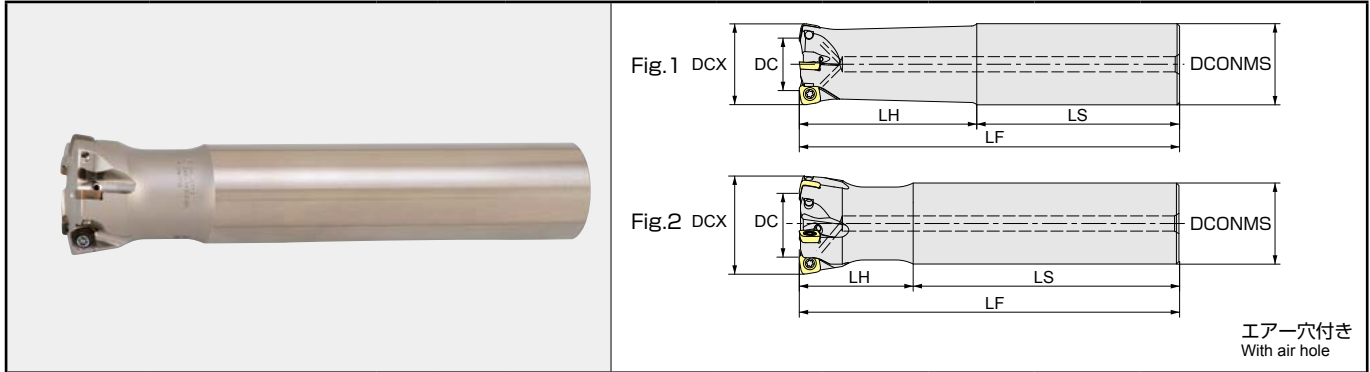

商品コード Item code	在庫 Stock	刃数 No. of flutes	寸法 Size (mm)							形状 Shape	希望小売 価格(円) Suggested retail price (¥)
			DCX	DC	LF	LH	LS	DCONMS			
レギュラー Regular	ASRFS3020R-2	●	2	20	8	130	50	80	20	Fig.1	31,800
	ASRFS3025R-3	●	3	25	13	140	60	80	25	Fig.1	35,550
	ASRFS3032R-4	●	4	32	20	150	70	80	32	Fig.1	42,700
	ASRFS3040R-5	●	5	40	28	150	45	105	32	Fig.2	46,110
ロング Long	ASRFL3020R-2	●	2	20	8	160	80	80	20	Fig.1	35,080
	ASRFL3022R-2	●	2	22	10	160	30	130	20	Fig.2	35,080
	ASRFL3025R-3	●	3	25	13	180	100	80	25	Fig.1	46,110
	ASRFL3028R-3	●	3	28	16	180	35	145	25	Fig.2	46,110
	ASRFL3032R-3	●	3	32	20	200	120	80	32	Fig.1	54,090
	ASRFL3035R-3	●	3	35	23	200	40	160	32	Fig.2	54,090
ASRFL3040R-3	●	3	40	28	220	45	175	32	Fig.2	62,300	

ASRFB30 R(M)- () ボアタイプ Bore type

○は数字が入ります。 Numeric figure in a circle ○
ボアタイプ用アーバはD11頁を参照ください。
Refer page D11 about the bore type arbor

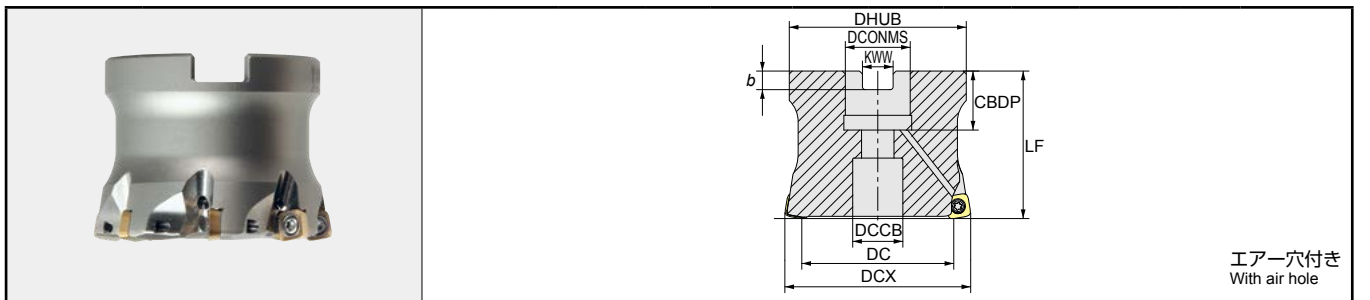

商品コード Item code	在庫 Stock	刃数 No. of flutes	寸法 Size (mm)										希望小売 価格(円) Suggested retail price (¥)
			DCX	DC	DHUB	LF	CBDP	KWW	b	DCONMS	DCCB		
内径インチ サイズ Internal diameter inch size	ASRFB3050R-7	●	7	50	38	47	50	19	8.4	5	22.225	17	75,550
	ASRFB3063R-8	●	8	63	51	60	50	19	8.4	5	22.225	20	80,710
内径ミリ サイズ Internal diameter mm size	ASRFB3040RM-5-16	●	5	40	28	35	40	19	8.4	5.6	16	13.5	62,760
	ASRFB3050RM-7-22	●	7	50	38	40	50	20	10.4	6.3	22	17	75,550
	ASRFB3063RM-8-22	●	8	63	51	60	50	20	10.4	6.3	22	17	80,710
	ASRFB3063RM-8-27	●	8	63	51	60	50	22	12.4	7	27	20	80,710

●印：標準在庫品です。 ●： Stocked items. 無印：弊社営業へお問合せください。 No mark： Contact with our sales department.

○は数字が入ります。 Numeric figure in a circle ○

ASRFM30○○R-○-M1○ モジュラータイプ Modular type

モジュラーミル用シャンクはD2頁を、締め付けトルクについてはD5頁を参照ください。
Refer page D2 about the shanks for Modular Mill, Refer page D5 about tightening torque

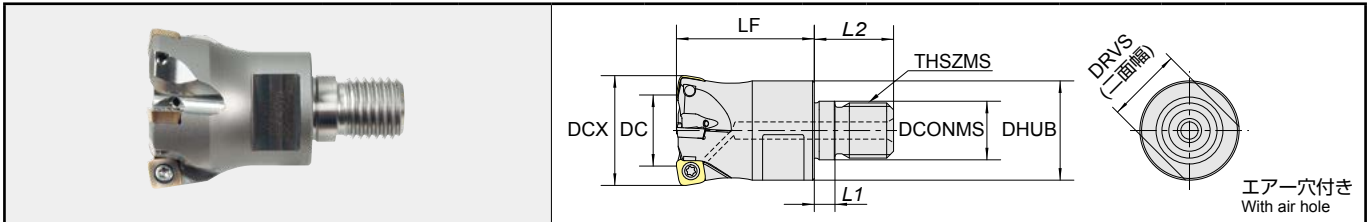

商品コード Item code	在庫 Stock	刃数 No. of flutes	寸法 Size (mm)									希望小売 価格(円) Suggested retail price (¥)
			DCX	DC	LF	L1	L2	DCONMS	DHUB	THSZMS	DRVS	
ASRFM3020R-2-M10	●	2	20	8	30	5.5	19	10.5	17.8	M10	15	31,800
※ ASRFM3022R-2-M10	●	2	22	10	30	5.5	19	10.5	17.8	M10	15	31,800
ASRFM3025R-3-M12	●	3	25	13	35	5.5	22	12.5	20.8	M12	17	35,550
※ ASRFM3028R-3-M12	●	3	28	16	35	5.5	22	12.5	20.8	M12	17	35,550
ASRFM3032R-4-M16	●	4	32	20	40	6	23	17	28.8	M16	22	42,700
※ ASRFM3035R-4-M16	●	4	35	23	40	6	23	17	28.8	M16	22	42,700
※ ASRFM3040R-5-M16	●	5	40	28	40	6	23	17	28.8	M16	22	46,110

【注意】 ※と超硬シャンクをセットで使用すると干渉がありません。モジュラーミル及び専用シャンク、専用アークの「工具端面」「モジュラーねじ部」にグリースなどの潤滑剤は塗布しないでください。
【Note】 When ※ and carbide shank are used together as a set, there is no interference.
Do not apply lubricants such as grease, etc. to the "contact faces" and "modular screws" of the "modular mill", "dedicated shanks" and "dedicated arbor".

■ インサート Inserts

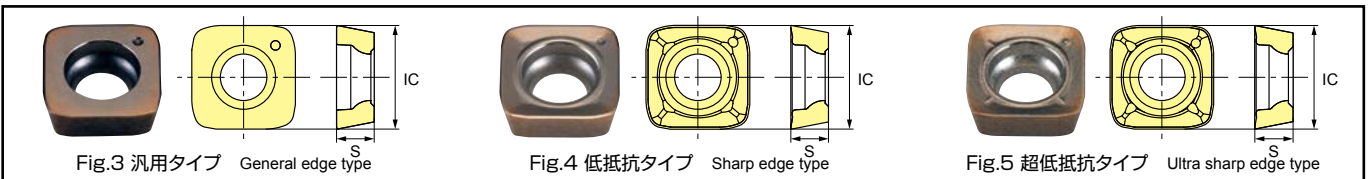

商品コード Item code	精度 Tolerance class	AJコーティング AJ Coating					GXコーティング GX Coating	JSコーティング JS Coating	寸法 Size (mm)		形状 Shape	希望小売価格(円) Suggested retail price(¥)
		JP4105	JP4120	JM4160	GX2140	JS4045			IC	S		
SPNW07T2TR	N級 N	●	●	●	●	●	●	7.8	2.8	Fig.3	910	
SPMT07T2TR	M級 M		●	●		●		7.8	2.8	Fig.4	910	
SPMT07T2ER-LF			●※1	●				7.8	2.8	Fig.5	910	

【注意】 GXコーティング、JSコーティングは通電式タッチセンサーに反応しませんのでご注意ください。
【Note】 Please note that the GX Coating and JS Coating do not cause a reaction in conductive touch sensors.
※1 M: SUS等、S: チタン合金・Ni基超耐熱合金等の切削にも対応します。Cutting of M (SUS, etc.) and S (titanium alloys, Ni-based alloys).

○ コーナチェンジ時のお願い Attention for the corner change

- コーナチェンジを行う際には、インサートを反時計回りに回転させてください。
Please turn the insert counterclockwise upon corner change of insert.



■ 部品番号 Parts

部品名 Parts	クランプねじ Clamp screw		ドライバー Screw driver		ねじ焼き付き防止剤 Screw anti-seizure agent	
形状 Shape						
適用カット Cutter body	265-143	締付トルク Fastening torque (N・m) 2.0	希望小売価格(円) Suggested retail price (¥) 870	希望小売価格(円) Suggested retail price (¥) 1,920	P-37	希望小売価格(円) Suggested retail price (¥) 1,010
ASRF S/L/M/B30...	265-143	2.0	870	1,920	P-37	1,010

標準切削条件表 Recommended cutting conditions

※赤字は第1推奨材種です。Red indicates primary recommended insert grade.

被削材 Work material	推奨材種 Recommended inserts grade	工具径 DCX Tool dia.	φ 20		φ 25		φ 32		φ 40		φ 40	φ 50	φ 63		
		タイプ Type	レギュラー Regular	ロング Long	レギュラー Regular	ロング Long	レギュラー Regular	ロング Long	レギュラー Regular	ロング Long	レギュラー Regular	ロング Long	ボア Bore	ボア Bore	ボア Bore
		刃数 flutes	2	2	3	3	4	3	5	3	5	7	8		
炭素鋼・合金鋼 <30HRC Carbon steels Alloy steels	※ GX2140 JS4045	n (min ⁻¹)	2710	2390	2170	1910	1690	1490	1350	1190	1350	1080	860		
		Vc(m/min)	170	150	170	150	170	150	170	150	170	170	170		
		Vf(mm/min)	7040	6210	8460	7440	8780	5810	8770	4640	8770	9820	8940		
		fz(mm/t)	1.3	1.3	1.3	1.3	1.3	1.3	1.3	1.3	1.3	1.3	1.3		
		ap(mm)	0.8	0.6	0.8	0.6	0.8	0.6	0.8	0.6	0.8	0.8	0.8		
		ae(mm)	12	12	15	15	20	20	24	24	24	30	38		
		Q (cm ³ /min)	68	45	102	67	140	70	168	67	168	236	272		
合金鋼・工具鋼 30~40HRC Alloy steels Tool steels	JS4045 JP4120	n (min ⁻¹)	2390	2070	1910	1660	1490	1290	1190	1040	1190	960	760		
		Vc(m/min)	150	130	150	130	150	130	150	130	150	150	150		
		Vf(mm/min)	5730	4960	6870	5970	7150	4640	7140	3740	7140	8060	7290		
		fz(mm/t)	1.2	1.2	1.2	1.2	1.2	1.2	1.2	1.2	1.2	1.2	1.2		
		ap(mm)	0.8	0.6	0.8	0.6	0.8	0.6	0.8	0.6	0.8	0.8	0.8		
		ae(mm)	12	12	15	15	20	20	24	24	24	30	38		
		Q (cm ³ /min)	55	36	82	54	114	56	137	54	137	193	222		
プリハードン鋼 40~50HRC Pre-Hardened steels	JP4120 JS4045	n (min ⁻¹)	1590	1430	1270	1150	1000	900	800	720	800	640	510		
		Vc(m/min)	100	90	100	90	100	90	100	90	100	100	100		
		Vf(mm/min)	3810	2860	4570	3450	4800	2700	4800	2160	4800	5370	4890		
		fz(mm/t)	1.2	1	1.2	1	1.2	1	1.2	1	1.2	1.2	1.2		
		ap(mm)	0.5	0.4	0.5	0.4	0.5	0.4	0.5	0.4	0.5	0.5	0.5		
		ae(mm)	12	12	15	15	20	20	24	24	24	30	38		
		Q (cm ³ /min)	23	14	34	21	48	22	58	21	58	81	93		
ステンレス鋼 Stainless steels	JM4160	n (min ⁻¹)	1590	1430	1270	1150	1000	900	800	720	800	640	510		
		Vc(m/min)	100	90	100	90	100	90	100	90	100	100	100		
		Vf(mm/min)	3180	2280	3810	2760	4000	2160	4000	1720	4000	4480	4080		
		fz(mm/t)	1	0.8	1	0.8	1	0.8	1	0.8	1	1	1		
		ap(mm)	0.8	0.5	0.8	0.5	0.8	0.5	0.8	0.5	0.8	0.8	0.8		
		ae(mm)	12	12	15	15	20	20	24	24	24	30	38		
		Q (cm ³ /min)	31	14	46	21	64	22	77	21	77	108	124		
鋳鉄 Cast irons	JP4120 GX2140	n (min ⁻¹)	3180	2870	2550	2290	1990	1790	1590	1430	1590	1270	1010		
		Vc(m/min)	200	180	200	180	200	180	200	180	200	200	200		
		Vf(mm/min)	9540	6880	11470	8240	11940	6440	11920	5140	11920	13330	12120		
		fz(mm/t)	1.5	1.2	1.5	1.2	1.5	1.2	1.5	1.2	1.5	1.5	1.5		
		ap(mm)	0.8	0.6	0.8	0.6	0.8	0.6	0.8	0.6	0.8	0.8	0.8		
		ae(mm)	12	12	15	15	20	20	24	24	24	30	38		
		Q (cm ³ /min)	92	50	138	74	191	77	229	74	229	320	368		
高硬度鋼 50~55HRC High-Hardened steels	JP4105 JP4120	n (min ⁻¹)	1270	1110	1020	890	800	700	640	560	640	510	400		
		Vc(m/min)	80	70	80	70	80	70	80	70	80	80	80		
		Vf(mm/min)	1520	1110	1830	1330	1920	1050	1920	840	1920	2140	1920		
		fz(mm/t)	0.6	0.5	0.6	0.5	0.6	0.5	0.6	0.5	0.6	0.6	0.6		
		ap(mm)	0.5	0.3	0.5	0.3	0.5	0.3	0.5	0.3	0.5	0.5	0.5		
		ae(mm)	12	12	15	15	20	20	24	24	24	30	38		
		Q (cm ³ /min)	9	4	14	6	19	6	23	6	23	32	36		
高硬度鋼 55~62HRC High-Hardened steels	JP4105	n (min ⁻¹)	1040	960	830	760	650	600	520	480	520	410	330		
		Vc(m/min)	65	60	65	60	65	60	65	60	65	65	65		
		Vf(mm/min)	~ 830	~ 670	~ 990	~ 790	~ 1040	~ 630	~ 1040	~ 500	~ 1040	~ 1140	~ 1050		
		fz(mm/t)	~ 0.4	~ 0.35	~ 0.4	~ 0.35	~ 0.4	~ 0.35	~ 0.4	~ 0.35	~ 0.4	~ 0.4	~ 0.4		
		ap(mm)	~ 0.3	~ 0.2	~ 0.3	~ 0.2	~ 0.3	~ 0.2	~ 0.3	~ 0.2	~ 0.3	~ 0.3	~ 0.3		
		ae(mm)	10	10	12	12	16	16	20	20	20	25	32		
		Q (cm ³ /min)	~ 2	~ 1	~ 4	~ 2	~ 5	~ 2	~ 6	~ 2	~ 6	~ 9	~ 10		

※この切削条件表は、L/D=3未満での切削条件の目安を示すものです。実際の加工では加工形状、目的、使用機械等により条件を調整してください。

This cutting condition table shows general guidelines for cutting conditions when L/D < 3. When performing actual machining, adjust the cutting conditions according to the shape to be machined, purpose, machine being used, etc.

- [注意]**
1. 無人加工の場合、事前に十分な切りくず排除を行い、異常な振動がないことを確認のうえ、使用することをお勧めいたします。
 2. 排出した切りくずは、飛散し作業者を切傷させ、火傷あるいは目に入って負傷させる恐れがありますので、ご使用に際してはその周囲に安全カバーを取付け、保護メガネ等の保護具を着用して、安全な環境で作業されることをお願い致します。
 3. [JP4105]は高硬度鋼専用材種で、生材には適しません。
 4. 焼入れ鋼(55~62HRC)は、鋼種や工具突き出し量によって被削性が大きく異なる場合があります。加工状況に合わせて、テーブル送り量と切込み深さapを調整してください。
 5. 強断続切削、突出しが長い場合及び湿式切削には「JM4160」を推奨します。
 6. GXコーティング、JSコーティングは通電式タッチセンサーに反応しませんのでご注意ください。
 7. インサートの交換は、早めに行い過度の使用による破損を防止してください。

- [Note]**
1. Before carrying out the work without operator, be sure to remove the chips and confirm the safe condition for cutting.
 2. The steel chips may cause cuts, burns or damages to eyes. Be sure to install the safety cover around the tool and wear the safety glasses when carrying out any works.
 3. JP4105 is for the high-hardness steels. It is not suitable for Non-heat-treated steel material.
 4. The machinability of hardened steels (55 - 62HRC) can vary significantly depending on the particular steel type and tool overhang. Adjust the table feed rate and cutting depth ap to suit machining conditions.
 5. For strongly interrupted cutting, when unsupported length is long, or for wet cutting, JM4160 is recommended.
 6. Please note that the GX Coating and JS Coating do not cause a reaction in conductive touch sensors.
 7. Replace the insert in good time to avoid any breakage of the tools because of wear and tear.

●傾斜切削とヘリカル加工径について Regarding ramping and helical milling diameter

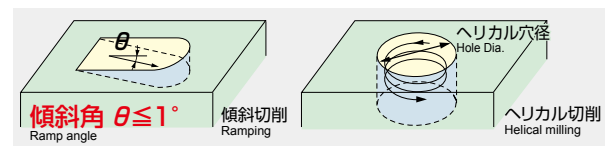

工具径 DCX Tool dia.	φ20	φ25	φ32	φ40	φ50	φ63
傾斜角θ Ramp angle	1°以下 or less					
ヘリカル穴径 Hole diameter	26~38	36~48	50~62	66~78	86~98	112~124

穴径が上記範囲外の場合は下穴をあけて加工してください。
For hole diameters outside the ranges listed above, a pilot hole should be drilled before milling.

●加工プログラム作成上の注意点

Points requiring care when creating the machining program

- ・ R2.0のラジウス形状として工具定義してください。
- ・ 軸方向切込み a_p は1.2mm以下でご使用ください。
- ・ Define the tool as the shape of the R2.0 radius.
- ・ Use with axial-direction cutting depths a_p of 1.2mm or less.

プログラミング R Programming R	削り残し量 (mm) Remainder	食い込み量 (mm) Over Cut
R2.0	0.62	0
R2.8	0.5	0.17
R3.0	0.47	0.23

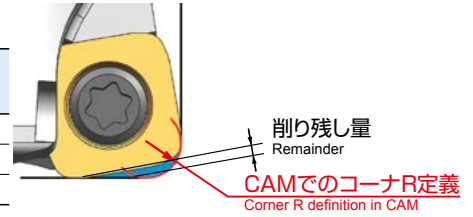

■テクノロジー Technology

1. 工具寿命に影響を及ぼすクランプ剛性改善

Improvements in clamp rigidity, which affects tool life.

- インサート固定ねじのサイズアップ
 - ・ Size of insert holding screw was increased.
- ホルダとの接触面積拡大
 - ・ Larger contact surface with holder.

ホルダ接触面拡大によるクランプ剛性UP
Broader holder contact surface increases clamp rigidity.

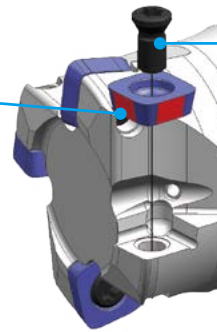

ねじ強度UP
M2.5→M3.0
Increased screw strength:
M2.5 → M3.0

2. 使用用途により使い分けができる3種類の形状

3 types of shapes to select from according to the use application.

- 経済性に優れた4コーナタイプインサート
 - ・ The economical four corner inserts.
- 低抵抗タイプのブレーカに加え、更に切れ味を重視したLFブレーカを標準化。
高送り加工の適用範囲が拡大します。
 - ・ In addition to the conventional free-cutting breaker, an LF breaker with the emphasis on further cutting performance has been added. This expands the applicable range for high-feed-rate machining.

切削抵抗 Cutting force 100%	93%	85%
SPNW 汎用タイプ General edge type	SPMT 低抵抗タイプ Sharp edge type	SPMT-LF 超低抵抗タイプ Ultra sharp edge type

■実績は語る Field Data

用途 Product items	被削材 Work material	工具径 DCX (mm) Tool dia.	使用工具 Item code	切削条件 Cutting conditions	結果 Result
ダイカスト型 Die-castmold	合金工具鋼 Alloy tool steels (40HRC)	50	ASRFB3050RM-7-22 SPMT07T2TR (JP4120)	$v_c = 115\text{m/min}$ $v_f = 6,150\text{mm/min}$ $a_p = 0.5\text{mm}$	刃数が多いメリットを活かして、加工能率向上と工具寿命改善が可能になった。 Multi-flute effect realizes efficiency cutting and long tool life.
金型部品 Mold parts	SS400 相当 Structural steel	32	ASRFM3032R-4-M16 SPNW07T2TR (JS4045)	$v_c = 160\text{m/min}$ $v_f = 9,850\text{mm/min}$ $a_p = 0.8\text{mm}$	刃先強度の改善により、一刃送りを上げて能率改善が可能になった。 By increases flute rigidity effect, high feed rate per flute realizes efficiency cutting.
金型部品 Mold parts	合金工具鋼 Alloy tool steels (35HRC)	25	ASRFM3025R-3-M12 SPMT07T2TR (JP4120)	$v_c = 173\text{m/min}$ $v_f = 9,000\text{mm/min}$ $a_p = 0.8\text{mm}$	突出しの長い加工を、2工程に分割して加工能率を改善することで、加工コストを60%削減できた。 The processing cost could be reduced 60% on the long overhang condition by the separated cutting process.
部品加工 Parts	SUS316	50	ASRFB3050RM-7-22 SPMT07T2ER-LF (JM4160)	$v_c = 120\text{m/min}$ $v_f = 3,000\text{mm/min}$ $a_p = 0.5\text{mm}$	LFブレーカにより抵抗が低減されることで、加工時に発生する熱が抑制された。 Cutting force is reduced by LF breaker and the heat of cutting process which occurs is suppressed.

Radius Mill ASR Multi-flutes type

アルファ高送りラジアスマイル ASR多刃タイプ

- ASRの多刃タイプです。
- 小さなインサートにもかかわらず大幅に耐久損性を向上させ、驚異的な送りが可能です。
- 最大切込み深さはR8タイプのインサートで1.5 mm R10タイプで2mmです。

・ ASR multi-flute type
 ・ Despite the use of small inserts, it provides greatly improved chipping resistance and enables amazing feed rates.
 ・ Maximum cutting depth is 1.5mm for R8 type and 2mm for R10 type.



ASR □20○○(□○○)R-○ ストレートシャンクタイプ

○は数字が入ります。 □は英文字が入ります。
 Numeric figure in a circle ○ and Alphabetical character comes in a square □



Fig.1 (一般形) Standard type

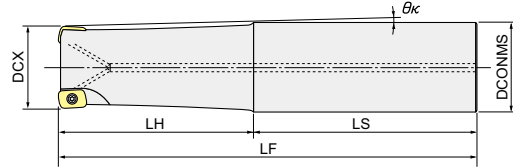
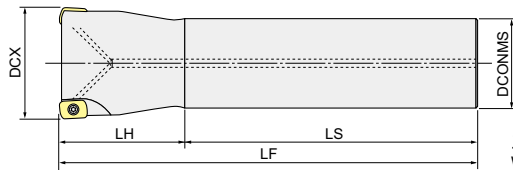

Fig.2 (アンダーカット形) Undercut type



商品コード Item code	在庫 Stock	刃数 No. of flutes	寸法 Size (mm)							形状 Shape	適用インサート Inserts	希望小売価格 (円) Suggested retail price (¥)
			DCX	LF	DCONMS	LH	LS	θκ				
Regular	ASRS2016R-2	●	2	16	100	16	30	70	—	Fig.1	EPNW0603TN-8 EPMT0603TN-8 EPMT0603EN-8LF	36,950
	ASRS2020R-3	●	3	20	130	20	50	80	—			47,640
	ASRS2025R-4	●	4	25	140	25	60	80	—			57,480
	ASRS2030R-4	●	4	30	150	32	70	80	0.9°			60,660
	ASRS2032R-5	●	5	32	150	32	70	80	—			68,400
	ASRS2040R-6	●	6	40	150	32	45	105	—			78,720
Shank type Long Shank type	ASRL2016R-2	●	2	16	150	16	50	100	—	Fig.1	EPNW0603TN-8 EPMT0603TN-8 EPMT0603EN-8LF	42,120
	ASRL2016S15R-2	●	2	16	150	15	25	125	—	Fig.2		42,120
	ASRL2018R-2	●	2	18	150	16	25	125	—	Fig.2		42,120
	ASRL2020R-3	●	3	20	160	20	80	80	—	Fig.1		54,200
	ASRL2020S18R-3	●	3	20	160	18	30	130	—	Fig.2		54,200
	ASRL2022R-3	●	3	22	160	20	30	130	—	Fig.2		54,200
	ASRL2025R-4	●	4	25	180	25	100	80	—	Fig.1		60,660
	ASRL2025S23R-4	●	4	25	180	23	35	145	—	Fig.2		60,660
	ASRL2028R-4	●	4	28	180	25	35	145	—	Fig.2		60,660
	ASRL2030R-4	●	4	30	200	32	120	80	0.6°	Fig.1		63,120
	ASRL2030S28R-4	●	4	30	200	28	40	160	—	Fig.2		63,120
	ASRL2032R-5	●	5	32	200	32	120	80	—	Fig.1		70,860
	ASRL2032S30R-5	●	5	32	200	30	40	160	—	Fig.1		70,860
	ASRL2040R-6	●	6	40	220	32	45	175	—	Fig.2		82,590

部品番号 Parts

○は数字が入ります。 Numeric figure in a circle ○

部品名 Parts	クランプねじ Clamp screw	クランプ駒セット Clamp piece set	ドライバーレンチ Screw driver / Wrench	ねじ焼き付き防止剤 Screw anti-seizure agent
形状 Shape				
適用カット Cutter body	締付トルク Fastening torque (N·m)	希望小売価格(円) Suggested retail price (¥)	形状 Shape	希望小売価格(円) Suggested retail price (¥)
ASR S/L/M20○○(S○○)R-○ ASR 20○○R(M)-○	250-141	1.1 870	A 1,800	P-37 1,010
ASR 30○○R(M)-○	412-141	2.9 540	B 2,120	

【注意】クランプねじは消耗品です。使用環境により交換寿命は変化しますので早めの交換をお願い致します。クランプねじは予備が2本付属します。

【Note】The clamp screw is a consumable part. Since replacement life depends on the use environment, it is recommended that it be replaced at an early stage.

●印：標準在庫品です。 ●：Stocked items.

ASR○○○○R(M)-○ ボアタイプ Bore type

○は数字が入ります。 Numeric figure in a circle ○

ボアタイプ用アーバはD11頁を参照ください。
Refer page D11 about the bore type arbor

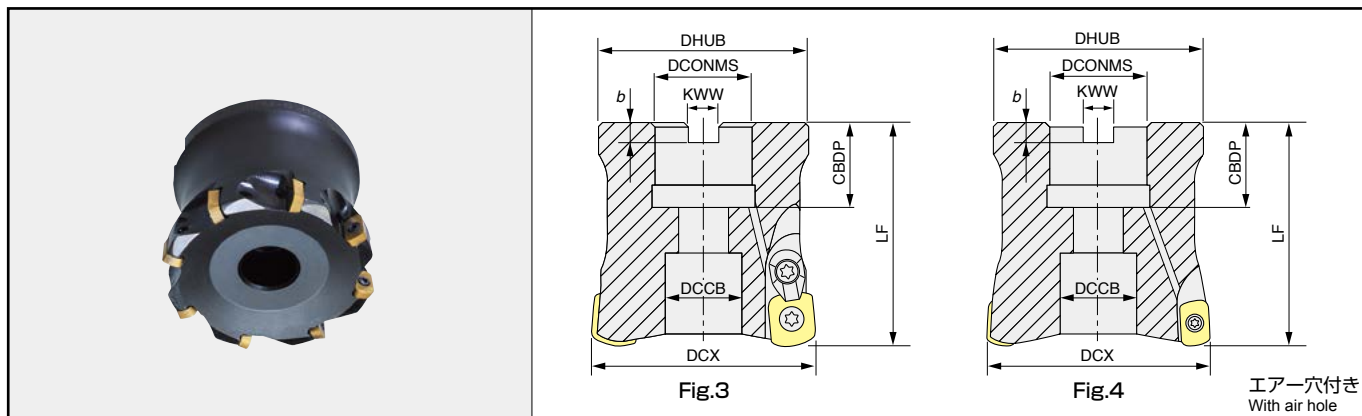

商品コード Item code	在庫 Stock	刃数 No. of flutes	寸法 Size (mm)								形状 Shape	適用インサート Inserts	希望小売価格 (円) Suggested retail price (¥)	
			DCX	DHUB	LF	CDBP	KWW	b	DCONMS	DCCB				
ボアタイプ 内径 インチ サイズ Internal diameter inch size	ASR3050R-5	●	5	50	47	50	19	8.4	5	22.225	17	Fig.3	EDNW12T3TN-10 EDMT12T3TN-10	86,460
	ASR3063R-6	●	6	63	60	50	19	8.4	5	22.225	17		Fig.4	EPNW0603TN-8 EPMT0603TN-8 EPMT0603EN-8LF
	ASR2052R-7	●	7	52	47	50	19	8.4	5	22.225	17	Fig.4		EPNW0603TN-8 EPMT0603TN-8 EPMT0603EN-8LF
	ASR2066R-8	●	8	66	60	50	19	8.4	5	22.225	17		Fig.4	EPNW0603TN-8 EPMT0603TN-8 EPMT0603EN-8LF
ボアタイプ 内径 ミリ サイズ Internal diameter mm size	ASR3050RM-5	●	5	50	47	50	20	10.4	6.3	22	17	Fig.3		EDNW12T3TN-10 EDMT12T3TN-10
	ASR3063RM-6	●	6	63	60	50	20	10.4	6.3	22	17		Fig.3	EDNW12T3TN-10 EDMT12T3TN-10
	ASR2052RM-7	●	7	52	47	50	20	10.4	6.3	22	17	Fig.4		EPNW0603TN-8 EPMT0603TN-8 EPMT0603EN-8LF
	ASR2066RM-8	●	8	66	60	50	20	10.4	6.3	22	17		Fig.4	EPNW0603TN-8 EPMT0603TN-8 EPMT0603EN-8LF

【注意】アーバ用ねじは付属しません。 【Note】 Arbor screw is not included.

ASRM20○○○R-○ モジュラータイプ Modular type

○は数字が入ります。 Numeric figure in a circle ○

モジュラーミル用シャンクはD2頁を、締め付けトルクについてはD5頁を参照ください。
Refer page D2 about the shanks for Modular Mill, Refer page D5 about tightening torque

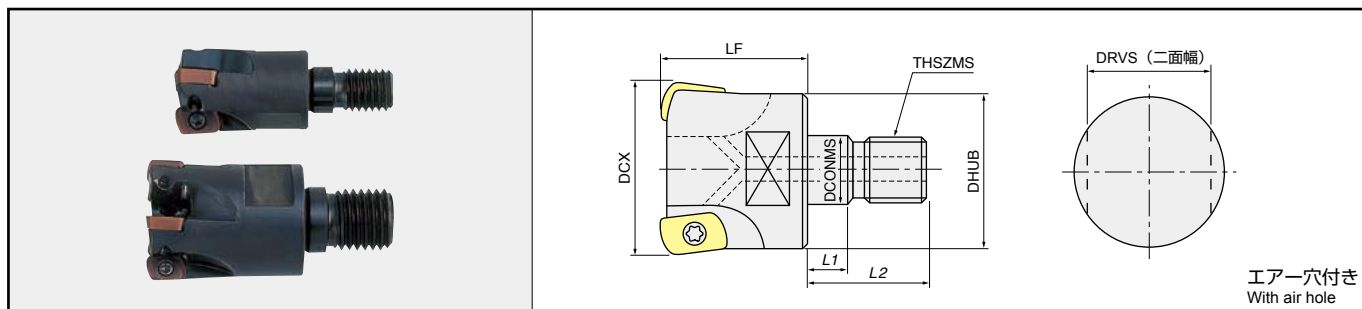

商品コード Item code	在庫 Stock	刃数 No. of flutes	寸法 Size (mm)								適用インサート Inserts	希望小売価格 (円) Suggested retail price (¥)
			DCX	LF	DCONMS	THSZMS	DHUB	L1	L2	DRVS		
ASRM2016R-2	●	2	16	25	8.5	M8	12.8	5.5	17	10	EPNW0603TN-8 EPMT0603TN-8 EPMT0603EN-8LF	36,950
※ ASRM2018R-2	●	2	18	25	8.5	M8	14.5	5.5	17	10		36,950
ASRM2020R-3	●	3	20	30	10.5	M10	17.8	5.5	19	15		47,640
※ ASRM2022R-3	●	3	22	30	10.5	M10	17.8	5.5	19	15		47,640
ASRM2025R-4	●	4	25	35	12.5	M12	20.8	5.5	22	17		57,480
※ ASRM2028R-4	●	4	28	35	12.5	M12	23	5.5	22	17		57,480
ASRM2030R-4	●	4	30	40	17	M16	28.8	6	23	22		60,660
ASRM2032R-5	●	5	32	40	17	M16	28.8	6	23	22		68,400
※ ASRM2040R-6	●	6	40	40	17	M16	28.8	6	23	22		78,720

【注意】※と超硬シャンクをセットで使用すると干渉がありません。

モジュラーミル及び専用シャンク、専用アーバの「工具端面」「モジュラーねじ部」にグリースなどの潤滑剤は塗布しないでください。

【Note】 When ※ and carbide shank are used together as a set, there is no interference.

Do not apply lubricants such as grease, etc. to the "contact faces" and "modular screws" of the "modular mill", "dedicated shanks" and "dedicated arbor".

■ インサート Inserts

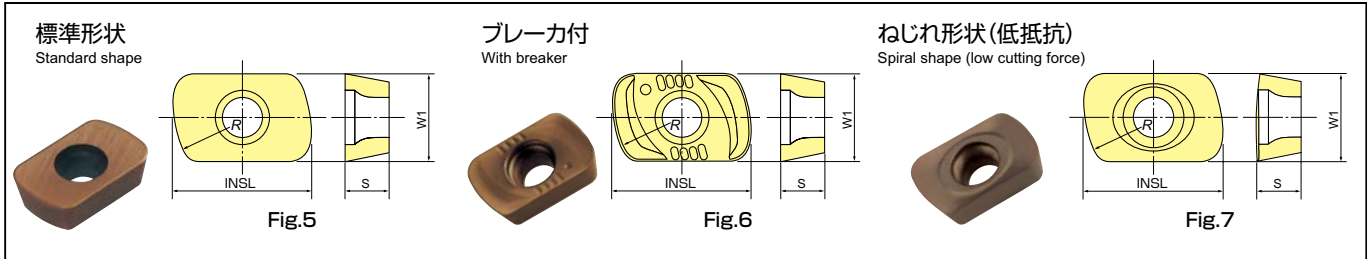

商品コード Item code	精度 Tolerance class	AJコーティング AJ Coating			GXコーティング GX Coating	JSコーティング JS Coating		寸法 Size(mm)				形状 Shape	希望小売価格(円) Suggested retail price(¥)
		JP4105	JP4120	JM4160	GX2140	JS4045	JS4060	R	INSL	S	W1		
EPNW0603TN-8	N級 N	●	●	●	●	●	●	8	10	3.18	6.35	Fig.5	1,100
EDNW12T3TN-10		●	●	●	●	●	●	10	12	3.97	10		1,500
EPMT0603TN-8	M級 M	●	●	●	●	●	●	8	10	3.18	6.35	Fig.6	1,100
EDMT12T3TN-10		●	●	●	●	●	●	10	12	3.97	10		1,500
EPMT0603EN-8LF		●						8	10	3.18	6.35	Fig.7	1,100

【注意】 GXコーティング、JSコーティングは通電式タッチセンサーに反応しませんのでご注意ください。
【Note】 Please note that the GX Coating and JS Coating do not cause a reaction in conductive touch sensors.

刃先交換式工具
高送りラジアスマイル

■ 切削領域-1 (BT40用) Overhang and Application Area 1 (for BT40)

① φ16 (2枚刃) 2 Flutes

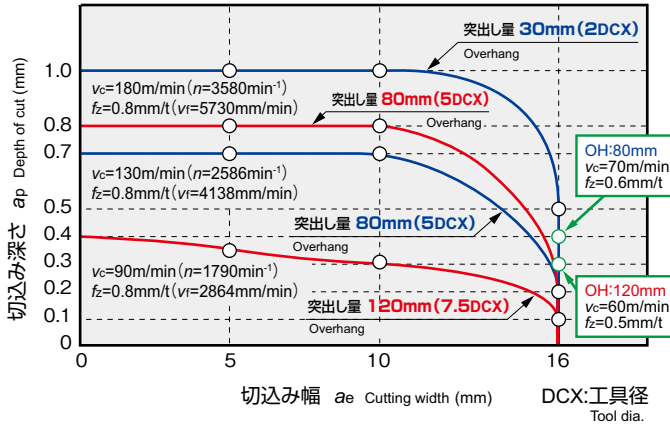

② φ20 (3枚刃) 3 Flutes

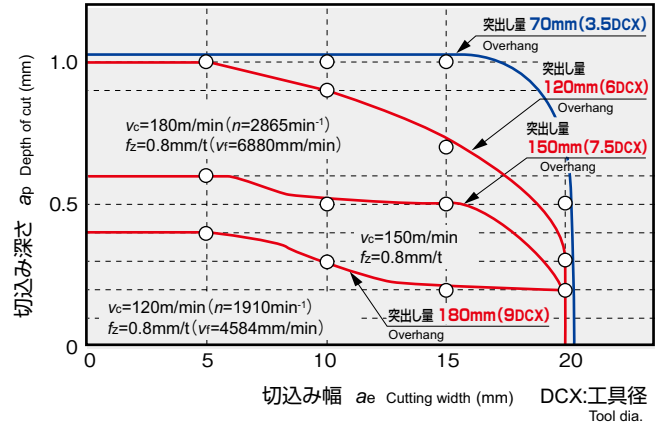

③ φ25 (4枚刃) 4 Flutes

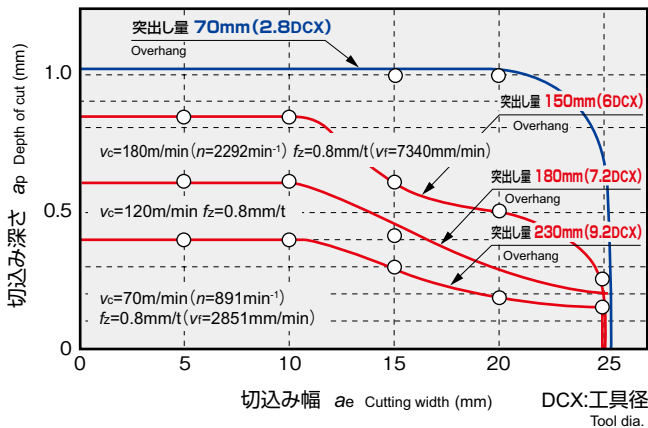

④ φ32 (5枚刃) 5 Flutes

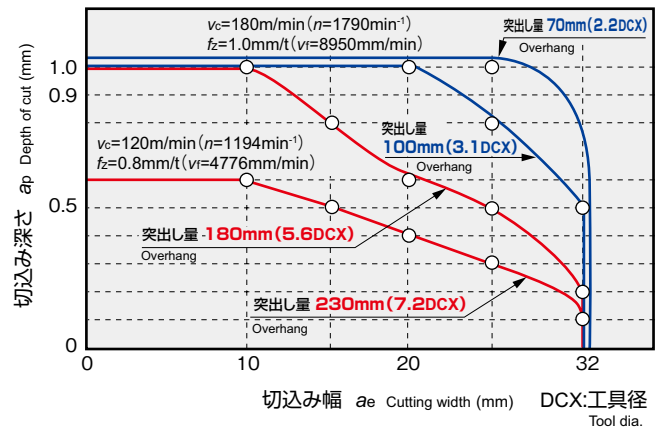

⑤ φ40 (6枚刃) 6 Flutes

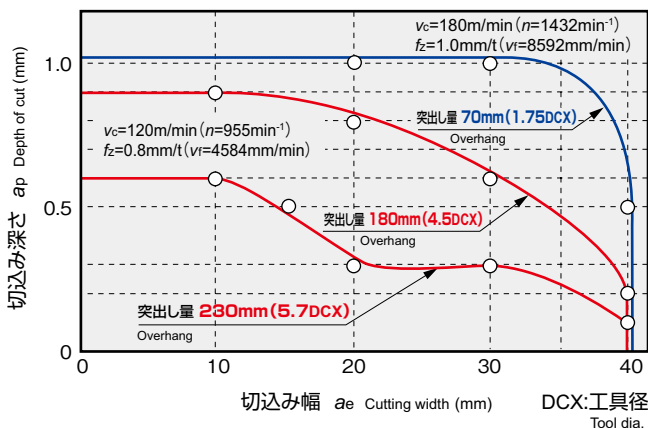

使用機械 (Machine): BT40 11/7.5kw
被削材 (Work material): S50C(220HB)
1.1213(Cf35)

— : 鋼シャンク (Steel Shank)
— : 超硬シャンク (Carbide Shank)

■ 切削領域-2 (BT50用) Overhang and Application Area 2 (for BT50)

① φ16 (2枚刃) 2 Flutes

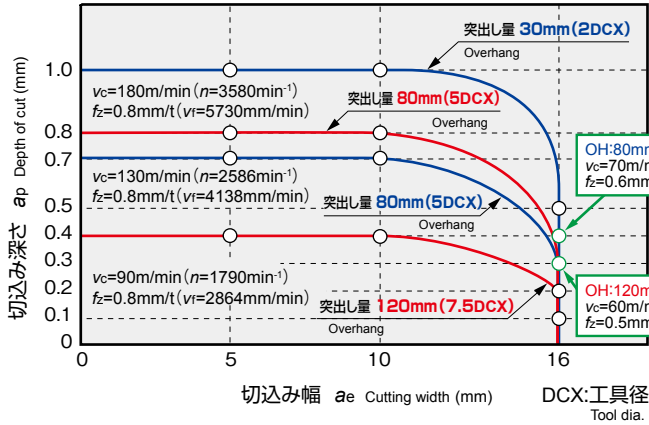

② φ20 (3枚刃) 3 Flutes

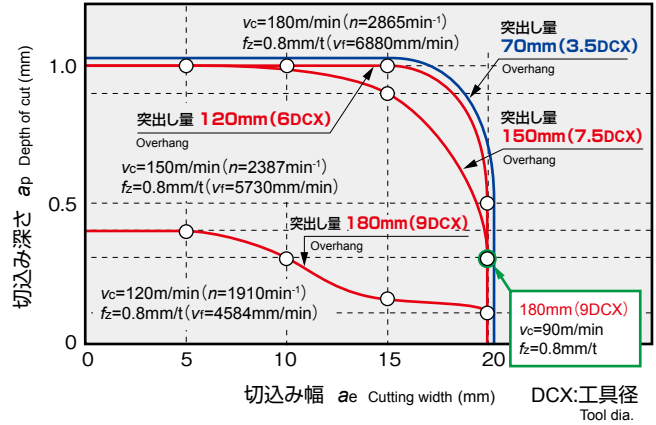

③ φ25 (4枚刃) 4 Flutes

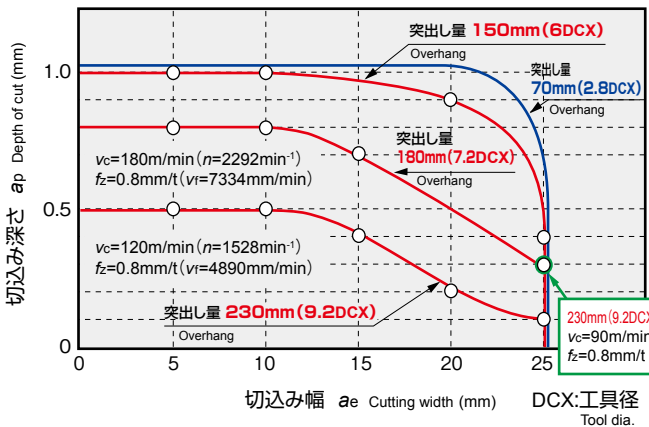

④ φ32 (5枚刃) 5 Flutes

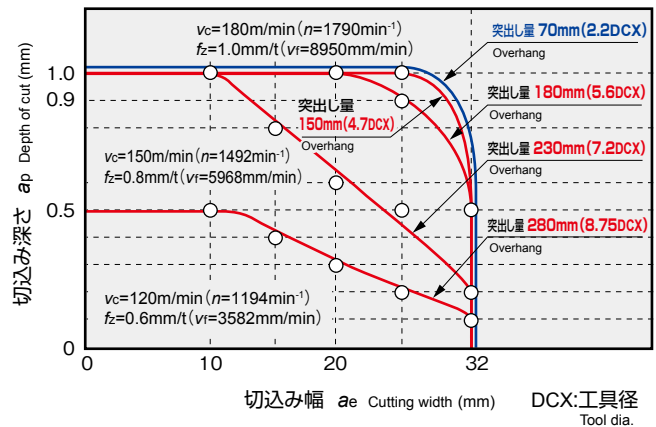

⑤ φ40 (6枚刃) 6 Flutes

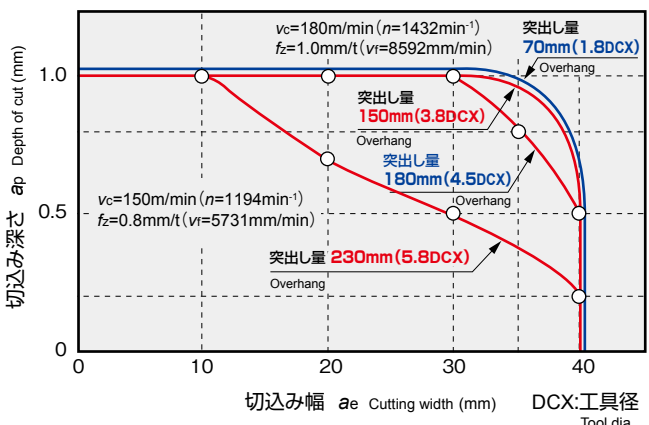

使用機械 (Machine) : BT50 22/18.5kw

被削材 (Work material) : S50C(220HB)

1.1213 (Cf35)

— : 鋼シャンク (Steel Shank)

— : 超硬シャンク (Carbide Shank)

標準切削条件表 Recommended cutting conditions

標準切削条件① ストレートシャンク Recommended Cutting Conditions for Straight Shank Type

※赤字は第一推奨材種です。
Red indicates primary recommended grade.

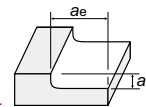

注意 次ページ
Note Next Page

被削材 Work material	推奨材種 Recommended grade	工具径DCX Tool dia.	φ16(2枚刃) 2 Flutes		φ20(3枚刃) 3 Flutes		φ25(4枚刃) 4 Flutes		φ32(5枚刃) 5 Flutes		φ40(6枚刃) 6 Flutes	
			<3DCX		<3DCX		<3DCX		<3DCX		<3DCX	
			汎用 General purpose	高速加工 High-speed processing	汎用 General purpose	高速加工 High-speed processing	汎用 General purpose	高速加工 High-speed processing	汎用 General purpose	高速加工 High-speed processing	汎用 General purpose	高速加工 High-speed processing
炭素鋼 Carbon steels 合金鋼 Alloy steels <30HRC	※ GX2140 JS4060 JS4045	n (min ⁻¹)	1,800	3,590	1,440	2,870	1,150	2,300	900	1,800	720	1,440
		v _c (m/min)	90	180	90	180	90	180	90	180	90	180
		v _r (mm/min)	2,880	10,060	3,460	12,060	4,600	14,720	4,500	14,400	4,320	13,830
		f _z (mm/t)	0.8	1.4	0.8	1.4	1.0	1.6	1.0	1.6	1.0	1.6
		a _p (mm)	0.8	0.6	1.0	0.5	1.0	0.5	1.0	0.5	1.0	0.5
		a _e (mm)	13	13	16	16	20	20	25	25	32	32
		Q (cm ³ /min)	30	78	55	96	92	147	113	180	138	221
		Q (cm ³ /min)	30	78	55	96	92	147	113	180	138	221
プリハードン鋼 Pre-Hardened steels 合金鋼 Alloy steels 30~40HRC	JP4120 JS4045 JS4060	n (min ⁻¹)	1,800	3,590	1,440	2,870	1,150	2,300	900	1,800	720	1,440
		v _c (m/min)	90	180	90	180	90	180	90	180	90	180
		v _r (mm/min)	2,880	10,060	3,460	12,060	4,600	14,720	4,500	14,400	4,320	13,830
		f _z (mm/t)	0.8	1.4	0.8	1.4	1.0	1.6	1.0	1.6	1.0	1.6
		a _p (mm)	0.8	0.6	1.0	0.5	1.0	0.5	1.0	0.5	1.0	0.5
		a _e (mm)	13	13	16	16	20	20	25	25	32	32
		Q (cm ³ /min)	30	78	55	96	92	147	113	180	138	221
		Q (cm ³ /min)	30	78	55	96	92	147	113	180	138	221
プリハードン鋼 Pre-hardened steels 合金鋼 Alloy steels 40~50HRC	JP4120 JS4045	n (min ⁻¹)	1,800	2,590	1,440	2,080	1,150	1,660	900	1,300	720	1,040
		v _c (m/min)	90	130	90	130	90	130	90	130	90	130
		v _r (mm/min)	2,160	6,220	2,600	7,490	2,760	7,970	2,700	7,800	2,600	7,490
		f _z (mm/t)	0.6	1.2	0.6	1.2	0.6	1.2	0.6	1.2	0.6	1.2
		a _p (mm)	0.5	0.35	0.6	0.35	0.6	0.35	0.6	0.35	0.6	0.35
		a _e (mm)	13	13	16	16	20	20	25	25	32	32
		Q (cm ³ /min)	14	28	25	42	33	56	41	68	50	84
		Q (cm ³ /min)	14	28	25	42	33	56	41	68	50	84
ステンレス鋼 Stainless steels SUS	JM4160	n (min ⁻¹)	1,800	3,590	1,440	2,870	1,150	2,300	900	1,800	720	1,440
		v _c (m/min)	90	180	90	180	90	180	90	180	90	180
		v _r (mm/min)	1,800	7,180	2,160	8,610	2,300	9,200	2,250	9,000	2,160	8,640
		f _z (mm/t)	0.5	1.0	0.5	1.0	0.5	1.0	0.5	1.0	0.5	1.0
		a _p (mm)	0.8	0.6	1.0	0.5	1.0	0.5	1.0	0.5	1.0	0.5
		a _e (mm)	13	13	16	16	20	20	25	25	32	32
		Q (cm ³ /min)	19	56	35	69	46	92	56	113	69	138
		Q (cm ³ /min)	19	56	35	69	46	92	56	113	69	138
鋳鉄 Cast irons FC FCD	JS4045 GX2140 JP4120	n (min ⁻¹)	1,800	3,590	1,440	2,870	1,150	2,300	900	1,800	720	1,440
		v _c (m/min)	90	180	90	180	90	180	90	180	90	180
		v _r (mm/min)	4,320	11,490	6,050	15,500	6,440	16,560	6,300	16,200	6,050	15,560
		f _z (mm/t)	1.2	1.6	1.4	1.8	1.4	1.8	1.4	1.8	1.4	1.8
		a _p (mm)	1.0	0.8	1.25	1.0	1.25	1.0	1.25	1.0	1.25	1.0
		a _e (mm)	13	13	16	16	20	20	25	25	32	32
		Q (cm ³ /min)	56	119	121	248	161	331	197	405	242	498
		Q (cm ³ /min)	56	119	121	248	161	331	197	405	242	498
焼入れ鋼 Hardened steels プリハードン鋼 Pre-hardened steels 50-55HRC	JP4120 JP4105	n (min ⁻¹)	1,600	2,390	1,280	1,920	1,020	1,530	800	1,200	640	960
		v _c (m/min)	80	120	80	120	80	120	80	120	80	120
		v _r (mm/min)	640	960	770	1,160	820	1,230	800	1,200	770	1,160
		f _z (mm/t)	0.2	0.2	0.2	0.2	0.2	0.2	0.2	0.2	0.2	0.2
		a _p (mm)	0.4	0.25	0.4	0.25	0.4	0.25	0.4	0.25	0.4	0.25
		a _e (mm)	13	13	16	16	20	20	25	25	32	32
		Q (cm ³ /min)	3	3	5	5	7	6	8	8	10	9
		Q (cm ³ /min)	3	3	5	5	7	6	8	8	10	9
焼入れ鋼 Hardened steels 55-62HRC	JP4105	n (min ⁻¹)	1,200	2,000	960	1,600	770	1,280	600	1,000	480	800
		v _c (m/min)	60	100	60	100	60	100	60	100	60	100
		v _r (mm/min)	120	200	150	240	160	260	150	250	150	240
		f _z (mm/t)	0.05	0.05	0.05	0.05	0.05	0.05	0.05	0.05	0.05	0.05
		a _p (mm)	0.5	0.3	0.5	0.3	0.5	0.3	0.5	0.3	0.5	0.3
		a _e (mm)	13	13	16	16	20	20	25	25	32	32
		Q (cm ³ /min)	0.8	0.8	1.2	1.2	1.6	1.6	1.9	1.9	2.4	2.3
		Q (cm ³ /min)	0.8	0.8	1.2	1.2	1.6	1.6	1.9	1.9	2.4	2.3
最大 Maximum f _z (mm/t)		<1.8 (汎用 f _z :<1.0) General purpose		<1.8 (汎用 f _z :<1.0) General purpose		<1.8 (汎用 f _z :<1.0) General purpose		<1.8 (汎用 f _z :<1.0) General purpose		<1.8 (汎用 f _z :<1.0) General purpose		
最大 Maximum a _p (mm)		<1.25 (汎用 a _p :<1.0) General purpose		<1.25 (汎用 a _p :<1.0) General purpose		<1.5 (汎用 a _p :<1.0) General purpose		<1.5 (汎用 a _p :<1.0) General purpose		<1.5 (汎用 a _p :<1.0) General purpose		

アルファ高送りラジアスマイル ASR多刃タイプ

標準切削条件② モジュラー超硬シャンクタイプ

Recommended Cutting Conditions for Modular Carbide Shank Type

※赤字は第一推奨材種です。
Red indicates primary recommended grade.

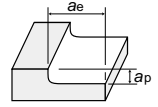

被削材 Work material	推奨材種 Recommended grade	工具径DCX Tool dia.	φ16(2枚刃) 2 Flutes			φ20(3枚刃) 3 Flutes			φ25(4枚刃) 4 Flutes			φ32(5枚刃) 5 Flutes			φ40(6枚刃) 6 Flutes		
			3DCX -5DCX	5DCX -7DCX	>7DCX	3DCX -5DCX	5DCX -7DCX	>7DCX	3DCX -5DCX	5DCX -7DCX	>7DCX	3DCX -5DCX	5DCX -7DCX	>7DCX	3DCX -5DCX	5DCX -7DCX	>7DCX
炭素鋼 Carbon steels 合金鋼 Alloy steels <30HRC	※ GX2140 JS4060 JS4045	突出し量 Overhang	モジュラー超硬シャンク Modular carbide shank			モジュラー超硬シャンク Modular carbide shank			モジュラー超硬シャンク Modular carbide shank			モジュラー超硬シャンク Modular carbide shank			モジュラー超硬シャンク Modular carbide shank		
		n (min ⁻¹)	2,590	2,590	1,800	2,080	2,080	1,440	1,660	1,660	1,150	1,300	1,300	900	1,040	1,040	720
		v_c (m/min)	130	130	90	130	130	90	130	130	90	130	130	90	130	130	90
		v_f (mm/min)	4,150	4,150	2,880	5,000	5,000	3,460	6,640	6,640	4,600	6,500	6,500	4,500	6,240	6,240	4,320
		f_z (mm/t)	0.8	0.8	0.8	0.8	0.8	0.8	1.0	1.0	1.0	1.0	1.0	1.0	1.0	1.0	1.0
		a_p (mm)	0.6	0.5	0.4	0.8	0.5	0.4	0.8	0.5	0.4	0.8	0.5	0.4	0.8	0.5	0.4
		a_e (mm)	13	13	13	16	16	16	20	20	20	25	25	25	32	32	32
		Q (cm ³ /min)	32	27	15	64	40	22	106	66	37	130	81	45	160	100	55
プリハードン鋼 Pre-hardened steels 合金鋼 Alloy-steels 30~40HRC	JP4120 JS4045 JS4060	n (min ⁻¹)	2,590	2,590	1,800	2,080	2,080	1,440	1,660	1,660	1,150	1,300	1,300	900	1,040	1,040	720
		v_c (m/min)	130	130	90	130	130	90	130	130	90	130	130	90	130	130	90
		v_f (mm/min)	4,150	4,150	2,880	5,000	5,000	3,460	6,640	6,640	4,600	6,500	6,500	4,500	6,240	6,240	4,320
		f_z (mm/t)	0.8	0.8	0.8	0.8	0.8	0.8	1.0	1.0	1.0	1.0	1.0	1.0	1.0	1.0	1.0
		a_p (mm)	0.6	0.5	0.4	0.8	0.5	0.4	0.8	0.5	0.4	0.8	0.5	0.4	0.8	0.5	0.4
		a_e (mm)	13	13	13	16	16	16	20	20	20	25	25	25	32	32	32
		Q (cm ³ /min)	32	27	15	64	40	22	106	66	37	130	81	45	160	100	55
		プリハードン鋼 Pre-hardened steels 合金鋼 Alloy-steels 40~50HRC	JP4120 JS4045	n (min ⁻¹)	1,800	1,800	1,800	1,440	1,440	1,440	1,150	1,150	1,150	900	900	900	720
v_c (m/min)	90			90	90	90	90	90	90	90	90	90	90	90	90	90	90
v_f (mm/min)	2,160			2,160	2,160	2,600	2,600	2,600	2,760	2,760	2,760	2,700	2,700	2,700	2,600	2,600	2,600
f_z (mm/t)	0.6			0.6	0.6	0.6	0.6	0.6	0.6	0.6	0.6	0.6	0.6	0.6	0.6	0.6	0.6
a_p (mm)	0.5			0.4	0.3	0.5	0.4	0.3	0.5	0.4	0.3	0.5	0.4	0.3	0.5	0.4	0.3
a_e (mm)	13			13	13	16	16	16	20	20	20	25	25	25	32	32	32
Q (cm ³ /min)	14			11	8	21	17	12	28	22	17	34	27	20	42	33	25
ステンレス鋼 Stainless steels SUS	JM4160			n (min ⁻¹)	2,990	1,800	1,800	2,390	1,440	1,440	1,920	1,150	1,150	1,500	900	900	1,200
		v_c (m/min)	150	90	90	150	90	90	150	90	90	150	90	90	150	90	90
		v_f (mm/min)	2,990	1,800	1,800	3,590	2,160	2,160	3,840	2,300	2,300	3,750	2,250	2,250	3,600	2,160	2,160
		f_z (mm/t)	0.5	0.5	0.5	0.5	0.5	0.5	0.5	0.5	0.5	0.5	0.5	0.5	0.5	0.5	0.5
		a_p (mm)	0.6	0.5	0.4	0.8	0.5	0.4	0.8	0.5	0.4	0.8	0.5	0.4	0.8	0.5	0.4
		a_e (mm)	13	13	13	16	16	16	20	20	20	25	25	25	32	32	32
		Q (cm ³ /min)	23	12	9	46	17	14	61	23	18	75	28	23	92	35	28
		鋳鉄 Cast irons FC FCD	JS4045 GX2140 JP4120	n (min ⁻¹)	2,590	2,590	1,800	2,080	2,080	1,440	1,660	1,660	1,150	1,300	1,300	900	1,040
v_c (m/min)	130			130	90	130	130	90	130	130	90	130	130	90	130	130	90
v_f (mm/min)	6,220			6,220	4,320	8,740	8,740	6,050	9,300	9,300	6,440	9,100	9,100	6,300	8,740	8,740	6,050
f_z (mm/t)	1.2			1.2	1.2	1.4	1.4	1.4	1.4	1.4	1.4	1.4	1.4	1.4	1.4	1.4	1.4
a_p (mm)	0.8			0.6	0.5	0.8	0.6	0.4	0.8	0.6	0.4	0.8	0.6	0.4	0.8	0.6	0.4
a_e (mm)	13			13	13	16	16	16	20	20	20	25	25	25	32	32	32
Q (cm ³ /min)	65			49	28	112	84	39	149	112	52	182	137	63	224	168	77
焼入れ鋼 Hardened steels プリハードン鋼 Pre-hardened steels 50-55HRC	JP4120 JP4105			n (min ⁻¹)	1,600	1,600	1,600	1,280	1,280	1,280	1,020	1,020	1,020	800	800	800	640
		v_c (m/min)	80	80	80	80	80	80	80	80	80	80	80	80	80	80	80
		v_f (mm/min)	640	640	640	770	770	770	820	820	820	800	800	800	770	770	770
		f_z (mm/t)	0.2	0.2	0.2	0.2	0.2	0.2	0.2	0.2	0.2	0.2	0.2	0.2	0.2	0.2	0.2
		a_p (mm)	0.35	0.25	0.15	0.35	0.25	0.15	0.35	0.25	0.15	0.35	0.25	0.15	0.35	0.25	0.15
		a_e (mm)	13	13	13	16	16	16	20	20	20	25	25	25	32	32	32
		Q (cm ³ /min)	3	2	1	4	3	2	6	4	2	7	5	3	9	6	4
		焼入れ鋼 Hardened steels 55-62HRC	JP4105	n (min ⁻¹)	1,200	1,200	1,200	960	960	960	770	770	770	600	600	600	480
v_c (m/min)	60			60	60	60	60	60	60	60	60	60	60	60	60	60	60
v_f (mm/min)	120			120	120	150	150	150	160	160	160	150	150	150	150	150	150
f_z (mm/t)	0.05			0.05	0.05	0.05	0.05	0.05	0.05	0.05	0.05	0.05	0.05	0.05	0.05	0.05	0.05
a_p (mm)	0.5			0.3	0.2	0.5	0.3	0.2	0.5	0.3	0.2	0.5	0.3	0.2	0.5	0.3	0.2
a_e (mm)	13			13	13	16	16	16	20	20	20	25	25	25	32	32	32
Q (cm ³ /min)	0.8			0.5	0.3	1.2	0.7	0.5	1.6	1.0	0.6	1.9	1.1	0.8	2.4	1.4	1.0
最大 Maximum f_z (mm/t)	<1.8 (汎用 f_z <1.0)			<1.8 (汎用 f_z <1.0)		<1.8 (汎用 f_z <1.0)		<1.8 (汎用 f_z <1.0)		<1.8 (汎用 f_z <1.0)		<1.8 (汎用 f_z <1.0)		<1.8 (汎用 f_z <1.0)		<1.8 (汎用 f_z <1.0)	
最大 Maximum a_p (mm)	<1.25 (汎用 a_p <1.0)		<1.25 (汎用 a_p <1.0)		<1.25 (汎用 a_p <1.0)		<1.5 (汎用 a_p <1.0)		<1.5 (汎用 a_p <1.0)		<1.5 (汎用 a_p <1.0)		<1.5 (汎用 a_p <1.0)		<1.5 (汎用 a_p <1.0)		

【注意】

- ①被削材、加工形状に合わせて、適切なクーラントを使用してください。
- ②この切削条件表は切削条件の目安を示すものです。実際の加工では加工形状、目的、使用機械等により条件を調整してください。
- ③本表は肩削り時の一般的な条件です。機械剛性やツーリング、加工物の状況に合わせて調整してください。特に、溝切削の併用、またはそれに近い切り込み幅の加工などでびびり振動が発生し、トラブルに至る場合がありますので下記を参考に調整してください。
・溝削りが伴う場合、C57、C58頁の切削領域を参照。
・ブレーカ付きインサートを使用する。
・回転数、テーブル送り量を50~70%下げる。
・切り込み深さを50~70%下げる。
- ④GXコーティング、JSコーティングは、通電式タッチセンサーに反応しませんのでご注意ください。
- ⑤J4105/J4105/J4105/J4105は高硬度鋼専用材種で、生材には適しません。
- ⑥強断続切削、突出しが長い場合及び湿式切削にはJM4160/JM4160/JM4160を推奨します。
- ⑦切りくず噛み込みによる工具損傷防止のため、必ずエアブロー等による切りくず除去を行ってください。
- ⑧排出した切りくずは、飛散し作業者を切傷させ、火傷あるいは目に入ると負傷させる恐れがありますので、ご使用に際してはその周囲に安全カバーを取付け、保護メガネ等の保護具を着用し、安全な環境で作業されることをお願い致します。
- ⑨インサートの交換は早めに行い、過度の使用による破損を防止してください。
- ⑩下記に単位時間当たりの切りくず排出量 Q を示します。
 $Q(\text{cm}^3/\text{min})=a_p(\text{mm}) \times a_e(\text{mm}) \times v_f(\text{mm}/\text{min}) / 1000$
- ⑪切り込み深さの最大値を下記図に示します。最大値を超えないように設定してください。

【Note】

- ① Use the appropriate coolant for the work material and machining shape.
- ② These conditions are for general guidance; in actual machining conditions adjust the parameters according to your actual machine and work-piece conditions.
- ③ This table shows the general conditions for shoulder milling. The conditions should be adjusted according to the machine rigidity, tooling, condition of object to be milled, etc. In particular, when performing shoulder milling in combination with slotting or machining of cutting widths close to slots, etc., chattering vibrations may occur, which can lead to trouble. Therefore, please consider the following when adjusting the conditions:
・When performing shoulder milling in combination with slotting, please refer to the cutting region on pp. C57 - C58.
・Use inserts equipped with breakers.
・Reduce rotation speed and table feed rate by 50 to 70%.
・Reduce cutting depth as by 50 to 70%.
- ④ Please note that the GX Coating and JS Coating do not cause a reaction in conductive touch sensors.
- ⑤ J4105 and JP4005 are a hardened steel, and is not suitable for Non-heat-treated steel material.
- ⑥ For strongly interrupted cutting, when unsupported length is long, or for wet cutting, JM4160 and JM4060 are recommended.
- ⑦ As a measure to prevent tool damage due to chip jamming, always use an air blower, etc. to remove chips.
- ⑧ Since there is a danger of the removed chips flying out and causing injury to workers, fire, or damage to eyes, during use be sure to cover the work area with a safety cover and have workers wear protective equipment such as glasses, etc. to make the work area safe.
- ⑨ Perform insert replacement at an early stage to prevent chipping due to excessive use.
- ⑩ The following equation expresses the metal removal rate per unit time:
 $Q(\text{cm}^3/\text{min})=a_p(\text{mm}) \times a_e(\text{mm}) \times v_f(\text{mm}/\text{min}) / 1000$
- ⑪ The maximum value of cut depth is shown in the table below. Be sure to use settings that do not exceed the maximum value.

最大 切り込み深さ
Maximum cut depth

EPNW(MT)0603TN-8 (プログラミングR:R2.0)
EPMT0603EN-8LF Programming R: R2.0

適用カッタ ASR S/L/M20(S)R

Applicable cutter

標準切削条件③ ボアタイプ

Recommended Cutting Conditions for Bore Type

※赤字は第一推奨材種です。
Red indicates primary recommended grade.

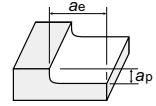

注意 次ページ
Note Next Page

被削材 Work material	推奨材種 Recommended grade	工具径DCX Tool dia.	φ50(5枚刃) 5 Flutes ASR3050R(M)-5					φ52(7枚刃) 7 Flutes ASR2052R(M)-7					φ63(6枚刃) 6 Flutes ASR3063R(M)-5					φ66(8枚刃) 8 Flutes ASR2066R(M)-8					
			突出し量 Overhang	<3DCX		3DCX-5DCX	5DCX-7DCX	7DCX	<3DCX		3DCX-5DCX	5DCX-7DCX	7DCX	<3DCX		3DCX-5DCX	5DCX-7DCX	7DCX	<3DCX		3DCX-5DCX	5DCX-7DCX	7DCX
				汎用 General purpose	高速加工 High-speed processing				汎用 General purpose	高速加工 High-speed processing				汎用 General purpose	高速加工 High-speed processing				汎用 General purpose	高速加工 High-speed processing			
炭素鋼 Carbon-steels 合金鋼 Alloy steels <30HRC	※ GX2140 JS4060 JS4045	n (min ⁻¹)	580	1,150	830	830	580	560	1,110	800	800	560	460	910	660	660	460	440	870	630	630	440	
		v _c (m/min)	90	180	130	130	90	90	180	130	130	90	90	180	130	130	90	90	180	130	130	90	
		v _f (mm/min)	3,770	9,200	4,150	4,150	2,900	3,920	12,440	5,600	5,600	3,920	3,590	8,740	3,960	3,960	2,760	3,520	11,140	5,040	5,040	3,520	
		f _z (mm/t)	1.3	1.6	1.0	1.0	1.0	1.0	1.6	1.0	1.0	1.0	1.3	1.6	1.0	1.0	1.0	1.0	1.6	1.0	1.0	1.0	
		a _p (mm)	1.0	0.8	1.0	0.7	0.5	1.0	0.5	0.8	0.5	0.4	1.0	0.8	1.0	0.7	0.5	1.0	0.5	0.8	0.5	0.4	
		a _e (mm)	40	40	40	40	40	40	40	40	40	40	50	50	50	50	50	50	50	50	50	50	
		Q (cm ³ /min)	151	294	166	116	58	157	249	179	112	63	180	350	198	139	69	176	279	202	126	70	
プリハードン鋼 Pre-hardened steels 合金鋼 Alloy steels 30~40HRC	JP4120 JS4045 JS4060	n (min ⁻¹)	580	1,150	830	830	580	560	1,110	800	800	560	460	910	660	660	460	440	870	630	630	440	
		v _c (m/min)	90	180	130	130	90	90	180	130	130	90	90	180	130	130	90	90	180	130	130	90	
		v _f (mm/min)	3,770	9,200	4,150	4,150	2,900	3,920	12,440	5,600	5,600	3,920	3,590	8,740	3,960	3,960	2,760	3,520	11,140	5,040	5,040	3,520	
		f _z (mm/t)	1.3	1.6	1.0	1.0	1.0	1.0	1.6	1.0	1.0	1.0	1.3	1.6	1.0	1.0	1.0	1.0	1.6	1.0	1.0	1.0	
		a _p (mm)	1.0	0.8	1.0	0.7	0.5	1.0	0.5	0.8	0.5	0.4	1.0	0.8	1.0	0.7	0.5	1.0	0.5	0.8	0.5	0.4	
		a _e (mm)	40	40	40	40	40	40	40	40	40	40	50	50	50	50	50	50	50	50	50	50	
		Q (cm ³ /min)	151	294	166	116	58	157	249	179	112	63	180	350	198	139	69	176	279	202	126	70	
プリハードン鋼 Pre-hardened steels 合金鋼 Alloy steels 40~50HRC	JP4120 JS4045	n (min ⁻¹)	580	830	580	580	580	560	800	560	560	560	460	660	460	460	460	440	630	440	440	440	
		v _c (m/min)	90	130	90	90	90	90	130	90	90	90	90	130	90	90	90	90	130	90	90		
		v _f (mm/min)	2,320	3,320	2,320	2,320	2,320	2,360	6,720	2,360	2,360	2,360	2,210	3,170	2,210	2,210	2,210	2,120	6,050	2,120	2,120	2,120	
		f _z (mm/t)	0.8	0.8	0.8	0.8	0.8	0.6	1.2	0.6	0.6	0.6	0.8	0.8	0.8	0.8	0.8	0.6	1.2	0.6	0.6	0.6	
		a _p (mm)	1.0	1.0	1.0	0.7	0.5	0.6	0.35	0.5	0.4	0.3	1.0	1.0	1.0	0.7	0.5	0.6	0.35	0.5	0.4	0.3	
		a _e (mm)	40	40	40	40	40	40	40	40	40	40	50	50	50	50	50	50	50	50	50	50	
		Q (cm ³ /min)	93	133	93	65	46	57	94	47	38	28	111	159	111	77	55	64	106	53	42	32	
ステンレス鋼 Stainless steels SUS	JM4160	n (min ⁻¹)	580	1,150	960	580	580	560	1,110	920	560	560	460	910	760	460	460	440	870	730	440	440	
		v _c (m/min)	90	180	150	90	90	90	180	150	90	90	90	180	150	90	90	90	180	150	90	90	
		v _f (mm/min)	1,450	5,750	2,400	1,450	1,450	1,960	7,770	3,220	1,960	1,960	1,380	5,460	2,280	1,380	1,380	1,760	6,960	2,920	1,760	1,760	
		f _z (mm/t)	0.5	1.0	0.5	0.5	0.5	0.5	1.0	0.5	0.5	0.5	0.5	1.0	0.5	0.5	0.5	0.5	1.0	0.5	0.5	0.5	
		a _p (mm)	1.0	0.8	1.0	0.7	0.5	1.0	0.5	0.8	0.5	0.4	1.0	0.8	1.0	0.7	0.5	1.0	0.5	0.8	0.5	0.4	
		a _e (mm)	40	40	40	40	40	40	40	40	40	40	50	50	50	50	50	50	50	50	50	50	
		Q (cm ³ /min)	58.0	184.0	96.0	40.6	29.0	78.4	155.4	103.0	39.2	31.4	69.0	218.4	114.0	48.3	34.5	88.0	174.0	116.8	44.0	35.2	
鋳鉄 Cast irons FC FCD	JS4045 GX2140 JP4120	n (min ⁻¹)	580	1,150	830	830	580	560	1,110	800	800	560	460	910	660	660	460	440	870	630	630	440	
		v _c (m/min)	90	180	130	130	90	90	180	130	130	90	90	180	130	130	90	90	180	130	130	90	
		v _f (mm/min)	4,350	10,350	6,230	6,230	4,350	5,490	13,990	7,840	7,840	5,490	4,140	9,830	5,940	5,940	4,140	4,930	12,530	7,060	7,060	4,930	
		f _z (mm/t)	1.5	1.8	1.5	1.5	1.5	1.4	1.8	1.4	1.4	1.4	1.5	1.8	1.5	1.5	1.5	1.4	1.8	1.4	1.4	1.4	
		a _p (mm)	1.5	1.5	1.5	1.0	0.7	1.25	1.0	0.8	0.6	0.4	1.5	1.5	1.5	1.0	0.7	1.25	1.0	0.8	0.6	0.4	
		a _e (mm)	40	40	40	40	40	40	40	40	40	40	50	50	50	50	50	50	50	50	50	50	
		Q (cm ³ /min)	261	621	374	249	122	275	560	251	188	88	311	737	446	297	145	308	627	282	212	99	
焼入れ鋼 Hardened steels プリハードン鋼 Pre-hardened steels 50-55HRC	JP4120 JP4105	n (min ⁻¹)	510	770	510	510	510	490	740	490	490	490	410	610	410	410	410	390	580	390	390	390	
		v _c (m/min)	80	120	80	80	80	80	120	80	80	80	80	120	80	80	80	80	120	80	80	80	
		v _f (mm/min)	510	770	510	510	510	690	1,040	690	690	690	500	740	500	500	500	630	930	630	630	630	
		f _z (mm/t)	0.2	0.2	0.2	0.2	0.2	0.2	0.2	0.2	0.2	0.2	0.2	0.2	0.2	0.2	0.2	0.2	0.2	0.2	0.2	0.2	
		a _p (mm)	1.0	1.0	1.0	0.7	0.5	0.4	0.25	0.35	0.25	0.15	1.0	1.0	1.0	0.7	0.5	0.4	0.25	0.35	0.25	0.15	
		a _e (mm)	40	40	40	40	40	40	40	40	40	40	50	50	50	50	50	50	50	50	50	50	
		Q (cm ³ /min)	20	31	20	14	10	11	10	10	7	4	25	37	25	18	13	13	12	11	8	5	
焼入れ鋼 Hardened steels 55-62HRC	JP4105	n (min ⁻¹)	390	640	390	390	390	370	620	370	370	370	310	510	310	310	310	290	490	290	290	290	
		v _c (m/min)	60	100	60	60	60	60	100	60	60	60	60	100	60	60	60	60	100	60	60	60	
		v _f (mm/min)	100	160	100	100	100	130	220	130	130	130	100	160	100	100	100	120	200	120	120	120	
		f _z (mm/t)	0.05	0.05	0.05	0.05	0.05	0.05	0.05	0.05	0.05	0.05	0.05	0.05	0.05	0.05	0.05	0.05	0.05	0.05	0.05	0.05	
		a _p (mm)	0.5	0.5	0.5	0.5	0.5	0.5	0.3	0.5	0.3	0.2	0.5	0.5	0.5	0.5	0.5	0.5	0.3	0.5	0.3	0.2	
		a _e (mm)	40	40	40	40	40	40	40	40	40	40	50	50	50	50	50	50	50	50	50	50	
		Q (cm ³ /min)	2.0	3.2	2.0	2.0	2.0	2.6	2.6	2.6	1.6	1.0	2.5	4.0	2.5	2.5	2.5	3.0	3.0	3.0	1.8	1.2	
最大 Maximum f _z (mm/t)		<2.0 (汎用 General purpose f _z :<1.0)					<1.8 (汎用 General purpose f _z :<1.0)					<2.0 (汎用 General purpose f _z :<1.0)					<1.8 (汎用 General purpose f _z :<1.0)						
最大 Maximum a _p (mm)		<2.0 (汎用 General purpose a _p :<1.5)					<1.5 (汎用 General purpose a _p :<1.0)					<2.0 (汎用 General purpose a _p :<1.5)					<1.5 (汎用 General purpose a _p :<1.0)						

Indexable Tools High Feed Radius End Mills

標準切削条件③ ボアタイプ Recommended Cutting Conditions for Bore Type

【注意】

- ①被削材、加工形状に合わせて、適切なクーラントを使用してください。
- ②この切削条件表は切削条件の目安を示すものです。実際の加工では加工形状、目的、使用機械等により条件を調整してください。
- ③本表は肩削り時の一般的な条件です。機械剛性やツーリング、加工物の状況に合わせて調整してください。
特に、溝切削の伴う、またはそれに近い切り込み幅の加工などでびびり振動が発生し、トラブルに至る場合がありますので下記を参考に調整してください。
・溝削りが伴う場合、C57、C58頁の切削領域を参照。
・ブレーカ付きインサートを使用する。
・回転数、テーブル送り量を50~70%下げる。
・切り込み深さを50~70%下げる。
- ④GXコーティング、JSコーティングは通電式タッチセンサーに反応しませんのでご注意ください。
- ⑤「JP4105」は高硬度鋼専用材種で、生材には適しません。
- ⑥強断続切削、突出しが長い場合及び湿式切削には「JM4160」を推奨します。
- ⑦切りくず噛み込みによる工具損傷防止のため、必ずエアブロー等による切りくず除去を行ってください。
- ⑧排出した切りくずは、飛散し作業者を切傷させ、火傷あるいは目に入って負傷させる恐れがありますので、ご使用に際してはその周囲に安全カバーを付け、保護メガネ等の保護具を着用し、安全な環境で作業されることをお願い致します。
- ⑨インサートの交換は早めに行い、過度の使用による破損を防止してください。
- ⑩下記に単位時間当たりの切りくず排出量Qを示します。
 $Q(\text{cm}^3/\text{min}) = a_p(\text{mm}) \times a_e(\text{mm}) \times v_f(\text{mm}/\text{min}) / 1000$
- ⑪切り込み深さの最大値を下記図に示します。最大値を超えないように設定してください。

【Note】

- ①Use the appropriate coolant for the work material and machining shape.
- ②These conditions are for general guidance; in actual machining conditions adjust the parameters according to your actual machine and work-piece conditions.
- ③This table shows the general conditions for shoulder milling. The conditions should be adjusted according to the machine rigidity, tooling, condition of object to be milled, etc. In particular, when performing shoulder milling in combination with slotting or machining of cutting widths close to slots, etc., chattering vibrations may occur, which can lead to trouble. Therefore, please consider the following when adjusting the conditions:
· When performing shoulder milling in combination with slotting, please refer to the cutting region on pp. C57 and C58.
· Use inserts equipped with breakers.
· Reduce rotation speed and table feed rate by 50 to 70%.
· Reduce cutting depth a_p by 50 to 70%.
- ④Please note that the GX Coating and JS Coating do not cause a reaction in conductive touch sensors.
- ⑤JP4105 is a hardened steel, and is not suitable for Non-heat-treated steel material.
- ⑥For strongly interrupted cutting, when unsupported length is long, or for wet cutting, JM4160 is recommended.
- ⑦As a measure to prevent tool damage due to chip jamming, always use an air blower, etc. to remove chips.
- ⑧Since there is a danger of the removed chips flying out and causing injury to workers, fire, or damage to eyes, during use be sure to cover the work area with a safety cover and have workers wear protective equipment such as glasses, etc. to make the work area safe.
- ⑨Perform insert replacement at an early stage to prevent chipping due to excessive use.
- ⑩The following equation expresses the chip removal amount per unit time:
 $Q(\text{cm}^3/\text{min}) = a_p(\text{mm}) \times a_e(\text{mm}) \times v_f(\text{mm}/\text{min}) / 1000$
- ⑪The maximum value of cut depth is shown in the table below. Be sure to use settings that do not exceed the maximum value.

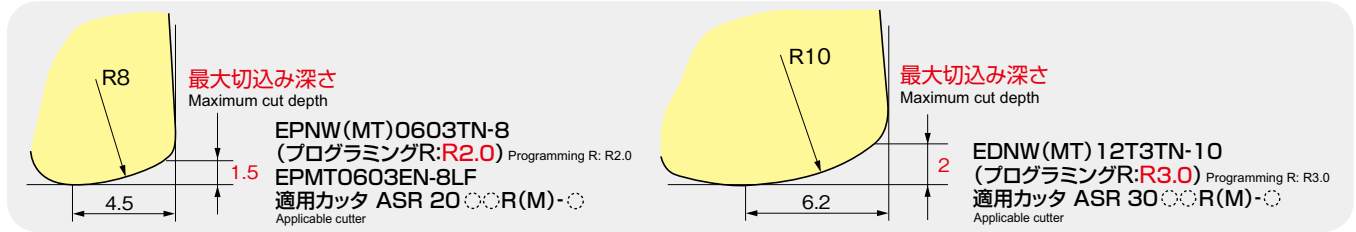

プログラム上の刃先形状定義は、下記図プログラミングRを参照ください。

When setting the definition of insert shape for programming, please refer to the Programming R in the diagram below.

商品コード Item code	プログラミングR Programming R	食込み量 Over cut	削り残し量 Remains
インサート Insert: EPNW(MT)0603TN-8 EPMT0603EN-8LF ボデー Body: ASRS/L/M20(S)R- ASR20R(M)-	R2.0	0	0.497
	R2.5	0.076	0.349
	R3.0	0.218	0.236
	R3.5	0.419	0.108
	R4.0	0.612	0.03
インサート Insert: EDNW(MT)12T3TN-10 ボデー Body: ASR30R(M)-	R3.0	0	0.700
	R3.5	0.03	0.542
	R4.0	0.155	0.394
	R4.5	0.319	0.259
	R5.0	0.5	0.144

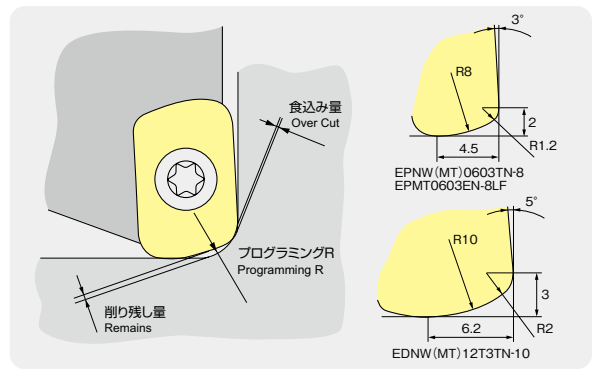

ダイレクトに彫り込み加工も可能

Processing by direct milling is also possible.

中心まで切れ刃がないため傾斜角度と穴径は制限されますが、下図に示しますように傾斜切削やヘリカル切削にて、下穴がなくともダイレクトに彫り込み加工が可能です。

Since the cutting flute do not extend to the center, there are limitations on the ramp angle and hole diameter, but as shown below, processing by direct milling without a pilot hole is possible for ramping and helical milling.

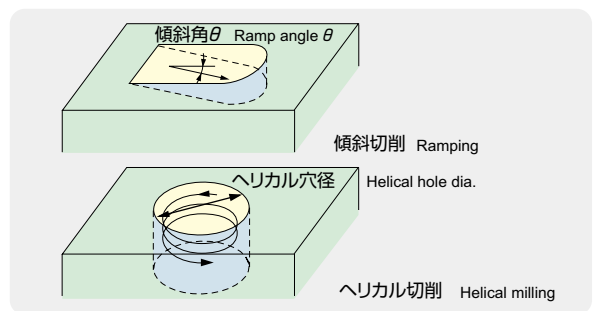

使用インサート Inserts	EPNW(MT)0603TN-8, EPMT0603EN-8LF											EPNW(MT)12T3TN-10	
	φ16	φ18	φ20	φ22	φ25	φ28	φ30	φ32	φ40	φ52	φ66	φ50	φ63
最大傾斜角θ Maximum ramp angle θ	4°	3.5°	3°	2.5°	2°	2°	2°	2°	1.5°	1°	0.5°	1.5°	1°
ヘリカル穴径 Helical hole dia.	22~30	26~34	30~38	34~42	40~48	46~54	50~58	54~62	70~78	94~102	122~130	83~98	109~124

【注意】 ①傾斜角θは上記範囲を超えない様に設定してください。0.5°以下での使用を推奨します。 ②穴径が上記範囲外の場合は下穴をあけて加工してください。 【Note】 ①The ramp angle θ should be set within the ranges listed above. Use at ramp angles of 0.5° or less is recommended. ②For helical hole diameters outside the ranges listed above, a pilot hole should be drilled before milling.

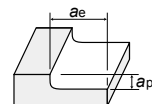

LF形インサート標準切削条件 [BT30用] Standard cutting conditions for LF type inserts (BT30 type)

被削材 Work material	推奨材種 Recommended grade	クーラント Coolant	工具径DCX Tool dia.	φ16(2枚刃) 2 Flutes			φ20(3枚刃) 3 Flutes			φ25(4枚刃) 4 Flutes		
				突出し量 Overhang (mm)	50	75	100	50	75	100	50	75
炭素鋼 Carbon-steels 合金鋼 Alloy-steels <30HRC 鋳鉄 Cast irons	JM4160	エア Air	n (min ⁻¹)	3,580	2,586	1,790	2,865	2,865	2,070	2,291	2,291	1,655
			v_c (m/min)	180	130	90	180	180	130	180	180	130
			v_f (mm/min)	5,728	4,138	2,864	6,876	6,876	4,970	7,331	7,331	5,296
			f_z (mm/t)	0.8	0.8	0.8	0.8	0.8	0.8	0.8	0.8	0.8
			a_p (mm)	0.5	0.5	0.4	0.6	0.5	0.4	0.6	0.5	0.5
			a_e (mm)	11	11	11	14	14	14	18	18	18
			Q (cm ³ /min)	32	23	13	58	48	28	79	66	48
			n (min ⁻¹)	3,580	2,586	1,790	2,865	2,865	2,070	2,291	2,291	1,655
			v_c (m/min)	180	130	90	180	180	130	180	180	130
			v_f (mm/min)	5,728	4,138	2,864	6,876	6,876	4,970	7,331	7,331	5,296
ステンレス鋼 Stainless steels	JM4160	エア Air	f_z (mm/t)	0.8	0.8	0.8	0.8	0.8	0.8	0.8	0.8	0.8
			a_p (mm)	0.5	0.5	0.4	0.6	0.5	0.4	0.6	0.5	0.5
			a_e (mm)	11	11	11	14	14	14	18	18	18
			Q (cm ³ /min)	32	23	13	58	48	28	79	66	48
			n (min ⁻¹)	2,586	2,586	1,790	2,070	2,070	1,432	1,655	1,655	1,273
		ウェット Wet	v_c (m/min)	130	130	90	130	130	90	130	130	100
			v_f (mm/min)	4,136	4,136	2,864	4,970	4,970	3,437	5,296	5,296	3,055
			f_z (mm/t)	0.8	0.8	0.8	0.8	0.8	0.8	0.8	0.8	0.8
			a_p (mm)	0.6	0.5	0.4	0.6	0.5	0.4	0.6	0.5	0.5
			a_e (mm)	11	11	11	14	14	14	18	18	18
Q (cm ³ /min)	27	23	13	42	35	19	57	48	27			
チタン合金 Titanium alloys	JM4160	ウェット Wet	n (min ⁻¹)	1,193	1,193	1,193	955	955	955	764	764	764
			v_c (m/min)	60	60	60	60	60	60	60	60	60
			v_f (mm/min)	954	954	954	1,146	1,146	1,146	1,222	1,222	1,222
			f_z (mm/t)	0.4	0.4	0.4	0.4	0.4	0.4	0.4	0.4	0.4
			a_p (mm)	0.6	0.5	0.4	0.8	0.6	0.5	1.0	0.8	0.6
			a_e (mm)	11	11	11	14	14	14	18	18	18
			Q (cm ³ /min)	6	5	4	13	10	8	22	18	13

EPMT0603EN-8LF
(プログラミングR:R2.0)
Programming R: R2.0
適用カッタ Applicable cutter
ASR S/L/M20○○○ ~
ASR 20○○○R(M)-○

LF形インサート標準切削条件 [BT40用] Standard cutting conditions for LF type inserts (BT40 type)

被削材 Work material	推奨材種 Recommended grade	クーラント Coolant	工具径DCX Tool dia.	φ16(2枚刃) 2 Flutes			φ20(3枚刃) 3 Flutes			φ25(4枚刃) 4 Flutes			φ32(5枚刃) 5 Flutes			φ40(6枚刃) 6 Flutes		
				突出し量 Overhang (mm)	50	75	100	50	75	100	50	75	100	50	75	100	50	75
炭素鋼 Carbon-steels 合金鋼 Alloy-steels <30HRC 鋳鉄 Cast irons	JM4160	エア Air	n (min ⁻¹)	3,580	2,586	1,790	2,865	2,865	2,070	2,291	2,291	1,655	1,790	1,790	1,790	1,432	1,432	1,432
			v_c (m/min)	180	130	90	180	180	130	180	180	130	180	180	180	180	180	180
			v_f (mm/min)	7,160	5,170	3,580	8,595	8,595	6,210	9,164	9,164	6,620	8,950	8,950	8,950	8,592	8,592	8,592
			f_z (mm/t)	1.0	1.0	1.0	1.0	1.0	1.0	1.0	1.0	1.0	1.0	1.0	1.0	1.0	1.0	1.0
			a_p (mm)	0.5	0.5	0.4	0.6	0.5	0.5	0.8	0.6	0.5	1.0	1.0	0.8	1.0	1.0	0.8
			a_e (mm)	11	11	11	14	14	14	18	18	18	22	22	22	28	28	28
			Q (cm ³ /min)	39	28	16	72	60	43	132	99	60	197	197	158	241	241	192
			n (min ⁻¹)	3,580	2,586	1,790	2,865	2,865	2,070	2,291	2,291	1,655	1,790	1,790	1,790	1,432	1,432	1,432
			v_c (m/min)	180	130	90	180	180	130	180	180	130	180	180	180	180	180	180
			v_f (mm/min)	7,160	5,170	3,580	8,595	8,595	6,210	9,164	9,164	6,620	8,950	8,950	8,950	8,592	8,592	8,592
ステンレス鋼 Stainless steels	JM4160	エア Air	f_z (mm/t)	1.0	1.0	1.0	1.0	1.0	1.0	1.0	1.0	1.0	1.0	1.0	1.0	1.0	1.0	
			a_p (mm)	0.5	0.5	0.4	0.6	0.5	0.5	0.8	0.6	0.5	1.0	1.0	0.8	1.0	1.0	
			a_e (mm)	11	11	11	14	14	14	18	18	18	22	22	22	28	28	
			Q (cm ³ /min)	39	28	16	72	60	43	132	99	60	197	197	158	241	241	
			n (min ⁻¹)	2,586	2,586	1,790	2,070	2,070	1,432	1,655	1,655	1,273	1,193	1,193	1,193	955	955	
		ウェット Wet	v_c (m/min)	130	130	90	130	130	90	130	130	100	120	120	120	120	120	
			v_f (mm/min)	5,172	5,172	3,580	6,210	6,210	4,296	6,620	6,620	5,092	5,965	5,965	4,772	5,730	5,730	
			f_z (mm/t)	1.0	1.0	1.0	1.0	1.0	1.0	1.0	1.0	1.0	1.0	1.0	1.0	1.0	1.0	
			a_p (mm)	0.6	0.5	0.4	0.6	0.5	0.4	0.8	0.6	0.5	1.0	1.0	0.8	1.0	1.0	
			a_e (mm)	11	11	11	14	14	14	18	18	18	22	22	22	28	28	
Q (cm ³ /min)	34	28	16	52	43	24	95	74	46	131	131	84	160	160				
チタン合金 Titanium alloys	JM4160	ウェット Wet	n (min ⁻¹)	1,193	1,193	1,193	955	955	955	764	764	764	597	597	597	477	477	
			v_c (m/min)	60	60	60	60	60	60	60	60	60	60	60	60	60	60	
			v_f (mm/min)	1,193	1,193	1,193	1,432	1,432	1,432	1,528	1,528	1,528	1,194	1,194	1,194	1,431	1,431	
			f_z (mm/t)	0.5	0.5	0.5	0.5	0.5	0.5	0.5	0.5	0.5	0.5	0.5	0.5	0.5	0.5	
			a_p (mm)	0.6	0.5	0.4	0.8	0.6	0.5	1.0	0.8	0.6	1.0	1.0	0.8	1.0	1.0	
			a_e (mm)	11	11	11	14	14	14	18	18	18	22	22	22	28	28	
			Q (cm ³ /min)	8	7	5	16	12	10	28	22	17	26	26	21	40	40	

LF形インサート標準切削条件

シャックタイプ / モジュラー超硬シャック / ポアタイプ

Standard cutting conditions for LF type inserts

Shank type

Modular Carbide Shank

Bore Type

◎標準切削条件①~③の「炭素鋼・合金鋼<30HRC」、「鋳鉄」、「ステンレス鋼」を参照してください。適用インサート材種はJM4160です。

• Refer to the standard cutting conditions ①, ②, ③ for "Carbon steels/alloy steels <30HRC", "Cast irons", and "Stainless steels". The applicable insert material is JM4160.

- [注意]**
- ①被削材、加工形状に合わせて、適切なクーラントを使用してください。
 - ②この切削条件表は切削条件の目安を示すものです。実際の加工では加工形状、目的、使用機械等により条件を調整してください。
 - ③本表は肩削り時の一般的な条件です。機械剛性や加工物の状況に合わせて調整してください。特にポケット加工時のような傾斜切り込みや溝加工の伴う場合、切り込み深さを50~60%下げてください。
 - ④LF形ブレーカは強断続切削には適しません。
 - ⑤排出した切りくずは、飛散し作業者を切傷させ、火傷あるいは目に入って負傷させる恐れがありますので、ご使用に際してはその周囲に安全カバーを取り付け、保護メガネ等の保護具を着用し、安全な環境で作業されることをお願いいたします。
 - ⑥インサートの交換は早めに行い、過度の使用による破損を防止してください。

- [Note]**
- ①Use the appropriate coolant for the work material and machining shape.
 - ②These conditions are for general guidance; in actual machining conditions adjust the parameters according to your actual machine and work-piece conditions.
 - ③These tables show general conditions for shoulder cutting. Please make adjustments according to the machine rigidity and work material conditions. In particular, for inclined cutting such as pocket machining or groove cutting, reduce cutting depth a_p by 50 to 60%.
 - ④LF type breakers are not suitable for strong interrupted cutting.
 - ⑤Since there is a danger of discharged chips flying out and causing injury to workers, fire, or damage to eyes, during use be sure to cover the work area with a safety cover and have workers wear protective equipment such as glasses to enable work to be performed in a safe environment.
 - ⑥Perform insert replacement at an early stage to prevent chipping due to excessive use.

High Hard Radius Mill RH2P

アルファ高硬度ラジアスマイル RH2P

- H級インサートと高精度ボデーの組合せにより、振れ精度を向上。寿命のバラツキを抑えました。
- プログラミングRで発生する削り残しを防ぐため、コーナRを2mmに設定しました。
- スクイ角を軸方向に対して負の角度に設定することで、刃先強度の向上と摩耗低減を実現しました。

・ Combination of high-accuracy-ground inserts (H grade) and high-accuracy bodies improves edge runout accuracy and stable cutting performance.
 ・ RH2P adopts corner R 2mm in order to reduce the remains by programming R.
 ・ By having negative setting of the rake angle against the axial direction, RH2P improves toughness of edges and reduces wear.



RH2P1○○○S(○○)-○ シャンクタイプ Shank type

○は数字が入ります。 Numeric figure in a circle ○

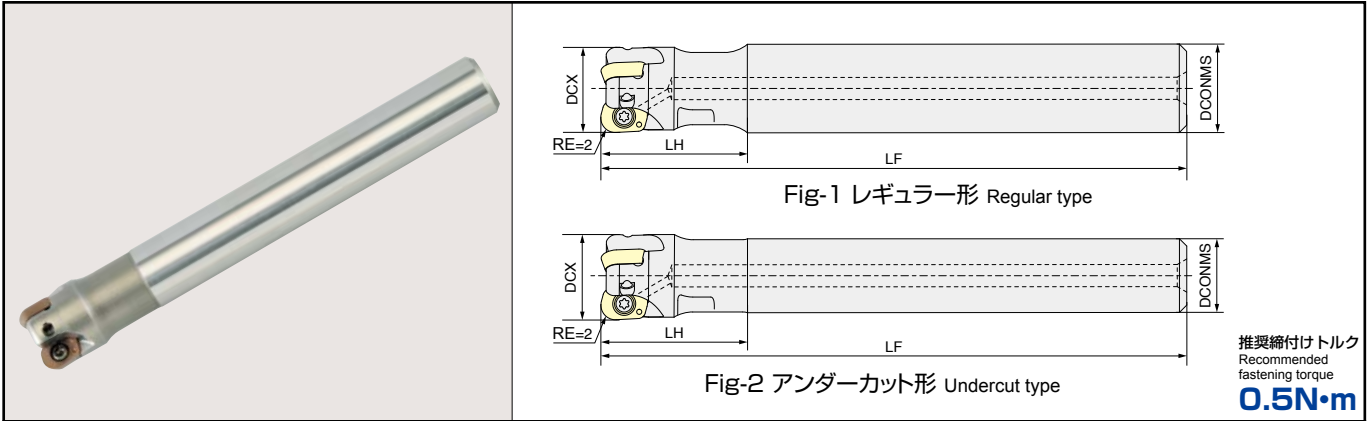

推奨締め付けトルク Recommended fastening torque **0.5N・m**

商品コード Item code	在庫 Stock	刃数 No. of flutes	寸法 Size (mm)				形状 Shape	希望小売価格(円) Suggested retail price (¥)
			DCX	LF	DCONMS	LH		
RH2P1008S-1	●	1	8	75	10	16	Fig-1	22,290
RH2P1010S-2	●	2	10	80	10	20	Fig-1	22,290
RH2P1010S08-2	●	2	10	80	8	20	Fig-2	22,290
RH2P1012S-3	●	3	12	80	12	20	Fig-1	26,980
RH2P1012S10-3	●	3	12	80	10	20	Fig-2	26,980
RH2P1016S-4	●	4	16	90	16	25	Fig-1	38,710
RH2P1020S-5	●	5	20	105	20	25	Fig-1	44,580

RH2P1○○○M-○ モジュラータイプ Modular type

○は数字が入ります。 Numeric figure in a circle ○

モジュラーミル用シャンクはD2頁を、締め付けトルクについてはD5頁を参照ください。 Refer page D2 about the shanks for Modular Mill, Refer page D5 about tightening torque

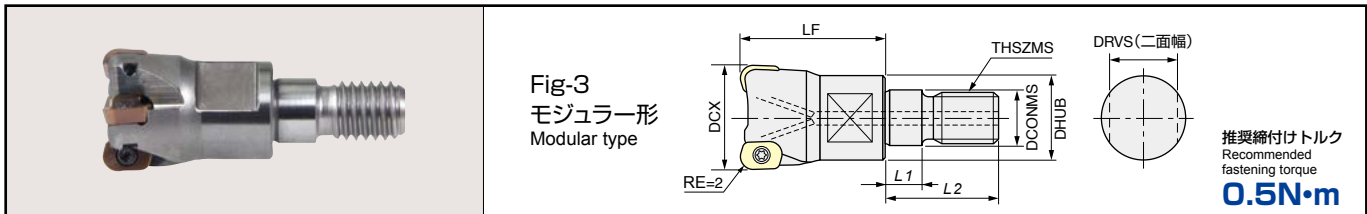

推奨締め付けトルク Recommended fastening torque **0.5N・m**

商品コード Item code	在庫 Stock	刃数 No. of flutes	寸法 Size (mm)								希望小売価格(円) Suggested retail price (¥)
			DCX	LF	DCONMS	THSZMS	DHUB	L1	L2	DRVS	
RH2P1008M-1	●	1	8	19	6.5	M6	9.4	5.5	14.5	7	22,290
RH2P1010M-2	●	2	10	17	6.5	M6	9.4	5.5	14.5	7	22,290
RH2P1012M-3	●	3	12	17	6.5	M6	9.8	5.5	14.5	7	26,980
RH2P1016M-4	●	4	16	22	8.5	M8	12.8	5.5	17	10	38,710
RH2P1020M-5	●	5	20	25	10.5	M10	17.8	5.5	19	15	44,580
RH2P1025M-6	●	6	25	25	12.5	M12	20.8	5.5	22	17	51,620
RH2P1032M-8	●	8	32	27	17	M16	28.8	6	23	22	64,520

【注意】モジュラーミル及び専用シャンク、専用アーバの「工具端面」「モジュラーねじ部」にグリースなどの潤滑剤は塗布しないでください。
 【Note】Do not apply lubricants such as grease, etc. to the "contact faces" and "modular screws" of the "modular mill", "dedicated shanks" and "dedicated arbor".

●印：標準在庫品です。 ●：Stocked items.

■ インサート Inserts

	P 鋼 Carbon steels							
	H 高硬度材 High hardness materials							
	商品コード Item code	精度 Tolerance class	AJコーティング AJ Coating		寸法 Size (mm)		希望小売価格(円) Suggested retail price (¥)	
EPHW0402TN-2	H級 H	●	●	RE	INSL	S	W1	1,180

■ 部品番号 Parts

部品名 Parts	クランプねじ Clamp screw			ドライバー Screw driver		ねじ焼き付き防止剤 Screw anti-seizure agent		
適用カッタ Cutter body		締付トルク Fastening torque (N·m)	希望小売価格(円) Suggested retail price (¥)		希望小売価格(円) Suggested retail price (¥)		希望小売価格(円) Suggested retail price (¥)	
RH2P10...	240-140	0.5	870	104-T6	1,800	P-37	1,010	

[注意] クランプねじは消耗品です。使用環境により交換寿命は変化しますので早めの交換をお願い致します。クランプねじは3枚刃までは予備が1本、4枚刃以上は予備が2本付属します。

[Note] The clamp screw is a consumable part. Since replacement life depends on the use environment, it is recommended that it be replaced at an early stage. One spare clamp screw is provided for cutter bodies with 3 or less flutes, and two for 4 or more flutes.

○ 標準切削条件表 Recommended cutting conditions

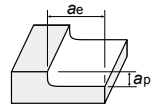

*赤字は第一推奨材種です。Red indicates primary recommended grade.

被削材 Work material	推奨材種 Recommended grade	切削条件 Cutting conditions	φ8/1枚刃 1 flute	φ10/2枚刃 2 flutes	φ12/3枚刃 3 flutes	φ16/4枚刃 4 flutes	φ20/5枚刃 5 flutes	φ25/6枚刃 6 flutes	φ32/8枚刃 8 flutes
プリハードン鋼 (40HRC以下) Pre-Hardened steels (40HRC or less)	※ JP4115	vc (m/min)	130	130	130	130	130	130	130
		n (min ⁻¹)	5,180	4,140	3,450	2,590	2,070	1,660	1,290
		fz (mm/t)	0.4	0.5	0.5	0.5	0.5	0.5	0.5
		vf (mm/min)	2,070	4,140	5,170	5,180	5,170	4,980	5,160
		ap (mm)	0.3	0.35	0.4	0.4	0.4	0.4	0.4
		ae (mm)	4.5	5	7	9.5	12	15	19
		Q (cm ³ /min)	2.8	7.2	14.5	19.7	24.8	29.9	39.2
プリハードン鋼 (40~50HRC) Pre-Hardened steels	JP4115	vc (m/min)	100	100	100	100	100	100	100
		n (min ⁻¹)	3,980	3,180	2,650	1,990	1,590	1,270	1,000
		fz (mm/t)	0.4	0.5	0.5	0.5	0.5	0.5	0.5
		vf (mm/min)	1,590	3,180	3,970	3,980	3,970	3,810	4,000
		ap (mm)	0.3	0.35	0.4	0.4	0.4	0.4	0.4
		ae (mm)	4.5	5	7	9.5	12	15	19
		Q (cm ³ /min)	2.1	5.6	11.1	15.1	19.1	22.9	30.4
焼入れ鋼 (50~55HRC) Hardened steels	JP4105 JP4115	vc (m/min)	90	90	90	90	90	90	90
		n (min ⁻¹)	3,580	2,870	2,390	1,790	1,430	1,150	900
		fz (mm/t)	0.4	0.4	0.4	0.4	0.4	0.4	0.4
		vf (mm/min)	1,430	2,290	2,860	2,860	2,860	2,760	2,880
		ap (mm)	0.2	0.3	0.3	0.3	0.3	0.3	0.3
		ae (mm)	4.5	5	7	9.5	12	15	19
		Q (cm ³ /min)	1.3	3.4	6.0	8.2	10.3	12.4	16.4
焼入れ鋼 (55~60HRC) Hardened steels	JP4105	vc (m/min)	75	75	75	75	75	75	75
		n (min ⁻¹)	2,990	2,390	1,990	1,490	1,190	960	750
		fz (mm/t)	0.3	0.4	0.4	0.4	0.4	0.4	0.4
		vf (mm/min)	890	1,910	2,380	2,380	2,380	2,300	2,400
		ap (mm)	0.15	0.2	0.2	0.2	0.2	0.2	0.2
		ae (mm)	3	4	5	6.5	8	10	13
		Q (cm ³ /min)	0.4	1.5	2.4	3.1	3.8	4.6	6.2
焼入れ鋼 (60~62HRC) Hardened steels	JP4105	vc (m/min)	65	65	65	65	65	65	65
		n (min ⁻¹)	2,590	2,070	1,730	1,290	1,040	830	650
		fz (mm/t)	0.25	0.3	0.3	0.3	0.3	0.3	0.3
		vf (mm/min)	640	1,240	1,550	1,540	1,560	1,490	1,560
		ap (mm)	0.15	0.15	0.15	0.15	0.15	0.15	0.15
		ae (mm)	3	4	5	6.5	8	10	13
		Q (cm ³ /min)	0.3	0.7	1.2	1.5	1.9	2.2	3.0

- [注意]**
- 被削材、加工形状に合わせて、適切なクーラントを使用してください。
 - この切削条件表は切削条件の目安を示すものです。実際の加工では、加工形状、目的、使用機械等により条件を調整してください。
 - 溝切削、傾斜切削の場合、送り速度は70%を目安としてください。
 - アンダーカット形状シャंकRH2P1010S08-2、RH2P1012S10-3をご使用の際は標準切削条件の1/4当たりの送り量(fz)を50~70%を目安に低減してください。
 - インサートの交換は早めに行い、過度の使用による破損を防止してください。
 - 排出した切りくずは、飛散し作業者を切傷させ、やけどあるいは目に入って負傷させる恐れがありますので、ご使用に際してはその周囲に安全カバーを取付け、保護メガネなどの保護具を着用し、安全な環境で作業されることをお願い致します。
 - 不水溶性切削油は、火災の恐れがありますので使用しないでください。

- [Note]**
- Use the appropriate coolant for the work material and machining shape.
 - These conditions are for general guidance; in actual cutting conditions adjust the parameters according to your actual machine and work-piece conditions.
 - For slotting or ramping, feed rate should be set to 70% as recommended cutting conditions.
 - When using an RH2P1010S08-2 or RH2P1012S10-3 undercut type shank, as a general rule the feed rate per flute (fz) should be reduced to 50~70% of the value listed in the recommended cutting conditions.
 - Ensure to exchange the insert at the correct time to ensure safety of the tool-body.
 - The evacuation of swarf can cause burns, cuts or damage to the eyes please ensure the correct safety cover is fitted around the machine, and necessary personal protection equipment is worn by the machine operator.
 - Due to fire risks do not use cutting oil as a coolant.

傾斜切削 / ヘリカル切削 Ramping / Helical milling

工具径 Tool diameter φ mm	φ8	φ10	φ12	φ16	φ20	φ25	φ32
最大傾斜角 Max. ramp angle °	0.5° 以下 (最大1.0°) Less than 0.5° (max. 1.0°)						
ヘリカル穴径 Helical milling / Hole dia.(mm)	10-15	13-19	17-23	25-31	33-39	43-49	57-63

穴径が上記範囲外の場合は下穴をあけて加工してください。For hole diameters outside the ranges listed above, a pilot hole should be drilled before milling.

Radius Mill AHR(Heavy Radius Mill)

アルファヘビーラジiasmil AHR

● 鋳造法等で造られた加工取代が不均一なワークでも、切込み量を気にせず使用できるロング切刃を設けたラジiasmilです。

・ A radius mill designed with long cutting flutes enables use without worrying about cutting depth, even for objects manufactured by casting for which machining bite is nonuniform.



AHR 42R/MT5-M シャンクタイプ Shank type

○は数字、□は英文字が入ります。
Numeric figure in a circle and Alphabetical character comes in a square

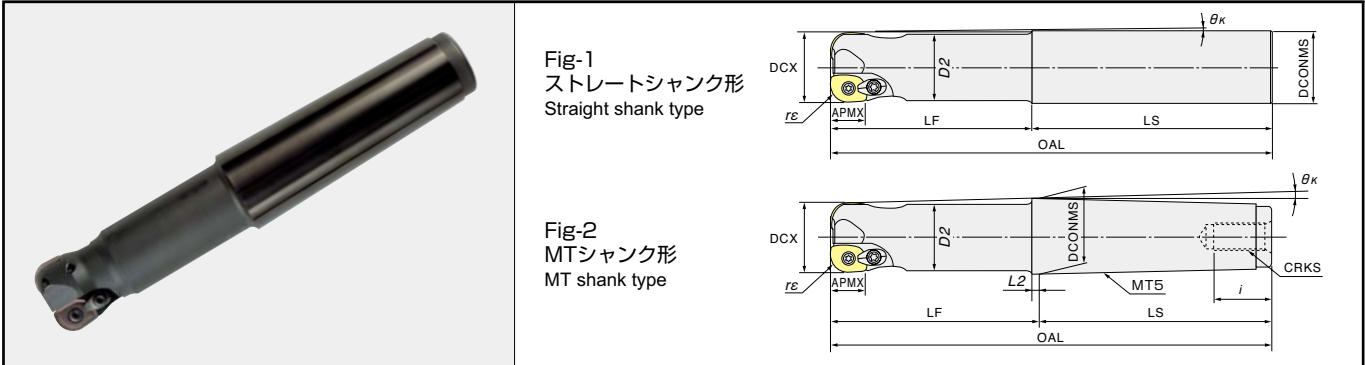

商品コード Item code	在庫 Stock	刃数 No. of flutes	寸法 Size (mm)													形状 Shape	適用インサート Inserts	希望小売 価格(円) Suggested retail price (¥)
			DCX	rε	APMX	OAL	LF	LS	DCONMS	D2	L2	i	CRKS	θk				
AHRS404042R	●	3	40	8	18	150	50	100	42	38	—	—	—	1.4°	Fig-1		51,620	
AHRS4040MT5-M16	●	3	40	8	18	249.5	120	129.5	44.399	38	6.5	32	M16	1.3°	Fig-2	ZDNW1204080TR	75,550	
AHRS4040MT5-M20		3	40	8	18	249.5	120	129.5	44.399	38	6.5	40	M20	1.3°		ZDMT1204080TR	—	
AHRS4040MT5-M24		3	40	8	18	249.5	120	129.5	44.399	38	6.5	45	M24	1.3°			—	
AHRS504042R	●	2	40	10	18	150	50	100	42	38	—	—	—	1.5°	Fig-1		46,920	
AHRS5040MT5-M16	●	2	40	10	18	249.5	120	129.5	44.399	38	6.5	32	M16	1.3°	Fig-2		70,860	
AHRS5040MT5-M20		2	40	10	18	249.5	120	129.5	44.399	38	6.5	40	M20	1.3°		ZDNW1505100TR	—	
AHRS5040MT5-M24		2	40	10	18	249.5	120	129.5	44.399	38	6.5	45	M24	1.3°	ZDMT1505100TR	—		
AHRS5050MT5-M16	●	3	50	10	18	249.5	120	129.5	44.399	48	6.5	32	M16	—			87,750	
AHRS5050MT5-M20		3	50	10	18	249.5	120	129.5	44.399	48	6.5	40	M20	—			—	
AHRS5050MT5-M24		3	50	10	18	249.5	120	129.5	44.399	48	6.5	45	M24	—			—	
AHRM404042R	●	3	40	8	18	250	50	200	42	38	—	—	—	1.4°	Fig-1		68,630	
AHRM4040MT5-M16	●	3	40	8	18	299.5	170	129.5	44.399	38	6.5	32	M16	0.9°	Fig-2	ZDNW1204080TR	89,980	
AHRM4040MT5-M20		3	40	8	18	299.5	170	129.5	44.399	38	6.5	40	M20	0.9°		ZDMT1204080TR	—	
AHRM4040MT5-M24		3	40	8	18	299.5	170	129.5	44.399	38	6.5	45	M24	0.9°			—	
AHRM504042R	●	2	40	10	18	250	50	200	42	38	—	—	—	1.5°	Fig-1		63,930	
AHRM5040MT5-M16	●	2	40	10	18	299.5	170	129.5	44.399	38	6.5	32	M16	0.9°	Fig-2		85,290	
AHRM5040MT5-M20		2	40	10	18	299.5	170	129.5	44.399	38	6.5	40	M20	0.9°		ZDNW1505100TR	—	
AHRM5040MT5-M24		2	40	10	18	299.5	170	129.5	44.399	38	6.5	45	M24	0.9°	ZDMT1505100TR	—		
AHRM5050MT5-M16	●	3	50	10	18	299.5	170	129.5	44.399	48	6.5	32	M16	—			99,120	
AHRM5050MT5-M20		3	50	10	18	299.5	170	129.5	44.399	48	6.5	40	M20	—			—	
AHRM5050MT5-M24		3	50	10	18	299.5	170	129.5	44.399	48	6.5	45	M24	—			—	
AHRL404042R	●	3	40	8	18	300	50	250	42	38	—	—	—	1.5°	Fig-1		81,770	
AHRL4040MT5-M16	●	3	40	8	18	349.5	220	129.5	44.399	38	6.5	32	M16	0.7°	Fig-2	ZDNW1204080TR	91,380	
AHRL4040MT5-M20		3	40	8	18	349.5	220	129.5	44.399	38	6.5	40	M20	0.7°		ZDMT1204080TR	—	
AHRL4040MT5-M24		3	40	8	18	349.5	220	129.5	44.399	38	6.5	45	M24	0.7°			—	
AHRL504042R	●	2	40	10	18	300	50	250	42	38	—	—	—	1.5°	Fig-1		77,080	
AHRL5040MT5-M16	●	2	40	10	18	349.5	220	129.5	44.399	38	6.5	32	M16	0.7°	Fig-2		90,910	
AHRL5040MT5-M20		2	40	10	18	349.5	220	129.5	44.399	38	6.5	40	M20	0.7°		ZDNW1505100TR	—	
AHRL5040MT5-M24		2	40	10	18	349.5	220	129.5	44.399	38	6.5	45	M24	0.7°	ZDMT1505100TR	—		
AHRL5050MT5-M16	●	3	50	10	18	349.5	220	129.5	44.399	48	6.5	32	M16	—			102,300	
AHRL5050MT5-M20		3	50	10	18	349.5	220	129.5	44.399	48	6.5	40	M20	—			—	
AHRL5050MT5-M24		3	50	10	18	349.5	220	129.5	44.399	48	6.5	45	M24	—			—	
AHRE504042R	●	2	40	10	18	350	50	300	42	38	—	—	—	1.5°	Fig-1		95,960	
AHRE5040MT5-M16	●	2	40	10	18	429.5	300	129.5	44.399	38	6.5	32	M16	0.5°	Fig-2		101,940	
AHRE5040MT5-M20		2	40	10	18	429.5	300	129.5	44.399	38	6.5	40	M20	0.5°		ZDNW1505100TR	—	
AHRE5040MT5-M24		2	40	10	18	429.5	300	129.5	44.399	38	6.5	45	M24	0.5°	ZDMT1505100TR	—		
AHRE5050MT5-M16	●	3	50	10	18	429.5	300	129.5	44.399	48	6.5	32	M16	—			115,900	
AHRE5050MT5-M20		3	50	10	18	429.5	300	129.5	44.399	48	6.5	40	M20	—			—	
AHRE5050MT5-M24		3	50	10	18	429.5	300	129.5	44.399	48	6.5	45	M24	—			—	

刃先交換式工具
ラジiasmil

○は数字が入ります。 Numeric figure in a circle ○

AHR5○○○R(M)-○ ボア Bore type

ボアタイプ用アーバはD11頁を参照ください。
Refer page D11 about the bore type arbor

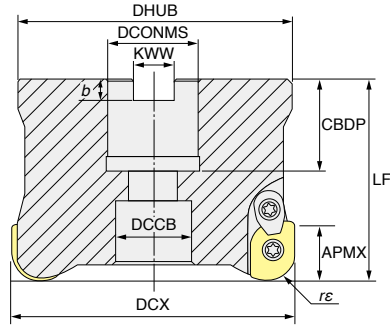

Fig.-3 ボア形 Bore type

商品コード Item code	在庫 Stock	刃数 No. of flutes	寸法 Size (mm)											形状 Shape	適用インサート Inserts	希望小売 価格(円) Suggested retail price (¥)
			DCX	rε	APMX	DHUB	Lf	CBDP	KWW	b	DCONMS	DCCB				
ボアタイプ 内径 インチ サイズ Internal diameter inch size	●	3	63	10	18	60	50	19	8.4	5	22.225	17	Fig-3	ZDNW1505100TR ZDMT1505100TR	58,780	
	●	4	63	10	18	60	50	19	8.4	5	22.225	17			71,100	
		4	80	10	18	76	70	32	12.7	8	31.75	26			—	
	●	5	80	10	18	76	70	32	12.7	8	31.75	26			107,810	
		5	100	10	18	96	70	32	12.7	8	31.75	26			—	
	●	6	100	10	18	96	70	32	12.7	8	31.75	26			145,460	
	●	6	125	10	18	100	63	32	12.7	8	31.75	26			160,710	
ボアタイプ 内径 ミリ サイズ Internal diameter mm size	●	3	63	10	18	60	50	20	10.4	6.3	22	17	Fig-3	ZDNW1505100TR ZDMT1505100TR	58,780	
	●	4	63	10	18	60	50	20	10.4	6.3	22	17			71,100	
		4	80	10	18	76	70	22	12.4	7	27	20			—	
	●	5	80	10	18	76	70	22	12.4	7	27	20			107,810	
	●	6	100	10	18	96	70	25	14.4	8	32	26			145,460	
	●	6	125	10	18	100	63	30	16.4	9	40	32			160,710	

【注意】アーバ用ねじは付属しません。

【Note】Arbor screw is not included.

アルファヘビーラジアスマイル AHR

■ インサート Inserts

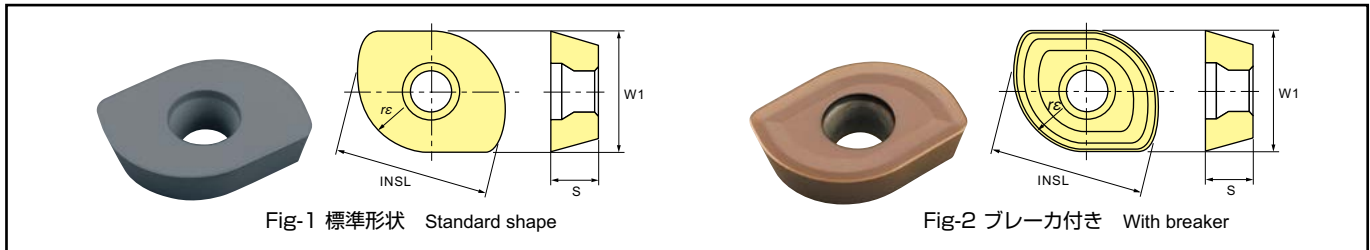

P	鋼	Carbon steels	■	■	■	■ : 一般切削・第一推奨 General cutting, First recommended						
	M	SUS等	SUS, etc.	■	■		■ : 一般切削・第二推奨 General cutting, Second recommended					
K	FC・FCD	Cast irons	□	□	■							
H	高硬度材	Hardened steels	■	□								
商品コード (メートル系) Item code (metric)	精度 Tolerance class	AJコーティング AJ Coating			JSコーティング JS Coating		寸法 Size (mm)				形状 Shape	希望小売価格 (円) Suggested retail price(¥)
		JP4105	JP4120	JM4160	JS4045	JS4060	rε	INSL	S	W1		
ZDNW1204080TR	N級 N	●	●	●	●	●	8	21.5	4.76	12.7	Fig-1	1,900
ZDNW1505100TR		●	●	●	●	●	10	21.5	5.56	15.875		2,390
ZDMT1204080TR	M級 M	●	●	●	●	●	8	21.5	4.76	12.7	Fig-2	1,900
ZDMT1505100TR		●	●	●	●	●	10	21.5	5.56	15.875		2,390

【注意】 JSコーティングは通電式タッチセンサーに反応しませんのでご注意ください。
 【Note】 Please note that the JS Coating does not cause a reaction in conductive touch sensors.

■ 部品番号 Parts

部品名 Parts	形状 Shape	クランプねじ Clamp screw	クランプ駒セット Clamp piece set	レンチ Wrench	ねじ焼き付き防止剤 Screw anti-seizure agent					
適用カッタ Cutter body		締付トルク Fastening torque (N・m)	希望小売 価格(円) Suggested retail price(¥)	希望小売 価格(円) Suggested retail price(¥)	希望小売 価格(円) Suggested retail price(¥)					
AHR S/M/L 4040 42R/MT5-M		262-142	2.9	870	CM4-141	2,030	105-T15	2,120		
AHR S/M/L/E 5040 42R/MT5-M		555-141	4.9	690	CM5-147	2,030	105-T20	2,120	P-37	1,010
AHR S/M/L/E 5050 MT5-M										
AHR 5000R/RM-										

【注意】 クランプねじは消耗品です。使用環境により交換寿命は変化しますので早めの交換をお願い致します。クランプねじは予備が1本付属します。
 【Note】 The clamp screw is a consumable part. Since replacement life depends on the use environment, it is recommended that it be replaced at an early stage. Includes one spare clamp screw.

■ MT5シャंक用アーバ MT5 Shank Arbor

商品コード Item code	在庫 Stock	寸法 Size (mm)						適用カッタ Cutter body	希望小売価格(円) Suggested retail price(¥)
		MT番号 MT No.	BD1	DCONWS	LB2	LB1	BHTA2		
BT50-MTB503-70-65	●	MT5	65	44.399	70	30	5°	AHR S/M/L 4040MT5-M16 AHR S/M/L/E 5040MT5-M16 AHR S/M/L/E 5050MT5-M16	103,230

【注意】 レンチは14mm六角レンチをご使用ください。 【Note】 Please use 14mm hexagon wrench.

●印：標準在庫品です。 ●：Stocked items.

■ インサートの形状違いによる特長比較例 Feature comparison by insert shape

形状 Shape	アルファヘビーラジアスマイルAHR形 (R10インサート) Heavy radius mill AHR type (R10 insert)	アルファヘビーラジアスマイルAHR形 (R8インサート) Heavy radius mill AHR type (R8 insert)	従来品丸駒ラジアスマイル Conventional round end radius mill
最大切込み深さ Maximum cutting depth	大 Deep	大 Deep	基準 Standard
刃先強度 Toughness of cutting edge	大 High	同等 Equivalent	基準 Standard
寿命 Tool life	長い Long	同等 Equivalent	基準 Standard
切削抵抗 Cutting force	大(約1.2倍) High (Approx. 1.2x)	同等 Equivalent	基準 Standard
カスプ高さ Cusp height	小 Small	同等 Equivalent	基準 Standard

■ ダイレクトに彫り込み加工も可能 Cutting by direct milling is also possible.

中心まで切れ刃がないため傾斜角度と穴径は制限されますが、右図に示しますように傾斜切削やヘリカル切削にて、下穴がなくてもダイレクトに彫り込み加工が可能です。

Since the cutting flute do not extend to the center, there are limitations on the ramp angle and hole diameter, but as shown right, cutting by direct milling without a pilot hole is possible for ramping and helical milling.

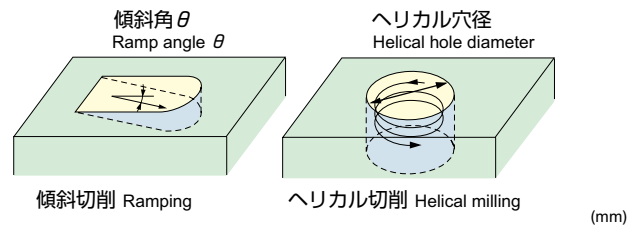

工具径DCX Tool dia.	φ40-R8	φ40-R10	φ50	φ63	φ80	φ100	φ125
推奨θ Recommended ramp angle	1°以下 1° or less					0.5°以下 0.5° or less	
最大傾斜角θ Max ramp angle	3°	4.5°	2.9°	1.9°	1.3°	1°	0.7°
ヘリカル穴径 Hole diameter	60~78	56~78	76~98	102~124	136~158	176~198	226~248

- [注意]** 1. 傾斜角θは上記範囲を超えない様に設定してください。0.5°以下での使用を推奨します。 2. 穴径が上記範囲外の場合は下穴を明けて加工してください。
[Note] 1. The ramp angle θ should be set within the ranges listed above. Use at ramp angles of 0.5° or less is recommended. 2. For hole diameters outside the ranges listed above, a pilot hole should be drilled before milling.

■ 切削領域 Cutting range

AHR5063R-4(φ63-R10-4枚刃 4 Flutes)
 インサート Insert : ZDNW1505100TR
 $V_c=180\text{m/min}(n=909\text{min}^{-1}), f_z=0.3\text{mm/t}(V_f=1091\text{mm/min})$
 Work:FCD450,Dry 機械 Machine : 立型M/C 15kW Vertical MC:15kW

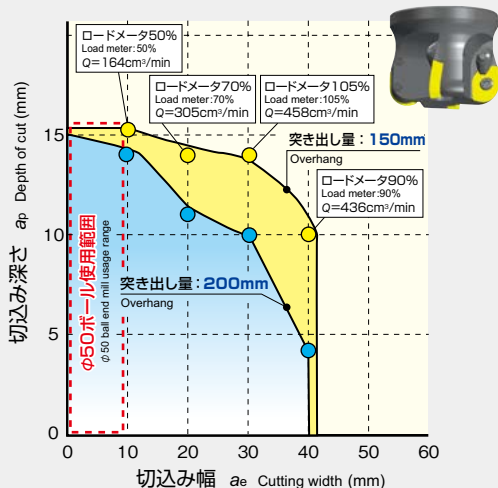

AHR5080R-5(φ80-R10-5枚刃 5 Flutes)
 インサート Insert : ZDNW1505100TR
 $V_c=180\text{m/min}(n=716\text{min}^{-1}), f_z=0.3\text{mm/t}(V_f=1074\text{mm/min})$
 Work:FCD450,Dry 機械 Machine : 立型M/C 15kW Vertical MC:15kW

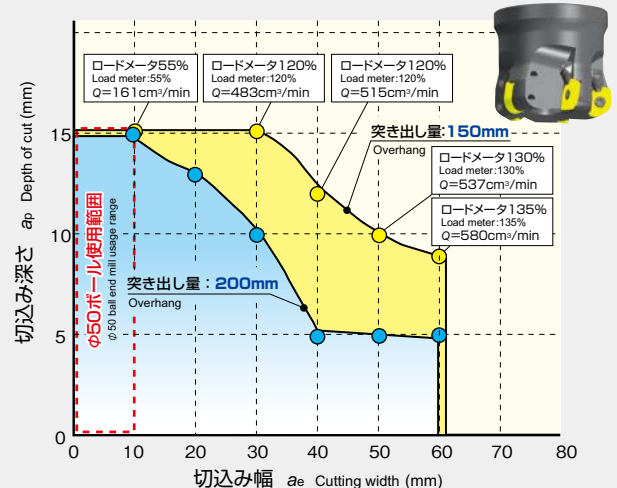

標準切削条件表 Recommended cutting conditions

※赤字は第一推奨材種です。Red indicates primary recommended grade.

被削材 Work material	推奨材種 Recommended grade	切削条件 Cutting conditions	φ40(2枚刃 2 Flutes)				φ50(3枚刃 3 Flutes)			
			<2DCX	2DCX -3DCX	3DCX -4DCX	>5DCX	<2DCX	2DCX -3DCX	3DCX -4DCX	>5DCX
炭素鋼 Carbon-steels 合金鋼 Alloy-steels <30HRC	※ JS4060 JS4045	回転数 n (min ⁻¹)	1,440	1,200	1,040	720	1,150	960	830	580
		切削速度 V_c (m/min)	180	150	130	90	180	150	130	90
		テーブル送り V_f (mm/min)	2,020	1,440	1,040	720	2,420	1,730	1,250	870
		1刃送り f_z (mm/t)	0.7	0.6	0.5	0.5	0.7	0.6	0.5	0.5
		切込み深 a_p (mm)	5	4	3	2	5	4	3	2
		切込み幅 a_e (mm)	28	24	24	20	35	30	30	25
		切りくず排出量 Q Volume cm ³ /min	283	138	75	29	424	208	113	44
		回転数 n (min ⁻¹)	1,440	1,200	1,040	720	1,150	960	830	580
プリハードン鋼 Pre-Hardened steels 合金鋼 Alloy-steels 30~40HRC	JS4060 JS4045	切削速度 V_c (m/min)	180	150	130	90	180	150	130	90
		テーブル送り V_f (mm/min)	2,020	1,440	1,040	720	2,420	1,730	1,250	870
		1刃送り f_z (mm/t)	0.7	0.6	0.5	0.5	0.7	0.6	0.5	0.5
		切込み深 a_p (mm)	5	4	3	2	5	4	3	2
		切込み幅 a_e (mm)	28	24	24	20	35	30	30	25
		切りくず排出量 Q Volume cm ³ /min	283	138	75	29	424	208	113	44
		回転数 n (min ⁻¹)	1,200	1,040	880	720	960	830	710	580
		切削速度 V_c (m/min)	150	130	110	90	150	130	110	90
プリハードン鋼 Pre-Hardened steels 合金鋼 Alloy-steels 40~50HRC	JP4120 JS4045	テーブル送り V_f (mm/min)	960	840	710	580	1,160	1,000	860	700
		1刃送り f_z (mm/t)	0.4	0.4	0.4	0.4	0.4	0.4	0.4	0.4
		切込み深 a_p (mm)	3	2.5	2	1.5	3	2.5	2	1.5
		切込み幅 a_e (mm)	28	24	24	20	35	30	30	25
		切りくず排出量 Q Volume cm ³ /min	81	50	34	17	122	75	52	26
		回転数 n (min ⁻¹)	960	800	720	640	760	640	570	510
		切削速度 V_c (m/min)	120	100	90	80	120	100	90	80
		テーブル送り V_f (mm/min)	1,340	960	720	640	1,600	1,150	860	770
ステンレス鋼 (湿式切削) Stainless steels (Wet condition)	JM4160	1刃送り f_z (mm/t)	0.7	0.6	0.5	0.5	0.7	0.6	0.5	0.5
		切込み深 a_p (mm)	5	4	3	2	5	4	3	2
		切込み幅 a_e (mm)	28	24	24	20	35	30	30	25
		切りくず排出量 Q Volume cm ³ /min	188	92	52	26	280	138	77	39
		回転数 n (min ⁻¹)	1,440	1,200	1,040	720	1,150	960	830	580
		切削速度 V_c (m/min)	180	150	130	90	180	150	130	90
		テーブル送り V_f (mm/min)	2,020	1,440	1,040	720	2,420	1,730	1,250	870
		1刃送り f_z (mm/t)	0.7	0.6	0.5	0.5	0.7	0.6	0.5	0.5
鋳鉄 Cast irons FC FCD	JP4120 JS4045	切込み深 a_p (mm)	5	4	3	2	5	4	3	2
		切込み幅 a_e (mm)	28	24	24	20	35	30	30	25
		切りくず排出量 Q Volume cm ³ /min	283	138	75	29	424	208	113	44
		回転数 n (min ⁻¹)	1,000	850	720	640	800	680	580	510
		切削速度 V_c (m/min)	125	106	90	80	125	106	90	80
		テーブル送り V_f (mm/min)	400	340	290	260	480	410	350	310
		1刃送り f_z (mm/t)	0.2	0.2	0.2	0.2	0.2	0.2	0.2	0.2
		切込み深 a_p (mm)	2	1.5	1	0.5	2	1.5	1	0.5
焼入れ鋼 Hardened steels (50~55HRC)	JP4120 JP4105	切込み幅 a_e (mm)	28	24	24	20	35	30	30	25
		切りくず排出量 Q Volume cm ³ /min	22	12	7	3	34	18	11	4
		回転数 n (min ⁻¹)	480	480	480	480	390	390	390	390
		切削速度 V_c (m/min)	60	60	60	60	60	60	60	60
		テーブル送り V_f (mm/min)	50	50	50	50	60	60	60	60
		1刃送り f_z (mm/t)	0.05	0.05	0.05	0.05	0.05	0.05	0.05	0.05
		切込み深 a_p (mm)	0.5	0.4	0.3	0.2	0.5	0.4	0.3	0.2
		切込み幅 a_e (mm)	28	24	24	20	35	30	30	25
焼入れ鋼 Hardened steels (55~62HRC)	JP4105	切りくず排出量 Q Volume cm ³ /min	0.7	0.5	0.4	0.2	1.1	0.7	0.5	0.3

【注意】 ①本表は肩削り時の一般的な条件です。機械剛性やツールリング、加工物の状況に合わせて調整してください。特に、溝切削の伴う、またはそれに近い切り込み幅の加工などでびびり振動が発生し、トラブルに至る場合がありますので下記を参考に調整してください。

- ・ブレーカ付きインサートを使用する。
- ・回転数、テーブル送り量を50~70%下げる。
- ・切り込み深さ a_p を50~70%下げる。
- ②JSコーティングは通電式タッチセンサーに反応しませんのでご注意ください。
- ③「JP4105」は高硬度鋼専用材種で、生材には適しません。
- ④強断続切削、突出しが長い場合及び湿式切削には「JM4160」を推奨します。
- ⑤切りくず噛み込みによる工具損傷防止のため、必ずエアブロー等による切りくず除去を行ってください。
- ⑥排出した切りくずは、飛散し作業者を切傷させ、火傷あるいは目に入って負傷させる恐れがありますので、ご使用に際してはその周囲に安全カバーを取付け、保護メガネ等の保護具を着用し、安全な環境で作業されることをお願い致します。
- ⑦インサートの交換は早めに行い、過度の使用による破損を防止してください。
- ⑧下記に単位時間当たりの切りくず排出量 Q を示します。

$$Q(\text{cm}^3/\text{min}) = a_p(\text{mm}) \times a_e(\text{mm}) \times v_f(\text{mm}/\text{min}) / 1000$$

φ63(4枚刃 4 Flutes)				φ80(5枚刃 5 Flutes)			φ100(6枚刃 6 Flutes)			φ125(6枚刃 6 Flutes)			被削材 Work material
<2DCX	2DCX -3DCX	3DCX -4DCX	>5DCX	<1DCX	1DCX -2DCX	2DCX -3DCX	<1DCX	1DCX -2DCX	2DCX -3DCX	<1DCX	1DCX -2DCX	2DCX -3DCX	
910	760	660	460	720	520	360	580	420	290	460	340	230	炭素鋼 Carbon-steels 合金鋼 Alloy-steels <30HRC
180	150	130	90	180	130	90	180	130	90	180	130	90	
2,550	1,830	1,320	920	2,520	1,300	900	2,440	1,260	870	1,940	1,020	690	
0.7	0.6	0.5	0.5	0.7	0.5	0.5	0.7	0.5	0.5	0.7	0.5	0.5	
5	4	3	2	5	4	3	5	4	3	5	4	3	
45	38	38	32	55	50	40	70	60	50	90	75	65	
574	278	150	59	693	260	108	854	302	131	873	306	135	プリハードン鋼 Pre-Hardened steels 合金鋼 Alloy-steels 30~40HRC
910	760	660	460	720	520	360	580	420	290	460	340	230	
180	150	130	90	180	130	90	180	130	90	180	130	90	
2,550	1,830	1,320	920	2,520	1,300	900	2,440	1,260	870	1,940	1,020	690	
0.7	0.6	0.5	0.5	0.7	0.5	0.5	0.7	0.5	0.5	0.7	0.5	0.5	
5	4	3	2	5	4	3	5	4	3	5	4	3	
45	38	38	32	55	50	40	70	60	50	90	75	65	プリハードン鋼 Pre-Hardened steels 合金鋼 Alloy-steels 40~50HRC
574	278	150	59	693	260	108	854	302	131	873	306	135	
760	660	560	460	600	440	360	480	360	290	390	290	230	
150	130	110	90	150	110	90	150	110	90	150	110	90	
1,220	1,060	900	740	1,200	880	720	1,160	870	700	940	700	560	
0.4	0.4	0.4	0.4	0.4	0.4	0.4	0.4	0.4	0.4	0.4	0.4	0.4	
3	2.5	2	1.5	3	2	2	3	2	2	3	2	2	ステンレス鋼 (湿式切削) Stainless steels (Wet condition)
45	38	38	32	55	50	40	70	60	50	90	75	65	
165	101	68	36	198	8	58	244	104	70	254	105	73	
610	510	460	400	480	400	360	380	320	290	310	260	230	
120	100	90	80	120	100	90	120	100	90	120	100	90	
1,710	1,220	920	800	1,680	1,000	900	1,600	960	870	1,300	780	690	
0.7	0.6	0.5	0.5	0.7	0.5	0.5	0.7	0.5	0.5	0.7	0.5	0.5	鋳鉄 Cast irons FC FCD
5	4	3	2	5	4	3	5	4	3	5	4	3	
45	38	38	32	55	50	40	70	60	50	90	75	65	
385	185	105	51	462	200	108	560	230	131	585	234	135	
910	760	660	460	720	520	360	580	420	290	460	340	230	
180	150	130	90	180	130	90	180	130	90	180	130	90	
2,550	1,830	1,320	920	2,520	1,300	900	2,440	1,260	870	1,940	1,020	690	焼入れ鋼 Hardened steels (50~55HRC)
0.7	0.6	0.5	0.5	0.7	0.5	0.5	0.7	0.5	0.5	0.7	0.5	0.5	
5	4	3	2	5	4	3	5	4	3	5	4	3	
45	38	38	32	55	50	40	70	60	50	90	75	65	
574	278	150	59	693	260	108	854	302	131	873	306	135	
640	540	460	410	500	360	320	400	290	260	320	230	210	
125	106	90	80	125	90	80	125	90	80	125	90	80	焼入れ鋼 Hardened steels (55~62HRC)
520	440	370	330	500	360	320	480	350	320	390	280	260	
0.2	0.2	0.2	0.2	0.2	0.2	0.2	0.2	0.2	0.2	0.2	0.2	0.2	
2	1.5	1	0.5	2	1.5	1	2	1.5	1	2	1.5	1	
45	38	38	32	55	50	40	70	60	50	90	75	65	
47	25	14	5	55	27	13	67	32	16	70	32	17	
310	310	310	310	240	240	240	200	200	200	160	160	160	
60	60	60	60	60	60	60	60	60	60	60	60	60	焼入れ鋼 Hardened steels (55~62HRC)
70	70	70	70	60	60	60	60	60	60	50	50	50	
0.05	0.05	0.05	0.05	0.05	0.05	0.05	0.05	0.05	0.05	0.05	0.05	0.05	
0.5	0.4	0.3	0.2	0.5	0.3	0.2	0.5	0.3	0.2	0.5	0.3	0.2	
45	38	38	32	55	50	40	70	60	50	90	75	65	
1.6	1.1	0.8	0.4	1.7	0.9	0.4	2.1	1.1	0.6	2.2	1.1	0.7	

[Note] ① This table shows the general conditions for shoulder milling. The conditions should be adjusted according to the machine rigidity, tooling, condition of object to be milled, etc. In particular, when performing shoulder milling in combination with slotting or machining of cutting widths close to slots, etc., chattering vibrations may occur, which can lead to trouble. Therefore, please consider the following when adjusting the conditions:

- ・Use inserts equipped with breakers.
- ・Reduce rotation speed and table feed rate by 50 to 70%.
- ・Reduce cutting depth a_p by 50 to 70%.

- ② Please note that the JS Coating does not cause a reaction in conductive touch sensors.
- ③ JP4105 is a special high-hardness steel, and is not suitable for Non-heat-treated steel material.
- ④ For strongly interrupted cutting, when unsupported length is long, or for wet cutting, JM4160 is recommended.
- ⑤ As a measure to prevent tool damage due to chip jamming, always use an air blower, etc. to remove chips.
- ⑥ Since there is a danger of the removed chips flying out and causing injury to workers, fire, or damage to eyes, during use be sure to cover the work area with a safety cover and have workers wear protective equipment such as glasses, etc. to make the work area safe.
- ⑦ Perform insert replacement at an early stage to prevent chipping due to excessive use.
- ⑧ The following equation expresses the chip removal amount per unit time:

$$Q(\text{cm}^3/\text{min.}) = a_p(\text{mm}) \times a_e(\text{mm}) \times v_f(\text{mm}/\text{min})/1000$$

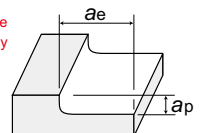

快削形アルファラジアスミルAR

- 15°ポジ円形インサート使用。
- ダイレクトに彫り込み加工ができます。
- Z方向の切込みや傾斜切削ができます。
- 難削材や高硬度材 (50 ~ 55HRC) の切削にも適します。

・ Uses 15° positive round inserts.
 ・ Can perform direct plunge cutting.
 ・ Can perform Z-direction or slant milling.
 ・ Also suitable for cutting high-hardness materials (50 to 55HRC) and difficult-to-cut materials.



○は数字が入ります。 Numeric figure in a circle ○

ARM○○○○R-○ モジュラータイプ Modular type

モジュラーミル用シャンクはD2頁を、締め付けトルクについてはD5頁を参照ください。
 Refer page D2 about the shanks for Modular Mill, Refer page D5 about tightening torque

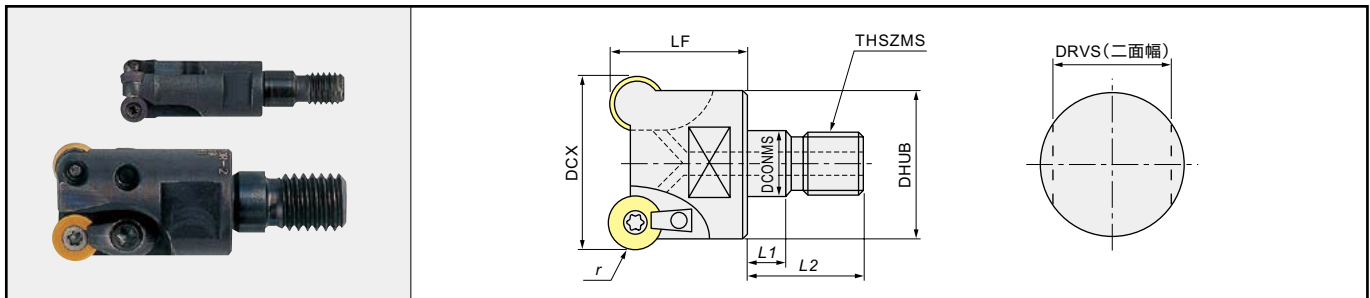

商品コード Item code	在庫 Stock	刃数 No. of flutes	寸法 Size (mm)									適用インサート Inserts	希望小売価格 (円) Suggested retail price (¥)
			DCX	r	LF	DCONMS	THSZMS	DHUB	L1	L2	DRVS		
※1 ARM0512R-2	●	2	12	2.5	20	6.5	M6	9.8	5.5	14.5	7	RDMW0501M0EN	29,330
※1 ARM0512R-3	●	3	12	2.5	20	6.5	M6	9.8	5.5	14.5	7		33,090
ARM0716R-2	●	2	16	3.5	25	8.5	M8	12.8	5.5	17	10	RDMW0702M0EN	29,330
ARM0020R-2	●	2	20	4	30	10.5	M10	17.8	5.5	19	15	RDHW0802M0TN RDMT0802M0TN	31,450
※ ARM0022R-2	●	2	22	4	30	10.5	M10	17.8	5.5	19	15	RDMT0802M0EN	31,450
ARM3025R-2	●	2	25	5	35	12.5	M12	20.8	5.5	22	17	RDHW10T3M0TN RDMT10T3M0TN RDMT10T3M0EN	33,090
※ ARM3028R-2	●	2	28	5	35	12.5	M12	23	5.5	22	17		33,090
ARM3030R-3	●	3	30	5	40	17	M16	28.8	6	23	22		38,250
ARM3032R-2	●	2	32	5	40	17	M16	28.8	6	23	22		35,670
ARM3032R-3	●	3	32	5	40	17	M16	28.8	6	23	22		38,250
※ ARM3040R-4	●	4	40	5	40	17	M16	28.8	6	23	22		51,620

- 【注意】** ①※と超硬シャンクをセットで使用すると干渉がありません。②※1工具径(DCX)がφ12の場合はエアークが付いておりません。
 ③モジュラーミル及び専用シャンク、専用アーバの「工具端面」「モジュラーねじ部」にグリースなどの潤滑剤は塗布しないでください。
- 【Note】** ①When ※ and carbide shank are used together as a set, there is no interference. ②※1 with tool dia. (DCX) of φ12 do not have air holes.
 ③Do not apply lubricants such as grease, etc. to the “contact faces” and “modular screws” of the “modular mill”, “dedicated shanks” and “dedicated arbor”.

部品番号 Parts

○は数字が入ります。 Numeric figure in a circle ○

部品名 Parts	クランプねじ Clamp screw			クランプ駒セット Clamp piece set		ドライバー Screw Driver		ねじ焼き付き防止剤 Screw anti-seizure agent	
形状 Shape	適用カット Cutter body	縮付トルク Fastening torque (N·m)	希望小売 価格(円) Suggested retail price (¥)	希望小売 価格(円) Suggested retail price (¥)	希望小売 価格(円) Suggested retail price (¥)	希望小売 価格(円) Suggested retail price (¥)	希望小売 価格(円) Suggested retail price (¥)	希望小売 価格(円) Suggested retail price (¥)	
ARM0512R-○	240-140	0.4	870	—	—	104-T6	1,800	P-37	1,010
ARM0716R-2	250-141	1.1	870	—	—	104-T8	1,800		
ARM0020R-2	261-140	1.1	870	CM3.5-141	2,030	104-T8	1,800		
ARM0022R-2						104-T15	2,060		
ARM3025R-2	501-161	2.9	870	CM3.5-141	2,030	104-T15	2,060		
ARM3028R-2									
ARM3030R-3									
ARM3032R-○									
ARM3040R-4									

- 【注意】** クランプねじは消耗品です。使用環境により交換寿命は変化しますので早めの交換をお願い致します。
【Note】 The clamp screw is a consumable part. Since replacement life depends on the use environment, it is recommended that it be replaced at an early stage.

●印：標準在庫品です。 ●：Stocked items.

AR() R() シャンクタイプ Shank type

○は数字、□は英文字が入ります。
Numeric figure in a circle ○ and Alphabetical character comes in a square □

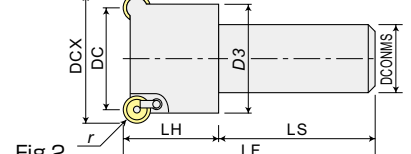
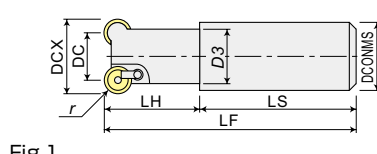

商品コード Item code	在庫 Stock	刃数 No. of flutes	寸法 Size (mm)								形状 Shape	適用インサート Inserts	希望小売価格(円) Suggested retail price (¥)	
			DCX	DC	LF	DCONMS	r	LH	LS	D3				
※ARS0020R	●	2	20	12	130	20	4	50	80	18	Fig.1	RDHW0802M0TN RDMT0802M0TN RDMT0802M0EN	31,450	
※ARS3025R	●	2	25	15	140	25	5	60	80	21		RDHW10T3M0TN RDMT10T3M0TN RDMT10T3M0EN	33,090	
※ARS3030R	●	3	30	20	150	32	5	70	80	26		RDHW1204M0TN RDMT1204M0TN RDMT1204M0EN	38,250	
※ARS3032R	●	3	32	22	150	32	5	70	80	28		RDHW1604M0TN RDMX1604M0TN RDMT1604M0EN	38,250	
※ARS4040R	●	3	40	28	150	32	6	50	100	35	Fig.2	RDHW1204M0TN RDMT1204M0TN RDMT1204M0EN	50,800	
※ARS4050R	●	3	50	38	150	32	6	50	100	45		RDHW1604M0TN RDMX1604M0TN RDMT1604M0EN	52,670	
※ARS4050R42	●	4	50	38	150	42	6	50	100	45		RDHW1604M0TN RDMX1604M0TN RDMT1604M0EN	55,490	
ARS5040R	●	2	40	24	150	32	8	50	100	35		RDHW1604M0TN RDMX1604M0TN RDMT1604M0EN	47,980	
ARS5050R	●	3	50	34	150	32	8	50	100	44		RDHW1604M0TN RDMX1604M0TN RDMT1604M0EN	52,670	
ARS5050R42	●	3	50	34	150	42	8	50	100	44		RDHW1604M0TN RDMX1604M0TN RDMT1604M0EN	52,670	
ARS5063R	●	3	63	47	150	32	8	50	100	58		RDHW1604M0TN RDMX1604M0TN RDMT1604M0EN	61,940	
ARS5063R42	●	3	63	47	150	42	8	50	100	58		RDHW1604M0TN RDMX1604M0TN RDMT1604M0EN	61,940	
※ARL0020R	●	2	20	12	180	20	4	100	80	18		Fig.1	RDHW0802M0TN RDMT0802M0TN RDMT0802M0EN	34,610
※ARL3025R	●	2	25	15	200	25	5	120	80	21			RDHW10T3M0TN RDMT10T3M0TN RDMT10T3M0EN	36,370
※ARL3030R	●	3	30	20	200	32	5	120	80	26	RDHW1204M0TN RDMT1204M0TN RDMT1204M0EN		42,120	
※ARL3032R	●	3	32	22	200	32	5	120	80	28	RDHW1204M0TN RDMT1204M0TN RDMT1204M0EN		42,120	
※ARL4032R	●	2	32	20	250	32	6	150	100	28	Fig.2	RDHW1604M0TN RDMX1604M0TN RDMT1604M0EN	47,280	
※ARL4040R	●	3	40	28	250	32	6	50	200	35		RDHW1604M0TN RDMX1604M0TN RDMT1604M0EN	55,610	
※ARL4050R42	●	4	50	38	250	42	6	50	200	45		RDHW1604M0TN RDMX1604M0TN RDMT1604M0EN	60,770	
ARL5040R	●	2	40	24	250	32	8	50	200	35		RDHW1604M0TN RDMX1604M0TN RDMT1604M0EN	52,790	
ARL5050R42	●	3	50	34	250	42	8	50	200	44		RDHW1604M0TN RDMX1604M0TN RDMT1604M0EN	57,950	
ARL5063R42	●	3	63	47	250	42	8	50	200	58		RDHW1604M0TN RDMX1604M0TN RDMT1604M0EN	68,170	
※ARE0020R	●	2	20	12	250	20	4	130	120	18	Fig.1	RDHW0802M0TN RDMT0802M0TN RDMT0802M0EN	36,250	
※ARE3025R	●	2	25	15	300	25	5	180	120	21		RDHW10T3M0TN RDMT10T3M0TN RDMT10T3M0EN	38,250	
※ARE3030R	●	2	30	20	300	32	5	180	120	26		RDHW1204M0TN RDMT1204M0TN RDMT1204M0EN	44,120	
※ARE3032R	●	3	32	22	300	32	5	180	120	28		RDHW1204M0TN RDMT1204M0TN RDMT1204M0EN	44,120	
※ARE4032R	●	2	32	20	300	32	6	180	120	28	Fig.2	RDHW1604M0TN RDMX1604M0TN RDMT1604M0EN	47,280	
※ARE4040R	●	2	40	28	300	32	6	50	250	35		RDHW1604M0TN RDMX1604M0TN RDMT1604M0EN	52,920	
※ARE4050R42	●	2	50	38	300	42	6	50	250	45		RDHW1604M0TN RDMX1604M0TN RDMT1604M0EN	55,490	

※:エア一穴付き。※:With air-hole.

部品番号 Parts

部品名 Parts	クランプねじ (インサート用) Clamp screw for Inserts	クランプ駒セット Clamp piece set	クランプ駒 Clamp piece	クランプねじ (クランプ駒用) Clamp screw for clamp piece	バネ Spring	ドライバー/レンチ Screw driver/Wrench								
形状 Shape														
適用カット Cutter body	縮付トルク Fastening torque (N·m)	希望小売価格(円) Suggested retail price (¥)	希望小売価格(円) Suggested retail price (¥)	希望小売価格(円) Suggested retail price (¥)	希望小売価格(円) Suggested retail price (¥)	希望小売価格(円) Suggested retail price (¥)								
ARS/L/E0020R	261-140	1.1	870	CM3.5-141	2,030	—	—	—	—	—	104-T8	A	1,800	
ARS/L/E3025R~ARS/L/E3032R	501-161	2.9	870	CM3.5-141	2,030	—	—	—	—	—	104-T15	A	2,060	
ARS/L/E4032R~ARS/L/E4050R(42)	262-142	2.9	870	CM4-141	2,030	—	—	—	—	—	104-T15	A	2,060	
ARS/L5040R~ARS/L5063R(42)	223-141	4.9	870	—	—	215-192	1,360	200-150	540	715-201	120	105-T20	B	2,120

【注意】クランプねじは消耗品です。使用環境により交換寿命は変化しますので早めの交換をお願い致します。
【Note】The clamp screw is a consumable part. Since replacement life depends on the use environment, it is recommended that it be replaced at an early stage.

Indexable Tools

Radius End Mills

快削形アルファラジアスミルAR

○は数字が入ります。Numeric figure in a circle ○

ARB○○○○R-○(M) AR5○○○○R ポアタイプ Bore type

ポアタイプ用アーバはD11頁を参照ください。
Refer page D11 about the bore type arbor

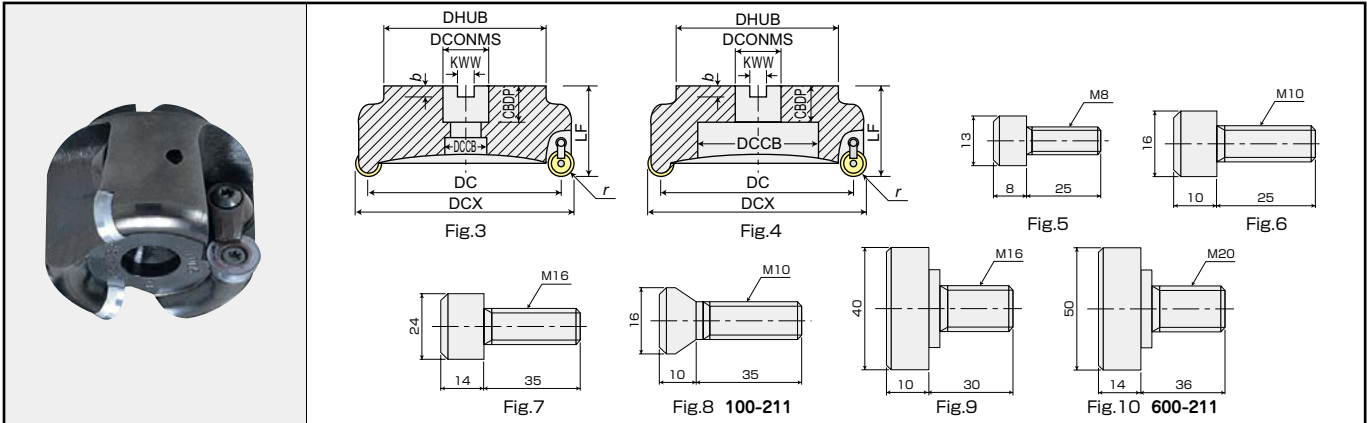

商品コード Item code	在庫 Stock	刃数 No. of flutes	寸法 Size(mm)											形状 Shape	適用インサート Inserts	希望小売 価格(円) Suggested retail price (¥)
			DCX	DC	DHUB	r	LF	DCONMS	DCCB	KWW	b	CBDP	アーバ用ねじ Arbor screw			
ARB4040R-3	●	3	40	28	32	6	50	16	13.5	8.4	5.6	19	M8×25 (Fig.5)	Fig.3	RDHW1204M0TN	57,250
ARB4050R-3	●	3	50	38	48	6	50	22.225	17	8.4	5	19	M10×25 (Fig.6)		RDMT1204M0TN	58,070
ARB4050R-5	●	5	50	38	48	6	50	22.225	17	8.4	5	19	M10×25 (Fig.6)		RDMT1204M0EN	85,630
ARB4050R-3M	●	3	50	38	48	6	50	22	17	10.4	6.3	20	M10×25 (Fig.6)			58,070
ARB4050R-5M	●	5	50	38	48	6	50	22	17	10.4	6.3	20	M10×25 (Fig.6)			85,630
ARB4063R-4	●	4	63	51	61	6	50	22.225	17	8.4	5	19	M10×25 (Fig.6)			74,960
ARB4063R-6	●	6	63	51	61	6	50	22.225	17	8.4	5	19	M10×25 (Fig.6)			103,230
ARB4063R-4M	●	4	63	51	61	6	50	22	17	10.4	6.3	20	M10×25 (Fig.6)			74,960
ARB4063R-6M	●	6	63	51	61	6	50	22	17	10.4	6.3	20	M10×25 (Fig.6)			102,770
ARB4080R-4	●	4	80	68	76	6	70	31.75	26	12.7	8	32	M16×35 (Fig.7)			80,010
ARB4080R-6	●	6	80	68	76	6	70	31.75	26	12.7	8	32	M16×35 (Fig.7)			107,810
ARB4100R-5	●	5	100	88	96	6	70	31.75	26	12.7	8	32	M16×35 (Fig.7)			99,360
ARB4125R-6	●	6	125	113	102	6	70	38.1	55	15.9	10	38	M20 (Fig.10)		Fig.4	120,820
ARB5063R-3	●	3	63	47	61	8	50	22.225	17	8.4	5	19	M10×25 (Fig.6)	Fig.3	RDHW1605M0TN	61,130
ARB5080R-4	●	4	80	64	76	8	70	31.75	26	12.7	8	32	M16×35 (Fig.7)		RDMT1605M0TN	80,010
ARB5100R-5	●	5	100	84	96	8	70	31.75	26	12.7	8	32	M16×35 (Fig.7)		RDMT1605M0EN	99,360
ARB5125R-6	●	6	125	109	102	8	70	38.1	55	15.9	10	38	M20 (Fig.10)	Fig.4	120,820	
AR5047R	●	3	63	47	47	8	47	22.225	16.5	8.4	5	19	M10 (Fig.8)	Fig.3	RDHW1604M0TN	55,850
AR5080R	●	4	96	80	65	8	63	31.75	43	12.7	8	32	M16 (Fig.9)		RDMX1604M0TN	86,460
AR5100R	●	5	116	100	85	8	63	38.1	53	15.9	10	38	M20 (Fig.10)	Fig.4	RDMX1604M0EN	114,840
AR5125R	●	6	141	125	85	8	63	38.1	60	15.9	10	38	M20 (Fig.10)		RDMT1604M0TN	145,460

【注意】カッタ取付のアーバ用ねじは、カッタ本体には付属しておりません。例外として、AR5047Rはアーバ用ねじ(100-211)が付属致します。

【Note】Arbor screws for cutter as lours are not equipped with cutter bodies. AR5047R exceptionally has arbor screws (100-211).

部品番号 Parts

○は数字が入ります。 Numeric figure in a circle ○

部品名 Parts	クランプねじ (インサート用) Clamp screw for inserts	クランプ駒セット Clamp piece set	クランプ駒 Clamp piece	クランプねじ (クランプ駒用) Clamp screw for clamp piece	バネ Spring	レンチ Wrench	ねじ焼き付き防止剤 Screw anti-seizure agent
形状 Shape							
適用カッタ Cutter body	締付トルク Fastening torque (N·m)	希望小売価格(円) Suggested retail price (¥)	希望小売価格(円) Suggested retail price (¥)	希望小売価格(円) Suggested retail price (¥)	希望小売価格(円) Suggested retail price (¥)	希望小売価格(円) Suggested retail price (¥)	希望小売価格(円) Suggested retail price (¥)
ARB4○○○R-○(M)	262-142	2.9 870	CM4-141 2,030	— —	— —	105-T15 2,120	—
ARB5○○○R-○	263-141	4.9 870	CM5-147 2,030	— —	— —	105-T20 2,120	P-37 1,010
AR5○○○R	223-141	4.9 870	— —	215-192 1,360	200-150 540	715-201 120	105-T20 2,120

【注意】クランプねじは消耗品です。使用環境により交換寿命は変化しますので早めの交換をお願い致します。

【Note】The clamp screw is a consumable part. Since replacement life depends on the use environment, it is recommended that it be replaced at an early stage.

インサート Inserts

○は数字が入ります。 Numeric figure in a circle ○

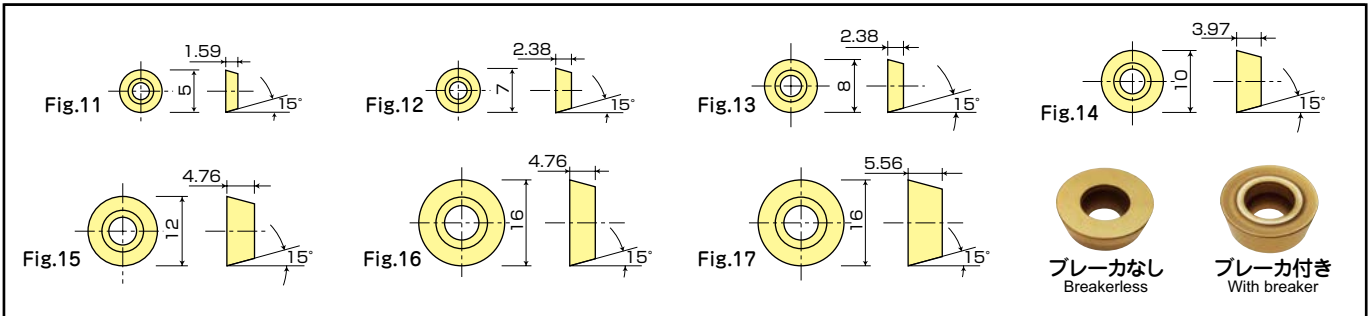

商品コード Item code	精度 Tolerance class	コーティング										形状 Shape	適用カッタ Cutter body	希望小売価格(円) Suggested retail price (¥)		
		AJコーティング AJ Coating	JSコーティング JS Coating	THコーティング TH Coating	Cコーティング C Coating	Gコーティング G Coating	K	AJ,JS TH コーティング AJ,JS TH Coating	CY100H CY25 CY250 GF30	WH10						
RDMW0501M0EN	M級 ブレイカなし M breakerless	●*		●		●						Fig.11	ARM0512R-2 ARM0512R-3	870	800	—
RDMW0702M0EN	M級 ブレイカなし M breakerless	●*		●		●						Fig.12	ARM0716R-2	940	850	—
RDHW0802M0TN	H級 ブレイカなし H breakerless			●	●							Fig.13	ARS0020R ARL0020R ARE0020R	1,560	1,410	—
RDMT0802M0TN	M級 ブレイカ付き M with breaker	●	●	●	●			●	●				ARM0020R-2 ARM0022R-2	940	850	—
RDMT0802M0EN	M級 ブレイカ付き M with breaker										●			—	—	660
RDHW10T3M0TN	H級 ブレイカなし H breakerless				●							Fig.14	ARS30○R ARL30○R ARE30○R	1,640	1,500	—
RDMT10T3M0TN	M級 ブレイカ付き M with breaker	●	●	●	●				●	●			ARM3025R-2 ARM3040R-4	1,030	940	—
RDMT10T3M0EN	M級 ブレイカ付き M with breaker							●			●			—	940	730
RDHW1204M0TN	H級 ブレイカなし H breakerless				●							Fig.15	ARS40○R(42) ARL40○R(42) ARE40○R	1,690	1,530	—
RDMT1204M0TN	M級 ブレイカ付き M with breaker	●	●	●	●					●			ARB4○R○(M)	1,320	1,200	—
RDMT1204M0EN	M級 ブレイカ付き M with breaker													—	—	—
RDHW1604M0TN	H級 ブレイカなし H breakerless				●							Fig.16	ARS50○R(42) ARL50○R(42) ARE50○R(42)	2,520	2,300	—
RDMT1604M0TN	M級 ブレイカ付き M with breaker	●	●	●	●					●			ARS50○R	1,940	1,760	—
RDMT1604M0EN	M級 ブレイカ付き M with breaker							●			●			—	1,760	1,360
RDHW1605M0TN	H級 ブレイカなし H breakerless				●							Fig.17	ARB5○R○	2,720	2,480	—
RDMT1605M0TN	M級 ブレイカ付き M with breaker	●		●	●										2,090	1,910
RDMT1605M0EN	M級 ブレイカ付き M with breaker													—	—	—

※ RDMW0501M0EN: JP4105、RDMW0702M0EN: JP4105の第二推奨被削材種は、P: 鋼、K: FC・FCDになります。
 Secondary recommended work material for RDMW0501M0EN: JP4105 and RDMW0702M0EN: JP4105 are P (steel) and K (FC, FCD).

[注意] JSコーティングは通電式タッチセンサーに反応しませんのでご注意ください。
 [Note] Please note that the JS Coating does not cause a reaction in conductive touch sensors.

●印: 標準在庫品です。 ●: Stocked items. 無印: 弊社営業へお問合せください。 No mark: Contact with our sales department.

快削形アルファラジアスミルAR

標準切削条件表 Recommended cutting conditions

ARS レギュラー形 Regular	ARL ロング形 Long	ARE エキストラロング形 Extra Long
---------------------------------	----------------------------	---------------------------------------

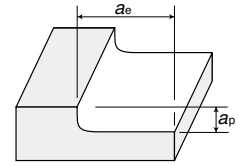

※赤字は第一推奨材種です。Red indicates primary recommended grade.

被削材 Work material	推奨材種 Recommended grade	切削速度 m/min Cutting speed	使用機械 Spindle of machine	一刃当りの送り mm/t Feed rate	φ20(2枚刃 2 Flutes r4)			φ25(2枚刃 2 Flutes r5)			φ32(3枚刃 3 Flutes r5)		
					回転数 min ⁻¹	送り速度 mm/min	Q 値 cm ³ /min	回転数 min ⁻¹	送り速度 mm/min	Q 値 cm ³ /min	回転数 min ⁻¹	送り速度 mm/min	Q 値 cm ³ /min
一般構造用鋼 Mild steels (200HB以下)	※ JS4060 JS4045	150~ 250	BT40	0.3~ 0.8	3,980	3,180	28.6	3,180	2,540	28.6	2,490	2,990	43.1
					vc=250m/min fz=0.4mm/t ap=1.5mm ae=0.3DCX								
					3,980	3,180	47.7	3,180	2,540	47.6	2,490	2,990	71.8
炭素鋼・合金鋼 Carbon & Alloy steels (30HRC以下)	JS4060 JS4045	120~ 230	BT40	0.3~ 0.8	3,180	2,540	22.9	2,550	2,040	23	1,990	2,390	34.4
					vc=200m/min fz=0.4mm/t ap=1.5mm ae=0.3DCX								
					3,180	2,540	38.1	2,550	2,040	38.3	1,990	2,390	57.4
炭素鋼・合金鋼 Carbon & Alloy steels (30~40HRC)	JS4060 JS4045	100~ 200	BT40	0.2~ 0.6	2,390	960	8.6	1,910	760	8.6	1,490	890	12.8
					vc=150m/min fz=0.2mm/t ap=1.5mm ae=0.3DCX								
					2,390	1,430	21.5	1,910	1,150	21.6	1,490	1,340	32.2
炭素鋼・合金鋼 Carbon & Alloy steels (40~45HRC)	JP4120 JS4045	60~ 150	BT40	0.15~ 0.3	1,590	480	2.9	1,270	380	2.9	990	450	4.3
					vc=100m/min fz=0.15mm/t ap=1mm ae=0.3DCX								
					1,590	640	6.4	1,270	510	6.4	990	590	9.4
ステンレス鋼 Stainless steels SUS	JM4160	150~ 240	BT40	0.2~ 0.8	3,180	1,590	14.3	2,550	1,280	14.4	1,990	1,490	21.5
					vc=200m/min fz=0.25mm/t ap=1.5mm ae=0.3DCX								
					2,860	1,716	25.7	2,290	1,370	25.7	1,790	1,610	38.6
鋳鉄 Cast irons FC, FCD	JP4120	100~ 220	BT40	0.3~ 1.0	2,860	2,290	20.6	2,290	1,830	20.6	1,790	2,150	31
					vc=180m/min fz=0.4mm/t ap=1.5mm ae=0.3DCX								
					2,860	2,860	42.9	2,290	2,290	42.9	1,790	2,690	64.6
焼入れ鋼 Hardened steels (45~50HRC)	JP4120 JP4105	60~ 100	BT40	0.15~ 0.3	1,270	380	2.3	1,020	310	2.3	800	360	3.5
					vc=80m/min fz=0.15mm/t ap=1mm ae=0.3DCX								
					1,270	380	3.8	1,020	310	3.9	800	360	5.8
焼入れ鋼 Hardened steels (50~60HRC)	※1 JP4105 JP4120	50~ 100	BT40	0.05~ 0.2	1,110	220	1.3	890	170	1.2	690	200	1.9
					vc=70m/min fz=0.1mm/t ap=1mm ae=0.3DCX								
					1,110	220	2.2	890	170	2.1	690	200	3.2
					vc=70m/min fz=0.1mm/t ap=1mm ae=0.5DCX								

※1:「JP4105」は高硬度鋼専用材種で、生材には適しません。

※1:「JP4105」insert's grade specialized in High hardened steel is not suitable for Non-heat-treated steel material.

※2: 強断続切削環境下では「JS4060」「JM4160」を推奨します。 ※2: 「JS4060」「JM4160」 is recommended under heavy interrupt cutting.

【注意】

- ① JSコートは通電式タッチセンサーに反応しませんのでご注意ください。
- ② 不水溶性切削油は、火災の恐れがありますので使用しないでください。
- ③ 排出した切りくずは飛散し作業者を切傷させ、火傷あるいは目に入って負傷させる恐れがありますので、ご使用に際してはその周囲に安全カバーを取り付け保護メガネ等の保護具を着用して、安全な環境で作業される事をお願い致します。
- ④ この切削条件表は切削条件の目安を示すものです。実際の加工では加工形状、目的、使用機械等により条件を調整してください。
- ⑤ 加工状況により振動が懸念される場合は、1. 切り込み深さ (ap) を低減する 2. 一刃当りの送り (fz) を低減する方法で調整ください。
- ⑥ 溝切削の場合、送り量は70%を目安としてください。
- ⑦ 冷間ダイス鋼など60HRCを超える鋼種の場合は、1刃当りの送り (fz) 値を1/2程度に設定して下さい。
- ⑧ 工具突き出し量は標準形の首下長さ (L1) です。

【Note】

- ① Please note that the JS Coating does not cause a reaction in conductive touch sensors.
- ② Due to fire risks do not use neat cutting oil as a coolant.
- ③ The evacuation of swarf can cause burns, cuts or damage to the eyes please ensure the correct safety cover is fitted around the machine, and necessary personal protection equipment is worn by the machine operator.
- ④ These conditions are for general guidance; in actual machining conditions adjust the parameters according to your actual machine and work-piece conditions.
- ⑤ If vibrations are a concern due to the cutting conditions, adjust conditions by 1. reducing cutting depth (ap) or 2. reducing per-flute feed rate (fz).
- ⑥ In the case of slotting, feed speed could be down to 70% of the whole.
- ⑦ In steel exceeding 60HRC, such as dice steel between the colds, please set the sending (fz) value per one edge about to 1/2.
- ⑧ This table is based on the overhang of regular type (L1).

φ40(3枚刃 3 Flutes r6)			φ50(4枚刃 4 Flutes r6)			φ40(2枚刃 2 Flutes r8)			φ50(3枚刃 3 Flutes r8)			φ63(3枚刃 3 Flutes r8)			被削材 Work material
回転数 min ⁻¹	送り速度 mm/min	Q 値 cm ³ /min	回転数 min ⁻¹	送り速度 mm/min	Q 値 cm ³ /min	回転数 min ⁻¹	送り速度 mm/min	Q 値 cm ³ /min	回転数 min ⁻¹	送り速度 mm/min	Q 値 cm ³ /min	回転数 min ⁻¹	送り速度 mm/min	Q 値 cm ³ /min	
1,990	2,990	71.8	1,590	3,180	95.4	1,990	1,990	47.8	1,590	2,390	71.7	1,260	1,890	71.4	一般構造用鋼 Mild steels (200HB以下)
vc=250m/min fz=0.5mm/t ap=2mm ae=0.3DCX			vc=250m/min fz=0.5mm/t ap=2mm ae=0.3DCX			vc=250m/min fz=0.5mm/t ap=2mm ae=0.3DCX			vc=250m/min fz=0.5mm/t ap=2mm ae=0.3DCX			vc=250m/min fz=0.5mm/t ap=2mm ae=0.3DCX			
1,990	4,780	191.2	1,590	5,090	254.5	1,990	3,180	159	1,590	3,820	238.8	1,260	3,020	237.8	
vc=250m/min fz=0.8mm/t ap=2mm ae=0.5DCX			vc=250m/min fz=0.8mm/t ap=2mm ae=0.5DCX			vc=250m/min fz=0.8mm/t ap=2.5mm ae=0.5DCX			vc=250m/min fz=0.8mm/t ap=2.5mm ae=0.5DCX			vc=250m/min fz=0.8mm/t ap=2.5mm ae=0.5DCX			炭素鋼・合金鋼 Carbon & Alloy steels (30HRC以下)
1,590	1,910	45.8	1,270	2,030	60.9	1,590	1,270	30.5	1,270	1,520	45.6	1,010	1,210	45.7	
vc=200m/min fz=0.4mm/t ap=2mm ae=0.3DCX			vc=200m/min fz=0.4mm/t ap=2mm ae=0.3DCX			vc=200m/min fz=0.4mm/t ap=2mm ae=0.3DCX			vc=200m/min fz=0.4mm/t ap=2mm ae=0.3DCX			vc=200m/min fz=0.4mm/t ap=2mm ae=0.3DCX			
1,590	2,860	114.4	1,270	3,050	152.5	1,590	1,910	95.5	1,270	2,290	143.1	1,010	2,120	167	炭素鋼・合金鋼 Carbon & Alloy steels (30~40HRC)
vc=200m/min fz=0.6mm/t ap=2mm ae=0.5DCX			vc=200m/min fz=0.6mm/t ap=2mm ae=0.5DCX			vc=200m/min fz=0.6mm/t ap=2.5mm ae=0.5DCX			vc=200m/min fz=0.6mm/t ap=2.5mm ae=0.5DCX			vc=200m/min fz=0.7mm/t ap=2.5mm ae=0.5DCX			
1,190	710	17	960	770	23.1	1,190	480	11.5	960	580	17.4	760	460	17.4	
vc=150m/min fz=0.2mm/t ap=2mm ae=0.3DCX			vc=150m/min fz=0.2mm/t ap=2mm ae=0.3DCX			vc=150m/min fz=0.2mm/t ap=2mm ae=0.3DCX			vc=150m/min fz=0.2mm/t ap=2mm ae=0.3DCX			vc=150m/min fz=0.2mm/t ap=2mm ae=0.3DCX			炭素鋼・合金鋼 Carbon & Alloy steels (30~40HRC)
1,190	1,070	42.8	960	1,150	57.5	1,190	950	47.5	960	1,150	71.9	760	910	71.7	
vc=150m/min fz=0.3mm/t ap=2mm ae=0.5DCX			vc=150m/min fz=0.3mm/t ap=2mm ae=0.5DCX			vc=150m/min fz=0.4mm/t ap=2.5mm ae=0.5DCX			vc=150m/min fz=0.4mm/t ap=2.5mm ae=0.5DCX			vc=150m/min fz=0.4mm/t ap=2.5mm ae=0.5DCX			
800	360	6.5	640	380	8.6	800	240	4.3	640	290	6.5	510	230	6.5	炭素鋼・合金鋼 Carbon & Alloy steels (40~45HRC)
vc=100m/min fz=0.15mm/t ap=1.5mm ae=0.3DCX			vc=100m/min fz=0.15mm/t ap=1.5mm ae=0.3DCX			vc=100m/min fz=0.15mm/t ap=1.5mm ae=0.3DCX			vc=100m/min fz=0.15mm/t ap=1.5mm ae=0.3DCX			vc=100m/min fz=0.15mm/t ap=1.5mm ae=0.3DCX			
800	480	14.4	640	510	19.1	800	320	12.8	640	380	19	510	310	19.5	
vc=100m/min fz=0.2mm/t ap=1.5mm ae=0.5DCX			vc=100m/min fz=0.2mm/t ap=1.5mm ae=0.5DCX			vc=100m/min fz=0.2mm/t ap=2mm ae=0.5DCX			vc=100m/min fz=0.2mm/t ap=2mm ae=0.5DCX			vc=100m/min fz=0.2mm/t ap=2mm ae=0.5DCX			ステンレス鋼 Stainless steels SUS
1,590	1,430	34.3	1,270	1,520	45.6	1,590	950	22.8	1,270	1,140	34.2	1,010	910	34.4	
vc=200m/min fz=0.3mm/t ap=2mm ae=0.3DCX			vc=200m/min fz=0.3mm/t ap=2mm ae=0.3DCX			vc=200m/min fz=0.3mm/t ap=2mm ae=0.3DCX			vc=200m/min fz=0.3mm/t ap=2mm ae=0.3DCX			vc=200m/min fz=0.3mm/t ap=2mm ae=0.3DCX			
1,430	2,150	86	1,150	2,300	115	1,430	1,720	86	1,150	2,070	129.4	910	1,640	129.2	炭素鋼・合金鋼 Carbon & Alloy steels (40~45HRC)
vc=180m/min fz=0.5mm/t ap=2mm ae=0.5DCX			vc=180m/min fz=0.5mm/t ap=2mm ae=0.5DCX			vc=180m/min fz=0.6mm/t ap=2.5mm ae=0.5DCX			vc=180m/min fz=0.6mm/t ap=2.5mm ae=0.5DCX			vc=180m/min fz=0.6mm/t ap=2.5mm ae=0.5DCX			
1,430	2,150	51.6	1,150	2,300	69	1,430	1,430	34.3	1,150	1,730	51.9	910	1,370	51.8	
vc=180m/min fz=0.5mm/t ap=2mm ae=0.3DCX			vc=180m/min fz=0.5mm/t ap=2mm ae=0.3DCX			vc=180m/min fz=0.5mm/t ap=2mm ae=0.3DCX			vc=180m/min fz=0.5mm/t ap=2mm ae=0.3DCX			vc=180m/min fz=0.5mm/t ap=2mm ae=0.3DCX			鑄鉄 Cast irons FC, FCD
1,430	3,430	137.2	1,150	3,680	184	1,430	2,290	114.5	1,150	2,760	172.5	910	2,180	171.7	
vc=180m/min fz=0.8mm/t ap=2mm ae=0.5DCX			vc=180m/min fz=0.8mm/t ap=2mm ae=0.5DCX			vc=180m/min fz=0.8mm/t ap=2.5mm ae=0.5DCX			vc=180m/min fz=0.8mm/t ap=2.5mm ae=0.5DCX			vc=180m/min fz=0.8mm/t ap=2.5mm ae=0.5DCX			
640	290	3.5	510	310	4.7	640	220	4	510	260	5.9	400	200	5.7	焼入れ鋼 Hardened steels (45~50HRC)
vc=80m/min fz=0.15mm/t ap=1mm ae=0.3DCX			vc=80m/min fz=0.17mm/t ap=1.5mm ae=0.3DCX			vc=80m/min fz=0.17mm/t ap=1.5mm ae=0.3DCX			vc=80m/min fz=0.17mm/t ap=1.5mm ae=0.3DCX			vc=80m/min fz=0.17mm/t ap=1.5mm ae=0.3DCX			
640	330	6.6	510	350	8.8	640	260	7.8	510	310	11.6	400	240	11.3	
vc=80m/min fz=0.17mm/t ap=1mm ae=0.5DCX			vc=80m/min fz=0.2mm/t ap=1.5mm ae=0.5DCX			vc=80m/min fz=0.2mm/t ap=1.5mm ae=0.5DCX			vc=80m/min fz=0.2mm/t ap=1.5mm ae=0.5DCX			vc=80m/min fz=0.2mm/t ap=1.5mm ae=0.5DCX			焼入れ鋼 Hardened steels (50~60HRC)
550	160	1.9	440	170	2.5	550	110	1.3	440	130	1.9	350	100	1.9	
vc=70m/min fz=0.1mm/t ap=1mm ae=0.3DCX			vc=70m/min fz=0.1mm/t ap=1mm ae=0.3DCX			vc=70m/min fz=0.1mm/t ap=1mm ae=0.3DCX			vc=70m/min fz=0.1mm/t ap=1mm ae=0.3DCX			vc=70m/min fz=0.1mm/t ap=1mm ae=0.3DCX			
550	160	3.2	440	170	4.2	550	110	2.2	440	130	3.2	350	100	3.1	焼入れ鋼 Hardened steels (50~60HRC)
vc=70m/min fz=0.1mm/t ap=1mm ae=0.5DCX			vc=70m/min fz=0.1mm/t ap=1mm ae=0.5DCX			vc=70m/min fz=0.1mm/t ap=1mm ae=0.5DCX			vc=70m/min fz=0.1mm/t ap=1mm ae=0.5DCX			vc=70m/min fz=0.1mm/t ap=1mm ae=0.5DCX			

傾斜切削・ヘリカル切削・Z方向切込み Ramping, Helical Milling, Feeding toward Z-AXIS

中心まで切れ刃がないため傾斜角度(θ)やZ軸方向切込み深さ(ap)に制限があります。
There are restrictions to ramp angle (θ) and cutting depth (ap) toward Z-axis because of designs of cutting edge.

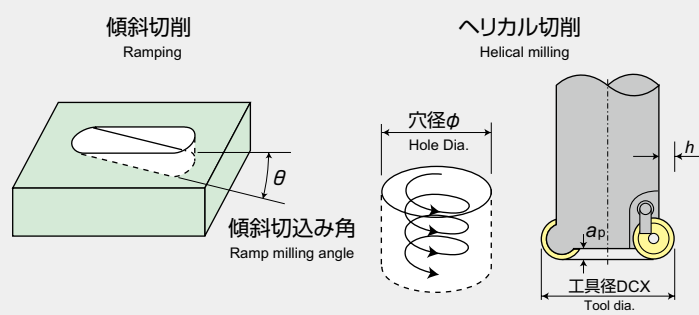

工具径DCX Tool dia.	φ20(r4)	φ25(r5)	φ32(r5)	φ40(r6)	φ50(r8)	φ63(r8)
推奨θ Recommended	3°以下 Below 3 degrees					
h	1	2	2	2.5	2.5	2.5
ap	2	3	3	3.7	4.5	5.5
ヘリカル穴径 Hole Dia.	28~38	34~38	48~62	60~78	75~98	101~124

[注意] 切りくずが飛散することがあります。切りくずカバーを設置してください。
[Note] Due to swarf evacuation wear safety glasses in the vicinity of the operation.

快削形アルファラジアスミルAR

ARB ボア形 Bore type	AR ボア形 Bore type
--------------------------------	-------------------------------

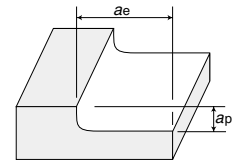

※赤字は第一推奨材種です。Red indicates primary recommended grade.

被削材 Work material	推奨材種 Recommended grade	切削速度 m/min Cutting speed	使用機械 Spindle of machine	一刃当りの送り mm/t Feed rate	φ40(3枚刃 3 Flutes r6)			φ50(5枚刃 5 Flutes r6)			φ63(6枚刃 6 Flutes r6)			φ80(6枚刃 6 Flutes r6)		
					回転数 min ⁻¹	送り速度 mm/min	Q 値 cm ³ /min	回転数 min ⁻¹	送り速度 mm/min	Q 値 cm ³ /min	回転数 min ⁻¹	送り速度 mm/min	Q 値 cm ³ /min	回転数 min ⁻¹	送り速度 mm/min	Q 値 cm ³ /min
一般構造用鋼 Mild steels (200HB以下)	※ JS4060 JS4045	150~ 250	BT40	0.3~ 0.8	1,990	2,990	71.8	1,590	3,975	95.4	1,260	3,780	142.9	—	—	—
					vc=250m/min fz=0.5mm/t ap=2mm ae=0.3DCX											
炭素鋼・合金鋼 Carbon & Alloy steels (30HRC以下)	JS4060 JS4045	120~ 230	BT40	0.3~ 0.8	1,990	4,780	191.2	1,590	6,360	254.5	1,260	6,050	381.2	1,000	4,800	384
					vc=250m/min fz=0.8mm/t ap=2mm ae=0.5DCX											
炭素鋼・合金鋼 Carbon & Alloy steels (30~40HRC)	JS4060 JS4045	100~ 200	BT40	0.2~ 0.6	1,190	710	17	960	960	23.1	760	910	34.4	—	—	—
					vc=150m/min fz=0.2mm/t ap=2mm ae=0.3DCX											
炭素鋼・合金鋼 Carbon & Alloy steels (40~45HRC)	JP4120 JS4045	60~ 150	BT40	0.15~ 0.3	800	360	6.5	640	480	8.6	510	460	13	—	—	—
					vc=100m/min fz=0.15mm/t ap=1.5mm ae=0.3DCX											
ステンレス鋼 Stainless steels SUS	JM4160	150~ 240	BT40	0.2~ 0.8	1,590	1,430	34.3	1,270	1,905	45.6	1,010	1,820	68.8	—	—	—
					vc=200m/min fz=0.3mm/t ap=2mm ae=0.3DCX											
鋳鉄 Cast irons FC, FCD	JP4120	100~ 220	BT40	0.3~ 1.0	1,430	2,150	51.6	1,150	2,875	69	910	2,730	103.2	—	—	—
					vc=180m/min fz=0.5mm/t ap=2mm ae=0.3DCX											
焼入れ鋼 Hardened steels (45~50HRC)	JP4120 JP4105	60~ 100	BT40	0.15~ 0.3	640	290	3.5	510	383	4.7	400	360	6.8	—	—	—
					vc=80m/min fz=0.15mm/t ap=1mm ae=0.3DCX											
焼入れ鋼 Hardened steels (50~60HRC)	※1 JP4105 JP4120	50~ 100	BT40	0.05~ 0.2	550	160	1.9	440	220	2.5	350	210	3.9	270	160	3.8
					vc=70m/min fz=0.1mm/t ap=1mm ae=0.3DCX											
					550	160	3.2	440	220	4.2	350	210	6.6	270	160	6.4
					vc=70m/min fz=0.1mm/t ap=1mm ae=0.5DCX											

※1: [JP4105]は高硬度鋼専用材種で、生材には適しません。

※1: [JP4105] insert's grade specialized in High hardened steel is not suitable for Non-heat-treated steel material.

※2: 強断続切削環境下では[JS4060][JM4160]を推奨します。※2: [JS4060][JM4160] is recommended under heavy interrupt cutting.

【注意】

- ① JSコートは通電式タッチセンサーに反応しませんのでご注意ください。
- ② 不水溶性切削油は、火災の恐れがありますので使用しないでください。
- ③ 排出した切りくずは飛散し作業者を切傷させ、火傷あるいは目に入って負傷させる恐れがありますので、ご使用に際してはその周囲に安全カバーを取り付け保護めがね等の保護具を着用して、安全な環境で作業される事をお願い致します。
- ④ この切削条件表は切削条件の目安を示すものです。実際の加工では加工形状、目的、使用機械等により条件を調整してください。
- ⑤ 加工状況により振動が懸念される場合は、1. 切り込み深さ (ap) を低減する 2. 一刃当りの送り (fz) を低減する方法で調整ください。
- ⑥ 溝切削の場合、送りは70%を目安としてください。
- ⑦ 冷間ダイス鋼など60HRCを超える鋼種の場合は、1刃当りの送り (fz) 値を1/2程度に設定して下さい。

【Note】

- ① Please note that the JS Coating does not cause a reaction in conductive touch sensors.
- ② Due to fire risks do not use neat cutting oil as a coolant.
- ③ The evacuation of swarf can cause burns, cuts or damage to the eyes please ensure the correct safety cover is fitted around the machine, and necessary personal protection equipment is worn by the machine operator.
- ④ These conditions are for general guidance; in actual machining conditions adjust the parameters according to your actual machine and work-piece conditions.
- ⑤ If vibrations are a concern due to the cutting conditions, adjust conditions by 1. reducing cutting depth (ap) or 2. reducing per-flute feed rate (fz).
- ⑥ In the case of slotting, feed speed could be down to 70% of the whole.
- ⑦ In steel exceeding 60HRC, such as dice steel between the colds, please set the sending (fz) value per one edge about to 1/2.

φ100(5枚刃 5 Flutes r6)			φ63(3枚刃 3 Flutes r8)			φ80(4枚刃 4 Flutes r8)			φ100(5枚刃 5 Flutes r8)			φ125(6枚刃 6 Flutes r8)			被削材 Work material
回転数 min ⁻¹	送り速度 mm/min	Q 値 cm ³ /min	回転数 min ⁻¹	送り速度 mm/min	Q 値 cm ³ /min	回転数 min ⁻¹	送り速度 mm/min	Q 値 cm ³ /min	回転数 min ⁻¹	送り速度 mm/min	Q 値 cm ³ /min	回転数 min ⁻¹	送り速度 mm/min	Q 値 cm ³ /min	
—	—	—	1,260	1,890	71.4	—	—	—	—	—	—	—	—	—	一般構造用鋼 Mild steels (200HB以下)
800	3,200	320	1,260	3,020	237.8	1,000	3,200	320	800	3,200	400	640	3,070	479.7	
—	—	—	1,010	1,210	45.7	—	—	—	—	—	—	—	—	—	炭素鋼・合金鋼 Carbon & Alloy steels (30HRC以下)
640	1,920	192	1,010	2,120	167	800	2,240	224	640	2,240	280	510	2,140	334.4	
—	—	—	760	460	17.4	—	—	—	—	—	—	—	—	—	炭素鋼・合金鋼 Carbon & Alloy steels (30~40HRC)
480	720	72	760	910	71.7	600	960	96	480	960	120	380	910	142.2	
—	—	—	510	230	6.5	—	—	—	—	—	—	—	—	—	炭素鋼・合金鋼 Carbon & Alloy steels (40~45HRC)
320	320	24	510	310	19.5	400	320	25.6	320	320	32	250	300	37.5	
—	—	—	1,010	910	34.4	—	—	—	—	—	—	—	—	—	ステンレス鋼 Stainless steels SUS
570	1,430	143	910	1,640	129.2	720	1,730	173	570	1,710	213.8	460	1,660	259.4	
—	—	—	910	1,370	51.8	—	—	—	—	—	—	—	—	—	鋳鉄 Cast irons FC, FCD
570	2,280	228	910	2,180	171.7	720	2,300	230	570	2,280	285	460	2,210	345.3	
—	—	—	400	200	5.7	—	—	—	—	—	—	—	—	—	焼入れ鋼 Hardened steels (45~50HRC)
250	210	10.5	400	240	11.3	320	260	15.6	250	250	18.8	200	240	22.5	
—	—	—	350	100	1.9	—	—	—	—	—	—	—	—	—	焼入れ鋼 Hardened steels (50~60HRC)
220	110	3.3	350	100	3.1	270	110	4.4	220	110	5.5	170	100	6.2	

傾斜切削・ヘリカル切削・Z方向切込み Ramping, Helical Milling, Feeding toward Z-AXIS

中心まで切れ刃がないため傾斜角度(θ)やZ軸方向切込み深さ(ap)に制限があります。
There are restrictions to ramp angle (θ) and cutting depth (ap) toward Z-axis because of designs of cutting edge.

		(mm)					
工具径DCX Tool dia.		φ40(r6)	φ50(r6)	φ63(r8)	φ80(r8)	φ100(r8)	φ125(r8)
推奨θ Recommended		3°以下 Below 3 degrees					2°以下 Below 2 degrees
h		2.5	2.5	2.5	2.5	2.5	2.5
ap		3.7	3.3	5.5	5.5	5.5	5.5
ヘリカル穴径 Hole Dia.		60~78	77~100	101~124	135~158	175~198	248~255

[注意] 切りくずが飛散することがあります。切りくずカバーを設置してください。
[Note] Due to swarf evacuation wear safety glasses in the vicinity of the operation.

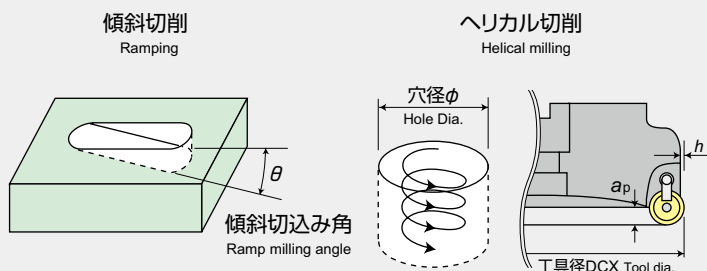

快削形アルファラジASMIL AR

ARM

モジュラー形
Modular

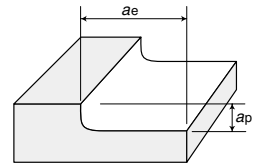

※赤字は第一推奨材種です。Red indicates primary recommended grade.

被削材 Work material	推奨材種 Recommended grade	切削速度 v_c m/min Cutting speed	使用機械 Spindle of machine	一刃当りの送り f_z mm/t Feed rate	φ12(3枚刃 3 Flutes $r2.5$)			φ16(2枚刃 2 Flutes $r3.5$)		
					回転数 n min ⁻¹	送り速度 v_f mm/min	切りくず排出量 cm ³ /min	回転数 n min ⁻¹	送り速度 v_f mm/min	切りくず排出量 cm ³ /min
一般構造用鋼 Mild steels (200HB以下)	※ JS4060 JS4045	150~250	BT40	0.1~0.8	6,630	1,990	6	4,970	1,990	16
					$v_c=250\text{m/min } f_z=0.1\text{mm/t}$ $a_p=0.5\text{mm } a_e=0.5\text{DCX}$			$v_c=250\text{m/min } f_z=0.2\text{mm/t}$ $a_p=1\text{mm } a_e=0.5\text{DCX}$		
炭素鋼・合金鋼 Carbon & Alloy steels (30HRC以下)	JS4060 JS4045	120~230	BT40	0.1~0.8	5,310	1,590	4.8	3,980	1,590	12.7
					$v_c=200\text{m/min } f_z=0.1\text{mm/t}$ $a_p=0.5\text{mm } a_e=0.5\text{DCX}$			$v_c=200\text{m/min } f_z=0.2\text{mm/t}$ $a_p=1\text{mm } a_e=0.5\text{DCX}$		
炭素鋼・合金鋼 Carbon & Alloy steels (30~40HRC)	JS4060 JS4045	100~200	BT40	0.08~0.6	3,980	960	2.9	2,980	890	7.1
					$v_c=150\text{m/min } f_z=0.08\text{mm/t}$ $a_p=0.5\text{mm } a_e=0.5\text{DCX}$			$v_c=150\text{m/min } f_z=0.15\text{mm/t}$ $a_p=1\text{mm } a_e=0.5\text{DCX}$		
炭素鋼・合金鋼 Carbon & Alloy steels (40~45HRC)	JP4120 JS4045	60~150	BT40	0.08~0.3	2,650	640	1.9	1,990	600	2.9
					$v_c=100\text{m/min } f_z=0.08\text{mm/t}$ $a_p=0.5\text{mm } a_e=0.5\text{DCX}$			$v_c=100\text{m/min } f_z=0.15\text{mm/t}$ $a_p=0.6\text{mm } a_e=0.5\text{DCX}$		
ステンレス鋼 Stainless steels SUS	JM4160	150~240	BT40	0.1~0.8	4,770	1,430	4.3	3,580	1,430	11.4
					$v_c=180\text{m/min } f_z=0.1\text{mm/t}$ $a_p=0.5\text{mm } a_e=0.5\text{DCX}$			$v_c=180\text{m/min } f_z=0.2\text{mm/t}$ $a_p=1\text{mm } a_e=0.5\text{DCX}$		
鋳鉄 Cast irons FC, FCD	JP4120	100~220	BT40	0.1~1.0	4,770	1,430	4.3	3,580	1,430	11.4
					$v_c=180\text{m/min } f_z=0.1\text{mm/t}$ $a_p=0.5\text{mm } a_e=0.5\text{DCX}$			$v_c=180\text{m/min } f_z=0.2\text{mm/t}$ $a_p=1\text{mm } a_e=0.5\text{DCX}$		
焼入れ鋼 Hardened steels (45~55HRC)	JP4120 JP4105	60~100	BT40	0.05~0.3	2,120	510	0.9	1,590	320	1.3
					$v_c=80\text{m/min } f_z=0.08\text{mm/t}$ $a_p=0.3\text{mm } a_e=0.5\text{DCX}$			$v_c=80\text{m/min } f_z=0.1\text{mm/t}$ $a_p=0.5\text{mm } a_e=0.5\text{DCX}$		
焼入れ鋼 Hardened steels (55~60HRC)	※ ₁ JP4105	50~100	BT40	0.05~0.2	1,860	280	0.5	1,390	280	0.7
					$v_c=70\text{m/min } f_z=0.05\text{mm/t}$ $a_p=0.3\text{mm } a_e=0.5\text{DCX}$			$v_c=70\text{m/min } f_z=0.1\text{mm/t}$ $a_p=0.3\text{mm } a_e=0.5\text{DCX}$		

※₁:「JP4105」は高硬度鋼専用材種で、生材には適しません。

※₁:「JP4105」insert's grade specialized in High hardened steel is not suitable for Non-heat-treated steel material.

※₂:強断続切削環境下では「JS4060」「JM4160」を推奨します。※₂:「JS4060」「JM4160」 is recommended under heavy interrupt cutting.

【注意】

- ① JSコーティングは通電式タッチセンサーに反応しませんのでご注意ください。
- ② 不水溶性切削油は、火災の恐れがありますので使用しないでください。
- ③ 排出した切りくずは飛散し作業者を切傷させ、火傷あるいは目に入って負傷させる恐れがありますので、ご使用に際してはその周囲に安全カバーを取り付け保護メガネ等の保護具を着用して、安全な環境で作業される事をお願い致します。
- ④ この切削条件表は切削条件の目安を示すものです。実際の加工では加工形状、目的、使用機械等により条件を調整してください。
- ⑤ 加工状況により振動が懸念される場合は、1. 切り込み深さ (a_p) を低減する 2. 一刃当りの送り (f_z) を低減する方法で調整ください。
- ⑥ 溝切削の場合、送り量は70%を目安としてください。
- ⑦ 冷間ダイス鋼など60HRCを超える鋼種の場合は、1刃当りの送り (f_z) 値を1/2程度に設定して下さい。

【Note】

- ① Please note that the JS Coating does not cause a reaction in conductive touch sensors.
- ② Due to fire risks do not use neat cutting oil as a coolant.
- ③ The evacuation of swarf can cause burns, cuts or damage to the eyes please ensure the correct safety cover is fitted around the machine, and necessary personal protection equipment is worn by the machine operator.
- ④ These conditions are for general guidance; in actual machining conditions adjust the parameters according to your actual machine and work-piece conditions.
- ⑤ If vibrations are a concern due to the cutting conditions, adjust conditions by 1. reducing cutting depth (a_p) or 2. reducing per-flute feed rate (f_z).
- ⑥ In the case of slotting, feed speed could be down to 70% of the whole.
- ⑦ In steel exceeding 60HRC, such as dice steel between the colds, please set the sending (f_z) value per one edge about to 1/2.

	φ20 (2枚刃 2 Flutes r4)			φ25 (2枚刃 2 Flutes r5)			φ32 (3枚刃 3 Flutes r5)			φ40 (4枚刃 4 Flutes r5)			被削材 Work material
	回転数 n min ⁻¹	送り速度 v_f mm/min	切りくず排出量 cm ³ /min	回転数 n min ⁻¹	送り速度 v_f mm/min	切りくず排出量 cm ³ /min	回転数 n min ⁻¹	送り速度 v_f mm/min	切りくず排出量 cm ³ /min	回転数 n min ⁻¹	送り速度 v_f mm/min	切りくず排出量 cm ³ /min	
	3,980	3,180	28.6	3,180	2,540	28.6	2,490	2,990	43.1	1,990	3,180	57.2	一般構造用鋼 Mild steels (200HB以下)
	vc=250m/min fz=0.4mm/t ap=1.5mm ae=0.3DCX												
	3,980	3,180	47.7	3,180	2,540	47.6	2,490	2,990	71.8	1,990	3,180	95.4	炭素鋼・合金鋼 Carbon & Alloy steels (30HRC以下)
	vc=250m/min fz=0.4mm/t ap=1.5mm ae=0.5DCX												
	3,180	2,540	22.9	2,550	2,040	23	1,990	2,390	34.4	1,590	2,540	45.7	炭素鋼・合金鋼 Carbon & Alloy steels (30~40HRC)
	vc=200m/min fz=0.4mm/t ap=1.5mm ae=0.3DCX												
	3,180	2,540	38.1	2,550	2,040	38.3	1,990	2,390	57.4	1,590	2,540	76.2	炭素鋼・合金鋼 Carbon & Alloy steels (30~40HRC)
	vc=200m/min fz=0.4mm/t ap=1.5mm ae=0.5DCX												
	2,390	960	8.6	1,910	760	8.6	1,490	890	12.8	1,190	950	17.1	炭素鋼・合金鋼 Carbon & Alloy steels (30~40HRC)
	vc=150m/min fz=0.2mm/t ap=1.5mm ae=0.3DCX												
	2,390	1,430	21.5	1,910	1,150	21.6	1,490	1,340	32.2	1,190	1,430	42.9	炭素鋼・合金鋼 Carbon & Alloy steels (40~45HRC)
	vc=150m/min fz=0.3mm/t ap=1.5mm ae=0.5DCX												
	1,590	480	2.9	1,270	380	2.9	990	450	4.3	800	480	5.8	炭素鋼・合金鋼 Carbon & Alloy steels (40~45HRC)
	vc=100m/min fz=0.15mm/t ap=1mm ae=0.3DCX												
	1,590	640	6.4	1,270	510	6.4	990	590	9.4	800	640	12.8	ステンレス鋼 Stainless steels SUS
	vc=100m/min fz=0.2mm/t ap=1mm ae=0.5DCX												
	3,180	1,590	14.3	2,550	1,280	14.4	1,990	1,490	21.5	1,590	1,590	28.6	ステンレス鋼 Stainless steels SUS
	vc=200m/min fz=0.25mm/t ap=1.5mm ae=0.3DCX												
	2,860	1,716	25.7	2,290	1,370	25.7	1,790	1,610	38.6	1,430	1,720	51.6	鑄鉄 Cast irons FC, FCD
	vc=180m/min fz=0.3mm/t ap=1.5mm ae=0.5DCX												
	2,860	2,290	20.6	2,290	1,830	20.6	1,790	2,150	31	1,430	2,290	41.2	焼入れ鋼 Hardened steels (45~55HRC)
	vc=180m/min fz=0.4mm/t ap=1.5mm ae=0.3DCX												
	2,860	2,860	42.9	2,290	2,290	42.9	1,790	2,690	64.6	1,430	2,860	85.8	焼入れ鋼 Hardened steels (55~60HRC)
	vc=180m/min fz=0.5mm/t ap=1.5mm ae=0.5DCX												
	1,270	380	2.3	1,020	310	2.3	800	360	3.5	640	380	4.6	焼入れ鋼 Hardened steels (45~55HRC)
	vc=80m/min fz=0.15mm/t ap=1mm ae=0.3DCX												
	1,270	380	3.8	1,020	310	3.9	800	360	5.8	640	380	7.6	焼入れ鋼 Hardened steels (55~60HRC)
	vc=80m/min fz=0.15mm/t ap=1mm ae=0.5DCX												
	1,110	220	1.3	890	170	1.2	690	200	1.9	560	230	2.8	焼入れ鋼 Hardened steels (55~60HRC)
	vc=70m/min fz=0.1mm/t ap=1mm ae=0.3DCX												
	1,110	220	2.2	890	170	2.1	690	200	3.2	560	230	4.6	
	vc=70m/min fz=0.1mm/t ap=1mm ae=0.5DCX												

傾斜切削・ヘリカル切削・Z方向切込み Ramping, Helical Milling, Feeding toward Z-AXIS

中心まで切れ刃がないため傾斜角度(θ)やZ軸方向切込み深さ(a_p)に制限があります。

There are restrictions to ramp angle (θ) and cutting depth (a_p) toward Z-axis because of designs of cutting edge.

(mm)

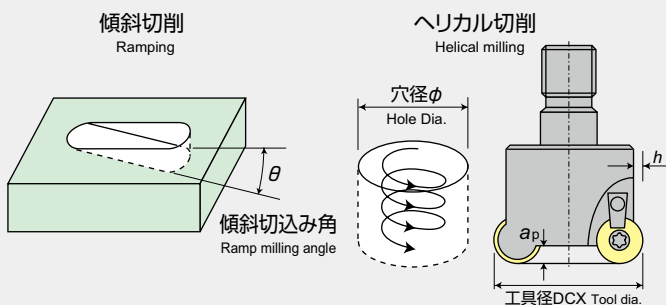

工具径DCX Tool dia.	φ12(r2.5)	φ16(r3.5)	φ20(r4)	φ22(r4)	φ25(r5)	φ28(r5)	φ30(r5)	φ32(r5)	φ40(r5)
推奨θ Recommended	2°以下 Below 2 degrees		3°以下 Below 3 degrees						
h	0.8	1	1	2	2	2	0.5	1.5	2
a_p	0.8	1	2	3	3	3	3	3	3
ヘリカル穴径 Hole Dia.	17~22	22~30	28~38	32~42	34~38	40~54	44~58	48~62	64~78

【注意】切りくずが飛散することがあります。切りくずカバーを設置してください。
【Note】Due to swarf evacuation wear safety glasses in the vicinity of the operation.

アルファラジアスミル RD16B

- 難削材加工における、高いコストパフォーマンス・低抵抗切削・多機能性を実現!
- 最新のプレス技術により16コーナを実現しました!
- ・ Cost-effective machining with low cutting force and multi-functionality is realized for difficult-to-machine material.
- ・ Insert has 16 corners which realized by latest press molding technology.



○は数字が入ります。Numeric figure in a circle ○.

RD16B○○○○R-○/RD16B○○○○RM-○ ボアタイプ Bore type

ボアタイプ用アーバはD11頁を参照ください。Refer page D11 about the bore type arbor.

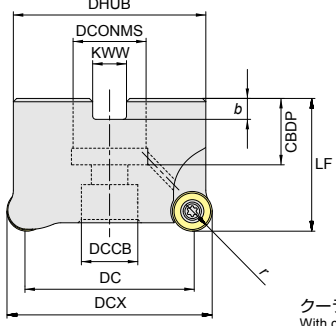
													適用インサート Insert 希望小売価格(円) Suggested retail price (¥)	
				寸法 Size (mm)										
商品コード Item code	在庫 Stock	刃数 No. of flutes	r	DCX	DC	DHUB	LF	DCONMS	DCCB	KWW	b	CDBP	適用インサート Insert	希望小売価格(円) Suggested retail price (¥)
内径 インチ サイズ Internal diameter inch size	RD16B4050R-5	●	5	50	38	45	40	22.225	17	8.4	5	19	RNMG1205M0EN-B16	94,200
	RD16B4063R-6	●	6	63	51	58	40	22.225	17	8.4	5	19		113,040
	RD16B4080R-7	●	7	80	68	75	63	31.75	26	12.7	8	32		118,480
	RD16B5063R-4	●	4	63	47	58	40	22.225	17	8.4	5	19	RNMG1606M0EN-B16	91,740
	RD16B5080R-5	●	5	80	64	75	63	31.75	26	12.7	8	32		116,490
	RD16B5100R-6	●	6	100	84	96	63	31.75	26	12.7	8	32		143,110
内径 ミリ サイズ Internal diameter mm size	RD16B4040RM-4	●	4	40	28	35	40	16	11.2	8.4	5.6	19	RNMG1205M0EN-B16	63,000
	RD16B4050RM-5	●	5	50	38	45	40	22	17	10.4	6.3	20		94,200
	RD16B4063RM-6	●	6	63	51	58	40	22	17	10.4	6.3	20		113,080
	RD16B4080RM-7	●	7	80	68	75	50	27	20	12.4	7	22		118,480
	RD16B5063RM-4	●	4	63	47	58	40	22	17	10.4	6.3	20	RNMG1606M0EN-B16	85,990
	RD16B5080RM-5	●	5	80	64	75	50	27	20	12.4	7	22		109,220
	RD16B5100RM-6	●	6	100	84	96	63	32	26	14.4	8	32		—





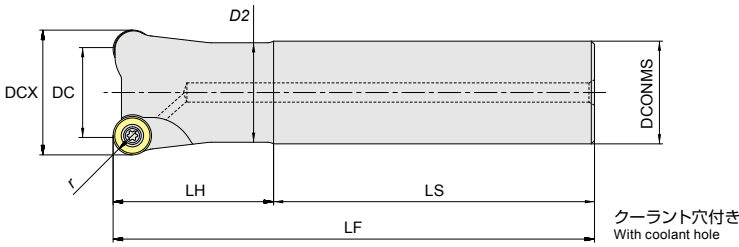

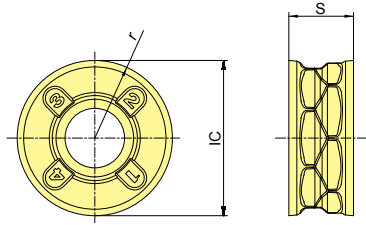

RD16B40○○S32R-○ シャンクタイプ Shank type

○は数字が入ります。Numeric figure comes in a circle ○.

													適用インサート Insert 希望小売価格(円) Suggested retail price (¥)	
				寸法 Size (mm)										
商品コード Item code	在庫 Stock	刃数 No. of flutes	r	DCX	DC	LF	DCONMS	LH	LS	D2	適用インサート Insert	希望小売価格(円) Suggested retail price (¥)		
シャンク タイプ Shank type	RD16B4032S32R-3	●	3	6	32	20	150	32	70	80	28	RNMG1205M0EN-B16	42,120	
	RD16B4040S32R-4	●	4	6	40	28	150	32	50	100	31		66,160	



●印：標準在庫品です。 ●：Stocked items. 無印：弊社営業へお問合せください。 No mark：Contact with our sales department.

■ インサート Inserts

								
P	軟鋼 Mild steels (SC・SS)				■ : 一般切削・第一推奨 General cutting, First recommendation □ : 一般切削・第二推奨 General cutting, Second recommendation			
K	FC・FCD Cast irons							
M	ステンレス鋼 Stainless steels							
S	チタン合金・Ni基超耐熱合金 Titanium alloys, Nickel based alloys							
商品コード Item code		精度 Tolerance class		AJコーティング AJ Coating	GXコーティング GX Coating	寸法 Size (mm)		希望小売価格(円) Suggested retail price (¥)
				JP4120	JM4160	GX2160	r IC S	
RNMG1205M0EN-B16		M級		●	●	●	6 12 4.9	1,920
RNMG1606M0EN-B16		M		●	●	●	8 16 5.9	3,370

【注意】 GX2160は通電式タッチセンサーに反応しませんのでご注意ください。
【Note】 Please note that the GX2160 does not cause a reaction in conductive touch sensors.

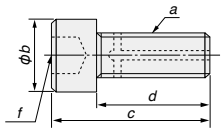
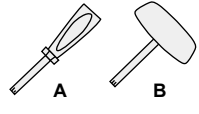
■ 部品番号 Parts

部品名 Parts		クランプねじ Clamp screw			アーバ用ねじ Arbor screw						ドライバー／レンチ Screw driver / Wrench		ねじ焼き付き防止剤 Screw anti-seizure agent		
形状 Shape															
適用カッタ Cutter body		締付トルク Fastening torque (N・m)	希望小売価格(円) Suggested Retail Price (¥)	商品コード Item code	a	φb	c	d	f	希望小売価格(円) Suggested Retail Price (¥)	タイプ Type	希望小売価格(円) Suggested Retail Price (¥)	希望小売価格(円) Suggested Retail Price (¥)		
シャンク Shank	RD16B4032S32R-3	412-142	2.9	540	-	-	-	-	-	-	104-T15	A	2,060	P-37	1,010
	RD16B4040S32R-4				-	-	-	-	-	-					
ボア Bore	RD16B4050R-5	412-142	2.9	540	100-178	M10×1.5	16	35	25	8	104-T15	A	2,060		
	RD16B4063R-6				100-180	M16×2.0	24	51	35	14					
	RD16B4080R-7				※2										
内径 Inch size	RD16B5063R-4	412-144	4.9	540	100-178	M10×1.5	16	35	25	8	105-T20	B	2,120		
	RD16B5080R-5				100-180	M16×2.0	24	51	35	14					
	RD16B5100R-6				※2										
ボア Bore	RD16B4040RM-4	412-142	2.9	540	100-184	M8×1.25	11	33	25	6	104-T15	A	2,060		
	RD16B4050RM-5				100-178	M10×1.5	16	35	25	8					
	RD16B4063RM-6				100-179	M12×1.75	18	42	30	10					
	RD16B4080RM-7				※2										
	RD16B5063RM-4				100-178	M10×1.5	16	35	25	8					
	RD16B5080RM-5				100-179	M12×1.75	18	42	30	10					
内径 mm size	RD16B5100RM-6	412-144	4.9	540	100-180	M16×2.0	24	51	35	14	105-T20	B	2,120		

【注意】
 クランプねじは消耗品です。使用環境により交換寿命は変化しますので早めの交換をお願い致します。
 ※1. 100-184 アーバ用ねじは、カッタ本体に付属しております。
 ※2. φ80用のアーバ用ねじは、インローサイズにより部品サイズが異なります。

【Note】
 The clamp screw is a consumable part. Since replacement life depends on the use environment, it is recommended that it be replaced at an early stage.
 ※ 1.The arbor screw 100-184 is included with the cutter themselves.
 ※ 2.Part size for arbor screw for Ø80 is different due to inlay size.

アルファラジアスミル RD16B

標準切削条件表 Recommended cutting conditions

※赤字は第1推奨材種です。Red indicates primary recommended insert grade.

被削材 Work material	加工方法 Cutting method	推奨材種 Recommended inserts grade	切削速度 Cutting speed Vc(m/min)	軸方向 切込量 Depth of cut ap(mm)	一刃当り の送り Feed rate fz(mm/t)	シャンクタイプ (r6) Shank type				ボアタイプ (r6) Bore type									
						φ 32-3 枚刃 3 flutes		φ 40-4 枚刃 4 flutes		φ 40-4 枚刃 4 flutes		φ 50-5 枚刃 5 flutes		φ 63-6 枚刃 6 flutes		φ 80-7 枚刃 7 flutes			
						回転数 Revolution min ⁻¹	送り速度 Feed speed mm/min	回転数 Revolution min ⁻¹	送り速度 Feed speed mm/min	回転数 Revolution min ⁻¹	送り速度 Feed speed mm/min	回転数 Revolution min ⁻¹	送り速度 Feed speed mm/min	回転数 Revolution min ⁻¹	送り速度 Feed speed mm/min	回転数 Revolution min ⁻¹	送り速度 Feed speed mm/min		
オーステナイト系・ フェライト系 ステンレス鋼 Austenite, ferrite Stainless steels SUS304 SUS316 SUS430 等 etc	Dry 加工 Dry cutting	GX2160	180 ~ 220	2 ~	0.1 ~ 0.2	1,989	1,492	1,592	1,592	1,592	1,592	1,273	1,592	1,011	1,516	796	1,393		
				1 ~ 2	0.2 ~ 0.3	Vc = 200m/min, fz = 0.25mm/t													
	Wet 加工 Wet cutting	JM4160	90 ~ 110	2 ~	0.1 ~ 0.2	995	746	796	796	796	796	637	796	505	758	398	696		
				1 ~ 2	0.2 ~ 0.3	Vc = 100m/min, fz = 0.25mm/t													
マルテンサイト系 ステンレス鋼 Martensite Stainless steels SUS410 SUS420J2 等 etc	Dry 加工 Dry cutting	GX2160	200 ~ 240	2 ~	0.1 ~ 0.2	2,188	1,641	1,751	1,751	1,751	1,751	1,401	1,751	1,112	1,667	875	1,532		
				1 ~ 2	0.2 ~ 0.3	Vc = 220m/min, fz = 0.25mm/t													
	Wet 加工 Wet cutting	JM4160	120 ~ 200	2 ~	0.1 ~ 0.2	1,592	1,194	1,273	1,273	1,273	1,273	1,019	1,273	808	1,213	637	1,114		
				1 ~ 2	0.2 ~ 0.3	Vc = 160m/min, fz = 0.25mm/t													
析出硬化系 ステンレス鋼 Precipitation- hardened Stainless steels SUS630 SUS631 等 etc	Dry 加工 Dry cutting	GX2160	160 ~ 200	2 ~	0.1 ~ 0.2	1,790	1,343	1,432	1,432	1,432	1,432	1,146	1,432	909	1,364	716	1,253		
				1 ~ 2	0.2 ~ 0.3	Vc = 180m/min, fz = 0.25mm/t													
	Wet 加工 Wet cutting	JM4160 JP4120	100 ~ 180	2 ~	0.1 ~ 0.2	1,194	895	955	955	955	955	764	955	606	909	477	836		
				1 ~ 2	0.2 ~ 0.3	Vc = 120m/min, fz = 0.25mm/t													
チタン合金 Titanium alloys Ti-6AL-4V 等 etc	Wet 加工 Wet cutting	JP4120	30 ~ 50	2 ~	0.07 ~ 0.13	398	119	318	127	318	127	255	127	202	121	159	111		
				Vc = 40m/min, fz = 0.1mm/t															
Ni基超耐熱合金 Ni based alloys	Wet 加工 Wet cutting	JP4120	30 ~ 40	2 ~	0.06 ~ 0.1	348	84	279	89	279	89	223	89	177	85	139	78		
				Vc = 35m/min, fz = 0.08mm/t															
軟鋼・炭素鋼 Mild steels, Carbon steels SS,S45C 等 etc	Dry 加工 Dry cutting	GX2160 JP4120	150 ~ 200	2 ~	0.1 ~ 0.2	1,592	1,194	1,273	1,273	1,273	1,273	1,019	1,273	808	1,213	637	1,114		
				1 ~ 2	0.2 ~ 0.3	Vc = 160m/min, fz = 0.25mm/t													
				~ 1	0.3 ~ 0.4	Vc = 160m/min, fz = 0.25mm/t													

被削材 Work material	加工方法 Cutting method	推奨材種 Recommended inserts grade	切削速度 Cutting speed Vc(m/min)	軸方向 切込量 Depth of cut ap(mm)	一刃当り の送り Feed rate fz(mm/t)	ボアタイプ (r8) Bore type					
						φ 63-4 枚刃 4 flutes		φ 80-5 枚刃 5 flutes		φ 100-6 枚刃 6 flutes	
						回転数 Revolution min ⁻¹	送り速度 Feed speed mm/min	回転数 Revolution min ⁻¹	送り速度 Feed speed mm/min	回転数 Revolution min ⁻¹	送り速度 Feed speed mm/min
オーステナイト系・ フェライト系 ステンレス鋼 Austenite, ferrite Stainless steels SUS304 SUS316 SUS430 等 etc	Dry 加工 Dry cutting	GX2160	180 ~ 220	2 ~	0.1 ~ 0.2	1,010	1,010	796	995	637	956
				1 ~ 2	0.2 ~ 0.3	Vc = 200m/min, fz = 0.25mm/t					
	Wet 加工 Wet cutting	JM4160	90 ~ 110	2 ~	0.1 ~ 0.2	505	505	397	496	318	477
				1 ~ 2	0.2 ~ 0.3	Vc = 100m/min, fz = 0.25mm/t					
マルテンサイト系 ステンレス鋼 Martensite Stainless steels SUS410 SUS420J2 等 etc	Dry 加工 Dry cutting	GX2160	200 ~ 240	2 ~	0.1 ~ 0.2	1,112	1,112	875	1,094	700	1,050
				1 ~ 2	0.2 ~ 0.3	Vc = 220m/min, fz = 0.25mm/t					
	Wet 加工 Wet cutting	JM4160	120 ~ 200	2 ~	0.1 ~ 0.2	808	808	637	796	509	764
				1 ~ 2	0.2 ~ 0.3	Vc = 160m/min, fz = 0.25mm/t					
析出硬化系 ステンレス鋼 Precipitation- hardened Stainless steels SUS630 SUS631 等 etc	Dry 加工 Dry cutting	GX2160	160 ~ 200	2 ~	0.1 ~ 0.2	909	909	716	895	572	858
				1 ~ 2	0.2 ~ 0.3	Vc = 180m/min, fz = 0.25mm/t					
	Wet 加工 Wet cutting	JM4160 JP4120	100 ~ 180	2 ~	0.1 ~ 0.2	606	606	477	596	382	573
				1 ~ 2	0.2 ~ 0.3	Vc = 120m/min, fz = 0.25mm/t					
チタン合金 Titanium alloys Ti-6AL-4V 等 etc	Wet 加工 Wet cutting	JP4120	30 ~ 50	2 ~	0.07 ~ 0.13	202	202	159	95	127	76
				Vc = 40m/min, fz = 0.1mm/t							
Ni基超耐熱合金 Ni Based alloys	Wet 加工 Wet cutting	JP4120	30 ~ 40	2 ~	0.06 ~ 0.1	177	57	139	56	111	53
				Vc = 35m/min, fz = 0.08mm/t							
軟鋼・炭素鋼 Mild steels, Carbon steels SS,S45C 等 etc	Dry 加工 Dry cutting	GX2160 JP4120	150 ~ 200	2 ~	0.1 ~ 0.2	808	808	637	796	509	764
				1 ~ 2	0.2 ~ 0.3	Vc = 160m/min, fz = 0.25mm/t					
				~ 1	0.3 ~ 0.4	Vc = 160m/min, fz = 0.25mm/t					

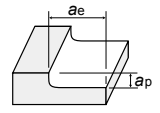

【注意】

- ① この切削条件表は切削条件の目安を示すものです。実際の加工では、加工形状、目的、使用機械等により条件を調整してください。
- ② GX2160は、通電式タッチセンサーに反応しませんのでご注意ください。
- ③ インサートの交換は早めに行い、過度の使用による破損を防いでください。
- ④ 被削材、加工形状に合わせて、適切なクーラントを使用してください。

【Note】

- ① These conditions are for general guidance; in actual machining conditions adjust the parameters according to your actual machine and work-piece conditions.
- ② Please note that the GX2160 does not cause a reaction in conductive touch sensors.
- ③ In order to avoid of insert breakage, please change insert earlier.
- ④ Use the appropriate coolant for the work material and machining shape.

※径方向切込量 ae は、0.3DCX ~ 0.6DCX を推奨いたします。

It is recommended that ae be set between 0.3DCX and 0.6DCX.

※切削条件の調整は次頁を参照して下さい。

See next page for adjustment of cutting conditions.

○ 傾斜切削について Regarding ramping

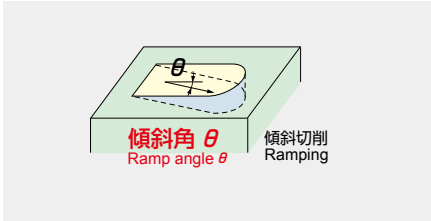

最大傾斜角 θ Maximum ramp angle θ

	工具径 DCX Tool dia. (mm)					
	$\phi 32$	$\phi 40$	$\phi 50$	$\phi 63$	$\phi 80$	$\phi 100$
RD16B4000形 RD16B4000 type	0.6°	1°	1.3°	1°	0.5°	
RD16B5000形 RD16B5000 type				1°	1°	0.7°

[注意] 十分な切りくず排除を行い、異常な振動がないことを確認のうえ、使用することをお勧め致します。

[Note] It is recommended that the tool be used while performing sufficient chip removal and checking that there are no abnormal vibrations.

○ 切削条件の調整 Adjustment of cutting conditions

- 工具突出し量、加工状況に合わせて送り量と回転数の調整が必要となります。
- 標準切削条件を100%として、右記表を参考に加工条件の調整を行ってください。

- Feed rate and spindle revolution must be adjusted to correspond to tool overhang and machining conditions.
- Please consider the standard cutting conditions as 100% and adjust the machining conditions by referring to the table right.

		突出し量 Overhang		
		<3DCX	3DCX~5DCX	5DCX<
面加工 Surfacing	回転数 Rotation speed	100%	70%	50%
	送り量 Feed rate	100%	70%	50%
肩削り加工 Shoulder cutting	回転数 Rotation speed	100%	70%	50%
	送り量 Feed rate	70%	50%	35%
溝加工 Slotting	回転数 Rotation speed	100%	70%	50%
	送り量 Feed rate	80%	55%	40%
傾斜切削 Ramping	回転数 Rotation speed	100%	70%	50%
	送り量 Feed rate	80%	55%	40%

⚠ 安全上のご注意 Attentions on Safety

- ① 排出した切りくずは、飛散し作業者を切傷させ、やけどあるいは目に入って負傷させる恐れがありますので、ご使用に際してはその周囲に安全カバーを取付け、保護メガネなどの保護具を着用し、安全な環境で作業されることをお願い致します。
 - ② 不水溶性切削油は、火災の恐れがありますので使用しないでください。
- ① The steel chips may cause cuts, burns or damages to eyes. Be sure to install the safety cover around the tool and wear the safety glasses when carrying out any works.
② Do not use non-water-soluble cutting oils. Such oils may result in fire.

アルファラジアスミルRV

- 独自の回転防止機構で確実なインサート割出しを実現。
 - ステンレス鋼、チタン合金、ニッケル基合金等の難削材加工に適します。
 - タービンブレード加工に適しています。
- ・ Achieves secure insert indexing using our original rotation prevention mechanism.
 ・ Suitable for difficult-to-cut materials such as stainless steel, titanium alloys, nickel-based alloys, etc.
 ・ For cutting turbine blades



RV○S○○○R-○ ストレートシャックタイプ Straight Shank type

○は数字が入ります。 Numeric figure in a circle ○

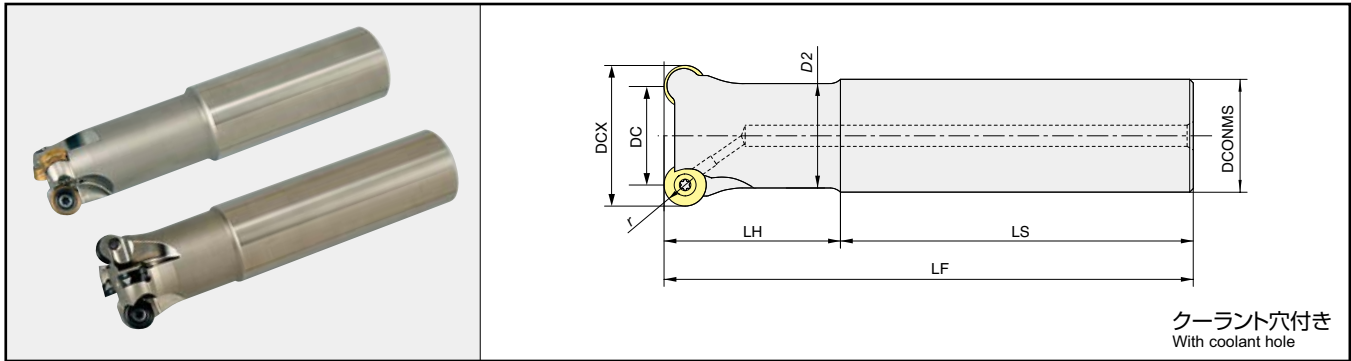

クーラント穴付き
With coolant hole

商品コード Item code	在庫 Stock	刃数 No. of flutes	寸法 Size (mm)									適用インサート Inserts	希望小売価格 (円) Suggested retail price (¥)
			r	DCX	DC	LF	DCONMS	LS	Ls	D2			
シャックタイプ Shank type	RV3S025R-3	●	3	5	25	15	140	25	60	80	21	RPOT10T3M0N-○	42,470
	RV3S032R-4	●	4	5	32	22	150	32	70	80	28		47,640
	RV3S040R-5	●	5	5	40	30	150	32	70	80	30		61,000
	RV4S032R-3	●	3	6	32	20	150	32	70	80	28	RPOT1204M0N-○	38,250
	RV4S040R-3	●	3	6	40	28	150	32	50	100	29.6		50,800
	RV4S040R-4	●	4	6	40	28	150	32	50	100	29.6		60,180

○は数字が入ります。 Numeric figure in a circle ○

RV○M○○○R-○ モジュラータイプ Modular type

モジュラーミル用シャックはD2頁を、締め付けトルクについてはD5頁を参照ください。
Refer page D2 about the shanks for Modular Mill, Refer page D5 about tightening torque

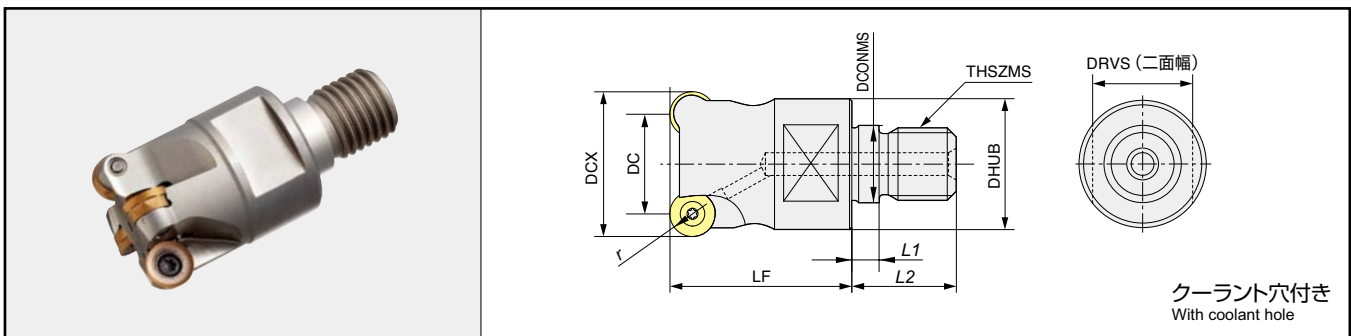

クーラント穴付き
With coolant hole

商品コード Item code	在庫 Stock	刃数 No. of flutes	寸法 Size (mm)											適用インサート Inserts	希望小売 価格(円) Suggested retail price (¥)
			r	DCX	DC	LF	DCONMS	THSZMS	DHUB	L1	L2	DRVS			
モジュラータイプ Modular type	RV3M025R-3	●	3	5	25	15	35	12.5	M12	20.8	5.5	22	17	RPOT10T3M0N-○	42,470
	RV3M032R-4	●	4	5	32	22	40	17	M16	28.8	6	23	22		47,640
	*RV3M040R-5	●	5	5	40	30	40	17	M16	28.8	6	23	22		61,000
	RV4M032R-3	●	3	6	32	20	40	17	M16	28.8	6	23	22	RPOT1204M0N-○	38,250
	*RV4M040R-3	●	3	6	40	28	40	17	M16	28.8	6	23	22		50,800
	*RV4M040R-4	●	4	6	40	28	40	17	M16	28.8	6	23	22		60,180

【注意】※と超硬シャックをセットで使用すると干渉がありません。
モジュラーミル及び専用シャック、専用アーバの「工具端面」「モジュラーねじ部」にグリースなどの潤滑剤は塗布しないでください。

【Note】 When * and carbide shank are used together as a set, there is no interference.
Do not apply lubricants such as grease, etc. to the "contact faces" and "modular screws" of the "modular mill", "dedicated shanks" and "dedicated arbor".

●印：標準在庫品です。 ●：Stocked items.

RV○B○0○0○R-○/RV○B○0○0○RM-○

ボアタイプ Bore type

○は数字が入ります。 Numeric figure in a circle ○

ボアタイプ用アーバはD11頁を参照ください。
Refer page D11 about the bore type arbor

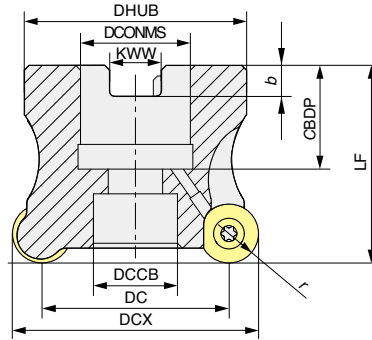

クーラント穴付き
With coolant hole

商品コード Item code	在庫 Stock	刃数 No. of flutes	寸 法 Size (mm)											適用インサート Inserts	希望小売 価格(円) Suggested retail price (¥)
			r	DCX	DC	DHUB	LF	DCONMS	DCCB	KWW	b	CBDF			
内径インチ Internal diameter inch size	●	5	6	50	38	45	40	22.225	17	8.4	5	19	RPST1204M0EN-S○	85,630	
	●	6	6	63	51	58	40	22.225	17	8.4	5	19		102,770	
	●	7	6	80	68	76	63	31.75	26	12.7	8	32		107,810	
内径ミリ Internal diameter mm size	●	5	5	40	30	35	40	16	13.2	8.4	5.6	19	RPST10T3M0EN-S○	66,640	
	●	5	5	42	32	35	40	16	13.2	8.4	5.6	19		66,640	
	●	4	6	40	28	35	40	16	13.2	8.4	5.6	19	RPST1204M0EN-S○	57,250	
	●	4	6	42	30	35	40	16	13.2	8.4	5.6	19		57,250	
	●	5	6	50	38	45	40	22	17	10.4	6.3	20		85,630	
	●	6	6	63	51	58	40	22	17	10.4	6.3	20		102,770	
	●	7	6	80	68	76	50	27	20	12.4	7	22		107,810	

[注意] アーバ用ねじは付属しません。 **[Note]** Arbor screw is not included.

アルファラジアスミルRV

■ インサート Inserts

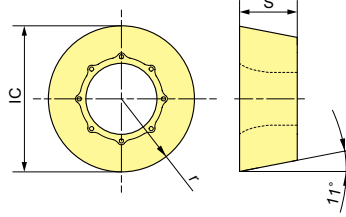

M	ステンレス鋼 Stainless steels	■ (Dry)	■ (Wet)	■ (Dry)		■ 一般切削 General cutting			希望小売価格(円) Suggested retail price(¥)		
	N	アルミニウム合金 Aluminum alloys									
S	チタン合金 Titanium alloys			■							
商品コード Item code	精度 Tolerance class	AXコーティング AX Coating	AJコーティング AJ Coating	GXコーティング GX Coating	JSコーティング JS Coating	SDコーティング SD Coating	寸法 Size(mm)				
		AX2040	JM4160	GX2160	JS1025	SD5010	r	IC	S		
RPET10T3M0FN-A8	E級 E	-	-	-	●	●	5	10	3.97	1,640	2,300
RPMT10T3M0EN-B8	M級 M	●	●	●	-	-				1,030	-
RPMT10T3M0EN-C8		●	●	●	-	-				1,030	-
RPHT10T3M0EN-B8		●	●	●	●	-				1,640	-
RPHT10T3M0EN-C8	H級 H	●	●	●	-	-				1,640	-
RPET1204M0FN-A8	E級 E	-	-	-	●	●	6	12	4.76	1,690	2,370
RPMT1204M0EN-B8	M級 M	●	●	●	-	-				1,320	-
RPMT1204M0EN-C8		●	●	●	-	-				1,320	-
RPHT1204M0EN-B8		●	●	●	●	-				1,690	-
RPHT1204M0EN-C8	H級 H	●	●	●	-	-				1,690	-

【注意】 AXコーティング、GXコーティング、JSコーティングは通電式タッチセンサーに反応しませんのでご注意ください。
 【Note】 Please note that the AX Coating, GX Coating and JS Coating do not cause a reaction in conductive touch sensors.

■ 部品番号 Parts

○は数字が入ります。 Numeric figure in a circle ○

部品名 Parts		クランプねじ Clamp screw		アーバ用ねじ ^{*2} Arbor screw						ドライバー/レンチ Screw driver / Wrench		ねじ焼き付き防止剤 Screw anti-seizure agent	
形状 Shape													
適用カッター Cutter body		締付トルク Fastening torque (N·m)	希望小売価格(円) Suggested retail price (¥)	商品コード Item code	a	φb	c	d	f	希望小売価格(円) Suggested retail price (¥)	形状 Shape	希望小売価格(円) Suggested retail price (¥)	希望小売価格(円) Suggested retail price (¥)
シャंक Shank	RV3S0○○R-○	265-141	2.0 870	-	-	-	-	-	-	-	104-T10	A 1,920	P-37 1,010
	RV4S0○○R-○	262-142	2.9 870	-	-	-	-	-	-	-	104-T15	A 2,060	
モジュラー Modular	RV3M0○○R-○	265-141	2.0 870	-	-	-	-	-	-	-	104-T10	A 1,920	
	RV4M0○○R-○	262-142	2.9 870	-	-	-	-	-	-	-	104-T15	A 2,060	
ボア 内径インチ inch size	RV4B050R-5	262-142	2.9 870	100-178	M10×1.5	16	35	25	8	1,760	105-T15	B 2,120	
	RV4B063R-6			100-180 ^{*1}	M16×2.0	24	51	35	14	1,760			
	RV4B080R-7			100-183	M8×1.25	13	33	25	6	1,760			
ボア 内径ミリ mm size	RV3B0○○R-○	265-141	2.0 870	100-183	M8×1.25	13	33	25	6	1,760	104-T10	A 1,920	
	RV4B040RM-4	262-142	2.9 870	100-183	M8×1.25	13	33	25	6	1,760	105-T15	B 2,120	
	RV4B042RM-4			100-183	M8×1.25	13	33	25	6	1,760			
	RV4B050RM-5			100-178	M10×1.5	16	35	25	8	1,760			
RV4B063RM-6	100-178			M10×1.5	16	35	25	8	1,760				
RV4B080RM-7	262-142	2.9 870	100-179 ^{*1}	M12×1.75	18	42	30	10	1,760				

*1 φ80用のアーバ用ねじは、インローサイズにより部品サイズが異なります。 *1 Part size for arbor screw for φ80 is different due to inlay size.
 *2 各切れ刃にエア、切削油剤を供給する場合は、本アーバ用ねじをご使用ください。 *2 When supplying air or cutting oil to each cutting flute, please use this arbor screw.

【注意】 クランプねじは消耗品です。使用環境により交換寿命は変化しますので早めの交換をお願い致します。クランプねじは予備が1本付属します。アーバ付属のねじでも、センタースルーとしてそのままご使用できます。

【Note】 The clamp screw is a consumable part. Since replacement life depends on the use environment, it is recommended that it be replaced at an early stage. Includes one spare clamp screw. Even with the screws included with the arbor, the arbor can be used as it is for center through.

●印：標準在庫品です。 ●：Stocked items. -印：製作致しません。 -：Not manufactured.

■ 難削材加工に適したブレイカ及びコーティング材種をラインナップ！ Lineup of breakers and coating materials suitable for difficult to cut materials

- ステンレス鋼、チタン合金、Ni基超耐熱合金、アルミ合金加工用に3種類のブレイカを用意!!
• 3 types of breakers are available for cutting stainless steels, titanium alloys, Ni based alloys, and aluminum alloys.

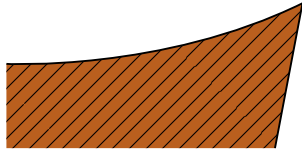
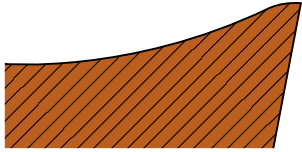
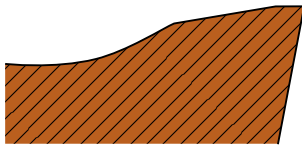
		シャープエッジ切れ刃 Sharp-edge A8形 A8 Type	快削ブレイカ Easy cutting breaker B8形 B8 Type	刃先強化ブレイカ Strong edge breaker C8形 C8 Type
インサート 断面形状 Insert cross section				
インサート 材種 Grade	JM4160	—	ステンレス鋼(WET加工) Stainless Steels (Wet cutting)	
	AX2040 GX2160	—	ステンレス鋼(DRY加工) Stainless Steels (Dry cutting)	
	JS1025	チタン合金(仕上げ加工) Titanium alloys (finishing)	チタン合金 Ni基超耐熱合金 Titanium alloys, Ni based alloys	—
	SD5010	アルミ合金 Aluminum alloys	—	—

■ 実績は語る Field data

	ユーザー User	ワーク Work material	使用工具 Tools	切削条件 Cutting conditions	結果 Result
1	A社 Company A	プレート SUS304 Plate	ボディ : RV4S040R-3 Body インサート : RPMT1204M0EN-B8 Insert JM4160	Wet加工 Wet cutting $v_c = 200\text{m/min}$, $f_z = 0.15\text{mm/t}$, $a_p \times a_e = 1.5 \times 25\text{mm}$	従来工具より能率50%UP 工具寿命も良好。 50% higher efficiency than conventional tools. Tool life is also good.
2	B社 Company B	機械部品 SUS304 Machine parts	ボディ : RV4S040R-3 Body インサート : RPMT1204M0EN-B8 Insert JM4160	Wet加工 Wet cutting $v_c = 200\text{m/min}$, $f_z = 0.2\text{mm/t}$, $a_p \times a_e = 1.5 \times 20\text{mm}$	摩耗量少なく結果良好。 Good results with low wear amount.
3	C社 Company C	インペラ SUS410 Impeller	ボディ : RV4B080R-7 Body インサート : RPMT1204M0EN-B8 Insert GX2160	Dry加工 Dry cutting $v_c = 200\text{m/min}$, $f_z = 0.5\text{mm/t}$, $a_p \times a_e = 2 \times 60\text{mm}$	従来工具に対して工具寿命が約2倍 となり、良好。 Good; tool life is approximately 2 times that of conventional tools.
4	D社 Company D	ブレード SUS材 Blade Stainless steels	ボディ : RV4B050R-5 Body インサート : RPMT1204M0EN-C8 Insert GX2160	Dry加工 Dry cutting $v_c = 330\text{m/min}$, $f_z = 0.24\text{mm/t}$, $a_p \times a_e = 5 \times 12\text{mm}$	従来工具に対して工具寿命が約2倍 となり、良好。 Good; tool life is approximately 2 times that of conventional tools.
5	E社 Company E	ブレード SUS材 Blade Stainless steels	ボディ : RV4B050RM-5 Body インサート : RPMT1204M0EN-B8 Insert JM4160	Wet加工 Wet cutting $v_c = 200\text{m/min}$, $f_z = 0.5\text{mm/t}$, $a_p \times a_e = 1 \times 35\text{mm}$	従来工具に対して、工具寿命が1.5~ 2倍となり、良好。 Good; tool life is approximately 1.5 to 2 times that of conventional tools.

アルファラジアスミルRV

標準切削条件表 Recommended cutting conditions

※赤字は第一推奨材種です。Red indicates primary recommended grade.

被削材 Work material	加工方法 Cutting method	推奨材種 Recommended grade	ブレーカ 形状 Breaker shape	切削 速度 Cutting speed Vc(m/min)	軸方向 切込量 Depth of cut ap(mm)	一刃当りの 送り Feed rate fz(mm/t)	シャンクタイプ(r5) Shank type モジュラータイプ(r5) Modular type						ボアタイプ(r5) Bore type				
							φ25-3枚刃 3 flutes		φ32-4枚刃 4 flutes		φ40-5枚刃 5 flutes		φ40-5枚刃 5 flutes		φ42-5枚刃 5 flutes		
							回転数 Revolution min ⁻¹	送り速度 Feed speed mm/min	回転数 Revolution min ⁻¹	送り速度 Feed speed mm/min	回転数 Revolution min ⁻¹	送り速度 Feed speed mm/min	回転数 Revolution min ⁻¹	送り速度 Feed speed mm/min	回転数 Revolution min ⁻¹	送り速度 Feed speed mm/min	
オーステナイト系 Austenite type フェライト系 Ferrite type ステンレス鋼 Stainless steels SUS304 SUS316 SUS430等 etc	Dry加工 Dry cutting	AX2040	-C8	180~ 220	2~	0.1~0.2	vc=200m/min、fz=0.2mm/t						vc=200m/min、fz=0.2mm/t				
		GX2160			1~2	0.2~0.3											
	Wet加工 Wet cutting	JM4160	-B8	90~ 110	2~	0.1~0.2	1,273	764	995	796	796	796	796	796	758	758	
					1~2	0.2~0.3	vc=100m/min、fz=0.2mm/t						vc=100m/min、fz=0.2mm/t				
マルテンサイト系 Martensite type ステンレス鋼 Stainless steels SUS410 SUS420J2 等 etc	Dry加工 Dry cutting	AX2040	-C8	200~ 240	2~	0.1~0.2	vc=220m/min、fz=0.2mm/t						vc=220m/min、fz=0.2mm/t				
		GX2160			1~2	0.2~0.3											
	Wet加工 Wet cutting	JM4160	-B8	120~ 200	2~	0.1~0.2	2,037	1,222	1,592	1,273	1,273	1,273	1,273	1,273	1,213	1,213	
					1~2	0.2~0.3	vc=160m/min、fz=0.2mm/t						vc=160m/min、fz=0.2mm/t				
析出硬化系 Precipitation-hardened type ステンレス鋼 Stainless steels SUS630 SUS631 等 etc	Dry加工 Dry cutting	AX2040	-C8	160~ 200	2~	0.1~0.2	vc=180m/min、fz=0.2mm/t						vc=180m/min、fz=0.2mm/t				
		GX2160			1~2	0.2~0.3											
	Wet加工 Wet cutting	JM4160	-B8	100~ 180	2~	0.1~0.2	1,528	917	1,194	955	955	955	955	955	909	909	
					1~2	0.2~0.3	vc=120m/min、fz=0.2mm/t						vc=120m/min、fz=0.2mm/t				
アルミ合金 Aluminum alloys A5052 等 etc	Dry加工 Dry cutting	SD5010	-A8	300~ 500	2~	0.1~0.2	vc=300m/min、fz=0.2mm/t						vc=300m/min、fz=0.2mm/t				
					1~2	0.2~0.3											
	Wet加工 Wet cutting					2~	0.1~0.2	vc=300m/min、fz=0.2mm/t						vc=300m/min、fz=0.2mm/t			
						1~2	0.2~0.3										
チタン合金 Titanium alloys Ti-6AL-4V 等 etc	Wet加工 Wet cutting	JS1025	-B8 (荒加工) -A8 (仕上げ加工)	30~ 50	~2	0.07~ 0.13	vc=40m/min、fz=0.1mm/t						vc=40m/min、fz=0.1mm/t				
																	509
	Wet加工 Wet cutting							vc=35m/min、fz=0.08mm/t						vc=35m/min、fz=0.08mm/t			

- 【注意】** ①この切削条件表は切削条件の目安を示すものです。実際の加工では、加工形状、目的、使用機械等により条件を調整してください。
 ②AXコーティング、GXコーティング、JSコーティングは通電式タッチセンサーに反応しませんのでご注意ください。
 ③インサートの交換は早めに行い、過度の使用による破損を防いでください。
 ④被削材、加工形状に合わせて、適切なクーラントを使用してください。

- 【Note】** ①These conditions are for general guidance; in actual machining conditions adjust the parameters according to your actual machine and work-piece conditions.
 ②Please note that the AX Coating, GX Coating and JS Coating do not cause a reaction in conductive touch sensors.
 ③In order to avoid of insert breakage, please change insert earlier.
 ④Use the appropriate coolant for the work material and machining shape.

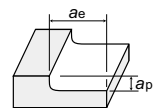

切削条件の調整 Adjustment of cutting conditions

- 工具突出し量、加工状況に合わせて送り量と回転数の調整が必要となります。
 • Feed rate and spindle revolution must be adjusted to correspond to tool overhang and machining conditions.
- 標準切削条件を100%として、右記表を参考に加工条件の調整を行ってください。
 • Please consider the standard cutting conditions as 100% and adjust the machining conditions by referring to the right table.

		突出し量 Overhang		
		<3DCX	3DCX~5DCX	5DCX<
面加工 Surfacing	回転数 Rotation speed	100%	70%	50%
	送り量 Feed rate	100%	70%	50%
肩削り加工 Shoulder cutting	回転数 Rotation speed	100%	70%	50%
	送り量 Feed rate	70%	50%	35%
溝加工 Slotting	回転数 Rotation speed	100%	70%	50%
	送り量 Feed rate	70%	50%	35%
傾斜切削 Ramping	回転数 Rotation speed	100%	70%	50%
	送り量 Feed rate	80%	55%	40%

被削材 Work material	加工方法 Cutting method	シャンクタイプ(r6) Shank type						ボアタイプ(r6) Bore type									
		φ32-3枚刃 3 flutes		φ40-3枚刃 3 flutes		φ40-4枚刃 4 flutes		φ40-4枚刃 4 flutes		φ42-4枚刃 4 flutes		φ50-5枚刃 5 flutes		φ63-6枚刃 6 flutes		φ80-7枚刃 7 flutes	
		回転数 Revolution min ⁻¹	送り速度 Feed speed mm/min	回転数 Revolution min ⁻¹	送り速度 Feed speed mm/min	回転数 Revolution min ⁻¹	送り速度 Feed speed mm/min	回転数 Revolution min ⁻¹	送り速度 Feed speed mm/min	回転数 Revolution min ⁻¹	送り速度 Feed speed mm/min	回転数 Revolution min ⁻¹	送り速度 Feed speed mm/min	回転数 Revolution min ⁻¹	送り速度 Feed speed mm/min	回転数 Revolution min ⁻¹	送り速度 Feed speed mm/min
オーステナイト系 Austenite type フェライト系 Ferrite type ステンレス鋼 Stainless steels SUS304 SUS316 SUS430等 etc	Dry加工 Dry cutting	1,989	1,492	1,592	1,194	1,592	1,592	1,592	1,592	1,516	1,516	1,273	1,592	1,011	1,516	796	1,393
	$v_c=200\text{m/min}, f_z=0.25\text{mm/t}$						$v_c=200\text{m/min}, f_z=0.25\text{mm/t}$										
マルテンサイト系 Martensite type ステンレス鋼 Stainless steels SUS410 SUS420J2 等 etc	Dry加工 Dry cutting	2,188	1,641	1,751	1,313	1,751	1,751	1,751	1,751	1,667	1,667	1,401	1,751	1,112	1,667	875	1,532
	$v_c=220\text{m/min}, f_z=0.25\text{mm/t}$						$v_c=220\text{m/min}, f_z=0.25\text{mm/t}$										
析出硬化系 Precipitation-hardened type ステンレス鋼 Stainless steels SUS630 SUS631 等 etc	Dry加工 Dry cutting	1,989	1,492	1,592	1,194	1,592	1,592	1,592	1,592	1,516	1,516	1,273	1,592	1,011	1,516	796	1,393
	$v_c=160\text{m/min}, f_z=0.25\text{mm/t}$						$v_c=160\text{m/min}, f_z=0.25\text{mm/t}$										
アルミ合金 Aluminum alloys A5052 等 etc	Dry加工 Dry cutting	1,790	1,343	1,432	1,074	1,432	1,432	1,432	1,432	1,364	1,364	1,146	1,432	909	1,364	716	1,253
	$v_c=180\text{m/min}, f_z=0.25\text{mm/t}$						$v_c=180\text{m/min}, f_z=0.25\text{mm/t}$										
チタン合金 Titanium alloys Ti-6AL-4V 等 etc	Dry加工 Dry cutting	1,194	895	955	716	955	955	955	955	909	909	764	955	606	909	477	835
	$v_c=120\text{m/min}, f_z=0.25\text{mm/t}$						$v_c=120\text{m/min}, f_z=0.25\text{mm/t}$										
Ni基超耐熱合金 Ni based alloys	Dry加工 Dry cutting	2,984	2,238	2,387	1,790	2,387	2,387	2,387	2,387	2,274	2,274	1,910	2,387	1,516	2,274	1,194	2,089
	$v_c=300\text{m/min}, f_z=0.25\text{mm/t}$						$v_c=300\text{m/min}, f_z=0.25\text{mm/t}$										
ステンレス鋼 SUS304 SUS316 SUS430等 etc	Wet加工 Wet cutting	995	746	796	597	796	796	796	796	758	758	637	796	505	758	398	696
	$v_c=100\text{m/min}, f_z=0.25\text{mm/t}$						$v_c=100\text{m/min}, f_z=0.25\text{mm/t}$										
チタン合金 Titanium alloys Ti-6AL-4V 等 etc	Wet加工 Wet cutting	398	119	318	95	318	127	318	127	303	121	255	127	202	121	159	111
	$v_c=40\text{m/min}, f_z=0.1\text{mm/t}$						$v_c=40\text{m/min}, f_z=0.1\text{mm/t}$										
Ni基超耐熱合金 Ni based alloys	Wet加工 Wet cutting	348	84	279	67	279	89	279	89	265	85	223	89	177	85	139	78
	$v_c=35\text{m/min}, f_z=0.08\text{mm/t}$						$v_c=35\text{m/min}, f_z=0.08\text{mm/t}$										

安全上のご注意 Attentions on Safety

- ① 排出した切りくずは、飛散し作業者を切傷させ、やけどあるいは目に入って負傷させる恐れがありますので、ご使用に際してはその周囲に安全カバーを取付け、保護メガネなどの保護具を着用し、安全な環境で作業されることをお願い致します。
- ② 不水溶性切削油は、火災の恐れがありますので使用しないでください。
- ① The steel chips may cause cuts, burns or damages to eyes. Be sure to install the safty cover around the tool and wear the safty glasses when carrying out any works.
- ② Do not use non-water-soluble cutting oils. Such oils may result in fire.

切込み量 Depth of cut

- 軸方向切込量 a_p は、使用インサートのサイズにより調整ください。
- 径方向切込量 a_e は、0.3DCX~0.6DCXを推奨いたします。

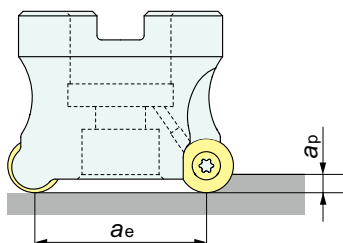

インサートサイズ Inserts size	推奨軸方向切込量 a_p Recommended a_p	最大軸方向切込量 a_p Maximum a_p	推奨切込幅 a_e Recommended a_e
RP-T1204M0	1~3mm	6mm	0.3DCX~0.6DCX
RP-T10T3M0	1~2.5mm	5mm	



- 刃先強度と切れ味を合わせ持つねじれ刃形インサートを追加ラインナップ！
- 2枚刃 刃先交換式高精度仕上げ用ラジアスエンドミルです。(取付け振れ精度0.02mm以下)
- 高精度なボデーと取付けねじからなる独特のクランプ機構により、インサートを高精度かつ強固に取付けすることが可能です。

- ・ Additional lineup of helical cutting edge inserts which offer both cutting edge strength and cutting performance.
- ・ 2 flutes radius end Mill for high-precision finishing. (Mounting runout accuracy of 0.02mm or less)
- ・ Unique clamp mechanism comprised of high-accuracy body and mounting screw enables inserts to be attached firmly with high accuracy.

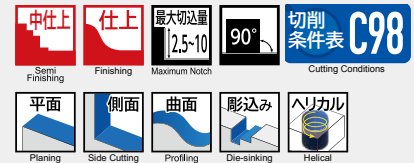

○は数字が入ります。 Numeric figure in a circle ○

ARPFM○○(-H) モジュラータイプ Modular type

モジュラーミル用シャンクはD2頁を、締め付けトルクについてはD5頁を参照ください。
Refer page D2 about the shanks for Modular Mill, Refer page D5 about tightening torque

商品コード Item code	在庫 Stock	Insets No. of inserts	寸法 Size (mm)										適用インサート Inserts	希望小売 価格(円) Suggested retail price(¥)
			DC	LF	APMX	DCONMS	THSZMS	DHUB	L1	L2	DRVS			
ARPFM10	●	1	10	26(26.4)	3	6.5	M6	9.8	5.5	14.5	7	ZCFG100S (R) ZCFW100-R	19,240	
ARPFM12	●	1	12	26(26.6)	4	6.5	M6	9.8	5.5	14.5	7	ZCFG120S (R) ZCFW120-R ZCFG130S (R) *	20,070	
ARPFM16	●	1	16	32(32.6)	5	8.5	M8	12.8	5.5	17	10	ZCFG160S (R) ZCFW160-R ZCFG170S (R) *	23,350	
ARPFM20	●	1	20	38(39)	6	10.5	M10	17.8	5.5	19	15	ZCFG200S (R) ZCFW200-R ZCFG210S (R) *	26,870	
ARPFM25	●	1	25	38(39.8)	8	12.5	M12	20.8	5.5	22	17	ZCFG250S (R) ZCFW250-R ZCFG260S (R) *	34,260	
ARPFM30	●	1	30	43(45.2)	10	17	M16	28.8	6	23	22	ZCFG300S (R) ZCFW300-R	41,060	
ARPFM32	●	1	32	43(45.2)	10	17	M16	28.8	6	23	22	ZCFG320S (R) ZCFW320-R	41,060	

商品コード Item code	在庫 Stock	Insets No. of inserts	寸法 Size (mm)										適用インサート Inserts	希望小売 価格(円) Suggested retail price(¥)
			DC	LF	APMX	DCONMS	THSZMS	DHUB	L1	L2	DRVS			
ARPFM10-H	●	1	10	26 (26.4)	3	6.5	M6	9.8	5.5	14.5	7	ZCFG100S (R) ZCFW100-R	21,120	
ARPFM12-H	●	1	12	26 (26.6)	4	6.5	M6	9.8	5.5	14.5	7	ZCFG120S (R) ZCFW120-R ZCFG130S (R) *	22,060	
ARPFM16-H	●	1	16	32 (32.6)	5	8.5	M8	12.8	5.5	17	10	ZCFG160S (R) ZCFW160-R ZCFG170S (R) *	25,700	
ARPFM20-H	●	1	20	38 (39)	6	10.5	M10	17.8	5.5	19	15	ZCFG200S (R) ZCFW200-R ZCFG210S (R) *	29,570	
ARPFM25-H	●	1	25	38 (39.8)	8	12.5	M12	20.8	5.5	22	17	ZCFG250S (R) ZCFW250-R ZCFG260S (R) *	37,670	
ARPFM30-H	●	1	30	43 (45.2)	10	17	M16	28.8	6	23	22	ZCFG300S (R) ZCFW300-R	45,170	
ARPFM32-H	●	1	32	43 (45.2)	10	17	M16	28.8	6	23	22	ZCFG320S (R) ZCFW320-R	45,170	

※φ13インサートはφ12ボディ、φ17インサートはφ16ボディ、φ21インサートはφ20ボディ、φ26インサートはφ25ボディに取付ける事ができます。

※A φ13 mm insert can be mounted on a φ12 mm body, a φ17 mm insert can be mounted on a φ16 mm body, a φ21 mm insert can be mounted on a φ20 mm body, or a φ26 mm insert can be mounted on a φ25 mm body.

[注意] モジュラーミル及び専用シャンク、専用アークの「工具端面」「モジュラーねじ部」にグリースなどの潤滑剤は塗布しないでください。

() 寸法は、ZCFGタイプのインサート取り付け時を示します。

[Note] Do not apply lubricants such as grease, etc. to the "contact faces" and "modular screws" of the "modular mill", "dedicated shanks" and "dedicated arbor".
Dimensions in parentheses () are with ZCFG type inserts installed.

部品番号 Parts

部品名 Parts	形状 Shape	クランプねじ Clamp screw		ドライバー/レンチ Screw Driver/Wrench			ねじ焼き付き防止剤 Screw anti-seizure agent								
適用カッタ Cutter body		締付トルク Fastening torque (N·m)	希望小売価格(円) Suggested retail price (¥)		希望小売価格(円) Suggested retail price (¥)	タイプ Type		希望小売価格(円) Suggested retail price (¥)							
		ARPF06S (W/WL)	581-140						0.5	1,970	104-T6	1,800	A	P-37	1,010
		ARPF08S (L/WL)	581-141						1.1	1,490	104-T8	1,800	A		
		ARPF10S (L/WL) ARPFM10 (-H)	581-142						2.2	1,490	104-T10	1,920	A		
		ARPF12S (L/WL) ARPFM12 (-H)	581-143						4.9	1,490	105-T20	2,120	B		
		ARPF16S (L/E/WE) ARPFM16 (-H)	581-144						4.9	1,490					
		ARPF20S (L/E/WE) ARPFM20 (-H)	581-145						6.9	1,490	105-T30A	2,120	C		
		ARPF25S (L/E/WE) ARPFM25 (-H)	581-146						9.8	1,710					
		ARPF30S (L/E/WE) ARPFM30 (-H)	581-147						9.8	1,710					
ARPF32S (L/E/WE) ARPFM32 (-H)															

[注意] クランプねじは消耗品です。使用環境により交換寿命は変化しますので早めの交換をお願い致します。

[Note] The clamp screw is a consumable part. Since replacement life depends on the use environment, it is recommended that it be replaced at an early stage.

●印：標準在庫品です。 ●：Stocked items.

ARPF○○S○○(□○○○/□○○○) シャンクタイプ Shank type

○は数字、□は英文字が入ります。
Numeric figure in a circle ○ and Alphabetical character comes in a square □

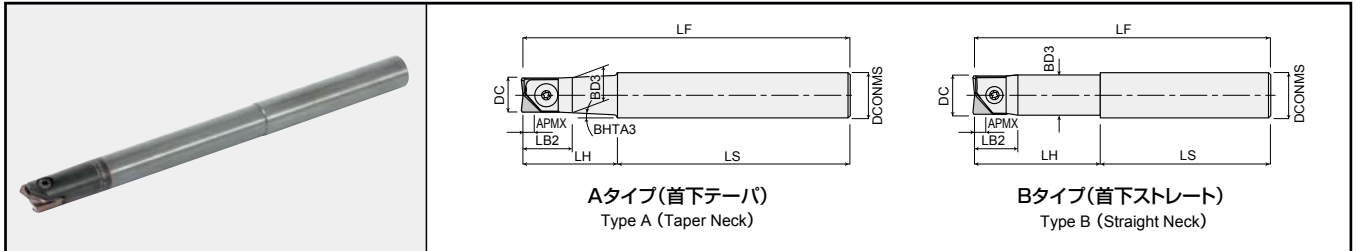

商品コード Item code	在庫 Stock	No. of inserts 挿入可能数	寸法 Size (mm)										形状 Shape	適用インサート Inserts	希望小売 価格(円) Suggested retail price (¥)	
			DC	LF	DCONMS	APMX	LB2	LH	BHTA3	BD3	LS					
Regular shank — リギュラーシャフト	ARPF06S10	●	1	6	80	10	2.0	15	30	8.25°	5.4	50	A	ZCFG06NS□(R○○○) ZCFW060-R○○○	15,730	
	ARPF08S12	●	1	8	100(100.2)	12	2.5	10(10.2)	22(22.2)	9.5°	7.5	78	A	ZCFG080S□(R○○○) ZCFW080-R○○○	18,430	
	ARPF10S12	●	1	10	100(100.4)	12	3.0	13(13.4)	25(25.4)	3°	9.5	75	A	ZCFG100S□(R○○○) ZCFW100-R○○○	19,240	
	ARPF12S12	●	1	12 13*	110(110.6)	12	4.0	21(21.6)	30(30.6)	—	11.5	80	B	ZCFG120S□(R○○○) ZCFW120-R○○○ ZCFG130S□(R○○○)*	20,070	
	ARPF16S16	●	1	16 17*	130(130.6)	16	5.0	27(27.6)	50(50.6)	—	15	80	B	ZCFG160S□(R○○○) ZCFW160-R○○○ ZCFG170S□(R○○○)*	23,350	
	ARPF20S20	●	1	20 21*	140(141)	20	6.0	35(36)	60(61)	—	19	80	B	ZCFG200S□(R○○○) ZCFW200-R○○○ ZCFG210S□(R○○○)*	26,870	
	ARPF25S25	●	1	25 26*	150(151.8)	25	8.0	43(44.8)	70(71.8)	—	24	80	B	ZCFG250S□(R○○○) ZCFW250-R○○○ ZCFG260S□(R○○○)*	34,260	
	ARPF30S32	●	1	30	160(162.2)	32	10.0	55(57.2)	80(82.2)	—	29	80	B	ZCFG300S□(R○○○) ZCFW300-R○○○	41,060	
	ARPF32S32	●	1	32	160(162.2)	32	10.0	58(60.2)	80(82.2)	—	31	80	B	ZCFG320S□(R○○○) ZCFW320-R○○○	41,060	
Under neck long — アンダーネックロング	ARPF08S12L	●	1	8	130(130.2)	12	2.5	10(10.2)	50(50.2)	3°	7.5	80	A	ZCFG080S□(R○○○) ZCFW080-R○○○	22,180	
	ARPF10S16L	●	1	10	150(150.4)	16	3.0	13(13.4)	50(50.4)	4.5°	9.5	100	A	ZCFG100S□(R○○○) ZCFW100-R○○○	23,120	
	ARPF12S16L	●	1	12 13*	160(160.6)	16	4.0	21(21.6)	60(60.6)	2°	11.5	100	A	ZCFG120S□(R○○○) ZCFW120-R○○○ ZCFG130S□(R○○○)*	23,940	
	ARPF16S16L	●	1	16 17*	165(165.6)	16	5.0	27(27.6)	65(65.6)	—	15	100	B	ZCFG160S□(R○○○) ZCFW160-R○○○ ZCFG170S□(R○○○)*	28,040	
	ARPF20S20L	●	1		180(181)	20	6.0	35(36)	80(81)	—	19	100	B		32,260	
	ARPF20S20L120	●	1	20 21*	220(221)	20	6.0	35(36)	120(121)	—	19	100	B	ZCFG200S□(R○○○) ZCFW200-R○○○ ZCFG210S□(R○○○)*	32,260	
	ARPF20S20L150	●	1		250(251)	20	6.0	35(36)	150(151)	—	19	100	B		32,260	
	ARPF25S25L	●	1	25	200(201.8)	25	8.0	43(44.8)	90(91.8)	—	24	110	B	ZCFG250S□(R○○○) ZCFW250-R○○○	41,060	
	ARPF25S32L150	●	1	26*	250(251.8)	32	8.0	43(44.8)	150(151.8)	—	24	100	B	ZCFG260S□(R○○○)*	49,270	
	ARPF30S32L	●	1	30	220(222.2)	32	10.0	55(57.2)	100(102.2)	—	29	120	B		49,270	
Long shank — ロングシャフト	ARPF16S16E	●	1	16 17*	200(200.6)	16	5.0	27(27.6)	65(65.6)	—	15	135	B	ZCFG160S□(R○○○) ZCFW160-R○○○ ZCFG170S□(R○○○)*	28,040	
	ARPF20S20E	●	1	20 21*	250(251)	20	6.0	35(36)	80(81)	—	19	170	B	ZCFG200S□(R○○○) ZCFW200-R○○○ ZCFG210S□(R○○○)*	32,260	
	ARPF25S25E	●	1	25	300(301.8)	25	8.0	43(44.8)	90(91.8)	—	24	210	B	ZCFG250S□(R○○○) ZCFW250-R○○○	41,060	
	ARPF25S32E	●	1	25	300(301.8)	32	8.0	43(44.8)	100(101.8)	3.5°	24	200	A	ZCFG260S□(R○○○)*	42,700	
	ARPF30S32E	●	1	30	350(352.2)	32	10.0	55(57.2)	100(102.2)	—	29	250	B	ZCFG300S□(R○○○) ZCFW300-R○○○	49,270	
	ARPF30S42E	●	1	30	350(352.2)	42	10.0	55(57.2)	120(122.2)	5.3°	29	230	A		58,190	
	ARPF32S32E	●	1	32	350(352.2)	32	10.0	58(60.2)	100(102.2)	—	31	250	B	ZCFG320S□(R○○○) ZCFW320-R○○○	49,270	
	Carbide shank — カーバイドシャンク	ARPF06S06W	●	1	6	90	6	2.0	10.3	25	—	5.5	65	B	ZCFG06NS□(R○○○) ZCFW060-R○○○	34,960
		ARPF06S06WL65	●	1	6	120	6	2.0	10.3	65	—	5.5	55	B		35,910
		ARPF08S08WL	●	1	8	130(130.2)	8	2.5	65(65.2)	65(65.2)	—	7.5	65	B	ZCFG080S□(R○○○) ZCFW080-R○○○	45,290
ARPF10S10WL		●	1	10	140(140.4)	10	3.0	18(18.4)	75(75.4)	—	9.5	65	B	ZCFG100S□(R○○○) ZCFW100-R○○○	49,510	
ARPF12S12WL		●	1	12 13*	150(150.6)	12	4.0	21(21.6)	85(85.6)	—	11.5	65	B	ZCFG120S□(R○○○) ZCFW120-R○○○ ZCFG130S□(R○○○)*	59,600	
ARPF16S16WE		●	1	16 17*	200(200.6)	16	5.0	27(27.6)	120(120.6)	—	15	80	B	ZCFG160S□(R○○○) ZCFW160-R○○○ ZCFG170S□(R○○○)*	82,240	
ARPF20S20WE		●	1	20 21*	250(251)	20	6.0	35(36)	150(151)	—	19	100	B	ZCFG200S□(R○○○) ZCFW200-R○○○ ZCFG210S□(R○○○)*	113,080	
ARPF25S25WE		●	1	25 26*	300(301.8)	25	8.0	43(44.8)	190(191.8)	—	24	110	B	ZCFG250S□(R○○○) ZCFW250-R○○○ ZCFG260S□(R○○○)*	170,090	
ARPF30S32WE		●	1	30	350(352.2)	32	10.0	55(57.2)	230(232.2)	—	29	120	B	ZCFG300S□(R○○○) ZCFW300-R○○○	267,450	
ARPF32S32WE		●	1	32	350(352.2)	32	10.0	58(60.2)	230(232.2)	—	31	120	B	ZCFG320S□(R○○○) ZCFW320-R○○○	267,450	

※φ13インサートはφ12ボディ、φ17インサートはφ16ボディ、φ21インサートはφ20ボディ、φ26インサートはφ25ボディに取付ける事ができます。
※A φ13 mm insert can be mounted on a φ12 mm body, a φ17 mm insert can be mounted on a φ16 mm body, a φ21 mm insert can be mounted on a φ20 mm body, or a φ26 mm insert can be mounted on a φ25 mm body.
【注意】()寸法は、ZCFGタイプのインサート取り付け時を示します。【Note】Dimensions in parentheses () are with ZCFG type inserts installed.

Indexable Tools
Radius End Mills

アルファラジアスプレジジョン ARPF

SG・SW・SQ タイプ (ねじれ刃形インサート) SG・SW・SQ type (helical cutting edge inserts)

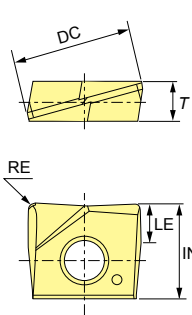
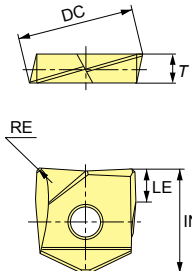
形状 Shape	商品コード Item code	精度 Tolerance class	THコーティング TH Coating		PNコーティング PN Coating		寸法 Size (mm)					形状 Shape	希望小売価格(円) Suggested retail price (¥)	
			TH308	PN215	DC	RE	LE	INSL	T	TH308 PN215				
P	鋼 Carbon steels		☐	■	■ : 一般切削・第一推奨 General cutting, First recommendation								Fig1	11,220
	K	FC・FCD Cast irons		■	☐	☐ : 一般切削・第二推奨 General cutting, Second recommendation								
N	アルミニウム合金 Aluminum alloys		☐	☐										
H	高硬度材 Hardened steels		■	■										
 <p>Fig.1</p>  <p>Fig.2</p>	ZCFG06NSG-R0.3	F級 F	●	●	6	0.3	2	5	2	Fig1	11,220			
	ZCFG06NSG-R0.5		●	●		0.5					11,220			
	ZCFG06NSG-R1.0		●	●		1.0					11,220			
	ZCFG080SG-R0.3		●	●	8	0.3	2.5	9.9	2.1	Fig1	9,350			
	ZCFG080SG-R0.5		●	●		0.5					9,350			
	ZCFG080SG-R1.0		●	●		1.0					9,350			
	ZCFG080SG-R1.5		●	●		1.5					9,350			
	ZCFG080SG-R2.0		●	●		2.0					9,350			
	* ZCFG100SG-R0.3		●	●	10	0.3	3	12.5	2.7	Fig1	9,930			
	* ZCFG100SG-R0.5		●	●		0.5					9,930			
	* ZCFG100SG-R1.0		●	●		1.0					9,930			
	* ZCFG100SG-R1.5		●	●		1.5					9,930			
	* ZCFG100SG-R2.0		●	●		2.0					9,930			
	* ZCFG120SG-R0.3		●	●	12	0.3	4	15.1	3.2	Fig1	10,500			
	* ZCFG120SG-R0.5		●	●		0.5					10,500			
	* ZCFG120SG-R1.0		●	●		1.0					10,500			
	* ZCFG120SG-R1.5		●	●		1.5					10,500			
	* ZCFG120SG-R2.0		●	●		2.0					10,500			
	* ZCFG130SG-R0.3		●	●	13	0.3	4	15.1	3.2	Fig1	10,590			
	* ZCFG130SG-R0.5		●	●		0.5					10,590			
	* ZCFG130SG-R1.0		●	●		1.0					10,590			
	* ZCFG130SG-R1.5		●	●		1.5					10,590			
	* ZCFG130SG-R2.0		●	●		2.0					10,590			
	* ZCFG160SG-R0.3		●	●	16	0.3	5	17.2	4.2	Fig2	10,850			
	* ZCFG160SG-R0.5		●	●		0.5					10,850			
	* ZCFG160SG-R1.0		●	●		1.0					10,850			
	* ZCFG160SG-R1.5		●	●		1.5					10,850			
	* ZCFG160SG-R2.0		●	●		2.0					10,850			
	* ZCFG170SG-R0.3		●	●	17	0.3	5	17.2	4.2	Fig2	11,000			
	* ZCFG170SG-R0.5		●	●		0.5					11,000			
	* ZCFG170SG-R1.0		●	●		1.0					11,000			
	* ZCFG170SG-R1.5		●	●		1.5					11,000			
	* ZCFG170SG-R2.0		●	●		2.0					11,000			
	* ZCFG200SG-R0.3		●	●	20	0.3	7	20.9	5.2	Fig2	11,460			
	* ZCFG200SG-R0.5		●	●		0.5					11,460			
	* ZCFG200SG-R1.0		●	●		1.0					11,460			
	* ZCFG200SG-R1.5		●	●		1.5					11,460			
	* ZCFG200SG-R2.0		●	●		2.0					11,460			
	* ZCFG210SG-R0.3		●	●	21	0.3	7	20.9	5.2	Fig2	11,790			
	* ZCFG210SG-R0.5		●	●		0.5					11,790			
	* ZCFG210SG-R1.0		●	●		1.0					11,790			
	* ZCFG210SG-R1.5		●	●		1.5					11,790			
	* ZCFG210SG-R2.0		●	●		2.0					11,790			
	* ZCFG250SG-R0.3		●	●	25	0.3	8	24.4	6.2	Fig2	13,250			
	* ZCFG250SG-R0.5		●	●		0.5					13,250			
	* ZCFG250SG-R1.0		●	●		1.0					13,250			
	* ZCFG250SG-R1.5		●	●		1.5					13,250			
	* ZCFG250SG-R2.0		●	●		2.0					13,250			
* ZCFG250SG-R3.0	●	●	3.0	13,250										
* ZCFG260SG-R0.3	●	●	26	0.3	8	24.4	6.2	Fig2	13,700					
* ZCFG260SG-R0.5	●	●		0.5					13,700					
* ZCFG260SG-R1.0	●	●		1.0					13,700					
* ZCFG260SG-R1.5	●	●		1.5					13,700					
* ZCFG260SG-R2.0	●	●		2.0					13,700					
* ZCFG260SG-R3.0	●	●	3.0	13,700										
* ZCFG300SG-R0.3	●	●	30	0.3	10	29.4	7.2	Fig2	15,600					
* ZCFG300SG-R0.5	●	●		0.5					15,600					
* ZCFG300SG-R1.0	●	●		1.0					15,600					
* ZCFG300SG-R1.5	●	●		1.5					15,600					
* ZCFG300SG-R2.0	●	●		2.0					15,600					
* ZCFG300SG-R3.0	●	●	3.0	15,600										
* ZCFG320SG-R0.3	●	●	32	0.3	10	30.4	7.2	Fig2	16,960					
* ZCFG320SG-R0.5	●	●		0.5					16,960					
* ZCFG320SG-R1.0	●	●		1.0					16,960					
* ZCFG320SG-R1.5	●	●		1.5					16,960					
* ZCFG320SG-R2.0	●	●		2.0					16,960					
* ZCFG320SG-R3.0	●	●	3.0	16,960										

刃先交換式工具
ラジアスエンドミル

●印：標準在庫品です。 ●： Stocked items.

P	鋼 Carbon steels	□	■								■：一般切削・第一推奨 General cutting, First recommendation							
K	FC・FCD Cast irons	■	□								□：一般切削・第二推奨 General cutting, Second recommendation							
N	アルミニウム合金 Aluminum alloys	□	□															
H	高硬度材 Hardened steels	■	□															
形状 Shape		商品コード Item code	精度 Tolerance class	THコーティング TH Coating	PNコーティング PN Coating	寸法 Size (mm)					形状 Shape	希望小売価格(円) Suggested retail price (¥)						
				TH308	PN215	DC	RE	LE	INSL	T		TH308 PN215						
<p>Fig.1</p>		ZCFG06NSW-R0.3	F級 F	●	●	6	0.3	2	5	2	Fig1	11,220						
		ZCFG06NSW-R0.5		●	●		0.5					11,220						
		ZCFG080SW-R0.3		●	●	8	0.3	2.5	9.9	2.1		9,350						
		ZCFG080SW-R0.5		●	●		0.5					9,350						
		ZCFG080SW-R1.0		●	●		1.0					9,350						
		<p>Fig.2</p>		* ZCFG100SW-R0.3	●	●	10	0.3	3	12.5		2.7	Fig2	9,930				
				* ZCFG100SW-R0.5	●	●		0.5						9,930				
				* ZCFG100SW-R1.0	●	●	1.0	9,930										
				* ZCFG120SW-R0.3	●	●	12	0.3	4	15.1		3.2		10,500				
				* ZCFG120SW-R0.5	●	●		0.5						10,500				
* ZCFG120SW-R1.0	●			●	1.0	10,500												
* ZCFG130SW-R0.3	●			●	13	0.3	4	15.1	3.2	10,590								
* ZCFG130SW-R0.5	●			●		0.5				10,590								
* ZCFG130SW-R1.0	●			●		1.0				10,590								
<p>Fig.3</p>				* ZCFG160SW-R0.3	●	●	16	0.3	5	17.2		4.2		Fig3	10,850			
		* ZCFG160SW-R0.5		●	●	0.5		10,850										
		* ZCFG160SW-R1.0		●	●	1.0	10,850											
		* ZCFG170SW-R0.3		●	●	17	0.3	5	17.2	4.2		11,000						
		* ZCFG170SW-R0.5		●	●		0.5					11,000						
		* ZCFG170SW-R1.0		●	●		1.0					11,000						
		<p>Fig.4</p>		* ZCFG200SW-R0.3	●	●	20	0.3	7	20.9		5.2			Fig4	11,460		
				* ZCFG200SW-R0.5	●	●		0.5								11,460		
				* ZCFG200SW-R1.0	●	●	1.0	11,460										
				* ZCFG210SW-R0.3	●	●	21	0.3	7	20.9		5.2				11,790		
* ZCFG210SW-R0.5	●			●	0.5	11,790												
* ZCFG210SW-R1.0	●			●	1.0	11,790												
<p>Fig.5</p>				* ZCFG250SW-R0.3	●	●	25	0.3	8	24.4		6.2				Fig5	13,250	
				* ZCFG250SW-R0.5	●	●		0.5									13,250	
				* ZCFG250SW-R1.0	●	●	1.0	13,250										
				* ZCFG260SW-R0.3	●	●	26	0.3	8	24.4		6.2					13,700	
		* ZCFG260SW-R0.5	●	●	0.5	13,700												
		* ZCFG260SW-R1.0	●	●	1.0	13,700												
		<p>Fig.6</p>		* ZCFG300SW-R0.3	●	●	30	0.3	10	29.4	7.2	Fig6					15,600	
				* ZCFG300SW-R0.5	●	●		0.5									15,600	
				* ZCFG300SW-R1.0	●	●	1.0	15,600										
				* ZCFG320SW-R0.3	●	●	32	0.3	10	30.4	7.2		16,960					
* ZCFG320SW-R0.5	●			●	0.5	16,960												
* ZCFG320SW-R1.0	●			●	1.0	16,960												

P	鋼 Carbon steels	■	□								■：一般切削・第一推奨 General cutting, First recommendation				
K	FC・FCD Cast irons	□	□								□：一般切削・第二推奨 General cutting, Second recommendation				
N	アルミニウム合金 Aluminum alloys	□	□												
H	高硬度材 Hardened steels	□	□												
形状 Shape		商品コード Item code	精度 Tolerance class	PNコーティング PN Coating	寸法 Size (mm)					形状 Shape	希望小売価格(円) Suggested retail price (¥)				
				PN215	DC	LE	INSL	T			PN215				
<p>Fig.3</p>		ZCFG080SQ	F級 F	●	8	2.5	9.9	2.1	2.1	Fig3	9,350				
		* ZCFG100SQ		●							10	3	12.5	2.7	9,930
		* ZCFG120SQ		●							12	4	15.1	3.2	10,500
		* ZCFG130SQ		●							13	4	15.1	3.2	10,590
		* ZCFG160SQ		●							16	5	17.2	4.2	10,850
		* ZCFG170SQ		●							17	5	17.2	4.2	11,000
		* ZCFG200SQ		●							20	7	20.9	5.2	11,460
		* ZCFG210SQ		●							21	7	20.9	5.2	11,790
		* ZCFG250SQ		●							25	8	24.4	6.2	13,250
		* ZCFG260SQ		●							26	8	24.4	6.2	13,700

【注意】SG、SW、SQタイプのインサートは、アルファボールプレシジョンF「ABPF形」ポデーに取り付け可能です。
 SG、SW、SQタイプのインサート(φ8~φ32)は、A寸法が従来品に対して長い設計になっております。ポデーにセットした場合の寸法にご注意下さい。
 【Note】Inserts of SG, SW, SQ type can be installed on Ball Precision F "ABPF" type bodies.
 Inserts(φ8~φ32) of SG, SW, SQ type have a design with a longer A dimension than conventional products. Be careful of the dimension when installed on body.

*印：φ10以上のインサートは再研磨が可能です。φ16以上では最大2回まで再研磨が可能です。 * mark: Re-grinding is applicable with insert φ10 or above. Insert φ16 or above may be re-ground up to twice.

インサートの再研磨&再コーティングも承っております。詳しくは弊社営業所までお問い合わせください。 Please inquire insert re-grinding / re-coating to sales office.

Indexable Tools
Radius End Mills

ねじれ刃形インサートの選択方法 How to select helical cutting edge inserts

<p>SGタイプ SG type</p> <p>高能率加工 High-efficiency machining. 用途：中仕上げから仕上げ Application : semi-finishing to finishing</p>  <p>刃先部拡大 Magnified view of cutting edge</p> <p>平面、傾斜面を含む3次元形状の加工に適します。 Suitable for machining of 3-dimensional shapes including flat surfaces and sloped surfaces.</p> 	<p>SWタイプ SW type</p> <p>立壁高精度加工 High-accuracy machining of standing walls 用途：仕上げ Application : Finishing</p>  <p>刃先部拡大 Magnified view of cutting edge</p> <p>基準面となる垂直側面部(立壁部)の高精度仕上げ加工に適します。 Suitable for high-accuracy finishing of vertical side surfaces (standing walls) which will be used as reference surfaces.</p> 	<p>SQタイプ SQ type</p> <p>用途：隅R除去加工 Application : Corner R removal</p>  <p>刃先部拡大 Magnified view of cutting edge</p> <p>ラジアス工具で加工した後に残る隅R部の除去加工に適します。 Suitable for removing remaining corner R areas after machining with radius tools.</p> 
--	---	--

シャンク+1mm刃径インサートの取り付け Mounting inserts with diameter of shank diameter +1mm

- φ13インサートはφ12ボディ、φ17インサートはφ16ボディ、φ21インサートはφ20ボディ、φ26インサートはφ25ボディに取付ける事ができます。
 * A φ13 mm insert can be mounted on a φ12 mm body, a φ17 mm insert can be mounted on a φ16 mm body, a φ21 mm insert can be mounted on a φ20 mm body, or a φ26 mm insert can be mounted on a φ25 mm body.

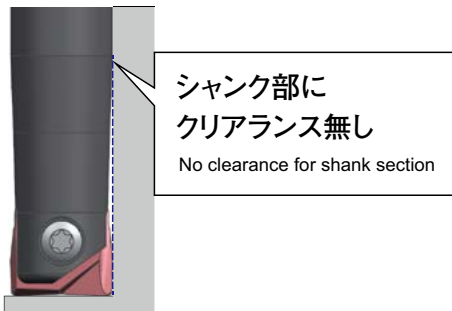

シャンク径同一インサート装着時
When insert with same diameter as shank is mounted



シャンク+1mm径インサート装着時
When insert with diameter +1mm larger than shank diameter is mounted.

インサート取付け手順 Set-up procedures of inserts

- 1 **インサート座面の清掃**
エアブローなどで、インサート座面を清掃ください。
Clean the insert seat:
Using air-blow or alike, clean the seat.
- 2 **インサートは、上面を工具本体のねじ締め付け側に合わせ、挿入する。**
Put in the insert with its top positioned to the screw-tightening side of the tool body.
- 3 **専用レンチにてクランプねじを締め付ける。**
この時インサートは押さえつけないでください。
Tighten the clamp screw with the special wrench.
Please do not press down the insert during this tightening process.
- 4 **締め付け完了。**
This is the end of insert set-up.

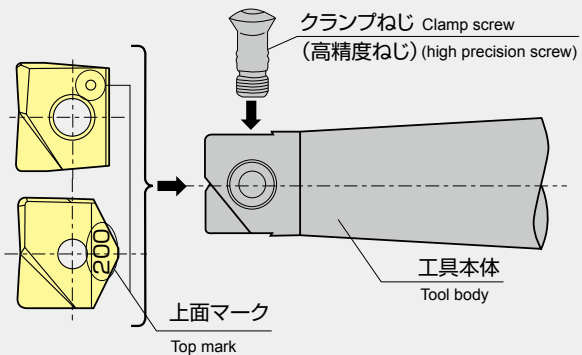

取り付け振れ精度0.02mm以下を満足するため、上記手順に従ってください。
In order to satisfy runout of 0.02mm or less, follow the procedure at above.

ご注意 Attention

インサートを入れない状態でのクランプねじ締結は、ホルダー本体の変形に繋がる恐れがあり、インサートの取り付け不良や取付精度の劣化につながる可能性があるため決して行わないでください。
Never tighten the clamp screw without putting the insert. The tool body may be deformed, resulting in improper insert mounting or deterioration of mounting accuracy.



インサート未挿入での空締め禁止
Do not tighten the screw without putting insert

一般刃形インサート General cutting edge shape inserts

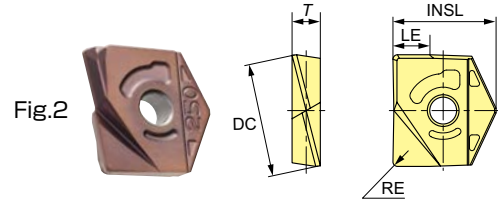
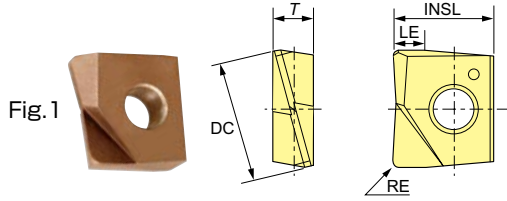

商品コード Item code	精度 Tolerance class	Cコーティング C Coating				THコーティング TH Coating				HDコーティング HD Coating				CBN				寸法 Size (mm)					形状 Shape	希望小売価格(円) Suggested retail price (¥)				
		PCA12M	PTH08M	HD7010	BH250	PCA12M	PTH08M	HD7010	BH250	PCA12M	PTH08M	HD7010	BH250	PCA12M	PTH08M	HD7010	BH250	DC	RE	LE	INSL	T		PCA12M	PTH08M	HD7010	BH250	
ZCFW060-R0.3	F級 F		●	●※	—					6	0.3											Fig.1	—	11,220	56,100			
ZCFW060-R0.5			●	●	—					6	0.5	2	5.0	2.0									Fig.1	—	11,220	—		
ZCFW060-R1.0				●	—							1.0											Fig.1	—	11,220	—		
ZCFW080-R0.3			●	●	●※	—				8	0.3												Fig.1	7,790	9,350	46,690		
ZCFW080-R0.5			●	●	●	—				8	0.5	2.5	9.7	2.1									Fig.1	7,790	9,350	—		
ZCFW080-R1.0			●	●	—	—						1.0											Fig.1	7,790	9,350	—		
※ ZCFW100-R0.3			●	●	●※	—				10	0.3												Fig.2	8,280	9,930	49,600		
※ ZCFW100-R0.5			●	●	—	—					0.5													Fig.2	8,280	9,930	—	
※ ZCFW100-R1.0			●	●	—	—					1.0	3	12.0	2.7											Fig.2	8,280	9,930	—
※ ZCFW100-R1.5			●	●	—	—					1.5															Fig.2	8,280	9,930
※ ZCFW100-R2.0			●	●	—	—				2.0												Fig.2	8,280				9,930	—
※ ZCFW100-R3.0			●	●	—	—				3.0	4												Fig.2	8,280			9,930	—
※ ZCFW120-R0.3			●	●	●※	—				12	0.3													Fig.2	8,750		10,500	52,410
※ ZCFW120-R0.5			●	●	—	—					0.5															Fig.2	8,750	10,500
※ ZCFW120-R1.0			●	●	—	—					1.0														Fig.2		8,750	10,500
※ ZCFW120-R1.5			●	●	—	—					1.5	4	14.6	3.2									Fig.2				8,750	10,500
※ ZCFW120-R2.0			●	●	—	—				2.0												Fig.2		8,750			10,500	—
※ ZCFW120-R3.0			●	●	—	—				3.0														Fig.2		8,750	10,500	—
※ ZCFW160-R0.3			●	●	●※	—				16	0.3														Fig.2	9,050	10,850	54,200
※ ZCFW160-R0.5			●	●	—	—					0.5															Fig.2	9,050	10,850
※ ZCFW160-R1.0			●	●	—	●					1.0												Fig.2				9,050	10,850
※ ZCFW160-R1.5			●	●	—	●					1.5	5	16.6	4.2										Fig.2			9,050	10,850
※ ZCFW160-R2.0			●	●	—	●				2.0												Fig.2			9,050		10,850	93,810
※ ZCFW160-R3.0			●	●	—	—				3.0															Fig.2	9,050	10,850	—
※ ZCFW200-R0.3			●	●	●※	—				20	0.3												Fig.2			9,510	11,460	57,010
※ ZCFW200-R0.5			●	●	—	—					0.5															Fig.2	9,510	11,460
※ ZCFW200-R1.0			●	●	—	●					1.0													Fig.2			9,510	11,460
※ ZCFW200-R1.5			●	●	—	●					1.5	6	19.9	5.2											Fig.2		9,510	11,460
※ ZCFW200-R2.0			●	●	—	●				2.0												Fig.2	9,510				11,460	99,190
※ ZCFW200-R3.0			●	●	—	—				3.0													Fig.2			9,510	11,460	—
※ ZCFW250-R0.3			●	●	—	—				25	0.3													Fig.2		11,030	13,250	—
※ ZCFW250-R0.5			●	●	—	—					0.5															Fig.2	11,030	13,250
※ ZCFW250-R1.0		●	●	—	●				1.0													Fig.2			11,030		13,250	101,670
※ ZCFW250-R2.0		●	●	—	●				2.0		8	22.6	6.2										Fig.2		11,030		13,250	101,670
※ ZCFW250-R3.0		●	●	—	—				3.0												Fig.2			11,030	13,250		—	
※ ZCFW300-R0.3		●	●	—	—				30	0.3														Fig.2	13,030	15,600	—	
※ ZCFW300-R0.5		●	●	—	—					0.5															Fig.2	13,030	15,600	—
※ ZCFW300-R1.0		●	●	—	●					1.0	10	27.2	7.2										Fig.2			13,030	15,600	115,570
※ ZCFW300-R2.0		●	●	—	●					2.0												Fig.2				13,030	15,600	115,570
※ ZCFW300-R3.0		●	●	—	—				3.0												Fig.2			13,030		15,600	—	
※ ZCFW320-R0.3		●	●	—	—				32	0.3														Fig.2	14,030	16,960	—	
※ ZCFW320-R0.5		●	●	—	—					0.5															Fig.2	14,030	16,960	—
※ ZCFW320-R1.0		●	●	—	—					1.0	10	28.2	7.2										Fig.2			14,030	16,960	—
※ ZCFW320-R2.0		●	●	—	—					2.0												Fig.2				14,030	16,960	—
※ ZCFW320-R3.0		●	●	—	—				3.0												Fig.2			14,030		16,960	—	

※印：HD7010は再研磨不可です。 ※印：HD7010以外のφ10以上のインサートは再研磨が可能です。φ16以上では最大2回まで再研磨が可能です。
 ※mark: HD7010 insert cannot be reground. ※mark: Inserts with diameters of φ10 or more except HD7010 can be reground. Insert φ16 or above may be re-ground up to twice.

インサートの再研磨&再コーティングも承っております。詳しくは弊社営業所までお問い合わせください。
Please inquire insert re-grinding / re-coating to sales office.

●印：標準在庫品です。 無印：弊社営業へお問合せください。 —印：製作致しません。
 ● : Stocked items. No mark : Contact with our sales department. — : Not Manufactured.

標準切削条件表 Recommended cutting conditions

※赤字は第一推奨材種です Red indicates primary recommended insert grade.

被削材 Work material	インサート材種 Insert grade		切削条件 Cutting conditions	φ6			φ8			φ10			φ12		
	SG-SW (ねじれ刃形) (helical cutting edge inserts)	一般刃形 General edge shape		中仕上げ Semi finishing		仕上げ Finishing	中仕上げ Semi finishing		仕上げ Finishing	中仕上げ Semi finishing		仕上げ Finishing	中仕上げ Semi finishing		仕上げ Finishing
				汎用 General purpose	高速加工 High-speed processing		汎用 General purpose	高速加工 High-speed processing		汎用 General purpose	高速加工 High-speed processing		汎用 General purpose	高速加工 High-speed processing	
炭素鋼 合金鋼 Carbon steels Alloy steels (30HRC以下) (30HRC or less)	※ PN215 TH308	PTH08M (PCA12M)	n (min ⁻¹)	8,490	16,450	16,450	6,370	11,940	11,940	5,090	9,550	9,550	4,240	7,960	7,960
			V_c (m/min)	160	310	310	160	300	300	160	300	300	160	300	300
			V_f (mm/min)	1,700	2,300	2,300	2,550	3,580	3,580	2,040	2,870	2,870	1,700	2,390	2,390
			f_z (mm/t)	0.1	0.07	0.07	0.2	0.15	0.15	0.2	0.15	0.15	0.2	0.15	0.15
			a_p (mm)	0.1	0.1	0.05	0.2	0.2	0.1	0.25	0.25	0.1	0.3	0.3	0.1
			a_e (mm)	0.6	0.3	0.2	0.8	0.4	0.2	1	0.5	0.2	1.2	0.6	0.2
炭素鋼 合金鋼 Carbon steels Alloy steels (30~45HRC)	TH308 PN215	PTH08M (PCA12M)	n (min ⁻¹)	6,370	14,850	14,850	4,770	11,150	11,150	3,820	8,920	8,920	3,180	7,430	7,430
			V_c (m/min)	120	280	280	120	280	280	120	280	280	120	280	280
			V_f (mm/min)	1,270	2,080	2,080	1,910	3,350	3,350	1,530	2,680	2,680	1,270	2,230	2,230
			f_z (mm/t)	0.1	0.07	0.07	0.2	0.15	0.15	0.2	0.15	0.15	0.2	0.15	0.15
			a_p (mm)	0.1	0.1	0.05	0.2	0.2	0.1	0.25	0.25	0.1	0.3	0.3	0.1
			a_e (mm)	0.6	0.3	0.2	0.8	0.4	0.2	1	0.5	0.2	1.2	0.6	0.2
鋳鉄 Cast irons	TH308 PN215	PTH08M (PCA12M)	n (min ⁻¹)	8,490	20,160	20,160	6,370	15,120	15,120	5,090	12,100	12,100	4,240	10,080	10,080
			V_c (m/min)	160	380	380	160	380	380	160	380	380	160	380	380
			V_f (mm/min)	2,550	4,030	4,030	3,820	6,050	6,050	3,050	4,840	4,840	2,550	4,030	4,030
			f_z (mm/t)	0.15	0.1	0.1	0.3	0.2	0.2	0.3	0.2	0.2	0.3	0.2	0.2
			a_p (mm)	0.1	0.1	0.05	0.2	0.2	0.1	0.25	0.2	0.1	0.3	0.3	0.1
			a_e (mm)	0.6	0.3	0.2	0.8	0.4	0.2	1	0.4	0.2	1.2	0.6	0.2
グラファイト Graphite	HD7010		n (min ⁻¹)	15,920	21,220	21,220	11,940	15,920	15,920	9,550	12,740	12,740	7,960	10,620	10,620
			V_c (m/min)	300	400	400	300	400	400	300	400	400	300	400	400
			V_f (mm/min)	3,180	6,370	4,240	4,780	9,550	6,370	3,820	7,640	5,100	3,190	6,370	4,240
			f_z (mm/t)	0.1	0.15	0.1	0.2	0.3	0.2	0.2	0.3	0.2	0.2	0.3	0.2
			a_p (mm)	0.3	0.15	0.15	0.4	0.2	0.2	0.5	0.3	0.2	0.6	0.4	0.2
			a_e (mm)	0.6	0.6	0.2	0.8	0.8	0.25	1	0.8	0.25	1.2	0.9	0.3
アルミニウム 合金鋳物 Cast aluminum alloys AC4A, ADC12等 etc	PN215	HD7010	n (min ⁻¹)	15,920	26,530	26,530	11,940	19,900	19,900	9,550	15,920	15,920	7,960	13,270	13,270
			V_c (m/min)	300	500	500	300	500	500	300	500	500	300	500	500
			V_f (mm/min)	3,180	10,610	5,310	4,780	15,920	7,960	3,820	12,740	6,370	3,190	10,620	5,310
			f_z (mm/t)	0.1	0.2	0.1	0.2	0.4	0.2	0.2	0.4	0.2	0.2	0.4	0.2
			a_p (mm)	0.3	0.15	0.15	0.4	0.2	0.2	0.5	0.3	0.2	0.6	0.4	0.2
			a_e (mm)	0.6	0.6	0.2	0.8	0.8	0.25	1	0.8	0.25	1.2	0.9	0.3
焼入れ鋼 Hardened steels 45~55HRC	TH308 PN215	PTH08M (PCA12M)	n (min ⁻¹)	5,310	14,850	14,850	3,980	11,150	11,150	3,180	8,920	8,920	2,650	7,430	7,430
			V_c (m/min)	100	280	280	100	280	280	100	280	280	100	280	280
			V_f (mm/min)	850	1,190	1,190	800	1,120	1,120	640	890	890	530	740	740
			f_z (mm/t)	0.08	0.04	0.04	0.1	0.05	0.05	0.1	0.05	0.05	0.1	0.05	0.05
			a_p (mm)	0.1	0.1	0.05	0.2	0.2	0.1	0.25	0.25	0.1	0.3	0.3	0.1
			a_e (mm)	0.6	0.2	0.2	0.8	0.2	0.2	1	0.25	0.2	1.2	0.3	0.2
焼入れ鋼 Hardened steels 55~62HRC	TH308	PTH08M	n (min ⁻¹)	4,240	11,670	11,670	3,180	8,760	8,760	2,550	7,000	7,000	2,120	5,840	5,840
			V_c (m/min)	80	220	220	80	220	220	80	220	220	80	220	220
			V_f (mm/min)	680	930	930	640	880	880	510	700	700	420	580	580
			f_z (mm/t)	0.08	0.04	0.04	0.1	0.05	0.05	0.1	0.05	0.05	0.1	0.05	0.05
			a_p (mm)	0.1	0.1	0.05	0.2	0.2	0.1	0.25	0.25	0.1	0.3	0.3	0.1
			a_e (mm)	0.6	0.2	0.2	0.8	0.2	0.2	1	0.25	0.2	1.2	0.3	0.2
最大 Maximum f_z (mm/t)				<0.2			<0.5			<0.5			<0.5		
最大 Maximum a_p (mm)				<0.6			<2.5			<3.0			<4.0		

- [注意]** (1)被削材、加工形状に合わせて、適切なクーラントを使用してください。
 (2)この切削条件表は切削条件の目安を示すものです。実際の加工では加工形状、目的、使用機械等により条件を調整してください。
 (3)この工具をご使用の際は、破損する危険性がありますので、必ずカバー・保護めがね・安全靴等をご使用してください。
 (4)超硬シャンクホルダには手を加えないでください。また、超硬シャンクホルダ使用時の切り込み量 a_p は、下記値にてご使用ください。
 工具径DC12以下は、 $a_p=0.2$ mm以下。工具径DC16以上は、 $a_p=0.3$ mm以下。

- [Note]** 1. Use the appropriate coolant for the work material and machining shape.
 2. These conditions are for general guidance; in actual machining conditions adjust the parameters according to your actual machine and work-piece conditions.
 3. Be sure to practice safety instructions and precautions such as wearing glasses and safety shoes, and placing safety covers when you use this tool. Because this tool can be broken during machining so failure to follow these instructions may cause personal injury.
 4. Never attempt to modify the carbide shank holder. Use the value for the depth of cut (a_p) when the carbide shank holder is used.
 Tool dia. DC ≤ 12mm: $a_p \leq 0.2$ mm. Tool dia. DC ≥ 16mm: $a_p \leq 0.3$ mm.

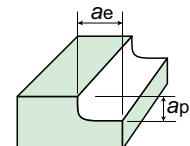

※赤字は第一推奨材種です Red indicates primary recommended insert grade.

被削材 Work material	インサート材種 Insert grade		切削条件 Cutting conditions	φ16			φ20			φ25			φ30			φ32		
	SG・SW (ねじれ刃形) General edge shape	一般刃形 General edge shape		中仕上げ Semi finishing		仕上げ Finishing	中仕上げ Semi finishing		仕上げ Finishing	中仕上げ Semi finishing		仕上げ Finishing	中仕上げ Semi finishing		仕上げ Finishing	中仕上げ Semi finishing		仕上げ Finishing
				汎用 General purpose	高速加工 High-speed processing		汎用 General purpose	高速加工 High-speed processing		汎用 General purpose	高速加工 High-speed processing		汎用 General purpose	高速加工 High-speed processing		汎用 General purpose	高速加工 High-speed processing	
炭素鋼 合金鋼 Carbon steels Alloy steels (30HRC以下) (30HRC or less)	※ PN215 TH308	PTH08M (PCA12M)	n (min ⁻¹)	3,190	5,970	5,970	2,550	4,780	4,780	2,040	3,820	3,820	1,700	3,180	3,180	1,590	2,990	2,990
			Vc (m/min)	160	300	300	160	300	300	160	300	300	160	300	300	160	300	300
			Vf (mm/min)	1,600	2,390	2,390	1,280	1,910	1,910	1,020	1,530	1,530	850	1,270	1,270	800	1,200	1,200
			fz (mm/t)	0.25	0.2	0.2	0.25	0.2	0.2	0.25	0.2	0.2	0.25	0.2	0.2	0.25	0.2	0.2
			ap (mm)	0.8	0.8	0.2	1	1	0.2	1.25	1.25	0.2	1.6	1.6	0.2	1.6	1.6	0.2
			ae (mm)	1.6	1.6	0.2	2	2	0.2	2.5	1.25	0.2	3.2	3.2	0.2	3.2	3.2	0.2
炭素鋼 合金鋼 Carbon steels Alloy steels (30~45HRC)	TH308 PN215	PTH08M (PCA12M)	n (min ⁻¹)	2,390	5,570	5,570	1,910	4,460	4,460	1,530	3,570	3,570	1,270	2,970	2,970	1,190	2,790	2,790
			Vc (m/min)	120	280	280	120	280	280	120	280	280	120	280	280	120	280	280
			Vf (mm/min)	1,200	2,230	2,230	960	1,780	1,780	760	1,430	1,430	640	1,190	1,190	600	1,120	1,120
			fz (mm/t)	0.25	0.2	0.2	0.25	0.2	0.2	0.25	0.2	0.2	0.25	0.2	0.2	0.25	0.2	0.2
			ap (mm)	0.8	0.8	0.2	1	1	0.2	1.25	1.25	0.2	1.6	1.6	0.2	1.6	1.6	0.2
			ae (mm)	1.6	1.6	0.2	2	2	0.2	2.5	2.5	0.2	3.2	3.2	0.2	3.2	3.2	0.2
鋳鉄 Cast irons	TH308 PN215	PTH08M (PCA12M)	n (min ⁻¹)	3,190	7,560	7,560	2,550	6,050	6,050	2,040	4,840	4,840	1,700	4,030	4,030	1,590	3,780	3,780
			Vc (m/min)	160	380	380	160	380	380	160	380	380	160	380	380	160	380	380
			Vf (mm/min)	2,240	4,540	4,540	1,790	3,630	3,630	1,430	2,900	2,900	1,190	2,420	2,420	1,110	2,270	2,270
			fz (mm/t)	0.35	0.3	0.3	0.35	0.3	0.3	0.35	0.3	0.3	0.35	0.3	0.3	0.35	0.3	0.3
			ap (mm)	0.8	0.8	0.2	1	1	0.2	1.25	1.25	0.2	1.6	1.6	0.2	1.6	1.6	0.2
			ae (mm)	1.6	1.6	0.2	2	2	0.2	2.5	2.5	0.2	3.2	3.2	0.2	3.2	3.2	0.2
グラファイト Graphite	HD7010	HD7010	n (min ⁻¹)	5,970	7,960	7,960	4,780	6,370	6,370	3,830	5,100	5,100	3,190	4,250	4,250	3,190	3,980	3,980
			Vc (m/min)	300	400	400	300	400	400	300	400	400	300	400	400	300	400	400
			Vf (mm/min)	2,990	4,780	3,980	2,390	3,820	3,190	1,920	3,060	2,550	1,600	2,550	2,130	1,600	2,390	1,990
			fz (mm/t)	0.25	0.3	0.25	0.25	0.3	0.25	0.25	0.3	0.25	0.25	0.3	0.25	0.25	0.3	0.25
			ap (mm)	0.8	0.6	0.2	1	0.7	0.2	1.25	1.25	0.2	1.6	1.6	0.2	1.6	1.6	0.2
			ae (mm)	1.6	1.1	0.3	2	1.5	0.4	2.5	2.5	0.4	3.2	3.2	0.4	3.2	3.2	0.4
アルミニウム 合金鋳物 Cast aluminum alloys AC4A, ADC12等 etc	PN215	HD7010	n (min ⁻¹)	5,970	9,950	9,950	4,780	7,960	7,960	3,830	6,370	6,370	3,190	5,310	5,310	3,190	4,980	4,980
			Vc (m/min)	300	500	500	300	500	500	300	500	500	300	500	500	300	500	500
			Vf (mm/min)	2,990	7,960	4,980	2,390	6,370	3,980	1,920	5,100	3,190	1,600	4,250	2,660	1,600	3,980	2,490
			fz (mm/t)	0.25	0.4	0.25	0.25	0.4	0.25	0.25	0.4	0.25	0.25	0.4	0.25	0.25	0.4	0.25
			ap (mm)	0.8	0.6	0.2	1	0.7	0.2	1.25	1.25	0.2	1.6	1.6	0.2	1.6	1.6	0.2
			ae (mm)	1.6	1.1	0.3	2	1.5	0.4	2.5	2.5	0.4	3.2	3.2	0.4	3.2	3.2	0.4
焼入れ鋼 Hardened steels 45~55HRC	TH308 PN215	PTH08M (PCA12M)	n (min ⁻¹)	1,990	5,570	5,570	1,590	4,460	4,460	1,270	3,570	3,570	1,060	2,970	2,970	1,000	2,790	2,790
			Vc (m/min)	100	280	280	100	280	280	100	280	280	100	280	280	100	280	280
			Vf (mm/min)	480	670	670	380	530	530	310	430	430	250	360	360	240	330	330
			fz (mm/t)	0.12	0.06	0.06	0.12	0.06	0.06	0.12	0.06	0.06	0.12	0.06	0.06	0.12	0.06	0.06
			ap (mm)	0.8	0.8	0.2	1	1	0.2	1.25	1.25	0.2	1.6	1.6	0.2	1.6	1.6	0.2
			ae (mm)	1.6	0.8	0.2	2	1	0.2	2.5	1.25	0.2	3.2	1.6	0.2	3.2	1.6	0.2
焼入れ鋼 Hardened steels 55~62HRC	TH308	PTH08M	n (min ⁻¹)	1,590	4,380	4,380	1,270	3,500	3,500	1,020	2,800	2,800	850	2,330	2,330	800	2,190	2,190
			Vc (m/min)	80	220	220	80	220	220	80	220	220	80	220	220	80	220	220
			Vf (mm/min)	380	530	530	300	420	420	240	340	340	200	280	280	190	260	260
			fz (mm/t)	0.12	0.06	0.06	0.12	0.06	0.06	0.12	0.06	0.06	0.12	0.06	0.06	0.12	0.06	0.06
			ap (mm)	0.8	0.8	0.2	1	1	0.2	1.25	1.25	0.2	1.6	1.6	0.2	1.6	1.6	0.2
			ae (mm)	1.6	0.8	0.2	2	1	0.2	2.5	1.25	0.2	3.2	1.6	0.2	3.2	1.6	0.2
最大 Maximum fz (mm/t)				<0.6			<0.6			<0.6			<0.6			<0.6		
最大 Maximum ap (mm)				<5.0			<6.0			<8.0			<10.0			<10.0		

※突き出し長3DC以上の場合は、
上記の表をもとに右記表を参考に
調整してください。

※If overhang length is 3DC or more,
make adjustments to the table above
according to the table at right.

突き出し量 Overhang	Vc (m/min)	Vf (mm/min)
<3DC	100%	100%
3DC~5DC	70%	70%
5DC~8DC	60%	60%
8DC~10DC	50%	50%



●独自のインサート取付機構とねじれ切れ刃で更なる高能率加工を実現します。
 ・Unique insert mounting mechanism and helical cutting edge for greater cutting efficiency

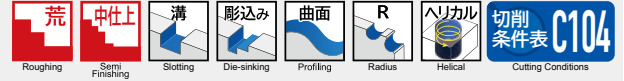

BR2P ○○○○-○○○-○○○ シャンクタイプ Shank type

○は数字、□は英文字が入ります。
 Numeric figure in a circle ○ and Alphabetical character comes in a square □

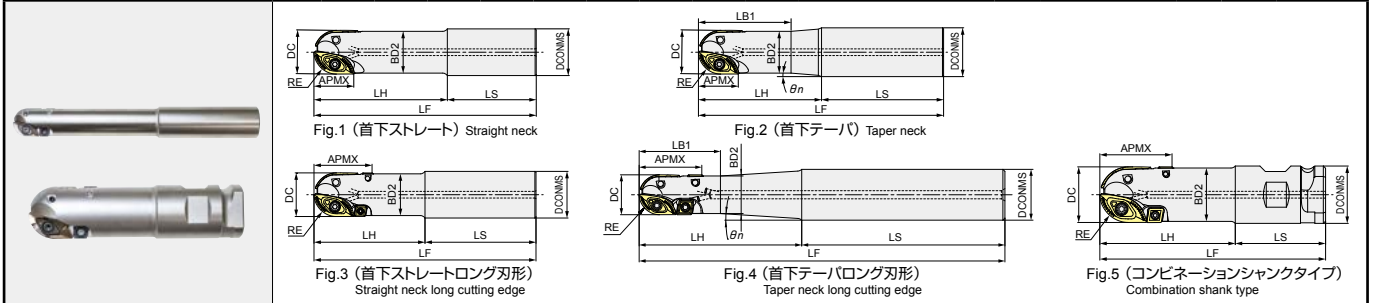

商品コード Item code	在庫 Stock	寸法 Size (mm)											適用インサート Insert				形状 Shape	希望小売 価格(円) Suggested retail price (¥)
		DC	RE	LF	DCONMS	BD2	APMX	LH	LB1	θ_n	LS	R 刃 R insert		外周刃 Peripheral insert				
												商品コード Item code	刃数 No. of flutes	商品コード Item code	刃数 No. of flutes			
BR2P16S16-130-50	●	16	8	130	16	14.8	15	50	-	-	80	ZPET080R	2	-	-	Fig.1	36,280	
BR2P16S20-130-50	●	16	8	130	20	14.8	15	50	27	4.23	80	ZPET080R	2	-	-	Fig.2	36,990	
BR2P20S20-130-50	●	20	10	130	20	18.5	18	50	-	-	80	ZPET100R	2	-	-	Fig.1	39,120	
BR2P20S25-140-60	●	20	10	140	25	18.5	18	60	40	6.14	80	ZPET100R	2	-	-	Fig.2	41,320	
BR2P25S25-140-60	●	25	12.5	140	25	23.3	22	60	-	-	80	ZPET125R	2	-	-	Fig.1	43,470	
BR2P25S32-150-70	●	25	12.5	150	32	23.3	22	70	50	8.41	80	ZPET125R	2	-	-	Fig.2	44,060	
BR2P30S32-160-80	●	30	15	160	32	28	27	80	60	3.4	80	ZPET150R	2	-	-	Fig.2	48,090	
BR2P30S32-200-120	●	30	15	200	32	28	27	120	60	1.13	80	ZPET150R	2	-	-	Fig.2	54,420	
BR2P32S32-160-80	●	32	16	160	32	30	28	80	-	-	80	ZPET160R	2	-	-	Fig.1	48,880	
BR2P40S42-200-120	●	40	20	200	42	37.6	35	120	-	-	80	ZPET200R	2	-	-	Fig.1	63,770	
BR2P2030S20-160-80	●	20	10	160	20	18.5	30	80	-	-	80	ZPET100R	2	CPMT070304	2	Fig.3	47,200	
BR2P2030S20-220-120	●	20	10	220	20	18.5	30	120	-	-	100	ZPET100R	2	CPMT070304	2	Fig.3	58,610	
BR2P2030S20-250-150	●	20	10	250	20	18.5	30	150	-	-	100	ZPET100R	2	CPMT070304	2	Fig.4	65,240	
BR2P2030S25-180-80	●	20	10	180	25	18.5	30	80	40	3.61	100	ZPET100R	2	CPMT070304	2	Fig.4	47,990	
BR2P2535S25-160-80	●	25	12.5	160	25	23.3	35	80	-	-	80	ZPET125R	2	CPMT070304	2	Fig.3	48,020	
BR2P2535S25-200-100	●	25	12.5	200	25	23.3	35	100	-	-	100	ZPET125R	2	CPMT070304	2	Fig.3	52,920	
BR2P2535S25-250-150	●	25	12.5	250	25	23.3	35	150	-	-	100	ZPET125R	2	CPMT070304	2	Fig.3	63,530	
BR2P2535S32-200-100	●	25	12.5	200	32	23.3	35	100	-	-	100	ZPET125R	2	CPMT070304	2	Fig.3	56,700	
BR2P2535S32-250-150	●	25	12.5	250	32	23.3	35	150	-	-	100	ZPET125R	2	CPMT070304	2	Fig.3	67,990	
BR2P3043S32-200-100	●	30	15	200	32	28	43	100	-	-	100	ZPET150R	2	CPMT090308	2	Fig.3	58,160	
BR2P3043S32-250-150	●	30	15	250	32	28	43	150	-	-	100	ZPET150R	2	CPMT090308	2	Fig.3	69,460	
BR2P3043S32-260-180	●	30	15	260	32	28	43	180	-	-	80	ZPET150R	2	CPMT090308	2	Fig.3	69,810	
BR2P4050S42-200-100	●	40	20	200	42	37.6	50	100	-	-	100	ZPET200R	2	CPMT090308	2	Fig.3	69,120	
BR2P4050S42-250-150	●	40	20	250	42	37.6	50	150	-	-	100	ZPET200R	2	CPMT090308	2	Fig.3	81,450	
BR2P5063C508-200-120	●	50	25	200	50.8	47.3	63	120	-	-	80	ZPET250R	2	CPMT120408	2	Fig.5	81,100	
BR2P5063C508-250-170	●	50	25	250	50.8	47.3	63	170	-	-	80	ZPET250R	2	CPMT120408	2	Fig.5	94,620	

○は数字、□は英文字が入ります。Numeric figure in a circle ○ and Alphabetical character comes in a square □

BR2PM ○○-M ○○ モジュラータイプ Modular type

モジュラーミル用シャンクはD2頁を、締め付けトルクについてはD5頁を参照ください。
 Refer page D2 about the shanks for Modular Mill, Refer page D5 about tightening torque

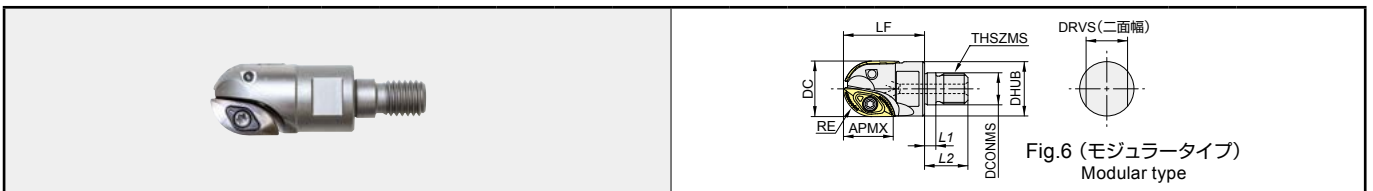

商品コード Item code	在庫 Stock	寸法 Size (mm)											適用インサート Insert		形状 Shape	希望小売 価格(円) Suggested retail price (¥)
		DC	RE	APMX	LF	DCONMS	THSZMS	DHUB	L1	L2	DRVS	R 刃 R insert				
												商品コード Item code	刃数 No. of flutes			
BR2PM16-M8	●	16	8	15	32	8.5	M8	12.8	5.5	17	10	ZPET080R	2	Fig.6	36,280	
BR2PM20-M10	●	20	10	18	38	10.5	M10	17.8	5.5	19	15	ZPET100R	2		36,990	
BR2PM25-M12	●	25	12.5	22	38	12.5	M12	20.8	5.5	22	17	ZPET125R	2		39,120	
BR2PM30-M16	●	30	15	27	43	17	M16	28.8	6	23	22	ZPET150R	2		41,320	
BR2PM32-M16	●	32	16	28	43	17	M16	28.8	6	23	22	ZPET160R	2		41,270	

【注意】モジュラーミル専用シャンク/アーバとの接続端面及びねじ部に潤滑剤は塗布しないでください。

【Note】Do not apply lubricants to the threaded section or end surface sections in contact with the dedicated shank/arbor for modular mills.

●印：標準在庫品です。 ●：Stocked items. 無印：弊社営業へお問合せください。 No mark：Contact with our sales department.

BR2P○○○○MT5-○○○○-M○○○ MTシャンクタイプ MT shank type

○は数字、□は英文字が入ります。
Numeric figure in a circle ○ and Alphabetical character comes in a square □

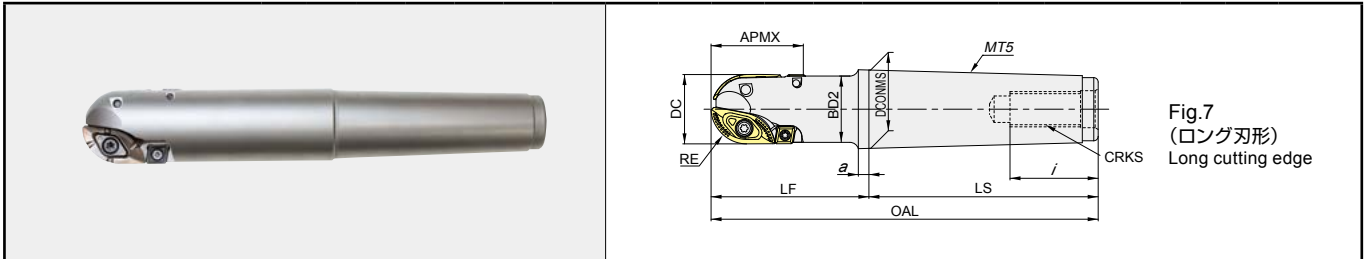

Fig.7
(ロング刃形)
Long cutting edge

商品コード Item code	在庫 Stock	寸法 Size (mm)											適用インサート Insert				形状 Shape	希望小売 価格(円) Suggested retail price (¥)		
		DC	RE	APMX	OAL	LF	LS	DCONMS	BD2	a	i	CRKS	R 刃 R insert		外周刃 Peripheral insert					
													商品コード Item code	刃数 No. of flutes	商品コード Item code	刃数 No. of flutes				
BR2P4050MT5-90-M20	●	40	20	50	219.5	90	129.5	44.399	37.6	6.5	50	M20	ZPET200R-□	2	CPMT090308	2	Fig.7	75,170		
BR2P4050MT5-120-M16		40	20	50	249.5	120												40	M16	—
BR2P4050MT5-120-M20	●	40	20	50	249.5	120												50	M20	80,210
BR2P4050MT5-170-M16		40	20	50	299.5	170												40	M16	—
BR2P4050MT5-170-M20	●	40	20	50	299.5	170												50	M20	84,210
BR2P5063MT5-100-M20	●	50	25	63	229.5	100												50	M20	96,040
BR2P5063MT5-120-M16		50	25	63	249.5	120							40	M16	—					
BR2P5063MT5-120-M20	●	50	25	63	249.5	120							50	M20	97,520					
BR2P5063MT5-120-M24		50	25	63	249.5	120							50	M24	—					
BR2P5063MT5-150-M20	●	50	25	63	279.5	150							50	M20	100,650					
BR2P5063MT5-170-M16		50	25	63	299.5	170							40	M16	—					
BR2P5063MT5-170-M20	●	50	25	63	299.5	170							50	M20	102,650					
BR2P5063MT5-170-M24		50	25	63	299.5	170	50	M24	—											

部品番号 Parts

部品名 Parts	クランプねじ Clamp screw						ドライバー/レンチ Screw driver/Wrench						ねじ焼き付き防止剤 Screw anti-seizure agent	
	R 刃 R insert	締付 トルク Fastening torque (N・m)	希望小売 価格(円) Suggested retail price (¥)	外周刃 Peripheral insert	締付 トルク Fastening torque (N・m)	希望小売 価格(円) Suggested retail price (¥)	R 刃 R insert	形状 Shape	希望小売 価格(円) Suggested retail price (¥)	外周刃 Peripheral insert	形状 Shape	希望小売 価格(円) Suggested retail price (¥)	希望小売 価格(円) Suggested retail price (¥)	
BR2P16S-○○-○○-○○-○○	P08-2507	1.1	1,110	—	—	106-8IP	A	2,500	—	—	—	P-37	1,010	
BR2PM16-M8				—	—				—					
BR2P20S-○○-○○-○○-○○	P10-3008	2.0	1,130	—	—	106-10IP	A	2,740	—	—	—			
BR2PM20-M10				—	—				—					
BR2P2030S-○○-○○-○○-○○	P15-4011	2.9	1,280	P10-3007	2.0	106-15IP	A	2,870	106-10IP	A	2,740			
BR2P25S-○○-○○-○○-○○				—	—				—					
BR2PM25-M12	P20-5013	4.9	1,280	—	—	105-20IP	B	4,890	—	—	—			
BR2P2535S-○○-○○-○○-○○				P10-3007	2.0				1,200	106-10IP				A
BR2P30S32-○○-○○-○○-○○	P25-6016	8.0	1,660	—	—	105-25IP	B	5,450	—	—	—			
BR2PM30-M16				—	—				—					
BR2P32S32-○○-○○-○○-○○	P30-6019	9.8	2,140	P15-4008	2.9	105-30IP	B	6,020	106-15IP	A	2,870			
BR2PM32-M16				—	—				—	—	—			
BR2P3043S32-○○-○○-○○-○○	P30-6019	9.8	2,140	—	—	105-30IP	B	6,020	106-15IP	A	2,870			
BR2P40S42-○○-○○-○○-○○				—	—				—	—	—			
BR2P4050S42-○○-○○-○○-○○	P30-6019	9.8	2,140	P15-4008	2.9	105-30IP	B	6,020	106-15IP	A	2,870			
BR2P4050MT5-○○-○○-○○-○○				—	—				—	—	—			
BR2P5063C508-○○-○○-○○-○○	P30-6019	9.8	2,140	P20-5011	4.9	105-30IP	B	6,020	105-20IP	B	4,890			
BR2P5063MT5-○○-○○-○○-○○				—	—				—	—	—			

[注意] クランプねじは消耗品です。使用環境により交換寿命は変化しますので早めの交換をお願い致します。R 刃用のクランプねじは予備が1本付属します。
[Note] The clamp screw is a consumable part. Since replacement life depends on the use environment, it is recommended that it be replaced at an early stage.
 One spare clamp screw is provided for the R insert.

Indexable Tools
Ball End Mills

アルファボールエンドミル BR2P

■ インサート Inserts

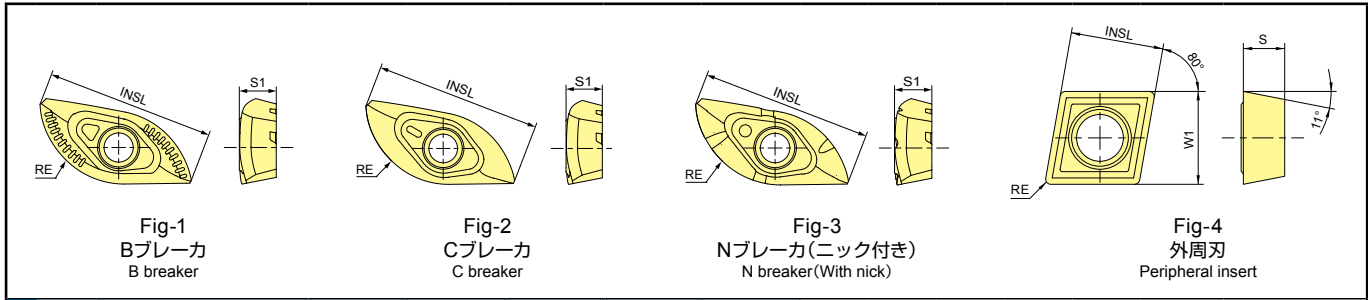

タイプ Type	商品コード Item code	精度 Tolerance class	TH3 コーティング TH3 Coating	AJ コーティング AJ Coating	JSコーティング JS Coating		寸法 Size (mm)					形状 Shape	希望小売 価格(円) Suggested retail price(¥)
			TH308	JP4120	JS4030	JS4060	RE	INSL	W1	S1	S		
R刃 R insert	ZPET080R-B	E級 E		●	●	●	8	16.9	—	3.6	—	Fig-1	4,050
	ZPET100R-B		●	●	●	10	20.3	—	4.7	—	4,490		
	ZPET125R-B		●	●	●	12.5	25.4	—	6	—	5,130		
	ZPET150R-B		●	●	●	15	30.5	—	7.5	—	6,200		
	ZPET160R-B		●	●	●	16	32.5	—	7.5	—	6,680		
	ZPET200R-B		●	●	●	20	40.4	—	8.8	—	6,850		
	ZPET250R-B		●	●	●	25	46.0	—	10.8	—	8,250		
R刃 R insert	ZPET080R-C	E級 E	●	●			8	16.9	—	3.6	—	Fig- 2	4,050
	ZPET100R-C		●	●			10	20.3	—	4.7	—		4,490
	ZPET125R-C		●	●			12.5	25.4	—	6	—		5,130
	ZPET150R-C		●	●			15	30.5	—	7.5	—		6,200
	ZPET160R-C		●	●			16	32.5	—	7.5	—		6,680
	ZPET200R-C		●	●			20	40.4	—	8.8	—		6,850
	ZPET250R-C		●	●			25	46.0	—	10.8	—		8,250
R刃 R insert	ZPET200R-N	E級 E	—	●	●	●	20	40.4	—	8.8	—	Fig- 3	6,850
	ZPET250R-N		—	●	●	●	25	46.0	—	10.8	—		8,250
外周刃 Peripheral insert	CPMT070304	M級 M	—		●		0.4	7.14	7.14	—	3.18	Fig- 4	860
	CPMT090308		—		●		0.8	9.525	9.525	—	3.18		1,010
	CPMT120408		—		●		0.8	12.7	12.7	—	4.76		1,850

【注意】JSコーティングは通電式タッチセンサーに反応しませんのでご注意ください。
 【Note】Please note that the JS Coating does not cause a reaction in conductive touch sensors.

■ コーティング材種使い分け Insert grade selection

材種名 Grade	用途 Application	特長 Features
TH308	高硬度鋼 High-hardened steels	超微粒超硬合金とTH3コーティングを採用。Features micro grain substrate and TH3 Coating. 高硬度鋼加工の汎用性に優れる。Offers excellent versatility for cutting high-hardened steels.
JP4120	30~50HRCの合金鋼・ 焼入れ鋼・肉盛溶接材 Alloy steels, hardened steels, and overlay welding materials with hardness ranging from 30 to 50 HRC	微粒超硬合金とAJコーティングを採用。Features fine grain substrate and AJ Coating. 鋼一般から焼入れ鋼の加工に優れる。Suitable for cutting materials ranging from general steel to hardened steels.
JS4030	鋼一般 General steel	粗粒超硬合金とJSコーティングを採用。Features rough grain substrate and JS Coating. 鋼一般の切削に優れる。Suitable for cutting general steel.
JS4060	不安定切削・湿式切削 Unstable cutting/wet cutting	粗粒超硬合金とJSコーティングを採用。Features rough grain substrate and JS Coating. 軟鋼の不安定切削や湿式切削に優れる。Suitable for unstable mild steel cutting and wet cutting.

●印：標準在庫品です。●：Stocked items. 無印：弊社営業へお問合せください。No mark：Contact with our sales department. 一印：製作いたしません。—：No Manufactured.

刃先交換式工具 ボールエンドミル

B、C、Nブレイカの使い分け Suitable uses for B, C, and N chipbreakers

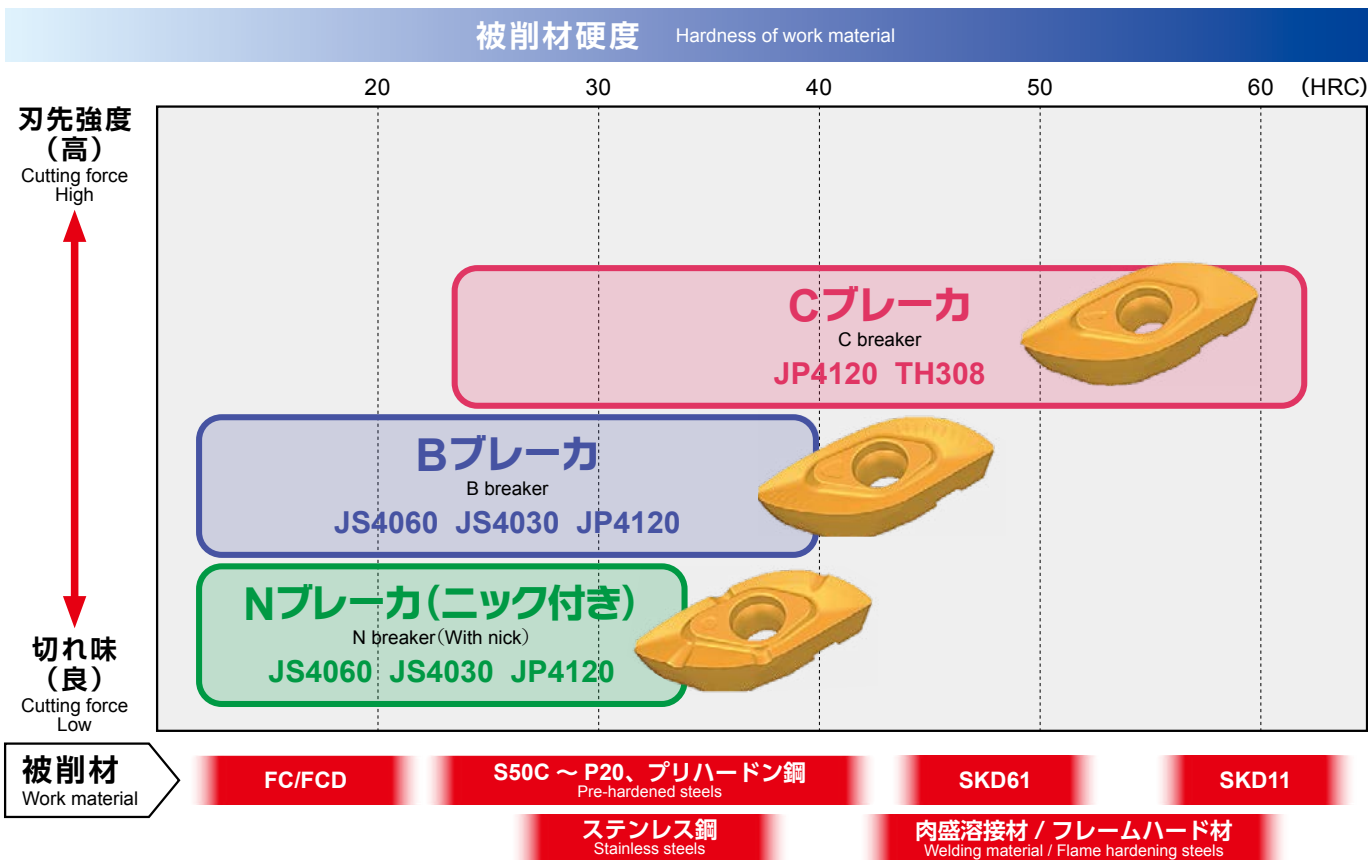

Indexable Tools
Ball End Mills

インサート取付け手順 Insert setup procedures

1 インサート座面の清掃

Clean the insert seat:
エアブローなどで、インサート座面を清掃ください。
Clean the insert seat surface, such as by using an air blower.

2 インサートは、親刃と子刃が一体の形状です。

The insert is formed by integrating a main cutting edge and a sub cutting edge.
ボディ親刃側の座へは親刃マークを先端方向へ向けてインサートを着座させてください。
ボディ子刃側の座へは親刃マークをシャンク方向へ向けてインサートを着座させてください。
On the main cutting edge side, position the insert on the body seat with the main cutting edge mark facing toward the tip.
On the sub cutting edge side, position the insert on the body seat with the main cutting edge mark facing toward the shank.

3 クランプねじを締め付けてインサートを固定する。

Tighten the clamp screw to fix the insert.
クランプねじのドライブサイズは、トルクス プラス®です。
トルクス プラス®に対応したレンチをご使用ください。
The drive type of the clamp screw is Torx Plus®.
Use a Torx Plus® wrench.

4 締め付け完了。

This concludes the insert setup.

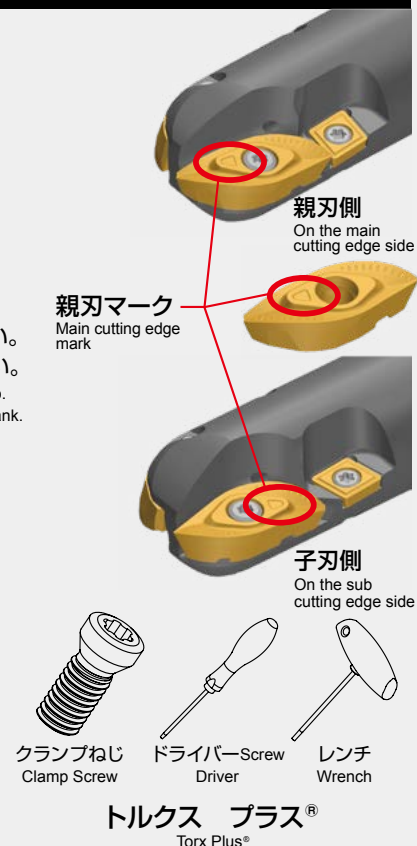

トルクス プラス®, Torx Plus®は、米国アキュメント インテクチュアル プロパティーズ エルエルシー社の登録商標です。
Torx Plus® is a trademark of Acument Intellectual Properties LLC in the United States.

アルファボールエンドミル BR2P

標準切削条件表 Recommended cutting conditions

■ スチールシャンク Steel Shank

※赤字は第1推奨材種です。Red indicates primary recommended insert grades.

被削材 Work material	推奨材種 Recommended inserts grade	切削条件 Cutting conditions	φ16			φ20					φ25				
			>3DC			>3DC			3DC ~5DC	5DC ~	>3DC			3DC ~5DC	5DC ~
			汎用 General purpose	フルR加工 高能率条件 Full R cutting in high efficiency machining	中仕上げ 汎用条件 Semi-finishing in general machining	汎用 General purpose	フルR加工 高能率条件 Full R cutting in high efficiency machining	中仕上げ 汎用条件 Semi-finishing in general machining			汎用 General purpose	フルR加工 高能率条件 Full R cutting in high efficiency machining	中仕上げ 汎用条件 Semi-finishing in general machining		
炭素鋼 合金鋼 Carbon steels Alloy steels (30HRC 以下) (30HRC or less)	JS4030 JP4120 JS4060	n (min ⁻¹)	3,190	4,380	4,980	2,550	3,510	3,980	1,760	1,520	2,040	2,810	3,190	1,410	1,210
		v_c (m/min)	160	220	250	160	220	250	110	95	160	220	250	110	95
		v_f (mm/min)	1,280	880	2,990	1,020	710	2,390	530	370	820	850	1,920	430	300
		f_z (mm/t)	0.2	0.1	0.3	0.2	0.1	0.3	0.15	0.12	0.2	0.15	0.3	0.15	0.12
		a_p (mm)	3	8	0.5	4	10	0.7	2	1	5	12.5	1	2.5	1.5
		a_e (mm)	3	1	1	4	2	1.2	2	1	5	3	2	2.5	1.5
合金鋼 工具鋼 Alloy steels Tool steels (30~45HRC)	JP4120 JS4030 JS4060 TH308	n (min ⁻¹)	2,390	2,590	3,590	1,910	2,070	2,870	1,360	1,120	1,530	1,660	2,300	1,090	900
		v_c (m/min)	120	130	180	120	130	180	85	70	120	130	180	85	70
		v_f (mm/min)	720	520	2,160	580	420	1,730	330	230	460	500	1,380	270	180
		f_z (mm/t)	0.15	0.1	0.3	0.15	0.1	0.3	0.12	0.1	0.15	0.15	0.3	0.12	0.1
		a_p (mm)	3	8	0.5	4	10	0.7	2	1	5	12.5	1	2.5	1.5
		a_e (mm)	3	1	1	4	2	1.2	2	1	5	3	2	2.5	1.5
鋳鉄 Cast irons FC FCD	JP4120 JS4060 JS4030 TH308	n (min ⁻¹)	3,190	4,380	4,980	2,550	3,510	3,980	1,760	1,520	2,040	2,810	3,190	1,410	1,210
		v_c (m/min)	160	220	250	160	220	250	110	95	160	220	250	110	95
		v_f (mm/min)	1,280	880	2,990	1,020	710	2,390	530	370	820	850	1,920	430	300
		f_z (mm/t)	0.2	0.1	0.3	0.2	0.1	0.3	0.15	0.12	0.2	0.15	0.3	0.15	0.12
		a_p (mm)	3	8	0.5	4	10	0.7	2	1	5	12.5	1	2.5	1.5
		a_e (mm)	3	1	1	4	2	1.2	2	1	5	3	2	2.5	1.5
ステンレス鋼 Stainless steels SUS	JS4060 JP4120	n (min ⁻¹)	1,990	—	2,990	1,600	—	2,390	1,120	960	1,280	—	1,910	900	770
		v_c (m/min)	100	—	150	100	—	150	70	60	100	—	150	70	60
		v_f (mm/min)	600	—	1,800	480	—	1,440	270	200	390	—	1,150	220	160
		f_z (mm/t)	0.15	—	0.3	0.15	—	0.3	0.12	0.1	0.15	—	0.3	0.12	0.1
		a_p (mm)	3	—	0.5	4	—	0.7	2	1	5	—	1	2.5	1.5
		a_e (mm)	3	—	1	4	—	1.2	2	1	5	—	2	2.5	1.5
焼入れ鋼 Hardened steels (45~55HRC)	JP4120 TH308	n (min ⁻¹)	1,990	—	2,990	1,600	—	2,390	1,120	960	1,280	—	1,910	900	770
		v_c (m/min)	100	—	150	100	—	150	70	60	100	—	150	70	60
		v_f (mm/min)	480	—	1,800	390	—	1,440	180	140	310	—	1,150	150	110
		f_z (mm/t)	0.12	—	0.3	0.12	—	0.3	0.08	0.07	0.12	—	0.3	0.08	0.07
		a_p (mm)	1.5	—	0.5	2	—	0.7	1	0.5	2.5	—	0.5	1.5	0.7
		a_e (mm)	1.5	—	1	2	—	1.2	1	0.5	2.5	—	2.7	1.5	0.7
焼入れ鋼 Hardened steels (55~62HRC)	TH308 JP4120	n (min ⁻¹)	1,600	—	2,390	1,280	—	1,910	880	800	1,020	—	1,530	710	640
		v_c (m/min)	80	—	120	80	—	120	55	50	80	—	120	55	50
		v_f (mm/min)	390	—	1,440	310	—	1,150	150	100	250	—	920	120	80
		f_z (mm/t)	0.12	—	0.3	0.12	—	0.3	0.08	0.06	0.12	—	0.3	0.08	0.06
		a_p (mm)	1.5	—	0.5	1.5	—	0.7	0.7	0.5	2	—	0.5	0.7	0.5
		a_e (mm)	1.5	—	1	2	—	1.2	1.5	1	2.5	—	2.7	1.5	1

- 【注意】①被削材、加工条件に合わせて、適切なクーラントを使用してください。
 ②この切削条件表は切削条件の目安を示すものです。実際の加工では加工形状、目的、使用機械等により条件を調整してください。
 ③JSコーティングは、通電式タッチセンサーに反応しませんのでご注意ください。
 ④切りくず噛み込みによる工具損傷防止のため、必ずエアブロー等による切りくず除去を行ってください。
 ⑤排出した切りくずは、飛散し作業者を切傷させ、火傷あるいは目に入って負傷させる恐れがありますので、ご使用に際してはその周辺に安全カバーを取り付け、保護メガネ等の保護具を着用し、安全な環境で作業されることをお願い致します。
 ⑥インサート交換時間は早めに行い、過度の使用による破損を防止してください。
 ⑦特に、溝切削の伴う、またはそれに近い切込み幅の加工などで、切りくずの噛み込みやびびり振動が発生し、トラブルに至る場合がありますので下記を参考に調整してください。
 ・回転数、テーブル送り速度を50~70%下げる。
 ・切り込み深さ a_p を50~70%下げる。
 ・切り込み幅 a_e は50~70%下げる。
 ⑧ポケット加工等にて傾斜切込みを行う場合は、角度は3~5°を推奨します。送り速度は70%を目安にしてください。高硬度材の場合は3°未満に設定してください。

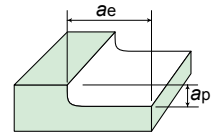

φ 30					φ 32			φ 40		φ 50		被削材 Work material
>3DC			3DC ~5DC	5DC ~	>3DC			汎用 General purpose	フルR加工 高能率条件 Full R cutting in high efficiency machining	汎用 General purpose	フルR加工 高能率条件 Full R cutting in high efficiency machining	
汎用 General purpose	フルR加工 高能率条件 Full R cutting in high efficiency machining	中仕上げ 汎用条件 Semi-finishing in general machining			汎用 General purpose	フルR加工 高能率条件 Full R cutting in high efficiency machining	中仕上げ 汎用条件 Semi-finishing in general machining					
1,700	2,340	2,660	1,170	1,010	1,600	2,190	2,490	1,280	1,990	1,020	1,600	炭素鋼 合金鋼 Carbon steels Alloy steels (30HRC 以下) (30HRC or less)
160	220	250	110	95	160	220	250	160	250	160	250	
1,020	710	2,130	470	370	960	660	2,000	770	600	820	740	
0.3	0.15	0.4	0.2	0.18	0.3	0.15	0.4	0.3	0.15	0.4	0.23	
6	15	1	3	2	6	16	1	8	20	10	25	
6	4	3	3	2	6	4	3	8	5	10	6	
1,280	1,380	1,910	910	750	1,200	1,300	1,800	960	1,200	770	960	合金鋼 工具鋼 Alloy steels Tool steels (30~45HRC)
120	130	180	85	70	120	130	180	120	150	120	150	
520	420	1,530	260	180	480	390	1,440	390	360	470	450	
0.2	0.15	0.4	0.14	0.12	0.2	0.15	0.4	0.2	0.15	0.3	0.23	
6	15	1	3	2	6	16	1	8	20	10	25	
6	4	3	3	2	6	4	3	8	5	10	6	
1,700	2,340	2,660	1,170	1,010	1,600	2,190	2,490	1,280	1,990	1,020	1,600	鋳鉄 Cast irons FC FCD
160	220	250	110	95	160	220	250	160	250	160	250	
1,020	710	2,130	470	370	960	660	2,000	770	600	820	740	
0.3	0.15	0.4	0.2	0.18	0.3	0.15	0.4	0.3	0.15	0.4	0.23	
6	15	1	3	2	6	16	1	8	20	10	25	
6	4	3	3	2	6	4	3	8	5	10	6	
1,070	—	1,600	750	640	1,000	—	1,500	800	—	640	—	ステンレス鋼 Stainless steels SUS
100	—	150	70	60	100	—	150	100	—	100	—	
430	—	960	210	160	400	—	900	320	—	390	—	
0.2	—	0.3	0.14	0.12	0.2	—	0.3	0.2	—	0.3	—	
6	—	1	3	2	6	—	1	8	—	10	—	
6	—	3	3	2	6	—	3	8	—	10	—	
1,070	—	1,600	750	640	1,000	—	1,500	800	—	640	—	焼入れ鋼 Hardened steels (45~55HRC)
100	—	150	70	60	100	—	150	100	—	100	—	
330	—	960	150	110	300	—	900	240	—	200	—	
0.15	—	0.3	0.1	0.08	0.15	—	0.3	0.15	—	0.15	—	
3	—	0.5	2	1	3	—	0.5	4	—	5	—	
3	—	3	2	1	3	—	3	4	—	5	—	
850	—	1,280	590	540	800	—	1,200	640	—	510	—	焼入れ鋼 Hardened steels (55~62HRC)
80	—	120	55	50	80	—	120	80	—	80	—	
210	—	770	100	70	200	—	720	130	—	110	—	
0.12	—	0.3	0.08	0.06	0.12	—	0.3	0.1	—	0.1	—	
2	—	0.5	1	0.5	2	—	0.5	2	—	2	—	
3	—	3	2	1	3	—	3	3	—	4	—	

[Note] ① Use the coolant appropriate for the work material and cutting conditions.

② This table of cutting conditions shows only reference data. For actual cutting, adjust the conditions by accounting for the shape to be machined, purpose, and machine type.

③ Note that the JS Coating does not respond to conductive touch sensors.

④ To prevent tool damage due to chip clogging, always use a chip removal method such as an air blower, etc.

⑤ Since there is a danger of the removed chips flying out and causing injury to workers, fire, or damage to eyes, during use be sure to cover the work area with a safety cover and have workers wear protective equipment such as glasses, etc. to make the work area safe.

⑥ Replace the insert ahead of time to prevent breakage caused by excessive use.

⑦ In particular, chip clogging or chattering vibration may occur when cutting a groove or processing cutting widths near the groove, which can lead to problems. Refer to the following to adjust conditions:

- Reduce revolution speed and table feed by 50 to 70%.
- Reduce cutting depth (ap) by 50 to 70%.
- Reduce cutting width (ae) by 50 to 70%.

⑧ A slant angle of 3 to 5° is recommended for pocketing with a feed rate of 70%. Reduce the slant angle to less than 3° for high hard materials.

標準切削条件表 Recommended cutting conditions

モジュラー Modular

※赤字は第1推奨材種です。Red indicates primary recommended insert grades.

被削材 Work material	推奨材種 Recommended inserts grade	切削条件 Cutting conditions	φ 16			φ 20		
			3DC ~5DC	5DC ~7DC	>7DC	3DC ~5DC	5DC ~7DC	>7DC
炭素鋼 合金鋼 Carbon steels Alloy steels (30HRC 以下) (30HRC or less)	JS4030 JP4120 JS4060	n (min ⁻¹)	2,190	1,890	1,600	1,760	1,520	1,280
		v_c (m/min)	110	95	80	110	95	80
		v_f (mm/min)	1,100	570	320	1,060	610	260
		f_z (mm/t)	0.25	0.15	0.1	0.3	0.2	0.1
		a_p (mm)	1	1	1	1	1	1
		a_e (mm)	1.7	1.2	1	2	1.5	1
合金鋼 工具鋼 Alloy steels Tool steels (30~45HRC)	JP4120 JS4030 JS4060 TH308	n (min ⁻¹)	1,700	1,400	1,200	1,360	1,120	960
		v_c (m/min)	85	70	60	85	70	60
		v_f (mm/min)	680	340	170	550	340	140
		f_z (mm/t)	0.2	0.12	0.07	0.2	0.15	0.07
		a_p (mm)	1	1	1	1	1	1
		a_e (mm)	1.7	1.2	1	2	1.5	1
鋳鉄 Cast irons FC FCD	JP4120 JS4060 JS4030 TH308	n (min ⁻¹)	2,190	1,890	1,600	1,760	1,520	1,280
		v_c (m/min)	110	95	80	110	95	80
		v_f (mm/min)	1,100	570	320	1,060	610	260
		f_z (mm/t)	0.25	0.15	0.1	0.3	0.2	0.1
		a_p (mm)	1	1	1	1	1	1
		a_e (mm)	1.7	1.2	1	2	1.5	1
ステンレス鋼 Stainless steels SUS	JS4060 JP4120	n (min ⁻¹)	1,400	1,200	1,000	1,120	960	800
		v_c (m/min)	70	60	50	70	60	50
		v_f (mm/min)	560	290	140	450	290	120
		f_z (mm/t)	0.2	0.12	0.07	0.2	0.15	0.07
		a_p (mm)	1	1	1	1	1	1
		a_e (mm)	1.7	1.2	1	2	1.5	1
焼入れ鋼 Hardened steels (45~55HRC)	JP4120 TH308	n (min ⁻¹)	1,400	1,200	1,000	1,120	960	800
		v_c (m/min)	70	60	50	70	60	50
		v_f (mm/min)	280	170	100	230	140	80
		f_z (mm/t)	0.1	0.07	0.05	0.1	0.07	0.05
		a_p (mm)	0.5	0.5	0.5	0.5	0.5	0.5
		a_e (mm)	1	0.7	0.5	1.2	0.8	0.5
焼入れ鋼 Hardened steels (55~62HRC)	TH308 JP4120	n (min ⁻¹)	1,100	1,000	800	880	800	640
		v_c (m/min)	55	50	40	55	50	40
		v_f (mm/min)	160	120	80	130	100	70
		f_z (mm/t)	0.07	0.06	0.05	0.07	0.06	0.05
		a_p (mm)	0.5	0.5	0.5	0.5	0.5	0.5
		a_e (mm)	1	0.7	0.5	1.2	0.8	0.5

- 【注意】**
- ①被削材、加工条件に合わせて、適切なクーラントを使用してください。
 - ②この切削条件表は切削条件の目安を示すものです。実際の加工では加工形状、目的、使用機械等により条件を調整してください。
 - ③JSコーティングは、通電式タッチセンサーに反応しませんのでご注意ください。
 - ④切りくず噛み込みによる工具損傷防止のため、必ずエアブロー等による切りくず除去を行ってください。
 - ⑤排出した切りくずは、飛散し作業者を切傷させ、火傷あるいは目に入って負傷させる恐れがありますので、ご使用に際してはその周辺に安全カバーを取り付け、保護メガネ等の保護具を着用し、安全な環境で作業されることをお願い致します。
 - ⑥インサート交換時間は早めに行い、過度の使用による破損を防止してください。
 - ⑦特に、溝切削の伴う、またはそれに近い切込み幅の加工などで、切りくずの噛み込みやびびり振動が発生し、トラブルに至る場合がありますので下記を参考に調整してください。
 - ・回転数、テーブル送り速度を 50~70%下げる。
 - ・切り込み深さ a_p を 50~70%下げる。
 - ・切り込み幅 a_e は 50~70%下げる。
 - ⑧ポケット加工等にて傾斜切込みを行う場合は、角度は 3~5° を推奨します。送り速度は 70%を目安にしてください。高硬度材の場合は 3' 未満に設定してください。

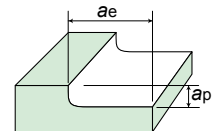

φ 25			φ 30			φ 32			被削材 Work material
3DC ~ 5DC	5DC ~ 7DC	>7DC	3DC ~ 5DC	5DC ~ 7DC	>7DC	3DC ~ 5DC	5DC ~ 7DC	>7DC	
1,410	1,210	1,020	1,170	1,010	850	1,110	950	800	炭素鋼 合金鋼 Carbon steels Alloy steels (30HRC 以下) (30HRC or less)
110	95	80	110	95	80	110	95	80	
850	490	210	940	610	340	880	570	320	
0.30	0.20	0.10	0.40	0.30	0.20	0.40	0.30	0.20	
1	1	1	1	1	1	1	1	1	
2	1.5	1	3	2	1	3	2	1	
1,090	900	770	910	750	640	850	700	600	合金鋼 工具鋼 Alloy steels Tool steels (30 ~ 45HRC)
85	70	60	85	70	60	85	70	60	
440	270	110	550	300	130	510	280	120	
0.20	0.15	0.07	0.30	0.20	0.10	0.30	0.20	0.10	
1	1	1	1	1	1	1	1	1	
2	1.5	1	3	2	1	3	2	1	
1,410	1,210	1,020	1,170	1,010	850	1,100	950	800	鑄鉄 Cast irons FC FCD
110	95	80	110	95	80	110	95	80	
850	490	210	940	610	340	880	570	320	
0.30	0.20	0.10	0.40	0.30	0.20	0.40	0.30	0.20	
1	1	1	1	1	1	1	1	1	
2	1.5	1	3	2	1	3	2	1	
900	770	640	750	640	540	700	600	500	ステンレス鋼 Stainless steels SUS
70	60	50	70	60	50	70	60	50	
360	240	90	450	260	110	420	240	100	
0.2	0.15	0.07	0.3	0.2	0.1	0.3	0.2	0.1	
1	1	1	1	1	1	1	1	1	
2	1.5	1	3	2	1	3	2	1	
900	770	640	750	640	540	700	600	500	焼入れ鋼 Hardened steels (45 ~ 55HRC)
70	60	50	70	60	50	70	60	50	
180	110	70	230	130	80	210	120	70	
0.1	0.07	0.05	0.15	0.1	0.07	0.15	0.1	0.07	
0.5	0.5	0.5	0.5	0.5	0.5	0.5	0.5	0.5	
1.2	0.8	0.5	1.5	1	0.5	1.5	1	0.5	
710	640	510	590	540	430	550	500	400	焼入れ鋼 Hardened steels (55 ~ 62HRC)
55	50	40	55	50	40	55	50	40	
100	80	60	120	80	50	110	70	40	
0.07	0.06	0.05	0.1	0.07	0.05	0.1	0.07	0.05	
0.5	0.5	0.5	0.5	0.5	0.5	0.5	0.5	0.5	
1.2	0.8	0.5	1.5	1	0.5	1.5	1	0.5	

- [Note] ① Use the coolant appropriate for the work material and cutting conditions.
 ② This table of cutting conditions shows only reference data. For actual cutting, adjust the conditions by accounting for the shape to be machined, purpose, and machine type.
 ③ Note that the JS Coating does not respond to conductive touch sensors.
 ④ To prevent tool damage due to chip clogging, always use a chip removal method such as an air blower, etc.
 ⑤ Since there is a danger of the removed chips flying out and causing injury to workers, fire, or damage to eyes, during use be sure to cover the work area with a safety cover and have workers wear protective equipment such as glasses, etc. to make the work area safe.
 ⑥ Replace the insert ahead of time to prevent breakage caused by excessive use.
 ⑦ In particular, chip clogging or chattering vibration may occur when cutting a groove or processing cutting widths near the groove, which can lead to problems. Refer to the following to adjust conditions:
 ・ Reduce revolution speed and table feed by 50 to 70%.
 ・ Reduce cutting depth (ap) by 50 to 70%.
 ・ Reduce cutting width (ae) by 50 to 70%.
 ⑧ A slant angle of 3 to 5° is recommended for pocketing with a feed rate of 70%. Reduce the slant angle to less than 3° for high hard materials.

標準切削条件表 Recommended cutting conditions

肉盛溶接材加工用標準切削条件表

Recommended cutting conditions table for processing overlay welding materials

※赤字は第1推奨材種です。

Red indicates primary recommended insert grades.

金型素材 Mold material	被削材 Work material			推奨材種 Recommended inserts grade	切削条件 Cutting conditions	スチールシャンク Steel shank		
	溶接材料 Welding material					φ 30		
	該当規格 (銘柄) Applicable standard (Brand)	特長・用途 Features and applications	硬さ (HRC) Hardness (HRC)			>3DC	3DC ~ 5DC	5DC ~
鋳鉄 Cast irons FC FCD	規格：該当なし Standard: N/A (TM-2000C)	金型硬化肉盛用 Mold hardfacing	20 ~ 30	JP4120 JS4060	n (min ⁻¹) v_c (m/min) vf (mm/min) fz (mm/t) a_p (mm) a_e (mm)	1700 160 1020 0.3 ~ 3 3	1170 110 470 0.2 ~ 3 3	1010 95 370 0.18 2 2
	規格：該当なし Standard: N/A (TM-2000B)	金型硬化肉盛用 耐摩耗・耐かじり防止用 Mold hardfacing [for anti-wear and anti-galling]	37 ~ 39	JP4120 JS4060	n (min ⁻¹) v_c (m/min) vf (mm/min) fz (mm/t) a_p (mm) a_e (mm)	1280 120 520 0.2 ~ 3 3	910 85 260 0.14 ~ 3 3	750 70 180 0.12 2 2
	規格：該当なし Standard: N/A (TM-2000)	金型硬化肉盛用 耐摩耗・耐かじり防止用 Mold hardfacing [for anti-wear and anti-galling]	44 ~ 46	JP4120 JS4060	n (min ⁻¹) v_c (m/min) vf (mm/min) fz (mm/t) a_p (mm) a_e (mm)	1070 100 370 0.17 ~ 3 3	910 85 220 0.12 2 2	750 70 150 0.1 1 2
	規格：該当なし Standard: N/A (TC-8B) (NIW-5)	金型硬化肉盛用 (切刃用) Mold hardfacing (for cutting edge)	52 ~ 58	JP4120 TH308	n (min ⁻¹) v_c (m/min) vf (mm/min) fz (mm/t) a_p (mm) a_e (mm)	1070 100 330 0.15 ~ 3 3	750 70 150 0.1 2 2	640 60 110 0.08 1 2
合金鋼 Alloy steels Tool steels (30 ~ 45HRC)	規格 Standard JIS Z3251 DF4A-500-B (TM-11Cr)	金型硬化肉盛用 (切刃用) Mold hardfacing (for cutting edge)	52 ~ 55	JP4120 TH308	n (min ⁻¹) v_c (m/min) vf (mm/min) fz (mm/t) a_p (mm) a_e (mm)	1070 100 330 0.15 ~ 3 3	750 70 150 0.1 2 2	640 60 110 0.08 1 2
	規格：該当なし Standard: N/A (THW)	金型硬化肉盛用 (衝撃摩耗用) Mold hardfacing (for anti-impact wear)	55 ~ 60	JP4120 TH308	n (min ⁻¹) v_c (m/min) vf (mm/min) fz (mm/t) a_p (mm) a_e (mm)	850 80 170 0.1 ~ 3 3	640 60 110 0.08 2 2	540 50 70 0.06 1 2
焼入れ鋼 Hardened steels (55 ~ 62HRC)	規格 Standard JIS Z3251 DF3B-600-B (TM10B)	金型硬化肉盛用 (衝撃摩耗用) Mold hardfacing (for anti-impact wear)	54 ~ 58	JP4120 TH308	n (min ⁻¹) v_c (m/min) vf (mm/min) fz (mm/t) a_p (mm) a_e (mm)	850 80 170 0.1 ~ 3 3	640 60 110 0.08 2 2	540 50 70 0.06 1 2
	規格：該当なし Standard: N/A (THW)	金型硬化肉盛用 (衝撃摩耗用) Mold hardfacing (for anti-impact wear)	55 ~ 60	JP4120 TH308	n (min ⁻¹) v_c (m/min) vf (mm/min) fz (mm/t) a_p (mm) a_e (mm)	850 80 170 0.1 ~ 3 3	640 60 110 0.08 2 2	540 50 70 0.06 1 2

- 【注意】**
- 溶接材料の銘柄、特長、硬度については東海溶業株式会社様のカタログを参考とさせていただきます。
 - 溶接材加工に関して、上記記載にない材種等不明の点、その他ご相談がありましたら弊社営業へお問い合わせください。
 - 被削材、加工条件に合わせて、適切なクーラントを使用してください。
 - この切削条件表は切削条件の目安を示すものです。実際の加工では加工形状、目的、使用機械等により条件を調整してください。
 - JSコーティングは、通電式タッチセンサーに反応しませんのでご注意ください。
 - 切りくず噛み込みによる工具損傷防止のため、必ずエアブロー等による切りくず除去を行ってください。
 - 排出した切りくずは、飛散し作業者を切傷させ、火傷あるいは目に入って負傷させる恐れがありますので、ご使用に際してはその周辺に安全カバーを取り付け、保護メガネ等の保護具を着用し、安全な環境で作業されることをお願い致します。
 - インサート交換時間は早めに行い、過度の使用による破損を防止してください。
 - 特に、溝切削の伴う、またはそれに近い切込み幅の加工などで、切りくずの噛み込みやびびり振動が発生し、トラブルに至る場合がありますので下記を参考に調整してください。
 - ・回転数、テーブル送り速度を 50~70% 下げる。
 - ・切込み深さ a_p を 50~70% 下げる。
 - ・切込み幅 a_e は 50~70% 下げる。
 - ポケット加工等にて傾斜切込みを行う場合は、角度は 3~5° を推奨します。送り速度は 70% を目安にしてください。高硬度材の場合は 3° 未満に設定してください。

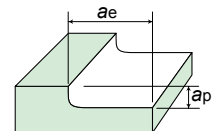

Ball End Mill BCF

アルファボールエンドミル BCF

- 滑らかな削りを生む、凸状すくい面切れ刃をもっています。
- 引き上げ切削に安心なキー溝つきインサートクランプです。
- 子刃インサートの切れ刃を中心近くまで設定しました。

- ・ A convex shape rake cutting edge enables smooth cutting.
- ・ The inserts are clamped with a key slot that provide safe cutting in lift cutting.
- ・ The cutting edge of a sub insert was set to nearly the center of cutting.

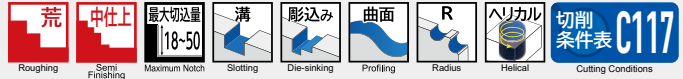

BCF○○○○○S○○S レギュラー形 Regular

○は数字が入ります。 Numeric figure in a circle ○

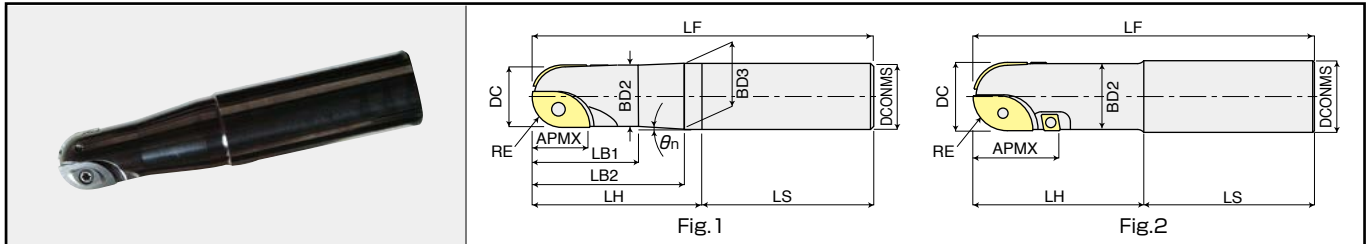

商品コード Item code	在庫 Stock	寸法 Size(mm)											形状 Shape	適用インサート Inserts				希望小売 価格(円) Suggested retail price (¥)				
		DC	RE	LF	DCONMS	APMX	LB2	LH	LB1	θn	BD3	BD2		LS	親刃 Main insert		子刃 Sub insert		外周刃 Peripheral insert			
															商品コード Item code	刃数 Flutes	商品コード Item code		刃数 Flutes	商品コード Item code	刃数 Flutes	
BCF2018S25S	●	20	10	140	25	18	52	60	30	5.7°	23.4	19	80	Fig.1	ZCE□100CE	1	ZCE□100SE	1	-	-	-	41,650
BCF2523S32S	●	25	12.5	150	32	23	62	70	35	6.5°	30.1	24	80	Fig.1	ZCE□125CE	1	ZCE□125SE	1	-	-	-	44,120
BCF3028S32S	●	30	15	160	32	28	72	80	50	3.1°	31.2	28.8	80	Fig.1	ZCE□150CE	1	ZCE□150SE	1	-	-	-	45,410
BCF3228S32S	●	32	16	160	32	-	80	-	-	-	-	30.6	80	Fig.1	ZCET160CE	1	ZCET160SE	1	-	-	-	45,410
BCF4050S42S	●	40	20	200	42	50	-	100	-	-	-	38.6	100	Fig.2	ZCEW200CE	1	ZCEW200SE	1	CPMT090308	2	73,560	

BCF○○○○○S○○L ロング刃形 Long cutting edge

○は数字が入ります。 Numeric figure in a circle ○

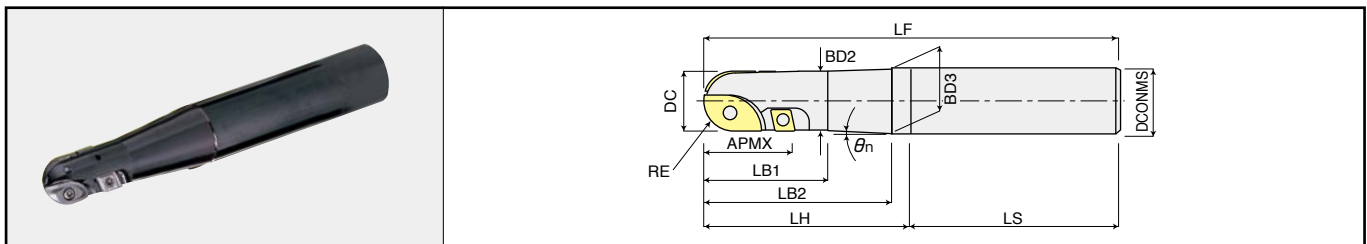

商品コード Item code	在庫 Stock	寸法 Size(mm)											形状 Shape	適用インサート Inserts				希望小売 価格(円) Suggested retail price (¥)			
		DC	RE	LF	DCONMS	APMX	LB2	LH	LB1	θn	BD3	BD2		LS	親刃 Main insert		子刃 Sub insert		外周刃 Peripheral insert		
															商品コード Item code	刃数 Flutes	商品コード Item code		刃数 Flutes	商品コード Item code	刃数 Flutes
BCF2030S25L	●	20	10	150	25	30	62	70	35	5.3°	24	18.5	80	Fig.1	ZCE□100CE	1	ZCE□100SE	1	CPMT080204	2	60,410
BCF2539S32L	●	25	12.5	180	32	39	72	80	50	9.7°	31	23.5	100	Fig.1	ZCE□125CE	1	ZCE□125SE	1	CPMT090308	2	62,890
BCF3043S32L	●	30	15	200	32	43	92	100	60	2.7°	31	28	100	Fig.1	ZCE□150CE	1	ZCE□150SE	1	CPMT090308	2	64,060
BCF3243S32L	●	32	16	200	32	43	-	100	-	-	30.3	-	100	Fig.1	ZCET160CE	1	ZCET160SE	1	CPMT090308	2	64,060
BCF4050S42L	●	40	20	250	42	50	-	150	-	-	38.6	-	100	Fig.2	ZCEW200CE	1	ZCEW200SE	1	CPMT090308	2	81,070

●印：標準在庫品です。 ●：Stocked items.

BCF○○○○S○○E ロングシャンク形 Long shank

○は数字が入ります。 Numeric figure in a circle ○

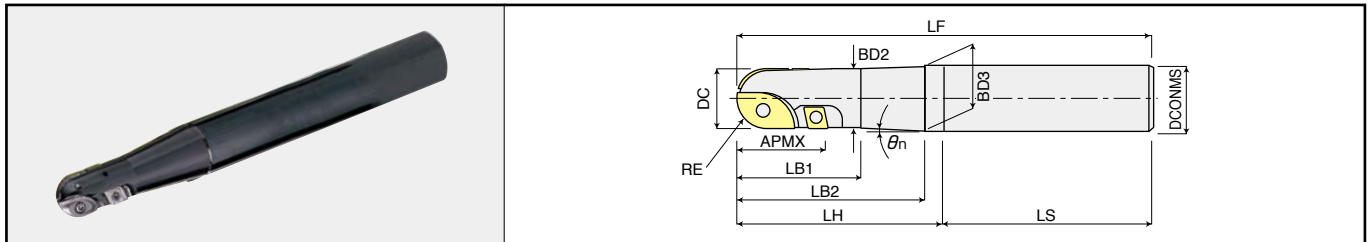

商品コード Item code	在庫 Stock	寸法 Size(mm)											適用インサート Inserts				希望小売価格 (円) Suggested retail price (¥)			
		DC	RE	LF	DCONMS	APMX	LB2	LH	LB1	θn	BD3	BD2	LS	親刃 Main insert		子刃 Sub insert		外周刃 Peripheral insert		
														商品コード Item code	刃数 Flutes	商品コード Item code		刃数 Flutes	商品コード Item code	刃数 Flutes
BCF2030S25E	●	20	10	250	25	30	62	70	35	5.2°	24	18.5	180	ZCE100CE	1	ZCE100SE	1	CPMT080204	2	64,400
BCF2030S32E	●	20	10	250	32	30	62	70	35	12.4°	30.4	18.5	180	ZCE100CE	1	ZCE100SE	1	CPMT080204	2	66,520
BCF2539S32E	●	25	12.5	300	32	39	72	80	50	9.7°	31	23.5	220	ZCE125CE	1	ZCE125SE	1	CPMT090308	2	70,380
BCF3043S32E	●	30	15	350	32	43	92	100	60	2.7°	31	28	250	ZCE150CE	1	ZCE150SE	1	CPMT090308	2	72,970
BCF3243S32E	●	32	16	350	32	43	-	100	-	-	30.3	-	250	ZCET160CE	1	ZCET160SE	1	CPMT090308	2	72,970

- [注意]** ①ロングシャンク形は全長(LF)を長くしておりますので、ご用途に合わせて適正な長さに切断してご使用ください。
 ②ロングシャンク形は上記寸法より追加加工できる仕様にて、LB1, LH, LSの追加加工を別途見積りにより承ります。
- [Note]** ① For a long shank type, its body length (LF) has been made a little longer. Cut it to adjust it to a proper length according to your use.
 ② For a long shank type, additional machining is available from the above listed size. Additional matching of LB1, LH and LS will be separately quoted upon your request.

BCF○○○○S○○TE テーパーネックロングシャンク形 Taper-necked Long shank

○は数字が入ります。 Numeric figure in a circle ○

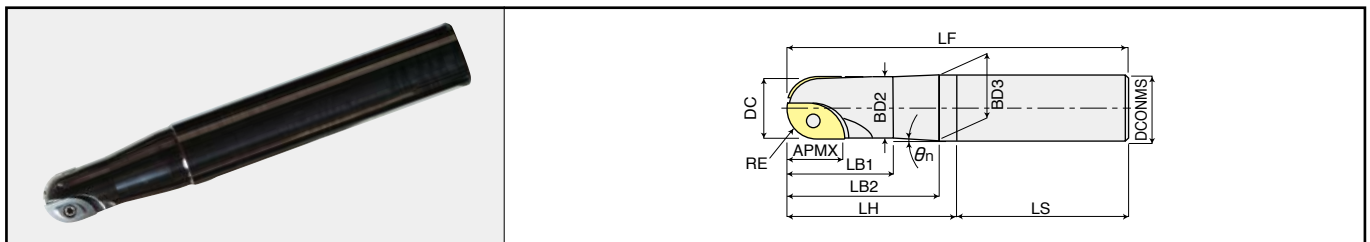

商品コード Item code	在庫 Stock	寸法 Size(mm)											適用インサート Inserts				希望小売価格 (円) Suggested retail price (¥)	
		DC	RE	LF	DCONMS	APMX	LB2	LH	LB1	θn	BD3	BD2	LS	親刃 Main insert		子刃 Sub insert		
														商品コード Item code	刃数 Flutes	商品コード Item code		刃数 Flutes
BCF2018S25TE	●	20	10	250	25	18	72	80	30	3°	23.4	19	170	ZCE100CE	1	ZCE100SE	1	58,070
BCF2018S32TE	●	20	10	300	32	18	107	115	30	4.9°	31.2	18	185	ZCE100CE	1	ZCE100SE	1	59,710
BCF2523S32TE	●	25	12.5	300	32	23	97	105	35	2.8°	30.1	24	195	ZCE125CE	1	ZCE125SE	1	63,350
BCF3028S32TE	●	30	15	350	32	28	92	100	40	1.3°	31.2	28.8	250	ZCE150CE	1	ZCE150SE	1	65,690
BCF3228S32TE	●	32	16	350	32	28	92	100	40	0.3°	31.2	30.6	250	ZCET160CE	1	ZCET160SE	1	65,690

アルファボールエンドミル BCF

BCF○○○○S○○ST○○○ ストレートネックロングシャンク形 Straight Neck Long Shank

○は数字が入ります。 Numeric figure in a circle ○

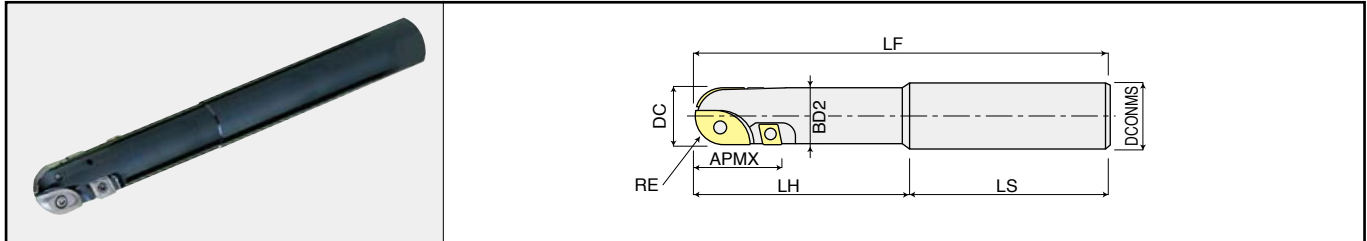

商品コード Item code	在庫 Stock	寸法 Size (mm)								適用インサート Inserts						希望小売価格 (円) Suggested retail price (¥)
		DC	RE	LF	DCONMS	APMX	LH	BD2	LS	親刃 Main insert		子刃 Sub insert		外周刃 Peripheral insert		
										商品コード Item code	刃数 Flutes	商品コード Item code	刃数 Flutes	商品コード Item code	刃数 Flutes	
BCF2030S20ST080	●	20	10	180	20	30	80	18.5	100							61,470
BCF2030S20ST120	●	20	10	220	20	30	120	18.5	100	ZCE○○100CE	1	ZCE○○100SE	1	CPMT080204	2	61,710
BCF2030S20ST150	●	20	10	250	20	30	150	18.5	100							61,940
BCF2539S32ST100	●	25	12.5	200	32	39	100	23.5	100	ZCE○○125CE	1	ZCE○○125SE	1	CPMT090308	2	64,520
BCF2539S32ST150	●	25	12.5	250	32	39	150	23.5	100							66,050
BCF3043S32ST100	●	30	15	200	32	43	100	28	100							65,230
BCF3043S32ST150	●	30	15	250	32	43	150	28	100	ZCE○○150CE	1	ZCE○○150SE	1	CPMT090308	2	66,870
BCF3043S32ST200	●	30	15	300	32	43	200	28	100							68,630

BCF○○MT○○ モールステーパシャンク形 Morse Taper Shank

○は数字が入ります。 Numeric figure in a circle ○

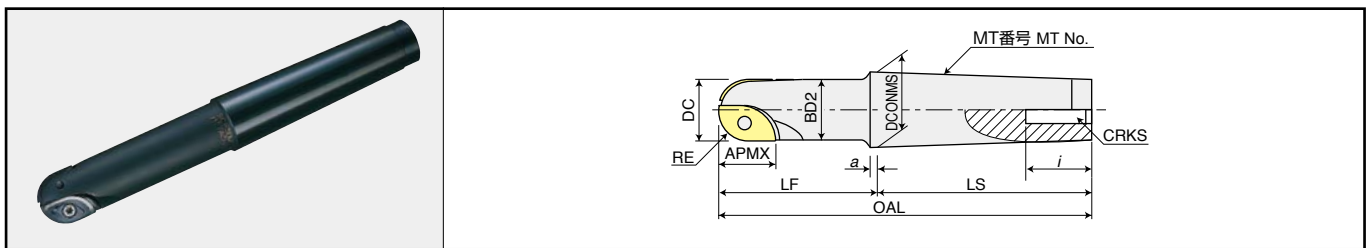

商品コード Item code	在庫 Stock	寸法 Size (mm)											適用インサート Inserts				希望小売価格 (円) Suggested retail price (¥)	
		DC	RE	APMX	MT番号 MT No.	OAL	LF	LS	DCONMS	BD2	a	i	CRKS	親刃 Main insert		子刃 Sub insert		
														商品コード Item code	刃数 Flutes	商品コード Item code		刃数 Flutes
BCF20MT2	●	20	10	18	MT2	129	65	64	17.78	19	5	24	M10	ZCE○○100CE	1	ZCE○○100SE	1	53,260
BCF25MT3	●	25	12.5	23	MT3	166	85	81	23.825	24	5	28	M12	ZCE○○125CE	1	ZCE○○125SE	1	57,250
BCF30MT4	●	30	15	28	MT4	217.5	115	102.5	31.267	28.8	6.5	32	M16	ZCE○○150CE	1	ZCE○○150SE	1	62,170
BCF32MT4	●	32	16	28	MT4	217.5	115	102.5	31.267	30.6	6.5	32	M16	ZCE○○160CE	1	ZCE○○160SE	1	62,170

●印：標準在庫品です。 ●：Stocked items.

○は数字が入ります。 Numeric figure in a circle ○

BCFM モジュラータイプ Modular type

モジュラーミル用シャンクはD2頁を、締め付けトルクについてはD5頁を参照ください。
Refer page D2 about the shanks for Modular Mill, Refer page D5 about tightening torque

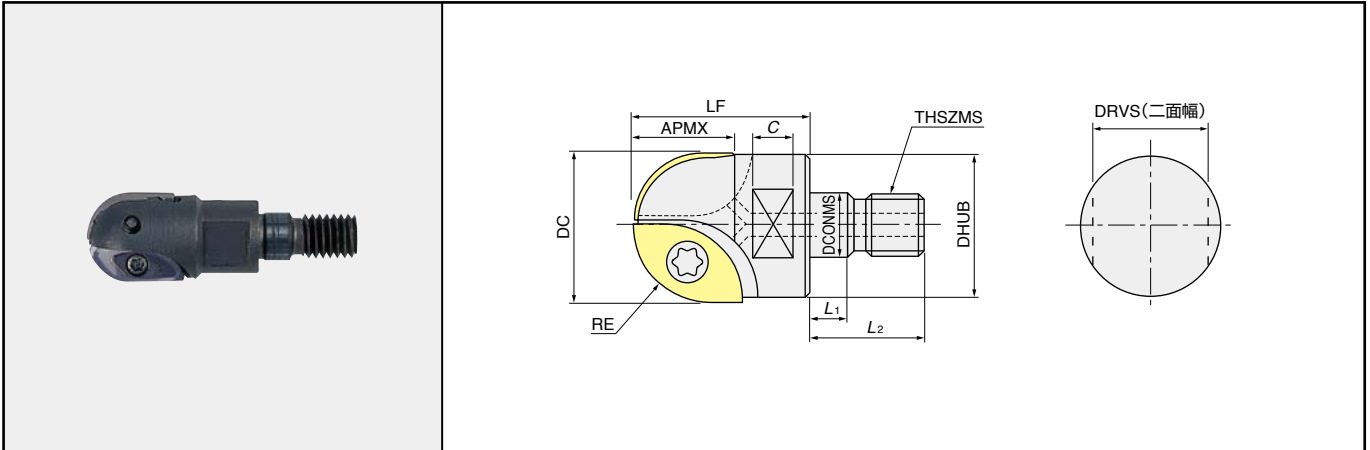

商品コード Item code	在庫 Stock	インサート数 No. of inserts	寸法 Size(mm)											適用インサート Inserts				希望小売 価格(円) Suggested retail price (¥)
			DC	RE	LF	APMX	DCONMS	TDZ	DHUB	L ₁	L ₂	C	E	親刃 Main inserts		子刃 Sub inserts		
														商品コード Item code	刃数 Flutes	商品コード Item code	刃数 Flutes	
BCFM16	●	2	16	8	32	16	8.5	M8	12.8	5.5	17	8	10	ZCET080CE	1	ZCET080SE	1	39,300
BCFM20	●	2	20	10	38	18	10.5	M10	17.8	5.5	19	10	15	ZCET100CE ZCEW100CE	1	ZCET100SE ZCEW100SE	1	41,650
BCFM25	●	2	25	12.5	38	23	12.5	M12	20.8	5.5	22	10	17	ZCET125CE ZCEW125CE	1	ZCET125SE ZCEW125SE	1	44,120
BCFM30	●	2	30	15	43	28	17	M16	28.8	6	23	12	22	ZCET150CE ZCEW150CE	1	ZCET150SE ZCEW150SE	1	45,410
BCFM32	●	2	32	16	43	28	17	M16	28.8	6	23	12	22	ZCET160CE	1	ZCET160SE	1	45,410

【注意】 モジュラーミル及び専用シャンク、専用アーバの「工具端面」「モジュラーねじ部」にグリスなどの潤滑剤は塗布しないでください。

【Note】 Do not apply lubricants such as grease, etc. to the "contact faces" and "modular screws" of the "modular mill", "dedicated shanks" and "dedicated arbor".

アルファボールエンドミル BCF

■ インサート Inserts

○は数字が入ります。 Numeric figure in a circle ○

Fig-1 親刃 Main insert

ZCEW○○○CE ZCET○○○CE



快削形 (中仕上に好適)
High-rake type

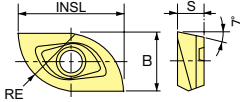

Fig-2 子刃 Sub insert

ZCEW○○○SE ZCET○○○SE



快削形 (中仕上に好適)
High-rake type

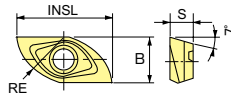
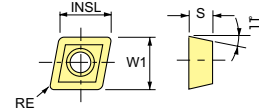

Fig-3 外周刃 Peripheral insert

CPMT○○○○○○○





商品コード Item code	精度 Tolerance class	コーティング Coating			超硬 Carbide		寸法 Size(mm)				形状 Shape	希望小売価格(円) Suggested retail price (¥)		
		AJ Coating JP4120	C Coating CY250	G Coating CY9020	HC844	P EX35	K WH10	RE	INSL	B W1		S	JP4120	CY250 CY9020 HC844
親刃 Main insert	E級 E	●		●			8	15.6	7.9	3.97	Fig. 1	5,140	4,670	—
		●		●			10	18.3	10.0	4.74		5,700	5,190	—
			●		●	●	10	18.3	10.0	4.74		—	5,190	3,990
		●		●			12.5	23.1	12.3	6.10		6,540	5,940	—
			●		●	●	12.5	23.1	12.3	6.10		—	5,940	4,580
		●		●			15	28.3	14.9	7.59		7,770	7,070	—
			●		●	●	15	28.3	14.9	7.59		—	7,070	5,430
		●		●			16	28.8	15.4	7.45		8,380	7,620	—
子刃 Sub insert	E級 E	●		●			8	16.8	5.9	3.43	Fig. 2	3,370	3,070	—
		●		●			10	16.7	8.1	4.24		3,740	3,410	—
			●		●	●	10	16.7	8.1	4.24		—	3,410	2,610
		●		●			12.5	20.8	9.3	5.40		4,270	3,880	—
			●		●	●	12.5	20.8	9.3	5.40		—	3,880	2,990
		●		●			15	25.7	11.8	7.09		5,280	4,800	—
			●		●	●	15	25.7	11.8	7.09		—	4,800	3,690
		●		●			16	26.3	12.4	6.96		5,690	5,170	—
外周刃 Peripheral insert	M級 M		●	—	●		0.4	7.94	7.94	2.38	Fig. 3	—	830	—
			●	—	●	●	0.8	9.525	9.525	3.18		—	920	720

●印：標準在庫品です。 無印：弊社営業へお問合せください。
●：Stocked items. No mark：Contact with our sales department.

部品番号 Parts

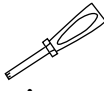
○は数字が入ります。 Numeric figure in a circle ○

部品名 Parts	クランプねじ Clamp screw						ドライバー/レンチ Screw driver/Wrench						ねじ焼き付き防止剤 Screw anti-seizure agent	
	形状 Shape	R 刃 R Insert	締付トルク Fastening torque (N·m)	希望小売価格(円) Suggested retail price (¥)	外周刃 Peripheral Insert	締付トルク Fastening torque (N·m)	希望小売価格(円) Suggested retail price (¥)	R 刃 R Insert	形状 Shape	希望小売価格(円) Suggested retail price (¥)	外周刃 Peripheral Insert	形状 Shape	希望小売価格(円) Suggested retail price (¥)	希望小売価格(円) Suggested retail price (¥)
適用カッタ Cutter body								A				B		
BCF2018S○S/TE	261-141	2.0	870	—	—	—	104-T10	A	1,920	—	—	—	P-37	1,010
BCF20MT2				251-141	1.1	870				104-T8	A	1,800		
BCF2030S○L/E/ST○	262-141	2.9	870	—	—	—	104-T15	A	2,060	—	—	—		
BCF2523S32S/TE				262-141	2.9	870				104-T15	A	2,060		
BCF25MT3				262-141	2.9	870				104-T15	A	2,060		
BCF2539S32L/E/ST○	263-141	4.9	870	—	—	—	105-T20	B	2,120	—	—	—		
BCF3028S32S/TE				262-141	2.9	870				104-T15	A	2,060		
BCF30MT4				262-141	2.9	870				104-T15	A	2,060		
BCF3228S32S				262-141	2.9	870				104-T15	A	2,060		
BCF32MT4				262-141	2.9	870				104-T15	A	2,060		
BCF3043S32L/E/ST○	571-141A	9.8	870	262-141	2.9	870	105-T30A	B	2,120	104-T15	A	2,060		
BCF3243S32L/E				104-T15	A	2,060								
BCF4050S42S	250-141	1.1	870	—	—	—	104-T8	A	1,800	—	—	—		
BCF4050S42L				104-T10	1,920									
BCFM16				104-T15	2,060									
BCFM20				105-T20	2,120									
BCFM25				105-T20	2,120									
BCFM30, BCFM32	263-141	4.9	870	—	—	—	104-T15	A	2,060	—	—	—		

[注意] クランプねじは消耗品です。使用環境により交換寿命は変化しますので早めの交換をお願い致します。クランプねじはR刃用の予備が2本付属します。

[Note] The clamp screw is a consumable part. Since replacement life depends on the use environment, it is recommended that it be replaced at an early stage. Includes two spare clamp screws for R insert.

アルファボールエンドミル BCF

「MT テーパーネックアーバ」規格 MT Taper Neck Arbor

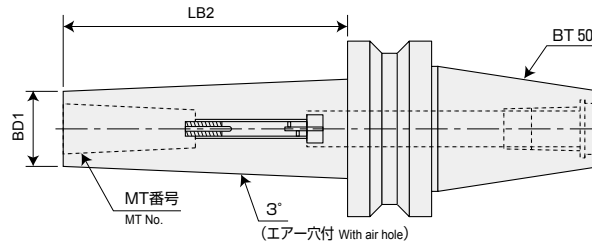

商品コード Item code	在庫 Stock	MT 番号 MT No.	BD1 (mm)	LB2 (mm)	引きねじ形番 Screw
BT50-MTB203-200-24		MT2	24	200	M10-160MT
BT50-MTB303-200-32		MT3	32	200	M12-150MT
BT50-MTB403-200-40		MT4	40	200	M16-160MT
BT50-MTB403-200-46		MT4	46	200	M16-160MT
BT50-MTB203-300-24		MT2	24	300	M10-160MT
BT50-MTB303-300-32		MT3	32	300	M12-150MT
BT50-MTB403-300-40		MT4	40	300	M16-160MT
BT50-MTB403-300-46		MT4	46	300	M16-160MT

〈レンチ・ツールクランパ〉 別途販売品 Wrench and Tool clasper are sold separately.

○は数字が入ります。 Numeric figure in a circle ○

部品名 Parts	レンチ Wrench		ツールクランパ Tool clasper	
形状 Shape				
適用アーバ Arbor body	商品コード Item code	在庫 Stock	商品コード Item code	在庫 Stock
	BT50-MTB203-○○○-24	100-H8	NCL-BT50	
	BT50-MTB303-○○○-32	100-H10		
	BT50-MTB403-○○○-40	100-H14		
	BT50-MTB403-○○○-46			
	BT50-MTB503-70-65			

【注意】 レンチ、ツールクランパは別途販売品となります。

【Note】 Wrench and Tool clasper are sold separately.

標準切削条件表 Recommended cutting conditions

BCF-S-S
レギュラー形
Regular

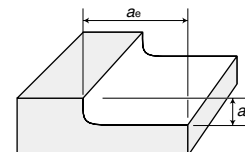

<肩削り> Side Milling ※赤字は第一推奨材種です。Red indicates primary recommended grade.

被削材 Work material	推奨材種 Recommended grade	※最大実切削速度 m/min ※ Actual maximum cutting speed	使用機械 Spindle of machine	一刃当りの送り mm/t Feed rate	φ 20		φ 25		φ 30		φ 40	
					回転数n min ⁻¹	送り速度vf mm/min	回転数n min ⁻¹	送り速度vf mm/min	回転数n min ⁻¹	送り速度vf mm/min	回転数n min ⁻¹	送り速度vf mm/min
炭素鋼 Carbon steels S40C ~ (200HB 以下)	※JP4120 CY9020 CY250	150~250	BT40	0.15 ~ 0.6	3,500	4,200	2,800	3,360	2,330	2,800	1,430	1,720
				vc=220m/min ap ≤ 1.0 mm ae=0.3DC								
			BT50	0.1 ~ 0.3	3,500	650	2,800	880	2,330	720	1,430	540
				vc=220m/min ap=0.5DC ae=0.3DC								
合金鋼 Alloy steels SKD, SKT (200 ~ 250HB)	JP4120 CY9020 CY250	120~200	BT40	0.15 ~ 0.6	3,180	3,820	2,550	3,060	2,120	2,550	1,270	1,530
				vc=200m/min ap ≤ 1.0 mm ae=0.3DC								
			BT50	0.08 ~ 0.3	3,180	540	2,550	660	2,120	530	1,270	410
				vc=200m/min ap=0.5DC ae=0.3DC								
合金鋼 Alloy steels SCM, SNCM (25 ~ 35HRC)	JP4120 CY9020 CY250	60~120	BT40	0.08 ~ 0.6	2,070	2,500	1,660	2,000	1,380	1,650	870	1,050
				vc=130m/min ap ≤ 1.0 mm ae=0.3DC								
			BT50	0.05 ~ 0.3	2,070	440	1,660	540	1,380	460	870	330
				vc=130m/min ap=0.5DC ae=0.3DC								
合金鋼 プリハードン鋼 Alloy steels, Pre-hardened steels (40 ~ 45HRC)	JP4120 CY9020 CY250	50~100	BT40	0.07 ~ 0.6	1,110	1,330	890	1,070	740	900	560	670
				vc=70m/min ap ≤ 1.0 mm ae=0.3DC								
			BT50	0.05 ~ 0.3	1,110	150	890	200	740	200	560	100
				vc=70m/min ap=0.5DC ae=0.3DC								
鋳鉄 Cast irons FC200, FC300, GM241 (150HB)	JP4120 CY9020 CY250	120~240	BT40	0.15 ~ 1.2	3,500	4,200	2,800	3,360	2,230	2,800	1,430	1,720
				vc=220m/min ap ≤ 1.0 mm ae=0.3DC								
			BT50	0.1 ~ 0.3	3,500	650	2,800	900	2,230	900	1,430	540
				vc=220m/min ap=0.5DC ae=0.3DC								

【注意】 [Note]

- この切削条件表は切削条件の目安を示すものです。実際の加工では加工形状、目的、使用機械等により条件を調整してください。
These conditions are for general guidance; in actual machining conditions adjust the parameters according to your actual machine and work-piece conditions.
- 工具突出し量は標準形の首下長さ(カタログのLH)です。
Overhang is the length below the chuck (LH).
- 高速マシンの回転数は次式にて算出しています。
RPM for high-speed machines is calculated using the following formula.

$$\text{回転数} = \frac{500 \times \text{※最大実切削速度}}{\pi \times \sqrt{2 \times RE \times a_p - a_p^2}} \quad \text{Revolution Speed} = \frac{500 \times \text{※ Actual Maximum Cutting Speed}}{\pi \times \sqrt{2 \times RE \times a_p - a_p^2}}$$

RE: ボール半径 Radius of the ball ap: 軸方向切込み量 Axial depth of cut π: 円周率 Circumference ratio

- ※最大実切削速度について。 Actual Maximum Cutting Speed

最大実切削速度: ap=0.5mm及び1mmにおける被削材との接触部の最大速度です。
Actual Maximum Cutting Speed: Maximum Cutting Speed at boundary of contact part with work material under the above recommended cutting condition (ap=0.5mm and 1mm)

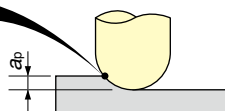

- 等高線加工をする場合、高速マシンの条件を推奨します。
Cutting conditions on high-speed machine tools are recommended for contouring path milling.
- ポケット加工等にて傾斜切込みを行う場合、角度は3~5°を推奨します。送り量は70%を目安にしてください。鋼の場合、切りくずが分断されず飛散する可能性がありますので機械にカバー(スブラッシュガード等)がない場合危険です。高硬度材の場合は3°未満に設定してください。
3 ~ 5° slant milling is recommended for pocketing using a 70% feed rate, please reduce slant angle to below 3° for harder materials. Please use machine guards when cutting steel due to flying chips.

アルファボールエンドミル BCF

BCF-S-L

ロング刃形
Long

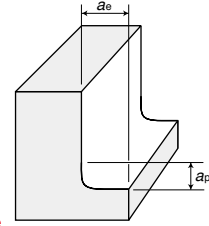

<深い肩削り L/D=4以上> Deep Side Milling L/D = 4 or more

※赤字は第一推奨材種です。
Red indicates primary recommended grade.

被削材 Work material	推奨材種 Recommended grade	切削速度 m/min Cutting speed	一刃当りの送り mm/t Feed rate	φ 20		φ 25		φ 30		φ 40	
				回転数n min ⁻¹	送り速度vf mm/min	回転数n min ⁻¹	送り速度vf mm/min	回転数n min ⁻¹	送り速度vf mm/min	回転数n min ⁻¹	送り速度vf mm/min
炭素鋼 Carbon steels S40C ~ (200HB 以下)	※JP4120 CY250 CY9020	120 ~ 200	0.08 ~ 0.2	2,700	420	2,160	530	1,800	440	1,110	420
				vc=170m/min				vc=140m/min			
				ap=1.2DC ae=0.1DC							
合金鋼 Alloy steels SCM, SNCM (200 ~ 250HB)	JP4120 CY250 CY9020	120 ~ 200	0.06 ~ 0.2	2,550	320	2,040	430	1,700	350	1,270	410
				vc=160m/min				vc=130m/min			
				ap=1.2DC ae=0.1DC							
合金鋼 Alloy steels SKD, SKT (25 ~ 35HRC)	JP4120 CY250 CY9020	100 ~ 160	0.05 ~ 0.15	1,750	220	1,400	330	1,170	270	790	300
				vc=110m/min				vc=100m/min			
				ap=1.2DC ae=0.1DC							
合金鋼 プリハードン鋼 Alloy steels, Pre-hardened steels (40 ~ 45HRC)	JP4120 CY250 CY9020	60 ~ 120	0.04 ~ 0.13	960	70	760	100	640	100	480	90
				vc=60m/min				vc=100m/min			
				ap=1.2DC ae=0.1DC							
鋳鉄 Cast irons FC200, FC300, GM241 (150HB)	JP4120 CY250 CY9020	140 ~ 220	0.08 ~ 0.2	2,700	420	2,160	530	1,800	440	1,110	420
				vc=170m/min				vc=140m/min			
				ap=1.2DC ae=0.1DC							

刃先交換式工具
ボールエンドミル

BCF-S-S

レギュラー形
Regular

BCF-S-L

ロング刃形
Long

BCF-S-E

ロングシャング形
Long Shank

BCF-S-TE

テーパネックロングシャング形
Taper Neck Long Shank

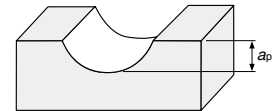

<溝削り> Slotting ※赤字は第一推奨材種です。Red indicates primary recommended grade.

被削材 Work material	推奨材種 Recommended grade	切削速度 m/min Cutting speed	一刃当りの送り mm/t Feed rate	φ 20		φ 25		φ 30		φ 40	
				回転数n min ⁻¹	送り速度vf mm/min	回転数n min ⁻¹	送り速度vf mm/min	回転数n min ⁻¹	送り速度vf mm/min	回転数n min ⁻¹	送り速度vf mm/min
炭素鋼 Carbon steels S40C ~ (200HB 以下)	※JP4120 CY250 CY9020	150 ~ 250	0.06 ~ 0.2	3,500	440	2,800	550	2,330	720	1,430	440
				vc=220m/min				vc=180m/min			
				ap=0.3DC							
合金鋼 Alloy steels SCM, SNCM (200 ~ 250HB)	JP4120 CY250 CY9020	150 ~ 230	0.05 ~ 0.2	3,180	330	2,550	450	2,120	420	1,270	340
				vc=200m/min				vc=160m/min			
				ap=0.3DC							
合金鋼 Alloy steels SKD, SKT (25 ~ 35HRC)	JP4120 CY250 CY9020	100 ~ 160	0.03 ~ 0.15	2,070	110	1,660	210	1,380	180	870	170
				vc=130m/min				vc=110m/min			
				ap=0.3DC							
合金鋼 プリハードン鋼 Alloy steels, Pre-hardened steels (40 ~ 45HRC)	JP4120 CY250 CY9020	60 ~ 120	0.02 ~ 0.13	1,100	50	890	80	740	80	560	100
				vc=70m/min				vc=100m/min			
				ap=0.3DC							
鋳鉄 Cast irons FC200, FC300, GM241 (150HB)	JP4120 CY250 CY9020	140 ~ 240	0.06 ~ 0.2	3,500	440	2,800	660	2,330	540	1,430	540
				vc=220m/min				vc=180m/min			
				ap=0.3DC							

【注意】①この切削条件表は切削条件の目安を示すものです。実際の加工では加工形状、目的、使用機械等により条件を調整してください。

②ロング刃形については上記条件の回転数、送りを70%減じてご使用ください。

③ロングシャング形については外径に関係なく、n=700min⁻¹, vf=210mm/min, ap=0.1DC, ae=0.3DCを目安にしてください。

【Note】① These conditions are for general guidance; in actual machining conditions adjust the parameters according to your actual machine and work-piece conditions.

② For long type please reduce speed and feed by 70%.

③ In case of using Long Shank Type, no relation to diameters, basic conditions are : n=700min⁻¹, vf=210mm/min, ap=0.1DC, ae=0.3DC.

BCFM

モジュラー形
Modular

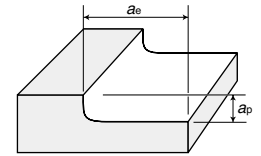

<低切込・高速・高送り切削>

Low depth of cut, High speed, High feed ※赤字は第一推奨材種です。Red indicates primary recommended grade.

被削材 Work material	推奨材種 Recommended grade	※最大実切削速度 v_c m/min ※Actual maximum cutting speed	一刃当りの送り f_z mm/t Feed rate	φ16		φ20		φ25		φ30 (32)	
				回転数 n min ⁻¹	送り速度 v_f mm/min	回転数 n min ⁻¹	送り速度 v_f mm/min	回転数 n min ⁻¹	送り速度 v_f mm/min	回転数 n min ⁻¹	送り速度 v_f mm/min
炭素鋼 Carbon steels S45C~ (220HB以下)	※JP4120 CY9020 CY250	220 (150~250)	0.15~0.6	4,380	1,750	3,500	4,200	2,800	3,360	2,330	2,800
				$v_c=220\text{m/min } a_p \leq 0.7\text{mm } a_e=0.1\text{DC}$		$v_c=220\text{m/min } a_p \leq 1.0\text{mm } a_e=0.1\text{DC}$					
合金鋼 Alloy steels SKD,SKT (200~250HB)	JP4120 CY9020 CY250	200 (120~200)	0.15~0.6	3,980	1,590	3,180	3,820	2,550	3,060	2,120	2,550
				$v_c=200\text{m/min } a_p \leq 0.7\text{mm } a_e=0.1\text{DC}$		$v_c=200\text{m/min } a_p \leq 1.0\text{mm } a_e=0.1\text{DC}$					
合金鋼 Alloy steels SCM,SNM (25~35HRC)	JP4120 CY9020 CY250	130 (60~130)	0.08~0.6	2,590	830	2,070	2,500	1,660	2,000	1,380	1,605
				$v_c=130\text{m/min } a_p \leq 0.5\text{mm } a_e=0.1\text{DC}$		$v_c=130\text{m/min } a_p \leq 1.0\text{mm } a_e=0.1\text{DC}$					
合金鋼・プリハードン鋼 Alloy & Pre-hardened steels (40~45HRC)	JP4120 CY9020 CY250	70 (50~100)	0.07~0.6	1,390	420	1,110	1,330	890	1,070	740	900
				$v_c=70\text{m/min } a_p \leq 0.5\text{mm } a_e=0.1\text{DC}$		$v_c=70\text{m/min } a_p \leq 1.0\text{mm } a_e=0.1\text{DC}$					
鋳鉄 Cast irons (150HB) FC200, FC300, GM241	JP4120 CY9020 CY250	220 (120~240)	0.15~0.6	4,380	1,750	3,500	4,200	2,800	3,360	2,230	2,800
				$v_c=220\text{m/min } a_p \leq 0.7\text{mm } a_e=0.15\text{DC}$		$v_c=220\text{m/min } a_p \leq 1.0\text{mm } a_e=0.15\text{DC}$					

【注意】

- この切削条件表は切削条件の目安を示すものです。実際の加工では加工形状、目的、使用機械等により条件を調整してください。
- モジュラーミル用BT30アーバご使用の際は、標準切削条件表を目安に加工条件を決定してください。
加工状況により振動が懸念される場合は、1.切り込み深さ(a_p)を低減する 2.一刃当りの送り(f_z)を低減する方法で調整下さい。
- 高速マシンの回転数は次式にて算出しています。

$$\text{回転数} = \frac{500 \times \text{※最大実切削速度}}{\pi \times \sqrt{2 \times \text{RE} \times a_p - a_p^2}}$$

RE : ボール半径
 π : 円周率
 a_p : 軸方向切込み量

- ※最大実切削速度について。

最大実切削速度 : $a_p=0.5\text{mm}$ 及び 1mm における被削材との接触部の最大速度です。

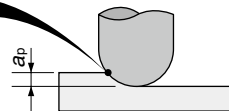

- 等線加工をする場合、高速マシンの条件を推奨します。
- ポケット加工等にて傾斜切込みを行う場合、角度は3~5°を推奨します。送りは70%を目安にしてください。鋼の場合、切りくずが分断されず飛散する可能性がありますので機械にカバー(スブラッシュカード等)がない場合危険です。高硬度材の場合は3°未満に設定してください。

【Note】

- These conditions are for general guidance; in actual machining conditions adjust the parameters according to your actual machine and work-piece conditions.
- When using the BT30 arbor for modular mills, determine the cutting conditions using the standard cutting conditions table as a general guide.
If vibrations are a concern due to the cutting conditions, adjust conditions by 1.reducing cutting depth (a_p) or 2.reducing per-flute feed rate (f_z).
- RPM for high-speed machines is calculated using the following formula.

$$\text{Revolution Speed} = \frac{500 \times \text{※Actual Maximum Cutting Speed}}{\pi \times \sqrt{2 \times \text{RE} \times a_p - a_p^2}}$$

RE : Radius of the ball
 π : Circumference ratio
 a_p : Axial depth of cut

- ※Actual Maximum Cutting Speed.

Actual Maximum Cutting Speed :
Maximum Cutting Speed at boundary of contact part with work material under the above recommended cutting condition ($a_p=0.5\text{mm}$ and 1mm)

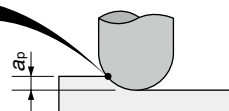

- Cutting conditions on high-speed machines are recommended for contour path milling.
- 3~5° ramp milling is recommended for pocketing using a 70% feed rate, please reduce the ramp angle to below 3° for harder materials. Please always use machine guards.

Ball End Mill for Heavy Duty ASB

アルファスーパーボールエンドミル (重切削用) ASB

- 快削形重切削用ボールエンドミル。
 - ダブルクランプ機構により強固にインサートを固定。
 - 新鋼種のボディで耐久性大幅アップ。
- ・ Ball end mill for light-cutting type roughing.
 ・ Double-clamp mechanism firmly holds inserts.
 ・ New type of steel greatly improves durability.

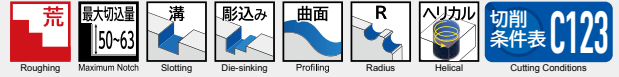

ASB ○○○○□○○○□ (-LH) シャンクタイプ形 Shank type

○は数字、□は英文字が入ります。
 Numeric figure in a circle and Alphabetical character comes in a square

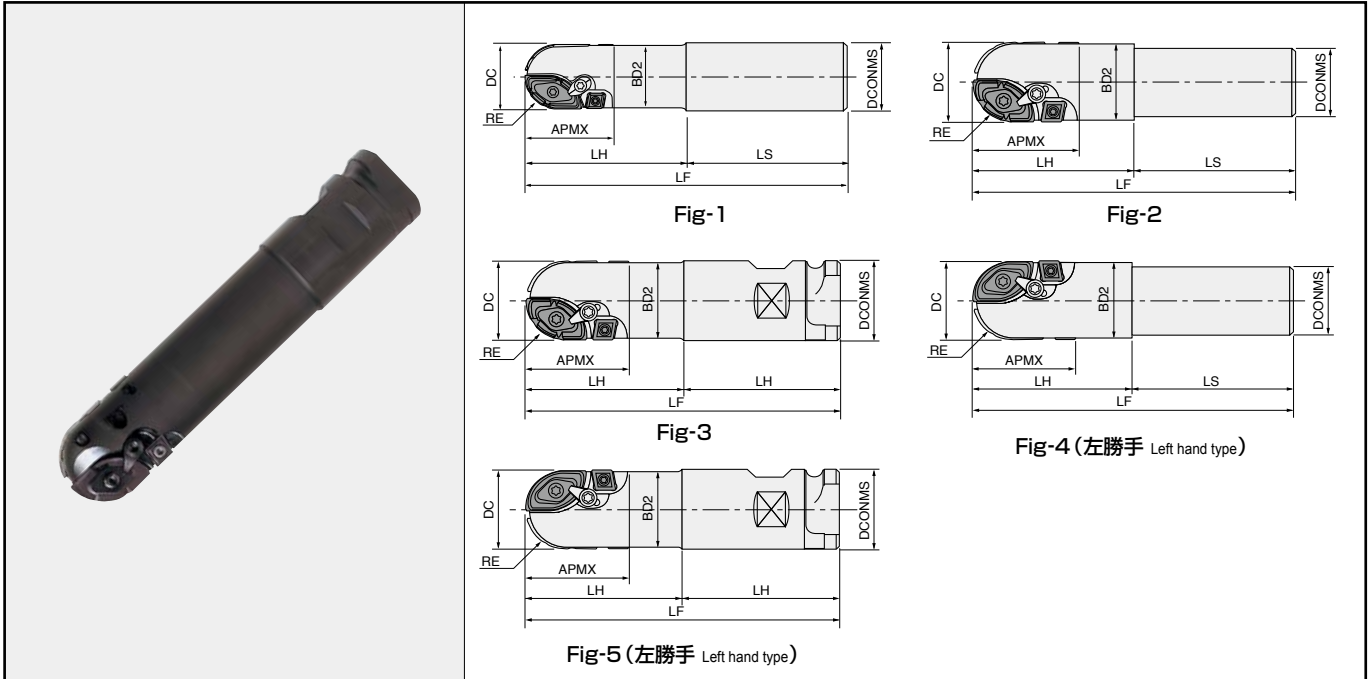

刃先交換式工具
ボールエンドミル

商品コード Item code	在庫 Stock	寸法 Size (mm)								適用インサート Inserts						形状 Shape	希望小売 価格(円) Suggested retail price (¥)
		DC	RE	LF	DCONMS	BD2	APMX	LH	LS	親刃 Main insert		子刃 Sub insert		外周刃 Peripheral insert			
										商品コード Item code	刃数 Flutes	商品コード Item code	刃数 Flutes	商品コード Item code	刃数 Flutes		
ASB4050S42S	●	40	20	200	42	38.6	50	100	100	ZPET200CE	1	ZPET200SK	1	CPMT090308	2	66,160	
ASB4050S42L	●			250				150		ZPET200CE-N		ZPET200SK-N				72,970	
ASB5063S42S	●	50	25	200	47.7	63	150	100	200	ZPET250CE	1	ZPET250SK	1	CPMT120408	2	72,970	
ASB5063S42L	●			250						ZPET250CE-N		ZPET250SK-N				80,240	
ASB5063S42E	●			350				ZPET250CE-N2	ZPET250SK-N2	82,000							
ASB5063C508S	●			200				ZPET250CE-N3	ZPET250SK-N3	80,240							
ASB5063C508L	●			250			170	80							88,450		
ASB5063S42S-LH		50	25	200	47.7	63	150	100	200	ZPET250CE-LH	1	ZPET250SK-LH	1		2	—	
ASB5063S42L-LH				250												100	—
ASB5063S42E-LH				350				200	—								
ASB5063C508S-LH				200				120	—								
ASB5063C508L-LH				250				170	80							—	

●印：標準在庫品です。 ●：Stocked items. 無印：弊社営業へお問合せください。 No mark：Contact with our sales department.

Ball End Mill for Heavy Duty ASB

アルファスーパーボールエンドミル (重切削用) ASB

■ インサート Inserts

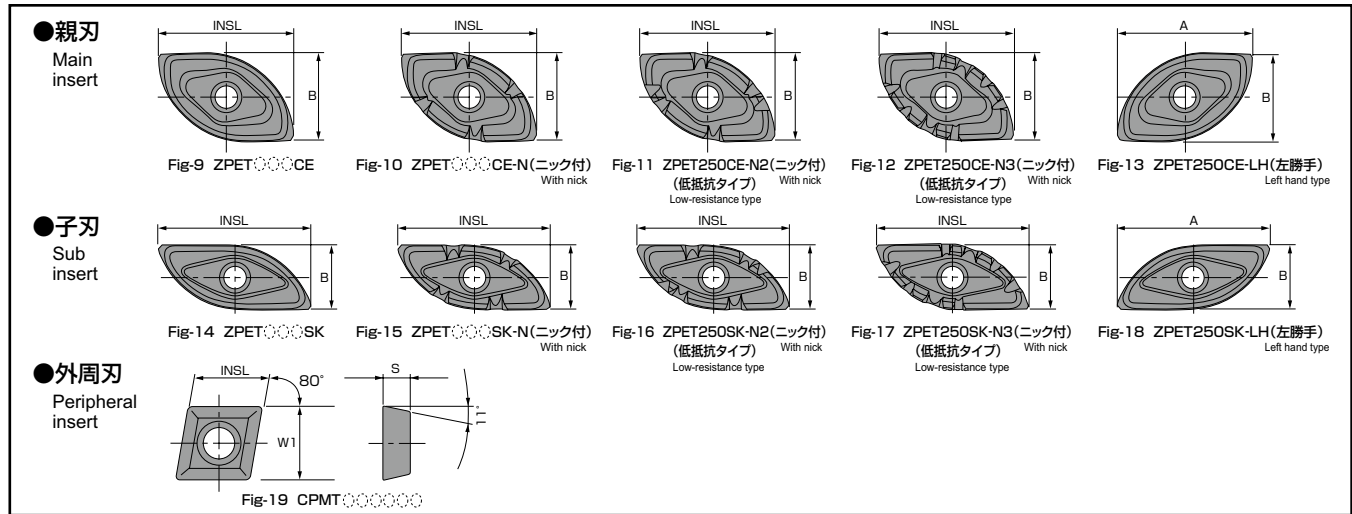

P	鋼 Carbon steels									■ : 一般切削・第一推奨 General cutting, First recommended					
	K	FC・FCD Cast irons									□ : 一般切削・第二推奨 General cutting, Second recommended				
H		高硬度材 Hardened steels													
	商品コード Item code			精度 Tolerance class	Aコーティング AJ Coating						寸法 Size(mm)			形状 Shape	希望小売価格(円) Suggested retail price (¥)
			JP4105		JP4120	JS4060	ATH08M	HC844	CY250	CY9020	INSL	B W1	S		JP4105 JP4120 JS4060 ATH08M
親刃 Main insert	ZPET200CE		●	●	●					35.4	20.3	—	Fig-9	7,920	—
	ZPET200CE-N(ニック付 With nick)			●	●	—						—	Fig-10	7,920	—
	ZPET250CE		●	●	●		●			39.3	26	—	Fig-9	8,970	8,160
	ZPET250CE-N(ニック付 With nick)			●	●		●	●	—			Fig-10	8,970	8,160	
	ZPET250CE-N2(ニック付 With nick)			—	—	—	●	—		—	Fig-11	—	8,160		
	ZPET250CE-N3(ニック付 With nick)				●	—	—	—		—	Fig-12	8,970	—		
ZPET250CE-LH(左勝手 Left hand type)					—	—	—		—	Fig-13	—	—			
子刃 Sub insert	ZPET200SK		●	●	●				39.9	16.1	—	Fig-14	5,770	—	
	ZPET200SK-N(ニック付 With nick)			●	●	—					—	Fig-15	5,770	—	
	ZPET250SK		●	●	●		●		44.6	19.2	—	Fig-14	6,740	6,120	
	ZPET250SK-N(ニック付 With nick)			●	●		●	●			—	Fig-15	6,740	6,120	
	ZPET250SK-N2(ニック付 With nick)			—	—	—	●	—		—	Fig-16	—	6,120		
	ZPET250SK-N3(ニック付 With nick)				●	—	—	—		—	Fig-17	6,740	—		
ZPET250SK-LH(左勝手 Left hand type)					—	—	—		—	Fig-18	—	—			
外周刃 Peripheral insert	CPMT090308						●	●	—	9.525	9.525	3.18	Fig-19	—	920
	CPMT120408						●	●	—	12.7	12.7	4.76		—	1,690

【注意】JSコーティングは通電式タッチセンサーに反応しませんのでご注意ください。【Note】 Please note that the JS Coating does not cause a reaction in conductive touch sensors.

■ MT5シャंक専用アーバ規格 MT5 Shank Arbor

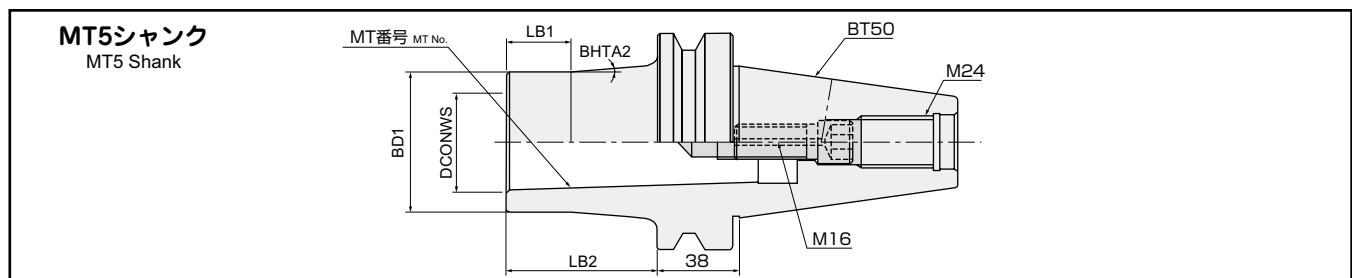

商品コード Item code	在庫 Stock	寸法 Size (mm)						適用カット Cutter body	希望小売価格(円) Suggested retail price (¥)
		MT番号 MT No.	BD1	DCONWS	LB2	LB1	BHTA		
BT50-MTB503-70-65	●	MT5	65	44.399	70	30	5°	ASB5063MT5S-M16 ASB5063MT5L-M16	103,230

【注意】レンチ、ツールクランパは別途販売品となります。【Note】 Wrench and Tool Clamper are sold separately.

●印：標準在庫品です。 無印：弊社営業へお問合せください。 —印：製作致しません。
 ● : Stocked items. No mark : Contact with our sales department. — : Not manufactured.

各インサートの使い分け (アルファボールφ 50 の FC, FCD の切削領域)

How to select of inserts (Cutting range of ball φ50 for FC, FCD)

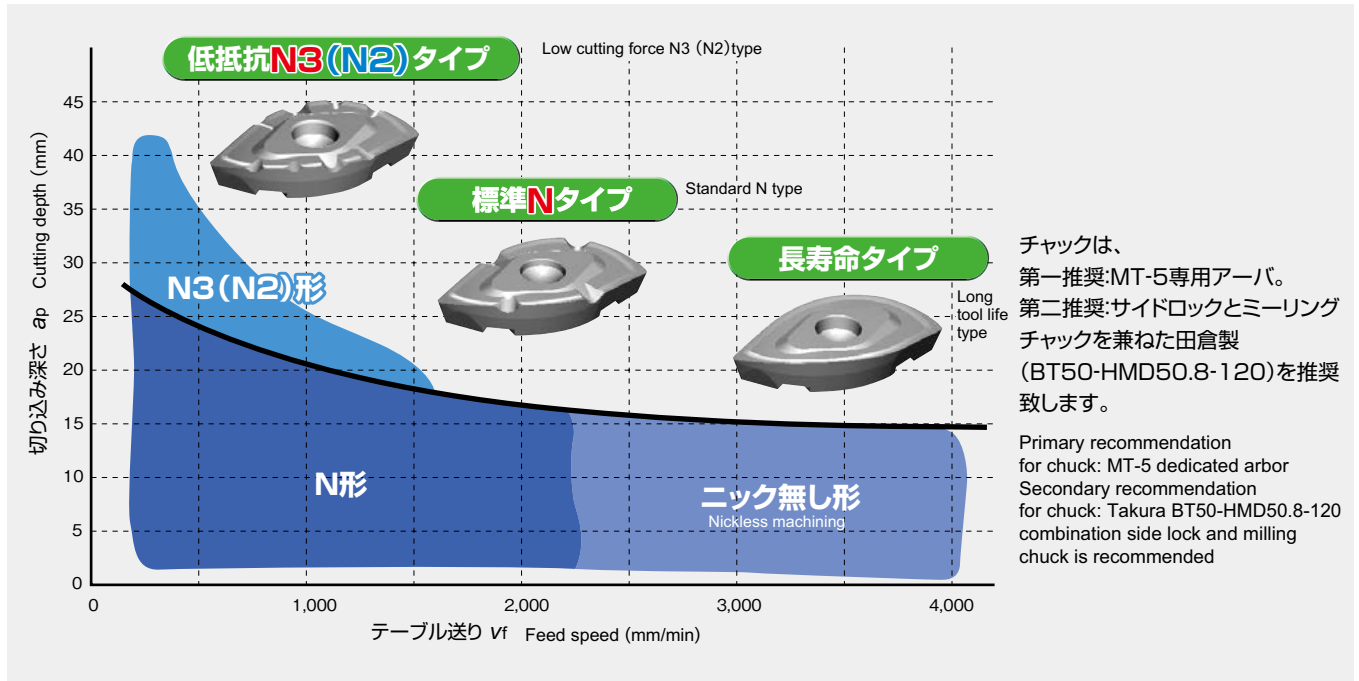

標準切削条件表 Recommended cutting conditions

※赤字は第一推奨材種です。Red indicates primary recommended grade.

被削材 Work material	推奨材種 Recommended grade	切削条件 Cutting conditions	肩削り Side milling	深い肩削り Depth side milling	溝削り Slotting
炭素鋼・合金鋼 Carbon & Alloy steels 30HRC以下	※ JS4060	切削速度 V_c Cutting speed (m/min)	200(150~250)	150(120~200)	150(120~200)
		1刃当りの送り f_z Feed rate per flute (mm/t)	0.2(0.1~0.4)	0.15(0.1~0.3)	0.12(0.08~0.2)
		切込み深 a_p Depth of cut (mm)	0.3DC	1DC	0.5DC
		切込み幅 a_e Cutting width (mm)	0.2DC	0.1DC	1DC
プリハードン鋼 Pre-hardened steels 50HRC以下	JP4120 ATH08M	切削速度 V_c Cutting speed (m/min)	80(60~100)	60(50~80)	60(50~80)
		1刃当りの送り f_z Feed rate per flute (mm/t)	0.15(0.05~0.3)	0.1(0.05~0.2)	0.08(0.04~0.15)
		切込み深 a_p Depth of cut (mm)	0.3DC	1DC	0.5DC
		切込み幅 a_e Cutting width (mm)	0.2DC	0.1DC	1DC
鋳鉄 Cast irons 200HB以下	JS4060 JP4120	切削速度 V_c Cutting speed (m/min)	200(150~250)	180(140~220)	180(140~220)
		1刃当りの送り f_z Feed rate per flute (mm/t)	0.3(0.2~0.5)	0.2(0.1~0.4)	0.15(0.1~0.3)
		切込み深 a_p Depth of cut (mm)	0.3DC	1DC	0.5DC
		切込み幅 a_e Cutting width (mm)	0.2DC	0.1DC	1DC
焼入れ鋼 Hardened steels 50~60HRC	JP4105 ATH08M	切削速度 V_c Cutting speed (m/min)	80(60~100)		
		1刃当りの送り f_z Feed rate per flute (mm/t)	0.08(0.04~0.15)		
		切込み深 a_p Depth of cut (mm)	0.1DC		
		切込み幅 a_e Cutting width (mm)	0.3DC		

【注意】

切削速度、送り速度はこの条件表の値を中央値として、下記に示す状況に合わせて調整してください。

- (1) ロング刃形、ロングシャンク形については条件表の値の70%でご使用ください。
- (2) 機械の主軸力15kw以下でご使用の場合は、回転数:60%、送り速度:35%でご使用ください。
(上記切削条件表は22kw以上の場合です。)
- (3) JSコーティングは通電式タッチセンサーに反応しませんのでご注意ください。
- (4) 下記に単位時間当たりの切りくず排出量Qを示します。

$$Q(\text{cm}^3/\text{min}) = a_p(\text{mm}) \times a_e(\text{mm}) \times v_f(\text{mm}/\text{min})/1000$$

【Note】

These conditions are for general guidance; in actual machining conditions adjust the parameters according to your actual machine and work-piece conditions.

- (1) For long type please reduce speed and feed by 70%.
- (2) If using a machine with less than 15kw power reduce data to 60% speed and 35% feed, cutting data listed is based on or over 22kw.
- (3) Please note that the JS Coating does not cause a reaction in conductive touch sensors.
- (4) The following formula shows the chip removal volume (Q) per unit time.

$$Q(\text{cm}^3/\text{min}) = a_p(\text{mm}) \times a_e(\text{mm}) \times v_f(\text{mm}/\text{min})/1000$$

Ball End Mill BCU

アルファボールエンドミル (重切削用) BCU

- 重切削用、ダブルキー溝付きの肉厚大形インサート。
- ニック付きインサートで深切込み加工もできます。
- ・ For heavy cutting. Double-key grooved thick-body inserts.
- ・ Nicked inserts enable deep plunge cutting.

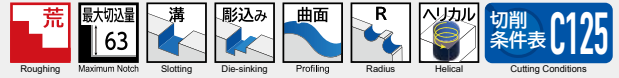

BCU5063

○は数字、□は英文字が入ります。
Numeric figure in a circle ○ and Alphabetical character comes in a square □

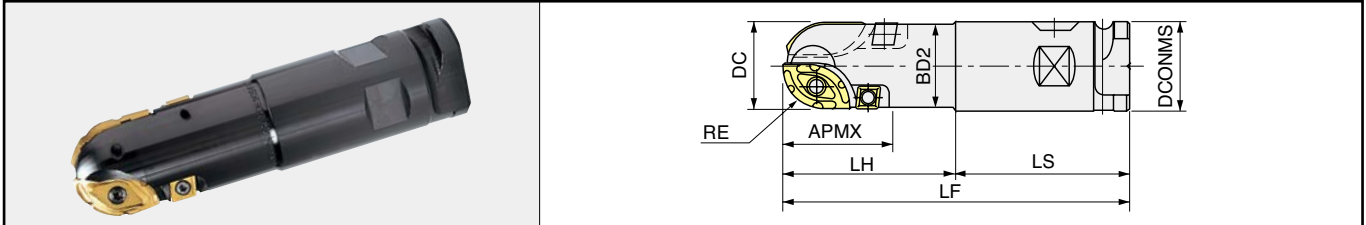

商品コード Item code	在庫 Stock	寸法 Size (mm)								適用インサート Inserts						希望小売価格 (円) Suggested retail price (¥)
		DC	RE	LF	DCONMS	BD2	APMX	LH	LS	親刃 Main insert 商品コード Item code	刃数 Flutes	子刃 Sub insert 商品コード Item code	刃数 Flutes	外周刃 Peripheral insert 商品コード Item code	刃数 Flutes	
BCU5063S42S	●	50	25	200	42	47.5	63	100	100	ZCET250CE ZCET250CE-N	1	ZCET250SK ZCET250SK-N	1	CPMT120408	2	81,070
BCU5063S42L	●	50	25	250	42	47.5	63	150	100							89,150
BCU5063S42E	●	50	25	350	42	47.5	63	150	200							93,730
BCU5063C508S	●	50	25	200	50.8	47.5	63	100	100							89,150
BCU5063C508L	●	50	25	250	50.8	47.5	63	150	100							98,190

BCU5063

○は数字、□は英文字が入ります。
Numeric figure in a circle ○ and Alphabetical character comes in a square □

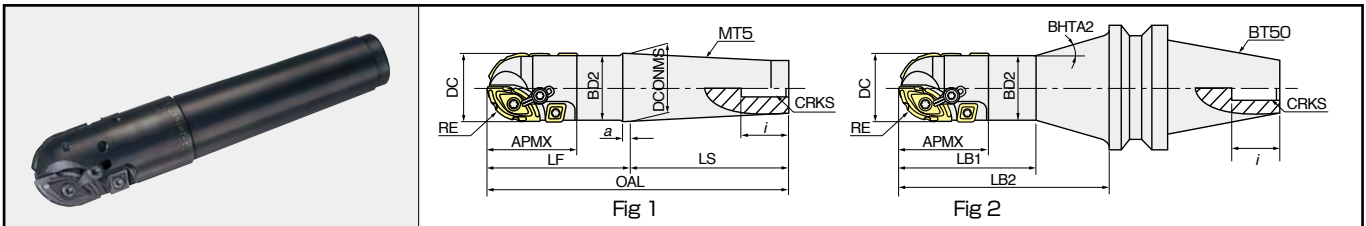

商品コード Item code	在庫 Stock	寸法 Size (mm)												適用インサート Inserts						形状 Shape	希望小売価格 (円) Suggested retail price (¥)						
		DC	RE	APMX	OAL LB2	LF LB1	LS	DCONMS	BD2	a	i	CRKS	BHTA2	親刃 Main insert 商品コード Item code	刃数 Flutes	子刃 Sub insert 商品コード Item code	刃数 Flutes	外周刃 Peripheral insert 商品コード Item code	刃数 Flutes								
BCU5063MT5S	●	50	25	63	249.5	120	129.5	44.399	47.5	6.5	32	M16	—	ZCET 250CE	1	ZCET 250SK	1	CPMT 120408	2	Fig-1	120,820						
BCU5063MT5L	●	50	25	63	279.5	150	129.5	44.399	47.5	6.5	32	M16	—							Fig-1	132,550						
BCU5063BT50S	●	50	25	63	170	100	—	—	47.5	—	45	M24	15°							ZCET 250CE-N	1	ZCET 250SK-N	1	CPMT 120408	2	Fig-2	197,070
BCU5063BT50L	●	50	25	63	220	150	—	—	47.5	—	45	M24	15°													Fig-2	217,010

部品番号 Parts

部品名 Parts	クランプねじ Clamp screw						クランプ駒 セット Clamp piece set		レンチ Wrench				ねじ焼き付き防止剤 Screw anti-seizure agent	
形状 Shape														
適用カット Cutter body	R 刃 R insert	締付 トルク Fastening torque (N·m)	希望小売 価格(円) Suggested retail price (¥)	外周刃 Peripheral insert	締付 トルク Fastening torque (N·m)	希望小売 価格(円) Suggested retail price (¥)	商品コード Item code	希望小売 価格(円) Suggested retail price (¥)	R 刃 R insert	希望小売 価格(円) Suggested retail price (¥)	外周刃 Peripheral insert	希望小売 価格(円) Suggested retail price (¥)	希望小売 価格(円) Suggested retail price (¥)	
BCU5063S42S/L/E BCU5063C508S/L							—	—						
BCU5063MT5S BCU5063MT5L	571-141A	9.8	870	263-143	4.9	870	CB8-161	2,030	105-T30A	2,120	105-T20	2,120	P-37	1,010
BCU5063BT50S BCU5063BT50L														

【注意】クランプねじは消耗品です。使用環境により交換寿命は変化しますので早めの交換をお願い致します。クランプねじはR刃用の予備が2本付属します。
【Note】The clamp screw is a consumable part. Since replacement life depends on the use environment, it is recommended that it be replaced at an early stage. Includes two spare clamp screws for R insert.

●印：標準在庫品です。●：Stocked items. 無印：弊社営業へお問合せください。No mark：Contact with our sales department. 一印：製作いたしません。—：No Manufactured.

MT5シャंक専用アーバ規格 MT5 Shank Arbor

MT5シャंक MT5 Shank								適用カッタ Cutter body	希望小売価格 (円) Suggested retail price (¥)
商品コード Item code	在庫 Stock	寸法 Size (mm)						適用カッタ Cutter body	希望小売価格 (円) Suggested retail price (¥)
		MT番号 MT No.	BD1	DCONWS	LB2	LB1	BHTA2		
BT50-MTB503-70-65	●	MT5	65	44.399	70	30	5°	BCU5063MT5S BCU5063MT5L	103,230

【注意】 レンチは14六角レンチをご使用ください。ツールクランパ(NCL-BT50)はC116ページを参照して下さい。
【Note】 Please use 14mm hexagon wrench, for Tool clamper (NCL-BT50) please consult page C116.

インサート Inserts

親刃 Main insert		子刃 Sub insert			外周刃 Peripheral insert	
Fig-3 ZCET250CE	Fig-4 ZCET250CE-N (ニック付 With nick)	Fig-5 ZCET250SK	Fig-6 ZCET250SK-N (ニック付 With nick)	Fig-7 CPMT120408		
P 鋼 Carbon steels	K FC・FCD Cast irons				: 一般切削・第一推奨 General cutting, First recommended	
商品コード Item code	精度 Tolerance class	Cコーティング C Coating		Gコーティング G Coating	刃先形状 Shape	希望小売価格 (円) Suggested retail price (¥)
		CY250	CY9020	HC844		
ZCET250CE	E 級 E	●	●	●	Fig-3	10,850
ZCET250CE-N (ニック付 With nick)		●	●	●	Fig-4	10,850
ZCET250SK		●	●	●	Fig-5	8,390
ZCET250SK-N (ニック付 With nick)		●	●	●	Fig-6	8,390
CPMT120408	M 級 M	●	—	●	Fig-7	1,690

標準切削条件表 Recommended cutting conditions

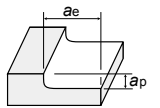

赤字は第1推奨材種です。 Red indicates primary recommended insert grade.

被削材 Work material	推奨材種 Recommended grade	切込み 15×10 mm (ap×ae)			切込み 25×15 mm (ap×ae)			切込み 55×5 mm (ap×ae)		
		回転数 min ⁻¹	送り速度 mm/min	切りくず排出量 cm ³ /min	回転数 min ⁻¹	送り速度 mm/min	切りくず排出量 cm ³ /min	回転数 min ⁻¹	送り速度 mm/min	切りくず排出量 cm ³ /min
炭素鋼・合金鋼 Carbon steels, Alloy steels (250HB以下)	HC844 CY250	1,500	900	135	1,500	500	86.3	800	240	66
		vc=236m/min fz=0.3mm/t			vc=236m/min fz=0.17mm/t			vc=126m/min fz=0.15mm/t		
焼入れ鋼・プリハードン鋼 Hardened steels, Pre-hardened steels (40HRC ~ 45HRC)	CY250 CY9020	450	90	13.5	450	140	24.2	380	90	24.8
		vc=70m/min fz=0.1mm/t			vc=70m/min fz=0.16mm/t			vc=60m/min fz=0.12mm/t		
鋳鉄 Cast irons (200HB以下)	HC844 CY250	1,500	1,500	225	1,500	900	155.4	1,000	400	110
		vc=236m/min fz=0.5mm/t			vc=236m/min fz=0.3mm/t			vc=157m/min fz=0.2mm/t		

【注意】 この切削条件表は切削条件の目安を示すものです。実際の加工では加工形状、目的、使用機械等により条件を調整してください。

- ①ロング刃形、ロングシャंक形については条件表の値の70%でご使用ください。
- ②機械の主軸力15kw以下でご使用の場合は、回転数：60%、送り速度：35%でご使用ください。(上記切削条件表は22kw以上の場合です。)
- ③下記に単位時間当たりの切りくず排出量 Q を示します。

$$Q (\text{cm}^3/\text{min}) = a_p (\text{mm}) \times a_e (\text{mm}) \times v_f (\text{mm}/\text{min}) / 1000$$

【Note】 These conditions are for general guidance; in actual machining conditions adjust the parameters according to your actual machine and work-piece conditions.

- ① For long type please reduce speed and feed by 70%.
- ② If using a machine with less than 15kw power reduce data to 60% speed and 35% feed, cutting data listed is based on or over 22kw.
- ③ The following formula shows the chip removal volume (Q) per unit time.

$$Q (\text{cm}^3/\text{min}) = a_p (\text{mm}) \times a_e (\text{mm}) \times v_f (\text{mm}/\text{min}) / 1000$$



- 取付けR精度±0.01mm、ボール部先端から外周まで、高いR精度を示します。
 - 優れた切れ味、きれいな仕上げ面。中心部切れ刃の刃形の工夫により、優れた仕上げ面粗さが得られます。
 - 長寿命。高性能コーティングインサートにより長寿命です。
- ・ Set up R accuracy : ±0.01mm
 High accuracy is exhibited from the ball tip to the outer circumference.
 ・ Excellent cutting performance and beautiful finish
 Special shape of central cutting flute provides excellent finished surface roughness.
 ・ Long life. High-performance coated inserts provide long life.

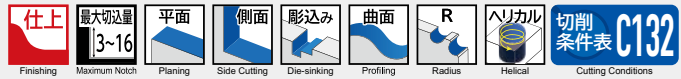

鋼シャンク Steel Shank

ABPF○○S○○(L/L○○○)

○は数字が入ります。 Numeric figure in a circle ○

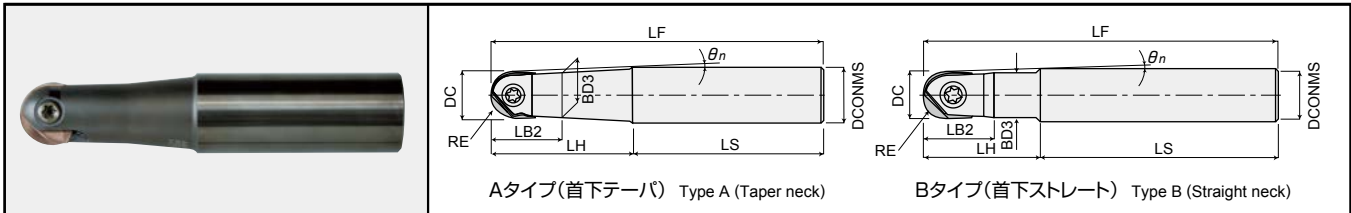

商品コード Item code	在庫 Stock	インサート数 No. of inserts	寸法 Size (mm)									形状 Shape	適用インサート Inserts		希望小売 価格(円) Suggested retail price(¥)
			DC	RE	LF	DCONMS	LB2	LH	BD3	LS	θ _n				
レギュラー Regular	ABPF06S10	●	1	6	3	80	10	15	30	5.4	50	4.3°	A	ZPFG06N-SH ZDFG06N-S	15,730
	ABPF08S12	●	1	8	4	100	12	10	22	7.5	78	6.4°	A	ZPFG080-SH ZDFG080-S	18,430
	ABPF10S12	●	1	10	5	100	12	13	25	9.5	75	2.9°	A	ZPFG100-SH ZDFG100-S	19,240
	ABPF12S12	●	1	12	6	110	12	15	30	11.5	80	—	B	ZPFG120-SH ZDFG120-S	20,070
	ABPF16S20	●	1	16	8	130	20	27	50	15	80	2.8°	A	ZPFG160-SH ZDFG160-S	23,350
	ABPF20S25	●	1	20	10	140	25	35	60	19	80	2.9°	A	ZPFG200-SH ZDFG200-S	26,870
	ABPF25S32	●	1	25	12.5	150	32	43	70	24	80	3.5°	A	ZPFG250-SH ZDFG250-S	41,060
	ABPF30S32	●	1	30	15	160	32	55	80	29	80	1.2°	A	ZPFG300-SH ZDFG300-S	41,060
	ABPF32S32	●	1	32	16	160	32	58	80	31	80	—	B	ZPFG320(-G) ZDFG320-W	41,060
首下ロング Under neck long	ABPF08S12L	●	1	8	4	130	12	10	50	7.5	80	2.5°	A	ZPFG080-SH ZDFG080-S	24,520
	ABPF10S16L	●	1	10	5	150	16	13	50	9.5	100	3.9°	A	ZPFG100-SH ZDFG100-S	27,110
	ABPF12S16L	●	1	12	6	160	16	15	60	10.8	100	2.2°	A	ZPFG120-SH ZDFG120-S	27,570
	ABPF16S20L	●	1	16	8	160	20	27	65	15	95	2.1°	A	ZPFG160-SH ZDFG160-S	29,570
	ABPF20S25L	●	1	20	10	180	25	35	80	19	100	2.1°	A		34,730
	ABPF20S20L120	●	1	20	10	220	20	35	120	19	100	—	B	ZPFG200-SH ZDFG200-S	32,260
	ABPF20S20L150	●	1	20	10	250	20	35	150	19	100	—	B		32,260
	ABPF25S32L	●	1	25	12.5	200	32	43	90	24	110	2.6°	A		49,270
	ABPF25S32L150	●	1	25	12.5	250	32	43	150	24	100	1.5°	B	ZPFG250-SH ZDFG250-S	49,270
	ABPF30S32L	●	1	30	15	220	32	55	100	29	120	0.7°	A		49,270
ABPF30S32L150	●	1	30	15	250	32	55	150	29	100	0.5°	B	ZPFG300-SH ZDFG300-S	49,270	
ABPF30S32L200	●	1	30	15	300	32	55	200	29	100	0.3°	B		49,270	
ABPF32S32L	●	1	32	16	220	32	58	100	31	120	—	B	ZPFG320(-G) ZDFG320-W	49,270	

ABPF○○MT○

○は数字が入ります。 Numeric figure in a circle ○

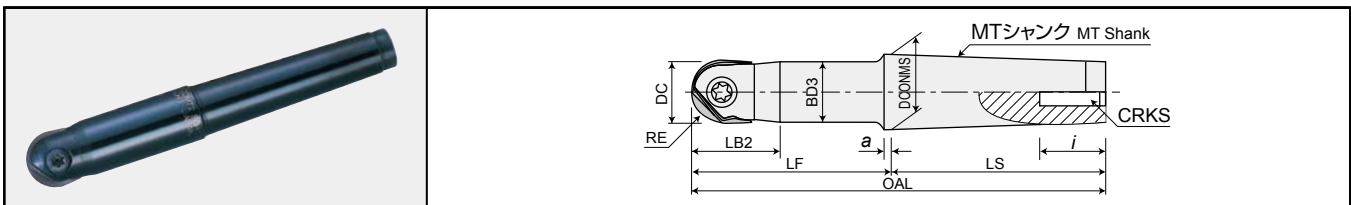

商品コード Item code	在庫 Stock	インサート数 No. of inserts	寸法 Size (mm)											適用インサート Inserts		希望小売 価格(円) Suggested retail price(¥)
			DC	RE	MT番号 MT No.	OAL	LB2	LF	LS	DCONMS	BD3	a	i	CRKS		
ABPF20MT2	●	1	20	10	MT2	129	35	65	64	17.78	19	5	24	M10	ZPFG200-SH ZDFG200-S	40,240
ABPF25MT3	●	1	25	12.5	MT3	166	43	85	81	23.825	24	5	28	M12	ZPFG250-SH ZDFG250-S	53,960
ABPF30MT4	●	1	30	15	MT4	217.5	55	115	102.5	31.267	29	6.5	32	M16	ZPFG300-SH ZDFG300-S	64,060
ABPF32MT4	●	1	32	16	MT4	217.5	58	115	102.5	31.267	31	6.5	32	M16	ZPFG320(-G) ZDFG320-W	64,060

●印：標準在庫品です。 ●： Stocked items. 無印：弊社営業へお問合せください。 No mark : Contact with our sales department.

超硬シャンク Carbide Shank

ABPF○○S○○W(□/□○○○)

○は数字、□は英文字が入ります。
 Numeric figure in a circle ○ and Alphabetical character comes in a square □

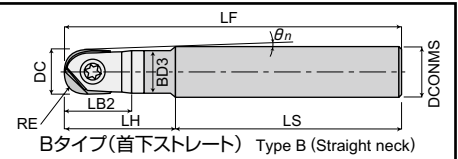
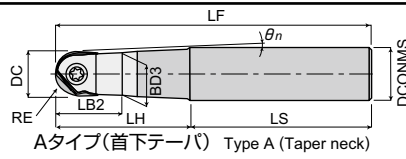

商品コード Item code	在庫 Stock	インサート数 No. of inserts	寸法 Size (mm)									形状 Shape	適用インサート Inserts	希望小売 価格(円) Suggested retail price(¥)
			DC	RE	LF	DCONMS	LB2	LH	BD3	LS	θ_n			
ABPF06S06W	●	1	6	3	90	6	10.3	25	5.5	65	—	B	ZPFG06N-SH	34,960
ABPF06S06WL65	●	1	6	3	120	6	10.3	65	5.5	55	—	B	ZDFG06N-S□	35,910
ABPF08S08W-90-25	●	1	8	4	90	8	25	25	7.5	65	—	B	ZPFG080-SH ZDFG080-S□	42,700
ABPF08S08W	●	1	8	4	100	8	30	30	7.5	70	—	B		43,410
ABPF08S08W-115-50	●	1	8	4	115	8	50	50	7.5	65	—	B		44,120
ABPF08S08WL	●	1	8	4	130	8	65	65	7.5	65	—	B		45,290
ABPF08S08W-140-75	●	1	8	4	140	8	75	75	7.5	65	—	B		45,750
ABPF08S08WL95	●	1	8	4	160	8	95	95	7.5	65	—	B		47,170
ABPF08S08W-175-110	●	1	8	4	175	8	110	110	7.5	65	—	B		51,620
ABPF08S12WLT75	●	1	8	4	140	12	14	75	7.5	65	1.62°	A		—
ABPF10S10W-90-25	●	1	10	5	90	10	18	25	9.5	65	—	B	ZPFG100-SH ZDFG100-S□	44,820
ABPF10S10W	●	1	10	5	100	10	18	35	9.5	65	—	B		45,050
ABPF10S10W-115-50	●	1	10	5	115	10	18	50	9.5	65	—	B		48,930
ABPF10S10WL	●	1	10	5	140	10	18	75	9.5	65	—	B		49,510
ABPF10S10WL95	●	1	10	5	160	10	18	95	9.5	65	—	B		51,740
ABPF10S10W-185-120	●	1	10	5	185	10	18	120	9.5	65	—	B		56,440
ABPF10S10WL140	●	1	10	5	220	10	18	140	9.5	80	—	B		58,420
ABPF10S12WLT75	●	1	10	5	140	12	18	75	9.5	65	0.82°	A		—
ABPF12S12W-95-30	●	1	12	6	95	12	21	30	11.5	65	—	B	ZPFG120-SH ZDFG120-S□	55,020
ABPF12S12W	●	1	12	6	110	12	21	45	11.5	65	—	B		56,780
ABPF12S12W-125-60	●	1	12	6	125	12	21	60	11.5	65	—	B		57,140
ABPF12S12WL	●	1	12	6	150	12	21	85	11.5	65	—	B		59,600
ABPF12S12WL100	●	1	12	6	200	12	21	100	11.5	100	—	B		61,470
ABPF12S12WL120	●	1	12	6	200	12	21	120	11.5	80	—	B		61,470
ABPF12S12WL150	●	1	12	6	220	12	21	150	11.5	70	—	B		64,520
ABPF12S16WLT85	●	1	12	6	150	16	21	85	11.5	65	1.45°	A		—
ABPF16S16W-105-35	●	1	16	8	105	16	27	35	15	70	—	B	ZPFG160-SH ZDFG160-S□	61,940
ABPF16S16W-120-50	●	1	16	8	120	16	27	50	15	70	—	B		69,340
ABPF16S16W60	●	1	16	8	130	16	27	60	15	70	—	B		70,380
ABPF16S16WL80	●	1	16	8	160	16	27	80	15	80	—	B		75,900
ABPF16S16WL100	●	1	16	8	200	16	27	100	15	100	—	B		82,240
ABPF16S16WE	●	1	16	8	200	16	27	120	15	80	—	B		82,240
ABPF16S16WE150	●	1	16	8	220	16	27	150	15	70	—	B		87,980
ABPF16S16W-250-180	●	1	16	8	250	16	27	180	15	70	—	B		99,950
ABPF16S20WLT100	●	1	16	8	165	20	27	100	15	65	1.25°	A	—	
ABPF20S20W-120-40	●	1	20	10	120	20	35	40	19	80	—	B	ZPFG200-SH ZDFG200-S□	78,250
ABPF20S20W-140-60	●	1	20	10	140	20	35	60	19	80	—	B		85,290
ABPF20S20W80	●	1	20	10	160	20	35	80	19	80	—	B		93,380
ABPF20S20WL100	●	1	20	10	220	20	35	100	19	120	—	B		106,520
ABPF20S20WL120	●	1	20	10	220	20	35	120	19	100	—	B		106,520
ABPF20S20WE	●	1	20	10	250	20	35	150	19	100	—	B		113,080
ABPF20S20W-270-190	●	1	20	10	270	20	35	190	19	80	—	B		117,300
ABPF20S20WE220	●	1	20	10	300	20	35	220	19	80	—	B		124,340
ABPF20S25WLT115	●	1	20	10	195	25	35	115	19	80	1.37°	A	—	
ABPF25S25W-130-50	●	1	25	12.5	130	25	43	50	24	80	—	B	ZPFG250-SH ZDFG250-S□	113,670
ABPF25S25W-160-80	●	1	25	12.5	160	25	43	80	24	80	—	B		123,170
ABPF25S25W100	●	1	25	12.5	220	25	43	100	24	120	—	B		132,550
ABPF25S25WL120	●	1	25	12.5	220	25	43	120	24	100	—	B		132,550
ABPF25S25WL150	●	1	25	12.5	250	25	43	150	24	100	—	B		151,320
ABPF25S25WE	●	1	25	12.5	300	25	43	190	24	110	—	B		170,090
ABPF25S25W-300-220	●	1	25	12.5	300	25	43	220	24	80	—	B		170,090
ABPF25S32WLT135	●	1	25	12.5	215	32	43	135	24	80	1.64°	A		—
ABPF30S32W-160-80	●	1	30	15	160	32	55	80	29	80	—	B	ZPFG300-SH ZDFG300-S□	156,010
ABPF30S32W100	●	1	30	15	180	32	55	100	29	80	0.7°	B		158,360
ABPF30S32W120	●	1	30	15	220	32	55	120	29	100	0.6°	B		190,030
ABPF30S32WL150	●	1	30	15	250	32	55	150	29	100	0.4°	B		202,930
ABPF30S32W-260-180	●	1	30	15	260	32	55	180	29	80	—	B		205,280
ABPF30S32W-290-210	●	1	30	15	290	32	55	210	29	80	—	B		228,740
ABPF30S32WE	●	1	30	15	350	32	55	230	29	120	0.3°	B		267,450
ABPF30S32WLT160	●	1	30	15	240	32	55	160	29	80	0.4°	A		—
ABPF32S32W120	●	1	32	16	200	32	58	120	31	80	—	B	ZPFG320-(G)□ ZDFG320-W□	171,260
ABPF32S32WL150	●	1	32	16	250	32	58	150	31	100	—	B		208,800
ABPF32S32WE220	●	1	32	16	300	32	58	220	31	80	—	B		235,780

Indexable Tools Ball End Mills

アルファボールプレジジョン F ABPF

ABPFU○○W○○○ アンダーネックタイプ Under neck type

○は数字が入ります。 Numeric figure in a circle ○

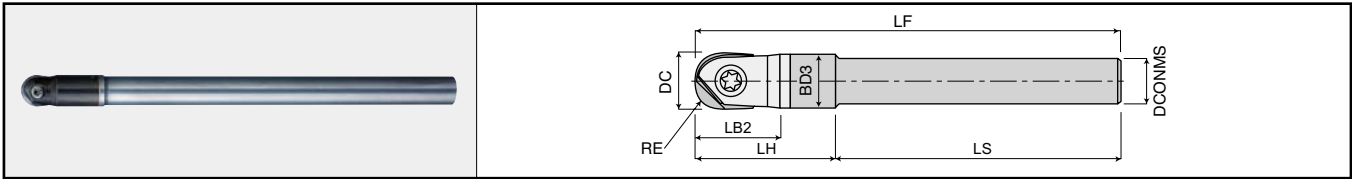

商品コード Item code	在庫 Stock	インサート数 No. of inserts	寸法 Size (mm)								適用インサート Inserts	希望小売 価格(円) Suggested retail price(¥)
			DC	RE	LF	DCONMS	LB2	LH	BD3	LS		
ABPFU16W220	●	1	16	8	220	15	27	39	15	181	ZPFG160-SH ZDFG160-S	81,180
ABPFU20W270	●	1	20	10	270	18	35	51	19	219	ZPFG200-SH ZDFG200-S	107,330
ABPFU25W300	●	1	25	12.5	300	23	43	61	24	239	ZPFG250-SH ZDFG250-S	161,880
ABPFU30W300	●	1	30	15	300	28	55	73	29	227	ZPFG300-SH ZDFG300-S	232,260

モジュラーミルタイプ Modular Mill type

○は数字が入ります。 Numeric figure in a circle ○

ABPFM○○(-M○○H)

モジュラーミル用シャンクはD2頁を、締め付けトルクについてはD5頁を参照ください。
Refer page D2 about the shanks for Modular Mill, Refer page D5 about tightening torque

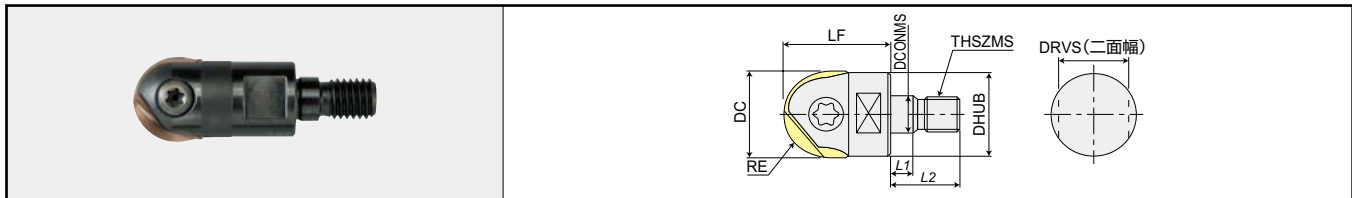

商品コード Item code	在庫 Stock	インサート数 No. of inserts	寸法 Size(mm)											適用インサート Inserts	希望小売 価格(円) Suggested retail price(¥)
			DC	RE	LF	DCONMS	THSZMS	DHUB	L1	L2	DRVS				
ABPFM10	●	1	10	5	26	6.5	M6	9.8	5.5	14.5	7	ZPFG100-SH ZDFG100-S	19,240		
ABPFM12	●	1	12	6	26	6.5	M6	9.8	5.5	14.5	7	ZPFG120-SH ZDFG120-S	20,070		
ABPFM16	●	1	16	8	32	8.5	M8	12.8	5.5	17	10	ZPFG160-SH ZDFG160-S	23,350		
ABPFM20	●	1	20	10	38	10.5	M10	17.8	5.5	19	15	ZPFG200-SH ZDFG200-S	26,870		
ABPFM25	●	1	25	12.5	38	12.5	M12	20.8	5.5	22	17	ZPFG250-SH ZDFG250-S	41,060		
ABPFM30	●	1	30	15	43	17	M16	28.8	6	23	22	ZPFG300-SH ZDFG300-S	41,060		
ABPFM32	●	1	32	16	43	17	M16	28.8	6	23	22	ZPFG320(-G) ZDFG320-W	41,060		

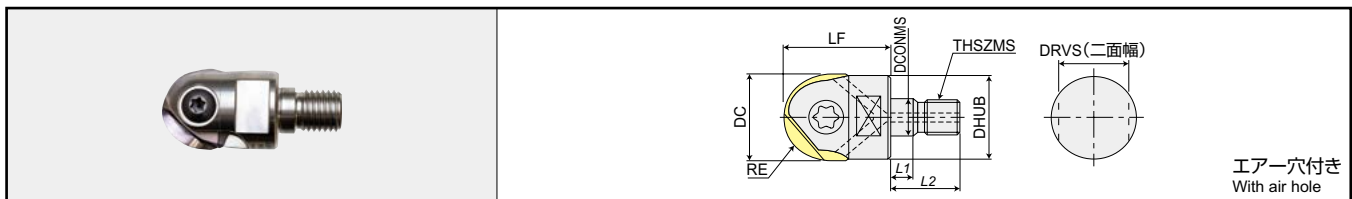





商品コード Item code	在庫 Stock	インサート数 No. of inserts	寸法 Size(mm)											適用インサート Inserts	希望小売 価格(円) Suggested retail price(¥)
			DC	RE	LF	DCONMS	THSZMS	DHUB	L1	L2	DRVS				
ABPFM10-M6H	●	1	10	5	26	6.5	M6	9.8	5.5	14.5	7	ZPFG100-SH ZDFG100-S	21,120		
ABPFM12-M6H	●	1	12	6	26	6.5	M6	9.8	5.5	14.5	7	ZPFG120-SH ZDFG120-S	22,060		
ABPFM16-M8H	●	1	16	8	32	8.5	M8	12.8	5.5	17	10	ZPFG160-SH ZDFG160-S	25,700		
ABPFM20-M10H	●	1	20	10	38	10.5	M10	17.8	5.5	19	15	ZPFG200-SH ZDFG200-S	29,570		
ABPFM25-M12H	●	1	25	12.5	38	12.5	M12	20.8	5.5	22	17	ZPFG250-SH ZDFG250-S	45,170		
ABPFM30-M16H	●	1	30	15	43	17	M16	28.8	6	23	22	ZPFG300-SH ZDFG300-S	45,170		

【注意】モジュラーミル及び専用シャンク、専用アーバの「工具端面」「モジュラーネジ部」にグリースなどの潤滑剤は塗布しないでください。

【Note】Do not apply lubricants such as grease, etc. to the "contact faces" and "modular screws" of the "modular mill", "dedicated shanks" and "dedicated arbor".

●印：標準在庫品です。 無印：弊社営業へお問合せください。 —印：製作致しません。
● : Stocked items. No mark : Contact with our sales department. — : Not manufactured.

部品番号 Parts

部品名 Parts	形状 Shape	クランプねじ Clamp screw			ドライバ/レンチ Screw driver / Wrench			ねじ焼き付き防止剤 Screw anti-seizure agent	
			締付トルク Fastening torque (N·m)	希望小売 価格(円) Suggested retail price (¥)	 A	 B	形状 Shape	希望小売 価格(円) Suggested retail price (¥)	
適用カッタ Cutter Body									
ABPF06S (W/WL)		581-140	0.5	1,970	104-T6	A	1,800	P-37	1,010
ABPF08S (L/W/WL/WL/WL/WL/WL)		581-141	1.1	1,490	104-T8	A	1,800		
ABPF10S (L/W/WL/WL/WL/WL/WL) ABPFM10(-M6H)		581-142	2.2	1,490	104-T10	A	1,920		
ABPF12S (L/W/WL/WL/WL/WL/WL) ABPFM12(-M6H)		581-143	4.9	1,490					
ABPF16S (L/W/WL/WL/WL/WL/WE/WE/WL)		581-144	4.9	1,490	105-T20	B	2,120		
ABPFU16W220 ABPFM16(-M8H)									
ABPF20S (L/W/WL/WL/WL/WE/WE/WL)		581-145	6.9	1,490	101-T25S	B	1,440		
ABPF20MT2 ABPFU20W270 ABPFM20(-M10H)									
ABPF25S (L/W/WL/WL/WL/WE/WE/WL)		581-146	9.8	1,710					
ABPF25MT3 ABPFU25W300 ABPFM25(-M12H)									
ABPF30S (L/W/WL/WL/WL/WE/WE/WL)		581-147	9.8	1,710	105-T30A	B	2,120		
ABPF30MT4 ABPFU30W300 ABPFM30(-M16H)									
ABPF32S (L/W/WL/WL/WL/WE/WE)		581-147	9.8						
ABPF32MT4 ABPFM32									

【注意】クランプねじは消耗品です。使用環境により交換寿命は変化しますので早めの交換をお願い致します。

【Note】 The clamp screw is a consumable part. Since replacement life depends on the use environment, it is recommended that it be replaced at an early stage.

強ねじれ刃形への切り替え対照表 Comparative table of the conventional and new items.

○ は数字が入ります。 Numeric figure comes in a circle ○.

一般刃形インサート Conventional		刃径 Diameter		強ねじれ刃形インサート High helix edge shape inserts	
商品コード Item code	材種 Grade			商品コード Item code	材種 Grade
ZPFG	PTH08M	(ϕ 8 ~ 30)	→	ZDFG-ST	ATH80D
ZPFG	PCA08M		→	ZDFG-SC	PN08M
ZPFG	PCA12M		→	ZDFG-ST	PN15M
ZPFG-GH	ATH80D	(ϕ 8 ~ 30)	→	ZPFG-SH	TH303
ZPFG-GF	ACS05E		→	ZDFG-SC	PN08M
ZPFG-GF	HD7010	(ϕ 6 ~ 20)	→	ZDFG-SF	HD7010
ZDFG-WH	ATH80D	(ϕ 6 ~ 30)	→	ZDFG-ST	ATH80D
ZDFG-WF	ACS05E	(ϕ 6 ~ 30)	→	ZDFG-SC	PN08M
	ACS05E	(ϕ 16 ~ 30)	→	ZDFG-SF	ATH10E

標準切削条件表 Recommended cutting conditions ※赤字は第一推奨材種です。Red indicates primary recommended grade.

被削材 Work material	推奨材種 Recommended inserts grade		切削条件 Cutting conditions	φ6			φ8			φ10			φ12		
	強ねじれ刃形 High helix edge shape	一般刃形 Standard		中仕上げ Semi Finishing		仕上げ Finishing	中仕上げ Semi Finishing		仕上げ Finishing	中仕上げ Semi Finishing		仕上げ Finishing	中仕上げ Semi Finishing		仕上げ Finishing
				汎用 General purpose	高速加工 High-speed processing		汎用 General purpose	高速加工 High-speed processing		汎用 General purpose	高速加工 High-speed processing		汎用 General purpose	高速加工 High-speed processing	
炭素鋼 合金鋼 (30HRC以下) Carbon steels Alloy steels (30HRC or less)	※ PN08M PN15M TH303 ATH80D ATH10E	ACS05E PCA12M PCA08M	n (min ⁻¹)	8,490	16,450	16,450	6,370	12,340	12,340	5,100	9,240	11,150	4,250	7,170	10,080
			v_c (m/min)	160	310	310	160	310	310	160	290	350	160	270	380
			vf (mm/min)	1,700	4,930	3,290	2,550	9,870	4,940	2,040	7,390	4,460	1,700	5,740	4,030
			fz (mm/t)	0.1	0.15	0.1	0.2	0.4	0.2	0.2	0.4	0.2	0.2	0.4	0.2
			a_p (mm)	0.1	0.05	0.05	0.2	0.1	0.1	0.25	0.15	0.1	0.3	0.2	0.1
			a_e (mm)	0.6	0.6	0.2	0.8	0.8	0.25	1	0.8	0.25	1.2	0.9	0.3
			ae (mm)	0.6	0.6	0.2	0.8	0.8	0.25	1	0.8	0.25	1.2	0.9	0.3
炭素鋼 合金鋼 (30~45HRC) Carbon steels Alloy steels	PN08M PN15M TH303 ATH80D	ACS05E PCA12M PCA08M	n (min ⁻¹)	6,370	14,320	14,320	4,780	10,750	10,750	3,820	7,640	9,550	3,180	6,100	8,760
			v_c (m/min)	120	270	270	120	270	270	120	240	300	120	230	330
			vf (mm/min)	1,270	4,300	2,860	1,910	8,600	4,300	1,530	6,110	3,820	1,270	4,880	3,500
			fz (mm/t)	0.1	0.15	0.1	0.2	0.4	0.2	0.2	0.4	0.2	0.2	0.4	0.2
			a_p (mm)	0.1	0.05	0.05	0.2	0.1	0.1	0.25	0.15	0.1	0.3	0.2	0.1
			a_e (mm)	0.6	0.6	0.2	0.8	0.8	0.25	1	0.8	0.25	1.2	0.9	0.3
			ae (mm)	0.6	0.6	0.2	0.8	0.8	0.25	1	0.8	0.25	1.2	0.9	0.3
鋳鉄 Cast irons	ATH10E TH303 ATH80D PN08M PN15M	ACS05E ATH80D PTH08M PCA12M PCA08M	n (min ⁻¹)	8,490	16,450	16,450	6,370	12,340	12,340	5,090	9,240	11,150	4,240	7,170	10,080
			v_c (m/min)	160	310	310	160	310	310	160	290	350	160	270	380
			vf (mm/min)	1,700	6,580	3,290	3,820	14,810	4,940	3,050	11,090	6,690	2,550	8,600	6,050
			fz (mm/t)	0.1	0.2	0.1	0.3	0.6	0.2	0.3	0.6	0.3	0.3	0.6	0.3
			a_p (mm)	0.1	0.05	0.05	0.2	0.1	0.1	0.25	0.15	0.1	0.3	0.2	0.1
			a_e (mm)	0.6	0.6	0.2	0.8	0.8	0.25	1	0.8	0.25	1.2	0.9	0.3
			ae (mm)	0.6	0.6	0.2	0.8	0.8	0.25	1	0.8	0.25	1.2	0.9	0.3
グラファイト Graphite	HD7010 ATH10E	HD7010	n (min ⁻¹)	15,920	21,220	21,220	11,940	15,920	15,920	9,550	12,740	12,740	7,960	10,620	10,620
			v_c (m/min)	300	400	400	300	400	400	300	400	400	300	400	400
			vf (mm/min)	3,180	6,370	4,240	4,780	9,550	6,370	3,820	7,640	5,100	3,190	6,370	4,240
			fz (mm/t)	0.1	0.15	0.1	0.2	0.3	0.2	0.2	0.3	0.2	0.2	0.3	0.2
			a_p (mm)	0.3	0.15	0.15	0.4	0.2	0.2	0.5	0.3	0.2	0.6	0.4	0.2
			a_e (mm)	0.6	0.6	0.2	0.8	0.8	0.25	1.0	0.8	0.25	1.2	0.9	0.3
			ae (mm)	0.6	0.6	0.2	0.8	0.8	0.25	1.0	0.8	0.25	1.2	0.9	0.3
アルミニウム 合金鋳物 Cast aluminum alloys AC4A, ADC12等	HD7010 PN08M	HD7010	n (min ⁻¹)	15,920	26,530	26,530	11,940	19,900	19,900	9,550	15,920	15,920	7,960	13,270	13,270
			v_c (m/min)	300	500	500	300	500	500	300	500	500	300	500	500
			vf (mm/min)	3,180	10,610	5,310	4,780	15,920	7,960	3,820	12,740	6,370	3,190	10,620	5,310
			fz (mm/t)	0.1	0.2	0.1	0.2	0.4	0.2	0.2	0.4	0.2	0.2	0.4	0.2
			a_p (mm)	0.3	0.15	0.15	0.4	0.2	0.2	0.5	0.3	0.2	0.6	0.4	0.2
			a_e (mm)	0.6	0.6	0.2	0.8	0.8	0.25	1.0	0.8	0.25	1.2	0.9	0.3
			ae (mm)	0.6	0.6	0.2	0.8	0.8	0.25	1.0	0.8	0.25	1.2	0.9	0.3
焼入れ鋼 45~55HRC Hardened steels	TH303 ATH80D PN15M PN08M	ATH80D PTH08M PCA12M PCA08M ACS05E	n (min ⁻¹)	5,310	12,200	12,200	3,980	9,160	9,160	3,180	6,690	8,280	2,650	5,310	7,700
			v_c (m/min)	100	230	230	100	230	230	100	210	260	100	200	290
			vf (mm/min)	850	2,440	2,440	800	3,660	3,660	640	2,680	3,310	530	2,120	3,080
			fz (mm/t)	0.08	0.1	0.1	0.1	0.2	0.2	0.1	0.2	0.2	0.1	0.2	0.2
			a_p (mm)	0.1	0.05	0.05	0.2	0.1	0.1	0.25	0.15	0.1	0.3	0.2	0.1
			a_e (mm)	0.6	0.6	0.2	0.8	0.8	0.25	1	0.8	0.25	1.2	0.9	0.3
			ae (mm)	0.6	0.6	0.2	0.8	0.8	0.25	1	0.8	0.25	1.2	0.9	0.3
焼入れ鋼 55~62HRC Hardened steels	TH303 ATH80D	ATH80D (PTH08M)	n (min ⁻¹)	4,240	9,550	9,550	3,180	7,170	7,170	2,550	5,410	6,370	2,120	4,250	6,100
			v_c (m/min)	80	180	180	80	180	180	80	170	200	80	160	230
			vf (mm/min)	680	1,910	1,910	640	2,870	2,870	510	2,160	2,550	420	1,700	2,440
			fz (mm/t)	0.08	0.1	0.1	0.1	0.2	0.2	0.1	0.2	0.2	0.1	0.2	0.2
			a_p (mm)	0.1	0.05	0.05	0.2	0.1	0.1	0.25	0.15	0.1	0.3	0.2	0.1
			a_e (mm)	0.6	0.6	0.2	0.8	0.8	0.25	1	0.8	0.25	1.2	0.9	0.3
			ae (mm)	0.6	0.6	0.2	0.8	0.8	0.25	1	0.8	0.25	1.2	0.9	0.3
最大 fz Maximum fz (mm/t)				< 0.2			< 0.8			< 0.8			< 0.8		
最大 a_p Maximum a_p (mm)				< 3.0			< 4.0			< 5.0			< 6.0		

- 【注意】** ①被削材、加工形状に合わせて、適切なクーラントを使用してください。
 ②この切削条件表は切削条件の目安を示すものです。実際の加工では加工形状、目的、使用機械等により条件を調整してください。
 ③この工具をご使用の際は、破損する危険性がありますので、必ずカバー・保護めがね・安全靴等をご使用してください。
 ④超硬シャンクホルダには手を加えないでください。また、突き出し長3DC以上の仕上げ加工は、切込み量 a_p を工具径DC12以下は $a_p=0.2$ mm以下、工具径DC16以上は $a_p=0.3$ mm以下を目安にご使用ください。

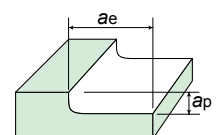

- 【Note】** ①Use the appropriate coolant for the work material and machining shape.
 ②These conditions are for general guidance; in actual machining conditions adjust the parameters according to your actual machine and work-piece conditions.
 ③Be sure to practice safety instructions and precautions such as wearing glasses and safety shoes, and placing safety covers when you use this tool. Because this tool can be broken during machining so failure to follow these instructions may cause personal injury.
 ④Never attempt to modify the carbide shank holder. Use the value for the depth of cut (a_p) when the carbide shank holder is used.
 Tool dia. DC \leq 12mm: $a_p\leq$ 0.2mm. Tool dia. DC \geq 16mm: $a_p\leq$ 0.3mm.

刃先交換式工具
ボールエンドミル

φ 16			φ 20			φ 25			φ 30			φ 32			被削材 Work material
中仕上げ Semi Finishing		仕上げ Finishing	中仕上げ Semi Finishing		仕上げ Finishing	中仕上げ Semi Finishing		仕上げ Finishing	中仕上げ Semi Finishing		仕上げ Finishing	中仕上げ Semi Finishing		仕上げ Finishing	
汎用 General purpose	高速加工 High-speed processing		汎用 General purpose	高速加工 High-speed processing		汎用 General purpose	高速加工 High-speed processing		汎用 General purpose	高速加工 High-speed processing		汎用 General purpose	高速加工 High-speed processing		
3,180	4,180	9,950	2,550	3,340	9,080	2,040	2,680	8,030	1,700	2,230	7,640	1,590	2,090	7,170	炭素鋼 合金鋼 (30HRC以下) Carbon steels Alloy steels (30HRC or less)
160	210	500	160	210	570	160	210	630	160	210	720	160	210	720	
1,590	4,180	5,970	1,280	3,340	7,260	1,020	2,680	8,030	850	2,230	9,170	800	2,090	8,600	
0.25	0.5	0.3	0.25	0.5	0.4	0.25	0.5	0.5	0.25	0.5	0.6	0.25	0.5	0.6	
0.8	0.6	0.1	1	0.7	0.1	1.25	0.9	0.1	1.6	1.1	0.1	1.6	1.1	0.1	
1.6	1.1	0.35	2	1.5	0.4	2.5	1.8	0.5	3.2	2.4	0.5	3.2	2.4	0.5	
2,390	2,990	7,560	1,910	2,550	6,690	1,530	2,040	5,990	1,270	1,700	5,730	1,190	1,590	5,370	炭素鋼 合金鋼 (30~45HRC) Carbon steels Alloy steels
120	150	380	120	160	420	120	160	470	120	160	540	120	160	540	
1,200	2,990	4,540	960	2,550	5,350	770	2,040	5,990	640	1,700	6,880	600	1,590	6,440	
0.25	0.5	0.3	0.25	0.5	0.4	0.25	0.5	0.5	0.25	0.5	0.6	0.25	0.5	0.6	
0.8	0.6	0.1	1	0.7	0.1	1.25	0.9	0.1	1.6	1.1	0.1	1.6	1.1	0.1	
1.6	1.1	0.3	2	1.5	0.4	2.5	1.8	0.5	3.2	2.4	0.6	3.2	2.4	0.6	
3,180	4,180	9,950	2,550	3,340	9,080	2,040	2,680	8,030	1,700	2,230	7,640	1,590	2,090	7,170	鋳鉄 Cast irons
160	210	500	160	210	570	160	210	630	160	210	720	160	210	720	
2,230	5,850	5,970	1,790	4,680	7,260	1,430	3,750	8,030	1,190	3,120	9,170	1,110	2,930	8,600	
0.35	0.7	0.3	0.35	0.7	0.4	0.35	0.7	0.5	0.35	0.7	0.6	0.35	0.7	0.6	
0.8	0.6	0.1	1	0.7	0.1	1.25	0.9	0.1	1.6	1.1	0.1	1.6	1.1	0.1	
1.6	1.1	0.3	2	1.5	0.4	2.5	1.8	0.5	3.2	2.4	0.6	3.2	2.4	0.6	
5,970	7,960	7,960	4,780	6,370	6,370	3,820	5,090	5,090	3,180	4,240	4,240				グラファイト Graphite
300	400	400	300	400	400	300	400	400	300	400	400				
2,990	4,780	3,980	2,390	3,820	3,190	1,910	5,090	5,090	1,590	4,240	5,090				
0.25	0.3	0.25	0.25	0.3	0.25	0.25	0.5	0.5	0.25	0.5	0.6				
0.8	0.6	0.1	1	0.7	0.1	1.25	0.9	0.1	1.6	1.1	0.1				
1.6	1.1	0.3	2	1.5	0.4	2.5	1.8	0.5	3.2	2.4	0.6				
5,970	9,950	9,950	4,780	7,960	7,960	3,820	6,370	6,370	3,180	5,310	5,310				アルミニウム 合金鋳物 Cast aluminum alloys AC4A, ADC12等
300	500	500	300	500	500	300	500	500	300	500	500				
2,990	7,960	4,980	2,390	6,370	3,980	1,910	6,370	6,370	1,590	5,310	6,370				
0.25	0.4	0.25	0.25	0.4	0.25	0.25	0.5	0.5	0.25	0.5	0.6				
0.8	0.6	0.1	1	0.7	0.1	1.25	0.9	0.1	1.6	1.1	0.1				
1.6	1.1	0.3	2	1.5	0.4	2.5	1.8	0.5	3.2	2.4	0.6				
1,990	2,990	6,970	1,590	2,390	6,370	1,270	1,910	5,730	1,060	1,590	5,310	1,000	1,490	4,980	焼入れ鋼 45~55HRC Hardened steels
100	150	350	100	150	400	100	150	450	100	150	500	100	150	500	
480	1,440	4,180	380	1,150	5,100	310	920	5,730	250	760	6,370	240	720	5,980	
0.12	0.24	0.3	0.12	0.24	0.4	0.12	0.24	0.5	0.12	0.24	0.6	0.12	0.24	0.6	
0.8	0.6	0.1	1	0.7	0.1	1.25	0.9	0.1	1.6	1.1	0.1	1.6	1.1	0.1	
1.6	1.1	0.3	2	1.5	0.4	2.5	1.8	0.5	3.2	2.4	0.6	3.2	2.4	0.6	
1,590	2,390	5,570	1,270	1,910	5,100	1,020	1,530	4,590	850	1,270	4,240	800	1,190	3,980	焼入れ鋼 55~62HRC Hardened steels
80	120	280	80	120	320	80	120	360	80	120	400	80	120	400	
380	1,150	3,340	300	920	4,080	240	730	4,590	200	610	5,090	190	570	4,780	
0.12	0.24	0.3	0.12	0.24	0.4	0.12	0.24	0.5	0.12	0.24	0.6	0.12	0.24	0.6	
0.8	0.6	0.1	1	0.7	0.1	1.25	0.9	0.1	1.6	1.1	0.1	1.6	1.1	0.1	
1.6	1.1	0.3	2	1.5	0.4	2.5	1.8	0.5	3.2	2.4	0.6	3.2	2.4	0.6	
< 1.0			< 1.0			< 1.0			< 1.0			< 1.0			最大 fz Maximum fz (mm/t)
< 8.0			< 10.0			< 12.5			< 15.0			< 16.0			最大 ap Maximum ap (mm)

※突き出し長3DC以上の場合は、
上記の表をもとに右記表を参考に
調整してください。

If overhang length is 3DC or more, make
adjustments to the table above according to
the table at right.

突き出し量 Overhang	Vc (m/min)	Vf (mm/min)
<3DC	100%	100%
3DC~5DC	70%	70%
5DC~8DC	60%	60%
8DC~10DC	50%	50%

Ball Precision F ABPFN

アルファボールプレジジョン F ABPFN

- ボール部先端から外周まで、高いR精度を示します。
 - 優れた切れ味、きれいな仕上げ面。中心部切れ刃の刃形の工夫により、優れた仕上げ面粗さが得られます。
 - 長寿命。高性能コーティングインサートにより長寿命です。
- ・ High accuracy is exhibited from the ball tip to the outer circumference.
 ・ Excellent cutting performance and beautiful finish
 Special shape of central cutting flute provides excellent finished surface roughness.
 ・ Long life. High-performance coated inserts provide long life.

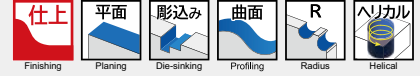

ABPFN○○S○○-○○○-○○○ シャンクタイプ Shank type

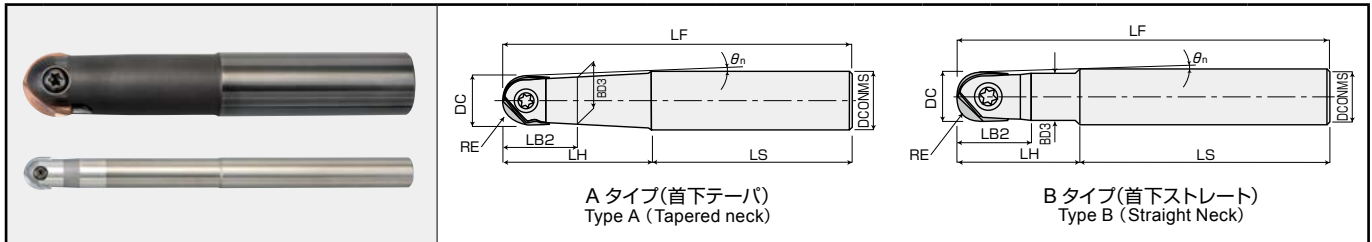

商品コード Item code	在庫 Stock	寸法 Size (mm)									形状 Shape	適用インサート Insert	希望小売 価格(円) Suggested retail price (¥)
		DC	RE	LF	DCONMS	LB2	LH	BD3	LS	θ_n			
ABPFN06S08-90-30	●	6	3	90	8	15	30	5.4	60	2.12	A	ZDFG06N-ST	17,960
ABPFN08S10-100-30	●	8	4	100	10	15	30	7.5	70	2.20	A	ZDFG08N-ST	18,430
ABPFN10S10-100-30	●	10	5	100	10	18	30	9.0	70	-	B	ZDFG10N-ST	19,240
ABPFN12S12-110-40	●	12	6	110	12	21	40	11.5	70	-	B	ZDFG12N-ST	20,070
ABPFN16S16-130-50	●	16	8	130	16	27	50	14.8	80	-	B	ZDFG16N-ST	23,350
ABPFN20S20-140-60	●	20	10	140	20	35	60	18	80	-	B	ZDFG20N-ST	26,870
ABPFN25S25-150-75	●	25	12.5	150	25	43	75	24	75	-	B	ZDFG25N-ST	41,060
ABPFN30S32-160-80	●	30	15.0	160	32	55	80	29	80	1.20	A	ZDFG30N-ST	41,060
ABPFN06S06W-100-50	●	6	3	100	6	10.3	50	5.5	50	-	B	ZDFG06N-ST	34,960
ABPFN08S08W-140-75	●	8	4	140	8	75	75	7.5	65	-	B	ZDFG08N-ST	45,290
ABPFN10S10W-140-75	●	10	5	140	10	18	75	9.0	65	-	B	ZDFG10N-ST	49,510
ABPFN12S12W-150-75	●	12	6	150	12	21	75	11.5	75	-	B	ZDFG12N-ST	59,600
ABPFN16S16W-160-90	●	16	8	160	16	27	90	14.8	70	-	B	ZDFG16N-ST	75,900
ABPFN20S20W-180-100	●	20	10	180	20	35	100	18	80	-	B	ZDFG20N-ST	94,200
ABPFN25S25W-200-100	●	25	12.5	200	25	43	100	24	100	-	B	ZDFG25N-ST	126,690
ABPFN30S32W-250-150	●	30	15.0	250	32	55	150	29	100	0.4	B	ZDFG30N-ST	202,930

刃先交換式工具
ボールエンドミル

部品番号 Parts

○は数字が入ります。 Numeric figure in a circle ○

部品名 Parts	クランプねじ Clamp screw			ドライバー／レンチ Screw driver / Wrench			ねじ焼き付き防止剤 Screw anti-seizure agent	
形状 Shape	締付トルク Fastening torque (N・m)	希望小売 価格(円) Suggested retail price (¥)	形状 Shape	希望小売 価格(円) Suggested retail price (¥)	形状 Shape	希望小売 価格(円) Suggested retail price (¥)	希望小売 価格(円) Suggested retail price (¥)	
適用カッタ Cutter body			A					
ABPFN06S○○(W)-○○○-○○○	581-140	0.5	1,970	104-T6	A	1,800	P-37 1,010	
ABPFN08S○○(W)-○○○-○○○	581-149	0.9	1,490	104-T7	A	2,060		
ABPFN10S○○(W)-○○○-○○○	581-150	1.1	1,490	104-T8	A	1,800		
ABPFN12S○○(W)-○○○-○○○	581-151	2.2	1,490	104-T10	A	1,920		
ABPFN16S○○(W)-○○○-○○○	581-152	2.9	1,490	104-T15	A	2,060		
ABPFN20S○○(W)-○○○-○○○	581-144	4.9	1,490	105-T20	B	2,120		
ABPFN25S○○(W)-○○○-○○○	581-146	9.8	1,710	105-T30A	B	2,120		
ABPFN30S○○(W)-○○○-○○○	581-147	9.8	1,710					

【注意】 クランプねじは消耗品です。使用環境により交換寿命は変化しますので早めの交換をお願い致します。

【Note】 The clamp screw is a consumable part. Since replacement life depends on the use environment, it is recommended that it be replaced at an early stage.

●印：標準在庫品です。 ●：Stocked items.

強ねじれ刃形インサート High helix edge shape inserts

P	鋼 Carbon steels	□	□	■：一般切削・第一推奨 General cutting, First recommendation □：一般切削・第二推奨 General cutting, Second recommendation						
	K	FC・FCD Cast irons	□		□					
H	高硬度材 Hardened steels	■	□							
インサート形状・寸法 Figure・Size	商品コード Item code	精度 Tolerance class	在庫材種 Stocked grade		刃先形状 Edge shape					希望小売価格(円) Suggested retail price (¥)
			THコーティング TH Coating	PNコーティング PN Coating	インサート寸法 Inserts size (mm)					
			ATH80D	PN15M	RE	LE	INSL	DC	T	
	ZDFG06N-ST	F級 F	●	●	3	3.3	5	6	2	4,490
	ZDFG08N-ST		●	●	4	4.4	7	8	2.4	5,050
	ZDFG10N-ST		●	●	5	5.6	8.5	10	2.6	7,020
	ZDFG12N-ST		●	●	6	6.6	10	12	3	7,440
	ZDFG16N-ST		●	●	8	9	12	16	4	7,640
	ZDFG20N-ST		●	●	10	11.5	15	20	5	8,060
	ZDFG25N-ST		●	●	12.5	14.5	18.5	25	6	8,550
	ZDFG30N-ST		●	●	15	18.5	22.5	30	7	11,020

φ10以上のインサートは再研磨が可能です。詳しくは弊社営業所までお問合せください。
Re-grinding is applicable with insert φ10 or above. Please contact our sales department.

○ インサート取付け手順 Set-up procedures of Inserts

- インサート座面の清掃
エアブローなどで、インサート座面を清掃ください。
Clean the insert seat:
Using air-blow or alike, clean the seat.
- インサートは、上面を工具本体のねじ締め付け側に合わせ、挿入する。
Put in the insert with its top positioned to the screw-tightening side of the tool body.
- 専用レンチにてクランプねじを締め付ける。
この時インサートは押さえつけないでください。
Tighten the clamp screw with the special wrench.
Please do not press down the insert during this tightening process.
- 締め付け完了。 This is the end of insert set-up.

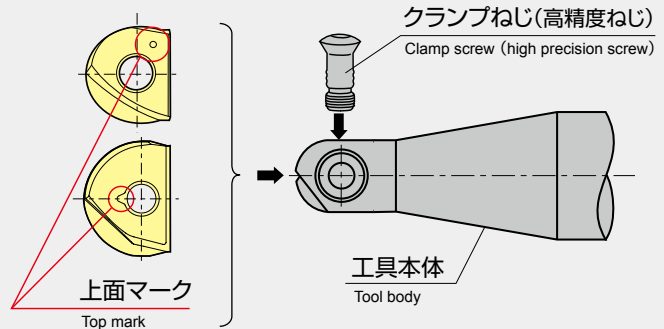

取り付け精度RE公差:±0.01mmを満足するため、左記手順に従ってください。
To meet the specification for precision of ±0.01mm, please follow this procedure.

ご注意 Attention

インサートを挿入しない状態でクランプねじ締結は、ホルダー本体の変形に繋がる恐れがあり、インサートの取り付け不良や取付精度の劣化につながる可能性があるため決して行わないでください。
Never tighten the clamp screw without putting the insert. The tool body may be deformed, resulting in improper insert mounting or deterioration of mounting accuracy.



インサート未挿入での空締め禁止
Do not tighten the screw without putting insert



- 独自のインサート固定方法により、仕上げ用刃先交換式ボールエンドミルの4枚刃化を実現！
- 最新高速マシンに対応！
- 従来品比、加工能率2倍、寿命3倍以上

・ We devised an original insert mounting method to achieve a four-insert indexable ball end mill with finishing insert tips.
 ・ Compatible with the latest highest-speed machines.
 ・ Compared with conventional products, it provides twice the processing performance and 3 times the tool life.

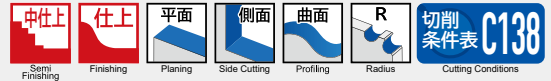

■超硬シャンク Carbide shank

ABP4F○○S○○WL○○○

○は数字が入ります。 Numeric figure in a circle ○

商品コード Item code	在庫 Stock	インサート数 No. of inserts		寸法 Size (mm)								適用インサート Inserts		希望小売 価格(円) Suggested retail price(¥)	
		親刃 Main insert	子刃 Sub insert	DC	RE	LF	DCONMS	APMX	LB2	LH	BD3	LS	親刃 Main insert		子刃 Sub insert
ABP4F20S20WL80	●					160			80						66,990
ABP4F20S20WL100	●	1	2	20	10	180	20	10	17	100	19	80	ZDFG200CE ZDFG200CT	ZDFG200SE ZDFG200SK	111,800
ABP4F20S20WL120	●					200			120						111,800
ABP4F25S25WL100	●					180			100						124,340
ABP4F25S25WL120	●	1	2	25	12.5	200	25	12.5	23.5	120	24	80	ZDFG250CE ZDFG250CT	ZDFG250SE ZDFG250SK	125,520
ABP4F25S25WL150	●					230			150						157,190
ABP4F30S32WL100	●					180			100						154,840
ABP4F30S32WL120	●	1	2	30	15	200	32	15	30	120	28	80	ZDFG300CE ZDFG300CT	ZDFG300SE ZDFG300SK	175,950
ABP4F30S32WL150	●					230			150						205,280

■鋼シャンク Steel shank

ABP4F○○S○○L○○○

○は数字が入ります。 Numeric figure in a circle ○

商品コード Item code	在庫 Stock	インサート数 No. of inserts		寸法 Size (mm)								適用インサート Inserts		希望小売 価格(円) Suggested retail price(¥)	
		親刃 Main insert	子刃 Sub insert	DC	RE	LF	DCONMS	APMX	LB2	LH	BD3	LS	親刃 Main insert		子刃 Sub insert
ABP4F20S20L60	●					140			60						28,630
ABP4F20S20L80	●	1	2	20	10	160	20	10	17	80	19	80	ZDFG200CE ZDFG200CT	ZDFG200SE ZDFG200SK	36,950
ABP4F20S20L100	●					180			100						45,290
ABP4F25S25L100	●					180			100						46,340
ABP4F25S25L120	●	1	2	25	12.5	200	25	12.5	23.5	120	24	80	ZDFG250CE ZDFG250CT	ZDFG250SE ZDFG250SK	47,510
ABP4F25S25L150	●					230			150						47,510
ABP4F30S32L100	●					180			100						50,100
ABP4F30S32L120	●	1	2	30	15	200	32	15	30	120	29	80	ZDFG300CE ZDFG300CT	ZDFG300SE ZDFG300SK	52,560
ABP4F30S32L150	●					230			150						52,560

●印：標準在庫品です。 無印：弊社営業へお問合せください。
 ● : Stocked items. No mark : Contact with our sales department.

■ インサート Insert

P 鋼 Carbon steels	K FC・FCD Cast irons	H 高硬度材 Hardened steels	形状 Shape	商品コード Item code	精度 Tolerance class	THコーティング TH Coating			PN2コーティング PN2 Coating	PNコーティング PN Coating	寸法 Size (mm)			希望小売価格(円) Suggested retail price(¥)
						TH303	ATH10E	ATH80D	PN215	PN15M	RE	INSL	T	
親刃 Main insert		子刃 Sub insert												
ZDFG200CE		ZDFG200CT												
ZDFG250CE		ZDFG250CT												
ZDFG300CE		ZDFG300CT												
ZDFG200SE		ZDFG200SK												
ZDFG250SE		ZDFG250SK												
ZDFG300SE		ZDFG300SK												

※親刃は1ケース1ヶ入り、子刃は1ケース2ヶ入りです。Main inserts are packaged 1 per case. Sub inserts are packaged 2 per case.

P 鋼 Carbon steels	K FC・FCD Cast irons	H 高硬度材 Hardened steels	形状 Shape	商品コード Item code	精度 Tolerance class	TH303	ATH10E	ATH80D	PN215	PN15M	セット内容 set items	希望小売価格(円) Suggested retail price(¥)				
親刃 Main insert		子刃 Sub insert		子刃 Sub insert												
ZDFG200SET		ZDFG250SET		ZDFG300SET												

インサートの再研磨&再コーティングも承っております。詳しくは弊社営業所までお問い合わせください。再研磨品をご使用の際は、再研磨された親刃と子刃を組合せてご使用ください。新品と再研磨品を組み合わせ使用しないでください。

Insert regrinding/recoating orders accepted. Please contact our sales department. Do not use new inserts in combination with reground inserts.

※再研磨、再コーティングは1回のみ可能です。 Regrinding and recoating can be performed only once.

■ 部品番号 Parts

○は数字が入ります。 Numeric figure in a circle ○

部品名 Parts	クランプねじ Clamp screw						ドライバー/レンチ Screw driver / Wrench						ねじ焼き付き防止剤 Screw anti-seizure agent	
	親刃 Main insert	締付トルク Fastening torque (N・m)	希望小売価格(円) Suggested retail price(¥)	子刃 Sub insert	締付トルク Fastening torque (N・m)	希望小売価格(円) Suggested retail price(¥)	親刃 Main insert	形状 Shape	希望小売価格(円) Suggested retail price(¥)	子刃 Sub insert	形状 Shape	希望小売価格(円) Suggested retail price(¥)	希望小売価格(円) Suggested retail price(¥)	
適用カッタ Cutter body														
ABP4F20S20	155-158	2.2	1,880	250-140	0.5	870	104-T15	A	2,060	104-T6	A	1,800		
ABP4F25S25	155-159	2.9	1,920	250-141	1.1	870	104-T15	A	2,060	104-T8	A	1,800	P-37	1,010
ABP4F30S32	155-160	4.9	2,020	265-141	2	870	105-T20	B	2,120	104-T10	A	1,920		

【注意】クランプねじは消耗品です。使用環境により交換寿命は変化しますので早めの交換をお願い致します。

【Note】The clamp screw is a consumable part. Since replacement life depends on the use environment, it is recommended that it be replaced at an early stage.

標準切削条件表 Recommended cutting conditions

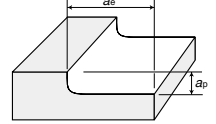

※赤字は第1推奨材種です。
Red indicates primary recommended insert grades.

被削材 Work material	インサート材種 Insert grade		切削条件 Cutting conditions	φ 20			φ 25			φ 30		
	中仕上げ Semi finishing	仕上げ Finishing		中仕上げ Semi finishing	仕上げ Finishing		中仕上げ Semi finishing	仕上げ Finishing		中仕上げ Semi finishing	仕上げ Finishing	
					汎用 General	高速加工 High-speed processing		汎用 General	高速加工 High-speed processing		汎用 General	高速加工 High-speed processing
炭素鋼 合金鋼 (30HRC以下) Carbon steels Alloy steels (30HRC or less)	PN215 PN15M	PN215 PN15M	n (min ⁻¹)	4,780	9,240	10,350	4,460	8,790	10,190	3,820	7,640	10,080
			Vc(m/min)	300	580	650	350	690	800	360	720	950
			Vf(mm/min)	3,440	6,650	9,110	3,570	7,030	8,970	3,060	6,110	8,870
			fz(mm/t)	0.18	0.18	0.22	0.2	0.2	0.22	0.2	0.2	0.2
			ap(mm)	0.3	0.1	0.1	0.4	0.1	0.1	0.5	0.1	0.1
			ae(mm)	1.2	0.4	0.4	1.4	0.45	0.45	1.5	0.5	0.5
炭素鋼 合金鋼 (30~45HRC) Carbon steels Alloy steels	PN215 TH303 PN15M ATH80D	PN215 TH303 PN15M ATH80D	n (min ⁻¹)	3,670	6,850	7,960	3,060	6,880	8,280	2,650	6,050	8,490
			Vc(m/min)	230	430	500	240	540	650	250	570	800
			Vf(mm/min)	2,640	4,930	6,370	2,450	5,510	6,630	2,120	4,840	6,790
			fz(mm/t)	0.18	0.18	0.2	0.2	0.2	0.2	0.2	0.2	0.2
			ap(mm)	0.3	0.1	0.1	0.4	0.1	0.1	0.5	0.1	0.1
			ae(mm)	1	0.4	0.4	1.4	0.45	0.45	1.5	0.5	0.5
鋳鉄 Cast irons	TH303 PN215 ATH80D PN15M	ATH10E TH303 PN215 ATH80D	n (min ⁻¹)	6,690	10,190	11,150	5,930	10,570	11,460	5,940	9,550	11,670
			Vc(m/min)	420	640	700	465	830	900	560	900	1,100
			Vf(mm/min)	4,820	8,150	11,150	4,740	8,460	11,460	4,750	7,640	11,670
			fz(mm/t)	0.18	0.2	0.25	0.2	0.2	0.25	0.2	0.2	0.25
			ap(mm)	0.3	0.1	0.1	0.4	0.1	0.1	0.5	0.1	0.1
			ae(mm)	1.2	0.4	0.4	1.4	0.45	0.45	1.5	0.5	0.5
焼入れ鋼 45~55HRC Hardened steels フレームハード鋼 Flame hardening steels	TH303 PN215 ATH80D PN15M	TH303 PN215 ATH80D PN15M	n (min ⁻¹)	1,910	4,780	6,690	1,790	4,460	6,120	1,700	4,240	5,840
			Vc(m/min)	120	300	420	140	350	480	160	400	550
			Vf(mm/min)	1,380	3,440	5,350	1,290	3,570	4,890	1,220	3,400	4,670
			fz(mm/t)	0.18	0.18	0.2	0.18	0.2	0.2	0.18	0.2	0.2
			ap(mm)	0.2	0.1	0.1	0.3	0.1	0.1	0.4	0.1	0.1
			ae(mm)	0.8	0.3	0.3	0.9	0.4	0.4	1	0.5	0.5
焼入れ鋼 55~62HRC Hardened steels	TH303 ATH80D	TH303 ATH80D	n (min ⁻¹)	1,600	3,190	5,420	1,410	3,570	5,230	1,270	3,820	5,200
			Vc(m/min)	100	200	340	110	280	410	120	360	490
			Vf(mm/min)	1,150	2,300	4,330	1,010	2,860	4,180	920	3,060	4,160
			fz(mm/t)	0.18	0.18	0.2	0.18	0.2	0.2	0.18	0.2	0.2
			ap(mm)	0.2	0.1	0.1	0.3	0.1	0.1	0.4	0.1	0.1
			ae(mm)	0.5	0.3	0.3	0.6	0.4	0.4	0.8	0.5	0.5
Maximum fz(mm/t)				< 0.5			< 0.6			< 0.7		
Maximum ap(mm)				< 10.0			< 12.5			< 15.0		

突出し量 Overhang	Vc (m/min)	Vf (mm/min)
4DC	100%	100%
4DC ~ 6DC	85%	85%

[注意] ①この切削条件表は切削条件の目安を示すものです。実際の加工では加工形状、目的、使用機械等により条件を調整してください。
②上記表は突出し比率<4DCの超硬シャンクを基準にしています。鋼シャンク使用時は切削条件を約2割下げてください。
③突出し長さ4DC以上の場合は、上記の表を参考に調整してください。

[Note] ① These conditions are for general guidance; in actual machining conditions adjust the parameters according to your actual machine and work-piece conditions.
② The above table is for an overhang of <4DC using a carbide shank as the standard. When using a steel shank, reduce the cutting conditions by approximately 20%.
③ When overhang is 4DC or more, values in the above table should be adjusted by referring to the table.

○ インサート取付け手順 Set-up procedures of Inserts

取付け精度RE公差±0.01mmを満足するため、下記手順に従ってインサートを取り付けてください。
To meet the specification for radius tolerance ±0.01mm, attach inserts according to the procedure below.

インサートの取付けは必ず①親刃②子刃の順でおこなってください。

エアブローなどで、工具体体のインサート取付け座面を清掃してください。また、クランプねじ全体に焼き付き防止剤を塗布してください。

過大なトルクで締め付けたり、ねじ部に切り屑等が付着したまま締め付けると、ねじ部が破損したり、外れなくなりますので下記表のトルクを超えないように締め付けてください。

Inserts must be set up in the order of ① main insert then ② sub insert.

Clean the insert seat by air-blow etc. Apply the Screw anti-seizure agent to the whole clamp screw. Excessive tightening torque or the screw to which chip adhered cause screw damage or the problem from which a screw does not separate. Please tighten the screw NOT to exceed the torque of the following table.

親刃の取付け Set-up procedures of main insert

1 親刃インサートは、上面を工具体体のねじ締め付け側に合わせ挿入します。
Place a top mark on the insert as shown toward a screw tightening side.

2 専用レンチでクランプねじを締め付けます。この時インサートは強く押さえつけないでください。
Tighten the insert screw without pressing down the insert too much strongly.

子刃の取付け Set-up procedures of sub inserts

3 子刃インサートをインサート座拘束面に沿わせて挿入します。
Install a sub insert along the restraining wall.

4 インサート座拘束面に押さえつけながら、専用レンチでクランプねじを締め付けます。
Pressing the insert firmly against the wall while tighten the insert screw.

インサートの取り外しは必ず①子刃②親刃の順でおこなってください。

Inserts must be removed in the order of ① sub insert then ② main insert.

締め付けトルク Tightening torque

工具径DC Tool dia. (mm)	親刃 Main insert (N·m)	子刃 Sub insert (N·m)
φ20	2.2	0.5
φ25	2.9	1.1
φ30	4.9	2.0

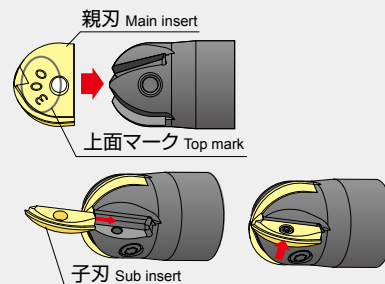

ご注意 Attention

インサートを挿入しない状態でのクランプねじ締結は、ホルダー本体の変形に繋がる恐れがあり、インサートの取付け不良や取付精度の劣化につながる可能性があるため決して行わないでください。
Never tighten the clamp screw without putting the insert. The tool body may be deformed, resulting in improper insert mounting or deterioration of mounting accuracy.



**インサート未挿入での
空締め禁止**
Do not tighten the screw
without putting insert

アルファスーパーエクセレントミニ ASM

- 当社先進の小型インサートを使用した刃先交換式エンドミルです。
- 3次元形状切刃のインサートとポケットデザインにより、小径サイズでも高効率な加工ができます。

- ・ Indexable end mill using advanced small inserts.
- ・ Pocket design and 3D-shaped cutting edge enables high-efficient machining of even small diameter sizes.

ASM 07 S R- シャンクタイプ Shank type

○は数字、□は英文字が入ります。 Numeric figure in a circle ○ and Alphabetical character comes in a square □

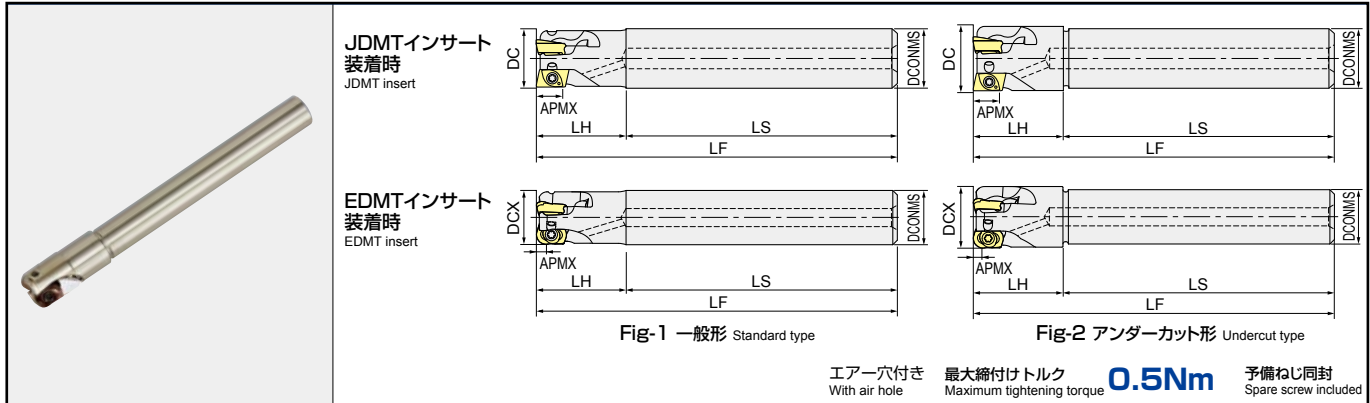

エアー穴付き With air hole 最大締め付けトルク Maximum tightening torque **0.5Nm** 予備ねじ同封 Spare screw included

商品コード Item code	在庫 Stock	刃数 No. of flutes	寸法 Size (mm)						形状 Shape	適用インサート Inserts	希望小売価格(円) Suggested retail price (¥)
			DC DCX	LF	APMX	LH	DCONMS	LS			
ASM0708S10R-1	●	1	8	75	5 (0.3)*	18	10	57	一般形 Standard type (Fig-1)	JDMT0702 S R EDMT070220R(-T)	22,290
ASM0710S10R-2	●	2	10	80		20	10	60	一般形 Standard type (Fig-1)		22,290
ASM0710S08R-2	●	2	10	80		20	8	60	アンダーカット形 Undercut type (Fig-2)		22,290
ASM0711S10R-2	●	2	11	80		20	10	60	アンダーカット形 Undercut type (Fig-2)		22,290
ASM0712S12R-3	●	3	12	80		20	12	60	一般形 Standard type (Fig-1)		26,980
ASM0712S10R-3	●	3	12	80		20	10	60	アンダーカット形 Undercut type (Fig-2)		26,980
ASM0714S12R-3	●	3	14	80		20	12	60	アンダーカット形 Undercut type (Fig-2)		29,330
ASM0716S16R-4	●	4	16	90		25	16	65	一般形 Standard type (Fig-1)		38,710
ASML0716S16R-4	●	4	16	115		50	16	65	一般形 Standard type (Fig-1)		41,060
ASM0717S16R-4	●	4	17	115		20	16	95	アンダーカット形 Undercut type (Fig-2)		41,060
ASM0720S20R-5	●	5	20	105		25	20	80	一般形 Standard type (Fig-1)		44,580
ASML0720S20R-5	●	5	20	140		60	20	80	一般形 Standard type (Fig-1)		48,100
ASM0721S20R-5	●	5	21	140		20	20	120	アンダーカット形 Undercut type (Fig-2)		48,100

*EDMT070220R(-T)をご使用の場合はAPMXは()寸法になります。 *When using EDMT070220R (-T), APMX is in () dimensions.

部品番号 Parts

部品名 Parts	クランプねじ Clamp screw	ドライバー Screw driver	ねじ焼き付き防止剤 Screw anti-seizure agent								
形状 Shape											
適用カッター Cutter body	<table border="1"> <tr> <td>締め付けトルク Fastening torque (N·m)</td> <td>希望小売価格 Suggested retail price (¥)</td> </tr> <tr> <td>0.5</td> <td>870</td> </tr> </table>	締め付けトルク Fastening torque (N·m)	希望小売価格 Suggested retail price (¥)	0.5	870	<table border="1"> <tr> <td>希望小売価格 Suggested retail price (¥)</td> </tr> <tr> <td>1,800</td> </tr> </table>	希望小売価格 Suggested retail price (¥)	1,800	<table border="1"> <tr> <td>希望小売価格 Suggested retail price (¥)</td> </tr> <tr> <td>1,010</td> </tr> </table>	希望小売価格 Suggested retail price (¥)	1,010
締め付けトルク Fastening torque (N·m)	希望小売価格 Suggested retail price (¥)										
0.5	870										
希望小売価格 Suggested retail price (¥)											
1,800											
希望小売価格 Suggested retail price (¥)											
1,010											
ASM (L) 07 S R- ASMM07 S R-	240-140	104-T6	P-37								

[注意] クランプねじは消耗品です。使用環境により交換寿命は変化しますので早めの交換をお願い致します。クランプねじは、3枚刃までは予備が1本、4枚刃以上は予備が2本付属します。

[Note] The clamp screw is a consumable part. Since replacement life depends on the use environment, it is recommended that it be replaced at an early stage. One spare clamp screw is provided for cutter bodies with 3 or less flutes, and two for 4 or more flutes.

●印：標準在庫品です。 ●：Stocked items. 無印：弊社営業へお問合せください。 No mark：Contact with our sales department.

ASMM07○○R-○ モジュラータイプ Modular type

○は数字が入ります。 Numeric figure in a circle ○

モジュラール用シャンクはD2頁を、締め付けトルクについてはD5頁を参照ください。
Refer page D2 about the shanks for Modular Mill, Refer page D5 about tightening torque

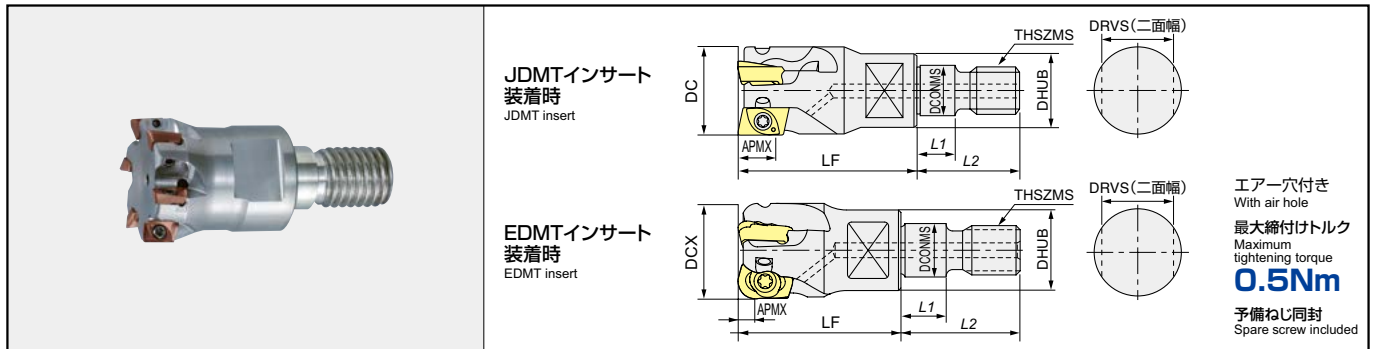

商品コード Item code	在庫 Stock	刃数 No. of flutes	寸法 Size(mm)									適用インサート Inserts	希望小売価格(円) Suggested retail price (¥)
			DC DCX	LF	APMX	DCONMS	THSZMS	DHUB	L1	L2	DRVS		
ASMM0708R-1	●	1	8	20	5 (0.3)*	6.5	M6	9.8	5.5	14.5	7	JDMT0702○○R EDMT070220R(-T)	22,290
ASMM0710R-2	●	2	10	20		6.5	M6	9.4	5.5	14.5	7		22,290
ASMM0711R-2	●	2	11	20		6.5	M6	9.8	5.5	14.5	7		22,290
ASMM0712R-3	●	3	12	20		6.5	M6	9.8	5.5	14.5	7		26,980
ASMM0712R-2		2	12	20		6.5	M6	9.8	5.5	14.5	7		—
ASMM0716R-4	●	4	16	25		8.5	M8	12.8	5.5	17	10		38,710
ASMM0716R-3		3	16	25		8.5	M8	12.8	5.5	17	10		—
ASMM0720R-5	●	5	20	30		10.5	M10	17.8	5.5	19	15		44,580
ASMM0720R-4		4	20	30		10.5	M10	17.8	5.5	19	15		—
ASMM0725R-6	●	6	25	30		12.5	M12	20.8	5.5	22	17		51,620
ASMM0725R-5		5	25	30		12.5	M12	20.8	5.5	22	17		—
ASMM0732R-8	●	8	32	30		17	M16	28.8	6	23	22		64,520
ASMM0732R-5		5	32	30		17	M16	28.8	6	23	22		—

*EDMT070220R(-T)をご使用の場合はAPMXは()寸法になります。 *When using EDMT070220R (-T), APMX is in () dimensions.

【注意】モジュラール用専用シャンク、専用アーバの「工具端面」「モジュラールねじ部」にグリースなどの潤滑剤は塗布しないでください。

【Note】 Do not apply lubricants such as grease, etc. to the "contact faces" and "modular screws" of the "modular mill", "dedicated shanks" and "dedicated arbor".

インサート Inserts

○は数字が入ります。 Numeric figure in a circle ○

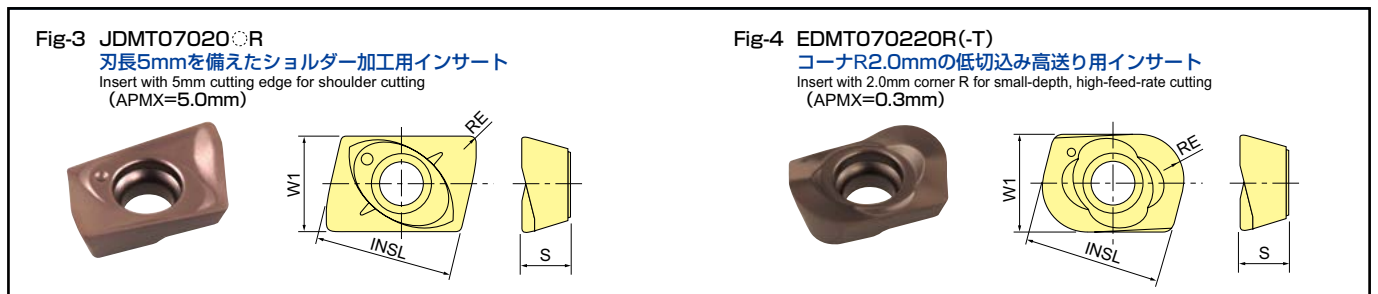

商品コード Item code	精度 Tolerance class	AJコーティング AJ Coating			THコーティング TH Coating	DLCコーティング DLC Coating	寸法 Size (mm)				形状 Shape	希望小売価格(円) Suggested retail price (¥)	
		JP4105	JP4120	JM4160	PTH30E	SD5010	INSL	W1	RE	S		AJコーティング THコーティング AJ,TH Coating	SD5010
JDMT070202R	M級 M	●	●	●	●	●	6.4	4.3	0.2	2.45	Fig-3	910	1,270
JDMT070204R		●	●	●	●	●	6.4	4.3	0.4	2.45		910	1,270
JDMT070208R		●	●	●	●	●	6.4	4.3	0.8	2.45		910	1,270
EDMT070220R(-T)		●	●	●			6.4	4.3	2	2.5	Fig-4 標準タイプ Standard type	910	—
EDMT070220R		●	●	●			6.4	4.3	2	2.5	Fig-4 低抵抗タイプ Low cutting force type	910	—

■：一般切削・第一推奨
General cutting, First recommended

□：一般切削・第二推奨
General cutting, Second recommended

Indexable Tools Square End Mills

アルファスーパーエクセレントミニ ASM

EDMTタイプインサートの肩削り標準切削条件: 低切込み高送り Side Milling standard cutting conditions for EDMT-type inserts : Low cutting depth, high feed rate

※赤字は第一推奨材種です。Red indicates primary recommended grade.

被削材 Work material	推奨材種 Recommended grade	切削速度vc Cutting speed vc (m/min)	切削条件 Cutting conditions	φ8	φ10	φ12	φ14	φ16	φ20	φ25	φ32
				(1枚刃) 1 Flute	(2枚刃) 2 Flutes	(3枚刃) 3 Flutes	(3枚刃) 3 Flutes	(4枚刃) 4 Flutes	(5枚刃) 5 Flutes	(6枚刃) 6 Flutes	(8枚刃) 8 Flutes
炭素鋼 合金鋼 ダイス鋼 S-C SCM SKD SKT <30HRC Carbon steels Alloy steels Die tool steels	※ JP4120	vc=100~180	n(min ⁻¹)	4,780	3,820	3,180	2,730	2,390	1,910	1,530	1,190
			Vc(m/min)	120	120	120	120	120	120	120	
			Vf(mm/min)	~2,870	~4,590	~5,730	~6,550	~7,640	~7,640	~7,340	~7,640
			fz(mm/t)	~0.6	~0.6	~0.6	~0.8	~0.8	~0.8	~0.8	~0.8
			ap(mm)	0.3	0.3	0.3	0.3	0.3	0.3	0.3	0.3
			ae(mm)	~3	~5	~7	~8	~10	~11	~17	~22
			Q(cm ³ /min)	3	7	12	16	23	25	37	50
			プリハードン鋼 合金鋼 ダイス鋼 SCM SKD SKT 30~40HRC Pre-harden steels Alloy steels Die tool steels	JP4120	vc=100~160	n(min ⁻¹)	4,380	3,500	2,920	2,500	2,190
Vc(m/min)	110	110				110	110	110	110	110	110
Vf(mm/min)	~2,630	~4,200				~5,260	~6,010	~7,010	~7,010	~6,730	~7,010
fz(mm/t)	~0.6	~0.6				~0.6	~0.8	~0.8	~0.8	~0.8	~0.8
ap(mm)	0.3	0.3				0.3	0.3	0.3	0.3	0.3	0.3
ae(mm)	~3	~5				~7	~8	~10	~11	~17	~22
Q(cm ³ /min)	2	6				11	14	21	23	34	46
プリハードン鋼 合金鋼 ダイス鋼 SCM SKD SKT 40~50HRC Pre-harden steels Alloy steels Die tool steels	JP4120	vc=80~120				n(min ⁻¹)	3,580	2,870	2,390	2,050	1,790
			Vc(m/min)	90	90	90	90	90	90	90	90
			Vf(mm/min)	~1,430	~2,290	~2,870	~3,690	~4,300	~4,300	~4,130	~4,300
			fz(mm/t)	~0.4	~0.4	~0.4	~0.6	~0.6	~0.6	~0.6	~0.6
			ap(mm)	0.3	0.3	0.3	0.3	0.3	0.3	0.3	0.3
			ae(mm)	~3	~5	~7	~8	~10	~11	~17	~22
			Q(cm ³ /min)	1	3	6	9	13	14	21	28
			ステンレス鋼 SUS Stainless steels	JM4160 JP4120	vc=80~120	n(min ⁻¹)	3,580	2,870	2,390	2,050	1,790
Vc(m/min)	90	90				90	90	90	90	90	90
Vf(mm/min)	~1,430	~2,290				~2,870	~3,690	~4,300	~4,300	~4,130	~4,300
fz(mm/t)	~0.4	~0.4				~0.4	~0.6	~0.6	~0.6	~0.6	~0.6
ap(mm)	0.3	0.3				0.3	0.3	0.3	0.3	0.3	0.3
ae(mm)	~3	~5				~7	~8	~10	~11	~17	~22
Q(cm ³ /min)	1	3				6	9	13	14	21	28
鋳鉄 FC FCD Cast irons	JP4120	vc=120~220				n(min ⁻¹)	5,970	4,780	3,980	3,410	2,990
			Vc(m/min)	150	150	150	150	150	150	150	150
			Vf(mm/min)	~3,580	~5,730	~7,170	~8,190	~9,550	~9,550	~9,170	~9,550
			fz(mm/t)	~0.6	~0.6	~0.6	~0.8	~0.8	~0.8	~0.8	~0.8
			ap(mm)	0.3	0.3	0.3	0.3	0.3	0.3	0.3	0.3
			ae(mm)	~3	~5	~7	~8	~10	~11	~17	~22
			Q(cm ³ /min)	3	9	15	20	29	32	47	63
			焼入れ鋼 50~60HRC Hardened steels	JP4105 JP4120	vc=60~100	n(min ⁻¹)	2,390	1,910	1,590	1,360	1,190
Vc(m/min)	60	60				60	60	60	60	60	60
Vf(mm/min)	~720	~1,150				~1,430	~1,630	~1,900	~1,900	~1,820	~1,900
fz(mm/t)	~0.3	~0.3				~0.3	~0.4	~0.4	~0.4	~0.4	~0.4
ap(mm)	0.2	0.2				0.2	0.2	0.2	0.2	0.2	0.2
ae(mm)	~3	~5				~7	~8	~10	~11	~17	~22
Q(cm ³ /min)	0.4	1				2	2	3	3	6	8

- [注意]**
- ①被削材、加工形状に合わせて、適切なクーラントを使用してください。
 - ②この切削条件表は切削条件の目安を示すものです。実際の加工では加工形状、目的、使用機械等により条件を調整してください。
 - ③溝切削、傾斜切削の場合、送り速度は70%を目安として下さい。
 - ④インサートの交換は早めに行い、過度の使用による破損を防止して下さい。
 - ⑤排出した切りくずは飛散し作業者を切傷させ、火傷あるいは目に入って負傷させる恐れがありますので、ご使用に際してはその周囲に安全カバーを取り付け保護メガネ等の保護具を着用して、安全な環境で作業される事をお願いします。
 - ⑥不水溶性切削油は、火災の恐れがありますので使用しないで下さい。
 - ⑦アンダーカット型シャンクは一回当たりの送り量(fz)を50~70%を目安に低減して下さい。

- [Note]**
- ①Use the appropriate coolant for the work material and machining shape.
 - ②These conditions are for general guidance; in actual machining conditions adjust the parameters according to your actual machine and work-piece conditions.
 - ③For slotting or ramping, feed rate should be set to 70% as general criteria.
 - ④Ensure to index the insert at the correct time to ensure safety of the tool-body.
 - ⑤The evacuation of swarf can cause burns, cuts or damage to the eyes please ensure the correct safety cover is fitted around the machine, and necessary personal protection equipment is worn by the machine operator.
 - ⑥Due to fire risks do not use neat cutting oil as a coolant.
 - ⑦When using an undercut type shank, as a general rule the feed rate per flute (fz) should be reduced to 50~70% of the value listed in the standard cutting conditions.

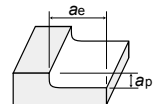

EDMTタイプインサートの傾斜切削

Ramping with EDMT-type inserts

中心まで切れ刃がないため傾斜角度と穴径は制限されますが、下図に示すように傾斜切削やヘリカル切削にて、下穴がなくともダイレクトに彫り込み加工が可能です。

Since the cutting flute do not extend to the center, there are limitations on the ramp angle and hole diameter, but as shown below, cutting by direct milling without a pilot hole is possible for ramping and helical milling. (mm)

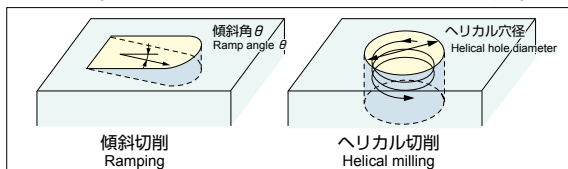

インサート Inserts	EDMT070220R(-T)									
工具径DCX Tool dia.	φ8	φ10	φ12	φ14	φ16	φ17	φ20	φ21	φ25	φ32
推奨θ Recommended θ	0.5°以下									
ヘリカル穴径 Hole Dia	10~15	13~19	17~23	21~27	25~31	27~33	33~39	35~41	43~49	57~63

- [注意]**
- ①被削材、加工形状に合わせて、適切なクーラントを使用してください。
 - ②この切削条件表は切削条件の目安を示すものです。実際の加工では加工形状、目的、使用機械等により条件を調整してください。
 - ③穴径が上記範囲外の場合は下穴をあけて加工してください。

- [Note]**
- ①Use the appropriate coolant for the work material and machining shape.
 - ②These conditions are for general guidance; in actual machining conditions adjust the parameters according to your actual machine and work-piece conditions.
 - ③For hole diameters outside the ranges listed above, a pilot hole should be drilled before milling.

○ 高能率ツーリングシステムと切削条件選定 High-efficient tooling system and selecting a cutting conditions

- **ASMは多種のツーリングシステムとの組み合わせにより、加工形状に合わせた高能率加工が可能です。**
 • ASM enables high-efficient machining according to cutting shape by combined use with various tooling systems.

特長と切削条件 Features & Cutting Conditions

	シャンクタイプホルダ Shank type holder	モジュラータイプホルダ + モジュラーアーバ Modular type holder + Modular arbor	モジュラータイプホルダ + 超硬シャンク Modular type holder + Carbide Shank
加工深さ Cutting depth			
工具突出し長さ L / 工具径 D / Tool overhang length L / Tool dia. (L/D)			
一般的な組み合わせ General-purpose combination	標準切削条件参照 Refer to standard cutting conditions	工具突出し長さを最短にできます。機械剛性を有効活用しますので、小型低剛性機械での使用に効果的です。 Tool overhang length can be minimized. By making effective use of machine tool rigidity, it can be used effectively on small-sized, low-rigidity machines.	長い工具突出し長さが必要な加工に効果を発揮します。 Exhibits good machining effects when long tool overhang lengths are necessary.
L/D ≥ 3.5	【注意】③ 一刃当たりの送り量 (fz) を標準切削条件の50~70%を目安に低減して調整下さい As a general rule, the feed rate per flute (fz) should be reduced to between 50% and 70% of the value listed in the standard cutting conditions and adjusted.	L/D ≥ 3.5 一刃当たりの送り量 (fz) を標準切削条件の50~70%を目安に低減して調整下さい As a general rule, the feed rate per flute (fz) should be reduced to between 50% and 70% of the value listed in the standard cutting conditions and adjusted.	L/D ≥ 5
④	超硬シャンクASC10-6.5-114-49/24をL/D ≥ 5で御使用の際は、fz=0.3mm/t, ap=0.2mm未満の切削条件を選定して下さい。		【注意】④ 一刃当たりの送り量 (fz) を標準切削条件の50~70%を目安に低減して調整下さい As a general rule, the feed rate per flute (fz) should be reduced to between 50% and 70% of the value listed in the standard cutting conditions and adjusted.

- 【注意】**
- ①本表は肩削り時の一般的な条件です。機械剛性やツーリング、加工物の形状に合わせて調整して下さい。
 - ②ASMφ20~φ32をBT30/40主軸にてご使用の際はモジュラータイプホルダ+モジュラーアーバの組み合わせを推奨します。
 - ③アンダーカット型シャンクASM0710S08R-2, ASM0712S10R-2をご使用の際は標準切削条件の一刃当たりの送り量 (fz) をさらに50~70%を目安に低減して下さい。
 - ④超硬シャンクASC10-6.5-114-49/24をL/D ≥ 5で御使用の際は、fz=0.3mm/t, ap=0.2mm未満の切削条件を選定して下さい。
- 【Note】**
- ①This table shows general conditions for shoulder cutting. Adjustments should be made according to machine rigidity or tooling and the shape of the subject for cutting.
 - ②When using ASM φ20 to φ32 inserts in a BT30 or BT40 arbor, the use of a combination of modular type holder and modular arbor is recommended.
 - ③When using an ASM0710S08R-2 or ASM0712S10R-2 undercut type shank, as a general rule the feed rate per flute (fz) should be reduced to in addition, 50~70% of the value listed in the standard cutting conditions.
 - ④Select the cutting condition of fz=0.3mm/t and less than ap=0.2mm when you use carbide shank ASC10-6.5-114-49/24 with L/D ≥ 5.

○ 2種類のインサート形状 2 kinds of insert geometry

- **標準タイプインサート(T型)と低抵抗タイプインサートの2種類を準備しました。**
- **低抵抗タイプインサートは掘込み加工時の隅部での切削抵抗を約10%低減します。**
 • 2 kinds of inserts are available: Standard type inserts (T-type) and low-cutting force-type inserts.
 • Low cutting force-type inserts reduce cutting force at the corners when pocketing by approximately 10%.



○ 加工プログラム Cutting programs

- **コーナRは正R形状を採用。プログラミングR定義は必要ありません。**
 • Regular R shape is used for corner R. There is no need for an approximate R definition.

● **工具のコーナはR2.0です。(高送り工具特有の削り残しはありません)**

● **軸方向の切込みapは0.3mm以下に設定してください。(ap ≤ 0.3mm)**

• Tool corner is R2.0 (Unique to high-feed-rate tools to leave no uncut areas.)
 • Axial direction cutting depth ap should be set to 0.3 mm or less. (ap ≤ 0.3 mm)

【注意】

- ①切削径=DCX - 4mm
- ②ポケット加工を行う際には、切込み幅(ae)に注意し、削り残しの発生を抑えて下さい。
(推奨切込み幅ae=切削径 × 0.5~0.8(mm))
- ③立ち壁隅部を加工する際は、ツールパスのコーナ部にRを設けることでより安定した加工が可能です。

【Note】

- ①Cutting dia. =DCX - 4mm
- ②When performing pocket cutting, be careful of the cutting width (ae) and generated variations due to remaining work to cut. (Recommended Cutting width ae=Cutting dia.×0.5~0.8(mm))
- ③When cutting the corner area of a vertical wall, setting the tool path corner area to R will enable more stable cutting.

Indexable Tools Square End Mills

JDMTタイプインサートの肩削り標準切削条件 Side Milling standard cutting conditions for JDMT-type inserts

切込み深さ a_p と切込み幅 a_e は次頁の「工具突出し量(OH)と切込み領域」を目安して下さい。
It is make standard that the depth cut a_p and the cutting width a_e be as shown in Tool Overhang (OH) and Cutting Region on the next page.

被削材硬度 > 40HRCの切込み深さ a_p と切込み幅 a_e は表中の条件を目安して下さい。
Work Hardness > Please use the conditions in the table as a guideline for the cut depth a_p and width a_e of 40HRC.

※赤字は第一推奨材種です。
Red indicates primary recommended grade.

被削材 Work material	推奨材種 Recommended grade	切削速度 v_c Cutting speed v_c (m/min) — 刃当たりの送り f_z Feed rate per flute f_z (mm/t)	切削条件 Cutting conditions	$\phi 8$	$\phi 10$	$\phi 12$	$\phi 14$	$\phi 16$	$\phi 20$	$\phi 25$	$\phi 32$	
				(1枚刃) 1 Flute	(2枚刃) 2 Flutes	(3枚刃) 3 Flutes	(3枚刃) 3 Flutes	(4枚刃) 4 Flutes	(5枚刃) 5 Flutes	(6枚刃) 6 Flutes	(8枚刃) 8 Flutes	
炭素鋼 合金鋼 S-C SCM <30HRC Carbon steels Alloy steels	※JP4120 PTH30E	$v_c=150\sim 200$ $f_z=0.04\sim 0.09$	n (min ⁻¹)	7,170	5,730	4,780	4,090	3,580	2,870	2,290	1,790	
			v_c (m/min)	180	180	180	180	180	180	180	180	180
			v_f (mm/min)	500	800	1,000	860	1,000	1,000	960	1,000	1,000
			f_z (mm/t)	0.07	0.07	0.07	0.07	0.07	0.07	0.07	0.07	0.07
ダイス鋼 SKD SKT <30HRC Die tool steels	JP4120 PTH30E	$v_c=130\sim 180$ $f_z=0.04\sim 0.07$	n (min ⁻¹)	5,970	4,780	3,980	3,410	2,990	2,390	1,910	1,490	
			v_c (m/min)	150	150	150	150	150	150	150	150	150
			v_f (mm/min)	360	570	720	610	720	720	690	720	
			f_z (mm/t)	0.06	0.06	0.06	0.06	0.06	0.06	0.06	0.06	
プリハードン鋼 合金鋼、ダイス鋼 SCM SKD SKT 30~40HRC Pre-hardened steels Alloy steels, Die tool steels	JP4120 PTH30E	$v_c=100\sim 150$ $f_z=0.04\sim 0.07$	n (min ⁻¹)	4,780	3,820	3,180	2,730	2,390	1,910	1,530	1,190	
			v_c (m/min)	120	120	120	120	120	120	120	120	
			v_f (mm/min)	290	460	570	490	570	570	550	570	
			f_z (mm/t)	0.06	0.06	0.06	0.06	0.06	0.06	0.06	0.06	
プリハードン鋼 合金鋼 ダイス鋼 SCM SKD SKT 40~50HRC Pre-hardened steels Alloy steels Die tool steels	JP4120	$v_c=80\sim 120$ $f_z=0.04\sim 0.07$	n (min ⁻¹)	3,580	2,860	2,390	2,050	1,790	1,430	1,150	900	
			v_c (m/min)	90	90	90	90	90	90	90	90	
			v_f (mm/min)	220	340	430	370	430	430	410	430	
			f_z (mm/t)	0.06	0.06	0.06	0.06	0.06	0.06	0.06	0.06	
			a_p (mm)	2	2	2	2	2	2	2	2	
			a_e (mm)	0.05D	0.05D	0.05D	0.05D	0.05D	0.05D	0.05D	0.05D	
ステンレス鋼 SUS Stainless steels	JM4160 PTH30E JP4120	$v_c=100\sim 150$ $f_z=0.04\sim 0.09$	n (min ⁻¹)	4,780	3,820	3,180	2,730	2,390	1,910	1,530	1,190	
			v_c (m/min)	120	120	120	120	120	120	120	120	
			v_f (mm/min)	290	460	570	490	570	570	550	570	
			f_z (mm/t)	0.06	0.06	0.06	0.06	0.06	0.06	0.06	0.06	
鋳鉄 FC FCD Cast irons	JP4120 PTH30E	$v_c=130\sim 180$ $f_z=0.04\sim 0.10$	n (min ⁻¹)	5,970	4,780	3,980	3,410	2,990	2,390	1,910	1,490	
			v_c (m/min)	150	150	150	150	150	150	150	150	
			v_f (mm/min)	420	670	840	720	840	840	800	840	
			f_z (mm/t)	0.07	0.07	0.07	0.07	0.07	0.07	0.07	0.07	
アルミ合金 (湿式) Aluminum alloys (wet condition)	SD5010 PTH30E JP4120	$v_c=200\sim 500$ $f_z=0.04\sim 0.12$	n (min ⁻¹)	11,940	9,550	7,960	6,820	5,970	4,780	3,820	2,990	
			v_c (m/min)	300	300	300	300	300	300	300	300	
			v_f (mm/min)	960	1,530	1,910	1,640	1,910	1,910	1,830	1,910	
			f_z (mm/t)	0.08	0.08	0.08	0.08	0.08	0.08	0.08	0.08	
焼入れ鋼 50~60HRC Hardened steels	JP4105 JP4120	$v_c=60\sim 100$ $f_z=0.04\sim 0.07$	n (min ⁻¹)	2,390	1,910	1,590	1,360	1,190	950	760	600	
			v_c (m/min)	60	60	60	60	60	60	60	60	
			v_f (mm/min)	140	230	290	240	290	290	270	290	
			f_z (mm/t)	0.06	0.06	0.06	0.06	0.06	0.06	0.06	0.06	
			a_p (mm)	2	2	2	2	2	2	2	2	
			a_e (mm)	0.05DC	0.05DC	0.05DC	0.05DC	0.05DC	0.05DC	0.05DC	0.05DC	

- 【注意】**
- 被削材、加工形状に合わせて、適切なクーラントを使用してください。
 - この切削条件表は切削条件の目安を示すものです。実際の加工では加工形状、目的、使用機械等により条件を調整してください。
 - 溝切削、傾斜切削の場合、送り速度は70%を目安として下さい。
 - インサートの交換は早めに行い、過度の使用による破損を防止して下さい。
 - 排出した切りくずは飛散し作業者を切傷させ、火傷あるいは目に入って負傷させる恐れがありますので、ご使用に際してはその周囲に安全カバーを取り付け保護メガネ等の保護具を装着して、安全な環境で作業される事をお願い致します。
 - 不水溶性切削油は、火災の恐れがありますので使用しないで下さい。

- 【Note】**
- Use the appropriate coolant for the work material and machining shape.
 - These conditions are for general guidance; in actual machining conditions adjust the parameters according to your actual machine and work-piece conditions.
 - For slotting or ramping, feed rate should be set to 70% as general criteria.
 - Ensure to index the insert at the correct time to ensure safety of the tool-body.
 - The evacuation of swarf can cause burns, cuts or damage to the eyes please ensure the correct safety cover is fitted around the machine, and necessary personal protection equipment is worn by the machine operator.
 - Due to fire risks do not use neat cutting oil as a coolant.

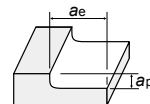

JDMTタイプインサートの傾斜切削

Ramping with JDMT-type inserts

中心まで切れ刃がないため傾斜角度と穴径は制限されますが、下図に示すように傾斜切削やヘリカル切削にて、下穴がなくともダイレクトに彫り込み加工が可能です。
Since the cutting flute do not extend to the center, there are limitations on the ramp angle and hole diameter, but as shown below, cutting by direct milling without a pilot hole is possible for ramping and helical milling.

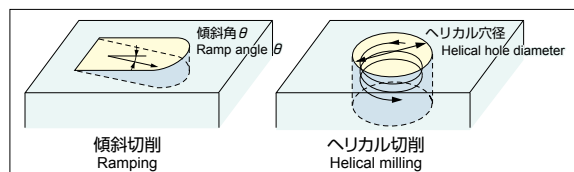

インサート Inserts	JDMT0702 \odot OR									
工具径DC Tool dia.	$\phi 8$	$\phi 10$	$\phi 12$	$\phi 14$	$\phi 16$	$\phi 17$	$\phi 20$	$\phi 21$	$\phi 25$	$\phi 32$
推奨 θ Recommended θ	1°以下									
ヘリカル穴径 Hole Dia	10~15	13~19	17~23	21~27	25~31	27~33	33~39	35~41	43~49	57~63

- 【注意】**
- 被削材、加工形状に合わせて、適切なクーラントを使用してください。
 - この切削条件表は切削条件の目安を示すものです。実際の加工では加工形状、目的、使用機械等により条件を調整してください。
 - 穴径が上記範囲外の場合は下穴をあけて加工してください。

- 【Note】**
- Use the appropriate coolant for the work material and machining shape.
 - These conditions are for general guidance; in actual machining conditions adjust the parameters according to your actual machine and work-piece conditions.
 - For hole diameters outside the ranges listed above, a pilot hole should be drilled before milling.

工具突出し(OH)と切込み限界 Relation between Tool Overhang (OH) and Limits of the cutting region

下記の切削領域線図は工具突出し量(OH)ごとの切込み条件選定の目安を示します。
切込み限界付近にてビビリ振動が発生する場合は、一刃当たりの送り量(f_z)を低減する方法で調整して下さい。

The cutting region curves shown below indicate criteria for selecting cutting conditions at each overhang (OH). If chattering occurs near the limits of the cutting region, make adjustments by reducing the per-flute feed rate (f_z).

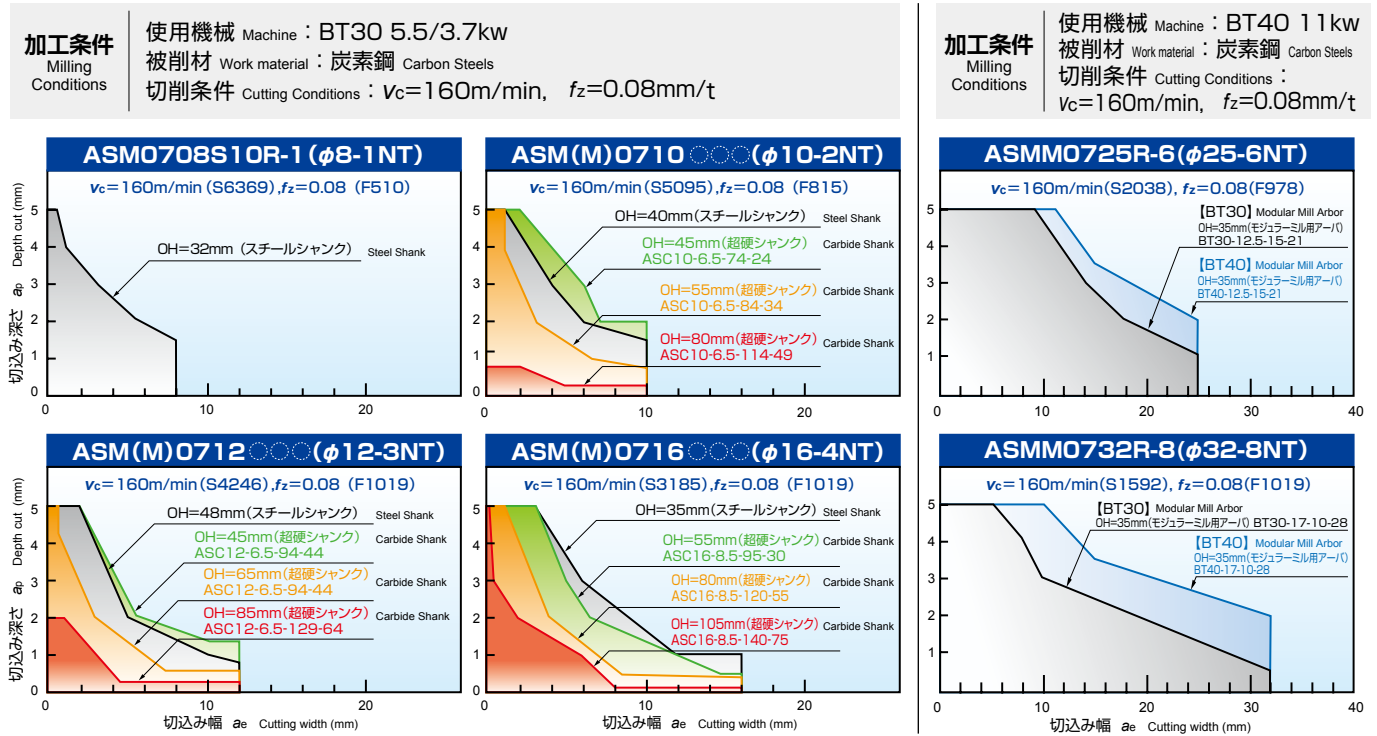

※アンダーカット型シャンク ASMO710S08R-2 は切込み領域 ASMO710S10R-2 の50%を ASMO712S10R-2 は切込み領域 ASMO710S10R-2 を目安に切り込み量を決定して下さい。
As a general rule, the cutting amount for ASMO710S08R-2 undercut type shank should be set within 50% of the cutting region for ASMO710S10R-2, and the cutting amount for ASMO712S10R-2 should be set within the cutting region for ASMO710S10R-2.

アルミニウム合金及び銅切削条件 Cutting conditions for cutting aluminum alloy and copper

<肩削り> Shoulder cutting : $ae=0.5DC$ 推奨材種 Recommended grade : SD5010

被削材 Work material		φ8	φ10	φ12	φ14	φ16	φ17	φ20	φ21	φ25	φ32
アルミニウム合金展伸材 Expanded aluminum alloy material A5052,A7075等, etc. (ウェット: 水溶性) (Wet: Water-soluble agent)	回転数 n (min^{-1})	11,900	12,700	10,600	11,400	9,900	9,400	9,500	9,100	7,600	6,000
	送り速度 v_f (mm/min)	950	2,040	2,550	2,730	3,180	3,000	3,820	3,640	3,670	3,820
	一刃当りの送り f_z (mm/t)	0.08	0.08	0.08	0.08	0.08	0.08	0.08	0.08	0.08	0.08
	切削速度 v_c (m/min)	300	400	400	500	500	500	600	600	600	600
	軸方向切り込み a_p (mm)	2	2	2	2	2	2	2	2	2	2
アルミニウム合金鋳物 Cast aluminum alloy material AC4A,ADC12等, etc. (ウェット: 水溶性) (Wet: Water-soluble agent)	回転数 n (min^{-1})	9,900	11,100	9,300	9,100	8,000	7,500	8,000	7,600	6,400	5,000
	送り速度 v_f (mm/min)	800	1,780	2,230	2,180	2,550	2,400	3,180	3,030	3,060	3,180
	一刃当りの送り f_z (mm/t)	0.08	0.08	0.08	0.08	0.08	0.08	0.08	0.08	0.08	0.08
	切削速度 v_c (m/min)	250	350	350	400	400	400	500	500	500	500
	軸方向切り込み a_p (mm)	2	2	2	2	2	2	2	2	2	2
純銅 Pure copper C1100,C1020等, etc. (ウェット: 水溶性) (Wet: Water-soluble agent)	回転数 n (min^{-1})	9,900	9,500	8,000	6,800	6,000	5,600	4,800	4,500	3,800	3,000
	送り速度 v_f (mm/min)	800	1,530	1,910	1,640	1,910	1,800	1,910	1,820	1,830	1,910
	一刃当りの送り f_z (mm/t)	0.08	0.08	0.08	0.08	0.08	0.08	0.08	0.08	0.08	0.08
	切削速度 v_c (m/min)	250	300	300	300	300	300	300	300	300	300
	軸方向切り込み a_p (mm)	2	2	2	2	2	2	2	2	2	2

[注意]

- 被削材、加工形状に合わせて、適切なクーラントを使用してください。
- この切削条件表は切削条件の目安を示すものです。実際の加工では加工形状、目的、使用機械等により条件を調整してください。
- 溝切削の場合、送り速度は70%を目安として下さい。
- $L/D=4$ 以上の場合は回転数と送り速度を50%を目安に下げて(0.5倍して)ご使用ください。また、銅加工時の軸方向切り込みは1mm以下として下さい。
- スプラッシュガード付きの機械でご使用ください。ご使用に際しては保護メガネ等の保護具を着用して、安全な環境で作業される事をお願いいたします。
- 上記条件表の回転数まで上がらない機械の場合は使用可能な回転数に設定して、送り速度は f_z 値で計算してください。
- ご使用されるミールリングチャックの許容回転数以内でご使用ください。許容回転数が上記条件表の回転数未満の場合は使用可能な回転数に設定して、送り速度は f_z 値で計算してください。

[Note]

- Use the appropriate coolant for the work material and machining shape.
- These conditions are for general guidance; in actual machining conditions adjust the parameters according to your actual machine and work-piece conditions.
- For slotting, feed rate should be set to 70% as general criteria.
- When $L/D=4$ or higher, reduce rotation speed and feed rate by 50% (set to 0.5 × stated values) as general criteria. In addition, when machining copper, set cutting depth in axial direction to 1mm or less.
- Use on a machine equipped with splashguards. During use, be sure to wear protective equipment such as safety glasses, and always perform work in a safe environment.
- When using a machine that cannot provide the rotation speed shown above, set the highest rotation speed possible and calculate the feed rate using the f_z value.
- Be sure to use this tool at rotation speeds within the acceptable range for the milling chuck being used. If the acceptable rotation speed range is below the rotation speed shown above, set the highest acceptable rotation speed and calculate the feed rate using the f_z value.

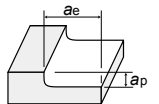

High Feed End Mill AHU

アルファ超快削エンドミル AHU

- 切れ味と刃先強度を兼ね備えたハイレーキ刃形のショルダーミル。
- 傾斜加工も可能な多機能工具でブレード加工に適しています。
- ・ Shoulder mill with good cutting performance and cutting edge strength.
- ・ Multifunction tool which can perform inclined cutting is ideal for blade cutting.



AHU(L)1○○○R-○ シャンクタイプ Shank type

○は数字が入ります。 Numeric figure in a circle ○

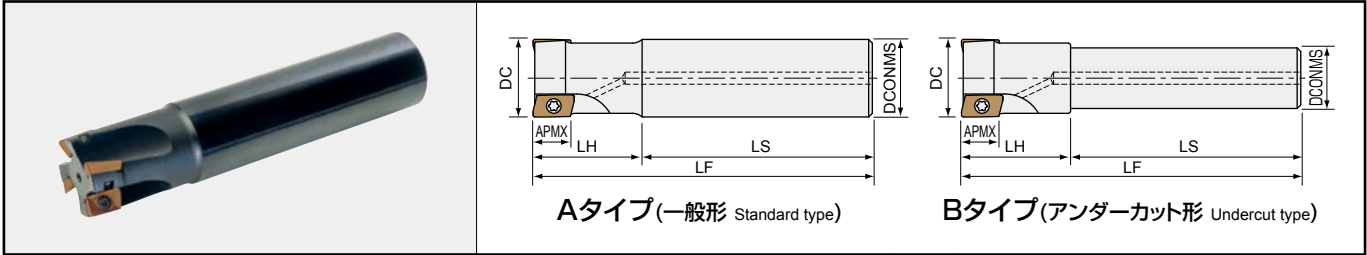

標準形 Regular shank type	商品コード Item code	在庫 Stock	刃数 No. of flutes	寸法 Size(mm)						形状 Shape	適用インサート Inserts	希望小売価格(円) Suggested retail price (¥)
				DC	LF	APMX	LH	LS	DCONMS			
標準形 Regular shank type	AHU1016R-2	●	2	16	100	9 (5)*	30	70	16	A	JDMT1003○○R	35,780
	AHU1020R-3	●	3	20	110		30	80	20	A	JDMT1003○○R-FW	44,120
	AHU1025R-4	●	4	25	120		35	85	25	A	JDMT1003○○R-B5/C5*	51,390
	AHU1030R-5	●	5	30	120		45	75	32	A	JDET1003○○R-FF	59,600
	AHU1032R-5	●	5	32	130		45	85	32	A	JDET100304R-FA	62,890
	AHU1525R-2	●	2	25	125	14 (7)*	40	85	25	A	JDMT1505○○R JDMT1505○○R-FW JDMT150508R-TFW JDMT1505○○R-B7/C7* JDET1505○○R-FF JDET1505○○R-FA	40,710
	AHU1530R-2	●	2	30	130		45	85	25	B		42,360
	AHU1532R-3	●	3	32	140		45	95	32	A		45,520
	AHU1535R-3	●	3	35	140		45	95	32	B		50,330
	AHU1540R-2	●	2	40	140		45	95	32	B		46,580
	AHU1540R-3	●	3	40	140		45	95	32	B		49,860
	AHU1540R-4	●	4	40	140		45	95	32	B		53,150
	AHU1550R-3	●	3	50	140		45	95	32	B		56,080
	AHU1550R-5	●	5	50	140		45	95	32	B		62,650
ロングシャンク形 Long shank type	AHUL1016R-2	●	2	16	150		9 (5)*	50	100	16		A
	AHUL1020R-2	●	2	20	160	60		100	20	A	45,290	
	AHUL1020R-3	●	3	20	160	60		100	20	A	48,570	
	AHUL1021R-3	●	3	21	160	30		130	20	B	49,040	
	AHUL1025R-2	●	2	25	180	75		105	25	A	46,220	
	AHUL1025R-3	●	3	25	180	75		105	25	A	49,510	
	AHUL1026R-3	●	3	26	180	35		145	25	B	50,570	
	AHUL1030R-2	●	2	30	180	45		135	25	B	50,570	
	AHUL1030R-3	●	3	30	180	45		135	25	B	53,850	
	AHUL1032R-4	●	4	32	200	90		110	32	A	57,020	
	AHUL1035R-2	●	2	35	200	45	155	32	B	52,560		
	AHUL1035R-4	●	4	35	200	45	155	32	B	59,130		
	AHUL1525R-2	●	2	25	180	14 (7)*	75	105	25	A	JDMT1505○○R JDMT1505○○R-FW JDMT150508R-TFW JDMT1505○○R-B7/C7* JDET1505○○R-FF JDET1505○○R-FA	44,940
	AHUL1530R-2	●	2	30	180		45	135	25	B		46,920
	AHUL1532R-3	●	3	32	200		90	110	32	A		50,210
	AHUL1535R-2	●	2	35	200		45	155	32	B		51,160
	AHUL1535R-3	●	3	35	200		45	155	32	B		54,430
	AHUL1540R-2	●	2	40	220		45	175	32	B		51,970
	AHUL1540R-3	●	3	40	220		45	175	32	B		55,260
	AHUL1540R-4	●	4	40	220		45	175	32	B		58,540
AHUL1540R-5	●	5	40	220	45		175	32	B	61,830		
AHUL1550R-4	●	4	50	220	45		175	42	B	64,290		

【注意】※JDMT1003○○R-B5/C5、JDMT1505○○R-B7/C7をご使用の場合は最大切込みAPMXは()寸法になります。

【Note】※ The APMX in the case of using JDMT1003○○R-B5/C5, JDMT1505○○R-B7/C7 is a value shown in ().

●印：標準在庫品です。 ●：Stocked items.

AHUM1○○○R(-M○○) モジュラータイプ Modular type

モジュラーミル用シャンクはD2頁を、締め付けトルクについてはD5頁を参照ください。
Refer page D2 about the shanks for Modular Mill, Refer page D5 about tightening torque

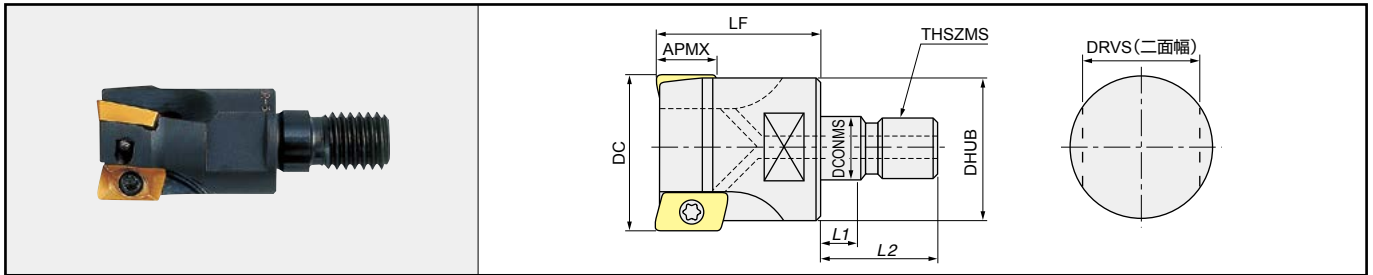

商品コード Item code	在庫 Stock	刃数 No. of flutes	寸法 Size(mm)									適用インサート Inserts	希望小売価格(円) Suggested retail price (¥)
			DC	LF	APMX	DCONMS	THSZMS	DHUB	L1	L2	DRVS		
AHUM1016R-2	●	2	16	25	9 (5)*	8.5	M8	12.8	5.5	17	10	JDMT1003○○R JDMT1003○○R-FW JDMT1003○○R-B5/C5* JDET1003○○R-FF JDET100304R-FA	35,780
※1 AHUM1018R-2	●	2	18	25		8.5	M8	14.5	5.5	17	10		39,890
※1 AHUM1020R-2-M8	●	2	20	25		8.5	M8	14.5	5.5	17	10		40,830
AHUM1020R-3	●	3	20	30		10.5	M10	17.8	5.5	19	15		44,120
※1 AHUM1022R-3	●	3	22	30		10.5	M10	17.8	5.5	19	15		44,120
※1 AHUM1025R-2-M10	●	2	25	30		10.5	M10	17.8	5.5	19	15		44,820
AHUM1025R-4	●	4	25	35		12.5	M12	20.8	5.5	22	17		51,390
※1 AHUM1028R-4	●	4	28	35		12.5	M12	23	5.5	22	17		55,490
※1 AHUM1030R-2-M12	●	2	30	35		12.5	M12	23	5.5	22	17		49,740
AHUM1030R-5	●	5	30	40		17	M16	28.8	6	23	22		59,600
AHUM1032R-5	●	5	32	40		17	M16	28.8	6	23	22		62,890
※1 AHUM1035R-2	●	2	35	40		17	M16	28.8	6	23	22		55,380
※1 AHUM1035R-5	●	5	35	40		17	M16	28.8	6	23	22		65,230
※1 AHUM1040R-6	●	6	40	40		17	M16	28.8	6	23	22		68,980
AHUM1525R-2	●	2	25	35	14 (7)*	12.5	M12	20.8	5.5	22	17	JDMT1505○○R	40,710
※1 AHUM1528R-2	●	2	28	35		12.5	M12	23	5.5	22	17	JDMT1505○○R-FW	40,710
※1 AHUM1528R-3	●	3	28	35		12.5	M12	23	5.5	22	17	JDMT150508R-TFW	40,710
※1 AHUM1530R-2-M12	●	2	30	35		12.5	M12	23	5.5	22	17	JDMT1505○○R-B7/C7*	42,360
AHUM1530R-3	●	3	30	40		17	M16	28.8	6	23	22	JDET1505○○R-FF	45,520
AHUM1532R-3	●	3	32	40		17	M16	28.8	6	23	22	JDET1505○○R-FA	45,520

- [注意]** ①※ JDMT1003○○R-B5/C5、JDMT1505○○R-B7/C7をご使用の場合は最大切込みAPMXは()寸法になります。
 ②AHUM○○○R-○M○○のモジュラーミルによる溝加工は工具破損の恐れがあります。C153頁記載のモジュラーミル切削領域線図を参考に加工条件を調整してください。
 ③モジュラーミルと超硬シャンクの組合せ表はD4をご覧ください。
 ④モジュラーミル及び専用シャンク、専用アーバの「工具端面」「モジュラーねじ部」にグリースなどの潤滑剤は塗布しないでください。
 ⑤※1と超硬シャンクをセットで使用すると干渉がありません。
- [Note]** ①※ The APMX in the case of using JDMT1003○○R-B5/C5, JDMT1505○○R-B7/C7 is a value shown in ().
 ②Slotting by AHUM○○○R-○M○○ has a possibility that a tool may be damaged. Please adjust a cutting condition with reference to the diagram of C153.
 ③Please refer to the D4 table for the combination of modular mill and carbide shank.
 ④Do not apply lubricants such as grease, etc. to the "contact faces" and "modular screws" of the "modular mill", "dedicated shanks" and "dedicated arbor".
 ⑤When※1 and carbide shank are used together as a set, there is no interference.

AHUB15○○○R(M)-○ ボアタイプ Bore type

○は数字が入ります。 Numeric figure in a circle ○
 ボアタイプ用アーバはD11頁を参照ください。
 Refer page D11 about the bore type arbor

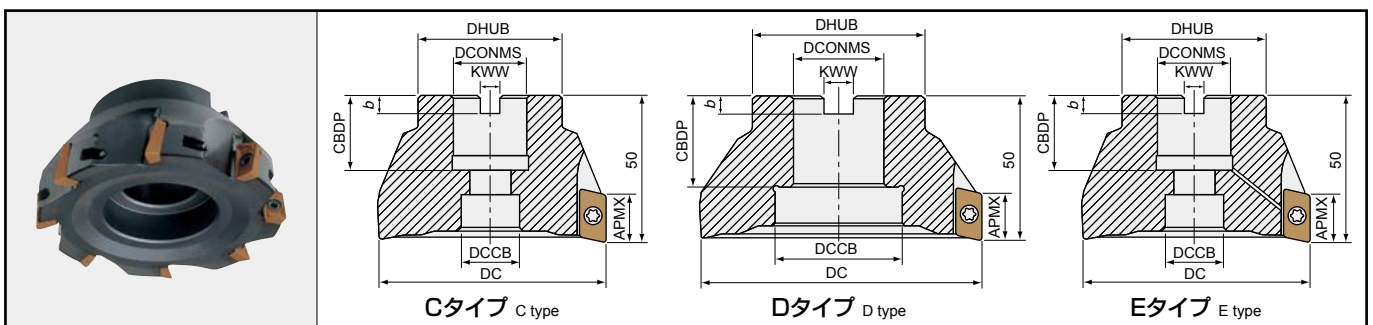



商品コード Item code	在庫 Stock	刃数 No. of flutes	寸法 Size(mm)									形状 Shape	適用インサート Inserts	希望小売価格(円) Suggested retail price (¥)
			DC	APMX	DCONMS	DCCB	DHUB	CBDP	KWW	b				
AHUB1550R-3	●	3	50	14 (7)*	22.225	17	47	20	8.4	5	E	JDMT1505○○R JDMT1505○○R-FW JDMT150508R-TFW JDMT1505○○R-B7/C7* JDET1505○○R-FF JDET1505○○R-FA	69,340	
AHUB1550R-5	●	5	50		22.225	17	47	20	8.4	5	C		75,900	
AHUB1550RM-3	●	3	50		22	17	47	20	10.4	6.3	E		69,340	
AHUB1550RM-5	●	5	50		22	17	47	20	10.4	6.3	C		75,900	
AHUB1563R-3	●	3	63		22.225	17	45	20	8.4	5	E		73,900	
AHUB1563R-6	●	6	63		22.225	17	45	20	8.4	5	C		83,760	
AHUB1563RM-3	●	3	63		22	17	45	20	10.4	6.3	E		73,900	
AHUB1563RM-6	●	6	63		22	17	45	20	10.4	6.3	C		83,760	
AHUB1580R-4	●	4	80		25.4	20	50	26	9.5	6	E		85,880	
AHUB1580R-7	●	7	80		25.4	20	50	26	9.5	6	C		95,730	
AHUB15100R-8	●	8	100		31.75	45	60	32	12.7	8	D		116,130	

- [注意]** Cタイプ、Eタイプについては、カッタ取付のアーバ用ねじはカッタ本体に付属しています。
 Dタイプを当社ボアタイプ用アーバに取付けるには、市販のフェースミル用締め付けボルトが必要となります。
 ※JDMT1505○○R-B7/C7をご使用の場合は最大切込みAPMXは()寸法となります。
- [Note]** The arbor screw for attaching the cutter is included with the cutter body of C type and E type.
 A commercial face mill clamping bolt is required to mount a D type into our bore type arbor.
 ※ The APMX in the case of using JDMT1505○○R-B7/C7 is a value shown in ().

アルファ超快削エンドミル AHU

部品番号 Parts

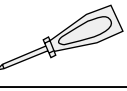
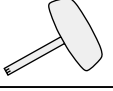



○は数字が入ります。 Numeric figure in a circle ○

部品名 Parts	クランプねじ Clamp screw			ドライバー Driver		レンチ Wrench		ねじ焼き付き防止剤 Screw anti-seizure agent	
形状 Shape		締付トルク Fastening torque (N·m)	希望小売価格(円) Suggested retail price (¥)		希望小売価格(円) Suggested retail price (¥)		希望小売価格(円) Suggested retail price (¥)		希望小売価格(円) Suggested retail price (¥)
適用カッタ Cutter body									
AHU (L) 1016R-2	250-141	1.1	870	104-T8	1,800	—	—	P-37	1,010
AHU (L) 1020R-○~1035R-○	251-141	1.1	870						
AHU (L) 15○R-○	412-141	2.9	540	104-T15	2,060	—	—		
AHUB1550R (M)-3~1563R (M)-3				—	—	105-T15	2,120		
AHUB1550R (M)-5~1563R (M)-6									
AHUB1580R-4									
AHUB1580R-7	250-141	1.1	870	104-T8	1,800	—	—		
AHUB15100R-8				412-141	2.9	540	104-T15	2,060	—
AHUM10○R-○(-M○)									
AHUM15○R-○(-M○)									

【注意】 クランプねじは消耗品です。使用環境により交換寿命は変化しますので早めの交換をお願い致します。

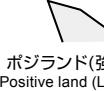
【Note】 The clamp screw is a consumable part. Since replacement life depends on the use environment, it is recommended that it be replaced at an early stage.

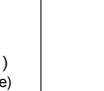
インサートの使い分け Recommended grades map

インサート 断面形状 Insert cross-section	低抵抗刃形 Low cutting force edge shape				刃先強化刃形 Tough cutting edge shape
					
	シャープエッジ Sharp edge	ポジランド(強スクイ) Positive land (Large rake)	ポジランド(弱スクイ) Positive land (Small rake)	汎用 General purpose	刃先強化 Tough cutting edge
用途 Application	FA形 FA type	B5/B7形 B5/B7 type	C5/C7形 C5/C7 type	汎用ブレーカ FW形、FF形、従来品 FW type, FF type, Conventional	TFW形 TFW type
一般構造用鋼 炭素鋼・合金鋼 ダイス鋼 Mild steels, Carbon steels Alloy steels, Die steels	—	—	JP4120	JS4045 JS4060	JS4060
プリハードン鋼 (30~40HRC) Pre-hardened steels	—	—	—	JP4120	JP4120
ステンレス鋼 Stainless steels	—	JM4160(Wet) JP4120(中仕上げ)	GX2160(Dry)	JM4160(PTH30E)	JM4160
鋳物 Cast irons	—	—	—	PTH13S(JP4120)	—
アルミニウム合金 Aluminum alloys	WH10 SD5010	—	—	HD7010 (アルミニウム合金鋳物 Cast aluminum alloy material)	—
チタン合金 Titanium alloys	—	JP4120	—	PTH30E	—
Ni基超耐熱合金 Nickel-based alloys	—	(JM4160) (ST処理 ST treatment)	JP4120 (AG処理 AG treatment)	—	—

●印：標準在庫品です。 無印：弊社営業へお問合せください。 一印：製作致しません。
 ● : Stocked items. No mark : Contact with our sales department. — : Not manufactured.

インサート Insert

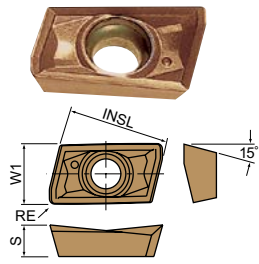

	FW, FF, 従来品 (M級) (E級) Conventional (M-class)(E-class)	TFW形 (M級) TFW type (M-class)	FA形 (E級) FA type (E-class)	B5/B7形 (M級) B5/B7 type (M-class)	C5/C7形 (M級) C5/C7 type (M-class)
インサート 断面形状 Insert cross-section shape	Fig.1	Fig.2	Fig.3 シャープエッジ Sharp edge	Fig.4 ポジランド (強スクイ) Positive land (Large rake)	Fig.5 ポジランド (弱スクイ) Positive land (Small rake)
用途 Application	汎用 General purpose	黒皮切削、 強断続切削 Forged surface cutting; Strong intermittent cutting	アルミ用 Aluminum use	ステンレス鋼(Wet加工) チタン、Ni基超耐熱合金用 Stainless steels (Wet cutting) Titanium, Nickel based alloy use	ステンレス鋼(Dry加工) Ni基超耐熱合金用 Stainless steels (Dry cutting) Nickel based alloy use

[注意] コーナR2.0以上のインサートを使用する場合はポデーコーナ部を追加加工する必要があります。
[Note] When using the insert with Radius bigger than R2.0, it is necessary to carry out additional cutting of cutter body corner part.

材料	鋼 Carbon steels	SUS等 SUS, etc.	FC・FCD Cast irons	グラファイト Graphite	アルミニウム合金 Aluminum alloys	チタン合金・Ni基超耐熱合金 Titanium alloys Nickel-based alloys
推奨	■	■	■	■	■	■
第一推奨	■	■	■	■	■	■
第二推奨	□	□	□	□	□	□

■：一般切削・第一推奨
General cutting, First recommended
□：一般切削・第二推奨
General cutting, Second recommended

商品コード Item code	精度 Tolerance class	コーティング										寸法 Size(mm)				インサート 断面形状 Insert cross-section shape	希望小売価格(円) Suggested retail price(¥)					
		AJ AJ Coating	GX GX Coating	JS JS Coating	TH TH Coating	DLC DLC Coating	HD HD Coating	超硬 Carbide	INSL	W1	S	RE	AJ,GX, JS,TH コーティング AJ,GX,JS, TH Coating	SD5010 HD7010	WH10							
JDMT100304R	M級 M	●		●	●	●	●						11	6.1	3.5	0.4	Fig.1	1,310	—	—		
JDMT100308R		●		●	●	●	●									0.8	1,310	—	—			
JDMT100320R		●		●	●	●	●									2.0	1,310	—	—			
JDMT100332R		●	●	●	●	●	●									3.2	1,310	—	—			
JDMT100304R-FW		●		●	●	●	●									0.4	1,310	—	—			
JDMT100308R-FW		●	●	●	●	●	●									0.8	1,310	—	—			
JDMT100308R-B5		● ^{#1}	●													0.8	Fig.4	1,310	—	—		
JDMT100308R-C5		● ^{#2}		●												0.8	Fig.5	1,310	—	—		
JDMT100320R-B5		● ^{#1}	●													2.0	Fig.4	1,310	—	—		
JDMT100320R-C5		● ^{#2}		●												2.0	Fig.5	1,310	—	—		
JDMT100330R-B5		● ^{#1}	●													3.0	Fig.4	1,310	—	—		
JDMT100330R-C5		● ^{#2}		●												3.0	Fig.5	1,310	—	—		
JDMT100332R-B5		● ^{#1}	●													3.2	Fig.4	1,310	—	—		
JDMT100332R-C5		● ^{#2}		●												3.2	Fig.5	1,310	—	—		
JDMT150504R		M級 M	●		●	●	●	●									0.4	Fig.1	1,490	—	—	
JDMT150508R			●		●	●	●	●	●								0.8		1,490	—	—	
JDMT150520R	●			●	●	●	●									2.0	1,490		—	—		
JDMT150530R	●			●	●	●	●	●								3.0	1,490		—	—		
JDMT150504R-FW	●			●	●	●	●									0.4	1,490		—	—		
JDMT150508R-FW	●		●	●	●	●	●									0.8	1,490		—	—		
JDMT150508R-TFW	●		●	●	●	●	●									0.8	Fig.2		1,490	—	—	
JDMT150508R-B7	● ^{#1}		●													0.8	Fig.4		1,490	—	—	
JDMT150508R-C7	● ^{#2}			●												0.8	Fig.5		1,490	—	—	
JDMT150520R-B7	● ^{#1}		●													2.0	Fig.4		1,490	—	—	
JDMT150520R-C7	● ^{#2}			●												2.0	Fig.5		1,490	—	—	
JDMT150530R-B7	● ^{#1}		●													3.0	Fig.4		1,490	—	—	
JDMT150530R-C7	● ^{#2}			●												3.0	Fig.5		1,490	—	—	
JDET100304R-FF	E級 E				●	●	●					●	—	11	6.1	3.5	0.4		Fig.1	1,630	9,770	—
JDET100308R-FF					●	●	●					●	—				0.8			1,630	9,770	—
JDET150504R-FF					●	●	●					●	—	16	9.12	5	0.4			1,860	11,110	—
JDET150508R-FF				●	●	●					●	—				0.8	1,860	11,110		—		
JDET100304R-FA		—	—	—	—	—	—	—	●		●	—	11	6.1	3.5	0.4	Fig.3	—	2,290	1,310		
JDET150502R-FA		—	—	—	—	—	—	●		●	—					0.2		—	2,600	1,490		
JDET150504R-FA		—	—	—	—	—	—	●		●	—		16	9.12	5	0.4		—	2,600	1,490		
JDET150530R-FA		—	—	—	—	—	—	●		●	—					3.0		—	2,600	1,490		

※1 JDMT○○○○○○R-B○; JP4120の第一推奨被削材種はS:チタン合金、第二推奨被削材種はM:ステンレス合金(中仕上げ)となります。
 ※2 JDMT○○○○○○R-C○; JP4120の第一推奨被削材種はS:Ni基超耐熱合金、第二推奨被削材種はP:鋼となります。
 ※3 推奨被削材種は目安を示すものです。実際の加工状況により適正な推奨材種が異なる場合があります。
 ※1 For JDMT○○○○○○R-B○: JP4120, the primary recommended work material is S (titanium alloys) and the secondary recommended work material M (stainless-steel; semi-finishing).
 ※2 For JDMT○○○○○○R-C○: JP4120, the primary recommended work material is S (Ni-based alloys) and the secondary recommended work material is P (carbon steel).
 ※3 The stated recommended work materials are general criteria. In actual use, suitable recommended materials may be different depending on the cutting situation.

[注意] GXコーティング、JSコーティングは通電式タッチセンサーに反応しませんのでご注意ください。**[Note]** Please note that the GX Coating and JS Coating do not cause a reaction in conductive touch sensors.

Indexable Tools Square End Mills

標準切削条件表 Recommended cutting conditions

※赤字は第一推奨材種です。Red indicates primary recommended grade.

被削材 Work material	推奨材種 Recommended grade	切削条件 Cutting conditions	工具径DC Tool dia.							
			AHU/AHUM 10形							
			φ16-2枚刃 2 flutes		φ20-3枚刃 3 flutes		φ25-4枚刃 4 flutes		φ32-5枚刃 5 flutes	
回転数 min ⁻¹	送り速度 mm/min	回転数 min ⁻¹	送り速度 mm/min	回転数 min ⁻¹	送り速度 mm/min	回転数 min ⁻¹	送り速度 mm/min			
一般構造用鋼 Mild steels SS	JS4060	回転数 <i>n</i> / 送り速度 <i>v_f</i>	3,180	570	2,390	1,080	1,910	1,150	1,490	1,120
		切削速度 Cutting Speed <i>v_c</i> (m/min)	120 ~ 200 (160)				120 ~ 180 (150)			
		一刃当りの送り Feed Rate <i>f_z</i> (mm/t)	0.06 ~ 0.12 (0.09)				0.1 ~ 0.2 (0.15)			
炭素鋼・合金鋼 Carbon steels & Alloy steels S-C, SCM	JS4060 JS4045	回転数 <i>n</i> / 送り速度 <i>v_f</i>	3,180	450	2,390	1,000	1,910	1,070	1,490	1,040
		切削速度 Cutting Speed <i>v_c</i> (m/min)	120 ~ 200 (160)				120 ~ 180 (150)			
		一刃当りの送り Feed Rate <i>f_z</i> (mm/t)	0.05 ~ 0.1 (0.07)				0.08 ~ 0.2 (0.14)			
ダイス鋼 (300HB以下) Die steels SKD, SKT	JS4060 JS4045	回転数 <i>n</i> / 送り速度 <i>v_f</i>	2,980	420	2,230	940	1,780	1,000	1,390	970
		切削速度 Cutting Speed <i>v_c</i> (m/min)	120 ~ 180 (150)				120 ~ 160 (140)			
		一刃当りの送り Feed Rate <i>f_z</i> (mm/t)	0.05 ~ 0.1 (0.07)				0.08 ~ 0.2 (0.14)			
プリハードン鋼 (30~40HRC) Pre-hardened steels	JP4120	回転数 <i>n</i> / 送り速度 <i>v_f</i>	1,990	280	1,590	670	1,270	710	990	700
		切削速度 Cutting Speed <i>v_c</i> (m/min)	80 ~ 120 (100)				80 ~ 120 (100)			
		一刃当りの送り Feed Rate <i>f_z</i> (mm/t)	0.05 ~ 0.1 (0.07)				0.08 ~ 0.2 (0.14)			
ステンレス鋼 (Dry加工) Stainless steels (Dry cutting) SUS	GX2160 JM4160	回転数 <i>n</i> / 送り速度 <i>v_f</i>	4,970	1,190	3,980	2,030	3,180	2,160	2,490	2,110
		切削速度 Cutting Speed <i>v_c</i> (m/min)	200 ~ 300 (250)				200 ~ 300 (250)			
		一刃当りの送り Feed Rate <i>f_z</i> (mm/t)	0.1 ~ 0.15 (0.12)				0.15 ~ 0.2 (0.17)			
ステンレス鋼 (湿式加工) Stainless steels (Wet cutting) SUS	JM4160 PTH30E	回転数 <i>n</i> / 送り速度 <i>v_f</i>	1,990	480	1,590	810	1,270	870	990	850
		切削速度 Cutting Speed <i>v_c</i> (m/min)	80 ~ 120 (100)				80 ~ 120 (100)			
		一刃当りの送り Feed Rate <i>f_z</i> (mm/t)	0.1 ~ 0.15 (0.12)				0.15 ~ 0.2 (0.17)			
鋳鉄 Cast irons FC, FCD	PTH13S JP4120	回転数 <i>n</i> / 送り速度 <i>v_f</i>	2,980	540	2,230	1,000	1,780	1,070	1,390	1,040
		切削速度 Cutting Speed <i>v_c</i> (m/min)	120 ~ 180 (150)				120 ~ 160 (140)			
		一刃当りの送り Feed Rate <i>f_z</i> (mm/t)	0.06 ~ 0.12 (0.09)				0.1 ~ 0.2 (0.15)			
アルミニウム合金 (湿式切削) Aluminum alloys (wet condition)	WH10 SD5010	回転数 <i>n</i> / 送り速度 <i>v_f</i>	6,960	1,670	6,370	2,860	5,090	3,060	3,980	2,980
		切削速度 Cutting Speed <i>v_c</i> (m/min)	200 ~ 500 (350)				200 ~ 600 (400)			
		一刃当りの送り Feed Rate <i>f_z</i> (mm/t)	0.1 ~ 0.15 (0.12)				0.1 ~ 0.2 (0.15)			
チタン合金 (湿式切削) Titanium alloys (wet condition) Ti-6Al-4V	JP4120 PTH30E	回転数 <i>n</i> / 送り速度 <i>v_f</i>	900	160	720	320	570	340	450	340
		切削速度 Cutting Speed <i>v_c</i> (m/min)	30 ~ 60 (45)				30 ~ 60 (45)			
		一刃当りの送り Feed Rate <i>f_z</i> (mm/t)	0.08 ~ 0.1 (0.09)				0.1 ~ 0.2 (0.15)			
Ni基超耐熱合金 (湿式切削) Ni based alloys (wet condition)	JP4120 JM4160	回転数 <i>n</i> / 送り速度 <i>v_f</i>	800	160	640	190	510	200	400	200
		切削速度 Cutting Speed <i>v_c</i> (m/min)	30 ~ 50 (40)				30 ~ 50 (40)			
		一刃当りの送り Feed Rate <i>f_z</i> (mm/t)	0.07 ~ 0.13 (0.1)				0.07 ~ 0.13 (0.1)			

【注意】GXコーティング、JSコーティングは通電式タッチセンサーに反応しませんのでご注意ください。

【Note】Please note that the GX Coating and JS Coating do not cause a reaction in conductive touch sensors.

切削条件の調整 Adjustment of cutting conditions

- 工具突出し量、加工状況に合わせて送り速度と回転数の調整が必要となります。
• Feed rate and spindle revolution must be adjusted to correspond to tool overhang and machining conditions.
- 標準切削条件を100%として、下記表を参考に加工条件の調整を行ってください。
• Please consider the standard cutting conditions as 100% and adjust the machining conditions by referring to the table below.

		突出し量 Overhang		
		<3DC	3DC~5DC	5DC<
面加工 Surfacing	回転数 <i>n</i> Rotation speed	100%	70%	50%
	送り速度 <i>v_f</i> Feed rate	100%	70%	50%
肩削り加工 Shoulder milling	回転数 <i>n</i> Rotation speed	100%	70%	50%
	送り速度 <i>v_f</i> Feed rate	70%	50%	35%
溝加工 Slotting	回転数 <i>n</i> Rotation speed	100%	70%	50%
	送り速度 <i>v_f</i> Feed rate	100%	70%	50%
傾斜切削 Ramping	回転数 <i>n</i> Rotation speed	100%	70%	50%
	送り速度 <i>v_f</i> Feed rate	80%	55%	40%

工具径DC Tool dia.														被削材 Work material
AHU/AHUM/AHUB 15形														
φ25-2枚刃 2 flutes		φ32-3枚刃 3 flutes		φ40-4枚刃 4 flutes		φ50-5枚刃 5 flutes		φ63-6枚刃 6 flutes		φ80-7枚刃 7 flutes		φ100-8枚刃 8 flutes		
回転数 min ⁻¹	送り速度 mm/min	回転数 min ⁻¹	送り速度 mm/min	回転数 min ⁻¹	送り速度 mm/min	回転数 min ⁻¹	送り速度 mm/min	回転数 min ⁻¹	送り速度 mm/min	回転数 min ⁻¹	送り速度 mm/min	回転数 min ⁻¹	送り速度 mm/min	
1,910	760	1,490	900	1,190	950	950	950	760	910	600	840	480	760	一般構造用鋼 Mild steels SS
120 ~ 180 (150)							120 ~ 180 (150)				120 ~ 180 (150)			
0.15 ~ 0.25 (0.2)														
1,910	760	1,490	900	1,190	950	950	950	760	910	600	840	480	760	炭素鋼・合金鋼 Carbon steels & Alloy steels S-C, SCM
120 ~ 180 (150)							120 ~ 180 (150)				120 ~ 180 (150)			
0.15 ~ 0.25 (0.2)														
1,780	530	1,390	630	1,110	670	890	670	710	640	560	580	450	530	ダイス鋼 (300HB以下) Die steels SKD, SKT
120 ~ 160 (140)							120 ~ 160 (140)				120 ~ 160 (140)			
0.1 ~ 0.2 (0.15)														
1,270	380	990	450	800	480	640	480	510	450	400	420	320	380	プリハードン鋼 (30~40HRC) Pre-hardened steels
80 ~ 120 (100)							80 ~ 120 (100)				80 ~ 120 (100)			
0.1 ~ 0.2 (0.15)														
3,180	1,270	2,490	1,490	1,990	1,590	1,590	1,590	1,260	1,520	990	1,390	760	1,220	ステンレス鋼 (Dry加工) Stainless steels (Dry cutting) SUS
200 ~ 300 (250)							200 ~ 300 (250)				200 ~ 280 (240)			
0.15 ~ 0.25 (0.2)														
1,270	510	990	600	800	640	640	640	510	610	400	560	320	510	ステンレス鋼 (Wet加工) Stainless steels (Wet cutting) SUS
80 ~ 120 (100)							80 ~ 120 (100)				80 ~ 120 (100)			
0.15 ~ 0.25 (0.2)														
1,780	710	1,390	840	1,110	890	890	890	710	850	560	780	450	710	鋳鉄 Cast irons FC, FCD
120 ~ 160 (140)							120 ~ 160 (140)				120 ~ 160 (140)			
0.15 ~ 0.25 (0.2)														
5,090	1,730	3,980	2,030	3,180	2,160	2,550	2,160	2,530	2,580	1,990	2,370	1,590	2,160	アルミニウム合金 (湿式切削) Aluminum alloys (wet condition)
200 ~ 600 (400)							200 ~ 800 (500)				200 ~ 800 (500)			
0.1 ~ 0.25 (0.17)														
570	170	450	200	360	210	290	210	230	200	180	190	130	150	チタン合金 (湿式切削) Titanium alloys (wet condition) Ti-6Al-4V
30 ~ 60 (45)							30 ~ 60 (45)				30 ~ 50 (40)			
0.1 ~ 0.2 (0.15)														
510	100	400	120	320	130	250	130	200	120	160	110	130	100	Ni基超耐熱合金 (湿式切削) Ni based alloys (wet condition)
30 ~ 50 (40)							30 ~ 50 (40)				30 ~ 50 (40)			
0.07 ~ 0.13 (0.1)														

傾斜切削 Ramping

中心まで切れ刃がないため傾斜角度に制限がありますが、下図に示すように傾斜切削やヘリカル切削にて下穴がなくてもダイレクトに彫り込み加工が可能です。
Although ramp angle is limited due to cutting edge design, direct milling is possible without pre-drill-hole with ramping and helical milling methods like next pictures.

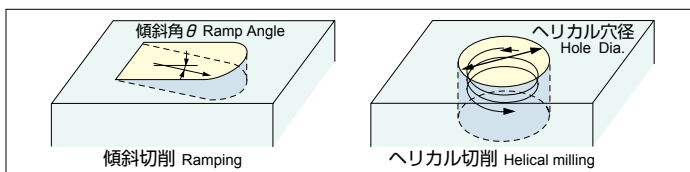

安全上のご注意 Attentions on Safety

- ① 排出した切りくずは、飛散し作業者を切傷させ、やけどあるいは目に入って負傷させる恐れがありますので、ご使用に際してはその周囲に安全カバーを取付け、保護メガネなどの保護具を着用し、安全な環境で作業されることをお願い致します。
 - ② 不水溶性切削油は、火災の恐れがありますので使用しないでください。
- ① The steel chips may cause cuts, burns or damages to eyes. Be sure to install the safety cover around the tool and wear the safety glasses when carrying out any works.
② Do not use non-water-soluble cutting oils. Such oils may result in fire.

① AHU(L)/AHUM 10形 type (mm)

工具径DC Tool dia.	φ16	φ20	φ21	φ25	φ26	φ30	φ32	φ35
最大傾斜角θ Maximum ramp angle	4°	3°	3°	2.5°	2.5°	2°	2°	1.5°
ヘリカル穴径 Hole Dia.	21~29	29~37	31~39	39~47	41~49	49~56	53~61	59~66

② AHU(L)/AHUM 15形 type (mm)

工具径DC Tool dia.	φ25	φ30	φ32	φ35	φ40	φ50
最大傾斜角θ Maximum ramp angle	5°	4°	4°	3.5°	3°	2°
ヘリカル穴径 Hole Dia.	34~47	43~56	47~60	54~66	64~76	83~96

③ AHUB 15形 type (mm)

工具径DC Tool dia.	φ50	φ63	φ80	φ100
最大傾斜角θ Maximum ramp angle	2°	1.5°	1.0°	0.5°
ヘリカル穴径 Hole Dia.	83~96	100~116	135~152	168~192

【注意】 ① 傾斜角θは上記範囲を超えない様に設定してください。1°以下での使用を推奨します。② 穴径が上記範囲外の場合は下穴を開けて加工してください。

【Note】 ① The ramp angle θ should be set within the ranges listed above. Use at ramp angles of 1° or less is recommended. ② For hole diameters outside the ranges listed above, a pilot hole should be drilled before milling.

SD5010によるアルミニウム合金及び銅切削条件 Cutting conditions for cutting aluminum alloy and copper using SD5010

<肩削り> Shoulder cutting : $ae=0.5DC$

被削材 Work material	切削条件 Cutting conditions	AHU/AHUM 10形 type					AHU/AHUB/AHUM 15形 type							
		φ16 (2枚刃) 2 Flutes	φ20 (3枚刃) 3 Flutes	φ25 (4枚刃) 4 Flutes	φ32 (5枚刃) 5 Flutes	φ35 (5枚刃) 5 Flutes	φ25 (2枚刃) 2 Flutes	φ32 (3枚刃) 3 Flutes	φ35 (3枚刃) 3 Flutes	φ40 (4枚刃) 4 Flutes	φ50 (5枚刃) 5 Flutes	φ63 (6枚刃) 6 Flutes	φ80 (7枚刃) 7 Flutes	φ100 (8枚刃) 8 Flutes
アルミニウム合金展伸材 Expanded aluminum alloy material A5052, A7075等, etc. (エアブロー or ウェット:水溶性) (Air-blow or wet: Water-soluble agent)	回転数 n (min ⁻¹)	15,900	15,900	12,700	11,900	10,910	12,000	9,950	9,090	9,500	7,640	6,060	5,970	4,770
	切削速度 v_c (m/min)	800	1,000	1,000	1,200	1,200	950	1,000	1,000	1,200	1,200	1,500	1,500	
	送り速度 v_f (mm/min)	4,770	7,150	7,620	8,920	8,180	4,800	5,970	5,450	7,600	7,640	7,270	8,360	7,630
	一刃当りの送り量 f_z (mm/t)	0.15	0.15	0.15	0.15	0.15	0.2	0.2	0.2	0.2	0.2	0.2	0.2	0.2
	軸方向切り込み a_p (mm)	3	3	3	3	3	5	5	5	5	5	5	5	5
アルミニウム合金鋳物 Cast aluminum alloy material AC4A, ADC12等, etc. (エアブロー or ウェット:水溶性) (Air-blow or wet: Water-soluble agent)	回転数 n (min ⁻¹)	12,700	12,700	10,160	9,520	8,730	9,600	7,960	7,270	7,600	6,110	4,850	4,780	3,820
	切削速度 v_c (m/min)	640	800	800	960	960	760	800	800	960	960	1,200	1,200	
	送り速度 v_f (mm/min)	3,820	5,720	6,100	7,140	6,550	3,840	4,780	4,360	6,080	6,110	5,820	6,690	6,100
	一刃当りの送り量 f_z (mm/t)	0.15	0.15	0.15	0.15	0.15	0.2	0.2	0.2	0.2	0.2	0.2	0.2	0.2
	軸方向切り込み a_p (mm)	3	3	3	3	3	5	5	5	5	5	5	5	5
純銅 Pure copper C1100, C1020等, etc. (ウェット:水溶性) (Wet: Water-soluble agent)	回転数 n (min ⁻¹)	5,970	4,770	3,820	2,980	2,730	3,820	2,980	2,730	2,390	1,910	1,520	1,190	955
	切削速度 v_c (m/min)	300	300	300	300	300	300	300	300	300	300	300	300	300
	送り速度 v_f (mm/min)	1,790	2,150	2,290	2,240	2,050	1,530	1,790	1,640	1,910	1,910	1,820	1,670	1,530
	一刃当りの送り量 f_z (mm/t)	0.15	0.15	0.15	0.15	0.15	0.2	0.2	0.2	0.2	0.2	0.2	0.2	0.2
	軸方向切り込み a_p (mm)	3	3	3	3	3	5	5	5	5	5	5	5	5

- [注意]**
- ①被削材、加工形状に合わせて、適切なクーラントを使用してください。
 - ②この切削条件表は切削条件の目安を示すものです。実際の加工では加工形状、目的、使用機械等により条件を調整してください。
 - ③溝切削の場合は送り速度を30%下げて(0.7倍して)ご使用ください。
 - ④L/D=4以上の場合は回転数と送り速度を60%下げて(0.4倍して)ご使用ください。
 - ⑤スプラッシュガード付きの機械でご使用ください。ご使用に際しては保護めがね等の保護具を着用して、安全な環境で作業される事をお願いいたします。
 - ⑥上記条件表の回転数まで上がらない機械の場合は使用可能な回転数に設定して、送り速度は f_z 値で計算してください。
 - ⑦ご使用されるミーリングチャックの許容回転数以内でご使用ください。許容回転数が上記条件表の回転数未満の場合は使用可能な回転数に設定して、送り速度は f_z 値で計算してください。

- [Note]**
- ① Use the appropriate coolant for the work material and machining shape.
 - ② These conditions are for general guidance; in actual machining conditions adjust the parameters according to your actual machine and work-piece conditions.
 - ③ When cutting grooves, reduce the feed rate by 30% (set it to 0.7 times the value shown above).
 - ④ When L/D = 4 or higher, reduce the rotation speed and feed rate by 60% (set them to 0.4 times the values shown above).
 - ⑤ Use on a machine equipped with splashguards. During use, be sure to wear protective equipment such as safety glasses, and always perform work in a safe environment.
 - ⑥ When using a machine that cannot provide the rotation speed shown above, set the highest rotation speed possible and calculate the feed rate using the f_z value.
 - ⑦ Be sure to use this tool at rotation speeds within the acceptable range for the milling chuck being used. If the acceptable rotation speed range is below the rotation speed shown above, set the highest acceptable rotation speed and calculate the feed rate using the f_z value.

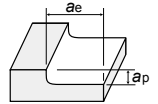

HD7010インサートによるグラファイト及びアルミニウム合金鋳物切削条件 Cutting conditions for cutting graphite and cast aluminium alloy

被削材 Work material	推奨材種 Recommended grade	切削条件 Cutting conditions	AHU/AHUM 10形 type		AHU/AHUB/AHUM 15形 type		
			φ16	φ20~35	φ25~50	φ63~80	φ100
グラファイト Graphite	HD7010	切削速度 v_c Cutting speed m/min	150~300	150~300	150~300	150~300	150~300
		一刃当りの送り量 f_z Feed rate mm/t	0.10~0.20	0.10~0.20	0.1~0.25	0.1~0.25	0.1~0.25
アルミニウム合金鋳物 Cast aluminum alloy AC4A, ADC12等 (エアブロー or ウェット:水溶性) (Air-blow or wet: water-soluble agent)	HD7010	切削速度 v_c Cutting speed m/min	200~500	200~500	200~600	200~600	200~600
		一刃当りの送り量 f_z Feed rate mm/t	0.10~0.20	0.10~0.20	0.1~0.25	0.1~0.25	0.1~0.25

- [注意]**
- ①被削材、加工形状に合わせて、適切なクーラントを使用してください。
 - ②この切削条件表は切削条件の目安を示すものです。実際の加工では加工形状、目的、使用機械等により条件を調整してください。
 - ③この工具をご使用の際は、破損する危険性がありますので、必ずカバー・保護めがね・安全靴などをご使用ください。

- [Note]**
- ① Use the appropriate coolant for the work material and machining shape.
 - ② These conditions are for general guidance; in actual machining conditions adjust the parameters according to your actual machine and work-piece conditions.
 - ③ Since there is a danger of breakage when using this tool, be sure to use the cutting area cover, protective goggles, safety shoes, etc.

突き出し量と切削領域

Overhang and Cutting Area

・切削速度: $V_c=120\text{m/min}$ ・被削材: S50C (220HB) ・使用機械: BT50 M/C
Cutting Speed Work material Machine

AHU(L) 10形 type		AHU(L) 15形 type	
<p>φ16 $f_z=0.1$ (mm/t)</p> <p>切込み幅 a_e Cutting Width(mm)</p>	<p>突き出し量: 2DC Overhang AHU1016R-2 突き出し量: 3DC, 4DC Overhang AHUL1016R-2 DC:工具径 Tool Dia.</p>	<p>φ25 $f_z=0.15$ (mm/t)</p> <p>切込み幅 a_e Cutting Width(mm)</p>	<p>突き出し量: 3DC Overhang AHU1525R-2 突き出し量: 4DC Overhang AHUL1525R-2 DC:工具径 Tool Dia.</p>
<p>φ20 $f_z=0.15$ (mm/t)</p> <p>切込み幅 a_e Cutting Width(mm)</p>	<p>突き出し量: 2DC, 3DC Overhang AHU1020R-3 突き出し量: 4DC, 5DC Overhang AHUL1020R-3 DC:工具径 Tool Dia.</p>	<p>φ32 $f_z=0.15$ (mm/t)</p> <p>切込み幅 a_e Cutting Width(mm)</p>	<p>突き出し量: 1.4DC Overhang AHU1532R-3 突き出し量: 3DC, 4DC Overhang AHUL1532R-3 DC:工具径 Tool Dia.</p>
<p>φ25 $f_z=0.15$ (mm/t)</p> <p>切込み幅 a_e Cutting Width(mm)</p>	<p>突き出し量: 3DC Overhang AHU1025R-4 突き出し量: 4DC Overhang AHUL1025R-3 DC:工具径 Tool Dia.</p>	<p>φ40 $f_z=0.15$ (mm/t)</p> <p>切込み幅 a_e Cutting Width(mm)</p>	<p>突き出し量: 1.5DC, 2DC Overhang AHU1540R-4 突き出し量: 3DC Overhang AHUL1540R-4 DC:工具径 Tool Dia.</p>
<p>φ32 $f_z=0.15$ (mm/t)</p> <p>切込み幅 a_e Cutting Width(mm)</p>	<p>突き出し量: 3DC Overhang AHU1032R-5 突き出し量: 4DC Overhang AHUL1032R-4 DC:工具径 Tool Dia.</p>	<p>φ50 $f_z=0.15$ (mm/t)</p> <p>切込み幅 a_e Cutting Width(mm)</p>	<p>突き出し量: 2DC Overhang AHU1550R-5 突き出し量: 3DC Overhang AHUL1550R-4 DC:工具径 Tool Dia.</p>

[注意] 実際の加工では上記領域図を参考に、加工形状や使用機械に合わせて条件を調整してください。

[Note] Please adjust the cutting condition with reference to the above-stated graph depending on the stiffness of a work piece or a machine.

モジュラーミル切削領域

Cutting area of modular mill

・被削材 Work material: S50C (220HB) ・切削速度 Cutting speed: $V_c=100\text{m/min}$
・一刃当りの送り Feed rate: $f_z=0.1\text{mm/t}$ ・使用機械 Machine: BT50

突出し量 Overhang 120mm		突出し量 Overhang 150mm		突出し量 Overhang 200mm	
<p>φ16</p> <p>切込み幅 a_e Cutting width(mm)</p>	<p>φ16シャフト+φ16ヘッド AHUM1016R-2 ASC16-8.5-160-30</p>	<p>φ20</p> <p>切込み幅 a_e Cutting width(mm)</p>	<p>φ20シャフト+φ20ヘッド AHUM1020R-3 ASC20-10.5-220-50Z</p>	<p>φ25</p> <p>切込み幅 a_e Cutting width(mm)</p>	<p>φ25シャフト+φ25ヘッド AHUM1025R-4 ASC25-12.5-265-145</p>
<p>φ20</p> <p>切込み幅 a_e Cutting width(mm)</p>	<p>φ20シャフト+φ20ヘッド AHUM1020R-3 ASC20-10.5-170-90Z</p> <p>φ16シャフト+φ20ヘッド AHUM1020R-2-M8 ASC16-8.5-160-30</p>	<p>φ25</p> <p>切込み幅 a_e Cutting width(mm)</p>	<p>φ25シャフト+φ25ヘッド AHUM1025R-4 ASC25-12.5-215-115</p> <p>φ25シャフト+φ25ヘッド AHUM1025R-2-M10 ASC20-10.5-220-50Z</p>	<p>φ30</p> <p>切込み幅 a_e Cutting width(mm)</p>	<p>φ32シャフト+φ30ヘッド AHUM1030R-5 ASC32-17-260-140</p> <p>φ25シャフト+φ30ヘッド AHUM1030R-2-M12 ASC25-12.5-265-145</p>

[注意] 実際の加工では上記領域図を参考に、加工形状や使用機械に合わせて条件を調整してください。

[Note] Please adjust the cutting condition with reference to the above-stated graph depending on the stiffness of a work piece or a machine.

Easy Cut 4 Corners Shoulder Mill SS4P

アルファ快削ショルダーミル 4コーナ SS4P

- 経済性に優れた4コーナ仕様のショルダーミル
- 汎用タイプと刃先強化タイプの2種類のインサートをラインナップ
 - ・ Shoulder mill with economical 4 cutting edge insrts.
 - ・ The kind of insert has a type of general purpose and a type of tough cutting edge.

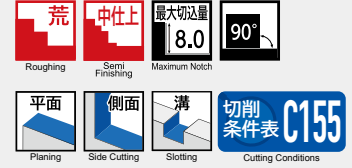

SS4P30○○S○○-○ シャンクタイプ Shank type

○は数字が入ります。 Numeric figure in a circle ○

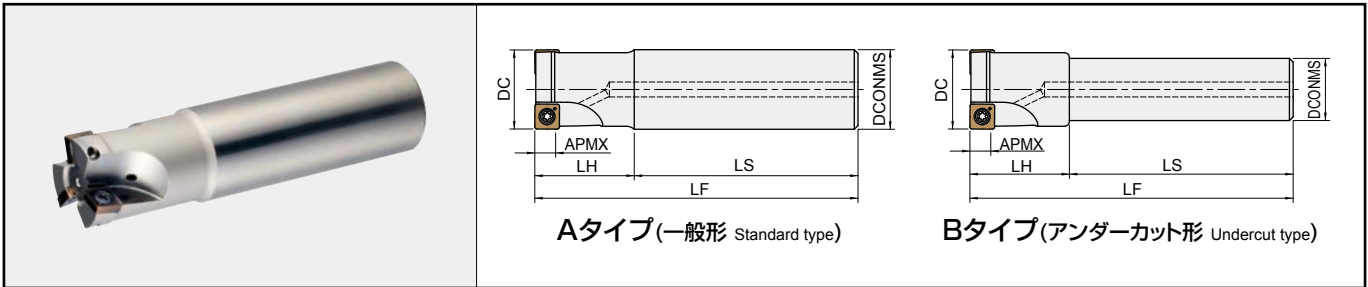

商品コード Item code	在庫 Stock	刃数 No. of flutes	寸法 Size(mm)							形状 Shape	適用インサート Inserts	希望小売価格 (円) Suggested retail price(¥)
			DC	LF	APMX	LH	LS	DCONMS				
SS4P3025S25-2	●	2	25	120	8	35	85	25	A	SPMT10030○R-FW SPMT100308R-TFW	37,200	
SS4P3032S32-3	●	3	32	130	8	45	85	32	A		45,410	
SS4P3040S32-4	●	4	40	130	8	45	85	32	B		56,440	

インサート Insert

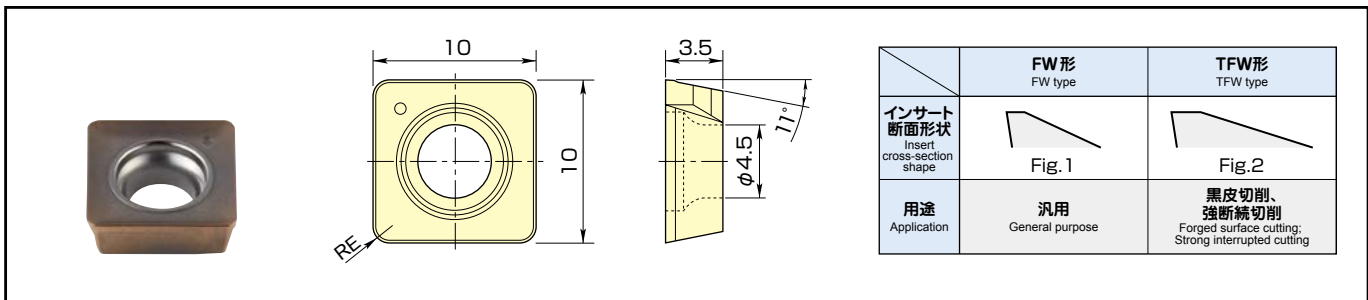



商品コード Item code	ノーズR Nose R	精度 Tolerance class	AJコーティング AJ Coating	GXコーティング GX Coating	寸法 Size(mm)	インサート断面形状 Insert cross-section shape	希望小売価格 (円) Suggested retail price(¥)
SPMT100304R-FW	0.4	M級 M	●	●	0.4	Fig.1	910
SPMT100308R-FW	0.8		●	●	0.8	Fig.1	910
SPMT100308R-TFW	0.8		●	●	0.8	Fig.2	910

[注意] GX2140 は通電式タッチセンサーに反応しませんのでご注意ください。
[Note] Please note that the GX2140 does not cause a reaction in conductive touch sensors.

●印：標準在庫品です。 ●：Stocked items.

部品番号 Parts

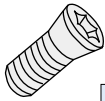
○は数字が入ります。 Numeric figure in a circle ○

部品名 Parts	クランプねじ Clamp screw	ドライバー Screw driver		ねじ焼付き防止剤 Screw anti-seizure agent			
形状 Shape							
適用カッター Cutter body	締付トルク Fastening torque (N·m)	希望小売価格 (円) Suggested retail price (¥)	希望小売価格 (円) Suggested retail price (¥)	希望小売価格 (円) Suggested retail price (¥)	希望小売価格 (円) Suggested retail price (¥)		
SS4P30○S○-○	412-141	2.9	540	104-T15	2,060	P-37	1,010

【注意】 クランプねじは消耗品です。使用環境により交換寿命は変化しますので早めの交換をお願い致します。

【Note】 The clamp screw is a consumable part. Since replacement life depends on the use environment, it is recommended that it be replaced at an early stage.

標準切削条件表 Recommended cutting conditions

※赤字は第一推奨材種です。 Red indicates primary recommended grade.

被削材 Work material	推奨材種 Recommended grade	切削速度 Cutting speed V_c (m/min)	一刃当りの送り Feed rate f_z (mm/t)	$\phi 25$ -2枚刃 2 flutes		$\phi 32$ -3枚刃 3 flutes		$\phi 40$ -4枚刃 4 flutes	
				回転数 n min ⁻¹	送り速度 v_f mm/min	回転数 n min ⁻¹	送り速度 v_f mm/min	回転数 n min ⁻¹	送り速度 v_f mm/min
一般構造用鋼 Mild steels SS(200HB以下)	※ GX2140	150~200	0.15~0.25	2,290	920	1,790	1,070	1,430	1,140
				$v_c=180$ m/min, $f_z=0.2$ mm/t, $a_p=3$ mm, $a_e=0.5$ DC					
炭素鋼・合金鋼 Carbon steels & Alloy steels S-C SCM(300HB以下)	GX2140	120~180	0.15~0.25	2,040	820	1,590	950	1,270	1,020
				$v_c=160$ m/min, $f_z=0.2$ mm/t, $a_p=3$ mm, $a_e=0.5$ DC					
プリハードン鋼 Pre-hardened steels (30~40HRC)	JP4120	80~120	0.1~0.2	1,270	380	995	450	795	480
				$v_c=100$ m/min, $f_z=0.15$ mm/t, $a_p=2$ mm, $a_e=0.5$ DC					
ステンレス鋼 (乾式切削) Stainless steels (dry) SUS	JP4120	200~300	0.15~0.25	3,180	1,270	2,490	1,490	1,990	1,600
				$v_c=250$ m/min, $f_z=0.2$ mm/t, $a_p=3$ mm, $a_e=0.5$ DC					
ステンレス鋼 (湿式切削) Stainless steels (wet) SUS	JP4120	80~120	0.15~0.25	1,270	510	995	600	795	640
				$v_c=100$ m/min, $f_z=0.2$ mm/t, $a_p=3$ mm, $a_e=0.5$ DC					
鋳鉄 Cast irons FC, FCD	JP4120 GX2140	120~160	0.15~0.25	1,780	710	1,390	830	1,110	890
				$v_c=140$ m/min, $f_z=0.2$ mm/t, $a_p=3$ mm, $a_e=0.5$ DC					
チタン合金 (湿式切削) Titanium alloys (wet) Ti-6Al-4V	JP4120	30~60	0.1~0.2	570	170	450	200	360	220
				$v_c=45$ m/min, $f_z=0.15$ mm/t, $a_p=3$ mm, $a_e=0.5$ DC					

- 【注意】**
- 被削材、加工形状に合わせて、適切なクーラントを使用してください。
 - この切削条件表は切削条件の目安を示すものです。実際の加工では加工形状、目的、使用機械等により条件を調整してください。
 - GX2140は、通電式タッチセンサーに反応しませんのでご注意ください。
 - 溝切削の場合、送り速度は70%を目安として下さい。
 - インサートの交換は早めに行い、過度の使用による破損を防止して下さい。
 - 排出した切りくずは飛散し作業者を切傷させ、火傷あるいは目に入って負傷させる恐れがありますので、ご使用に際してはその周囲に安全カバーを取り付け保護めがね等の保護具を着用して、安全な環境で作業される事をお願い致します。
 - 不水溶性切削油は、火災の恐れがありますので使用しないで下さい。

- 【Note】**
- Use the appropriate coolant for the work material and machining shape.
 - These conditions are for general guidance; in actual machining conditions adjust the parameters according to your actual machine and work-piece conditions.
 - Please note that the GX2140 does not cause a reaction in conductive touch sensors.
 - Please reduce feed rate 30% from above table for slotting.
 - In order to avoid of insert breakage, please change insert earlier.
 - The steel chips may cause cuts, burns or damages to eyes. Be sure to install the safety cover around the tool and wear the safety glasses when carrying out any works.
 - Please don't use cutting oil as coolant.(It may be cause of fire.)

SE90(shank)

アルファ90(シャンク) SE90

- 切りくずの排出が安定したハイレーキタイプの直角削りカッタ
- 鋼、ステンレス鋼の切削や薄肉ワークの加工に適します
- マシニングセンタや馬力の小さい機械の加工で能率アップ
- ・ A high rake angle type cutter for cutting right angle material, which eject cutting chips steadily.
- ・ Suitable for cutting steel, stainless steel or thin works.
- ・ Reveals excellent cutting effect when used for machining center or a machine of small horse power.



SE(L)90-40 $\circ\circ$ R(42)

\circ は数字が入ります。 Numeric figure in a circle \circ

商品コード Item code		在庫 Stock	刃数 No. of flutes	寸 法 Size (mm)					適用インサート Inserts	希望小売価格 (円) Suggested retail price(¥)				
				DC	LF	DCONMS	APMX	LH			LS			
標準 Regular shank	SE90-4050R	●	3	50	※1 120 (150)	32	17	40	80	TE \circ 43 \circ R-G0(\circ)	61,000			
	SE90-4063R	●	4	63							81,300			
	SE90-4050R42		3	50										
	SE90-4063R42		4	63										
ロング Shank Long shank	SEL90-4050R		3	50	200	32	17	40	160					
	SEL90-4063R		4	63										
	SEL90-4063R42		4	63										

[注意] ※1 LF欄の(150)は全長 150mm となり、商品コード末尾に「-L150」が追加されます。
[Note] ※1 "(150)" in the LF column indicates a total length of 150 mm; "-L150" is appended to the end of the item code.

■ インサート Inserts





TE \circ 43 \circ R-G0(\circ)																	
						※2											
G0E		23°		G0Y		23°		G0		20°							
P	鋼	Carbon steels	■	■	■	■	■	■	■	■ : 一般切削・第一推奨 General cutting, First recommended							
M	SUS等	SUS, etc.	■	■	■	■	■	■	■	■ : 一般切削・第二推奨 General cutting, Second recommended							
K	FC・FCD	Cast irons	□	■	■	■	■	■	■	□ : 一般切削・第二推奨 General cutting, Second recommended							
N	アルミニウム合金	Aluminum alloys	■	■	■	■	■	■	■	■ : 一般切削・第二推奨 General cutting, Second recommended							
商品コード (インチ系) Item code (inch)	ISO形番 ISO (metric)	精度 Tolerance class	AJコーティング AJ Coating		Cコーティング C Coating		GXコーティング GX Coating		Gコーティング G Coating		サーメット Cermet		超硬 Carbide		形状 Shape	希望小売価格(円) Suggested retail price(¥)	
			JP4120	JM4160	CY100H	CY25	CY250	GX2140	HC844	CH550	EX35	WH10	P	K		AJ,C,GX Gコーティング AJ,C,GX, G Coating	CH550 EX35 WH10
TEE43TR-G0	TEEN2204PETR-G0	E 級 E	●	●		●	●	●	●	●				Fig-1	1,790	1,380	
TEE43TR-G0Y	TEEN2204PETR-G0Y		●	●		●	●	●	●	●					1,790	—	
TEE43TR-G0E	TEEN2204PETR-G0E				●				●	●	●				1,790	1,380	
TEE43FR-G0E	TEEN2204PEFR-G0E				●				●	●	●		●		1,790	1,380	
TEK43TR-G0E	TEKN2204PETR-G0E	K 級 K							●	●	●			1,620	1,260		
TEK43FR-G0E	TEKN2204PEFR-G0E				●								●	1,620	1,260		

[注意] GX2140 は通電式タッチセンサーに反応しませんのでご注意ください。
[Note] Please note that the GX2140 does not cause a reaction in conductive touch sensors.

●印 : 標準在庫品です。 ● : Stocked items. 無印 : 弊社営業へお問合せください。 No mark : Contact with our sales department.

部品番号 Parts

○は数字が入ります。 Numeric figure in a circle ○

部品名 Parts	サポータ Locater	サポータ止ねじ Locater screw	クサビ Wedge	クランプねじ Clamp screw	レンチ Wrench					
形状 Shape										
適用カッタ Cutter body	希望小売 価格(円) Suggested retail price (¥)	希望小売 価格(円) Suggested retail price (¥)	希望小売 価格(円) Suggested retail price (¥)	希望小売 価格(円) Suggested retail price (¥)	希望小売 価格(円) Suggested retail price (¥)					
SE90-4○○○R(○○)	231-111	6,420	231-160	200	231-121	2,190	231-140	540	100-221	950
SEL90-4○○○R(○○)										

標準切削条件表 Recommended cutting conditions

※赤字は第一推奨材種です。 Red indicates primary recommended grade.

被削材 Work material	推奨材種 Recommended grade	切削速度 Cutting speed (m/min)	φ 50		φ 63		切削速度 Cutting Speed (m/min)	φ 50		φ 63	
			SE90-4050R		SE90-4063R			SEL90-4050R		SEL90-4063R	
			回転数 Revolutions min ⁻¹	送り速度 Table speed mm/min	回転数 Revolutions min ⁻¹	送り速度 Table speed mm/min		回転数 Revolutions min ⁻¹	送り速度 Table speed mm/min	回転数 Revolutions min ⁻¹	送り速度 Table speed mm/min
軟鋼 Mild steels SS, SM (200HB以下)	CH550, GX2140	250	1,590	715	1,260	570	175	1,110	330	880	350
	CY25, HC844	200	1,270	760	1,010	610	140	890	400	710	430
	EX35	160	1,020	610	810	490	110	700	315	560	340
炭素鋼・合金鋼 Carbon steels, Alloy steels S-C, SCM (30HRC以下)	CH550, GX2140	200	1,270	570	1,010	450	140	890	270	710	280
	CY25, HC844	160	1,020	610	810	490	110	700	315	560	340
	EX35	120	760	460	610	370	80	510	230	400	240
炭素鋼・合金鋼 Carbon steels, Alloy steels (30 ~ 40HRC)	JP4120	130	830	250	660	200	90	570	140	450	145
	CH550, CY25	120	760	340	610	270	90	510	150	400	160
	EX35	100	640	290	505	230	70	445	130	350	140
ステンレス鋼 Stainless steels SUS	JM4160	250	1,590	720	1,260	570	175	1,110	330	880	350
	CH550, CY25	220	1,400	840	1,110	670	150	955	430	760	450
	HC844, EX35	180	1,150	690	910	550	130	830	370	660	390
鋳鉄 Cast irons FC, FCD	CY100H, WH10	150	950	570	760	460	100	640	290	500	300
	JP4120, GX2140	100	640	380	505	300	70	445	200	350	210
アルミ合金 Aluminium alloys (SiC15%以下)	WH10	700	4,460	2,000	3,540	1,590	490	3,120	940	2,480	990
アルミ合金 Aluminium alloys (SiC15%以上)	WH10	300	1,910	860	1,520	680	210	1,340	400	1,060	420
銅合金 Copper alloys	WH10	300	1,910	860	1,520	680	210	1,340	400	1,060	420

- 【注意】 ①被削材、加工形状に合わせて、適切なクーラントを使用してください。
 ②この標準切削条件表は切削条件の目安を示すものです。実際の加工では加工形状、目的、使用機械等により条件を調整してください。
 ③GX2140は、通電式タッチセンサーに反応しませんのでご注意ください。

- 【Note】 ① Use the appropriate coolant for the work material and machining shape.
 ② These recommended cutting conditions indicate only the rule of a thumb for the cutting conditions. In actual machining, the condition should be adjusted according to the machining shape, purpose and the machine type.
 ③ Please note that the GX2140 does not cause a reaction in conductive touch sensors.

Easy Cut Square Mill UEX

快削エンドミル UEX

● 研付けブレードインサート使用で切れ味優先のショルダミルです。

・ A shoulder mill with superior cutting performance due to the grinder-equipped breaker insert.

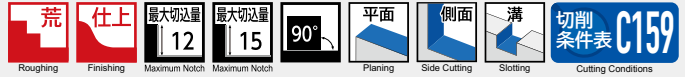

UEX(L)○○R(-○○)

○は数字が入ります。 Numeric figure in a circle ○

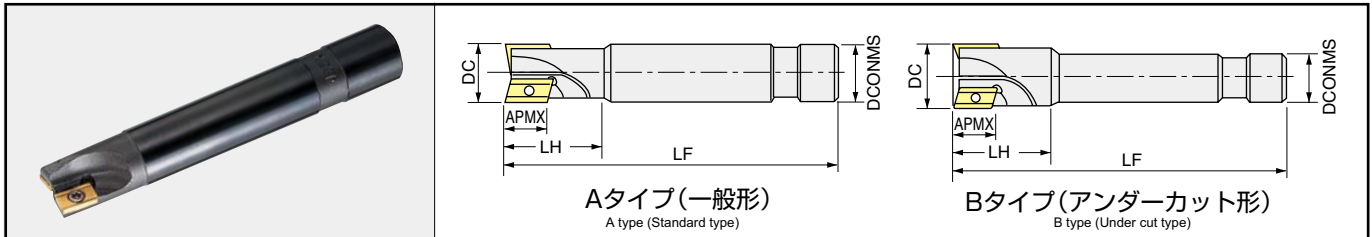

商品コード Item code	在庫 Stock	刃数 No. of flutes	寸法 Size (mm)							形状 Shape	適用インサート Inserts	希望小売価格(円) Suggested retail price (¥)	
			DC	LF	DCONMS	APMX	LH	A.R.* ₁	R.R.* ₂				
UEX16R	●	1	16	120	20	12	15	3°	1°	A	AP○○T12020○○R	18,900	
UEX20R-16	●	2	20	120	16	12	30	6°	4°	B* ₃		AD○○T16030○○R	28,870
UEX20R	●				20					A			28,870
UEX25R-20	●	2	25	130	20	15	35	6°	3°	B* ₃	AD○○T16030○○R		32,620
UEX25R	●				25					A		32,620	
UEX30R-25	●	2	30	150	25	15	45	8°	3°	B* ₃		AD○○T16030○○R	35,080
UEX30R	●				32					A	35,080		
UEX35R-32	●	3	35	150	32	15	45	8°	4°	B* ₃	AD○○T16030○○R		50,210
UEX40R-32	●	3	40	170	32	15	45	10°	4.5°	B* ₃		53,960	
UEX50R-32	●	4	50	170	32	15	45	10°	5°	B* ₃		66,520	
UEXL20R	●	2	20	185	20	12	30	6°	4°	A	AP○○T12020○○R	31,800	
UEXL25R-20	●	2	25	220	20	15	35	6°	3°	B* ₃		AD○○T16030○○R	35,910
UEXL30R-25	●	2	30	220	25	15	45	8°	3°	B* ₃			38,710
UEXL35R-32	●	3	35	235	32	15	45	8°	4°	B* ₃	55,260		
UEXL40R-32	●	3	40	240	32	15	45	10°	4.5°	B* ₃	AD○○T16030○○R	59,480	
UEXL50R-42	●	4	50	250	42	15	45	10°	5°	B* ₃		73,320	

【注意1】 ※₁ アキシャルレーキ, ※₂ すくい角付きインサートの場合でのラジアルレーキ
※₃ アンダーカット形上記以外のボディ寸法についてもご注文を承ります。

【Note1】 ※₁ Axial rake, ※₂ Radial rake with a rake angled insert.
※₃ Under-cuttype, body sizes other than those listed above are also available.

部品番号 Parts

適用カッタ Cutter body	部品名 Parts	クランプねじ Clamp screw			ドライバー Screw driver	
		クランプねじ Clamp screw	締付トルク Fastening torque (N·m)	希望小売価格(円) Suggested retail price(¥)	ドライバー Screw driver	希望小売価格(円) Suggested retail price(¥)
UEX16R~UEX20R UEXL20R		242-141	2.9	540		104-T15 2,060
UEX25R-20~UEX50R-32 UEXL25R-20~UEXL50R-42		412-141	2.9	540		

【注意】 クランプねじは消耗品です。使用環境により交換寿命は変化しますので早めの交換をお願い致します。

【Note】 The clamp screw is a consumable part. Since replacement life depends on the use environment, it is recommended that it be replaced at an early stage.

●印：標準在庫品です。 ●：Stocked items. 無印：弊社営業へお問合せください。 No mark：Contact with our sales department.

■ インサート Inserts

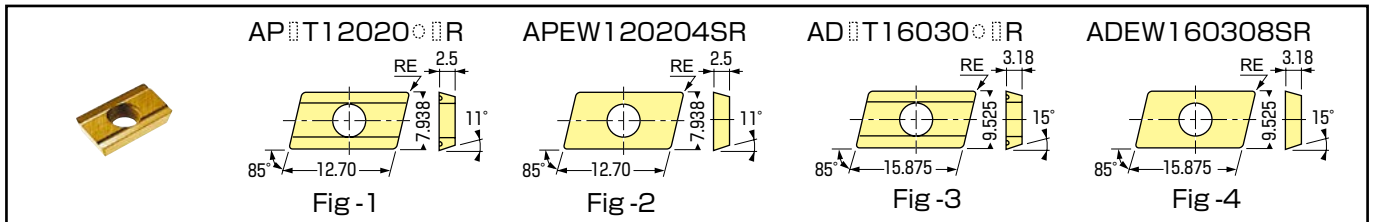

商品コード Item code	精度 Tolerance class	コーティング C Coating	コーティング G Coating	サーメット Cermet	超硬 Carbide		寸法 Size(mm)	形状 Shape	希望小売価格(円) Suggested retail price(¥)	
		CY100H	HC844	CH550	P	K			CY100H HC844	CH550 EX35 WH10
APET120202SR	E級 E		●	●			0.2	Fig-1	1,640	1,270
APET120202ER							0.2		—	—
*APET120202FR						●	0.2		—	1,270
APET120204SR		●	●	●	●	0.4	1,640		1,270	
APET120204ER					●	0.4	—		1,270	
APET120208SR		●	●	●	●	0.8	1,640		1,270	
APET120208ER					●	0.8	—		1,270	
APEW120204SR						0.4	Fig-2		—	—
APNT120208SR	N級 N		●	●	●	0.8	Fig-1	1,100	850	
APNT120208ER					●	0.8		—	850	
ADET160302SR	E級 E		●	●			0.2	Fig-3	2,060	1,590
ADET160302ER							0.2		—	—
*ADET160302FR						●	0.2		—	1,590
ADET160304SR		●	●	●	●	0.4	2,060		1,590	
ADET160304ER					●	0.4	—		1,590	
ADET160308SR		●	●	●	●	0.8	2,060		1,590	
ADET160308ER		●			●	0.8	2,060		1,590	
ADEW160308SR						0.8	Fig-4		—	—
ADNT160308SR	N級 N		●	●	●	0.8	Fig-3	1,370	1,060	
ADNT160308ER		●			●	0.8		1,370	1,060	

* : アルミ加工専用インサート Inserts for aluminium

○ 標準切削条件表 Recommended cutting conditions

被削材 Work material	推奨材種 Recommended grade	適用インサート Inserts	切削速度 Vc Cutting speed Vc (m/min)	外径 DC Tool diameter															
				φ16		φ20		φ25		φ30		φ35		φ40		φ50			
				回転数 Revolutions min ⁻¹	送り速度 Table speed mm/min	回転数 Revolutions min ⁻¹	送り速度 Table speed mm/min	回転数 Revolutions min ⁻¹	送り速度 Table speed mm/min	回転数 Revolutions min ⁻¹	送り速度 Table speed mm/min	回転数 Revolutions min ⁻¹	送り速度 Table speed mm/min	回転数 Revolutions min ⁻¹	送り速度 Table speed mm/min	回転数 Revolutions min ⁻¹	送り速度 Table speed mm/min	回転数 Revolutions min ⁻¹	送り速度 Table speed mm/min
軟鋼 Mild steels (200HB以下)	CH550	APET12020SR ADNT16030SR	180	3,580	180	2,860	290	2,290	370	1,910	370	1,640	490	1,430	490	1,150	510		
	HC844		140	2,780	220	2,230	360	1,780	360	1,490	360	1,270	460	1,110	460	890	500		
炭素鋼、合金鋼 Carbon steels - Alloy steels (30HRC以下)	CH550		150	2,980	150	2,390	240	1,910	310	1,590	310	1,360	410	1,190	410	950	420		
	EX35 HC844		100	1,990	160	1,590	250	1,270	250	1,060	250	910	330	800	330	640	350		
炭素鋼、合金鋼 Carbon steels - Alloy steels (30~40HRC)	CH550		50	990	80	800	130	640	130	530	130	450	160	400	160	320	170		
	HC844		80	1,590	130	1,270	200	1,020	200	850	200	730	260	640	260	510	290		
ステンレス鋼 Stainless steels	EX35		100	1,990	160	1,590	250	1,270	250	1,060	250	910	330	800	330	640	360		
	HC844		125	2,490	200	1,990	320	1,590	320	1,330	320	1,140	410	990	410	800	450		
鋳鉄 Cast irons	WH10		APET12020ER	80	1,590	160	1,270	250	1,020	250	850	250	730	330	640	330	510	350	
	CY100H		ADNT16030ER	80	1,590	190	1,270	300	1,020	300	850	300	730	390	640	390	510	400	
アルミ合金、銅 Aluminum alloys (SiC15%以下) グラファイト Graphite (65HS)	WH10	APET120202FR ADET160302FR	350	6,960	1,040	5,570	1,670	4,460	1,340	3,710	1,110	3,180	1,430	2,790	1,260	2,230	1,340		

【注意】 ① Bタイプ(アンダーカット形)のボディでは上記条件の70%をご利用ください。 **【Note】** ① In case of B type body (under cut type), apply 70% of the above listed values.
 ② 切りくずのかみこみを防ぐためにエアブローのご使用をおすすめします。 ② Blow residing chips with the air, to prevent clogging of cutting edge.
 ③ この標準切削条件表は切削条件の目安を示すものです。実際の加工では加工形状、目的、使用機械等により条件を調整してください。 ③ These recommended cutting conditions indicate only the rule of a thumb for the cutting conditions. In actual machining, the condition should be adjusted according to the machining shape, purpose and the machine type.

Indexable Tools Square End Mills

Easy Cut Multi Function Mill AHJ

アルファ快削じゅうおう AHJ

- 快削形多機能エンドミルです。
- ドリル加工や傾斜、横送り加工など縦横無尽の加工ができます。
- ・ Multi-function end mill for light cutting.
- ・ Can perform unlimited horizontal and vertical cutting such as drilling, slanted- or horizontal-feed cutting, etc.



AHJ(L) R 標準 刃長形 Regular flute

は数字が入ります。 Numeric figure in a circle

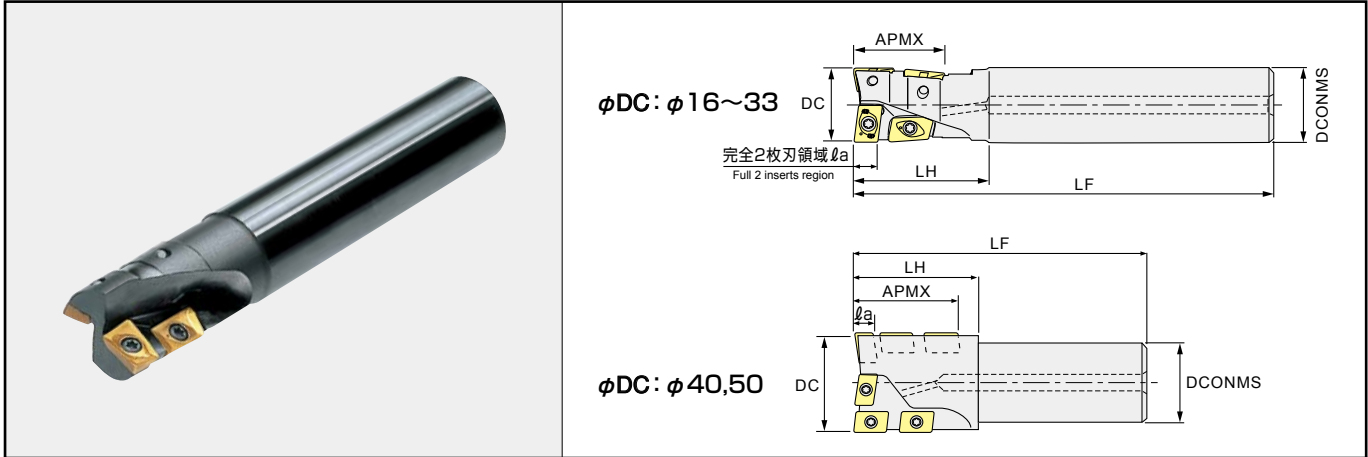

商品コード Item code	在庫 Stock	寸法 Size(mm)							適用インサート Inserts				希望小売価格 (円) Suggested retail price (¥)
		DC	LF	la	APMX	LH	DCONMS	底刃用 On end		外周刃用 On periphery			
								商品コード Item code	使用数 No. of inserts	商品コード Item code	使用数 No. of inserts		
標準形 Regular	AHJ16R	●	16	120	4.5	19	33	16	JDMT0803 L	1	JDMT0903 R	3	37,430
	AHJ20R	●	20	130	5.5	23	35	20	JDMT1003 L	1	JDMT1003 R	3	40,010
	AHJ25R	●	25	140	7.0	29	45	25	JDMT12T3 L	1	JDMT12T3 R	3	41,300
	AHJ32R	●	32	150	8.5	34	50	32	JDMT1605 L	1	JDMT1505 R	3	45,170
	AHJ40R	●	40	160	7.0	40	55	32	JDMT12T3 L	2	JDMT12T3 R	4	54,200
	AHJ50R	●	50	170	8.5	50	70	42	JDMT1605 L	2	JDMT1505 R	4	64,990
ロングシャンク形 Long shank	AHJL16R	●	16	175	4.5	19	50	16	JDMT0803 L	1	JDMT0903 R	3	41,300
	AHJL17R	●	17				33						41,300
	AHJL20R	●	20	185	5.5	23	60	20	JDMT1003 L	1	JDMT1003 R	3	43,880
	AHJL21R	●	21				35						43,880
	AHJL25R	●	25	220	7.0	29	75	25	JDMT12T3 L	1	JDMT12T3 R	3	45,170
	AHJL26R	●	26				45						45,170
	AHJL32R	●	32	230	8.5	34	90	32	JDMT1605 L	1	JDMT1505 R	3	49,040
	AHJL33R	●	33				50						49,040
	AHJL40R	●	40	240	7.0	40	55	32	JDMT12T3 L	2	JDMT12T3 R	4	58,070
	AHJL50R	●	50	250	8.5	50	70	42	JDMT1605 L	2	JDMT1505 R	4	68,630

●印：標準在庫品です。 ●：Stocked items.

AHJ(L)ORS 短刃長形 Short flute

○は数字が入ります。 Numeric figure in a circle ○

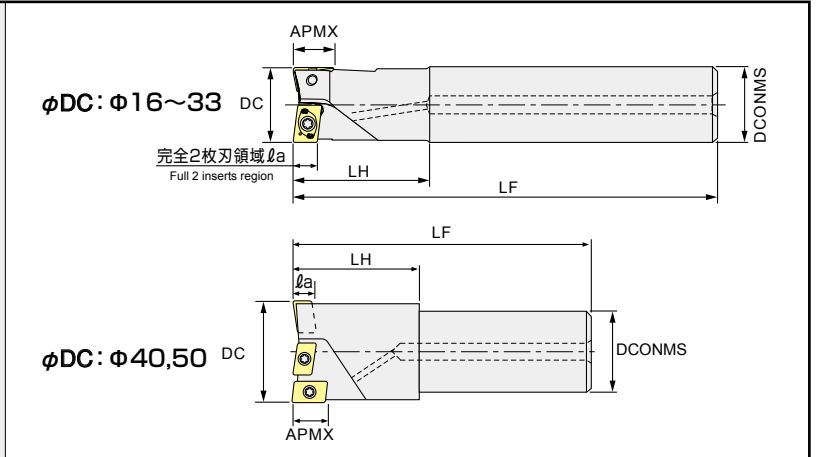

商品コード Item code	在庫 Stock	寸法 Size (mm)						適用インサート Inserts				希望小売価格 (円) Suggested retail price (¥)	
		DC	LF	ℓa	APMX	LH	DCONMS	底刃用 On end		外周刃用 On periphery			
								商品コード Item code	使用数 No. of inserts	商品コード Item code	使用数 No. of inserts		
標準形 Regular	AHJ16RS	●	16	120	4.5	8.5	33	16	JDMT0803○L	1	JDMT0903○R	1	28,040
	AHJ17RS	●	17						JDMT1003○L	1	JDMT1003○R	1	28,040
	AHJ20RS	●	20						JDMT12T3○L	1	JDMT12T3○R	1	29,920
	AHJ21RS	●	21	130	5.5	9.5	35	20	JDMT1605○L	1	JDMT1505○R	1	29,920
	AHJ25RS	●	25						JDMT12T3○L	1	JDMT12T3○R	1	30,970
	AHJ26RS	●	26	140	7.0	12.5	45	25	JDMT1605○L	1	JDMT1505○R	1	30,970
	AHJ32RS	●	32						JDMT12T3○L	1	JDMT12T3○R	1	33,790
	AHJ33RS	●	33	150	8.5	14.5	50	32	JDMT1605○L	1	JDMT1505○R	1	33,790
	AHJ40RS	●	40						JDMT12T3○L	2	JDMT12T3○R	1	40,710
	AHJ50RS	●	50	170	8.5	14.5	70	42	JDMT1605○L	2	JDMT1505○R	1	48,810
ロングシャンク形 Long shank	AHJL16RS	●	16	175	4.5	8.5	50	16	JDMT0803○L	1	JDMT0903○R	1	31,920
	AHJL17RS	●	17				33		JDMT1003○L	1	JDMT1003○R	1	31,920
	AHJL20RS	●	20	185	5.5	9.5	60	20	JDMT12T3○L	1	JDMT12T3○R	1	32,980
	AHJL21RS	●	21				35		JDMT1605○L	1	JDMT1505○R	1	32,980
	AHJL25RS	●	25	220	7.0	12.5	75	25	JDMT12T3○L	1	JDMT12T3○R	1	33,790
	AHJL26RS	●	26				45		JDMT1605○L	1	JDMT1505○R	1	33,790
	AHJL32RS	●	32	230	8.5	14.5	90	32	JDMT12T3○L	1	JDMT12T3○R	1	36,840
	AHJL33RS	●	33				50		JDMT1605○L	1	JDMT1505○R	1	36,840
	AHJL40RS	●	40	240	7.0	12.5	55	32	JDMT12T3○L	2	JDMT12T3○R	1	43,530
	AHJL50RS	●	50	250	8.5	14.5	70	42	JDMT1605○L	2	JDMT1505○R	1	51,390

Easy Cut Multi Function Mill AHJ

アルファ快削じゅうおう AHJ

○は数字が入ります。 Numeric figure in a circle ○

AHJM○○RS

モジュラーミル用シャンクはD2頁を、締め付けトルクについてはD5頁を参照ください。
Refer page D2 about the shanks for Modular Mill, Refer page D5 about tightening torque

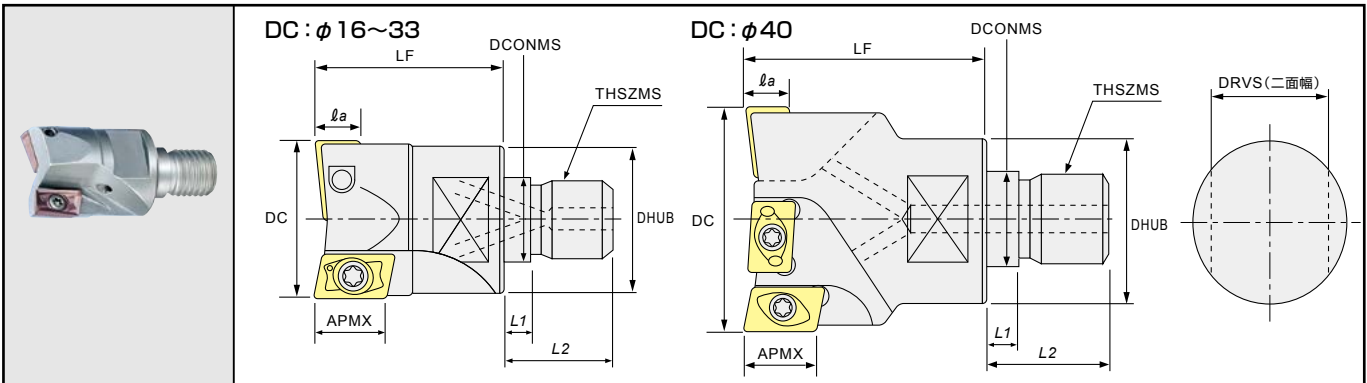

商品コード Item code	在庫 Stock	寸法 Size(mm)										使用インサート Inserts				希望小売 価格(円) Suggested retail price (¥)	
		DC	LF	la	APMX	DCONMS	THSZMS	DHUB	L1	L2	DRVS	底刃用 On end		外周刃用 On periphery			
												商品コード Item code	使用数 No. of inserts	商品コード Item code	使用数 No. of inserts		
短 刃 形 Short flute	AHJM16RS	●	16	25	4.5	8.5	8.5	M8	12.8	5.5	17	10	JDMT0803○○L	1	JDMT0903○○R	1	28,040
	※ AHJM17RS	●	17														28,040
	AHJM20RS	●	20	30	5.5	9.5	10.5	M10	17.8	5.5	19	15	JDMT1003○○L	1	JDMT1003○○R	1	29,920
	※ AHJM21RS	●	21														29,920
	AHJM25RS	●	25	35	7	12.5	12.5	M12	20.8	5.5	22	17	JDMT12T3○○L	1	JDMT12T3○○R	1	30,970
	※ AHJM26RS	●	26														23
	AHJM32RS	●	32	40	8.5	14.5	17	M16	28.8	6	23	22	JDMT1605○○L	1	JDMT1505○○R	1	33,790
	※ AHJM33RS	●	33														33,790
	※ AHJM40RS	●	40	40	7	12.5	17	M16	28.8	6	23	22	JDMT12T3○○L	2	JDMT12T3○○R	1	40,710

【注意】※と超硬シャンクをセットで使用すると干渉がありません。
モジュラーミル及び専用シャンク、専用アーバの「工具端面」「モジュラーねじ部」にグリースなどの潤滑剤は塗布しないでください。
【Note】 When ※ and carbide shank are used together as a set, there is no interference.
Do not apply lubricants such as grease, etc. to the "contact faces" and "modular screws" of the "modular mill", "dedicated shanks" and "dedicated arbor".

部品番号 Parts

部品名 Parts	クランプねじ Clamp screw	ドライバー Screw driver
形状 Shape		
適用カッタ Cutter body	締付トルク Fastening torque (N·m)	希望小売価格 (円) Suggested retail price(¥)
φ16/17...AHJ(L) 16/17R(S) AHJM16/17RS	250-140	0.5
φ20/21...AHJ(L) 20/21R(S) AHJM20/21RS	251-141	1.1
φ25/26...AHJ(L) 25/26R(S) AHJM25/26RS	265-143	2.0
φ32/33...AHJ(L) 32/33R(S) AHJM32/33RS	412-141	2.9
φ40...AHJ(L) 40R(S) AHJM40RS	265-143	2.0
φ50...AHJ(L) 50R(S)	412-141	2.9

【注意】クランプねじは消耗品です。使用環境により交換寿命は変化しますので早めの交換をお願い致します。
【Note】 The clamp screw is a consumable part. Since replacement life depends on the use environment, it is recommended that it be replaced at an early stage.

●印：標準在庫品です。 ●：Stocked items. 無印：弊社営業へお問合せください。 No mark：Contact with our sales department.

刃先交換式工具 スクエアエンドミル

■ インサート Insert

Fig.1 底刃用インサート
Inserts on end

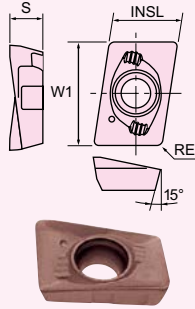
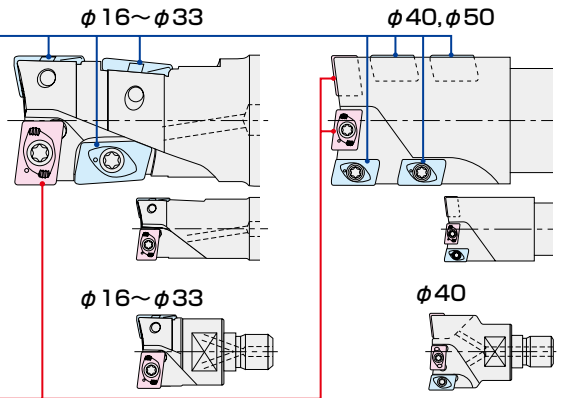
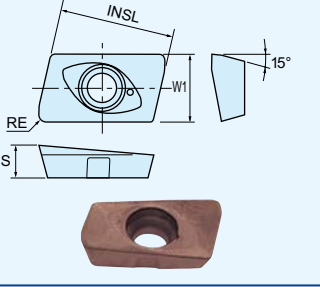

Fig.2 外周刃用インサート
Inserts on periphery



【注意】 $R \geq 2.0$ のインサートを使用する場合はボデーコーナ部を追加加工する必要があります。
 【Note】 When using the insert with $R \geq 2.0$, it is necessary to carry out additional processing of cutter body corner part.

P 鋼 Carbon steels		M SUS等 SUS, etc.		K FC・FCD Cast irons		<input type="checkbox"/> : 一般切削・第一推奨 General cutting, First recommended <input type="checkbox"/> : 一般切削・第二推奨 General cutting, Second recommended										
適用インサート Inserts				※ 使用数 No. of inserts	精度 Tolerance class	AJ コーティング AJ Coating		JS コーティング JS Coating		TH コーティング TH Coating		寸法 Size(mm)				希望小売 価格(円) Suggested retail price (¥)
外径 DC Tool dia.	コーナ R Corner R	インサート 取付け位置 Position	商品コード Item code			JP4120	JS4045	JS4060	PTH30E	PTH13S	INSL	W1	S	RE		
φ16 φ17	R0.4	底刃用 On end Fig.1	JDMT080304L	1	M級 M	●	●	●	●		5.3	7.8	3.0	0.4	970	
		外周刃用 On periphery Fig.2	JDMT090304R	3(1)		●	●	●	●		9.2	5.0	2.8	0.4	970	
R0.8	底刃用 On end Fig.1	JDMT080308L	1	●		●	●	●	●	5.3	7.8	3.0	0.8	970		
	外周刃用 On periphery Fig.2	JDMT090308R	3(1)	●		●	●	●	●	9.2	5.0	2.8	0.8	970		
φ20 φ21	R0.4	底刃用 On end Fig.1	JDMT100304L	1		●	●	●	●		6.3	9.8	3.2	0.4	1,310	
		外周刃用 On periphery Fig.2	JDMT100304R	3(1)		●	●	●	●	[●]	11.0	6.1	3.5	0.4	1,310	
	R0.8	底刃用 On end Fig.1	JDMT100308L	1		●	●	●	●	●	6.3	9.8	3.2	0.8	1,310	
		外周刃用 On periphery Fig.2	JDMT100308R	3(1)		●	●	●	●	●	11.0	6.1	3.5	0.8	1,310	
	R2.0	底刃用 On end Fig.1	JDMT100320L	1		●	●	●	●		6.3	9.8	3.2	2.0	1,310	
		外周刃用 On periphery Fig.2	JDMT100320R	1		●	[●]	●	●	●	11.0	6.1	3.5	2.0	1,310	
			JDMT100308R	2(0)		●	[●]	●	●	[●]	11.0	6.1	3.5	0.8	1,310	
φ25 φ26	R0.8	底刃用 On end Fig.1	JDMT12T308L	1		●	●	●	●	●	7.9	12.3	3.9	0.8	1,370	
		外周刃用 On periphery Fig.2	JDMT12T308R	3(1)		●	●	●	●	●	13.6	8.0	3.9	0.8	1,370	
	R2.0	底刃用 On end Fig.1	JDMT12T320L	1		●		●	●	●	7.9	12.3	3.9	2.0	1,370	
		外周刃用 On periphery Fig.2	JDMT12T320R	1		●		●	●	●	13.6	8.0	3.9	2.0	1,370	
				JDMT12T308R		2(0)	●	[●]	●	●	[●]	13.6	8.0	3.9	0.8	1,370
				JDMT12T330L		1	●		●	●	●	7.9	12.3	3.9	3.0	1,370
φ32 φ33	R0.8	底刃用 On end Fig.1	JDMT12T330R	1		●		●	●	●	13.6	8.0	3.9	3.0	1,370	
		外周刃用 On periphery Fig.2	JDMT12T308R	2(0)		●	[●]	●	●	[●]	13.6	8.0	3.9	0.8	1,370	
	R3.0	底刃用 On end Fig.1	JDMT150530L	1		●		●	●	●	9.5	15.8	5.0	3.0	1,490	
		外周刃用 On periphery Fig.2	JDMT150530R	1	●	[●]	●	●	●	16.0	9.1	5.0	3.0	1,490		
				JDMT150508R	2(0)	●	[●]	●	●	[●]	16.0	9.1	5.0	0.8	1,490	
				JDMT150508R	2(0)	●	[●]	●	●	[●]	16.0	9.1	5.0	0.8	1,490	
φ40	R0.8	底刃用 On end Fig.1	JDMT12T308L	2	●	●	●	●	●	7.9	12.3	3.9	0.8	1,370		
		外周刃用 On periphery Fig.2	JDMT12T308R	4(1)	●	●	●	●	●	13.6	8.0	3.9	0.8	1,370		
	R2.0	底刃用 On end Fig.1	JDMT12T320L	1	●		●	●	●	7.9	12.3	3.9	2.0	1,370		
		外周刃用 On periphery Fig.2	JDMT12T320R	1	●	[●]	●	●	[●]	7.9	12.3	3.9	0.8	1,370		
				JDMT12T308R	3(0)	●	[●]	●	●	[●]	13.6	8.0	3.9	0.8	1,370	
				JDMT12T308R	3(0)	●	[●]	●	●	[●]	13.6	8.0	3.9	0.8	1,370	
φ50	R0.8	底刃用 On end Fig.1	JDMT12T330L	1	●		●	●	●	7.9	12.3	3.9	3.0	1,370		
		外周刃用 On periphery Fig.2	JDMT12T330R	1	●	[●]	●	●	[●]	7.9	12.3	3.9	0.8	1,370		
	R3.0	底刃用 On end Fig.1	JDMT12T308L	1	●		●	●	●	13.6	8.0	3.9	3.0	1,370		
		外周刃用 On periphery Fig.2	JDMT12T308R	3(0)	●	[●]	●	●	[●]	13.6	8.0	3.9	0.8	1,370		
				JDMT12T308R	3(0)	●	[●]	●	●	[●]	13.6	8.0	3.9	0.8	1,370	
				JDMT12T308R	3(0)	●	[●]	●	●	[●]	13.6	8.0	3.9	0.8	1,370	
φ50	R0.8	底刃用 On end Fig.1	JDMT160508L	2	●	●	●	●	●	9.5	15.8	5.0	0.8	1,490		
		外周刃用 On periphery Fig.2	JDMT160508R	4(1)	●	●	●	●	●	16.0	9.1	5.0	0.8	1,490		
	R3.0	底刃用 On end Fig.1	JDMT160530L	1	●		●	●	●	9.5	15.8	5.0	3.0	1,490		
		外周刃用 On periphery Fig.2	JDMT160530R	1	●	[●]	●	●	●	16.0	9.1	5.0	3.0	1,490		
				JDMT160508L	1	●	[●]	●	●	[●]	9.5	15.8	5.0	0.8	1,490	
				JDMT160508R	1	●	[●]	●	●	[●]	16.0	9.1	5.0	0.8	1,490	

[] : 底刃用と同じ材種がないため推奨いたしません。 [] : Since the same insert grade is not used for the bottom flute, it is not recommended.
 ※ : (カッコ)内は短刃長形とモジュラーミルのインサート使用数です。 ※ : Numbers in parentheses are the number of inserts when using a short flute and Modular Mill.
 【注意】 JSコートは通電式タッチセンサーに反応しませんのでご注意ください。 【Note】 Please note that the JS coating does not cause a reaction in conductive touch sensors.

Indexable Tools Square End Mills

Easy Cut Multi Function Mill AHJ

アルファ快削じゅうおう AHJ

標準切削条件表 Recommended cutting conditions

肩削り加工条件 Cutting conditions for shoulder milling

- 切込み深さ l_a までは完全2枚刃です。
- l_a を超えると、オーバーラップの関係により、1枚刃領域が発生します。切込み深さと送り速度の関係に注意して下さい。
- 一般的に切込み境界部はインサートの損傷が大きくなる傾向にあります。深切込みでご使用の際は、切込み境界部が2枚刃になる切込み量を推奨します。

- Full 2 inserts are used up to the cutting depth l_a .
- If l_a is exceeded, depending on the overlap relationship, a single insert region may occur. Care should be taken regarding the relationship between cutting depth and feed rate.
- In general, insert damage tends to become larger at the border region of the cut. When using for deep cutting, it is recommended that the cutting depth be set so that two inserts will be used at the cutting border region.

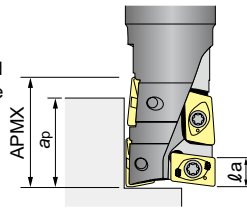

工具径DC Tool dia.	推奨切込み量 a_p Recommended a_p		最大切込み量 APMX
	完全2枚刃領域 l_a Full 2 inserts region		
$\phi 16, \phi 17$	~4.5	13~16	19
$\phi 20, \phi 21$	~5.5	15~18	23
$\phi 25, \phi 26$	~7.0	18~24	29
$\phi 32, \phi 33$	~8.5	21~28	34
$\phi 40$	~7.0	21~23	42
$\phi 50$	~8.5	24~28	50

※赤字は第一推奨材種です。 ※Red indicates primary recommended grade.

被削材 Work material	推奨材種 Recommended grade	切削速度 v_c (m/min) Cutting speed	工具径DC Tool dia.(mm)							
			$\phi 16, \phi 17$				$\phi 20, \phi 21$			
			切込み深さ a_p (mm) Cutting Depth	切込み幅 a_e (mm) Cutting Width	送り速度 V_f (mm/min) Feed	1刃当りの送り f_z (mm/t) Feed rate	切込み深さ a_p (mm) Cutting Depth	切込み幅 a_e (mm) Cutting Width	送り速度 V_f (mm/min) Feed	1刃当りの送り f_z (mm/t) Feed rate
一般構造用鋼 Steels for general structure SS($\leq 180\text{HB}$)	※ JS4060 JS4045 PTH30E	180 (140~220)	~4.5	~8	570	0.08	~5.5	~10	860	0.15
			4.5~13	~3	500	0.07	5.5~15	~6	690	0.12
			13~19	~2	290	0.04	15~23	~3	460	0.08
			回転数 $n=3,580\text{min}^{-1}$ ($v_c=180\text{m/min}$)				回転数 $n=2,870\text{min}^{-1}$ ($v_c=180\text{m/min}$)			
炭素鋼・合金鋼 Carbon Steels & Alloy Steels S-C SCM (180~300HB)	JS4060 JS4045	160 (120~200)	~4.5	~8	510	0.08	~5.5	~10	760	0.15
			4.5~13	~3	450	0.07	5.5~15	~6	610	0.12
			13~19	~2	250	0.04	15~23	~3	410	0.08
			回転数 $n=3,180\text{min}^{-1}$ ($v_c=160\text{m/min}$)				回転数 $n=2,550\text{min}^{-1}$ ($v_c=160\text{m/min}$)			
炭素鋼・合金鋼 Carbon Steels & Alloy Steels S-C SCM (30~40HRC)	JP4120	100 (70~120)	~4.5	~6	320	0.08	~5.5	~6	320	0.10
			4.5~13	~2	280	0.07	5.5~15	~4	260	0.08
			13~19	~1	160	0.04	15~23	~2	190	0.06
			回転数 $n=1,990\text{min}^{-1}$ ($v_c=100\text{m/min}$)				回転数 $n=1,590\text{min}^{-1}$ ($v_c=100\text{m/min}$)			
ステンレス鋼 Stainless Steels SUS	Dry JS4045	250 (200~300)	~4.5	~8	800	0.08	~5.5	~10	1,200	0.15
			4.5~13	~3	700	0.07	5.5~15	~6	960	0.12
	Wet PTH30E	100 (80~120)	~4.5	~8	320	0.08	~5.5	~10	480	0.15
			4.5~13	~3	280	0.07	5.5~15	~6	380	0.12
回転数 $n=1,990\text{min}^{-1}$ ($v_c=100\text{m/min}$)				回転数 $n=1,590\text{min}^{-1}$ ($v_c=100\text{m/min}$)						
鋳鉄 Cast Irons FC FCD	PTH13S	160 (120~200)	~4.5	~8	640	0.10	~5.5	~10	760	0.15
			4.5~13	~4	450	0.07	5.5~15	~7	610	0.12
			13~19	~3	260	0.04	15~23	~4	410	0.08
			回転数 $n=3,180\text{min}^{-1}$ ($v_c=160\text{m/min}$)				回転数 $n=2,550\text{min}^{-1}$ ($v_c=160\text{m/min}$)			

【注意】(1)短刃長形は切込み深さに注意して下さい。
(2)JSコーティングは通電式タッチセンサーに反応しませんのでご注意ください。

DC: 工具径 Tool dia.(mm)

工具径DC Tool dia.	工具突出し長さ Overhang		
	DC×2	DC×3	DC×4
φ16, φ17	ae×1	ae×0.6	ae×0.3
φ20, φ21	ae×1	ae×0.8	ae×0.6
φ25, φ26	ae×1	ae×1	ae×0.7
φ32, φ33	ae×1	ae×1	ae×0.8
φ40	ae×1	ae×1	ae×0.8
φ50	ae×1	ae×1	ae×0.8

- 工具突出し量が多い場合は、びびり振動などが発生しやすく、不安定な切削状態になりがちです。異常損傷、短寿命の原因となりますので右表の係数を参考にして下の条件表の切込み幅aeを小さくして加工して下さい。
- モジュラー超硬シャンクにて5DC以上の突き出し長さでご使用される場合、切削速度vcに0.7~0.5の係数を掛けて条件設定をして下さい。

- When the amount the tool sticks out is large, chattering vibrations, etc. are more likely to occur, making cutting conditions unstable. Since this may result in abnormal damage and cause shortened tool life, refer to the factors in the table at right and reduce the cutting width ae when machining.
- When using a modular carbide shank with a tool overhang of 5DC or more, set the conditions by multiplying cutting speed vc by a factor of 0.7 to 0.5.

工具径DC Tool dia.(mm)																被削材 Work material
φ25, φ26				φ32, φ33				φ40				φ50				
切込み深さ ap (mm) Cutting Depth	切込み幅 ae (mm) Cutting Width	送り速度 Vf (mm/min) Feed	1刃当りの送り fz (mm/t) Feed rate	切込み深さ ap (mm) Cutting Depth	切込み幅 ae (mm) Cutting Width	送り速度 Vf (mm/min) Feed	1刃当りの送り fz (mm/t) Feed rate	切込み深さ ap (mm) Cutting Depth	切込み幅 ae (mm) Cutting Width	送り速度 Vf (mm/min) Feed	1刃当りの送り fz (mm/t) Feed rate	切込み深さ ap (mm) Cutting Depth	切込み幅 ae (mm) Cutting Width	送り速度 Vf (mm/min) Feed	1刃当りの送り fz (mm/t) Feed rate	
~7	~12.5	780	0.17	~8.5	~16	720	0.20	~7	~20	490	0.17	~8.5	~25	460	0.20	一般構造用鋼 Steels for general structure SS(≤180HB)
7~18	~7	600	0.13	8.5~21	~10	540	0.15	7~21	~12	370	0.13	8.5~24	~15	350	0.15	
18~29	~4	460	0.10	21~34	~5	430	0.12	21~42	~8	290	0.10	24~50	~10	280	0.12	
回転数n=2,290min ⁻¹ (vc=180m/min)				回転数n=1,790min ⁻¹ (vc=180m/min)				回転数n=1,430min ⁻¹ (vc=180m/min)				回転数n=1,150min ⁻¹ (vc=180m/min)				
~7	~12.5	700	0.17	~8.5	~16	640	0.20	~7	~20	430	0.17	~8.5	~25	410	0.20	炭素鋼・合金鋼 Carbon Steels & Alloy Steels S-C SCM (180~300HB)
7~18	~7	530	0.13	8.5~21	~10	480	0.15	7~21	~12	330	0.13	8.5~24	~15	310	0.15	
18~29	~4	410	0.10	21~34	~5	380	0.12	21~42	~8	250	0.10	24~50	~10	250	0.12	
回転数n=2,040min ⁻¹ (vc=160m/min)				回転数n=1,590min ⁻¹ (vc=160m/min)				回転数n=1,270min ⁻¹ (vc=160m/min)				回転数n=1,020min ⁻¹ (vc=160m/min)				
~7	~8	310	0.12	~8.5	~10	300	0.15	~7	~20	190	0.12	~8.5	~25	190	0.15	炭素鋼・合金鋼 Carbon Steels & Alloy Steels S-C SCM (30~40HRC)
7~18	~6	260	0.10	8.5~21	~7	240	0.12	7~21	~12	160	0.10	8.5~24	~15	150	0.12	
18~29	~3	200	0.08	21~34	~4	200	0.10	21~42	~8	130	0.08	24~50	~10	130	0.10	
回転数n=1,270min ⁻¹ (vc=100m/min)				回転数n=1,000min ⁻¹ (vc=100m/min)				回転数n= 800min ⁻¹ (vc=100m/min)				回転数n= 640min ⁻¹ (vc=100m/min)				
~7	~12.5	1,080	0.17	~8.5	~16	1,000	0.20	~7	~20	680	0.17	~8.5	~25	640	0.20	ステンレス鋼 Stainless Steels SUS
7~18	~7	830	0.13	8.5~21	~10	750	0.15	7~21	~12	520	0.13	8.5~24	~15	480	0.15	
18~29	~4	640	0.10	21~34	~5	600	0.12	21~42	~8	400	0.10	24~50	~10	380	0.12	
回転数n=3,180min ⁻¹ (vc=250m/min)				回転数n=2,490min ⁻¹ (vc=250m/min)				回転数n=1,990min ⁻¹ (vc=250m/min)				回転数n=1,590min ⁻¹ (vc=250m/min)				
~7	~12.5	430	0.17	~8.5	~16	400	0.20	~7	~20	270	0.17	~8.5	~25	260	0.20	鋳鉄 Cast Irons FC FCD
7~18	~7	330	0.13	8.5~21	~10	300	0.15	7~21	~12	210	0.13	8.5~24	~15	190	0.15	
18~29	~4	260	0.10	21~34	~5	240	0.12	21~42	~8	160	0.10	24~50	~10	150	0.12	
回転数n=1,270min ⁻¹ (vc=100m/min)				回転数n=1,000min ⁻¹ (vc=100m/min)				回転数n= 800min ⁻¹ (vc=100m/min)				回転数n= 640min ⁻¹ (vc=100m/min)				
~7	~12.5	690	0.17	~8.5	~16	640	0.20	~7	~20	430	0.17	~8.5	~25	410	0.20	鋳鉄 Cast Irons FC FCD
7~18	~8	530	0.13	8.5~21	~11	480	0.15	7~21	~12	330	0.13	8.5~24	~15	310	0.15	
18~29	~5	410	0.10	21~34	~6	380	0.12	21~42	~8	250	0.10	24~50	~10	250	0.12	
回転数n=2,040min ⁻¹ (vc=160m/min)				回転数n=1,590min ⁻¹ (vc=160m/min)				回転数n=1,270min ⁻¹ (vc=160m/min)				回転数n=1,020min ⁻¹ (vc=160m/min)				

[Note] (1) For short flute type, use extra caution regarding the cutting depth.
 (2) Please note that the JS Coating does not cause a reaction in conductive touch sensors.

Easy Cut Multi Function Mill AHJ

アルファ快削じゅうおう AHJ

■ 溝削り加工条件 Cutting condition for slotting.

- 肩削り加工条件を参考に、送り速度は70%を目安として下さい。
 - 切込み深さは完全2枚刃領域 l_a での切削を推奨します。
- Refer to the cutting conditions for shoulder milling and set the feed rate to 70% of the value as general criteria.
• It is recommended that the cutting depth be set within the full 2 inserts region l_a .

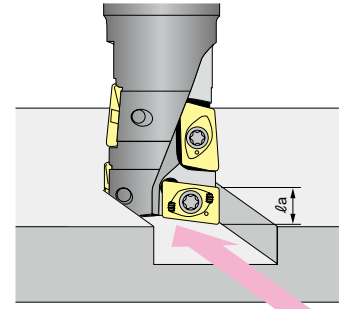

■ 傾斜加工条件 Cutting condition for ramping

- 肩削り加工条件を参考に送り速度は、70%を目安として下さい。
 - 鋼切削時の傾斜角度 θ は3°以下を推奨します。
これをこえると切りくずが分断されず、工具本体にからみつく場合があります危険です。
 - 40HRC以上の傾斜角度は1°以下に設定して下さい。
- Refer to the cutting conditions for shoulder milling and set the feed rate to 70% of the value as general criteria.
• When cutting steel, it is recommended that the ramp angle θ is 3° or less. With angles larger than this there is a danger of the cut chips not breaking off and sticking to the tool body.
• For hardnesses higher than 40HRC, the ramp angle should be set to 1° or less.

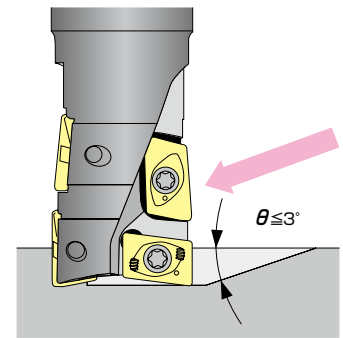

■ ドリル加工条件 Cutting condition for drilling

- 穴加工深さは工具径の半分以下にてご使用下さい。また、40HRC以上の穴加工には、ヘリカル穴あけを適用して下さい。
- 切りくず分断のためステップ送りを行って下さい。
- 切りくず除去のため、エアブローを使用しながら加工して下さい。
- 切りくずが思わぬ方向へ飛び散る場合がありますので、適切な安全策を施してご使用下さい。
- 外径 ϕ 17、21、26、33のAHJM、AHJL、AHJL-RSは、穴中心部に ϕ 1程度の柱が残ります。

※赤字は第一推奨材種です。
Red indicates primary recommended grade.

被削材 Work material	推奨材種 Recommended grade	切削速度 V_c (m/min) Cutting speed	工具径DC Tool dia.(mm)							
			$\phi 16, \phi 17$		$\phi 20, \phi 21$		$\phi 25, \phi 26$			
			送り Feed (mm/min)	ステップ Step (mm)	送り Feed (mm/min)	ステップ Step (mm)	送り Feed (mm/min)	ステップ Step (mm)		
一般構造用鋼 Steels for general structure SS($\leq 180\text{HB}$)	※JS4060 JS4045 PTH30E	180 (140~220)	110	0.2	120	0.3	120	0.3	120	0.3
炭素鋼・合金鋼 Carbon Steels & Alloy Steels S-C SCM(180~300HB)	JS4060 JS4045	160 (120~200)	100	0.2	100	0.3	100	0.3	100	0.3
炭素鋼・合金鋼 Carbon Steels & Alloy Steels S-C SCM(30~40HRC)	JP4120	100 (70~120)	40	0.15	50	0.25	50	0.25	50	0.25
ステンレス鋼 Stainless Steels SUS	JS4045 PTH30E	100 (80~120)	60	0.15	60	0.25	60	0.25	60	0.25
鋳鉄 Cast Irons FC FCD	PTH13S	160 (120~200)	130	0.3	130	0.5	120	0.5	120	0.5

- 【注意】 (1) 切削の条件は上記表を参考に、加工時の状況に合わせて調整して下さい。
(2) JSコーティングは通電式タッチセンサーに反応しませんのでご注意ください。
(3) インサート交換は早めに行い、過度の使用による破損を防止してください。
(4) 排出した切りくずは飛散し作業者を切傷させ、火傷あるいは目に入って負傷させる恐れがありますので、ご使用に際してはその周囲に安全カバーを取り付け保護めがね等の保護具を着用して、安全な環境で作業される事をお願いします。
(5) 不水溶性切削油は、火災の恐れがありますので使用しないで下さい。

■ プランジ加工条件 Cutting condition for plunging

- ドリル加工条件を参考に送り速度は、150～180%を目安として下さい。
 - ステップ送りは不要です。
 - ピックフィード $pf \leq 0.5DC$ 、径方向切込み量 ae は下表を参照して下さい。
- Refer to the cutting conditions for drilling and set feed rate at 150% to 180% as general criteria.
 • Step feed is not necessary.
 • Pick feed $pf \leq 0.5DC$; Refer to the table below for diametrical cutting amount ae .

工具径 DC Tool dia.	$\phi 16, \phi 17$	$\phi 20, \phi 21$	$\phi 25, \phi 26$	$\phi 32, \phi 33$	$\phi 40$	$\phi 50$
径方向切込み量 ae Radial depth of cut	4.5	6	7.5	8.5	7.5	8.5

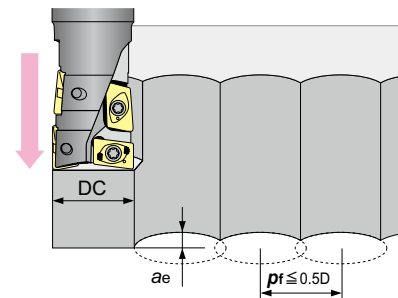

■ ヘリカル穴あけ条件 Cutting condition for helical boring

- 肩削り加工条件を参考に送り速度は、70%を目安として下さい。
 - 工具径 DC におけるヘリカル穴径 ϕDH は $1.2DC \sim 1.8DC$ です。
 - 切りくず除去のため、エアブローを使用しながら加工して下さい。
- Refer to the cutting conditions for shoulder milling and set the feed rate to 70% of the value as general criteria.
 • The helical hole diameter ϕDH for a tool diameter DC is 1.2DC to 1.8DC.
 • Boring should be performed while using an air blower to discharge cutting chips.

・工具中心軌跡
Helical centrode

$$\phi Dt = \phi D_H - DC$$

$$P = \pi \times \phi Dt \times \tan \theta$$

ヘリカル穴径 Helical hole dia. 工具径 DC Tool dia.
傾斜角 Ramp angle

・工具 1 周当りの切込み量
Cutting amount per tool rotation

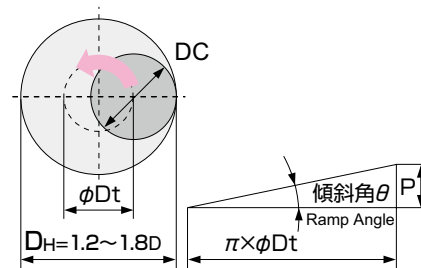

- The drill hole depth h should be less than the one half the tool diameter. In addition, for materials with hardnesses of 40HRC or higher, helical boring should be performed.
- To allow the cut chips to break off, step feed should be performed.
- An air blower should be used while machining to remove chips.
- Since the cut chips may fly off in unexpected directions, take appropriate safety measures when machining.
- For AHJM, AHJL, and AHJL-RS with flute diameters of $\phi 17, 21, 26,$ and $33,$ a column with a diameter of about $\phi 1$ will be left in the center of the hole.

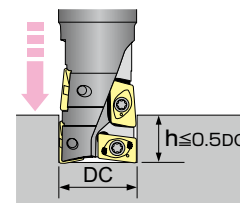

	工具径 DC Tool dia. (mm)						被削材 Work material
	$\phi 32, \phi 33$		$\phi 40$		$\phi 50$		
	送り Feed (mm/min)	ステップ Step (mm)	送り Feed (mm/min)	ステップ Step (mm)	送り Feed (mm/min)	ステップ Step (mm)	
	90	0.3	70	0.3	60	0.3	一般構造用鋼 Steels for general structure SS ($\leq 180HB$)
	回転数 $n=1,790\text{min}^{-1}$		回転数 $n=1,430\text{min}^{-1}$		回転数 $n=1,150\text{min}^{-1}$		
	80	0.3	60	0.3	50	0.3	炭素鋼・合金鋼 Carbon Steels & Alloy Steels S-C SCM (180~300HB)
	回転数 $n=1,590\text{min}^{-1}$		回転数 $n=1,270\text{min}^{-1}$		回転数 $n=1,020\text{min}^{-1}$		
	40	0.25	30	0.25	25	0.25	炭素鋼・合金鋼 Carbon Steels & Alloy Steels S-C SCM (30~40HRC)
	回転数 $n=1,000\text{min}^{-1}$		回転数 $n=800\text{min}^{-1}$		回転数 $n=640\text{min}^{-1}$		
	50	0.25	40	0.25	30	0.25	ステンレス鋼 Stainless Steels SUS
	回転数 $n=1,000\text{min}^{-1}$		回転数 $n=800\text{min}^{-1}$		回転数 $n=640\text{min}^{-1}$		
	110	0.5	75	0.5	60	0.5	鋳鉄 Cast Irons FC FCD
	回転数 $n=1,590\text{min}^{-1}$		回転数 $n=1,270\text{min}^{-1}$		回転数 $n=1,020\text{min}^{-1}$		

- [Note]**
- (1) Choose the best cutting condition from above table.
 - (2) Please note that the JS Coating does not cause a reaction in conductive touch sensors.
 - (3) In order to avoid of insert breakage, please change insert earlier.
 - (4) The steel chips may cause cuts, burns or damages to eyes.
Be sure to install the safety cover around the tool and wear the safety glasses when carrying out any works.
 - (5) Please don't use cutting oil as coolant. (It may be cause of fire.)

アルファスーパーじゅうおう ASJ

- ロング刃の多機能工具です。使用工具本数を大幅に削減できます。
- 切れ味の良いプレーカー付きインサートにより、荒～中仕上げまで軽快な切削が可能です。

・ Long cutting-edged end mill for multi-function, (See the figure) It is able much to reduce the number of in use.
 ・ Able to machine easily from roughing to semi finishing by the insert with light cutting forced breaker .

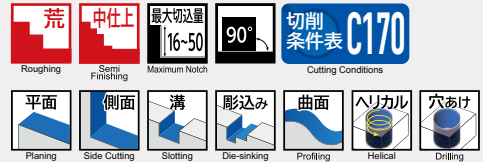

ASJ(L/E)○○R

○は数字が入ります。 Numeric figure in a circle ○

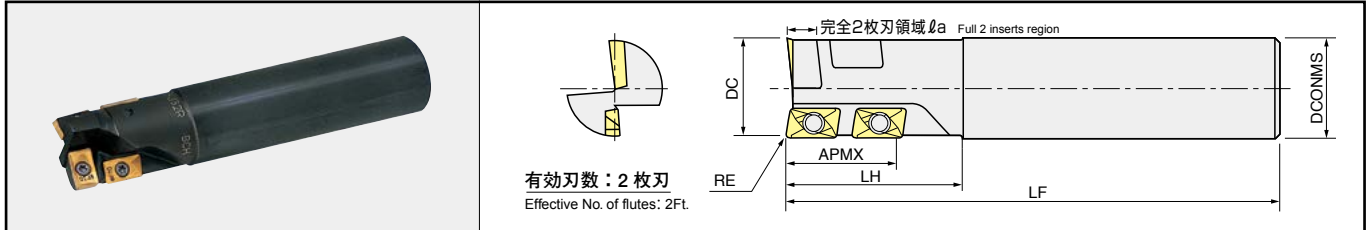

商品コード Item code	在庫 Stock	寸法 (mm) Size							適用インサート Inserts				希望小売 価格(円) Suggested retail price(¥)
		DC	LF	la	APMX	LH	DCONMS	底刃用 On end		外周刃用 On periphery			
								商品コード Item code	使用数 No. of inserts	商品コード Item code	使用数 No. of inserts		
標準形 Reguler	ASJ16R	●	16	120	5	16	33	16	ADMT080308L	1	APMT090208R	3	34,730
	ASJ20R	●	20	130	5.5	20	35	20	ADMT1003○○L	1	ACMT1003○○R	3	37,080
	ASJ25R	●	25	140	7	25	40	25	ADMT12T3○○L	1	APMT12T3○○R	3	38,250
	ASJ32R	●	32	150	8.5	32	50	32	APMT1604○○L	1	APMT1504○○R	3	43,060
	ASJ35R	●	35			35			1	3		43,060	
	ASJ40R	●	40	160	9	40	55	APMT1704○○L	1	4		51,740	
	ASJ50R	●	50	170	10	50	70	42	APMT1905○○L	1		5	59,480
ASJL16R	●	16	175	5	16	50	16	ADMT080308L	1	APMT090208R		3	38,130
ロング シャंक形 Long shank	ASJL20R	●	20	185	5.5	20	60	20	ADMT1003○○L	1	ACMT1003○○R	3	40,940
	ASJL21R	●	21										
	ASJL25R	●	25	220	7	25	75	25	ADMT12T3○○L	1	APMT12T3○○R	3	42,120
	ASJL26R	●	26										
	ASJL32R	●	32	230	8.5	32	90	32	APMT1604○○L	1	APMT1504○○R	3	47,400
	ASJL35R	●	35						35	1		3	47,400
	ASJL40R	●	40	240	9	40	55	APMT1704○○L	1	4		56,780	
	ASJL50R	●	50	250	10	50	70	42	APMT1905○○L	1		5	65,580
エキストラ ロング形 Extra long	ASJE26R	●	26	300	7	25	40	25	ADMT12T3○○L	1	APMT12T3○○R	3	46,340
	ASJE35R	●	35	350	8.5	35	50	32	APMT1704○○L	1	APMT1504○○R	3	51,970
	ASJE40R	●	40	400	9	40	55	32	APMT1905○○L	1	4	61,830	

■ 切削領域 Application Range

< 1 > φ25 ~ 26 肩削りの切削領域 Side milling

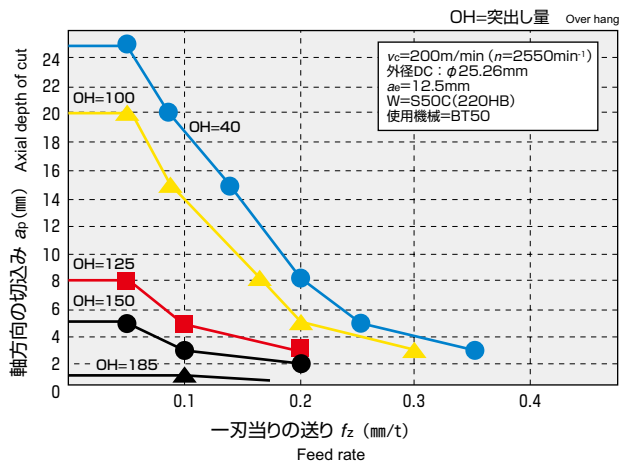

< 2 > φ40 肩削りの切削領域 Side milling

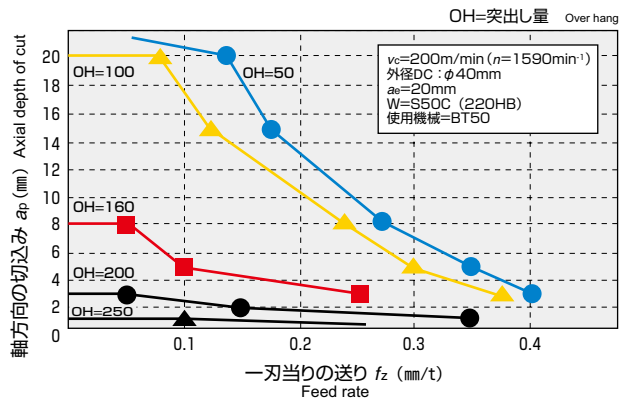

●印：標準在庫品です。 ●：Stocked items. 無印：弊社営業へお問合せください。 No mark：Contact with our sales department.

■ インサート Inserts

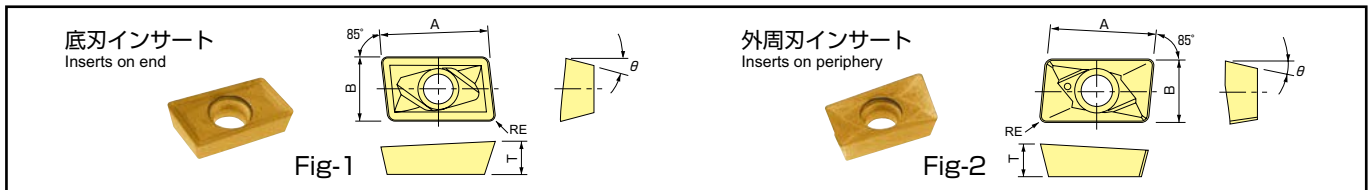

商品コード Item code	精度 Tolerance class	コーティング Coating			寸法 Size(mm)					形状 Shape	希望小売価格(円) Suggested retail price (¥)
		CY250	GF30	CY100H	A	B	T	θ	RE		
ADMT080308L	M 級 M	●		●	7.8	6.2	3.0	15°	0.8	Fig-1	1,280
ADMT100308L		●	●	●	10.4	6.35	3.18	15°	0.8		1,350
ADMT100320L		●			10.4	6.35	3.18	15°	2.0		1,350
ADMT12T308L		●	●	●	12.6	7.93	3.9	15°	0.8		1,400
ADMT12T320L		●		●	12.6	7.93	3.9	15°	2.0		1,400
ADMT12T330L		●	●		12.6	7.93	3.9	15°	3.0		1,400
APMT160408L		●	●	●	16.45	9.53	4.76	11°	0.8		1,470
APMT160430L		●			16.45	9.53	4.76	11°	3.0		1,470
APMT170408L		●	●	●	17.6	9.53	4.76	11°	0.8		1,520
APMT170430L		●			17.6	9.53	4.76	11°	3.0		1,520
APMT190508L		●	●	●	19.6	10	5.0	11°	0.8		1,760
APMT190530L		●			19.6	10	5.0	11°	3.0		1,760
APMT250508L		●	●	●	25.4	11	5.5	11°	0.8		2,300
APMT250530L		●			25.4	11	5.5	11°	3.0		2,300
APMT090208R	M 級 M	●		●	9.1	5.1	2.6	11°	0.8	Fig-2	1,100
ACMT100308R		●	●	●	10.1	6.35	3.4	7°	0.8		1,250
ACMT100320R		●			10.1	6.35	3.4	7°	2.0		1,250
APMT12T308R		●	●	●	13.14	7.93	3.9	11°	0.8		1,320
APMT12T320R		●		●	13.14	7.93	3.9	11°	2.0		1,320
APMT12T330R		●	●		13.14	7.93	3.9	11°	3.0		1,320
APMT150408R		●	●	●	15.88	9.53	4.76	11°	0.8		1,410
APMT150430R		●	●		15.88	9.53	4.76	11°	3.0		1,410

【注意】 コーナRE2以上のインサートを使用する場合はボディコーナ部を追加加工する必要があります。
【Note】 When inserts over RE2 are used the corner of insert pockets on cutter body must be modified to an appropriate radius for the clamping inserts.

■ 部品番号 Parts

部品名 Parts	形状 Shape	クランプねじ Clamp screw		ドライバー Screw driver		
		適用カット Cutter body	締付トルク Fastening torque (N·m)	希望小売価格(円) Suggested retail price(¥)	適用カット Cutter body	希望小売価格(円) Suggested retail price(¥)
ASJ(L)16R(底刃 End insert)		250-141	1.1	870	104-T8	1,800
ASJ(L)16R(外周刃 Periphery insert)		250-140	0.5	870	104-T6	1,800
ASJ(L)20R-ASJ(L)21R		251-141	1.1	870	104-T8	1,800
ASJ(L)25R-ASJ(L/E)26R		265-141	2.0	870	104-T10	1,920
ASJ(L)32R-ASJ(L/E)40R		412-141	2.9	540	104-T15	2,060
ASJ(L)50R(外周刃 Periphery insert)						
ASJ(L)50R(底刃 End insert)	263-141	4.9	870	102-T20	2,270	

【注意】 ①部品類が損傷した場合、新しいものと交換してください。損傷した部品はインサート固定不良の原因となりますのでご注意ください。
 ②クランプねじには時々、締付防止剤(モリコート等)を全面に塗布してください。ねじの取付・取外しがスムーズになります。
 ③部品類(クランプねじ、ドライバー)は上記指定以外はご使用にならないでください。インサート固定不良や、クランプねじ締付トルク不良となる場合がありますのでご注意ください。

【Note】 ① Exchange new part-preventing from clamping problem when a part is damaged.
 ② Apply the paste sufficiently on screws for easy screwing.
 ③ Use part specified in the table, preventing from problem.

標準切削条件表 Recommended cutting conditions

ASJ

レギュラー形
Regular

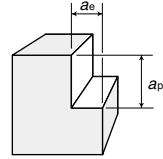

<肩削り> Side milling

被削材 Work material	推奨材種 Recommended grade	切削速度 m/min Cutting speed	使用機械 Spindle of machine	一刃当りの送り mm/t Feed rate	φ 16			φ 20			φ 25		
					回転数 min ⁻¹	送り速度 mm/min	切く排量 cm ³ /min	回転数 min ⁻¹	送り速度 mm/min	切く排量 cm ³ /min	回転数 min ⁻¹	送り速度 mm/min	切く排量 cm ³ /min
一般構造用鋼 Mild steels (200HB 以下)	CY250	150 ~ 220	BT40	0.1 ~ 0.25	4,380	1,000	14.4	3,500	1,050	18.9	2,800	840	18.9
					vc=220m/min fz=0.15mm/t ap=3mm ae=0.3DC								
					3,980	900	21.6	3,180	1,270	38.1	2,550	1,020	38.3
					vc=200m/min fz=0.2mm/t ap=3mm ae=0.5DC								
炭素鋼・合金鋼 Carbon steels Alloy steels (30HRC 以下)	CY250	120 ~ 200	BT40	0.1 ~ 0.2	3,980	900	13	3,180	955	17.2	2,550	765	17.2
					vc=200m/min fz=0.15mm/t ap=3mm ae=0.3DC								
					3,580	800	19.2	2,865	1,145	34.4	2,290	920	34.5
					vc=180m/min fz=0.2mm/t ap=3mm ae=0.5DC								
炭素鋼・合金鋼 Carbon steels Alloy steels (30~40HRC)	CY250	60 ~ 120	BT40	0.08 ~ 0.2	2,390	380	5.5	1,910	380	6.8	1,530	310	6.9
					vc=120m/min fz=0.1mm/t ap=3mm ae=0.3DC								
					1,990	320	7.7	1,590	480	14.4	1,270	380	14.2
					vc=100m/min fz=0.15mm/t ap=3mm ae=0.5DC								
炭素鋼・合金鋼 Carbon steels Alloy steels (40~45HRC)	CY250	50 ~ 100	BT40	0.05 ~ 0.2	1,690	270	2.6	1,350	270	3.2	1,080	220	3.3
					vc=85m/min fz=0.1mm/t ap=2mm ae=0.3DC								
					1,390	220	3.5	1,110	335	6.7	890	270	6.8
					vc=70m/min fz=0.15mm/t ap=2mm ae=0.5DC								
ステンレス鋼 Stainless steels SUS	CY250	120 ~ 220	BT40	0.08 ~ 0.25	4,380	1,000	14.4	3,500	1,050	18.9	2,800	840	18.9
					vc=220m/min fz=0.15mm/t ap=3mm ae=0.3DC								
					3,980	900	21.6	3,180	1,270	38.1	2,550	1,020	38.3
					vc=200m/min fz=0.2mm/t ap=3mm ae=0.5DC								
鋳鉄 Cast irons FC, FCD	CY100H	120 ~ 180	BT40	0.08 ~ 0.25	3,580	720	10.4	2,865	860	15.5	2,290	690	15.5
					vc=180m/min fz=0.15mm/t ap=3mm ae=0.3DC								
					3,180	640	15.4	2,550	1,020	30.6	2,040	820	30.7
					vc=160m/min fz=0.2mm/t ap=3mm ae=0.5DC								

被削材 Work material	推奨材種 Recommended grade	切削速度 m/min Cutting speed	使用機械 Spindle of machine	一刃当りの送り mm/t Feed rate	φ 32			φ 35			φ 40			φ 50					
					回転数 min ⁻¹	送り速度 mm/min	切く排量 cm ³ /min	回転数 min ⁻¹	送り速度 mm/min	切く排量 cm ³ /min	回転数 min ⁻¹	送り速度 mm/min	切く排量 cm ³ /min	回転数 min ⁻¹	送り速度 mm/min	切く排量 cm ³ /min			
一般構造用鋼 Mild steels (200HB 以下)	CY250	150 ~ 220	BT40	0.1 ~ 0.25	2,190	660	19	2,000	600	18.9	1,750	525	18.9	1,400	420	18.9			
					vc=220m/min fz=0.15mm/t ap=3mm ae=0.3DC														
					1,990	800	38.4	1,820	730	38.3	1,590	640	38.4	1,270	510	38.3			
					vc=200m/min fz=0.2mm/t ap=3mm ae=0.5DC														
炭素鋼・合金鋼 Carbon steels Alloy steels (30HRC 以下)	CY250	120 ~ 200	BT40	0.1 ~ 0.2	1,990	600	17.3	1,820	550	17.3	1,590	480	17.3	1,270	380	17.1			
					vc=200m/min fz=0.15mm/t ap=3mm ae=0.3DC														
					1,790	720	34.6	1,640	660	34.7	1,430	570	34.2	1,145	460	34.5			
					vc=180m/min fz=0.2mm/t ap=3mm ae=0.5DC														
炭素鋼・合金鋼 Carbon steels Alloy steels (30~40HRC)	CY250	60 ~ 120	BT40	0.08 ~ 0.2	1,190	240	6.9	1,090	220	6.9	950	190	6.8	765	155	6.9			
					vc=120m/min fz=0.1mm/t ap=3mm ae=0.3DC														
					995	300	14.4	910	275	14.4	800	240	14.4	635	190	14.3			
					vc=100m/min fz=0.15mm/t ap=3mm ae=0.5DC														
炭素鋼・合金鋼 Carbon steels Alloy steels (40~45HRC)	CY250	50 ~ 100	BT40	0.05 ~ 0.2	850	170	3.3	770	155	3.3	680	140	3.3	540	110	3.3			
					vc=85m/min fz=0.1mm/t ap=2mm ae=0.3DC														
					700	210	6.7	640	190	6.7	560	170	6.8	445	135	6.8			
					vc=70m/min fz=0.15mm/t ap=2mm ae=0.5DC														
ステンレス鋼 Stainless steels SUS	CY250	120 ~ 220	BT40	0.08 ~ 0.25	2,190	660	19	2,000	600	18.9	1,750	525	18.9	1,400	420	18.9			
					vc=220m/min fz=0.15mm/t ap=3mm ae=0.3DC														
					1,990	800	38.4	1,820	730	38.3	1,590	640	38.4	1,270	510	38.3			
					vc=200m/min fz=0.2mm/t ap=3mm ae=0.5DC														
鋳鉄 Cast irons FC, FCD	CY100H	120 ~ 180	BT40	0.08 ~ 0.25	1,790	540	15.5	1,640	490	15.5	1,430	430	15.5	1,145	345	15.5			
					vc=180m/min fz=0.15mm/t ap=3mm ae=0.3DC														
					1,590	640	30.7	1,455	585	30.7	1,275	510	30.6	1,020	410	30.8			
					vc=160m/min fz=0.2mm/t ap=3mm ae=0.5DC														

- [注意]** ①この標準切削条件表は切削条件の目安を示すものです。実際の加工では加工形状、目的、使用機械等により条件を調整してください。
 ②本表の切削条件は切削時間30分で逃げ面摩耗が0.3mmになる条件を示しています。また、工具突出し量は標準形の首下長さ(カタログのLH)です。
 ③下記に単位時間当たりの切りくず排量 Q を示します。
 $Q(\text{cm}^3/\text{min}) = a_p(\text{mm}) \times a_e(\text{mm}) \times v_f(\text{mm}/\text{min})/1000$
 ④湿式切削をする場合のインサート材種はGF30を推奨いたします。切削速度は下限側に設定してください。
 ⑤溝切削の場合は、送り速度は70%を目安としてください。また、最大切込み量は DC/2 以下を推奨します。
 ⑥ロング・エキストラロング品は前ページの切削領域図を参照ください。

- [Note]** ① These recommended cutting conditions indicate only the rule of a thumb for the cutting conditions. In actual machining, the condition should be adjusted according to the machining shape, purpose and the machine type.
 ② The cutting conditions shown in this table are conditions which will result in escape-surface wear of 0.3mm for 30 minutes of cutting time. In addition, the projecting length of the tool is the standard below-neck length (LH in catalog).
 ③ The following formula shows the chip removal volume (Q) per unit time.
 $Q(\text{cm}^3/\text{min}) = a_p(\text{mm}) \times a_e(\text{mm}) \times v_f(\text{mm}/\text{min})/1000$
 ④ When performing wet cutting, GF30 is recommended as the insert material. Please set the cutting speed at the lower limit.
 ⑤ For groove cutting, the feed rate should be set to 70% as a rule. In addition, it is recommended that the maximum cutting depth be DC/2 or less.
 ⑥ Refer to the cutting region on the previous page for long-shank and extra-long products.

ASJ レギュラー形 Regular	ASJL 注⑤ ロングシャンク Long Shank	ASJE 注⑤ エキストラロング Extra Long
---------------------------------	---	--

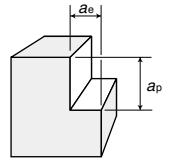

<側面切削> Side milling

被削材 Work material	推奨材種 Recommended grade	切削速度 m/min Cutting speed	使用機械 Spindle of machine	一刃当りの送り mm/t Feed rate	φ 16			φ 20			φ 25		
					回転数 min ⁻¹	送り速度 mm/min	切くず排出量 cm ³ /min	回転数 min ⁻¹	送り速度 mm/min	切くず排出量 cm ³ /min	回転数 min ⁻¹	送り速度 mm/min	切くず排出量 cm ³ /min
一般構造用鋼 Mild steels (200HB 以下)	CY250	150 ~ 220	BT40	0.05 ~ 0.25	4,380	700	25.1	3,500	560	31.4	2,800	450	39.4
					vc=220m/min fz=0.08mm/t ap=DC ae=0.14DC								
炭素鋼・合金鋼 Carbon steels Alloy steels (30HRC 以下)	CY250	120 ~ 200	BT40	0.05 ~ 0.2	3,980	800	41	3,180	640	51.2	2,550	510	63.8
					vc=200m/min fz=0.1mm/t ap=DC ae=0.2DC								
炭素鋼・合金鋼 Carbon steels Alloy steels (30~40HRC)	CY250	60 ~ 120	BT40	0.05 ~ 0.2	2,390	380	9.7	1,910	305	12.2	1,530	245	15.3
					vc=120m/min fz=0.08mm/t ap=DC ae=0.1DC								
炭素鋼・合金鋼 Carbon steels Alloy steels (40~45HRC)	CY250	50 ~ 100	BT40	0.05 ~ 0.2	1,690	270	5.5	1,350	220	7	1,080	175	8.8
					vc=85m/min fz=0.08mm/t ap=DC ae=0.08DC								
ステンレス鋼 Stainless steels SUS	CY250	120 ~ 220	BT40	0.14 ~ 0.3	4,380	700	25.1	3,500	560	31.4	2,800	450	39.4
					vc=220m/min fz=0.08mm/t ap=DC ae=0.14DC								
ステンレス鋼 SUS	CY250	120 ~ 220	BT50	0.1 ~ 0.25	3,980	800	41	3,180	640	51.2	2,550	510	63.8
					vc=200m/min fz=0.1mm/t ap=DC ae=0.2DC								
鋳鉄 Cast irons FC, FCD	CY100H	120 ~ 180	BT40	0.05 ~ 0.25	3,580	570	20.4	2,865	460	25.8	2,290	365	31.9
					vc=180m/min fz=0.08mm/t ap=DC ae=0.14DC								
鋳鉄 FC, FCD	CY100H	120 ~ 180	BT50	0.05 ~ 0.25	3,180	640	32.8	2,550	510	40.8	2,040	410	51.3
					vc=160m/min fz=0.1mm/t ap=DC ae=0.2DC								

被削材 Work material	推奨材種 Recommended grade	切削速度 m/min Cutting speed	使用機械 Spindle of machine	一刃当りの送り mm/t Feed rate	φ 32			φ 35			φ 40			φ 50		
					回転数 min ⁻¹	送り速度 mm/min	切くず排出量 cm ³ /min	回転数 min ⁻¹	送り速度 mm/min	切くず排出量 cm ³ /min	回転数 min ⁻¹	送り速度 mm/min	切くず排出量 cm ³ /min	回転数 min ⁻¹	送り速度 mm/min	切くず排出量 cm ³ /min
一般構造用鋼 Mild steels (200HB 以下)	CY250	150 ~ 220	BT40	0.05 ~ 0.25	2,190	440	45.1	2,000	400	49	1,750	520	49.9	1,400	420	63
					vc=220m/min fz=0.1mm/t ap=DC ae=0.1DC									vc=220m/min fz=0.15mm/t ap=DC ae=0.06DC		
炭素鋼・合金鋼 Carbon steels Alloy steels (30HRC 以下)	CY250	120 ~ 200	BT40	0.05 ~ 0.2	1,990	600	92.2	1,820	550	101	1,590	640	102.4	1,270	510	127.5
					vc=200m/min fz=0.15mm/t ap=DC ae=0.15DC									vc=200m/min fz=0.2mm/t ap=DC ae=0.1DC		
炭素鋼・合金鋼 Carbon steels Alloy steels (30~40HRC)	CY250	60 ~ 120	BT40	0.05 ~ 0.2	1,990	400	41	1,820	365	44.7	1,590	480	46.1	1,270	380	57
					vc=200m/min fz=0.1mm/t ap=DC ae=0.1DC									vc=200m/min fz=0.15mm/t ap=DC ae=0.06DC		
炭素鋼・合金鋼 Carbon steels Alloy steels (40~45HRC)	CY250	50 ~ 100	BT40	0.05 ~ 0.2	1,790	540	82.9	1,640	490	90	1,430	570	91.2	1,145	460	115
					vc=180m/min fz=0.15mm/t ap=DC ae=0.15DC									vc=180m/min fz=0.2mm/t ap=DC ae=0.1DC		
ステンレス鋼 Stainless steels SUS	CY250	120 ~ 220	BT40	0.14 ~ 0.3	1,190	240	19.7	1,090	220	21.6	950	285	22.8	765	230	28.8
					vc=120m/min fz=0.1mm/t ap=DC ae=0.08DC									vc=120m/min fz=0.15mm/t ap=DC ae=0.05DC		
ステンレス鋼 SUS	CY250	120 ~ 220	BT50	0.1 ~ 0.25	995	300	39.9	910	270	43	800	320	51.2	635	255	63.8
					vc=100m/min fz=0.15mm/t ap=DC ae=0.13DC									vc=100m/min fz=0.2mm/t ap=DC ae=0.1DC		
鋳鉄 Cast irons FC, FCD	CY100H	120 ~ 180	BT40	0.05 ~ 0.25	850	170	13.9	770	155	15.2	680	200	16	540	160	20
					vc=85m/min fz=0.1mm/t ap=DC ae=0.08DC									vc=85m/min fz=0.15mm/t ap=DC ae=0.05DC		
鋳鉄 FC, FCD	CY100H	120 ~ 180	BT50	0.05 ~ 0.25	700	210	27.9	640	190	30.3	560	225	36	445	180	45
					vc=70m/min fz=0.15mm/t ap=DC ae=0.13DC									vc=70m/min fz=0.2mm/t ap=DC ae=0.1DC		
鋳鉄 FC, FCD	CY100H	120 ~ 180	BT40	0.05 ~ 0.25	2,190	440	45.1	2,000	400	49	1,750	520	49.9	1,400	420	63
					vc=220m/min fz=0.1mm/t ap=DC ae=0.1DC									vc=220m/min fz=0.15mm/t ap=DC ae=0.06DC		
鋳鉄 FC, FCD	CY100H	120 ~ 180	BT50	0.05 ~ 0.25	1,990	600	92.2	1,820	550	101	1,590	640	102.4	1,270	510	127.5
					vc=200m/min fz=0.15mm/t ap=DC ae=0.15DC									vc=200m/min fz=0.2mm/t ap=DC ae=0.1DC		
鋳鉄 FC, FCD	CY100H	120 ~ 180	BT40	0.05 ~ 0.25	1,790	360	36.9	1,640	330	40.4	1,430	430	41.3	1,145	345	51.8
					vc=180m/min fz=0.1mm/t ap=DC ae=0.1DC									vc=180m/min fz=0.15mm/t ap=DC ae=0.06DC		
鋳鉄 FC, FCD	CY100H	120 ~ 180	BT50	0.05 ~ 0.25	1,590	480	73.7	1,455	440	80.9	1,275	510	81.6	1,020	410	102.5
					vc=160m/min fz=0.15mm/t ap=DC ae=0.15DC									vc=160m/min fz=0.2mm/t ap=DC ae=0.1DC		

- [注意]** ①この標準切削条件表は切削条件の目安を示すものです。実際の加工では加工形状、目的、使用機械等により条件を調整してください。
 ②本表の切削条件は切削時間30分で逃げ面摩耗が0.3mmになる条件を示しています。また、工具突出し量は標準形の首下長さ(カタログのLH)です。
 ③下記に単位時間当たりの切りくず排出量 Q を示します。
 $Q(\text{cm}^3/\text{min}) = a_p(\text{mm}) \times a_e(\text{mm}) \times v_f(\text{mm}/\text{min})/1000$
 ④湿式切削をする場合のインサート材種はGF30を推奨いたします。切削速度は下側限に設定してください。
 ⑤溝切削の場合は、送り速度は70%を目安としてください。また、最大切込量は DC/2 以下を推奨します。
 ⑥ロングシャンク品またはL/Dが5倍以上は、上記条件の約 50%を目安としてください。

- [Note]** ① These recommended cutting conditions indicate only the rule of a thumb for the cutting conditions. In actual machining, the condition should be adjusted according to the machining shape, purpose and the machine type.
 ② The cutting conditions shown in this table are conditions which will result in escape-surface wear of 0.3mm for 30 minutes of cutting time. In addition, the projecting length of the tool is the standard below-neck length (LH in catalog).
 ③ The following formula shows the chip removal volume (Q) per unit time.
 $Q(\text{cm}^3/\text{min}) = a_p(\text{mm}) \times a_e(\text{mm}) \times v_f(\text{mm}/\text{min})/1000$
 ④ When performing wet cutting, GF30 is recommended as the insert material. Please set the cutting speed at the lower limit.
 ⑤ For groove cutting, the feed rate should be set to 70% as a rule. In addition, it is recommended that the maximum cutting depth be DC/2 or less.
 ⑥ For long shank or when L/D is greater than 5 times, as a rule conditions should be approximately 50% of those shown above.

アルファスーパーじゅうおう ASJ

ASJ レギュラー形 Regular	ASJL ロングシャンク Long Shank	ASJE エキストラロング Extra Long
---------------------------------	--------------------------------------	---------------------------------------

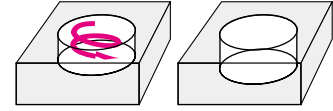

<ドリル加工> Drilling 必ずステップ送りをしてください。Please use only step-feed.

被削材 Work material	推奨材種 Recommended grade	切削速度 m/min Cutting speed	一刃当りの送り mm/t Feed rate	φ 16		φ 20		φ 25		φ 32	
				回転数 min ⁻¹	送り速度 mm/min	回転数 min ⁻¹	送り速度 mm/min	回転数 min ⁻¹	送り速度 mm/min	回転数 min ⁻¹	送り速度 mm/min
一般構造用鋼 Mild steels (200HB 以下)	CY250	150 ~ 220	0.03 ~ 0.08	4,380	440	3,500	350	2,800	280	2,190	220
$v_c=220\text{m/min}$ $f_z=0.05\text{mm/t}$ ステップ量 step feed=0.3mm											
炭素鋼・合金鋼 Carbon steels Alloy steels (30HRC 以下)	CY250	120 ~ 220	0.03 ~ 0.08	3,980	400	3,180	320	2,550	250	1,990	200
$v_c=200\text{m/min}$ $f_z=0.05\text{mm/t}$ ステップ量 step feed=0.5mm											
ステンレス鋼 Stainless steels SUS	CY250	120 ~ 220	0.03 ~ 0.06	3,980	400	3,180	320	2,550	250	1,990	200
$v_c=200\text{m/min}$ $f_z=0.05\text{mm/t}$ ステップ量 step feed=0.3mm											
鋳鉄 Cast irons FC, FCD	CY100H	120 ~ 180	0.03 ~ 0.1	3,180	510	2,550	410	2,040	330	1,590	250
$v_c=160\text{m/min}$ $f_z=0.08\text{mm/t}$ ステップ量 step feed=1mm											

被削材 Work material	推奨材種 Recommended grade	切削速度 m/min Cutting speed	一刃当りの送り mm/t Feed rate	φ 35		φ 40		φ 50	
				回転数 min ⁻¹	送り速度 mm/min	回転数 min ⁻¹	送り速度 mm/min	回転数 min ⁻¹	送り速度 mm/min
一般構造用鋼 Mild steels (200HB 以下)	CY250	150 ~ 220	0.03 ~ 0.08	2,000	200	1,750	180	1,400	140
$v_c=220\text{m/min}$ $f_z=0.05\text{mm/t}$ ステップ量 step feed=0.3mm									
炭素鋼・合金鋼 Carbon steels Alloy steels (30HRC 以下)	CY250	120 ~ 220	0.03 ~ 0.08	1,820	180	1,590	160	1,270	130
$v_c=200\text{m/min}$ $f_z=0.05\text{mm/t}$ ステップ量 step feed=0.5mm									
ステンレス鋼 Stainless steels SUS	CY250	120 ~ 220	0.03 ~ 0.06	1,820	180	1,590	160	1,270	130
$v_c=200\text{m/min}$ $f_z=0.05\text{mm/t}$ ステップ量 step feed=0.3mm									
鋳鉄 Cast irons FC, FCD	CY100H	120 ~ 180	0.03 ~ 0.1	1,460	230	1,270	200	1,020	160
$v_c=160\text{m/min}$ $f_z=0.08\text{mm/t}$ ステップ量 step feed=1mm									

- 【注意】**
- ① この切削条件表は切削条件の目安を示すものです。実際の加工では加工形状、目的、使用機械等により条件を調整してください。
 - ② 40HRC 以上の穴加工は、ヘリカル加工を適用してください。
 - ③ 湿式切削をする場合のインサート材種はGF30を推奨いたします。切削速度は下限側に設定してください。
 - ④ ASJL21R, 26R, ASJE26R は穴中心部にφ1程度の柱が残ります。

- 【Note】**
- ① These conditions are for general guidance; in actual machining conditions adjust the parameters according to your actual machine and work-piece conditions.
 - ② Hole cutting at 40HRC or higher should be performed using helical cutting.
 - ③ When performing wet cutting, GF30 is recommended as the insert material. Please set the cutting speed at the lower limit.
 - ④ For ASJL21R, 26R, and ASJE26R, a column with a diameter of about Ø1 will be left in the center of the hole

■ 傾斜加工について About slant milling

鋼切削時の傾斜角度は **3°以下を推奨します。**

傾斜角度が 3°あたりから切りくずが分断されず、つながるため機械にカバー（スプラッシュガード等）がない場合危険です。必ずカバーを使用してください。

ポケット加工等で傾斜切込みを行う場合の送り速度は肩削りF値の70%に設定してください。

Slant angles of 3° or less are recommended when cutting steel.

At slant angles from around 3°, the chips will not break and will remain connected, which is dangerous for machines without covers (splash guards, etc.). Be sure to use covers.

When performing slant milling for pocket cutting, etc., the feed rate should be set to 70% of the shoulder milling F value.

■ ヘリカル加工のプログラム作成方法 How to program for Helical cutting.

※ヘリカル加工での最小加工径は 1.2DC、最大加工径は 1.8DC です。

The minimum cutting diameter for helical cutting is 1.2DC and the maximum cutting diameter is 1.8DC

ヘリカル加工のプログラム例（ファナックの場合）を以下に示します。

A helical cutting program example (for a Fanuc machine) is shown below.

【例 ASJ25R (φ 25) でφ 35 mm、深さ 12 mmの穴あけ（一周当たり 1.5 mm）】

Cutting a (35mm, 12mm-deep hole using ASJ25R (φ 25)). (1.5mm per cycle)

【メインプログラム】 Main Program	【サブプログラム】 Sub Program
...	O1001
...	G91
M98 P1001L8	G03 X-10. R5. Z-0.75 F760
G03 X-10. R5. F760	X10. R5. Z-0.75
X10. R5.	M99
...	
...	

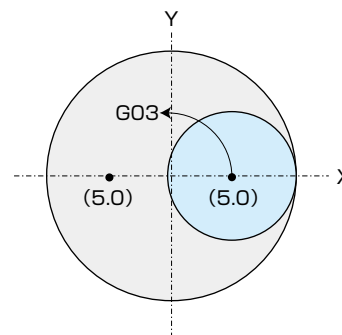

【一周当たりの切込み量の設定方法】 How to set the per-cycle cutting amount

θ が 3°以下になるように切込み量を設定します。The cutting amount will be set for θ of 3° or less.

右図でのDは工具中心軌跡の直径を示します。D in the figure at right is the diameter of the tool center path.

$$\begin{aligned} \text{一周当たりの切込み量} & H = \pi \times D \times \tan \theta \\ \text{Per-cycle cutting amount} & = 3.14 \times 10 \times \tan 3^\circ \\ & = 1.6 \text{ mm} \end{aligned}$$

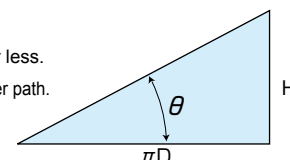

本例の場合加工深さが 12 mmなので一周当たりの切込み量は 1.5 mmとしました。 In this example, since the cutting depth is 12mm, the per-cycle cutting amount is 1.5mm.

【切削条件】 Cutting condition

肩削りの条件を参照してください。Refer to the shoulder cutting conditions.

※注意

- ①多くの場合、ヘリカル加工はNC制御装置のオプションとなっています。
 - ②切りくずが滞留しやすいため加工時はエアブローの使用を推奨します。
 - ③ 40HRC 以上の被削材の傾斜角度は 1.5°以下に設定してください。
 - ④ L/D=4 以上の長突出しにてヘリカル加工を行う場合、一周当たりの切込み量は 1mm以下に設定してください。
- ① In many cases, helical cutting is an option for the NC control equipment.
 - ② Since chips are likely to remain, use of an air blower is recommended during cutting.
 - ③ For cutting materials of 40HRC or higher, the slant angle should be set to 1.5° or less.
 - ④ When performing helical cutting with long projections of L/D= 4 or more, the per-cycle cutting amount should be set to 1mm or less.

Super Vertical Mill ASV

アルファスーパーバーチカルミル ASV

- 高能率バーチカル加工（軸方向切削）の他に、横送り機能・微い加工機能・立壁仕上機能をもつ多機能工具です。
- 工具突出しが長く、加工能率の低下する深堀り加工に威力を発揮します。
- 荒加工～立壁の仕上げ加工まで高能率・高精度加工が軽快にできます。

Super Vertical Mill is a multi-function tooling like horizontal direction milling, contouring, finishing of vertical wall, in a addition of conventional vertical milling.
 Effective for deep die-sinking like low efficient machining with long reach condition.
 Precision inserts with breakers make high efficient and precision machining from roughing to finishing at vertical.



ASV(L/E)R シャンクタイプ Shank type

○は数字が入ります。 Numeric figure in a circle ○

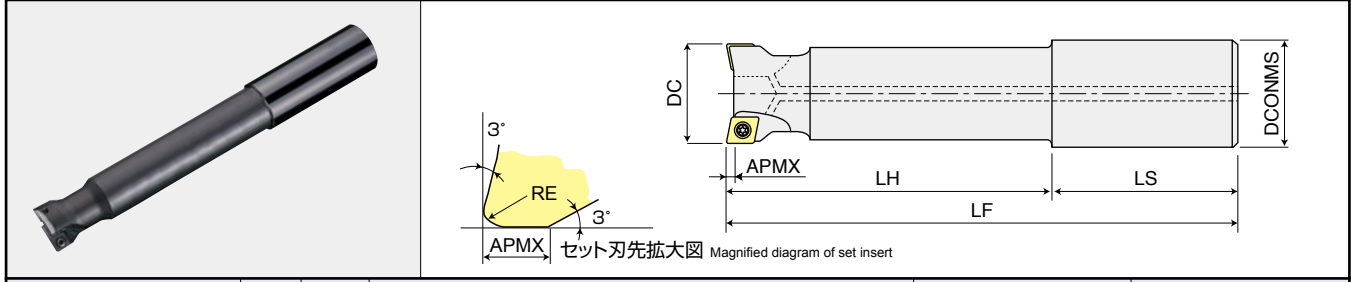

商品コード Item code	在庫 Stock	刃数 No. of flutes	寸法 Size (mm)							適用インサート Inserts	希望小売価格(円) Suggested retail price(¥)
			DC	LF	DCONMS	APMX	LH	LS			
レギュラー Regular type	ASV25R	●	2	25	200	25	1.5	120	80	MP09T308ZEL	26,870
	ASV30R	●	2	30	250	32	1.5	150	100	MP110408ZEL	31,450
	ASV32R	●	2	32	250	32	1.5	150	100		31,450
	ASV40R	●	2	40	270	42	3	150	120	MP1205ZL	35,910
ロング Long	ASVL25R	●	2	25	250	25	1.5	170	80	MP09T308ZEL	29,460
	ASVL30R	●	2	30	300	32	1.5	200	100	MP110408ZEL	34,380
	ASVL32R	●	2	32	320	32	1.5	200	120		35,320
	ASVL40R	●	2	40	320	42	3	200	120	MP1205ZL	39,770
エクストラロング Extra long	ASVE32R	●	2	32	400	32	1.5	250	150	MP110408ZEL	40,010
	ASVE40R	●	2	40	400	42	3	250	150	MP1205ZL	45,640

○は数字が入ります。 Numeric figure in a circle ○

ASV R ボアタイプ Bore type

ボアタイプ用アーバはD11頁を参照ください。
Refer page D11 about the bore type arbor

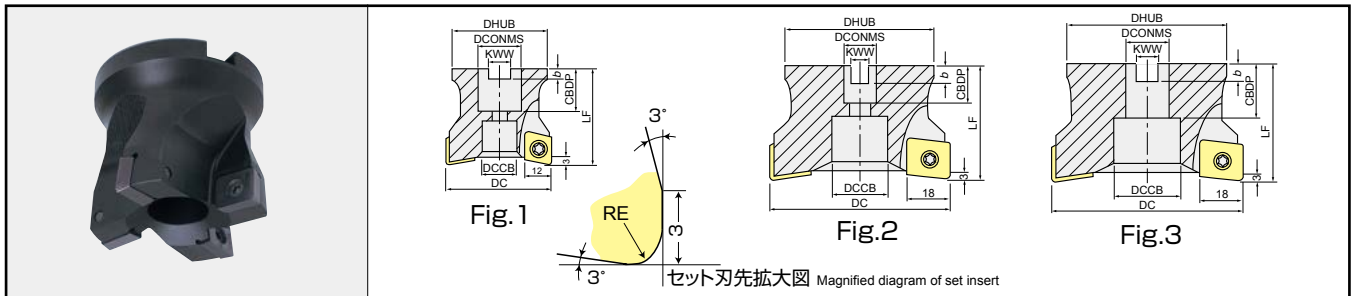

商品コード Item code	在庫 Stock	刃数 No. of flutes	寸法 Size (mm)								適用インサート Inserts	形状 Shape	希望小売価格(円) Suggested retail price(¥)	
			DC	LF	DCONMS	CBDB	DCCB	KWW	b	DHUB				
ボアタイプ Bore type	ASV4050R	●	3	50	50	22.225	19	17	8.4	5	48	MP1205ZL	Fig-1	58,540
	ASV4063R	●	3	63	50	22.225	19	17	8.4	5	60			65,580
	ASV6080R	●	4	80	70	31.75	32	26	12.7	8	76		81,770	
	ASV6100R	●	5	100	70	31.75	32	26	12.7	8	96	AP190616ZL	Fig-2	104,060
	ASV6125R	●	6	125	70	38.1	38	55	15.9	10	102			Fig-3

【注意】 アーバ用ねじは付属しません。 【Note】 Arbor screw is not included.

●印：標準在庫品です。 ●：Stocked items. 無印：弊社営業へお問合せください。 No mark：Contact with our sales department.

■ インサート Inserts

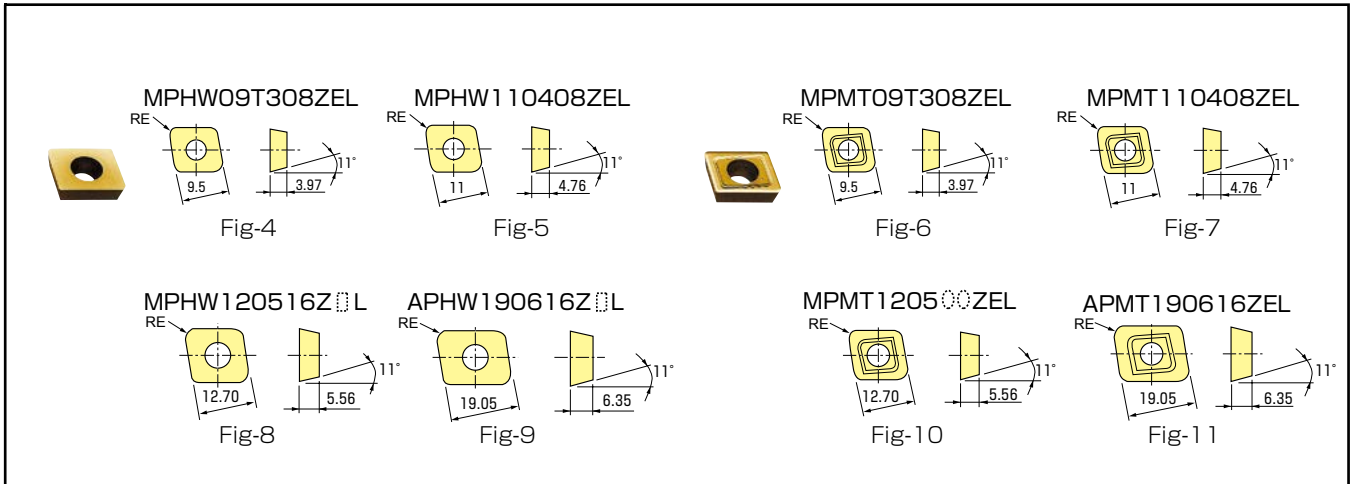

商品コード Item code	精度 Tolerance class	JSコーティング JS Coating		Cコーティング C Coating		GFコーティング GF Coating	超硬 Carbide K	寸法 Size(mm)	形状 Shape	希望小売価格(円) Suggested retail price (¥)
		JS4045		CY100H	CY250V	GF30	WH10			
MPHW09T308ZEL	H級 H	●			●			0.8	Fig-4	1,590
MPHW110408ZEL		●			●			0.8	Fig-5	1,750
MPHW120516ZEL		●		●	●	●		1.6	Fig-8	2,130
MPHW120516ZFL							●	1.6		1,630
APHW190616ZEL		●		●	●			1.6	Fig-9	4,000
APHW190616ZFL							●	1.6		3,100
MPMT09T308ZEL	M級 M	●		●	●			0.8	Fig-6	1,090
MPMT110408ZEL		●		●	●	●		0.8	Fig-7	1,210
MPMT120508ZEL		●		●	●	●		0.8	Fig-10	1,470
MPMT120516ZEL		●		●	●	●		1.6		1,470
APMT190616ZEL		●		●	●	●		1.6		Fig-11

[注意] JSコーティングは通電式タッチセンサーに反応しませんのでご注意ください。
[Note] Please note that the JS Coating does not cause a reaction in conductive touch sensors.

■ 部品番号 Parts

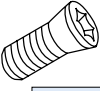
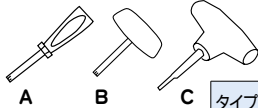
部品名 Parts		クランプねじ Clamp screw		ドライバ/レンチ Screw driver / Wrench			
適用カッタ Cutter body	形状 Shape						
		締付トルク Fastening torque (N·m)	希望小売価格(円) Suggested retail price(¥)	A	B	C	タイプ Type
ASV(L)25R		265-141	2.0	870	104-T10	A	1,920
ASV(L)30R~ASV(L/E)32R		262-142	2.9	870	104-T15	A	2,060
ASV(L/E)40R		263-143	4.9	870	105-T20	B	2,120
ASV4050R		263-141	4.9	870	101-T20	C	1,440
ASV4063R							
ASV6080R		541-161	9.8	870	101-T25L	C	1,440
ASV6100R							
ASV6125R							

【注意】クランプねじは消耗品です。使用環境により交換寿命は変化しますので早めの交換をお願い致します。

【Note】 The clamp screw is a consumable part. Since replacement life depends on the use environment, it is recommended that it be replaced at an early stage.

標準切削条件表 Recommended cutting conditions

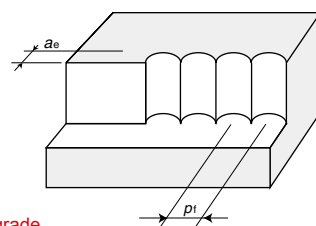

<バーチカル加工> Vertical milling ※赤字は第一推奨材種です。Red indicates primary recommended grade.

被削材 Work material	推奨材種 Recommended grade	切削速度 m/min Cutting speed	一刃当りの送り mm/t Feed rate	φ 25			φ 30			φ 32			φ 40		
				回転数 min ⁻¹	送り速度 mm/min	切りくず排出量 cm ³ /min	回転数 min ⁻¹	送り速度 mm/min	切りくず排出量 cm ³ /min	回転数 min ⁻¹	送り速度 mm/min	切りくず排出量 cm ³ /min	回転数 min ⁻¹	送り速度 mm/min	切りくず排出量 cm ³ /min
炭素鋼・合金鋼 Carbon steels Alloy steels (250HB 以下)	※ JS4045 CY250V GF30	100~200	0.1~ 0.25	2,290	460	35	1,910	460	48	1,790	470	53	1,430	510	82
				vc=180m/min pf=0.5DC ae=6mm			vc=180m/min pf=0.5DC ae=7mm			vc=180m/min pf=0.5DC ae=8mm					
プリハードン鋼 Pre-hardened steels (40~45HRC)	JS4045 CY250V GF30	80~150	0.05~ 0.2	1,270	150	11	1,060	150	16	990	150	17	790	160	26
				vc=100m/min pf=0.5DC ae=6mm			vc=100m/min pf=0.5DC ae=7mm			vc=100m/min pf=0.5DC ae=8mm					
ステンレス鋼 Stainless steels SUS	JS4045 CY250V GF30	100~200	0.1~ 0.25	2,290	460	35	1,910	460	48	1,790	470	53	1,430	510	82
				vc=180m/min pf=0.5DC ae=6mm			vc=180m/min pf=0.5DC ae=7mm			vc=180m/min pf=0.5DC ae=8mm					
鋳鉄 Cast irons FC, FCD	CY100H	100~200	0.1~ 0.25	2,290	550	41	1,910	570	60	1,790	580	65	1,430	570	91
				vc=180m/min pf=0.5DC ae=6mm			vc=180m/min pf=0.5DC ae=7mm			vc=180m/min pf=0.5DC ae=8mm					
アルミニウム合金 Aluminium alloys	WH10	400~1,000	0.05~ 0.2	10,200	1,220	92	8,500	1,190	125	7,960	1,270	142	6,370	1,530	245
				vc=800m/min pf=0.5DC ae=6mm			vc=800m/min pf=0.5DC ae=7mm			vc=800m/min pf=0.5DC ae=8mm					

被削材 Work material	推奨材種 Recommended grade	切削速度 m/min Cutting speed	一刃当りの送り mm/t Feed rate	φ 50			φ 63			φ 80			φ 100			φ 125		
				回転数 min ⁻¹	送り速度 mm/min	切りくず排出量 cm ³ /min	回転数 min ⁻¹	送り速度 mm/min	切りくず排出量 cm ³ /min	回転数 min ⁻¹	送り速度 mm/min	切りくず排出量 cm ³ /min	回転数 min ⁻¹	送り速度 mm/min	切りくず排出量 cm ³ /min	回転数 min ⁻¹	送り速度 mm/min	切りくず排出量 cm ³ /min
炭素鋼・合金鋼 Carbon steels Alloy steels (250HB 以下)	※ JS4045 CY250V GF30	100~200	0.15~ 0.3	1,150	690	138	910	550	151	720	720	432	570	710	532	460	690	646
				vc=180m/min pf=0.5DC ae=8mm			vc=180m/min pf=0.5DC ae=15mm											
プリハードン鋼 Pre-hardened steels (40~45HRC)	JS4045 CY250V GF30	80~150	0.1~ 0.15	640	230	46	500	180	58	400	240	144	320	240	180	250	220	206
				vc=100m/min pf=0.5DC ae=8mm			vc=100m/min pf=0.5DC ae=15mm											
ステンレス鋼 Stainless steels SUS	JS4045 CY250V GF30	100~200	0.15~ 0.3	1,150	690	138	910	550	151	720	720	432	570	710	532	460	690	646
				vc=180m/min pf=0.5DC ae=8mm			vc=180m/min pf=0.5DC ae=15mm											
鋳鉄 Cast irons FC, FCD	CY100H	100~200	0.15~ 0.3	1,150	860	172	910	680	186	720	860	516	570	850	637	460	830	778
				vc=180m/min pf=0.5DC ae=8mm			vc=180m/min pf=0.5DC ae=15mm											
アルミニウム合金 Aluminium alloys	WH10	400~1,000	0.05~ 0.2	5,100	2,300	460	4,040	1,800	529	3,180	2,550	1,530	2,550	2,550	1,912	2,040	2,450	2,296
				vc=800m/min pf=0.5DC ae=8mm			vc=800m/min pf=0.5DC ae=15mm											

【注意】

- この標準切削条件表は切削条件の目安を示すものです。実際の加工では加工形状、目的、使用機械等により条件を調整してください。
- JSコーティングは通電式タッチセンサーに反応しませんのでご注意ください。
- 湿式切削を実施する場合のインサート材種はGF30を推奨いたします。
- 下記に単位時間当たりの切りくず排出量Qを示します。

$$Q (\text{cm}^3/\text{min}) = a_p (\text{mm}) \times a_e (\text{mm}) \times v_f (\text{mm}/\text{min}) / 1000$$

【Note】

- These recommended cutting conditions indicate only the rule of a thumb for the cutting conditions.
In actual machining, the condition should be adjusted according to the machining shape, purpose and the machine type.
- Please note that the JS Coating does not cause a reaction in conductive touch sensors.
- When performing wet cutting, GF30 is recommended as the insert material.
- The following formula shows the chip removal volume (Q) per unit time.

$$Q(\text{cm}^3/\text{min})=a_p(\text{mm}) \times a_e(\text{mm}) \times v_f(\text{mm}/\text{min})/1000$$

アルファスーパーバーチカルミル ASV

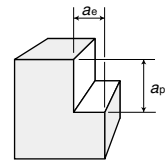

<横送り切削> Side feed milling ※赤字は第一推奨材種です。Red indicates primary recommended grade.

被削材 Work material	推奨材種 Recommended grade	切削速度 m/min Cutting speed	一刃当りの送り mm/t Feed rate	φ 25		φ 30		φ 32		φ 40	
				回転数 min ⁻¹	送り速度 mm/min	回転数 min ⁻¹	送り速度 mm/min	回転数 min ⁻¹	送り速度 mm/min	回転数 min ⁻¹	送り速度 mm/min
炭素鋼・合金鋼 Carbon steels Alloy steels (250HB以下)	※ JS4045 CY250V GF30	100 ~ 200	0.1 ~ 0.2	2,290	460	1,910	570	1,790	540	1,430	570
				vc=180m/min ap×ae=0.5×0.7DCmm fz=0.1mm/t		vc=180m/min ap×ae=0.5×0.7DCmm fz=0.15mm/t				vc=180m/min ap×ae=0.8×0.7DCmm fz=0.2mm/t	
プリハードン鋼 Pre-hardened steels (40 ~ 45HRC)	JS4045 CY250V GF30	80 ~ 150	0.05 ~ 0.15	1,270	150	1,060	150	990	150	790	160
				vc=100m/min ap×ae=0.5×0.7DCmm fz=0.05mm/t		vc=100m/min ap×ae=0.5×0.7DCmm fz=0.07mm/t fz=0.08mm/t				vc=100m/min ap×ae=0.8×0.7DCmm fz=0.1mm/t	
ステンレス鋼 Stainless steels SUS	JS4045 CY250V GF30	100 ~ 200	0.1 ~ 0.2	2,290	460	1,910	570	1,790	540	1,430	570
				vc=180m/min ap×ae=0.5×0.7DCmm fz=0.1mm/t		vc=180m/min ap×ae=0.5×0.7DCmm fz=0.15mm/t				vc=180m/min ap×ae=0.8×0.7DCmm fz=0.2mm/t	
鋳鉄 Cast irons FC, FCD	CY100H	100 ~ 200	0.1 ~ 0.2	2,290	550	1,910	570	1,790	580	1,430	570
				vc=180m/min ap×ae=0.5×0.7DCmm fz=0.12mm/t		vc=180m/min ap×ae=0.5×0.7DCmm fz=0.15mm/t fz=0.16mm/t				vc=180m/min ap×ae=0.8×0.7DCmm fz=0.2mm/t	
アルミニウム合金 Aluminium alloys	WH10	400 ~ 1,000	0.05 ~ 0.15	10,200	1,220	8,500	1,190	7,960	1,270	6,370	1,270
				vc=800m/min ap×ae=0.5×0.7DCmm fz=0.06mm/t		vc=800m/min ap×ae=0.5×0.7DCmm fz=0.07mm/t fz=0.08mm/t				vc=800m/min ap×ae=0.8×0.7DCmm fz=0.1mm/t	

被削材 Work material	推奨材種 Recommended grade	切削速度 m/min Cutting speed	一刃当りの送り mm/t Feed rate	φ 50		φ 63		φ 80		φ 100		φ 125	
				回転数 min ⁻¹	送り速度 mm/min	回転数 min ⁻¹	送り速度 mm/min	回転数 min ⁻¹	送り速度 mm/min	回転数 min ⁻¹	送り速度 mm/min	回転数 min ⁻¹	送り速度 mm/min
炭素鋼・合金鋼 Carbon steels Alloy steels (250HB以下)	※ JS4045 CY250V GF30	100 ~ 200	0.15 ~ 0.25	950	570	760	460	600	480	480	480	380	460
				vc=150m/min fz=0.2mm/t ap=1mm ae=0.7DC				vc=150m/min fz=0.2mm/t ap=1mm ae=0.7DC					
プリハードン鋼 Pre-hardened steels (40 ~ 45HRC)	JS4045 CY250V GF30	80 ~ 150	0.1 ~ 0.15	640	230	500	180	400	240	320	240	250	220
				vc=100m/min fz=0.12mm/t ap=0.8mm ae=0.7DC				vc=100m/min fz=0.15mm/t ap=0.8mm ae=0.7DC					
ステンレス鋼 Stainless steels SUS	JS4045 CY250V GF30	100 ~ 200	0.15 ~ 0.25	950	570	760	460	600	480	480	480	380	460
				vc=150m/min fz=0.2mm/t ap=1mm ae=0.7DC				vc=150m/min fz=0.2mm/t ap=1mm ae=0.7DC					
鋳鉄 Cast irons FC, FCD	CY100H	100 ~ 200	0.15 ~ 0.25	1,150	690	910	550	720	580	570	570	460	550
				vc=180m/min fz=0.2mm/t ap=1.5mm ae=0.7DC				vc=180m/min fz=0.2mm/t ap=1.5mm ae=0.7DC					
アルミニウム合金 Aluminium alloys	WH10	400 ~ 1000	0.05 ~ 0.2	5,100	1,530	4,040	1,210	3,180	1,910	2,550	1,910	2,040	1,840
				vc=800m/min fz=0.1mm/t ap=1mm ae=0.7DC				vc=800m/min fz=0.15mm/t ap=1mm ae=0.7DC					

- 【注意】**
- ① 被削材、加工形状に合わせて、適切なクーラントを使用してください。
 - ② この標準切削条件表は切削条件の目安を示すものです。実際の加工では加工形状、目的、使用機械等により条件を調整してください。
 - ③ JSコーティングは通電式タッチセンサーに反応しませんのでご注意ください。

- 【Note】**
- ① Use the appropriate coolant for the work material and machining shape.
 - ② These recommended cutting conditions indicate only the rule of a thumb for the cutting conditions. In actual machining, the condition should be adjusted according to the machining shape, purpose and the machine type.
 - ③ Please note that the JS Coating does not cause a reaction in conductive touch sensors.

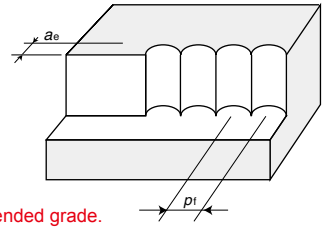

<立壁仕上げ加工> Vertical finishing

加工は往復加工を推奨します。Reciprocating cutting is recommended

※赤字は第一推奨材種です。
Red indicates primary recommended grade.

被削材 Work material	推奨材種 Recommended grade	切削速度 m/min Cutting speed	一刃当りの送り mm/t Feed rate	φ 25		φ 30		φ 32		φ 40	
				回転数 min ⁻¹	送り速度 mm/min	回転数 min ⁻¹	送り速度 mm/min	回転数 min ⁻¹	送り速度 mm/min	回転数 min ⁻¹	送り速度 mm/min
炭素鋼・合金鋼 Carbon steels Alloy steels (250HB以下)	※ JS4045 CY250V	250 ~ 400	0.1 ~ 0.25	4,460	1,340	3,710	1,480	3,480	1,390	2,790	1,230
				$pi=0.7mm$ $ae=0.1mm$		$pi=0.7mm$ $ae=0.1mm$		$pi=0.9mm$ $ae=0.1mm$			
				$vc=350m/min$ $fz=0.15mm/t$		$vc=350m/min$ $fz=0.2mm/t$		$vc=350m/min$ $fz=0.22mm/t$		$vc=350m/min$ $fz=0.22mm/t$	
鑄鉄 Cast irons FC, FCD	CY100H	300 ~ 500	0.1 ~ 0.25	5,090	1,530	4,240	1,700	3,980	1,590	3,180	1,590
				$pi=0.7mm$ $ae=0.1mm$		$pi=0.7mm$ $ae=0.1mm$		$pi=0.9mm$ $ae=0.1mm$			
				$vc=400m/min$ $fz=0.15mm/t$		$vc=400m/min$ $fz=0.2mm/t$		$vc=400m/min$ $fz=0.25mm/t$		$vc=400m/min$ $fz=0.25mm/t$	

被削材 Work material	推奨材種 Recommended grade	切削速度 m/min Cutting speed	一刃当りの送り mm/t Feed rate	φ 50		φ 63		φ 80		φ 100		φ 125	
				回転数 min ⁻¹	送り速度 mm/min	回転数 min ⁻¹	送り速度 mm/min	回転数 min ⁻¹	送り速度 mm/min	回転数 min ⁻¹	送り速度 mm/min	回転数 min ⁻¹	送り速度 mm/min
炭素鋼・合金鋼 Carbon steels Alloy steels (250HB以下)	※ JS4045 CY250V	250 ~ 400	0.15 ~ 0.25	2,330	1,470	1,770	1,170	1,390	1,220	1,110	1,220	890	1,170
				$pi=1mm$ $ae=0.1mm$		$pi=1.1mm$ $ae=0.1mm$		$pi=1.2mm$ $ae=0.1mm$		$pi=1.4mm$ $ae=0.1mm$		$pi=1.5mm$ $ae=0.1mm$	
				$vc=350m/min$ $fz=0.22mm/t$									
鑄鉄 Cast irons FC, FCD	CY100H	300 ~ 500	0.2 ~ 0.3	2,550	1,910	2,020	1,520	1,590	1,590	1,270	1,590	1,020	1,530
				$pi=1mm$ $ae=0.1mm$		$pi=1.1mm$ $ae=0.1mm$		$pi=1.2mm$ $ae=0.1mm$		$pi=1.4mm$ $ae=0.1mm$		$pi=1.5mm$ $ae=0.1mm$	
				$vc=400m/min$ $fz=0.25mm/t$									

①立壁仕上げ加工を行う前の荒加工は、下表のピック量にしてください。

Use the value below for roughing pick-feed before vertical finishing.

外径 DC	φ 25	φ 30	φ 32	φ 40	φ 50	φ 63	φ 80	φ 100	φ 125
ピック量 Pick feed	3.1 mm	3.5 mm	3.6 mm	4 mm	4.5 mm	5 mm	5.5 mm	6.3 mm	7 mm

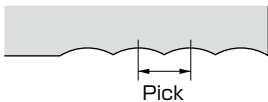

②表は突出し長さ 250mm を基本とした条件です。

ロングアーブ使用の際は、機械により固有振動数が異なりますので回転数と送りを調整してください。

The tables above are based on the over-hang length of 250mm.

When you use long arbors, adjustment of spindle revolution and feed speed may be required due to the machine's inherent frequency of vibration.

[注意] ①被削材、加工形状に合わせて、適切なクーラントを使用してください。

②この標準切削条件表は切削条件の目安を示すものです。実際の加工では加工形状、目的、使用機械等により条件を調整してください。

③JSコーティングは通電式タッチセンサーに反応しませんのでご注意ください。

[Note]

① Use the appropriate coolant for the work material and machining shape.

② These recommended cutting conditions indicate only the rule of a thumb for the cutting conditions. In actual machining, the condition should be adjusted according to the machining shape, purpose and the machine type.

③ Please note that the JS Coating does not cause a reaction in conductive touch sensors.

アルファラフィングエンドミル AME

- ニック付きインサートでびびりのない深切り込み加工が可能！
- AJ&JS インサートで長寿命。
- ・ Nicked inserts enable heavy milling without chattering.
- ・ AJ & JS coatings provide long tool life.

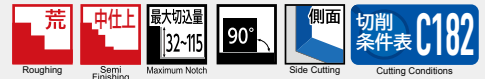

AME○○○○S○○○-○○○-○NT シャンクタイプ Shank type ○は数字が入ります。Numeric figure in a circle○.

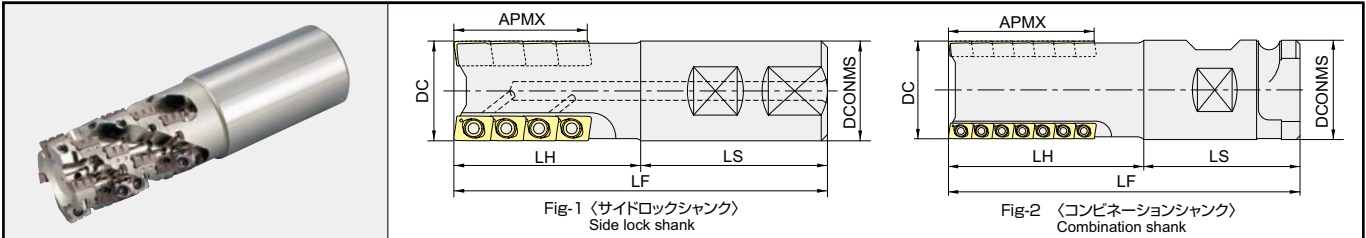

商品コード Item code	在庫 Stock	刃列 No. of flutes	インサート数 No. of inserts			寸法 Size (mm)						適用インサート Inserts	形状 Shape	希望小売 価格(円) Suggested retail price (¥)	
			波刃、 シャープエッジ の場合 For wave-edge and sharp-edged inserts	ニック付の場合 For Nicked inserts	2ニック 2 Nicks	3ニック 3 Nicks	DC	LF	DCONMS	APMX	LH				LS
サイドロック シャンク Side lock shank	AME1232S32-42-3NT※4	●	3	12	4	8	32	120	32	42	60	60	APMT120508R-FT	Fig.1	80,240
	AME1240S32-63-4NT	●	4	24	12	12	40	150	32	63	80	70	APMT120530R-FT※1※2		147,800
	AME1240S42-63-4NT	●	4	24	12	12	40	150	42	63	80	70	APMT120508R-N2※3		146,630
	AME1250S42-73-4NT	●	4	28	14	14	50	160	42	73	90	70	APMT120508R-N3※3 APMT120508R-RS		171,260
コンビネーション シャンク Combination shank	AME1250S508-73-4NT	●	4	28	14	14	50	180	50.8	73	100	80	APMT120520R-RS※1	Fig.2	174,780
	AME1250S508-115-4NT	●	4	44	22	22	50	220	50.8	115	140	80	APMT120530R-RS※1※2		260,410

- ※1：コーナ半径RE2.0およびRE3.0は先端刃のみ使用可能です。
- ※2：コーナ半径RE3.0を使用する場合はボディコーナ部を追加加工する必要があります。
- ※3：ニック付インサートは1本のホルダーにつき、N2・N3タイプの2種類を取り付けてください。N2かN3を単独で取り付けると工具破損します。
- ※4：3枚刃タイプにニック付インサートを使用する場合、N2タイプを4個、N3タイプを8個取り付けてください。

- ※1：Corner radius RE2.0 and RE3.0 can be used only for tip inserts.
- ※2：When using corner radius RE3.0, it is necessary to perform additional machining of body corner areas.
- ※3：When using nicked inserts, install 2 types of inserts (N2 type and N3 type) on a single holder. Installing only N2 type inserts or only N3 type inserts on the holder will cause tool damage.
- ※4：When using nicked inserts on a 3-flute type shank, use 4 N2 type inserts and 8 N3 type inserts.

【注意】アーバ用ねじは付属しません。

【Note】Arbor screw is not included.

AMEB○○○○R(M/S)-○○○-○NT ボアタイプ Bore type ○は数字が入ります。Numeric figure in a circle○.

ボアタイプ用アーバはD11頁を参照ください。Refer page D11 about the bore type arbor

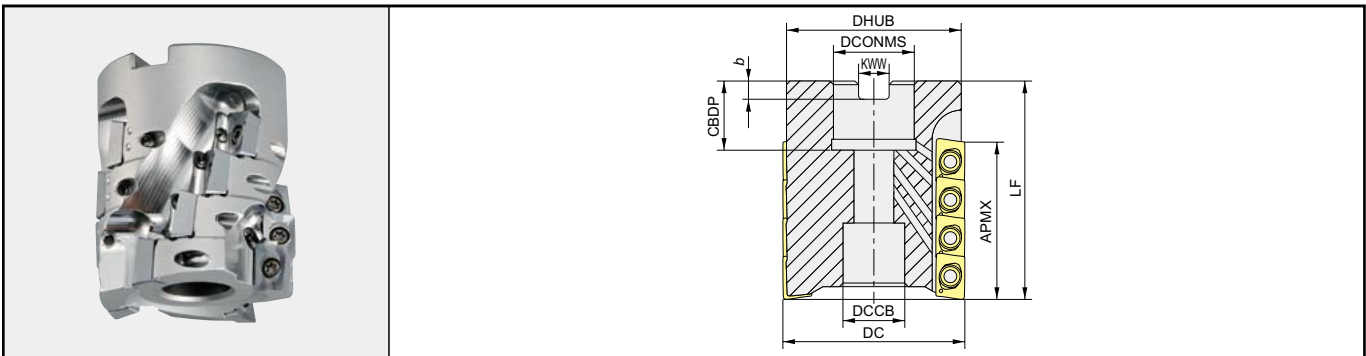

商品コード Item code	在庫 Stock	刃列 No. of flutes	インサート数 No. of inserts			寸法 Size (mm)										適用インサート Inserts	希望小売 価格(円) Suggested retail price (¥)
			波刃、 シャープエッジ の場合 For wave-edge and sharp-edged inserts	ニック付の場合 For Nicked inserts	2ニック 2 Nicks	3ニック 3 Nicks	DC	APMX	DHUB	LF	CDBP	KWW	b	DCONMS	DCCB		
内径インチ Inside diameter inch size	AMEB1250R-42-4NT	●	4	16	8	8	50	42	48	60	19	8.4	5	22.225	17	APMT120508R-FT	98,190
	AMEB1263R-42-6NT	●	6	24	12	12	63	42	61	60	19	8.4	5	22.225	17	APMT120530R-FT※1※2 APMT120508R-N2※3	
内径ミリ Inside diameter mm size	AMEB1250RM-42-4NT	●	4	16	8	8	50	42	48	60	20	10.4	6.3	22	17	APMT120508R-N3※3	98,190
	AMEB1263RM-42-6NT	●	6	24	12	12	63	42	61	60	20	10.4	6.3	22	17	APMT120508R-RS APMT120520R-RS※1	
シェルタイプ Shell type	AMEB1250RS-32-4NT	●	4	12	6	6	50	32	48	55	22	12.4	7	27	19	APMT120530R-RS※1※2	78,600

- ※1：コーナ半径RE2.0およびRE3.0は先端刃のみ使用可能です。
- ※2：コーナ半径RE3.0を使用する場合はボディコーナ部を追加加工する必要があります。
- ※3：ニック付インサートは1本のホルダーにつき、N2・N3タイプの2種類を取り付けてください。N2かN3を単独で取り付けると工具破損します。

- ※1：Corner radius RE2.0 and RE3.0 can be used only for tip inserts.
- ※2：When using corner radius RE3.0, it is necessary to perform additional machining of body corner areas.
- ※3：When using nicked inserts, install 2 types of inserts (N2 type and N3 type) on a single holder. Installing only N2 type inserts or only N3 type inserts on the holder will cause tool damage.

【注意】アーバ用ねじは付属しません。

【Note】Arbor screw is not included.

●印：標準在庫品です。 ●：Stocked items. 無印：弊社営業へお問合せください。 No mark：Contact with our sales department.

■ インサート Insert

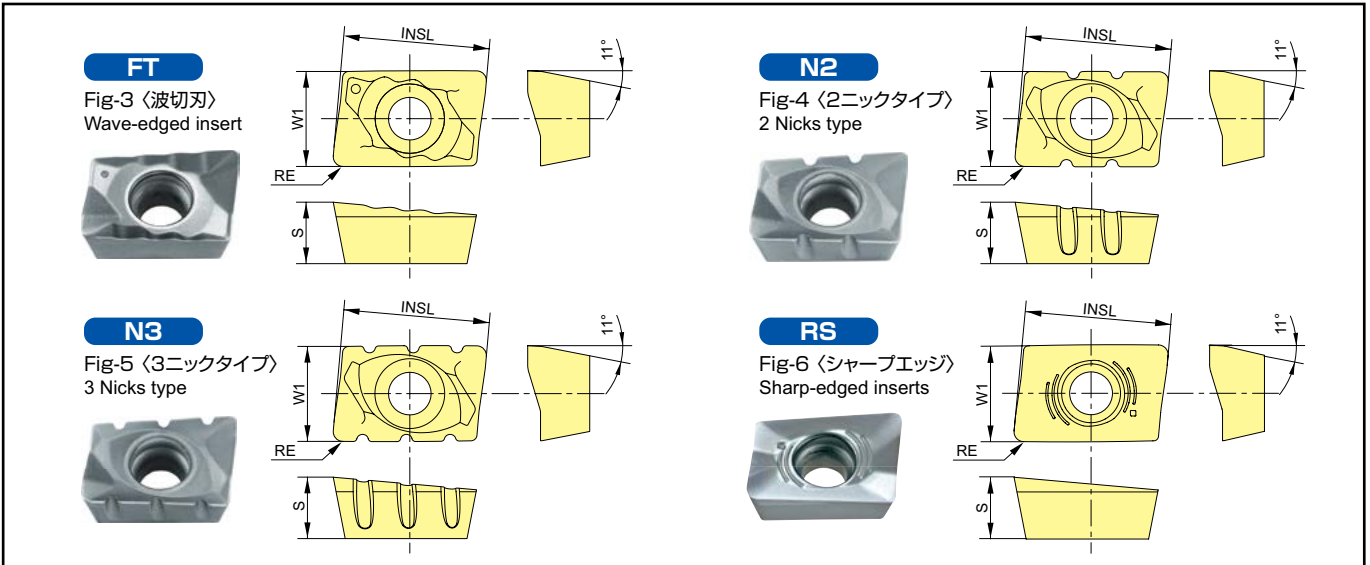

P 鋼	Carbon steels											
M SUS等	SUS, etc.											
K FC・FCD	Cast irons											
S チタン合金	Titanium alloys											

商品コード Item code	精度 Tolerance class	JSコーティング JS Coating		AJコーティング AJ Coating	寸法 Size (mm)				形状 Shape	希望小売 価格(円) Suggested retail price(¥)
		JS1025	JS4060	JM4160	INSL	W1	S	RE		
波切刃 Wave-edged insert	M級 M	APMT120508R-FT	●	●	12	7.89	5	0.8	Fig.3	1,130
		APMT120530R-FT※1			12	7.89	5	3.0		1,130
2ニック 2 Nicks	M級 M	APMT120508R-N2※2	●	●	12	7.89	5	0.8	Fig.4	1,130
3ニック 3 Nicks		APMT120508R-N3※2	●	●	12	7.89	5	0.8	Fig.5	1,130
シャープエッジ Sharp-edged inserts	M級 M	APMT120508R-RS	●		12	7.89	5	0.8	Fig.6	1,130
		APMT120520R-RS※1	●		12	7.89	5	2.0		1,130
		APMT120530R-RS※1	●		12	7.89	5	3.0		1,130

※1 : コーナ半径RE2.0およびRE3.0は先端刃のみ使用可能です。 ※1 : Corner radius RE2.0 and RE3.0 can be used only for tip inserts.
 ※2 : ニック付インサートは1本のホルダーにつき、N2・N3タイプの2種類を取り付けてください。N2かN3を単独で取り付けると工具破損します。 ※2 : When using nicked inserts, install 2 types of inserts (N2 type and N3 type) on a single holder. Installing only N2 type inserts or only N3 type inserts on the holder will cause tool damage.

[注意] JSコーティングは通電式タッチセンサーに反応しませんのでご注意ください。 **[Note]** Please note that the JS Coating does not cause a reaction in conductive touch sensors.

■ 部品番号 Parts

部品名 Parts	クランプねじ Clamp screw	アーバ用ねじ Arbor screw	ドライバー Screw driver	ねじ焼き付き防止剤 Screw anti-seizure agent						
適用カッタ Cutter body										
シャック Shank	AME12○○S○○○-○○○-○NT	265-141	2.0	870	—	—	—	—		
ボア Bore	AMEB12○○R-○○-○NT	265-141	2.0	870	100-182(エア穴付) With Air hole	3,060	104-T10	1,920	P-37	1,010
	AMEB12○○RM-○○-○NT	265-141	2.0	870	—	—	—	—	—	—

[注意] クランプねじは消耗品です。使用環境により交換寿命は変化しますので早めの交換をお願い致します。クランプねじは予備が2本付属します。
[Note] The clamp screw is a consumable part. Since replacement life depends on the use environment, it is recommended that it be replaced at an early stage. Includes two spare clamp screws.

■ 使用上の注意 Cautions during use

※コーナ半径RE3.0のインサートを使用する場合にはボディコーナを右記のように追加加工してご使用ください。
 ※When using corner radius RE3.0 it is necessary to perform additional machining of body corner areas as indicated below.

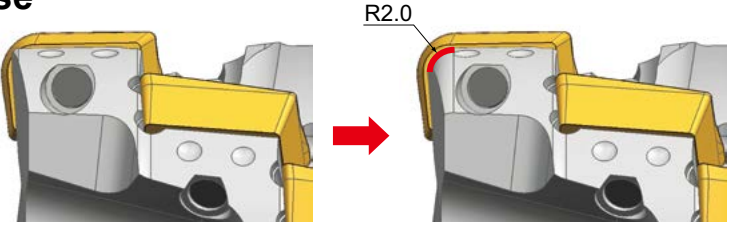

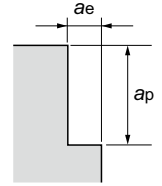

標準切削条件表 Recommended cutting conditions

<肩削り> Shoulder Milling

被削材 Work material	推奨材種 Recommended grade	切削速度 Cutting speed Vc(m/min)	一刃当りの送り Feed tooth fz(mm/t)	シャンクタイプ Shank type									
				φ32		φ40		φ50					
				ae < 8mm		ae < 4mm		4mm < ae < 10mm		ae < 5mm		5mm < ae < 12mm	
				回転数 min ⁻¹	送り速度 mm/min	回転数 min ⁻¹	送り速度 mm/min	回転数 min ⁻¹	送り速度 mm/min	回転数 min ⁻¹	送り速度 mm/min	回転数 min ⁻¹	送り速度 mm/min
一般構造用鋼 Mild steels (200HB以下)	JS4060	120~ 150 ~180	0.12~ 0.16 ~0.20	1,492	716	1,432	1,146	1,194	764	1,146	917	955	611
				Vc=150m/min fz=0.16mm/t		Vc=180m/min fz=0.2mm/t		Vc=150m/min fz=0.16mm/t		Vc=180m/min fz=0.2mm/t		Vc=150m/min fz=0.16mm/t	
炭素鋼・合金鋼 Carbon / Alloy steels (30HRC以下)	JS4060	100~ 120 ~140	0.12~ 0.16 ~0.20	1,194	573	1,114	891	955	611	891	713	764	489
				Vc=120m/min fz=0.16mm/t		Vc=140m/min fz=0.2mm/t		Vc=120m/min fz=0.16mm/t		Vc=140m/min fz=0.2mm/t		Vc=120m/min fz=0.16mm/t	
炭素鋼・合金鋼 Carbon / Alloy steels (30~40HRC)	JS4060	80~ 90 ~100	0.10~ 0.12 ~0.14	895	322	716	401	637	306	573	321	509	244
				Vc=90m/min fz=0.12mm/t		Vc=90m/min fz=0.14mm/t		Vc=80m/min fz=0.12mm/t		Vc=90m/min fz=0.14mm/t		Vc=80m/min fz=0.12mm/t	
ステンレス鋼 Stainless steels SUS ※湿式加工 ※Wet Cutting	JM4160	80~ 90 ~100	0.12~ 0.16 ~0.20	995	477	796	637	716	458	637	509	573	367
				Vc=100m/min fz=0.16mm/t		Vc=100m/min fz=0.2mm/t		Vc=90m/min fz=0.16mm/t		Vc=100m/min fz=0.2mm/t		Vc=90m/min fz=0.16mm/t	
鋳鉄 Cast irons FC,FCD	JS4060	120~ 150 ~180	0.12~ 0.16 ~0.20	1,492	716	1,432	1,146	1,194	764	1,146	917	955	611
				Vc=150m/min fz=0.16mm/t		Vc=180m/min fz=0.2mm/t		Vc=150m/min fz=0.16mm/t		Vc=180m/min fz=0.2mm/t		Vc=150m/min fz=0.16mm/t	
チタン合金 Titanium alloys Ti ※湿式加工 ※Wet Cutting	JS1025	30~ 40 ~50	0.07~ 0.10 ~0.13	398	119	398	207	318	127	318	166	255	102
				Vc=40m/min fz=0.1mm/t		Vc=50m/min fz=0.13mm/t		Vc=40m/min fz=0.1mm/t		Vc=50m/min fz=0.13mm/t		Vc=40m/min fz=0.1mm/t	

被削材 Work material	推奨材種 Recommended grade	切削速度 Cutting speed Vc(m/min)	一刃当りの送り Feed tooth fz(mm/t)	ボアタイプ Bore type							
				φ50				φ63			
				L/D < 3		3 < L/D < 5		L/D < 3		3 < L/D < 5	
				回転数 min ⁻¹	送り速度 mm/min	回転数 min ⁻¹	送り速度 mm/min	回転数 min ⁻¹	送り速度 mm/min	回転数 min ⁻¹	送り速度 mm/min
一般構造用鋼 Mild steels (200HB以下)	JS4060	120~ 150 ~180	0.12~ 0.16 ~0.20	955	611	764	367	758	728	606	437
				Vc=150m/min fz=0.16mm/t		Vc=120m/min fz=0.12mm/t		Vc=150m/min fz=0.16mm/t		Vc=120m/min fz=0.12mm/t	
炭素鋼・合金鋼 Carbon / Alloy steels (30HRC以下)	JS4060	100~ 120 ~140	0.12~ 0.16 ~0.20	764	489	637	306	606	582	505	364
				Vc=120m/min fz=0.16mm/t		Vc=100m/min fz=0.12mm/t		Vc=120m/min fz=0.16mm/t		Vc=100m/min fz=0.12mm/t	
炭素鋼・合金鋼 Carbon / Alloy steels (30~40HRC)	JS4060	80~ 90 ~100	0.10~ 0.12 ~0.14	573	275	509	204	455	327	404	243
				Vc=90m/min fz=0.12mm/t		Vc=80m/min fz=0.1mm/t		Vc=90m/min fz=0.12mm/t		Vc=80m/min fz=0.1mm/t	
ステンレス鋼 Stainless steels SUS ※湿式加工 ※Wet Cutting	JM4160	80~ 90 ~100	0.12~ 0.16 ~0.20	637	407	573	275	505	485	455	327
				Vc=100m/min fz=0.16mm/t		Vc=90m/min fz=0.12mm/t		Vc=100m/min fz=0.16mm/t		Vc=90m/min fz=0.12mm/t	
鋳鉄 Cast irons FC,FCD	JS4060	120~ 150 ~180	0.12~ 0.16 ~0.20	955	611	764	367	758	728	606	437
				Vc=150m/min fz=0.16mm/t		Vc=120m/min fz=0.12mm/t		Vc=150m/min fz=0.16mm/t		Vc=120m/min fz=0.12mm/t	
チタン合金 Titanium alloys Ti ※湿式加工 ※Wet Cutting	JS1025	30~ 40 ~50	0.07~ 0.10 ~0.13	318	166	255	102	253	197	202	121
				Vc=50m/min fz=0.13mm/t		Vc=40m/min fz=0.1mm/t		Vc=50m/min fz=0.13mm/t		Vc=40m/min fz=0.1mm/t	

切込み量の調整は次頁の加工領域線図を参考にしてください。 For adjusting cutting amount, refer to the machining region curves on the next page.

- [注意]**
- ①本表は肩削り時の一般的な条件です。機械剛性やツールリング、加工物の状況に合わせて調整してください。
 - ②切りくず噛み込みによる工具損傷防止のため、必ずエアブロー等による切りくず除去を行ってください。
 - ③排出した切りくずは、飛散し作業者を切傷させ、火傷あるいは目に入って負傷させる恐れがありますので、ご使用に際してはその周囲に安全カバーを取付け、保護メガネ等の保護具を着用し、安全な環境で作業される事を願っています。
 - ④JSコーティングは通電式タッチセンサーに反応しませんのでご注意ください。
 - ⑤インサートの交換は早めに行い、過度の使用による破損を防いでください。
 - ⑥下記に単位時間当たりの切りくず排出量Qを示します。

$$Q(\text{cm}^3/\text{min}) = a_p(\text{mm}) \times a_e(\text{mm}) \times v_f(\text{mm}/\text{min}) / 1000$$
 - ⑦本工具は溝切削には適しません。
 - ⑧チタン合金の加工では必ず水溶性切削油を供給してください。
 - ⑨FTブレイカは中仕上げ用のインサートです。ae<3mmでの使用を推奨いたします。

- [Note]**
- ① This table shows general conditions for shoulder cutting. Conditions should be adjusted according to machine rigidity and tooling, workpiece condition, etc.
 - ② To prevent tool damage due to chip clogging, always use a chip removal method such as an air blower, etc.
 - ③ Since there is a danger of discharged chips flying up and causing cuts, burns, or damaging eyes, during use be sure that protective covers are in place and that workers wear protective equipment such as protective goggles to create a safe work environment.
 - ④ Please note that the JS Coating does not cause a reaction in conductive touch sensors.
 - ⑤ Replace inserts at an early stage to avoid breakage due to excessive use.
 - ⑥ The following equation can be used to determine the metal removal rate per unit time Q:

$$Q(\text{cm}^3/\text{min}) = a_p(\text{mm}) \times a_e(\text{mm}) \times v_f(\text{mm}/\text{min}) / 1000$$
 - ⑦ This tool is not suitable for slotting.
 - ⑧ Be sure to supply a water-soluble lubricant when machining titanium alloys.
 - ⑨ FT breakers are medium-finishing inserts. Recommended for use for ae<3mm.

■ 突出し量と切削領域 Overhang and Cutting range

① シャンクタイプ (φ50) Shank Type

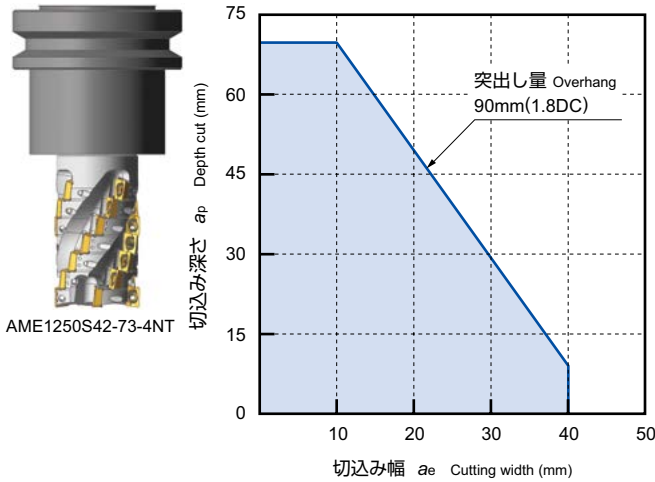

② ボアタイプ (φ50) Bore Type

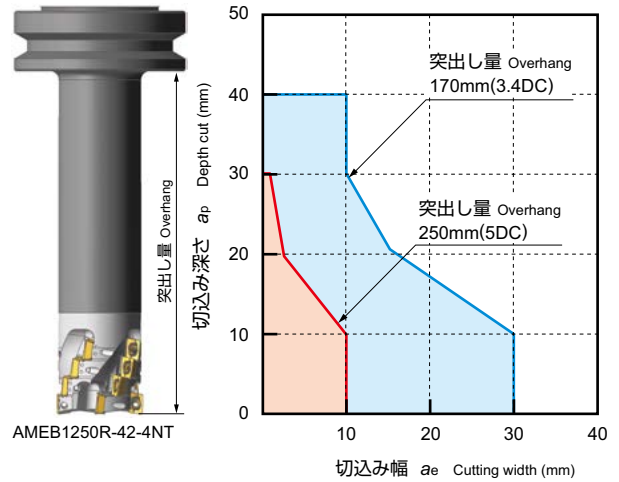

■ 切削条件 Cutting Conditions

使用機械: **BT50 (11/15kW)**
Machine used

インサート: **APMT120508R-N2/N3(ニック付)**
Insert With nick

被削材: **炭素鋼 (S50C:220HB)**
Work material Carbon Steels

切削速度: **$v_c=120$ m/min ($n=764$ min⁻¹)**
Cutting speed

送り速度: **$v_f=367$ mm/min ($f_z=0.1$ mm/t)**
Feed rate

※実際の加工では機械剛性やツーリング、加工物の状況に合わせて切込み量を調整してください。

※For actual machining, adjust the cutting amount according to the cutting material and machine rigidity and tooling.

■ カッタボディの特長及び用途 Features and Applications of Cutter Body

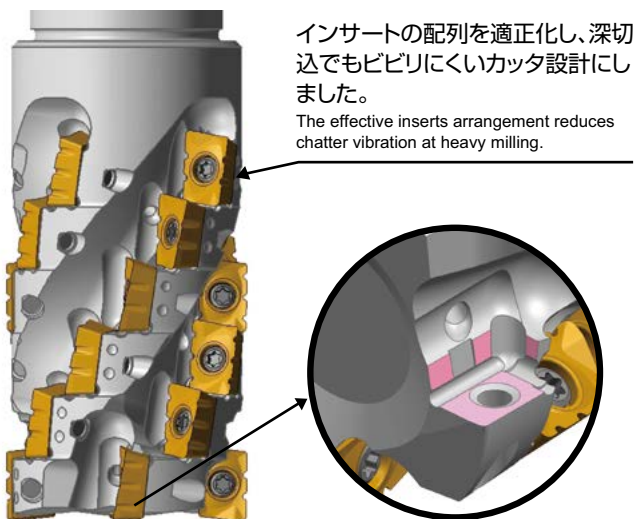

先端刃も工具軸方向のインサート拘束面が有り確実なクランプを実現しています。

The tip blade also has a surface to clamp insert surface in the tool axis direction to achieve secure clamping.

■ ニック付インサートの取付方法 How to install the nicked inserts.

●ホルダーの印がある刃列に **N2タイプインサート** を取り付けてください。

●N3タイプインサートは印のない刃列に取り付けてください。

- Install N2 type inserts on insert rows with holder mark.
- Install N3 type inserts on insert rows without holder mark.

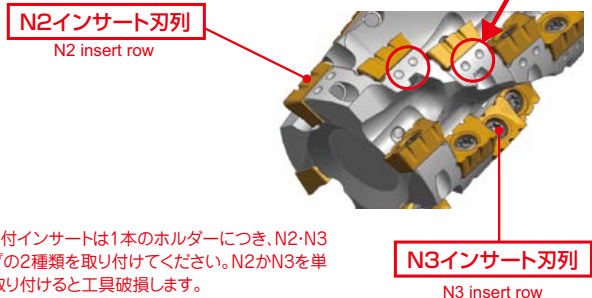

【注意】

- ①ニック付インサートは1本のホルダーにつき、N2・N3タイプの2種類を取り付けてください。N2かN3を単独で取り付けると工具破損します。
- ②ニック付インサートの取り付け位置を誤ると工具破損しますので充分ご注意ください。

【Note】

- ①When using nicked inserts, install 2 types of inserts (N2 type and N3 type) on a single holder. Installing only N2 type inserts or only N3 type inserts on the holder will cause tool damage.
- ②Installing nicked inserts in the wrong position will cause tool damage. Be sure to exercise sufficient care.



●小径多刃シリーズに高精度仕上げ工具が追加。快削刃形が立壁加工のお困り事を解決します。

・We've added high-precision finishing tools to our small-diameter multi-flute cutting tool series. The free-cutting edge shape solves issues related to vertical wall cutting.



ASPV10 $\circ\circ$ R- \circ スチールシャンクタイプ Steel shank type

○は数字が入ります。 Numeric figure in a circle ○

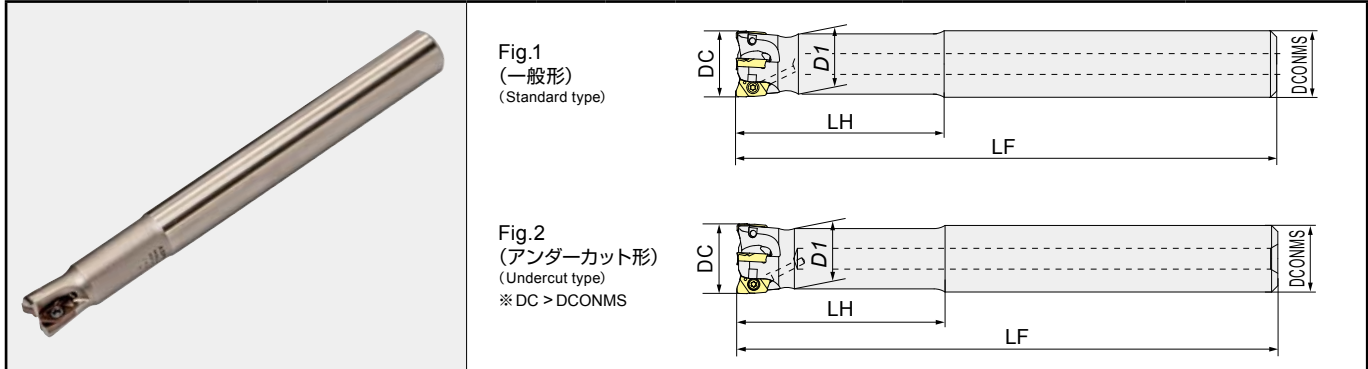

商品コード Item code	在庫 Stock	刃数 No. of flutes	寸法 Size (mm)					形状 Shape	適用インサート Recommended insert	希望小売価格(円) Suggested retail price(¥)
			DC	LF	LH	D1	DCONMS			
ASPV1010R-2	●	2	10	100	30	9.4	10	Fig.1 一般形 Standard type	MPHT0402 $\circ\circ$ ZEL(- $\circ\circ$)	22,290
ASPV1011R-2	●	2	11	100	30	9.4	10	Fig.2 アンダーカット形 Undercut type		22,290
ASPV1012R-3	●	3	12	100	40	11.2	12	Fig.1 一般形 Standard type		26,980
ASPV1013R-3	●	3	13	100	40	11.2	12	Fig.2 アンダーカット形 Undercut type		26,980
ASPV1016R-4	●	4	16	130	50	14.5	16	Fig.1 一般形 Standard type		38,710
ASPV1017R-4	●	4	17	130	50	14.5	16	Fig.2 アンダーカット形 Undercut type		38,710
ASPV1020R-5	●	5	20	160	60	18	20	Fig.1 一般形 Standard type		44,580
ASPV1021R-5	●	5	21	160	60	18	20	Fig.2 アンダーカット形 Undercut type		44,580
ASPV1025R-6	●	6	25	180	75	23	25	Fig.1 一般形 Standard type		51,620
ASPV1026R-6	●	6	26	180	75	23	25	Fig.2 アンダーカット形 Undercut type		51,620
ASPV1032R-8	●	8	32	200	100	30	32	Fig.1 一般形 Standard type	64,520	

■ 部品番号 Parts

部品名 Parts	クランプねじ Clamp screw			ドライバー Screw Driver		ねじ焼き付き防止剤 Screw anti-seizure agent	
形状 Shape		締付トルク Fastening torque (N·m)	希望小売価格 (円) Suggested retail price (¥)		希望小売価格 (円) Suggested retail price (¥)		希望小売価格 (円) Suggested retail price (¥)
適用カッター Cutter body ASPV10 $\circ\circ$ R- \circ ASPVM10 $\circ\circ$ R- \circ -M \circ	240-140	0.5	870	104-T6	1,800	P-37	1,010

クランプねじは消耗品です。使用環境により交換寿命は変化しますので早めの交換をお願い致します。

クランプねじは、工具径13mm以下に予備が1本、工具径16mm以上に2本付属します。

The clamp screw is a consumable part. Since replacement life depends on the use environment, it is recommended that it be replaced at an early stage.

As spare parts for the tools, one clamp screw is attached when the tool diameter is 13 mm or smaller, while two clamp screws are attached when the tool diameter is 16 mm or larger.

●印：標準在庫品です。 ●：Stocked items.

○は数字が入ります。Numeric figure in a circle ○

ASPVM10○○R-○-M○○ モジュラータイプ Modular type

モジュラーミル用シャンクはD2頁を、締め付けトルクについてはD5頁を参照ください。
Refer page D2 about the shanks for Modular Mill, Refer page D5 about tightening torque

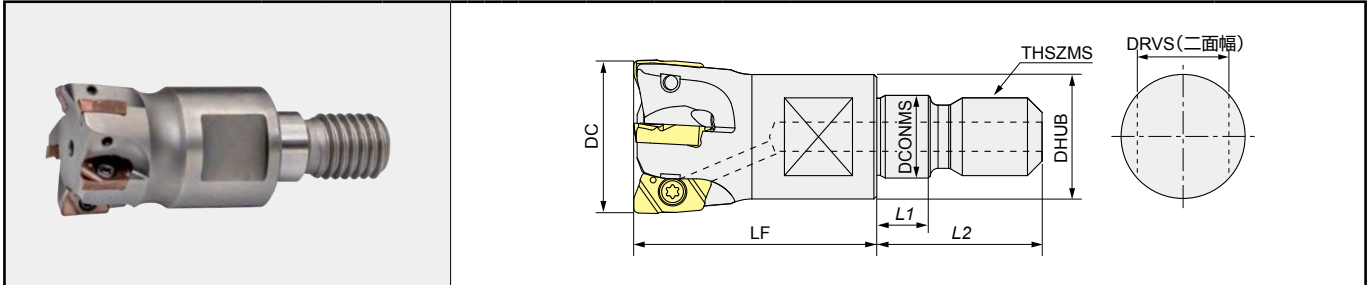

商品コード Item code	在庫 Stock	刃数 No. of flutes	寸法 Size (mm)								適用インサート Recommended insert	希望小売価格(円) Suggested retail price(¥)
			DC	LF	DCONMS	THSZMS	DHUB	L1	L2	DRVS		
ASPVM1010R-2-M6	●	2	10	20	6.5	M6	9.4	5.5	14.5	7	MPHT0402○○ZEL(-○○)	22,290
※ ASPVM1011R-2-M6	●	2	11	20	6.5	M6	9.8	5.5	14.5	7		22,290
ASPVM1012R-3-M6	●	3	12	20	6.5	M6	9.8	5.5	14.5	7		26,980
※ ASPVM1013R-3-M6	●	3	13	20	6.5	M6	9.8	5.5	14.5	7		26,980
ASPVM1016R-4-M8	●	4	16	25	8.5	M8	12.8	5.5	17	10		38,710
※ ASPVM1017R-4-M8	●	4	17	25	8.5	M8	12.8	5.5	17	10		38,710
ASPVM1020R-5-M10	●	5	20	30	10.5	M10	17.8	5.5	19	15		44,580
※ ASPVM1021R-5-M10	●	5	21	30	10.5	M10	17.8	5.5	19	15		44,580
ASPVM1025R-6-M12	●	6	25	30	12.5	M12	20.8	5.5	22	17		51,620
※ ASPVM1026R-6-M12	●	6	26	30	12.5	M12	20.8	5.5	22	17		51,620
ASPVM1032R-8-M16	●	8	32	30	17	M16	28.8	6	23	22		64,520

[注意] ※と超硬シャンクをセットで使用すると干渉がありません。
モジュラーミル専用シャンク/アーバとの接続端面及びねじ部に潤滑剤は塗布しないでください。
[Note] When ※ and carbide shank are used together as a set, there is no interference.
Do not apply lubricants to the threaded section or end surface sections in contact with the dedicated shank/arbor for modular mills.

■ インサート Inserts

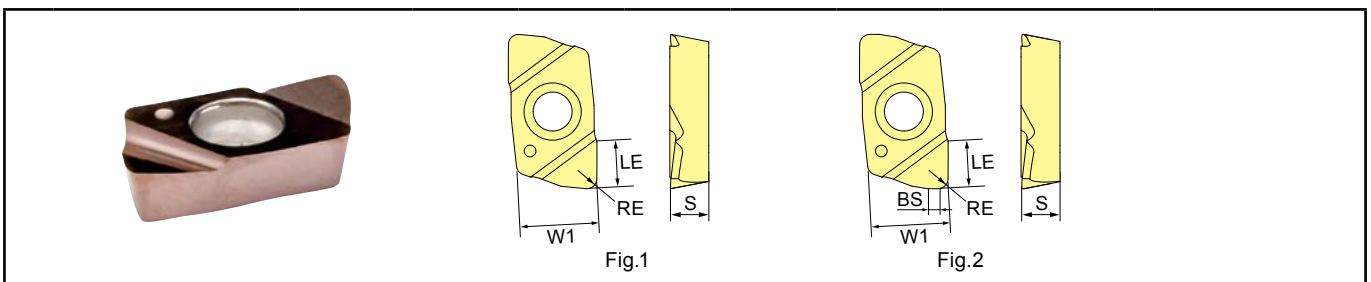

商品コード Item code	精度 Tolerance class	TH308	寸法 Size (mm)					形状 Shape	希望小売価格(円) Suggested retail price(¥)
			W1	BS	S	LE	RE		
MPHT040202ZEL	H級 H	●	4.3	0	2	2.3	0.2	Fig. 1	1,520
MPHT040202ZEL-0.5		●		0.5				Fig. 2	1,520
MPHT040205ZEL		●		0			0.5	Fig. 1	1,520
MPHT040205ZEL-0.5		●		0.5				Fig. 2	1,520
MPHT040210ZEL		●		0			1	Fig. 1	1,520
MPHT040210ZEL-0.5		●		0.5				Fig. 2	1,520

■：一般切削・第一推奨
General cutting, First recommendation

側面仕上げ Side finishing

被削材 Work material	推奨 材種 Recommended grade	工具径 DC Tool dia.	φ 10(2枚刃) (2 Flutes)					φ 11(2枚刃) (2 Flutes)					φ 12(3枚刃) (3 Flutes)					φ 13(3枚刃) (3 Flutes)					φ 16(4枚刃) (4 Flutes)				
		突出し量 Overhang	<3DC		モジュラー超硬シャンク Modular carbide shank			<3DC		モジュラー超硬シャンク Modular carbide shank			<3DC		モジュラー超硬シャンク Modular carbide shank			<3DC		モジュラー超硬シャンク Modular carbide shank			<3DC		モジュラー超硬シャンク Modular carbide shank		
			汎用 General purpose	高速加工 High-speed cutting	3DC -5DC	5DC -7DC	>7DC	汎用 General purpose	高速加工 High-speed cutting	3DC -5DC	5DC -7DC	>7DC	汎用 General purpose	高速加工 High-speed cutting	3DC -5DC	5DC -7DC	>7DC	汎用 General purpose	高速加工 High-speed cutting	3DC -5DC	5DC -7DC	>7DC	汎用 General purpose	高速加工 High-speed cutting	3DC -5DC	5DC -7DC	>7DC
一般構造用鋼 Mild steels (200HB 以下) (200HB or less)	TH308	n (min ⁻¹)	12,732	19,099	15,915	12,732	12,732	11,575	17,362	14,469	11,575	11,575	10,610	18,568	15,915	10,610	10,610	9,794	19,588	14,691	9,794	9,794	7,958	15,915	11,937	7,958	7,958
		Vc(m/min)	400	600	500	400	400	400	600	500	400	400	400	700	600	400	400	400	800	600	400	400	400	800	600	400	400
		Vf(mm/min)	2,546	5,730	4,775	3,056	2,546	2,315	5,209	4,341	2,778	2,315	3,183	8,356	7,162	3,820	3,183	2,938	8,815	6,611	3,526	2,938	3,183	9,549	7,162	3,820	3,183
		fz(mm/t)	0.1	0.15	0.15	0.12	0.1	0.1	0.15	0.15	0.12	0.1	0.1	0.15	0.15	0.12	0.1	0.1	0.15	0.15	0.12	0.1	0.1	0.15	0.15	0.12	0.1
		ap(mm)	1.5	1.5	1	0.7	0.5	1.5	1.5	1	0.7	0.5	1.5	1.5	1	0.7	0.5	1.5	1.5	1	0.7	0.5	1.5	1.5	1	0.7	0.5
		ae(mm)	<0.2	<0.2	<0.2	<0.2	<0.2	<0.2	<0.2	<0.2	<0.2	<0.2	<0.2	<0.2	<0.2	<0.2	<0.2	<0.2	<0.2	<0.2	<0.2	<0.2	<0.2	<0.2	<0.2	<0.2	<0.2
炭素鋼 合金鋼 Carbon steels Alloy steels (30HRC 以下) (30HRC or less)	TH308	n (min ⁻¹)	9,549	19,099	12,732	12,732	9,549	8,681	17,362	11,575	11,575	8,681	7,958	15,915	10,610	10,610	7,958	7,346	14,691	9,794	9,794	7,346	5,968	11,937	7,958	7,958	5,968
		Vc(m/min)	300	600	400	400	300	300	600	400	400	300	300	600	400	400	300	300	600	400	400	300	300	600	400	400	300
		Vf(mm/min)	1,910	5,730	3,820	3,056	1,910	1,736	5,209	3,472	2,778	1,736	2,387	7,162	4,775	3,820	2,387	2,204	6,611	4,407	3,526	2,204	2,387	7,162	4,775	3,820	2,387
		fz(mm/t)	0.1	0.15	0.15	0.12	0.1	0.1	0.15	0.15	0.12	0.1	0.1	0.15	0.15	0.12	0.1	0.1	0.15	0.15	0.12	0.1	0.1	0.15	0.15	0.12	0.1
		ap(mm)	1.5	1.5	1	0.7	0.5	1.5	1.5	1	0.7	0.5	1.5	1.5	1	0.7	0.5	1.5	1.5	1	0.7	0.5	1.5	1.5	1	0.7	0.5
		ae(mm)	<0.2	<0.2	<0.2	<0.2	<0.2	<0.2	<0.2	<0.2	<0.2	<0.2	<0.2	<0.2	<0.2	<0.2	<0.2	<0.2	<0.2	<0.2	<0.2	<0.2	<0.2	<0.2	<0.2	<0.2	<0.2
炭素鋼 合金鋼 Carbon steels Alloy steels (30 ~ 45HRC)	TH308	n (min ⁻¹)	6,366	15,915	11,141	9,549	9,549	5,787	14,469	10,128	8,681	8,681	5,305	13,263	9,284	7,958	7,958	4,897	12,243	8,570	7,346	7,346	3,979	9,947	6,963	5,968	5,968
		Vc(m/min)	200	500	350	300	300	200	500	350	300	300	200	500	350	300	300	200	500	350	300	300	200	500	350	300	300
		Vf(mm/min)	1,273	3,820	2,674	1,910	1,528	1,157	3,472	2,431	1,736	1,389	1,592	4,775	3,342	2,387	1,910	1,469	4,407	3,085	2,204	1,763	1,592	4,775	3,342	2,387	1,910
		fz(mm/t)	0.1	0.12	0.12	0.1	0.08	0.1	0.12	0.12	0.1	0.08	0.1	0.12	0.12	0.1	0.08	0.1	0.12	0.12	0.1	0.08	0.1	0.12	0.12	0.1	0.08
		ap(mm)	1.5	1.5	1	0.7	0.5	1.5	1.5	1	0.7	0.5	1.5	1.5	1	0.7	0.5	1.5	1.5	1	0.7	0.5	1.5	1.5	1	0.7	0.5
		ae(mm)	<0.2	<0.2	<0.2	<0.2	<0.2	<0.2	<0.2	<0.2	<0.2	<0.2	<0.2	<0.2	<0.2	<0.2	<0.2	<0.2	<0.2	<0.2	<0.2	<0.2	<0.2	<0.2	<0.2	<0.2	<0.2
焼入れ鋼 Hardened steels (45 ~ 55HRC)	TH308	n (min ⁻¹)	4,775	7,958	5,730	4,775	4,775	4,341	7,234	5,209	4,341	4,341	3,979	6,631	4,775	3,979	3,979	3,673	6,121	4,407	3,673	3,673	2,984	4,974	3,581	2,984	2,984
		Vc(m/min)	150	250	180	150	150	150	250	180	150	150	150	250	180	150	150	150	250	180	150	150	150	250	180	150	150
		Vf(mm/min)	955	1,592	1,146	764	764	868	1,447	1,042	694	694	1,194	1,989	1,432	955	955	1,102	1,836	1,322	881	881	1,194	1,989	1,432	955	955
		fz(mm/t)	0.1	0.1	0.1	0.08	0.08	0.1	0.1	0.1	0.08	0.08	0.1	0.1	0.1	0.08	0.08	0.1	0.1	0.1	0.08	0.08	0.1	0.1	0.1	0.08	0.08
		ap(mm)	1.5	1.5	1	0.7	0.5	1.5	1.5	1	0.7	0.5	1.5	1.5	1	0.7	0.5	1.5	1.5	1	0.7	0.5	1.5	1.5	1	0.7	0.5
		ae(mm)	<0.2	<0.2	<0.2	<0.2	<0.2	<0.2	<0.2	<0.2	<0.2	<0.2	<0.2	<0.2	<0.2	<0.2	<0.2	<0.2	<0.2	<0.2	<0.2	<0.2	<0.2	<0.2	<0.2	<0.2	<0.2
焼入れ鋼 Hardened steels (55 ~ 62HRC)	TH308	n (min ⁻¹)	4,138	6,366	5,093	4,138	4,138	3,762	5,787	4,630	3,762	3,762	3,448	5,305	4,244	3,448	3,448	3,183	4,897	3,918	3,183	3,183	2,586	3,979	3,183	2,586	2,586
		Vc(m/min)	130	200	160	130	130	130	200	160	130	130	130	200	160	130	130	130	200	160	130	130	130	200	160	130	130
		Vf(mm/min)	828	1,273	1,019	662	414	752	1,157	926	602	376	1,035	1,592	1,273	828	517	955	1,469	1,175	764	477	1,035	1,592	1,273	828	517
		fz(mm/t)	0.1	0.1	0.1	0.08	0.05	0.1	0.1	0.1	0.08	0.05	0.1	0.1	0.1	0.08	0.05	0.1	0.1	0.1	0.08	0.05	0.1	0.1	0.1	0.08	0.05
		ap(mm)	1.5	1.5	1	0.7	0.5	1.5	1.5	1	0.7	0.5	1.5	1.5	1	0.7	0.5	1.5	1.5	1	0.7	0.5	1.5	1.5	1	0.7	0.5
		ae(mm)	<0.2	<0.2	<0.2	<0.2	<0.2	<0.2	<0.2	<0.2	<0.2	<0.2	<0.2	<0.2	<0.2	<0.2	<0.2	<0.2	<0.2	<0.2	<0.2	<0.2	<0.2	<0.2	<0.2	<0.2	<0.2
ステンレス鋼 Stainless steels SUS	TH308	n (min ⁻¹)	9,549	19,099	12,732	12,732	9,549	8,681	17,362	11,575	11,575	8,681	7,958	15,915	10,610	10,610	7,958	7,346	14,691	9,794	9,794	7,346	5,968	11,937	7,958	7,958	5,968
		Vc(m/min)	300	600	400	400	300	300	600	400	400	300	300	600	400	400	300	300	600	400	400	300	300	600	400	400	300
		Vf(mm/min)	1,910	5,730	3,820	3,056	1,910	1,736	5,209	3,472	2,778	1,736	2,387	7,162	4,775	3,820	2,387	2,204	6,611	4,407	3,526	2,204	2,387	7,162	4,775	3,820	2,387
		fz(mm/t)	0.1	0.15	0.15	0.12	0.1	0.1	0.15	0.15	0.12	0.1	0.1	0.15	0.15	0.12	0.1	0.1	0.15	0.15	0.12	0.1	0.1	0.15	0.15	0.12	0.1
		ap(mm)	1.5	1.5	1	0.7	0.5	1.5	1.5	1	0.7	0.5	1.5	1.5	1	0.7	0.5	1.5	1.5	1	0.7	0.5	1.5	1.5	1	0.7	0.5
		ae(mm)	<0.2	<0.2	<0.2	<0.2	<0.2	<0.2	<0.2	<0.2	<0.2	<0.2	<0.2	<0.2	<0.2	<0.2	<0.2	<0.2	<0.2	<0.2	<0.2	<0.2	<0.2	<0.2	<0.2	<0.2	<0.2
鋳鉄 Cast irons FC FCD	TH308	n (min ⁻¹)	9,549	19,099	15,915	12,732	12,732	8,681	17,362	14,469	11,575	11,575	7,958	15,915	13,263	10,610	10,610	7,346	14,691	12,243	9,794	9,794	5,968	11,937	9,947	7,958	7,958
		Vc(m/min)	300	600	500	400	400	300	600	500	400	400	300	600	500	400	400	300	600	500	400	400	300	600	500	400	400
		Vf(mm/min)	1,910	5,730	4,775	3,056	2,546	1,736	5,209	4,341	2,778	2,315	2,387	7,162	5,968	3,820	3,183	2,204	6,611	5,509	3,526	2,938	2,387	7,162	5,968	3,820	3,183
		fz(mm/t)	0.1	0.15	0.15	0.12	0.1	0.1	0.15	0.15	0.12	0.1	0.1	0.15	0.15	0.12	0.1	0.1	0.15	0.15	0.12	0.1	0.1	0.15	0.15	0.12	0.1
		ap(mm)	1.5	1.5	1	0.7	0.5	1.5	1.5	1	0.7	0.5	1.5	1.5	1	0.7	0.5	1.5	1.5	1	0.7	0.5	1.5	1.5	1	0.7	0.5
		ae(mm)	<0.2	<0.2	<0.2	<0.2	<0.2	<0.2	<0.2	<0.2	<0.2	<0.2	<0.2	<0.2	<0.2	<0.2	<0.2	<0.2	<0.2	<0.2	<0.2	<0.2	<0.2	<0.2	<0.2	<0.2	<0.2

- 【注意】**
- ①被削材、加工形状に合わせて、適切なクーラントを使用してください。
 - ②この切削条件表は切削条件の目安を示すものです。実際の加工では加工形状、目的、使用機械等により条件を調整してください。
 - ③溝切削、傾斜切削の場合、送り速度は70%を目安として下さい。
 - ④インサートの交換は早めに行い、過度の使用による破損を防止して下さい。
 - ⑤排出した切屑くずは飛散し作業者を切傷させ、火傷あるいは目に入って負傷させる恐れがありますので、ご使用に際してはその周囲に安全カバーを取り付け保護めがね等の保護具を着用して、安全な環境で作業される事を願います。
 - ⑥不水溶性切削油は、火災の恐れがありますので使用しないで下さい。

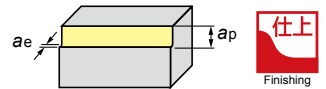

φ 17(4 枚刃) (4 Flutes)					φ 20(5 枚刃) (5 Flutes)					φ 21(5 枚刃) (5 Flutes)					φ 25(6 枚刃) (6 Flutes)					φ 26(6 枚刃) (6 Flutes)					φ 32(8 枚刃) (8 Flutes)					被削材 Work material	
<3DC		モジュラー超硬シャンク Modular carbide shank			<3DC		モジュラー超硬シャンク Modular carbide shank			<3DC		モジュラー超硬シャンク Modular carbide shank			<3DC		モジュラー超硬シャンク Modular carbide shank			<3DC		モジュラー超硬シャンク Modular carbide shank			<3DC		モジュラー超硬シャンク Modular carbide shank				
汎用 General purpose	高速加工 High-speed cutting	3DC -5DC	5DC -7DC	>7DC	汎用 General purpose	高速加工 High-speed cutting	3DC -5DC	5DC -7DC	>7DC	汎用 General purpose	高速加工 High-speed cutting	3DC -5DC	5DC -7DC	>7DC	汎用 General purpose	高速加工 High-speed cutting	3DC -5DC	5DC -7DC	>7DC	汎用 General purpose	高速加工 High-speed cutting	3DC -5DC	5DC -7DC	>7DC	汎用 General purpose	高速加工 High-speed cutting	3DC -5DC	5DC -7DC	>7DC		
7,490	14,979	11,234	7,490	7,490	6,366	12,732	9,549	6,366	6,366	6,063	12,126	9,095	6,063	6,063	5,093	10,186	7,639	5,093	5,093	4,897	9,794	7,346	4,897	4,897	4,897	4,897	9,794	7,346	4,897	4,897	一般構造用鋼 Mild steels (200HB 以下) (200HB or less)
400	800	600	400	400	400	800	600	400	400	400	800	600	400	400	400	800	600	400	400	400	800	600	400	400	400	400	800	600	400	400	
2,996	8,988	6,741	3,595	2,996	3,183	9,549	7,162	3,820	3,183	3,032	9,095	6,821	3,638	3,032	3,056	9,167	6,875	3,667	3,056	2,938	8,815	6,611	3,526	2,938	2,938	8,815	6,611	3,526	2,938		
0.1	0.15	0.15	0.12	0.1	0.1	0.15	0.12	0.1	0.1	0.1	0.15	0.12	0.1	0.1	0.1	0.15	0.12	0.1	0.1	0.1	0.15	0.12	0.1	0.1	0.1	0.15	0.12	0.1	0.1		
1.5	1.5	1	0.7	0.5	1.5	1.5	1	0.7	0.5	1.5	1.5	1	0.7	0.5	1.5	1.5	1	0.7	0.5	1.5	1.5	1	0.7	0.5	1.5	1.5	1	0.7	0.5		
<0.2	<0.2	<0.2	<0.2	<0.2	<0.2	<0.2	<0.2	<0.2	<0.2	<0.2	<0.2	<0.2	<0.2	<0.2	<0.2	<0.2	<0.2	<0.2	<0.2	<0.2	<0.2	<0.2	<0.2	<0.2	<0.2	<0.2	<0.2	<0.2	<0.2		
5,617	11,234	7,490	7,490	5,617	4,775	9,549	6,366	6,366	4,775	4,547	9,095	6,063	6,063	4,547	3,820	7,639	5,093	5,093	3,820	3,673	7,346	4,897	4,897	3,673	2,984	5,968	3,979	3,979	2,984	炭素鋼 合金鋼 Carbon steels Alloy steels (30HRC 以下) (30HRC or less)	
300	600	400	400	300	300	600	400	400	300	300	600	400	400	300	300	600	400	400	300	300	600	400	400	300	300	600	400	400	300		
2,247	6,741	4,494	3,595	2,247	2,387	7,162	4,775	3,820	2,387	2,274	6,821	4,547	3,638	2,274	2,292	6,875	4,584	3,667	2,292	2,204	6,611	4,407	3,526	2,204	2,387	7,162	4,775	3,820	2,387		
0.1	0.15	0.15	0.12	0.1	0.1	0.15	0.12	0.1	0.1	0.1	0.15	0.12	0.1	0.1	0.1	0.15	0.12	0.1	0.1	0.1	0.15	0.12	0.1	0.1	0.1	0.15	0.12	0.1	0.1		
1.5	1.5	1	0.7	0.5	1.5	1.5	1	0.7	0.5	1.5	1.5	1	0.7	0.5	1.5	1.5	1	0.7	0.5	1.5	1.5	1	0.7	0.5	1.5	1.5	1	0.7	0.5		
<0.2	<0.2	<0.2	<0.2	<0.2	<0.2	<0.2	<0.2	<0.2	<0.2	<0.2	<0.2	<0.2	<0.2	<0.2	<0.2	<0.2	<0.2	<0.2	<0.2	<0.2	<0.2	<0.2	<0.2	<0.2	<0.2	<0.2	<0.2	<0.2	<0.2		
3,745	9,362	6,553	5,617	5,617	3,183	7,958	5,570	4,775	4,775	3,032	7,579	5,305	4,547	4,547	2,546	6,366	4,456	3,820	3,820	2,449	6,121	4,285	3,673	3,673	1,989	4,974	3,482	2,984	2,984	炭素鋼 合金鋼 Carbon steels Alloy steels (30 ~ 45HRC)	
200	500	350	300	300	200	500	350	300	300	200	500	350	300	300	200	500	350	300	300	200	500	350	300	300	200	500	350	300	300		
1,498	4,494	3,146	2,247	1,798	1,592	4,775	3,342	2,387	1,910	1,516	4,547	3,183	2,274	1,819	1,528	4,584	3,209	2,292	1,833	1,469	4,407	3,085	2,204	1,763	1,592	4,775	3,342	2,387	1,910		
0.1	0.12	0.12	0.1	0.08	0.1	0.12	0.12	0.1	0.08	0.1	0.12	0.12	0.1	0.08	0.1	0.12	0.12	0.1	0.08	0.1	0.12	0.12	0.1	0.08	0.1	0.12	0.12	0.1	0.08		
1.5	1.5	1	0.7	0.5	1.5	1.5	1	0.7	0.5	1.5	1.5	1	0.7	0.5	1.5	1.5	1	0.7	0.5	1.5	1.5	1	0.7	0.5	1.5	1.5	1	0.7	0.5		
<0.2	<0.2	<0.2	<0.2	<0.2	<0.2	<0.2	<0.2	<0.2	<0.2	<0.2	<0.2	<0.2	<0.2	<0.2	<0.2	<0.2	<0.2	<0.2	<0.2	<0.2	<0.2	<0.2	<0.2	<0.2	<0.2	<0.2	<0.2	<0.2	<0.2		
2,809	4,681	3,370	2,809	2,809	2,387	3,979	2,865	2,387	2,387	2,274	3,789	2,728	2,274	2,274	1,910	3,183	2,292	1,910	1,910	1,836	3,061	2,204	1,836	1,836	1,492	2,487	1,790	1,492	1,492	焼入れ鋼 Hardened steels (45 ~ 55HRC)	
150	250	180	150	150	150	250	180	150	150	150	250	180	150	150	150	250	180	150	150	150	250	180	150	150	150	250	180	150	150		
1,123	1,872	1,348	899	899	1,194	1,989	1,432	955	955	1,137	1,895	1,364	909	909	1,146	1,910	1,375	917	917	1,102	1,836	1,322	881	881	1,194	1,989	1,432	955	955		
0.1	0.1	0.1	0.08	0.08	0.1	0.1	0.1	0.08	0.08	0.1	0.1	0.1	0.08	0.08	0.1	0.1	0.1	0.08	0.08	0.1	0.1	0.1	0.08	0.08	0.1	0.1	0.1	0.08	0.08		
1.5	1.5	1	0.7	0.5	1.5	1.5	1	0.7	0.5	1.5	1.5	1	0.7	0.5	1.5	1.5	1	0.7	0.5	1.5	1.5	1	0.7	0.5	1.5	1.5	1	0.7	0.5		
<0.2	<0.2	<0.2	<0.2	<0.2	<0.2	<0.2	<0.2	<0.2	<0.2	<0.2	<0.2	<0.2	<0.2	<0.2	<0.2	<0.2	<0.2	<0.2	<0.2	<0.2	<0.2	<0.2	<0.2	<0.2	<0.2	<0.2	<0.2	<0.2	<0.2		
2,434	3,745	2,996	2,434	2,434	2,069	3,183	2,546	2,069	2,069	1,970	3,032	2,425	1,970	1,970	1,655	2,546	2,037	1,655	1,655	1,592	2,449	1,959	1,592	1,592	1,293	1,989	1,592	1,293	1,293	焼入れ鋼 Hardened steels (55 ~ 62HRC)	
130	200	160	130	130	130	200	160	130	130	130	200	160	130	130	130	200	160	130	130	130	200	160	130	130	130	200	160	130	130		
974	1,498	1,198	779	487	1,035	1,592	1,273	828	517	985	1,516	1,213	788	493	993	1,528	1,222	795	497	955	1,469	1,175	764	477	1,035	1,592	1,273	828	517		
0.1	0.1	0.1	0.08	0.05	0.1	0.1	0.1	0.08	0.05	0.1	0.1	0.1	0.08	0.05	0.1	0.1	0.1	0.08	0.05	0.1	0.1	0.1	0.08	0.05	0.1	0.1	0.1	0.08	0.05		
1.5	1.5	1	0.7	0.5	1.5	1.5	1	0.7	0.5	1.5	1.5	1	0.7	0.5	1.5	1.5	1	0.7	0.5	1.5	1.5	1	0.7	0.5	1.5	1.5	1	0.7	0.5		
<0.2	<0.2	<0.2	<0.2	<0.2	<0.2	<0.2	<0.2	<0.2	<0.2	<0.2	<0.2	<0.2	<0.2	<0.2	<0.2	<0.2	<0.2	<0.2	<0.2	<0.2	<0.2	<0.2	<0.2	<0.2	<0.2	<0.2	<0.2	<0.2	<0.2		
5,617	11,234	7,490	7,490	5,617	4,775	9,549	6,366	6,366	4,775	4,547	9,095	6,063	6,063	4,547	3,820	7,639	5,093	5,093	3,820	3,673	7,346	4,897	4,897	3,673	2,984	5,968	3,979	3,979	2,984	ステンレス鋼 Stainless steels SUS	
300	600	400	400	300	300	600	400	400	300	300	600	400	400	300	300	600	400	400	300	300	600	400	400	300	300	600	400	400	300		
2,247	6,741	4,494	3,595	2,247	2,387	7,162	4,775	3,820	2,387	2,274	6,821	4,547	3,638	2,274	2,292	6,875	4,584	3,667	2,292	2,204	6,611	4,407	3,526	2,204	2,387	7,162	4,775	3,820	2,387		
0.1	0.15	0.15	0.12	0.1	0.1	0.15	0.12	0.1	0.1	0.1	0.15	0.12	0.1	0.1	0.1	0.15	0.12	0.1	0.1	0.1	0.15	0.12	0.1	0.1	0.1	0.15	0.12	0.1	0.1		
1.5	1.5	1	0.7	0.5	1.5	1.5	1	0.7	0.5	1.5	1.5	1	0.7	0.5	1.5	1.5	1	0.7	0.5	1.5	1.5	1	0.7	0.5	1.5	1.5	1	0.7	0.5		
<0.2	<0.2	<0.2	<0.2	<0.2	<0.2	<0.2	<0.2	<0.2	<0.2	<0.2	<0.2	<0.2	<0.2	<0.2	<0.2	<0.2	<0.2	<0.2	<0.2	<0.2	<0.2	<0.2	<0.2	<0.2	<0.2	<0.2	<0.2	<0.2	<0.2		
5,617	11,234	9,362	7,490	7,490	4,775	9,549	7,958	6,366	6,366	4,547	9,095	7,579	6,063	6,063	3,820	7,639	6,366	5,093	5,093	3,673	7,346	6,121	4,897	4,897	2,984	5,968	4,974	3,979	3,979	鋳鉄 Cast irons FC FCD	
300	600	500	400	400	300	600	500	400	400	300	600	500	400	400	300	600	500	400	400	300	600	500	400	400	300	600	500	400	400		
2,247	6,741	5,617	3,595	2,996	2,387	7,162	5,968	3,820	3,183	2,274	6,821	5,684	3,638	3,032	2,292	6,875	5,730	3,667	3,056	2,204	6,611	5,509	3,526	2,938	2,387	7,162	5,968	3,820	3,183		
0.1	0.15	0.15	0.12	0.1	0.1	0.15	0.12	0.1	0.1	0.1	0.15	0.12	0.1	0.1	0.1	0.15	0.12	0.1	0.1	0.1	0.15	0.12	0.1	0.1	0.1	0.15	0.12	0.1	0.1		
1.5	1.5	1	0.7	0.5	1.5	1.5	1	0.7	0.5	1.5	1.5	1	0.7	0.5	1.5	1.5	1	0													

アルファポリッシュミル Vタイプ ASPVmini

底面仕上げ Bottom finishing

被削材 Work material	推奨 材種 Recommended grade	工具径 DC Tool dia.	φ 10(2枚刃) (2 Flutes)					φ 11(2枚刃) (2 Flutes)					φ 12(3枚刃) (3 Flutes)					φ 13(3枚刃) (3 Flutes)					φ 16(4枚刃) (4 Flutes)					
			突出し量 Overhang																									
			汎用 General purpose	高速加工 High-speed cutting	3DC -5DC	5DC -7DC	>7DC	汎用 General purpose	高速加工 High-speed cutting	3DC -5DC	5DC -7DC	>7DC	汎用 General purpose	高速加工 High-speed cutting	3DC -5DC	5DC -7DC	>7DC	汎用 General purpose	高速加工 High-speed cutting	3DC -5DC	5DC -7DC	>7DC	汎用 General purpose	高速加工 High-speed cutting	3DC -5DC	5DC -7DC	>7DC	
一般構造用鋼 Mild steels (200HB 以下) (200HB or less)	TH308	n (min ⁻¹)	4,775	9,549	6,366	4,775	4,138	4,341	8,681	5,787	4,341	3,762	3,979	7,958	5,305	3,979	3,448	3,673	7,346	4,897	3,673	3,183	2,984	5,968	3,979	2,984	2,586	
		Vc(m/min)	150	300	200	150	130	150	300	200	150	130	150	300	200	150	130	150	300	200	150	130	150	300	200	150	130	
		Vf(mm/min)	955	2,865	1,910	1,146	828	868	2,604	1,736	1,042	752	1,194	3,581	2,387	1,432	1,035	1,102	3,306	2,204	1,322	955	1,194	3,581	2,387	1,432	1,035	
		fz(mm/t)	0.1	0.15	0.15	0.12	0.1	0.1	0.15	0.15	0.12	0.1	0.1	0.15	0.15	0.12	0.1	0.1	0.15	0.15	0.12	0.1	0.1	0.15	0.15	0.12	0.1	
		ap(mm)	0.2	0.2	0.2	0.2	0.2	0.2	0.2	0.2	0.2	0.2	0.2	0.2	0.2	0.2	0.2	0.2	0.2	0.2	0.2	0.2	0.2	0.2	0.2	0.2	0.2	0.2
		ae(mm)	5-10	5-10	5-10	5-10	5-10	5.5-11	5.5-11	5.5-11	5.5-11	5.5-11	6-12	6-12	6-12	6-12	6-12	6.5-13	6.5-13	6.5-13	6.5-13	6.5-13	8-16	8-16	8-16	8-16	8-16	
炭素鋼 合金鋼 Carbon steels Alloy steels (30HRC 以下) (30HRC or less)	TH308	n (min ⁻¹)	4,775	7,958	5,730	4,138	3,183	4,341	7,234	5,209	3,762	2,894	3,979	6,631	4,775	3,448	2,653	3,673	6,121	4,407	3,183	2,449	2,984	4,974	3,581	2,586	1,989	
		Vc(m/min)	150	250	180	130	100	150	250	180	130	100	150	250	180	130	100	150	250	180	130	100	150	250	180	130	100	
		Vf(mm/min)	955	2,387	1,719	993	637	868	2,170	1,563	903	579	1,194	2,984	2,149	1,241	796	1,102	2,755	1,983	1,146	735	1,194	2,984	2,149	1,241	796	
		fz(mm/t)	0.1	0.15	0.15	0.12	0.1	0.1	0.15	0.15	0.12	0.1	0.1	0.15	0.15	0.12	0.1	0.1	0.15	0.15	0.12	0.1	0.1	0.15	0.15	0.12	0.1	
		ap(mm)	0.2	0.2	0.2	0.2	0.2	0.2	0.2	0.2	0.2	0.2	0.2	0.2	0.2	0.2	0.2	0.2	0.2	0.2	0.2	0.2	0.2	0.2	0.2	0.2	0.2	0.2
		ae(mm)	5-10	5-10	5-10	5-10	5-10	5.5-11	5.5-11	5.5-11	5.5-11	5.5-11	6-12	6-12	6-12	6-12	6-12	6.5-13	6.5-13	6.5-13	6.5-13	6.5-13	8-16	8-16	8-16	8-16	8-16	
炭素鋼 合金鋼 Carbon steels Alloy steels (30 ~ 45HRC)	TH308	n (min ⁻¹)	4,138	6,366	5,093	4,138	2,865	3,762	5,787	4,630	3,762	2,604	3,448	5,305	4,244	3,448	2,387	3,183	4,897	3,918	3,183	2,204	2,586	3,979	3,183	2,586	1,790	
		Vc(m/min)	130	200	160	130	90	130	200	160	130	90	130	200	160	130	90	130	200	160	130	90	130	200	160	130	90	
		Vf(mm/min)	828	1,528	1,222	828	458	752	1,389	1,111	752	417	1,035	1,910	1,528	1,035	573	955	1,763	1,410	955	529	1,035	1,910	1,528	1,035	573	
		fz(mm/t)	0.1	0.12	0.12	0.1	0.08	0.1	0.12	0.12	0.1	0.08	0.1	0.12	0.12	0.1	0.08	0.1	0.12	0.12	0.1	0.08	0.1	0.12	0.12	0.1	0.08	
		ap(mm)	0.1	0.1	0.1	0.1	0.1	0.1	0.1	0.1	0.1	0.1	0.1	0.1	0.1	0.1	0.1	0.1	0.1	0.1	0.1	0.1	0.1	0.1	0.1	0.1	0.1	0.1
		ae(mm)	5-10	5-10	5-10	5-10	5-10	5.5-11	5.5-11	5.5-11	5.5-11	5.5-11	6-12	6-12	6-12	6-12	6-12	6.5-13	6.5-13	6.5-13	6.5-13	6.5-13	8-16	8-16	8-16	8-16	8-16	
焼入れ鋼 Hardened steels (45 ~ 55HRC)	TH308	n (min ⁻¹)	2,546	3,820	3,183	2,546	2,546	2,315	3,472	2,894	2,315	2,315	2,122	3,183	2,653	2,122	2,122	1,959	2,938	2,449	1,959	1,959	1,592	2,387	1,989	1,592	1,592	
		Vc(m/min)	80	120	100	80	80	80	120	100	80	80	80	120	100	80	80	80	120	100	80	80	80	120	100	80	80	
		Vf(mm/min)	509	764	637	407	407	463	694	579	370	370	637	955	796	509	509	588	881	735	470	470	637	955	796	509	509	
		fz(mm/t)	0.1	0.1	0.1	0.08	0.08	0.1	0.1	0.1	0.08	0.08	0.1	0.1	0.1	0.08	0.08	0.1	0.1	0.1	0.08	0.08	0.1	0.1	0.1	0.08	0.08	
		ap(mm)	0.1	0.1	0.1	0.1	0.1	0.1	0.1	0.1	0.1	0.1	0.1	0.1	0.1	0.1	0.1	0.1	0.1	0.1	0.1	0.1	0.1	0.1	0.1	0.1	0.1	0.1
		ae(mm)	5-10	5-10	5-10	5-10	5-10	5.5-11	5.5-11	5.5-11	5.5-11	5.5-11	6-12	6-12	6-12	6-12	6-12	6.5-13	6.5-13	6.5-13	6.5-13	6.5-13	8-16	8-16	8-16	8-16	8-16	
焼入れ鋼 Hardened steels (55 ~ 62HRC)	TH308	n (min ⁻¹)	1,592	3,183	2,228	1,592	1,592	1,447	2,894	2,026	1,447	1,447	1,326	2,653	1,857	1,326	1,326	1,224	2,449	1,714	1,224	1,224	995	1,989	1,393	995	995	
		Vc(m/min)	50	100	70	50	50	50	100	70	50	50	50	100	70	50	50	50	100	70	50	50	50	100	70	50	50	
		Vf(mm/min)	318	637	446	255	159	289	579	405	231	145	398	796	557	318	199	367	735	514	294	184	398	796	557	318	199	
		fz(mm/t)	0.1	0.1	0.1	0.08	0.05	0.1	0.1	0.1	0.08	0.05	0.1	0.1	0.1	0.08	0.05	0.1	0.1	0.1	0.08	0.05	0.1	0.1	0.1	0.08	0.05	
		ap(mm)	0.1	0.1	0.1	0.1	0.1	0.1	0.1	0.1	0.1	0.1	0.1	0.1	0.1	0.1	0.1	0.1	0.1	0.1	0.1	0.1	0.1	0.1	0.1	0.1	0.1	0.1
		ae(mm)	5-10	5-10	5-10	5-10	5-10	5.5-11	5.5-11	5.5-11	5.5-11	5.5-11	6-12	6-12	6-12	6-12	6-12	6.5-13	6.5-13	6.5-13	6.5-13	6.5-13	8-16	8-16	8-16	8-16	8-16	
ステンレス鋼 Stainless steels SUS	TH308	n (min ⁻¹)	4,775	7,958	5,730	4,138	3,183	4,341	7,234	5,209	3,762	2,894	3,979	6,631	4,775	3,448	2,653	3,673	6,121	4,407	3,183	2,449	2,984	4,974	3,581	2,586	1,989	
		Vc(m/min)	150	250	180	130	100	150	250	180	130	100	150	250	180	130	100	150	250	180	130	100	150	250	180	130	100	
		Vf(mm/min)	955	2,387	1,719	993	637	868	2,170	1,563	903	579	1,194	2,984	2,149	1,241	796	1,102	2,755	1,983	1,146	735	1,194	2,984	2,149	1,241	796	
		fz(mm/t)	0.1	0.15	0.15	0.12	0.1	0.1	0.15	0.15	0.12	0.1	0.1	0.15	0.15	0.12	0.1	0.1	0.15	0.15	0.12	0.1	0.1	0.15	0.15	0.12	0.1	
		ap(mm)	0.2	0.2	0.2	0.2	0.2	0.2	0.2	0.2	0.2	0.2	0.2	0.2	0.2	0.2	0.2	0.2	0.2	0.2	0.2	0.2	0.2	0.2	0.2	0.2	0.2	0.2
		ae(mm)	5-10	5-10	5-10	5-10	5-10	5.5-11	5.5-11	5.5-11	5.5-11	5.5-11	6-12	6-12	6-12	6-12	6-12	6.5-13	6.5-13	6.5-13	6.5-13	6.5-13	8-16	8-16	8-16	8-16	8-16	
鋳鉄 Cast irons FC FCD	TH308	n (min ⁻¹)	4,775	7,958	6,366	4,775	4,138	4,341	7,234	5,787	4,341	3,762	3,979	6,631	5,305	3,979	3,448	3,673	6,121	4,897	3,673	3,183	2,984	4,974	3,979	2,984	2,586	
		Vc(m/min)	150	250	200	150	130	150	250	200	150	130	150	250	200	150	130	150	250	200	150	130	150	250	200	150	130	
		Vf(mm/min)	955	2,387	1,910	1,146	828	868	2,170	1,736	1,042	752	1,194	2,984	2,387	1,432	1,035	1,102	2,755	2,204	1,322	955	1,194	2,984	2,387	1,432	1,035	
		fz(mm/t)	0.1	0.15	0.15	0.12	0.1	0.1	0.15	0.15	0.12	0.1	0.1	0.15	0.15	0.12	0.1	0.1	0.15	0.15	0.12	0.1	0.1	0.15	0.15	0.12	0.1	
		ap(mm)	0.2	0.2	0.2	0.2	0.2	0.2	0.2	0.2	0.2	0.2	0.2	0.2	0.2	0.2	0.2	0.2	0.2	0.2	0.2	0.2	0.2	0.2	0.2	0.2	0.2	0.2
		ae(mm)	5-10	5-10	5-10	5-10	5-10	5.5-11	5.5-11	5.5-11	5.5-11	5.5-11	6-12	6-12	6-12	6-12	6-12	6.5-13	6.5-13	6.5-13	6.5-13	6.5-13	8-16	8-16	8-16	8-16	8-16	

【注意】 ①被削材、加工形状に合わせて、適切なクーラントを使用してください。
 ②この切削条件表は切削条件の目安を示すものです。実際の加工では加工形状、目的、使用機械等により条件を調整してください。
 ③溝切削、傾斜切削の場合、送り速度は70%を目安として下さい。
 ④インサートの交換は早めに行い、過度の使用による破損を防止して下さい。
 ⑤排出した切りくずは飛散し作業者を切傷させ、火傷あるいは目に入って負傷させる恐れがありますので、ご使用に際してはその周囲に安全カバーを取り付け保護めがね等の保護具を着用して、安全な環境で作業される事をお願いします。
 ⑥不水溶性切削油は、火災の恐れがありますので使用しないで下さい。

刃先交換式工具 スクエアエンドミル

アルファポリッシュミル Vタイプ ASPVmini

○ **バーチカル** Vertical cutting (※突き加工でのみご使用ください Use only in pushing-down direction.)

被削材 Work material	推奨 材種 Recommended grade	工具径 DC Tool dia.	φ 10(2枚刃) (2 Flutes)					φ 11(2枚刃) (2 Flutes)					φ 12(3枚刃) (3 Flutes)					φ 13(3枚刃) (3 Flutes)					φ 16(4枚刃) (4 Flutes)					
			突出し量 Overhang																									
			汎用 General purpose	高速加工 High-speed cutting	3DC -5DC	5DC -7DC	>7DC	汎用 General purpose	高速加工 High-speed cutting	3DC -5DC	5DC -7DC	>7DC	汎用 General purpose	高速加工 High-speed cutting	3DC -5DC	5DC -7DC	>7DC	汎用 General purpose	高速加工 High-speed cutting	3DC -5DC	5DC -7DC	>7DC	汎用 General purpose	高速加工 High-speed cutting	3DC -5DC	5DC -7DC	>7DC	
一般構造用鋼 Mild steels (200HB 以下) (200HB or less)	TH308	<i>n</i> (min ⁻¹)	9,549	19,099	12,732	12,732	9,549	8,681	17,362	11,575	11,575	8,681	7,958	15,915	10,610	10,610	7,958	7,346	14,691	9,794	9,794	7,346	5,968	11,937	7,958	7,958	5,968	
		Vc(m/min)	300	600	400	400	300	300	600	400	400	300	300	600	400	400	300	300	600	400	400	300	300	600	400	400	300	
		Vf(mm/min)	2,483	7,639	3,820	3,310	1,910	2,257	6,945	3,472	3,009	1,736	3,104	9,549	4,775	4,138	2,387	2,865	8,815	4,407	3,820	2,204	3,104	9,549	4,775	4,138	2,387	
		fz(mm/t)	0.13	0.2	0.15	0.13	0.1	0.13	0.2	0.15	0.13	0.1	0.13	0.2	0.15	0.13	0.1	0.13	0.2	0.15	0.13	0.1	0.13	0.2	0.15	0.13	0.1	
		pf(mm)	0.4	0.4	0.4	0.4	0.4	0.4	0.4	0.4	0.4	0.4	0.4	0.4	0.4	0.4	0.4	0.5	0.5	0.5	0.5	0.5	0.5	0.5	0.5	0.5	0.5	0.5
		ae(mm)	<0.2	<0.2	<0.2	<0.2	<0.2	<0.2	<0.2	<0.2	<0.2	<0.2	<0.2	<0.2	<0.2	<0.2	<0.2	<0.2	<0.2	<0.2	<0.2	<0.2	<0.2	<0.2	<0.2	<0.2	<0.2	
炭素鋼 合金鋼 Carbon steels Alloy steels (30HRC 以下) (30HRC or less)	TH308	<i>n</i> (min ⁻¹)	7,958	14,324	9,549	9,549	7,958	7,234	13,022	8,681	8,681	7,234	6,631	11,937	7,958	7,958	6,631	6,121	11,018	7,346	7,346	6,121	4,974	8,952	5,968	5,968	4,974	
		Vc(m/min)	250	450	300	300	250	250	450	300	300	250	250	450	300	300	250	250	450	300	300	250	250	450	300	300	250	
		Vf(mm/min)	2,069	5,730	2,865	2,483	1,592	1,881	5,209	2,604	2,257	1,447	2,586	7,162	3,581	3,104	1,989	2,387	6,611	3,306	2,865	1,836	2,586	7,162	3,581	3,104	1,989	
		fz(mm/t)	0.13	0.2	0.15	0.13	0.1	0.13	0.2	0.15	0.13	0.1	0.13	0.2	0.15	0.13	0.1	0.13	0.2	0.15	0.13	0.1	0.13	0.2	0.15	0.13	0.1	
		pf(mm)	0.4	0.4	0.4	0.4	0.4	0.4	0.4	0.4	0.4	0.4	0.4	0.4	0.4	0.4	0.4	0.5	0.5	0.5	0.5	0.5	0.5	0.5	0.5	0.5	0.5	0.5
		ae(mm)	<0.2	<0.2	<0.2	<0.2	<0.2	<0.2	<0.2	<0.2	<0.2	<0.2	<0.2	<0.2	<0.2	<0.2	<0.2	<0.2	<0.2	<0.2	<0.2	<0.2	<0.2	<0.2	<0.2	<0.2	<0.2	
炭素鋼 合金鋼 Carbon steels Alloy steels (30 ~ 45HRC)	TH308	<i>n</i> (min ⁻¹)	5,730	11,141	7,958	6,366	5,730	5,209	10,128	7,234	5,787	5,209	4,775	9,284	6,631	5,305	4,775	4,407	8,570	6,121	4,897	4,407	3,581	6,963	4,974	3,979	3,581	
		Vc(m/min)	180	350	250	200	180	180	350	250	200	180	180	350	250	200	180	180	350	250	200	180	180	350	250	200	180	
		Vf(mm/min)	1,146	2,674	1,910	1,273	917	1,042	2,431	1,736	1,157	833	1,432	3,342	2,387	1,592	1,146	1,322	3,085	2,204	1,469	1,058	1,432	3,342	2,387	1,592	1,146	
		fz(mm/t)	0.1	0.12	0.12	0.1	0.08	0.1	0.12	0.12	0.1	0.08	0.1	0.12	0.12	0.1	0.08	0.1	0.12	0.12	0.1	0.08	0.1	0.12	0.12	0.1	0.08	
		pf(mm)	0.4	0.4	0.4	0.4	0.4	0.4	0.4	0.4	0.4	0.4	0.4	0.4	0.4	0.4	0.4	0.5	0.5	0.5	0.5	0.5	0.5	0.5	0.5	0.5	0.5	
		ae(mm)	<0.2	<0.2	<0.2	<0.2	<0.2	<0.2	<0.2	<0.2	<0.2	<0.2	<0.2	<0.2	<0.2	<0.2	<0.2	<0.2	<0.2	<0.2	<0.2	<0.2	<0.2	<0.2	<0.2	<0.2	<0.2	
焼入れ鋼 Hardened steels (45 ~ 55HRC)	TH308	<i>n</i> (min ⁻¹)	3,820	6,366	5,730	4,775	3,820	3,472	5,787	5,209	4,341	3,472	3,183	5,305	4,775	3,979	3,183	2,938	4,897	4,407	3,673	2,938	2,387	3,979	3,581	2,984	2,387	
		Vc(m/min)	120	200	180	150	120	120	200	180	150	120	120	200	180	150	120	120	200	180	150	120	120	200	180	150	120	
		Vf(mm/min)	764	1,273	1,146	764	611	694	1,157	1,042	694	556	955	1,592	1,432	955	764	881	1,469	1,322	881	705	955	1,592	1,432	955	764	
		fz(mm/t)	0.1	0.1	0.1	0.08	0.08	0.1	0.1	0.1	0.08	0.08	0.1	0.1	0.1	0.08	0.08	0.1	0.1	0.1	0.08	0.08	0.1	0.1	0.1	0.08	0.08	
		pf(mm)	0.4	0.4	0.4	0.4	0.4	0.4	0.4	0.4	0.4	0.4	0.4	0.4	0.4	0.4	0.4	0.5	0.5	0.5	0.5	0.5	0.5	0.5	0.5	0.5	0.5	
		ae(mm)	<0.2	<0.2	<0.2	<0.2	<0.2	<0.2	<0.2	<0.2	<0.2	<0.2	<0.2	<0.2	<0.2	<0.2	<0.2	<0.2	<0.2	<0.2	<0.2	<0.2	<0.2	<0.2	<0.2	<0.2	<0.2	
焼入れ鋼 Hardened steels (55 ~ 62HRC)	TH308	<i>n</i> (min ⁻¹)	3,183	5,730	4,775	3,820	3,183	2,894	5,209	4,341	3,472	2,894	2,653	4,775	3,979	3,183	2,653	2,449	4,407	3,673	2,938	2,449	1,989	3,581	2,984	2,387	1,989	
		Vc(m/min)	100	180	150	120	100	100	180	150	120	100	100	180	150	120	100	100	180	150	120	100	100	180	150	120	100	
		Vf(mm/min)	637	1,146	955	611	318	579	1,042	868	556	289	796	1,432	1,194	764	398	735	1,322	1,102	705	367	796	1,432	1,194	764	398	
		fz(mm/t)	0.1	0.1	0.1	0.08	0.05	0.1	0.1	0.1	0.08	0.05	0.1	0.1	0.1	0.08	0.05	0.1	0.1	0.1	0.08	0.05	0.1	0.1	0.1	0.08	0.05	
		pf(mm)	0.4	0.4	0.4	0.4	0.4	0.4	0.4	0.4	0.4	0.4	0.4	0.4	0.4	0.4	0.4	0.5	0.5	0.5	0.5	0.5	0.5	0.5	0.5	0.5	0.5	
		ae(mm)	<0.2	<0.2	<0.2	<0.2	<0.2	<0.2	<0.2	<0.2	<0.2	<0.2	<0.2	<0.2	<0.2	<0.2	<0.2	<0.2	<0.2	<0.2	<0.2	<0.2	<0.2	<0.2	<0.2	<0.2	<0.2	
ステンレス鋼 Stainless steels SUS	TH308	<i>n</i> (min ⁻¹)	7,958	14,324	9,549	9,549	7,958	7,234	13,022	8,681	8,681	7,234	6,631	11,937	7,958	7,958	6,631	6,121	11,018	7,346	7,346	6,121	4,974	8,952	5,968	5,968	4,974	
		Vc(m/min)	250	450	300	300	250	250	450	300	300	250	250	450	300	300	250	250	450	300	300	250	250	450	300	300	250	
		Vf(mm/min)	1,592	4,297	2,865	2,292	1,592	1,447	3,907	2,604	2,083	1,447	1,989	5,371	3,581	2,865	1,989	1,836	4,958	3,306	2,644	1,836	1,989	5,371	3,581	2,865	1,989	
		fz(mm/t)	0.1	0.15	0.15	0.12	0.1	0.1	0.15	0.15	0.12	0.1	0.1	0.15	0.15	0.12	0.1	0.1	0.15	0.15	0.12	0.1	0.1	0.15	0.15	0.12	0.1	
		pf(mm)	0.4	0.4	0.4	0.4	0.4	0.4	0.4	0.4	0.4	0.4	0.4	0.4	0.4	0.4	0.4	0.5	0.5	0.5	0.5	0.5	0.5	0.5	0.5	0.5	0.5	
		ae(mm)	<0.2	<0.2	<0.2	<0.2	<0.2	<0.2	<0.2	<0.2	<0.2	<0.2	<0.2	<0.2	<0.2	<0.2	<0.2	<0.2	<0.2	<0.2	<0.2	<0.2	<0.2	<0.2	<0.2	<0.2	<0.2	
鋳鉄 Cast irons FC FCD	TH308	<i>n</i> (min ⁻¹)	7,958	14,324	12,732	11,141	9,549	7,234	13,022	11,575	10,128	8,681	6,631	11,937	10,610	9,284	7,958	6,121	11,018	9,794	8,570	7,346	4,974	8,952	7,958	6,963	5,968	
		Vc(m/min)	250	450	400	350	300	250	450	400	350	300	250	450	400	350	300	250	450	400	350	300	250	450	400	350	300	
		Vf(mm/min)	1,592	4,297	3,820	2,674	1,910	1,447	3,907	3,472	2,431	1,736	1,989	5,371	4,775	3,342	2,387	1,836	4,958	4,407	3,085	2,204	1,989	5,371	4,775	3,342	2,387	
		fz(mm/t)	0.1	0.15	0.15	0.12	0.1	0.1	0.15	0.15	0.12	0.1	0.1	0.15	0.15	0.12	0.1	0.1	0.15	0.15	0.12	0.1	0.1	0.15	0.15	0.12	0.1	
		pf(mm)	0.4	0.4	0.4	0.4	0.4	0.4	0.4	0.4	0.4	0.4	0.4	0.4	0.4	0.4	0.4	0.5	0.5	0.5	0.5	0.5	0.5	0.5	0.5	0.5	0.5	
		ae(mm)	<0.2	<0.2	<0.2	<0.2	<0.2	<0.2	<0.2	<0.2	<0.2	<0.2	<0.2	<0.2	<0.2	<0.2	<0.2	<0.2	<0.2	<0.2	<0.2	<0.2	<0.2	<0.2	<0.2	<0.2	<0.2	

- 【注意】**
- ①被削材、加工形状に合わせて、適切なクーラントを使用してください。
 - ②この切削条件表は切削条件の目安を示すものです。実際の加工では加工形状、目的、使用機械等により条件を調整してください。
 - ③インサートの交換は早めに行い、過度の使用による破損を防止して下さい。
 - ④排出した切りくずは飛散し作業者を切傷させ、火傷あるいは目に入ると負傷させる恐れがありますので、ご使用に際してはその周囲に安全カバーを取り付け保護めがね等の保護具を着用して、安全な環境で作業される事をお願い致します。
 - ⑤不水溶性切削油は、火災の恐れがありますので使用しないで下さい。

アルファポリッシュミル Vタイプ ASPV

- 底面や側面などの構造部分の仕上げ加工用途に適したカッタです。
- 多刃仕様により送り速度を上げる能率の高い仕上げ加工が可能です。
- 機械の主軸方向へ切削送りをかけるバーチカル加工もできます。

- ・ Ideal cutter for applications finishing structural parts of bottom, side, etc.
- ・ Multi-flute specifications enable higher feed rates for more efficient finishing.
- ・ Vertical machining in which cutting feed is in the direction of the machine's main axis can also be performed.

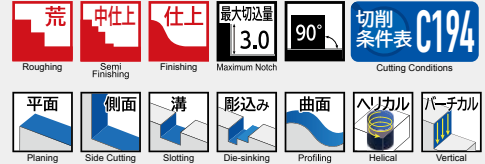

ASPVS2○○○R-○ ストレートシャンクタイプ Straight shank type

○は数字が入ります。 Numeric figure in a circle ○

商品コード Item code		在庫 Stock	刃数 No. of flute	寸法 Size (mm)						適用インサート Inserts	希望小売価格(円) Suggested retail price (¥)
				DC	LF	DCONMS	D1	LH	LS		
シャンクタイプ Shank type	ASPVS2016R-2	●	2	16	100	16	14.5	30	70	MPHW0603○○ZEL MPHW06030○ZEL-○○ MPHW0603○○ZFL MPNW0603○○ZEL	36,950
	ASPVS2020R-3	●	3	20	110	20	18	30	80		47,640
	ASPVS2025R-4	●	4	25	120	25	23	40	80		57,480
	ASPVS2030R-4	●	4	30	150	32	28	50	100		60,660
	ASPVS2032R-5	●	5	32	150	32	30	50	100		68,400
	ASPVS2035R-5	●	5	35	150	32	31	50	100		68,400
	ASPVS2040R-6	●	6	40	170	32	31	50	120		78,720

ASPVM20○○○R-○ モジュラータイプ Modular type

○は数字が入ります。 Numeric figure in a circle ○

モジュラーミル用シャンクはD2頁を、締め付けトルクについてはD5頁を参照ください。
Refer page D2 about the shanks for Modular Mill, Refer page D5 about tightening torque

商品コード Item code		在庫 Stock	刃数 No. of flute	寸法 Size (mm)							適用インサート Inserts	希望小売価格 (円) Suggested retail price (¥)	
				DC	LF	DCONMS	THSZMS	DHUB	L1	L2			DRVS
モジュラー Modular	ASPVM2016R-2	●	2	16	25	8.5	M8	12.8	5.5	17	10	MPHW0603○○ZEL MPHW06030○ZEL-○○ MPNW0603○○ZEL	36,950
	※ ASPVM2018R-2	●	2	18	25	8.5	M8	14.5	5.5	17	10		36,950
	ASPVM2020R-2	●	2	20	30	10.5	M10	17.8	5.5	19	15		43,530
	ASPVM2020R-3	●	3	20	30	10.5	M10	17.8	5.5	19	15		47,640
	ASPVM2022R-2		2	22	30	10.5	M10	17.8	5.5	19	15		—
	※ ASPVM2022R-3	●	3	22	30	10.5	M10	17.8	5.5	19	15		47,640
	ASPVM2025R-3		3	25	35	12.5	M12	20.8	5.5	22	17		—
	ASPVM2025R-4	●	4	25	35	12.5	M12	20.8	5.5	22	17		57,480
	ASPVM2028R-3		3	28	35	12.5	M12	23	5.5	22	17		—
	※ ASPVM2028R-4	●	4	28	35	12.5	M12	23	5.5	22	17		57,480
	ASPVM2030R-3		3	30	40	17	M16	28.8	6	23	22		—
	ASPVM2030R-4	●	4	30	40	17	M16	28.8	6	23	22		60,660
	ASPVM2032R-3	●	3	32	40	17	M16	28.8	6	23	22		64,290
	ASPVM2032R-5	●	5	32	40	17	M16	28.8	6	23	22		68,400
	ASPVM2035R-3		3	35	40	17	M16	28.8	6	23	22		—
	※ ASPVM2035R-5	●	5	35	40	17	M16	28.8	6	23	22		68,400
	※ ASPVM2040R-3		3	40	40	17	M16	28.8	6	23	22		—
※ ASPVM2040R-6	●	6	40	40	17	M16	28.8	6	23	22	78,720		

【注意】※と超硬シャンクをセットで使用すると干渉がありません。
モジュラーミル及び専用シャンク、専用アーバの「工具端面」「モジュラーねじ部」にグリースなどの潤滑剤は塗布しないでください。

【Note】 When ※ and carbide shank are used together as a set, there is no interference.
Do not apply lubricants such as grease, etc. to the "contact faces" and "modular screws" of the "modular mill", "dedicated shanks" and "dedicated arbor".

●印：標準在庫品です。 ●：Stocked items. 無印：弊社営業へお問合せください。 No mark：Contact with our sales department.

ASPVB2○○○R(M)-○ ボアタイプ Bore type

○は数字が入ります。 Numeric figure in a circle ○

ボアタイプ用アーバはD11頁を参照ください。
Refer page D11 about the bore type arbor

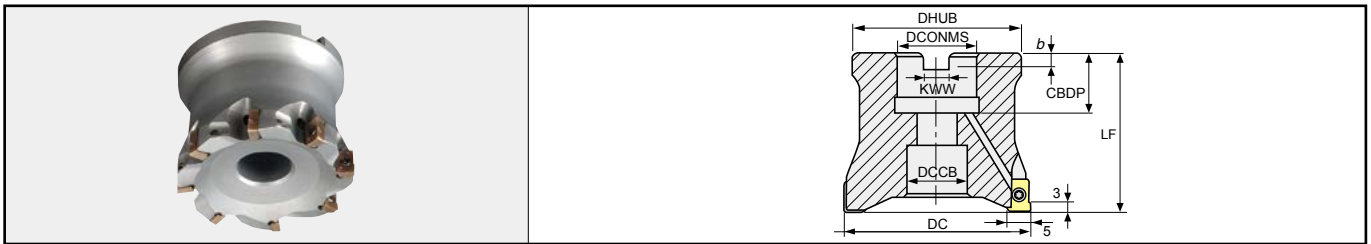

商品コード Item code	在庫 Stock	刃数 No. of flute	寸法 Size (mm)								適用インサート Inserts	希望小売価格(円) Suggested retail price (¥)
			DC	DHUB	LF	CDBP	KWW	b	DCONMS	DCCB		
内径インチ Inside diameter inch size	●	7	50	47	50	19	8.4	5	22.225	17	MPHW0603○○○ZEL MPHW0603○○○ZEL-○○○	96,780
	●	8	63	60	50	19	8.4	5	22.225	17		
内径ミリ Inside diameter mm size	●	7	50	47	50	20	10.4	6.3	22	17	MPHW0603○○○ZFL MPNW0603○○○ZEL	96,780
	●	8	63	60	50	20	10.4	6.3	22	17		

【注意】アーバ用ねじは付属しません。 【Note】 Arbor screw is not included.

インサート Inserts

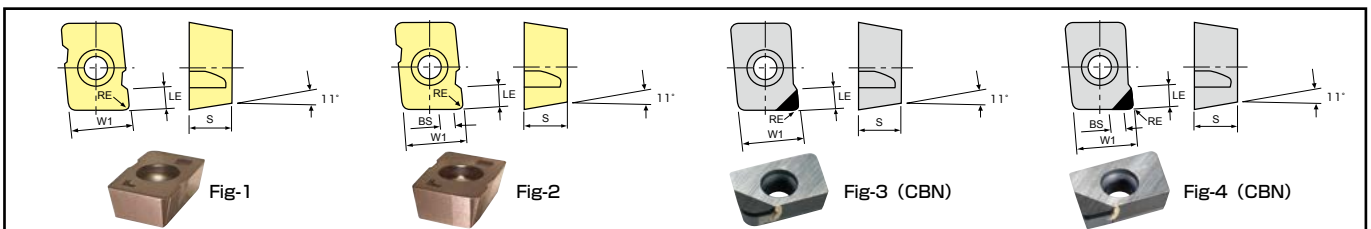

材料	鋼	SUS等	FC・FCD	アルミニウム合金	チタン合金	高硬度材
鋼	■	■	■	■	■	■
SUS等	■	■	■	■	■	■
FC・FCD	■	■	■	■	■	■
アルミニウム合金	■	■	■	■	■	■
チタン合金	■	■	■	■	■	■
高硬度材	■	■	■	■	■	■

■: 一般切削・第一推奨 (General cutting, First recommended)
□: 一般切削・第二推奨 (General cutting, Second recommended)

商品コード Item code	精度 Tolerance class	コーティング							寸法 Size (mm)					形状 Shape	希望小売価格(円) Suggested retail price (¥)	
		AJ Coating	JS Coating	Coated Cermet	TH Coating	CBN	DLC Coating	W1	BS	S	LE	RE	JP4105 JP4120 JM4160 JS4060 MZ1000 ATH08M		SD5010 BH250	
MPHW060302ZEL	H級 H							6.35	-	3.18	3	0.2	Fig-1	1,430	—	
MPHW060302ZEL-0.5								6.35	0.5	3.18	3	0.2	Fig-2	1,430	—	
MPHW060304ZEL								6.35	-	3.18	3	0.4	Fig-1	1,430	—	
MPHW060304ZEL-0.5								6.35	0.5	3.18	3	0.4	Fig-2	1,430	—	
MPHW060304ZFL							●	6.35	-	3.18	3	0.4	Fig-1	—	2,010	
MPHW060308ZEL			●			●	●	6.35	-	3.18	3	0.8	Fig-1	1,430	—	
MPHW060308ZEL-1.5			●	●		●	●	6.35	1.5	3.18	3	0.8	Fig-2,4	1,430	22,440	
MPHW060308ZFL							●	6.35	-	3.18	3	0.8	Fig-1	—	2,010	
MPHW060320ZEL	N級 N				●	●	6.35	-	3.18	3	2	Fig-1,3	1,430	22,440		
MPNW060308ZEL			●	●	●		6.35	-	3.18	3	0.8	Fig-1,3	1,100	—		
MPNW060320ZEL			●	●	●		6.35	-	3.18	3	2	Fig-1,3	1,100	—		

【注意】JSコーティングは通電式タッチセンサーに反応しませんのでご注意ください。 【Note】 Please note that the JS Coating does not cause a reaction in conductive touch sensors.

部品番号 Parts

○は数字が入ります。 Numeric figure in a circle ○

部品名 Parts	クラップねじ Clamp screw	ドライバー Screw driver	ねじ焼き付き防止剤 Screw anti-seizure agent	
適用カット Cutter body	形状 Shape	希望小売価格 (円) Suggested retail price (¥)	希望小売価格 (円) Suggested retail price (¥)	
モジュラー Modular	ASPVM2○○○R-○	250-141	1.1	
シャンク Shank	ASPVS2○○○R-○			870
ボア Bore	ASPVB2○○○R-○ ASPVB2○○○RM-○			
		希望小売価格 (円) Suggested retail price (¥)	希望小売価格 (円) Suggested retail price (¥)	
		1,800	P-37	
			1,010	

【注意】各切れ刃にエア、切削油剤を供給する場合は上記アーバ用ねじをご使用下さい。 【Note】 When supplying air and cutting agent to each flute, please use the arbor screws listed above. The clamp screw is a consumable part. Since replacement life depends on the use environment, it is recommended that it be replaced at an early stage. One spare clamp screw is provided for cutter bodies with 3 or less flutes, and two for 4 or more flutes.

アルファポリッシュミル Vタイプ ASPV

標準切削条件表 Recommended cutting conditions

底面仕上げ標準切削条件 Standard cutting conditions for bottom finishing

※赤字は第一推奨材種です。
Red indicates primary recommended grade.

被削材 Work material	推奨材種 Recommended grade	工具径DC Tool dia.	φ16(2枚刃) 2 Flutes					φ20(3枚刃) 3 Flutes					φ25(4枚刃) 4 Flutes					
			突出し量 Overhang	<3DC		モジュラー超硬シャング Modular carbide shank			<3DC		モジュラー超硬シャング Modular carbide shank			<3DC		モジュラー超硬シャング Modular carbide shank		
				汎用 General purpose	高速加工 High-speed cutting	3DC-5DC	5DC-7DC	>7DC	汎用 General purpose	高速加工 High-speed cutting	3DC-5DC	5DC-7DC	>7DC	汎用 General purpose	高速加工 High-speed cutting	3DC-5DC	5DC-7DC	>7DC
一般構造用鋼 (200HB以下) Mild steels (200HB or less)	※ MZ1000 ATH08M JP4120 JS4060	n (min ⁻¹)	2,990	5,980	3,990	2,990	2,590	2,390	4,780	3,190	2,390	2,080	1,920	3,830	2,550	1,920	1,660	
		vc (m/min)	150	300	200	150	130	150	300	200	150	130	150	300	200	150	130	
		vf (mm/min)	600	1,800	1,200	720	520	720	2,160	1,440	870	630	770	2,300	1,530	930	670	
		fz (mm/t)	0.1	0.15	0.15	0.12	0.1	0.1	0.15	0.15	0.12	0.1	0.1	0.15	0.15	0.12	0.1	
		ap (mm)	0.2	0.2	0.2	0.2	0.2	0.2	0.2	0.2	0.2	0.2	0.2	0.2	0.2	0.2	0.2	
		ae (mm)	8~16	8~16	8~16	8~16	8	10~20	10~20	10~20	10~20	10	12.5~25	12.5~25	12.5~25	12.5~25	12.5	
炭素鋼 合金鋼 (30HRC以下) Carbon steels Alloy steels (30HRC or less)	MZ1000 ATH08M JP4120 JS4060	n (min ⁻¹)	2,990	4,980	3,590	2,590	2,000	2,390	3,990	2,870	2,080	1,600	1,920	3,190	2,300	1,660	1,280	
		vc (m/min)	150	250	180	130	100	150	250	180	130	100	150	250	180	130	100	
		vf (mm/min)	600	1,500	1,080	630	400	720	1,800	1,300	750	480	770	1,920	1,380	800	520	
		fz (mm/t)	0.1	0.15	0.15	0.12	0.1	0.1	0.15	0.15	0.12	0.1	0.1	0.15	0.15	0.12	0.1	
		ap (mm)	0.2	0.2	0.2	0.2	0.2	0.2	0.2	0.2	0.2	0.2	0.2	0.2	0.2	0.2	0.2	
		ae (mm)	8~16	8~16	8~16	8~16	8	10~20	10~20	10~20	10~20	10	12.5~25	12.5~25	12.5~25	12.5~25	12.5	
炭素鋼 合金鋼 (30~45HRC) Carbon steels Alloy steels	ATH08M JP4120 JS4060	n (min ⁻¹)	2,590	3,990	3,190	2,590	1,800	2,080	3,190	2,550	2,080	1,440	1,660	2,550	2,040	1,660	1,150	
		vc (m/min)	130	200	160	130	90	130	200	160	130	90	130	200	160	130	90	
		vf (mm/min)	520	960	770	520	360	630	1,150	920	630	440	670	1,230	980	670	460	
		fz (mm/t)	0.1	0.12	0.12	0.1	0.1	0.1	0.12	0.12	0.1	0.1	0.1	0.12	0.12	0.1	0.1	
		ap (mm)	0.2	0.2	0.2	0.2	0.2	0.2	0.2	0.2	0.2	0.2	0.2	0.2	0.2	0.2	0.2	
		ae (mm)	8~16	8~16	8~16	8~16	8	10~20	10~20	10~20	10~20	10	12.5~25	12.5~25	12.5~25	12.5~25	12.5	
ステンレス鋼 SUS Stainless steels	JP4120 JM4160 ATH08M	n (min ⁻¹)	2,990	4,980	3,590	2,590	2,000	2,390	3,990	2,870	2,080	1,600	1,920	3,190	2,300	1,660	1,280	
		vc (m/min)	150	250	180	130	100	150	250	180	130	100	150	250	180	130	100	
		vf (mm/min)	600	1,500	1,080	630	400	720	1,800	1,300	750	480	770	1,920	1,380	800	520	
		fz (mm/t)	0.1	0.15	0.15	0.12	0.1	0.1	0.15	0.15	0.12	0.1	0.1	0.15	0.15	0.12	0.1	
		ap (mm)	0.2	0.2	0.2	0.2	0.2	0.2	0.2	0.2	0.2	0.2	0.2	0.2	0.2	0.2	0.2	
		ae (mm)	8~16	8~16	8~16	8~16	8	10~20	10~20	10~20	10~20	10	12.5~25	12.5~25	12.5~25	12.5~25	12.5	
鋳鉄 FC FCD Cast irons	ATH08M JP4120 JS4060	n (min ⁻¹)	2,990	4,980	3,990	2,990	2,590	2,390	3,990	3,190	2,390	2,080	1,920	3,190	2,550	1,920	1,660	
		vc (m/min)	150	250	200	150	130	150	250	200	150	130	150	250	200	150	130	
		vf (mm/min)	600	2,000	1,600	900	520	720	2,400	1,920	1,080	630	770	2,560	2,040	1,160	670	
		fz (mm/t)	0.1	0.2	0.2	0.15	0.1	0.1	0.2	0.2	0.15	0.1	0.1	0.2	0.2	0.15	0.1	
		ap (mm)	0.2	0.2	0.2	0.2	0.2	0.2	0.2	0.2	0.2	0.2	0.2	0.2	0.2	0.2	0.2	
		ae (mm)	8~16	8~16	8~16	8~16	8	10~20	10~20	10~20	10~20	10	12.5~25	12.5~25	12.5~25	12.5~25	12.5	
アルミニウム合金 Aluminum alloys	SD5010	n (min ⁻¹)	11,950	23,890	15,930	11,950	11,950	9,560	19,110	12,740	9,560	9,560	7,650	15,290	10,200	7,650	7,650	
		vc (m/min)	600	1,200	800	600	600	600	1,200	800	600	600	600	1,200	800	600	600	
		vf (mm/min)	2,390	7,170	4,780	2,870	2,390	2,870	8,600	5,740	3,450	2,870	3,060	9,180	6,120	3,680	3,060	
		fz (mm/t)	0.1	0.15	0.15	0.12	0.1	0.1	0.15	0.15	0.12	0.1	0.1	0.15	0.15	0.12	0.1	
		ap (mm)	0.2	0.2	0.2	0.2	0.2	0.2	0.2	0.2	0.2	0.2	0.2	0.2	0.2	0.2	0.2	
		ae (mm)	8~16	8~16	8~16	8~16	8	10~20	10~20	10~20	10~20	10	12.5~25	12.5~25	12.5~25	12.5~25	12.5	
チタン合金 Ti-6Al-4V (湿式切削) Titanium alloys (wet condition)	ATH08M JP4120	n (min ⁻¹)	600	1,200	1,000	600	600	480	960	800	480	480	390	770	640	390	390	
		vc (m/min)	30	60	50	30	30	30	60	50	30	30	30	60	50	30	30	
		vf (mm/min)	120	360	300	120	120	150	440	360	150	150	160	470	390	160	160	
		fz (mm/t)	0.1	0.15	0.15	0.1	0.1	0.1	0.15	0.15	0.1	0.1	0.1	0.15	0.15	0.1	0.1	
		ap (mm)	0.2	0.2	0.2	0.2	0.2	0.2	0.2	0.2	0.2	0.2	0.2	0.2	0.2	0.2	0.2	
		ae (mm)	8~16	8~16	8~16	8~16	8	10~20	10~20	10~20	10~20	10	12.5~25	12.5~25	12.5~25	12.5~25	12.5	
焼入れ鋼 45~55HRC Hardened steels	JP4105 ATH08M JP4120	n (min ⁻¹)	1,600	2,390	2,000	1,600	1,600	1,280	1,920	1,600	1,280	1,280	1,020	1,530	1,280	1,020	1,020	
		vc (m/min)	80	120	100	80	80	80	120	100	80	80	80	120	100	80	80	
		vf (mm/min)	320	480	400	320	320	390	580	480	390	390	410	620	520	410	410	
		fz (mm/t)	0.1	0.1	0.1	0.1	0.1	0.1	0.1	0.1	0.1	0.1	0.1	0.1	0.1	0.1	0.1	
		ap (mm)	0.2	0.2	0.2	0.2	0.2	0.2	0.2	0.2	0.2	0.2	0.2	0.2	0.2	0.2	0.2	
		ae (mm)	8~16	8~16	8~16	8~16	8	10~20	10~20	10~20	10~20	10	12.5~25	12.5~25	12.5~25	12.5~25	12.5	
焼入れ鋼 55~62HRC Hardened steels	JP4105 ATH08M JP4120	n (min ⁻¹)	1,000	2,000	1,400	1,000	1,000	800	1,600	1,120	800	800	640	1,280	900	640	640	
		vc (m/min)	50	100	70	50	50	50	100	70	50	50	50	100	70	50	50	
		vf (mm/min)	100	280	200	100	100	120	340	240	120	120	130	360	260	130	130	
		fz (mm/t)	0.05	0.07	0.07	0.05	0.05	0.05	0.07	0.07	0.05	0.05	0.05	0.07	0.07	0.05	0.05	
		ap (mm)	0.2	0.2	0.2	0.2	0.2	0.2	0.2	0.2	0.2	0.2	0.2	0.2	0.2	0.2	0.2	
		ae (mm)	8~16	8~16	8~16	8~16	8	10~20	10~20	10~20	10~20	10	12.5~25	12.5~25	12.5~25	12.5~25	12.5	

- 【注意】
- この切削条件表は切削条件の目安を示すものです。実際の加工では加工形状、目的、使用機械等により条件を調整してください。
 - 切りくず噛み込みによる工具損傷防止のため、必ずエアブロー等による切りくず除去を行って下さい。
 - 排出した切りくずは、飛散し作業者を切傷させ、火傷あるいは目に入ると負傷させる恐れがありますので、ご使用に際してはその周囲に安全カバーを取付け、保護メガネ等の保護具を着用し、安全な環境で作業されることをお願い致します。
 - JSコーティングは通電式タッチセンサーに反応しませんのでご注意ください。
 - インサートの交換は早めに行い、過度の使用による破損を防止してください。
 - 切込み深さ及び1刃送り量の最大値を超えないように設定してください。
 - MZ1000, BH250は湿式切削には適しません。乾式(エアブロー)での使用をお願いします。
 - 不水溶性切削油は、火災の恐れがありますので使用しないで下さい。
 - モジュラーミル用BT30アーバご使用の際は、標準切削条件表を目安に加工条件を決定して下さい。加工状況により振動が懸念される場合は、1.切込み深さ(ap)を低減する、2.一刃当りの送り(fz)を低減する方法で調整下さい。

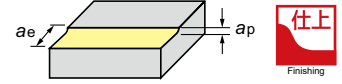

φ32(5枚刃) 5 Flutes					φ40(6枚刃) 6 Flutes					φ50(7枚刃) 7 Flutes					φ63(8枚刃) 8 Flutes					被削材 Work material
<3DC		モジュラー超硬シャンク Modular carbide shank			<3DC		モジュラー超硬シャンク Modular carbide shank			<3DC		3DC-5DC	5DC-7DC	>7DC	<3DC		3DC-5DC	5DC-7DC	>7DC	
汎用 General purpose	高速加工 High-speed cutting	3DC-5DC	5DC-7DC	>7DC	汎用 General purpose	高速加工 High-speed cutting	3DC-5DC	5DC-7DC	>7DC	汎用 General purpose	高速加工 High-speed cutting	3DC-5DC	5DC-7DC	>7DC	汎用 General purpose	高速加工 High-speed cutting	3DC-5DC	5DC-7DC	>7DC	
1,500	2,990	2,000	1,500	1,300	1,200	2,390	1,600	1,200	1,040	960	1,600	1,280	960	830	760	1,270	1,020	760	660	一般構造用鋼 (200HB以下) Mild steels (200HB or less)
150	300	200	150	130	150	300	200	150	130	150	250	200	150	130	150	250	200	150	130	
750	2,250	1,500	900	650	720	2,160	1,160	720	630	680	1,680	1,350	810	590	610	1,530	1,230	730	530	
0.1	0.15	0.15	0.12	0.1	0.1	0.15	0.12	0.1	0.1	0.1	0.15	0.15	0.12	0.1	0.1	0.15	0.15	0.12	0.1	
0.2	0.2	0.2	0.2	0.2	0.2	0.2	0.2	0.2	0.2	0.2	0.2	0.2	0.2	0.2	0.2	0.2	0.2	0.2	0.2	
16~32	16~32	16~32	16~32	16	20~40	20~40	20~40	20~40	20	25~50	25~50	25~50	25~50	25	31~63	31~63	31~63	31~63	31	
1,500	2,490	1,800	1,300	1,000	1,200	2,000	1,440	1,040	800	960	1,470	1,150	830	640	760	1,170	910	660	510	炭素鋼 合金鋼 (30HRC以下) Carbon steels Alloy steels (30HRC or less)
150	250	180	130	100	150	250	180	130	100	150	230	180	130	100	150	230	180	130	100	
750	1,870	1,350	780	500	720	1,800	1,040	630	480	680	1,550	1,210	700	450	610	1,410	1,100	640	410	
0.1	0.15	0.15	0.12	0.1	0.1	0.15	0.12	0.1	0.1	0.1	0.15	0.15	0.12	0.1	0.1	0.15	0.15	0.12	0.1	
0.2	0.2	0.2	0.2	0.2	0.2	0.2	0.2	0.2	0.2	0.2	0.2	0.2	0.2	0.2	0.2	0.2	0.2	0.2	0.2	
16~32	16~32	16~32	16~32	16	20~40	20~40	20~40	20~40	20	25~50	25~50	25~50	25~50	25	31~63	31~63	31~63	31~63	31	
1,300	2,000	1,600	1,300	900	1,040	1,600	1,280	1,040	720	830	1,150	960	830	580	660	910	760	660	460	炭素鋼 合金鋼 (30~45HRC) Carbon steels Alloy steels
130	200	160	130	90	130	200	160	130	90	130	180	150	130	90	130	180	150	130	90	
650	1,200	960	650	450	630	1,160	930	630	440	590	970	810	700	410	530	880	730	530	370	
0.1	0.12	0.12	0.1	0.1	0.1	0.12	0.12	0.1	0.1	0.1	0.12	0.12	0.12	0.1	0.1	0.12	0.12	0.1	0.1	
0.2	0.2	0.2	0.2	0.2	0.2	0.2	0.2	0.2	0.2	0.2	0.2	0.2	0.2	0.2	0.2	0.2	0.2	0.2	0.2	
16~32	16~32	16~32	16~32	16	20~40	20~40	20~40	20~40	20	25~50	25~50	25~50	25~50	25	31~63	31~63	31~63	31~63	31	
1,500	2,490	1,800	1,300	1,000	1,200	2,000	1,440	1,040	800	960	1,470	1,150	830	640	760	1,170	910	660	510	ステンレス鋼 SUS Stainless steels
150	250	180	130	100	150	250	180	130	100	150	230	180	130	100	150	230	180	130	100	
750	1,870	1,350	780	500	720	1,800	1,040	630	480	680	1,550	1,210	700	450	610	1,410	1,100	640	410	
0.1	0.15	0.15	0.12	0.1	0.1	0.15	0.12	0.1	0.1	0.1	0.15	0.15	0.12	0.1	0.1	0.15	0.15	0.12	0.1	
0.2	0.2	0.2	0.2	0.2	0.2	0.2	0.2	0.2	0.2	0.2	0.2	0.2	0.2	0.2	0.2	0.2	0.2	0.2	0.2	
16~32	16~32	16~32	16~32	16	20~40	20~40	20~40	20~40	20	25~50	25~50	25~50	25~50	25	31~63	31~63	31~63	31~63	31	
1,500	2,490	2,000	1,500	1,300	1,200	2,000	1,600	1,200	1,040	960	1,600	1,280	960	830	760	1,270	1,020	760	660	鋳鉄 FC FCD Cast irons
150	250	200	150	130	150	250	200	150	130	150	250	200	150	130	150	250	200	150	130	
750	2,490	2,000	1,130	650	720	2,400	1,920	1,080	630	680	2,240	1,800	1,010	590	610	2,040	1,640	920	530	
0.1	0.2	0.2	0.15	0.1	0.1	0.2	0.2	0.15	0.1	0.1	0.2	0.2	0.15	0.1	0.1	0.2	0.2	0.15	0.1	
0.2	0.2	0.2	0.2	0.2	0.2	0.2	0.2	0.2	0.2	0.2	0.2	0.2	0.2	0.2	0.2	0.2	0.2	0.2	0.2	
16~32	16~32	16~32	16~32	16	20~40	20~40	20~40	20~40	20	25~50	25~50	25~50	25~50	25	31~63	31~63	31~63	31~63	31	
5,980	11,950	7,970	5,980	5,980	4,780	9,560	6,370	4,780	4,780	3,830	9,560	6,370	3,830	3,830	3,040	7,590	5,060	3,040	3,040	アルミニウム合金 Aluminum alloys
600	1,200	800	600	600	600	1,200	800	600	600	600	1,500	1,000	600	600	600	1,500	1,000	600	600	
2,990	8,970	5,980	3,590	2,990	2,870	8,610	5,740	3,450	2,870	2,690	10,040	6,690	3,220	3,220	2,440	9,110	6,080	2,920	2,920	
0.1	0.15	0.15	0.12	0.1	0.1	0.15	0.15	0.12	0.1	0.1	0.15	0.15	0.12	0.12	0.1	0.15	0.15	0.12	0.12	
0.2	0.2	0.2	0.2	0.2	0.2	0.2	0.2	0.2	0.2	0.2	0.2	0.2	0.2	0.2	0.2	0.2	0.2	0.2	0.2	
16~32	16~32	16~32	16~32	16	20~40	20~40	20~40	20~40	20	25~50	25~50	25~50	25~50	25	31~63	31~63	31~63	31~63	31	
300	600	500	300	300	240	480	400	240	240	200	390	320	200	200	160	310	260	160	160	チタン合金 Ti-6Al-4V (湿式切削) Titanium alloys (wet condition)
30	60	50	30	30	30	60	50	30	30	30	60	50	30	30	30	60	50	30	30	
150	450	380	150	150	150	440	360	150	150	140	410	340	170	140	130	380	320	160	130	
0.1	0.15	0.15	0.1	0.1	0.1	0.15	0.15	0.1	0.1	0.1	0.15	0.15	0.12	0.1	0.1	0.15	0.15	0.12	0.1	
0.2	0.2	0.2	0.2	0.2	0.2	0.2	0.2	0.2	0.2	0.2	0.2	0.2	0.2	0.2	0.2	0.2	0.2	0.2	0.2	
16~32	16~32	16~32	16~32	16	20~40	20~40	20~40	20~40	20	25~50	25~50	25~50	25~50	25	31~63	31~63	31~63	31~63	31	
800	1,200	1,000	800	800	640	960	800	640	640	390	640	510	390	390	310	510	410	310	310	焼入れ鋼 45~55HRC Hardened steels
80	120	100	80	80	80	120	100	80	80	60	100	80	60	60	60	100	80	60	60	
400	600	500	400	400	390	580	480	390	390	280	450	360	280	280	250	410	330	250	250	
0.1	0.1	0.1	0.1	0.1	0.1	0.1	0.1	0.1	0.1	0.1	0.1	0.1	0.1	0.1	0.1	0.1	0.1	0.1	0.1	
0.2	0.2	0.2	0.2	0.2	0.2	0.2	0.2	0.2	0.2	0.2	0.2	0.2	0.2	0.2	0.2	0.2	0.2	0.2	0.2	
16~32	16~32	16~32	16~32	16	20~40	20~40	20~40	20~40	20	25~50	25~50	25~50	25~50	25	31~63	31~63	31~63	31~63	31	
500	1,000	700	500	500	400	800	560	400	400	320	510	390	320	320	250	410	310	260	260	焼入れ鋼 55~62HRC Hardened steels
50	100	70	50	50	50	100	70	50	50	50	80	60	50	50	50	80	60	50	50	
130	350	250	130	130	120	340	240	120	120	120	250	200	120	120	110	230	180	110	110	
0.05	0.07	0.07	0.05	0.05	0.05	0.07	0.07	0.05	0.05	0.05	0.07	0.07	0.05	0.05	0.05	0.07	0.07	0.05	0.05	
0.2	0.2	0.2	0.2	0.2	0.2	0.2	0.2	0.2	0.2	0.2	0.2	0.2	0.2	0.2	0.2	0.2	0.2	0.2	0.2	
16~32	16~32	16~32	16~32	16	20~40	20~40	20~40	20~40	20	25~50	25~50	25~50	25~50	25	31~63	31~63	31~63	31~63	31	

- [Note] ① These conditions are for general guidance; in actual machining conditions adjust the parameters according to your actual machine and work-piece conditions.
 ② To prevent tool breakage due to chips clogging tool flutes, always be sure to use an air blower, etc. to remove chips.
 ③ The evacuation of swarf can cause burns, cuts or damage to the eyes please ensure the correct safety cover is fitted around the machine, and necessary personal protection equipment is worn by the machine operator.
 ④ Please note that the JS Coating does not cause a reaction in conductive touch sensors.
 ⑤ Ensure to index the insert at the correct time to ensure safety of the tool-body.
 ⑥ Make settings so that the cutting depth and per-flute feed rate do not exceed the maximum values.
 ⑦ MZ1000 and BH250 are not suitable for wet cutting. Use them for dry cutting (air blow).
 ⑧ Due to fire risks do not use neat cutting oil as a coolant.
 ⑨ When using the BT30 arbor for modular mills, determine the cutting conditions using the standard cutting conditions table as a general guide. If vibrations are a concern due to the cutting conditions, adjust conditions by 1. reducing cutting depth (ap) or 2. reducing per-flute feed rate (fz).

Indexable Tools Square End Mills

アルファポリッシュミル Vタイプ ASPV

側面仕上げ標準切削条件

Standard cutting conditions for side finishing

※赤字は第一推奨材種です。
Red indicates primary recommended grade.

被削材 Work material	推奨材種 Recommended grade	工具径DC Tool dia.	φ16(2枚刃) 2 Flutes					φ20(3枚刃) 3 Flutes					φ25(4枚刃) 4 Flutes				
			突出し量 Overhang		モジュラー超硬シャンク Modular carbide shank			突出し量 Overhang		モジュラー超硬シャンク Modular carbide shank			突出し量 Overhang		モジュラー超硬シャンク Modular carbide shank		
			汎用 General purpose	高速加工 High-speed cutting	3DC-5DC	5DC-7DC	>7DC	汎用 General purpose	高速加工 High-speed cutting	3DC-5DC	5DC-7DC	>7DC	汎用 General purpose	高速加工 High-speed cutting	3DC-5DC	5DC-7DC	>7DC
一般構造用鋼 (200HB以下) Mild steels (200HB or less)	※ M21000 ATH08M JP4120 JS4060	n (min ⁻¹)	7,970	15,930	11,950	7,970	7,970	6,370	12,740	9,560	6,370	6,370	5,100	10,200	7,650	5,100	5,100
		vc (m/min)	400	800	600	400	400	400	800	600	400	400	400	800	600	400	400
		vf (mm/min)	1,600	4,780	3,590	1,920	1,600	1,920	5,740	4,310	2,300	1,920	2,040	6,120	4,590	2,450	2,040
		fz (mm/t)	0.1	0.15	0.15	0.12	0.1	0.1	0.15	0.15	0.12	0.1	0.1	0.15	0.15	0.12	0.1
		ap (mm)	2	2	1.5	1	0.7	2	2	1.5	1	0.7	2	2	1.5	1	0.7
		ae (mm)	< 0.2	< 0.2	< 0.2	< 0.2	< 0.2	< 0.2	< 0.2	< 0.2	< 0.2	< 0.2	< 0.2	< 0.2	< 0.2	< 0.2	< 0.2
炭素鋼 合金鋼 (30HRC以下) Carbon steels Alloy steels (30HRC or less)	M21000 ATH08M JP4120 JS4060	n (min ⁻¹)	5,980	11,950	7,970	7,970	5,980	4,780	9,560	6,370	6,370	4,780	3,830	7,650	5,100	5,100	3,830
		vc (m/min)	300	600	400	400	300	300	600	400	400	300	300	600	400	400	300
		vf (mm/min)	1,200	3,590	2,400	1,920	1,200	1,440	4,310	2,870	2,300	1,440	1,540	4,590	3,060	2,450	1,540
		fz (mm/t)	0.1	0.15	0.15	0.12	0.1	0.1	0.15	0.15	0.12	0.1	0.1	0.15	0.15	0.12	0.1
		ap (mm)	2	2	1.5	1	0.7	2	2	1.5	1	0.7	2	2	1.5	1	0.7
		ae (mm)	< 0.2	< 0.2	< 0.2	< 0.2	< 0.2	< 0.2	< 0.2	< 0.2	< 0.2	< 0.2	< 0.2	< 0.2	< 0.2	< 0.2	< 0.2
炭素鋼 合金鋼 (30~45HRC) Carbon steels Alloy steels	ATH08M JP4120 JS4060	n (min ⁻¹)	3,990	9,960	6,970	5,980	5,980	3,190	7,970	5,580	4,780	4,780	2,550	6,370	4,460	3,830	3,830
		vc (m/min)	200	500	350	300	300	200	500	350	300	300	200	500	350	300	300
		vf (mm/min)	800	2,400	1,680	1,200	960	960	2,870	2,010	1,440	1,150	1,020	3,060	2,150	1,540	1,230
		fz (mm/t)	0.1	0.12	0.12	0.1	0.08	0.1	0.12	0.12	0.1	0.08	0.1	0.12	0.12	0.1	0.08
		ap (mm)	2	2	1.5	1	0.7	2	2	1.5	1	0.7	2	2	1.5	1	0.7
		ae (mm)	< 0.2	< 0.2	< 0.2	< 0.2	< 0.2	< 0.2	< 0.2	< 0.2	< 0.2	< 0.2	< 0.2	< 0.2	< 0.2	< 0.2	< 0.2
ステンレス鋼 SUS Stainless steels	JP4120 JM4160 ATH08M	n (min ⁻¹)	5,980	11,950	7,970	7,970	5,980	4,780	9,560	6,370	6,370	4,780	3,830	7,650	5,100	5,100	3,830
		vc (m/min)	300	600	400	400	300	300	600	400	400	300	300	600	400	400	300
		vf (mm/min)	1,200	3,590	2,400	1,920	1,200	1,440	4,310	2,870	2,300	1,440	1,540	4,590	3,060	2,450	1,540
		fz (mm/t)	0.1	0.15	0.15	0.12	0.1	0.1	0.15	0.15	0.12	0.1	0.1	0.15	0.15	0.12	0.1
		ap (mm)	2	2	1.5	1	0.7	2	2	1.5	1	0.7	2	2	1.5	1	0.7
		ae (mm)	< 0.2	< 0.2	< 0.2	< 0.2	< 0.2	< 0.2	< 0.2	< 0.2	< 0.2	< 0.2	< 0.2	< 0.2	< 0.2	< 0.2	< 0.2
鋳鉄 FC FCD Cast irons	ATH08M JP4120 JS4060	n (min ⁻¹)	5,980	11,950	9,960	7,970	7,970	4,780	9,560	7,970	6,370	6,370	3,830	7,650	6,370	5,100	5,100
		vc (m/min)	300	600	500	400	400	300	600	500	400	400	300	600	500	400	400
		vf (mm/min)	1,200	3,590	2,990	1,920	1,600	1,440	4,310	3,590	2,300	1,920	1,540	4,590	3,830	2,450	2,040
		fz (mm/t)	0.1	0.15	0.15	0.12	0.1	0.1	0.15	0.15	0.12	0.1	0.1	0.15	0.15	0.12	0.1
		ap (mm)	2	2	1.5	1	0.7	2	2	1.5	1	0.7	2	2	1.5	1	0.7
		ae (mm)	< 0.2	< 0.2	< 0.2	< 0.2	< 0.2	< 0.2	< 0.2	< 0.2	< 0.2	< 0.2	< 0.2	< 0.2	< 0.2	< 0.2	< 0.2
アルミニウム合金 Aluminum alloys	SD5010	n (min ⁻¹)	11,950	23,890	15,930	11,950	11,950	9,560	19,110	12,740	9,560	9,560	7,650	15,290	10,200	7,650	7,650
		vc (m/min)	600	1,200	800	600	600	600	1,200	800	600	600	600	1,200	800	600	600
		vf (mm/min)	2,390	7,170	4,780	2,870	2,390	2,870	8,600	5,740	3,450	2,870	3,060	9,180	6,120	3,680	3,060
		fz (mm/t)	0.1	0.15	0.15	0.12	0.1	0.1	0.15	0.15	0.12	0.1	0.1	0.15	0.15	0.12	0.1
		ap (mm)	2	2	2	1.5	1	2	2	2	1.5	1	2	2	2	1.5	1
		ae (mm)	< 0.2	< 0.2	< 0.2	< 0.2	< 0.2	< 0.2	< 0.2	< 0.2	< 0.2	< 0.2	< 0.2	< 0.2	< 0.2	< 0.2	< 0.2
チタン合金 Ti-6Al-4V (湿式切削) Titanium alloys (wet condition)	ATH08M JP4120	n (min ⁻¹)	1,200	1,800	1,600	1,200	1,200	960	1,440	1,280	960	960	770	1,150	1,020	770	770
		vc (m/min)	60	90	80	60	60	60	90	80	60	60	60	90	80	60	60
		vf (mm/min)	240	440	390	240	200	290	520	470	290	240	310	560	490	310	250
		fz (mm/t)	0.1	0.12	0.12	0.1	0.08	0.1	0.12	0.12	0.1	0.08	0.1	0.12	0.12	0.1	0.08
		ap (mm)	2	2	1.5	1	0.7	2	2	1.5	1	0.7	2	2	1.5	1	0.7
		ae (mm)	< 0.2	< 0.2	< 0.2	< 0.2	< 0.2	< 0.2	< 0.2	< 0.2	< 0.2	< 0.2	< 0.2	< 0.2	< 0.2	< 0.2	< 0.2
焼入れ鋼 45~55HRC Hardened steels	JP4105 ATH08M JP4120	n (min ⁻¹)	2,990	4,980	3,590	2,990	2,990	2,390	3,990	2,870	2,390	2,390	1,920	3,190	2,300	1,920	1,920
		vc (m/min)	150	250	180	150	150	150	250	180	150	150	150	250	180	150	150
		vf (mm/min)	600	1,000	720	480	480	720	1,200	870	580	580	770	1,280	920	620	620
		fz (mm/t)	0.1	0.1	0.1	0.08	0.08	0.1	0.1	0.1	0.08	0.08	0.1	0.1	0.1	0.08	0.08
		ap (mm)	2	2	1.5	1	0.7	2	2	1.5	1	0.7	2	2	1.5	1	0.7
		ae (mm)	< 0.2	< 0.2	< 0.2	< 0.2	< 0.2	< 0.2	< 0.2	< 0.2	< 0.2	< 0.2	< 0.2	< 0.2	< 0.2	< 0.2	< 0.2
焼入れ鋼 55~62HRC Hardened steels	JP4105 ATH08M JP4120	n (min ⁻¹)	2,590	3,990	3,190	2,590	2,590	2,080	3,190	2,550	2,080	2,080	1,660	2,550	2,040	1,660	1,660
		vc (m/min)	130	200	160	130	130	130	200	160	130	130	130	200	160	130	130
		vf (mm/min)	520	800	640	420	260	630	960	770	500	320	670	1,020	820	540	340
		fz (mm/t)	0.1	0.1	0.1	0.08	0.05	0.1	0.1	0.1	0.08	0.05	0.1	0.1	0.1	0.08	0.05
		ap (mm)	1.5	1.5	1	0.7	0.5	1.5	1.5	1	0.7	0.5	1.5	1.5	1	0.7	0.5
		ae (mm)	< 0.2	< 0.2	< 0.2	< 0.2	< 0.2	< 0.2	< 0.2	< 0.2	< 0.2	< 0.2	< 0.2	< 0.2	< 0.2	< 0.2	< 0.2

- 【注意】 ①この切削条件表は切削条件の目安を示すものです。実際の加工では加工形状、目的、使用機械等により条件を調整してください。
 ②切りくず噛み込みによる工具損傷防止のため、必ずエアブロー等による切りくず除去を行ってください。
 ③排出した切りくずは、飛散し作業者を切傷させ、火傷あるいは目に入って負傷させる恐れがありますので、ご使用に際してはその周囲に安全カバーを付け、保護メガネ等の保護具を着用し、安全な環境で作業されることをお願い致します。
 ④JSコーティングは通電式タッチセンサーに反応しませんのでご注意ください。
 ⑤インサートの交換は早めに行い、過度の使用による破損を防止してください。
 ⑥切込み深さ及び1刃送り量の最大値を超えないように設定してください。
 ⑦M21000、BH250は湿式切削には適しません。乾式(エアブロー)での使用をお願いします。
 ⑧不水溶性切削油は、火災の恐れがありますので使用しないで下さい。
 ⑨モジュラーミル用BT30アーバご使用の際は、標準切削条件表を目安に加工条件を決定して下さい。加工状況により振動が懸念される場合は、1切込み深さ(ap)を低減する2、一刃当りの送り(fz)を低減する方法で調整下さい。

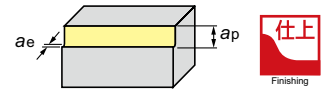

φ32(5枚刃) 5 Flutes					φ40(6枚刃) 6 Flutes					φ50(7枚刃) 7 Flutes					φ63(8枚刃) 8 Flutes					被削材 Work material
<3DC		モジュラー超硬シャンク Modular carbide shank			<3DC		モジュラー超硬シャンク Modular carbide shank			<3DC		3DC-5DC	5DC-7DC	>7DC	<3DC		3DC-5DC	5DC-7DC	>7DC	
汎用 General purpose	高速加工 High-speed cutting	3DC-5DC	5DC-7DC	>7DC	汎用 General purpose	高速加工 High-speed cutting	3DC-5DC	5DC-7DC	>7DC	汎用 General purpose	高速加工 High-speed cutting	3DC-5DC	5DC-7DC	>7DC	汎用 General purpose	高速加工 High-speed cutting	3DC-5DC	5DC-7DC	>7DC	
3,990	7,970	5,980	3,990	3,990	3,190	6,370	4,780	3,190	3,190	2,550	5,100	3,830	2,550	2,550	2,030	4,050	3,040	2,030	2,030	一般構造用鋼 (200HB以下) Mild steels (200HB or less)
400	800	600	400	400	400	800	600	400	400	400	800	600	400	400	400	800	600	400	400	
2,000	5,980	4,490	2,400	2,000	1,920	5,740	4,310	2,300	1,920	1,790	5,360	4,030	2,150	1,790	1,630	4,860	3,650	1,950	1,630	炭素鋼 合金鋼 (30HRC以下) Carbon steels Alloy steels (30HRC or less)
0.1	0.15	0.15	0.12	0.1	0.1	0.15	0.15	0.12	0.1	0.1	0.15	0.15	0.12	0.1	0.1	0.15	0.15	0.12	0.1	
2	2	1.5	1	0.7	2	2	1.5	1	0.7	2	2	2	1.5	1	2	2	2	1.5	1	
<0.2	<0.2	<0.2	<0.2	<0.2	<0.2	<0.2	<0.2	<0.2	<0.2	<0.2	<0.2	<0.2	<0.2	<0.2	<0.2	<0.2	<0.2	<0.2	<0.2	
2,990	5,980	3,990	3,990	2,990	2,390	4,780	3,190	3,190	2,390	1,920	3,830	2,550	2,550	1,920	1,520	3,040	2,030	2,030	1,520	炭素鋼 合金鋼 (30~45HRC) Carbon steels Alloy steels (30~45HRC)
300	600	400	400	300	300	600	400	400	300	300	600	400	400	300	300	600	400	400	300	
1,500	4,490	3,000	2,400	1,500	1,440	4,310	2,880	2,300	1,440	1,350	4,030	2,680	2,150	1,350	1,220	3,650	2,440	1,950	1,220	
0.1	0.15	0.15	0.12	0.1	0.1	0.15	0.15	0.12	0.1	0.1	0.15	0.15	0.12	0.1	0.1	0.15	0.15	0.12	0.1	
2	2	1.5	1	0.7	2	2	1.5	1	0.7	2	2	2	1.5	1	2	2	2	1.5	1	
<0.2	<0.2	<0.2	<0.2	<0.2	<0.2	<0.2	<0.2	<0.2	<0.2	<0.2	<0.2	<0.2	<0.2	<0.2	<0.2	<0.2	<0.2	<0.2	<0.2	
2,000	4,980	3,490	2,990	2,990	1,600	3,990	2,790	2,390	2,390	1,280	3,190	2,230	1,920	1,920	1,020	2,530	1,770	1,520	1,520	ステンレス鋼 SUS Stainless steels
200	500	350	300	300	200	500	350	300	300	200	500	350	300	300	200	500	350	300	300	
1,000	2,990	2,100	1,500	1,200	960	2,880	2,010	1,440	1,150	900	2,680	1,880	1,350	1,080	820	2,430	1,700	1,220	980	
0.1	0.12	0.12	0.1	0.08	0.1	0.12	0.12	0.1	0.08	0.1	0.12	0.12	0.1	0.08	0.1	0.12	0.12	0.1	0.08	
2	2	1.5	1	0.7	2	2	1.5	1	0.7	2	2	2	1.5	1	2	2	2	1.5	1	
<0.2	<0.2	<0.2	<0.2	<0.2	<0.2	<0.2	<0.2	<0.2	<0.2	<0.2	<0.2	<0.2	<0.2	<0.2	<0.2	<0.2	<0.2	<0.2	<0.2	
2,990	5,980	4,980	3,990	3,990	2,390	4,780	3,990	3,190	3,190	1,920	3,830	3,190	2,550	2,550	1,520	3,040	2,530	2,030	2,030	鋳鉄 FC FCD Cast irons
300	600	500	400	400	300	600	500	400	400	300	600	500	400	400	300	600	500	400	400	
1,500	4,490	3,740	2,400	2,000	1,440	4,310	3,600	2,300	1,920	1,350	4,030	3,350	2,150	1,790	1,220	3,650	3,040	1,950	1,630	
0.1	0.15	0.15	0.12	0.1	0.1	0.15	0.15	0.12	0.1	0.1	0.15	0.15	0.12	0.1	0.1	0.15	0.15	0.12	0.1	
2	2	1.5	1	0.7	2	2	1.5	1	0.7	2	2	2	1.5	1	2	2	2	1.5	1	
<0.2	<0.2	<0.2	<0.2	<0.2	<0.2	<0.2	<0.2	<0.2	<0.2	<0.2	<0.2	<0.2	<0.2	<0.2	<0.2	<0.2	<0.2	<0.2	<0.2	
5,980	11,950	7,970	5,980	5,980	4,780	9,560	6,370	4,780	4,780	3,830	9,560	6,370	3,830	3,830	3,040	7,590	5,060	3,040	3,040	アルミニウム合金 Aluminum alloys
600	1,200	800	600	600	600	1,200	800	600	600	600	1,500	1,000	600	600	600	1,500	1,000	600	600	
2,990	8,970	5,980	3,590	2,990	2,870	8,610	5,740	3,450	2,870	2,690	10,040	6,690	3,220	2,690	2,440	9,110	6,080	2,920	2,440	
0.1	0.15	0.15	0.12	0.1	0.1	0.15	0.15	0.12	0.1	0.1	0.15	0.15	0.12	0.1	0.1	0.15	0.15	0.12	0.1	
2	2	2	1.5	1	2	2	2	1.5	1	2	2	2	2	1.5	2	2	2	2	1.5	
<0.2	<0.2	<0.2	<0.2	<0.2	<0.2	<0.2	<0.2	<0.2	<0.2	<0.2	<0.2	<0.2	<0.2	<0.2	<0.2	<0.2	<0.2	<0.2	<0.2	
600	900	800	600	600	480	720	640	480	480	390	580	510	390	390	310	460	410	310	310	チタン合金 Ti-6Al-4V (湿式切削) Titanium alloys (wet condition)
60	90	80	60	60	60	90	80	60	60	60	90	80	60	60	60	90	80	60	60	
300	540	480	300	240	290	520	470	290	240	280	490	430	280	220	250	450	400	250	200	
0.1	0.12	0.12	0.1	0.08	0.1	0.12	0.12	0.1	0.08	0.1	0.12	0.12	0.1	0.08	0.1	0.12	0.12	0.1	0.08	
2	2	1.5	1	0.7	2	2	1.5	1	0.7	2	2	2	1.5	1	2	2	2	1.5	1	
<0.2	<0.2	<0.2	<0.2	<0.2	<0.2	<0.2	<0.2	<0.2	<0.2	<0.2	<0.2	<0.2	<0.2	<0.2	<0.2	<0.2	<0.2	<0.2	<0.2	
1,500	2,490	1,800	1,500	1,500	1,200	2,000	1,440	1,200	1,200	960	1,600	1,150	960	960	760	1,270	910	760	760	焼入れ鋼 45~55HRC Hardened steels
150	250	180	150	150	150	250	180	150	150	150	250	180	150	150	150	250	180	150	150	
750	1,250	900	600	600	720	1,200	870	580	580	680	1,120	810	540	540	610	1,020	730	490	490	
0.1	0.1	0.1	0.08	0.08	0.1	0.1	0.1	0.08	0.08	0.1	0.1	0.1	0.08	0.08	0.1	0.1	0.1	0.08	0.08	
2	2	1.5	1	0.7	2	2	1.5	1	0.7	2	2	1.5	1.2	1	2	2	1.5	1.2	1	
<0.2	<0.2	<0.2	<0.2	<0.2	<0.2	<0.2	<0.2	<0.2	<0.2	<0.2	<0.2	<0.2	<0.2	<0.2	<0.2	<0.2	<0.2	<0.2	<0.2	
1,300	2,000	1,600	1,300	1,300	1,040	1,600	1,280	1,040	1,040	830	1,280	1,020	830	830	660	1,020	810	660	660	焼入れ鋼 55~62HRC Hardened steels
130	200	160	130	130	130	200	160	130	130	130	200	160	130	130	130	200	160	130	130	
650	1,000	800	520	330	630	960	770	500	320	590	900	720	470	300	530	820	650	370	270	
0.1	0.1	0.1	0.08	0.05	0.1	0.1	0.1	0.08	0.05	0.1	0.1	0.1	0.08	0.05	0.1	0.1	0.1	0.07	0.05	
1.5	1.5	1	0.7	0.5	1.5	1.5	1	0.7	0.5	1.5	1.5	1	0.7	0.5	1.5	1.5	1	1.2	1	
<0.2	<0.2	<0.2	<0.2	<0.2	<0.2	<0.2	<0.2	<0.2	<0.2	<0.2	<0.2	<0.2	<0.2	<0.2	<0.2	<0.2	<0.2	<0.2	<0.2	

- [Note] ① These conditions are for general guidance; in actual machining conditions adjust the parameters according to your actual machine and work-piece conditions.
 ② To prevent tool breakage due to chips clogging tool flutes, always be sure to use an air blower, etc. to remove chips.
 ③ The evacuation of swarf can cause burns, cuts or damage to the eyes please ensure the correct safety cover is fitted around the machine, and necessary personal protection equipment is worn by the machine operator.
 ④ Please note that the JS Coating does not cause a reaction in conductive touch sensors.
 ⑤ Ensure to index the insert at the correct time to ensure safety of the tool-body.
 ⑥ Make settings so that the cutting depth and per-flute feed rate do not exceed the maximum values.
 ⑦ MZ1000 and BH250 are not suitable for wet cutting. Use them for dry cutting (air blow).
 ⑧ Due to fire risks do not use neat cutting oil as a coolant.
 ⑨ When using the BT30 arbor for modular mills, determine the cutting conditions using the standard cutting conditions table as a general guide. If vibrations are a concern due to the cutting conditions, adjust conditions by 1.reducing cutting depth (ap) or 2.reducing per-flute feed rate (fz).

アルファポリッシュミル Vタイプ ASPV

■ バーチカル側面仕上げ標準切削条件

Standard cutting conditions for vertical side finishing

※赤字は第一推奨材種です。
Red indicates primary recommended grade.

被削材 Work material	推奨材種 Recommended grade	工具径DC Tool dia.	φ16(2枚刃) 2 Flutes					φ20(3枚刃) 3 Flutes					φ25(4枚刃) 4 Flutes				
			<3DC		モジュラー超硬シャンク Modular carbide shank			<3DC		モジュラー超硬シャンク Modular carbide shank			<3DC		モジュラー超硬シャンク Modular carbide shank		
			汎用 General purpose	高速加工 High-speed cutting	3DC-5DC	5DC-7DC	>7DC	汎用 General purpose	高速加工 High-speed cutting	3DC-5DC	5DC-7DC	>7DC	汎用 General purpose	高速加工 High-speed cutting	3DC-5DC	5DC-7DC	>7DC
炭素鋼 合金鋼 (30HRC以下) Carbon steels Alloy steels (30HRC or less)	※ ATH08M MZ1000 JP4120 JS4060	<i>n</i> (min ⁻¹)	5,980	11,950	7,970	7,970	5,980	4,780	9,560	6,370	6,370	4,780	3,830	7,650	5,100	5,100	3,830
		<i>vc</i> (m/min)	300	600	400	400	300	300	600	400	400	300	300	600	400	400	300
		<i>vf</i> (mm/min)	1,560	4,780	2,400	2,080	1,200	1,870	5,740	2,870	2,490	1,440	2,300	6,120	3,680	3,060	1,840
		<i>fz</i> (mm/t)	0.13	0.2	0.15	0.13	0.1	0.13	0.2	0.15	0.13	0.1	0.15	0.2	0.18	0.15	0.12
		<i>pf</i> (mm)	0.5	0.5	0.5	0.5	0.5	0.6	0.6	0.6	0.6	0.6	0.7	0.7	0.7	0.7	0.7
		<i>ae</i> (mm)	< 0.2	< 0.2	< 0.2	< 0.2	< 0.2	< 0.2	< 0.2	< 0.2	< 0.2	< 0.2	< 0.2	< 0.2	< 0.2	< 0.2	< 0.2
鋳鉄 FC FCD Cast irons	ATH08M JP4120 JS4060	<i>n</i> (min ⁻¹)	5,980	11,950	9,960	7,970	7,970	4,780	9,560	7,970	6,370	6,370	3,830	7,650	6,370	5,100	5,100
		<i>vc</i> (m/min)	300	600	500	400	400	300	600	500	400	400	300	600	500	400	400
		<i>vf</i> (mm/min)	1,800	4,780	3,990	3,190	2,400	2,160	5,740	4,790	3,830	2,870	3,070	7,650	5,100	4,080	3,060
		<i>fz</i> (mm/t)	0.15	0.2	0.2	0.2	0.15	0.15	0.2	0.2	0.2	0.15	0.2	0.25	0.2	0.2	0.15
		<i>pf</i> (mm)	0.5	0.5	0.5	0.5	0.5	0.6	0.6	0.6	0.6	0.6	0.7	0.7	0.7	0.7	0.7
		<i>ae</i> (mm)	< 0.2	< 0.2	< 0.2	< 0.2	< 0.2	< 0.2	< 0.2	< 0.2	< 0.2	< 0.2	< 0.2	< 0.2	< 0.2	< 0.2	< 0.2

■ バーチカル荒加工標準切削条件

Standard cutting conditions for vertical roughing

【注意】 インサートはコーナ半径RE0.8をご使用下さい。 【Note】 Use nose corner radius RE0.8 insert.

被削材 Work material	推奨材種 Recommended grade	工具径DC Tool dia.	φ16(2枚刃) 2 Flutes					φ20(3枚刃) 3 Flutes					φ25(4枚刃) 4 Flutes				
			<3DC		モジュラー超硬シャンク Modular carbide shank			<3DC		モジュラー超硬シャンク Modular carbide shank			<3DC		モジュラー超硬シャンク Modular carbide shank		
			汎用 General purpose	高速加工 High-speed cutting	3DC-5DC	5DC-7DC	>7DC	汎用 General purpose	高速加工 High-speed cutting	3DC-5DC	5DC-7DC	>7DC	汎用 General purpose	高速加工 High-speed cutting	3DC-5DC	5DC-7DC	>7DC
炭素鋼 合金鋼 (30HRC以下) Carbon steels Alloy steels (30HRC or less)	※ JS4060 JP4120	<i>n</i> (min ⁻¹)	2,990	3,990	2,990	2,990	2,390	2,390	3,190	2,390	2,390	1,920	1,920	2,550	1,920	1,920	1,530
		<i>vc</i> (m/min)	150	200	150	150	120	150	200	150	150	120	150	200	150	150	120
		<i>vf</i> (mm/min)	900	1,200	720	600	340	1,080	1,440	870	720	410	1,160	1,530	930	770	430
		<i>fz</i> (mm/t)	0.15	0.15	0.12	0.1	0.07	0.15	0.15	0.12	0.1	0.07	0.15	0.15	0.12	0.1	0.07
		<i>pf</i> (mm)	3.6	3.6	3.6	3.6	3	4	4	4	4	4	4.5	4.5	4.5	4.5	4.5
		<i>ae</i> (mm)	< 4	< 4	< 3	< 2	< 2	< 4	< 4	< 3	< 2	< 2	< 4	< 4	< 3	< 2	< 2
鋳鉄 FC FCD Cast irons	ATH08M JP4120 JS4060	<i>n</i> (min ⁻¹)	2,990	4,980	3,990	3,990	2,990	2,390	3,990	3,190	3,190	2,390	1,920	3,190	2,550	2,550	1,920
		<i>vc</i> (m/min)	150	250	200	200	150	150	250	200	200	150	150	250	200	200	150
		<i>vf</i> (mm/min)	1,200	2,000	1,200	1,040	600	1,440	2,400	1,440	1,250	720	1,540	2,560	1,530	1,330	770
		<i>fz</i> (mm/t)	0.2	0.2	0.15	0.13	0.1	0.2	0.2	0.15	0.13	0.1	0.2	0.2	0.15	0.13	0.1
		<i>pf</i> (mm)	3.6	3.6	3.6	3.6	3.6	4	4	4	4	4	4.5	4.5	4.5	4.5	4.5
		<i>ae</i> (mm)	< 4	< 4	< 4	< 4	< 3	< 4	< 4	< 4	< 4	< 3	< 4	< 4	< 4	< 4	< 3

- 【注意】
- この切削条件表は切削条件の目安を示すものです。実際の加工では加工形状、目的、使用機械等により条件を調整してください。
 - 切りくず噛み込みによる工具損傷防止のため、必ずエアブロー等による切りくず除去を行ってください。
 - 排出した切りくずは、飛散し作業者を切傷させ、火傷あるいは目に入って負傷させる恐れがありますので、ご使用に際してはその周囲に安全カバーを取付け、保護メガネ等の保護具を着用し、安全な環境で作業されることをお願い致します。
 - JSコーティングは通電式タッチセンサーに反応しませんのでご注意ください。
 - インサートの交換は早めに行い、過度の使用による破損を防止してください。
 - 切込み深さ及び1刃送り量の最大値を超えないように設定してください。
 - MZ1000, BH250は湿式切削には適しません。乾式(エアブロー)での使用をお願いします。
 - 不水溶性切削油は、火災の恐れがありますので使用しないで下さい。
 - モジュラーミル用BT30アーバご使用の際は、標準切削条件表を目安に加工条件を決定して下さい。加工状況により振動が懸念される場合は、1.切込み深さ(*ap*)を低減する、2.一刃当りの送り(*fz*)を低減する方法で調整下さい。

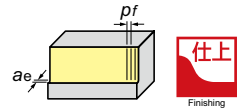

φ32(5枚刃) 5 Flutes					φ40(6枚刃) 6 Flutes					φ50(7枚刃) 7 Flutes					φ63(8枚刃) 8 Flutes					被削材 Work material
<3DC		モジュラー超硬シャンク Modular carbide shank			<3DC		モジュラー超硬シャンク Modular carbide shank			<3DC		3DC-5DC	5DC-7DC	>7DC	<3DC		3DC-5DC	5DC-7DC	>7DC	
汎用 General purpose	高速 加工 High-speed cutting	3DC-5DC	5DC-7DC	>7DC	汎用 General purpose	高速 加工 High-speed cutting	3DC-5DC	5DC-7DC	>7DC	汎用 General purpose	高速 加工 High-speed cutting	3DC-5DC	5DC-7DC	>7DC	汎用 General purpose	高速 加工 High-speed cutting	3DC-5DC	5DC-7DC	>7DC	
2,990	5,980	3,990	3,990	2,990	2,390	4,780	3,190	3,190	2,390	1,920	3,830	2,550	2,550	1,920	1,520	3,040	2,030	2,030	1,520	炭素鋼 合金鋼 (30HRC以下) Carbon steels Alloy steels (30HRC or less)
300	600	400	400	300	300	600	400	400	300	300	600	400	400	300	300	600	400	400	300	
2,250	5,980	3,600	3,000	1,800	2,160	5,740	3,450	2,880	1,730	2,020	5,370	3,220	2,680	1,750	1,830	4,870	2,930	2,440	1,590	
0.15	0.2	0.18	0.15	0.12	0.15	0.2	0.18	0.15	0.12	0.15	0.2	0.18	0.15	0.13	0.15	0.2	0.18	0.15	0.13	
0.8	0.8	0.8	0.8	0.8	0.88	0.88	0.88	0.88	0.88	1	1	1	1	1	1.12	1.12	1.12	1.12	1.12	
< 0.2	< 0.2	< 0.2	< 0.2	< 0.2	< 0.2	< 0.2	< 0.2	< 0.2	< 0.2	< 0.2	< 0.2	< 0.2	< 0.2	< 0.2	< 0.2	< 0.2	< 0.2	< 0.2	< 0.2	
2,990	5,980	4,980	3,990	3,990	2,390	4,780	3,990	3,190	3,190	1,920	3,830	3,190	2,550	2,550	1,520	3,040	2,530	2,030	2,030	鑄鉄 FC FCD Cast irons
300	600	500	400	400	300	600	500	400	400	300	600	500	400	400	300	600	500	400	400	
2,990	7,480	4,980	3,990	3,000	2,870	7,170	4,790	3,830	2,880	2,690	6,710	4,920	3,570	3,220	2,440	6,080	4,460	3,250	2,930	
0.2	0.25	0.2	0.2	0.15	0.2	0.25	0.2	0.2	0.15	0.2	0.25	0.22	0.2	0.18	0.2	0.25	0.22	0.2	0.18	
0.8	0.8	0.8	0.8	0.8	0.88	0.88	0.88	0.88	0.88	1	1	1	1	1	1.12	1.12	1.12	1.12	1.12	
< 0.2	< 0.2	< 0.2	< 0.2	< 0.2	< 0.2	< 0.2	< 0.2	< 0.2	< 0.2	< 0.2	< 0.2	< 0.2	< 0.2	< 0.2	< 0.2	< 0.2	< 0.2	< 0.2	< 0.2	

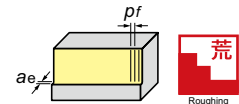

※赤字は第一推奨材種です。 ※Red indicates primary recommended grade.

φ32(5枚刃) 5 Flutes					φ40(6枚刃) 6 Flutes					φ50(7枚刃) 7 Flutes					φ63(8枚刃) 8 Flutes					被削材 Work material
<3DC		モジュラー超硬シャンク Modular carbide shank			<3DC		モジュラー超硬シャンク Modular carbide shank			<3DC		3DC-5DC	5DC-7DC	>7DC	<3DC		3DC-5DC	5DC-7DC	>7DC	
汎用 General purpose	高速 加工 High-speed cutting	3DC-5DC	5DC-7DC	>7DC	汎用 General purpose	高速 加工 High-speed cutting	3DC-5DC	5DC-7DC	>7DC	汎用 General purpose	高速 加工 High-speed cutting	3DC-5DC	5DC-7DC	>7DC	汎用 General purpose	高速 加工 High-speed cutting	3DC-5DC	5DC-7DC	>7DC	
1,500	2,000	1,500	1,500	1,200	1,200	1,600	1,200	1,200	960	960	1,280	960	960	770	760	1,020	760	760	610	炭素鋼 合金鋼 (30HRC以下) Carbon steels Alloy steels (30HRC or less)
150	200	150	150	120	150	200	150	150	120	150	200	150	150	120	150	200	150	150	120	
1,130	1,500	900	750	420	1,080	1,440	870	720	410	1,010	1,350	810	680	380	920	1,230	730	610	350	
0.15	0.15	0.12	0.1	0.07	0.15	0.15	0.12	0.1	0.07	0.15	0.15	0.12	0.1	0.07	0.15	0.15	0.12	0.1	0.07	
5	5	5	5	5	5.7	5.7	5.7	5.7	5.7	6.3	6.3	6.3	6.3	6.3	7.1	7.1	7.1	7.1	7.1	
< 4	< 4	< 3	< 2	< 2	< 4	< 4	< 3	< 2	< 2	< 4	< 4	< 3	< 2	< 2	< 4	< 4	< 3	< 2	< 2	
1,500	2,490	2,000	2,000	1,500	1,200	2,000	1,600	1,600	1,200	960	1,600	1,280	1,280	960	760	1,270	1,020	1,020	760	鑄鉄 FC FCD Cast irons
150	250	200	200	150	150	250	200	200	150	150	250	200	200	150	150	250	200	200	150	
1,500	3,120	2,000	2,000	1,130	1,440	3,000	1,920	1,920	1,080	1,350	2,800	1,800	1,800	1,010	1,220	2,540	1,640	1,640	920	
0.2	0.25	0.2	0.2	0.15	0.2	0.25	0.2	0.2	0.15	0.2	0.25	0.2	0.2	0.15	0.2	0.25	0.2	0.2	0.15	
5	5	5	5	5	5.7	5.7	5.7	5.7	5.7	6.3	6.3	6.3	6.3	6.3	7.1	7.1	7.1	7.1	7.1	
< 4	< 4	< 4	< 4	< 3	< 4	< 4	< 4	< 4	< 3	< 4	< 4	< 4	< 4	< 3	< 4	< 4	< 4	< 4	< 3	

- [Note]**
- ① These conditions are for general guidance; in actual machining conditions adjust the parameters according to your actual machine and work-piece conditions.
 - ② To prevent tool breakage due to chips clogging tool flutes, always be sure to use an air blower, etc. to remove chips.
 - ③ The evacuation of swarf can cause burns, cuts or damage to the eyes please ensure the correct safety cover is fitted around the machine, and necessary personal protection equipment is worn by the machine operator.
 - ④ Please note that the JS Coating does not cause a reaction in conductive touch sensors.
 - ⑤ Ensure to index the insert at the correct time to ensure safety of the tool-body.
 - ⑥ Make settings so that the cutting depth and per-flute feed rate do not exceed the maximum values.
 - ⑦ MZ1000 and BH250 are not suitable for wet cutting. Use them for dry cutting (air blow).
 - ⑧ Due to fire risks do not use neat cutting oil as a coolant.
 - ⑨ When using the BT30 arbor for modular mills, determine the cutting conditions using the standard cutting conditions table as a general guide. If vibrations are a concern due to the cutting conditions, adjust conditions by 1.reducing cutting depth (ap) or 2.reducing per-flute feed rate (fz).

アルファポリッシュミル Vタイプ ASPV

等高線荒加工標準切削条件 Standard cutting conditions for contour roughing

【注意】 インサートはコーナ半径RE2をご使用下さい。 **【Note】** Use nose corner radius RE2 insert.

被削材 Work material	推奨材種 Recommended grade	工具径DC Tool dia.	φ16(2枚刃) 2 Flutes					φ20(3枚刃) 3 Flutes					φ25(4枚刃) 4 Flutes					
			突出し量 Overhang	<3DC		モジュラー超硬シャンク Modular carbide shank			<3DC		モジュラー超硬シャンク Modular carbide shank			<3DC		モジュラー超硬シャンク Modular carbide shank		
				汎用 General purpose	高速加工 High-speed cutting	3DC-5DC	5DC-7DC	>7DC	汎用 General purpose	高速加工 High-speed cutting	3DC-5DC	5DC-7DC	>7DC	汎用 General purpose	高速加工 High-speed cutting	3DC-5DC	5DC-7DC	>7DC
炭素鋼 合金鋼 (30HRC以下) Carbon steels Alloy steels (30HRC or less)	※ JP4120 JS4060	n (min ⁻¹)	2,590	3,990	2,590	2,590	1,800	2,080	3,190	2,080	2,080	1,440	1,660	2,550	1,660	1,660	1,150	
		v_c (m/min)	130	200	130	130	90	130	200	130	130	90	130	200	130	130	90	
		v_f (mm/min)	2,590	3,990	2,590	2,590	1,800	3,120	4,790	3,120	3,120	2,160	3,320	5,100	3,320	3,320	2,300	
		f_z (mm/t)	0.5	0.5	0.5	0.5	0.5	0.5	0.5	0.5	0.5	0.5	0.5	0.5	0.5	0.5	0.5	
		a_p (mm)	0.5	0.5	0.4	0.3	0.25	0.5	0.5	0.4	0.3	0.25	0.5	0.5	0.4	0.3	0.25	
		a_e (mm)	13	13	13	13	13	16	16	16	16	16	16	20	20	20	20	
炭素鋼 合金鋼 (30~45HRC) Carbon steels Alloy steels	JP4120 JS4060	n (min ⁻¹)	1,800	3,590	2,590	2,590	1,800	1,440	2,870	2,080	2,080	1,440	1,150	2,300	1,660	1,660	1,150	
		v_c (m/min)	90	180	130	130	90	90	180	130	130	90	90	180	130	130	90	
		v_f (mm/min)	1,440	2,880	2,080	2,080	1,440	1,730	3,450	2,500	2,500	1,730	1,840	3,680	2,660	2,660	1,840	
		f_z (mm/t)	0.4	0.4	0.4	0.4	0.4	0.4	0.4	0.4	0.4	0.4	0.4	0.4	0.4	0.4	0.4	
		a_p (mm)	0.5	0.5	0.4	0.3	0.25	0.5	0.5	0.4	0.3	0.25	0.5	0.5	0.4	0.3	0.25	
		a_e (mm)	13	13	13	13	13	16	16	16	16	16	16	20	20	20	20	
ステンレス鋼 SUS Stainless steels	JM4160	n (min ⁻¹)	2,590	3,990	2,590	2,590	1,800	2,080	3,190	2,080	2,080	1,440	1,660	2,550	1,660	1,660	1,150	
		v_c (m/min)	130	200	130	130	90	130	200	130	130	90	130	200	130	130	90	
		v_f (mm/min)	2,590	3,990	2,590	2,590	1,800	3,120	4,790	3,120	3,120	2,160	3,320	5,100	3,320	3,320	2,300	
		f_z (mm/t)	0.5	0.5	0.5	0.5	0.5	0.5	0.5	0.5	0.5	0.5	0.5	0.5	0.5	0.5	0.5	
		a_p (mm)	0.5	0.5	0.4	0.3	0.25	0.5	0.5	0.4	0.3	0.25	0.5	0.5	0.4	0.3	0.25	
		a_e (mm)	13	13	13	13	13	16	16	16	16	16	16	20	20	20	20	
鋳鉄 FC FCD Cast irons	JP4120 JS4060	n (min ⁻¹)	2,990	3,990	2,590	2,590	1,800	2,390	3,190	2,080	2,080	1,440	1,920	2,550	1,660	1,660	1,150	
		v_c (m/min)	150	200	130	130	90	150	200	130	130	90	150	200	130	130	90	
		v_f (mm/min)	4,190	5,590	3,630	3,630	2,520	5,020	6,700	4,370	4,370	3,030	5,380	7,140	4,650	4,650	3,220	
		f_z (mm/t)	0.7	0.7	0.7	0.7	0.7	0.7	0.7	0.7	0.7	0.7	0.7	0.7	0.7	0.7	0.7	
		a_p (mm)	0.5	0.5	0.5	0.4	0.3	0.5	0.5	0.5	0.4	0.3	0.5	0.5	0.5	0.4	0.3	
		a_e (mm)	13	13	13	13	13	16	16	16	16	16	16	20	20	20	20	

刃先交換式工具 スクエアエンドミル

CBN底面仕上げ標準切削条件 Standard cutting conditions for CBN bottom finishing

被削材 Work material	推奨材種 Recommended grade	工具径DC Tool dia.	φ16(2枚刃) 2 Flutes		φ20(3枚刃) 3 Flutes		φ25(4枚刃) 4 Flutes		
			突出し量 Overhang	<3DC	モジュラー超硬シャンク Modular carbide shank	<3DC	モジュラー超硬シャンク Modular carbide shank	<3DC	モジュラー超硬シャンク Modular carbide shank
				高速加工 High-speed cutting	3DC-5DC	高速加工 High-speed cutting	3DC-5DC	高速加工 High-speed cutting	3DC-5DC
炭素鋼 合金鋼 (30HRC以下) Carbon steels Alloy steels (30HRC or less)	BH250	n (min ⁻¹)	11,950	9,960	9,560	7,970	7,650	6,370	
		v_c (m/min)	600	500	600	500	600	500	
		v_f (mm/min)	2,390	1,600	2,870	1,920	3,060	2,040	
		f_z (mm/t)	0.1	0.08	0.1	0.08	0.1	0.08	
		a_p (mm)	< 0.1	< 0.1	< 0.1	< 0.1	< 0.1	< 0.1	
		a_e (mm)	8~16	8~16	10~20	10~20	12.5~25	12.5~25	
鋳鉄 FC FCD Cast irons	BH250	n (min ⁻¹)	15,930	11,950	12,740	9,560	11,470	8,920	
		v_c (m/min)	800	600	800	600	900	700	
		v_f (mm/min)	3,830	2,870	4,590	3,450	5,510	4,290	
		f_z (mm/t)	0.12	0.12	0.12	0.12	0.12	0.12	
		a_p (mm)	< 0.1	< 0.1	< 0.1	< 0.1	< 0.1	< 0.1	
		a_e (mm)	8~16	8~16	10~20	10~20	12.5~25	12.5~25	

- 【注意】**
- この切削条件表は切削条件の目安を示すものです。実際の加工では加工形状、目的、使用機械等により条件を調整してください。
 - 切りくず噛み込みによる工具損傷防止のため、必ずエアブロー等による切りくず除去を行ってください。
 - 排出した切りくずは、飛散し作業者を切傷させ、火傷あるいは目に入って負傷させる恐れがありますので、ご使用に際してはその周囲に安全カバーを取付け、保護メガネ等の保護具を着用し、安全な環境で作業されることをお願い致します。
 - JSコーティングは通電式タッチセンサーに反応しませんのでご注意ください。
 - インサートの交換は早めに行い、過度の使用による破損を防止してください。
 - 切込み深さ及び1刃送り量の最大値を超えないように設定してください。
 - MZ1000, BH250は湿式切削には適しません。乾式(エアブロー)での使用をお願いします。
 - 不水溶性切削油は、火災の恐れがありますので使用しないで下さい。
 - モジュラーミル用BT30アーバご使用の際は、標準切削条件表を目安に加工条件を決定して下さい。加工状況により振動が懸念される場合は、1.切込み深さ(a_p)を低減する、2.一刃当りの送り(f_z)を低減する方法で調整下さい。

※赤字は第一推奨材種です。
※Red indicates primary recommended grade.

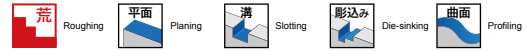
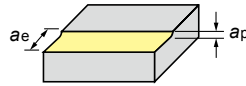

φ32(5枚刃) 5 Flutes					φ40(6枚刃) 6 Flutes					φ50(7枚刃) 7 Flutes					φ63(8枚刃) 8 Flutes					被削材 Work material
<3DC		モジュラー超硬シャンク Modular carbide shank			<3DC		モジュラー超硬シャンク Modular carbide shank			<3DC		3DC-5DC	5DC-7DC	>7DC	<3DC		3DC-5DC	5DC-7DC	>7DC	
汎用 General purpose	高速 加工 High-speed cutting	3DC-5DC	5DC-7DC	>7DC	汎用 General purpose	高速 加工 High-speed cutting	3DC-5DC	5DC-7DC	>7DC	汎用 General purpose	高速 加工 High-speed cutting	3DC-5DC	5DC-7DC	>7DC	汎用 General purpose	高速 加工 High-speed cutting	3DC-5DC	5DC-7DC	>7DC	
1,300	2,000	1,300	1,300	900	1,040	1,600	1,040	1,040	720	830	1,280	830	830	580	660	1,020	660	660	460	炭素鋼 合金鋼 (30HRC以下) Carbon steels Alloy steels (30HRC or less)
130	200	130	130	90	130	200	130	130	90	130	200	130	130	90	130	200	130	130	90	
3,250	5,000	3,250	3,250	2,250	3,120	4,800	3,120	3,120	2,160	2,910	4,480	2,910	2,910	2,030	2,640	4,080	2,640	2,640	1,840	炭素鋼 合金鋼 (30~45HRC) Carbon steels Alloy steels
0.5	0.5	0.5	0.5	0.5	0.5	0.5	0.5	0.5	0.5	0.5	0.5	0.5	0.5	0.5	0.5	0.5	0.5	0.5	0.5	
0.5	0.5	0.4	0.3	0.25	0.5	0.5	0.4	0.3	0.25	0.5	0.5	0.4	0.3	0.25	0.5	0.5	0.4	0.3	0.25	
25	25	25	25	25	32	32	32	32	32	40	40	40	40	40	50	50	50	50	50	
900	1,800	1,300	1,300	900	720	1,440	1,040	1,040	720	830	1,280	830	830	580	460	910	660	660	460	ステンレス鋼 SUS Stainless steels
90	180	130	130	90	90	180	130	130	90	130	200	130	130	90	90	180	130	130	90	
1,800	3,600	2,600	2,600	1,800	1,730	3,460	2,500	2,500	1,730	2,330	3,590	2,330	2,330	1,630	1,480	2,920	2,120	2,120	1,480	
0.4	0.4	0.4	0.4	0.4	0.4	0.4	0.4	0.4	0.4	0.4	0.4	0.4	0.4	0.4	0.4	0.4	0.4	0.4	0.4	
0.5	0.5	0.4	0.3	0.25	0.5	0.5	0.4	0.3	0.25	0.5	0.5	0.4	0.3	0.25	0.5	0.5	0.4	0.3	0.25	
25	25	25	25	25	32	32	32	32	32	40	40	40	40	40	50	50	50	50	50	
1,300	2,000	1,300	1,300	900	1,040	1,600	1,040	1,040	720	960	1,470	1,150	830	640	660	1,020	660	660	460	炭素鋼 合金鋼 (30HRC以下) Carbon steels Alloy steels
130	200	130	130	90	130	200	130	130	90	150	230	180	130	100	130	200	130	130	90	
3,250	5,000	3,250	3,250	2,250	3,120	4,800	3,120	3,120	2,160	3,360	5,150	4,030	2,910	2,240	2,640	4,080	2,640	2,640	1,840	
0.5	0.5	0.5	0.5	0.5	0.5	0.5	0.5	0.5	0.5	0.5	0.5	0.5	0.5	0.5	0.5	0.5	0.5	0.5	0.5	
0.5	0.5	0.4	0.3	0.25	0.5	0.5	0.4	0.3	0.25	0.5	0.5	0.4	0.3	0.25	0.5	0.5	0.4	0.3	0.25	
25	25	25	25	25	32	32	32	32	32	40	40	40	40	40	50	50	50	50	50	
1,500	2,000	1,300	1,300	900	1,200	1,600	1,040	1,040	720	960	1,280	830	830	580	760	1,020	660	660	460	ステンレス鋼 SUS Stainless steels
150	200	130	130	90	150	200	130	130	90	150	200	130	130	90	150	200	130	130	90	
5,250	7,000	4,550	4,550	3,150	5,040	6,720	4,370	4,370	3,030	4,710	6,280	4,070	4,070	2,850	4,260	5,720	3,700	3,700	2,580	
0.7	0.7	0.7	0.7	0.7	0.7	0.7	0.7	0.7	0.7	0.7	0.7	0.7	0.7	0.7	0.7	0.7	0.7	0.7	0.7	
0.5	0.5	0.5	0.4	0.3	0.5	0.5	0.5	0.4	0.3	0.5	0.5	0.5	0.4	0.3	0.5	0.5	0.5	0.4	0.3	
25	25	25	25	25	32	32	32	32	32	40	40	40	40	40	50	50	50	50	50	

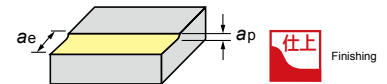

φ32(5枚刃) 5 Flutes		φ40(6枚刃) 6 Flutes		φ50(7枚刃) 7 Flutes		φ63(8枚刃) 8 Flutes		被削材 Work material
<3DC	モジュラー超硬シャンク Modular carbide shank	<3DC	モジュラー超硬シャンク Modular carbide shank	<3DC	3DC-5DC	<3DC	3DC-5DC	
高速加工 High-speed cutting	3DC-5DC	高速加工 High-speed cutting	3DC-5DC	高速加工 High-speed cutting	3DC-5DC	高速加工 High-speed cutting	3DC-5DC	
5,980	4,980	4,780	3,990	3,830	3,190	3,040	2,530	炭素鋼 合金鋼 (30HRC以下) Carbon steels Alloy steels (30HRC or less)
600	500	600	500	600	500	600	500	
2,990	2,000	2,870	1,920	2,690	2,240	2,440	2,030	炭素鋼 合金鋼 (30HRC以下) Carbon steels Alloy steels (30HRC or less)
0.1	0.08	0.1	0.08	0.1	0.1	0.1	0.1	
< 0.1	< 0.1	< 0.1	< 0.1	< 0.1	< 0.1	< 0.1	< 0.1	炭素鋼 合金鋼 (30HRC以下) Carbon steels Alloy steels (30HRC or less)
16~32	16~32	20~40	20~40	25~50	25~50	31~63	31~63	
8,960	6,970	7,170	5,580	5,740	4,460	4,550	3,540	炭素鋼 合金鋼 (30HRC以下) Carbon steels Alloy steels (30HRC or less)
900	700	900	700	900	700	900	700	
5,380	4,190	5,170	4,020	4,830	3,750	4,370	3,400	炭素鋼 合金鋼 (30HRC以下) Carbon steels Alloy steels (30HRC or less)
0.12	0.12	0.12	0.12	0.12	0.12	0.12	0.12	
< 0.1	< 0.1	< 0.1	< 0.1	< 0.1	< 0.1	< 0.1	< 0.1	炭素鋼 合金鋼 (30HRC以下) Carbon steels Alloy steels (30HRC or less)
16~32	16~32	20~40	20~40	25~50	25~50	31~63	31~63	

- [Note]**
- ① These conditions are for general guidance; in actual machining conditions adjust the parameters according to your actual machine and work-piece conditions.
 - ② To prevent tool breakage due to chips clogging tool flutes, always be sure to use an air blower, etc. to remove chips.
 - ③ The evacuation of swarf can cause burns, cuts or damage to the eyes please ensure the correct safety cover is fitted around the machine, and necessary personal protection equipment is worn by the machine operator.
 - ④ Please note that the JS Coating does not cause a reaction in conductive touch sensors.
 - ⑤ Ensure to index the insert at the correct time to ensure safety of the tool-body.
 - ⑥ Make settings so that the cutting depth and per-flute feed rate do not exceed the maximum values.
 - ⑦ MZ1000 and BH250 are not suitable for wet cutting. Use them for dry cutting (air blow).
 - ⑧ Due to fire risks do not use neat cutting oil as a coolant.
 - ⑨ When using the BT30 arbor for modular mills, determine the cutting conditions using the standard cutting conditions table as a general guide. If vibrations are a concern due to the cutting conditions, adjust conditions by 1. reducing cutting depth (ap) or 2. reducing per-flute feed rate (fz).

■ CBN 側面仕上げ標準切削条件 Standard cutting conditions for CBN side finishing

被削材 Work material	推奨材種 Recommended grade	工具径DC Tool dia.	φ16(2枚刃) 2 Flutes				φ20(3枚刃) 3 Flutes				φ25(4枚刃) 4 Flutes			
			突出し量 Overhang	モジュラー超硬シャンク Modular carbide shank			高速加工 High-speed cutting	モジュラー超硬シャンク Modular carbide shank			高速加工 High-speed cutting	モジュラー超硬シャンク Modular carbide shank		
				<3DC	3DC-5DC	5DC-7DC		>7DC	<3DC	3DC-5DC		5DC-7DC	>7DC	<3DC
炭素鋼 合金鋼 (30HRC以下) Carbon steels Alloy steels (30HRC or less)	BH250	<i>n</i> (min ⁻¹)	15,930	15,930	11,950	11,950	12,740	12,740	9,560	9,560	10,200	10,200	7,650	7,650
		<i>vc</i> (m/min)	800	800	600	600	800	800	600	600	800	800	600	600
		<i>vf</i> (mm/min)	2,240	2,240	1,680	1,200	3,830	3,830	2,010	2,010	4,080	4,080	2,150	2,150
		<i>fz</i> (mm/t)	0.07	0.07	0.07	0.05	0.1	0.1	0.07	0.07	0.1	0.1	0.07	0.07
		<i>ap</i> (mm)	2	1.5	1	0.7	2	1.5	1	0.7	2	1.5	1	0.7
		<i>ae</i> (mm)	< 0.1	< 0.1	< 0.1	< 0.1	< 0.1	< 0.1	< 0.1	< 0.1	< 0.1	< 0.1	< 0.1	< 0.1
鑄鉄 FC FCD Cast irons	BH250	<i>n</i> (min ⁻¹)	19,910	15,930	15,930	15,930	15,930	12,740	12,740	12,740	12,740	10,200	10,200	10,200
		<i>vc</i> (m/min)	1,000	800	800	800	1,000	800	800	800	1,000	800	800	800
		<i>vf</i> (mm/min)	4,780	3,830	3,190	3,190	5,740	4,590	3,830	3,830	6,120	4,900	4,080	4,080
		<i>fz</i> (mm/t)	0.12	0.12	0.1	0.1	0.12	0.12	0.1	0.1	0.12	0.12	0.1	0.1
		<i>ap</i> (mm)	2	1.5	1	0.7	2	1.5	1	0.7	2	1.5	1	0.7
		<i>ae</i> (mm)	< 0.1	< 0.1	< 0.1	< 0.1	< 0.1	< 0.1	< 0.1	< 0.1	< 0.1	< 0.1	< 0.1	< 0.1

■ CBNバーチカル側面仕上げ標準切削条件 Standard cutting conditions for CBN vertical side finishing

被削材 Work material	推奨材種 Recommended grade	工具径DC Tool dia.	φ16(2枚刃) 2 Flutes				φ20(3枚刃) 3 Flutes				φ25(4枚刃) 4 Flutes			
			突出し量 Overhang	モジュラー超硬シャンク Modular carbide shank			高速加工 High-speed cutting	モジュラー超硬シャンク Modular carbide shank			高速加工 High-speed cutting	モジュラー超硬シャンク Modular carbide shank		
				<3DC	3DC-5DC	5DC-7DC		>7DC	<3DC	3DC-5DC		5DC-7DC	>7DC	<3DC
炭素鋼 合金鋼 (30HRC以下) Carbon steels Alloy steels (30HRC or less)	BH250	<i>n</i> (min ⁻¹)	15,930	15,930	11,950	11,950	12,740	12,740	9,560	9,560	10,200	10,200	7,650	7,650
		<i>vc</i> (m/min)	800	800	600	600	800	800	600	600	800	800	600	600
		<i>vf</i> (mm/min)	2,240	2,240	1,680	1,200	3,830	3,830	2,010	2,010	4,080	4,080	2,150	2,150
		<i>fz</i> (mm/t)	0.07	0.07	0.07	0.05	0.1	0.1	0.07	0.07	0.1	0.1	0.07	0.07
		<i>pf</i> (mm)	< 0.5	< 0.5	< 0.5	< 0.5	< 0.6	< 0.6	< 0.6	< 0.6	< 0.7	< 0.7	< 0.7	< 0.7
		<i>ae</i> (mm)	< 0.1	< 0.1	< 0.1	< 0.1	< 0.1	< 0.1	< 0.1	< 0.1	< 0.1	< 0.1	< 0.1	< 0.1
鑄鉄 FC FCD Cast irons	BH250	<i>n</i> (min ⁻¹)	19,910	15,930	15,930	15,930	15,930	12,740	12,740	12,740	12,740	10,200	10,200	10,200
		<i>vc</i> (m/min)	1,000	800	800	800	1,000	800	800	800	1,000	800	800	800
		<i>vf</i> (mm/min)	4,780	3,830	3,190	3,190	5,740	4,590	3,830	3,830	6,120	4,900	4,080	4,080
		<i>fz</i> (mm/t)	0.12	0.12	0.1	0.1	0.12	0.12	0.1	0.1	0.12	0.12	0.1	0.1
		<i>pf</i> (mm)	< 0.5	< 0.5	< 0.5	< 0.5	< 0.6	< 0.6	< 0.6	< 0.6	< 0.7	< 0.7	< 0.7	< 0.7
		<i>ae</i> (mm)	< 0.1	< 0.1	< 0.1	< 0.1	< 0.1	< 0.1	< 0.1	< 0.1	< 0.1	< 0.1	< 0.1	< 0.1

- 【注意】**
- この切削条件表は切削条件の目安を示すものです。実際の加工では加工形状、目的、使用機械等により条件を調整してください。
 - 切りくず噛み込みによる工具損傷防止のため、必ずエアブロー等による切りくず除去を行ってください。
 - 排出した切りくずは、飛散し作業者を切傷させ、火傷あるいは目に入って負傷させる恐れがありますので、ご使用に際してはその周囲に安全カバーを取付け、保護メガネ等の保護具を着用し、安全な環境で作業されることをお願い致します。
 - JSコーティングは通電式タッチセンサーに反応しませんのでご注意ください。
 - インサートの交換は早めに行い、過度の使用による破損を防止してください。
 - 切込み深さ及び1刃送り量の最大値を超えないように設定してください。
 - MZ1000, BH250は湿式切削には適しません。乾式(エアブロー)での使用をお願いします。
 - 不水溶性切削油は、火災の恐れがありますので使用しないで下さい。
 - モジュラーミル用BT30アーバご使用の際は、標準切削条件表を目安に加工条件を決定して下さい。加工状況により振動が懸念される場合は、1.切込み深さ(*ap*)を低減する2.一刃当りの送り(*fz*)を低減する方法で調整下さい。

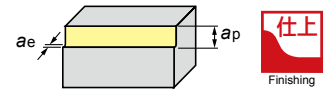

φ32(5枚刃) 5 Flutes				φ40(6枚刃) 6 Flutes				φ50(7枚刃) 7 Flutes				φ63(8枚刃) 8 Flutes				被削材 Work material
<3DC	モジュラー超硬シャンク Modular carbide shank			<3DC	モジュラー超硬シャンク Modular carbide shank			<3DC	3DC-5DC	5DC-7DC	>7DC	<3DC	3DC-5DC	5DC-7DC	>7DC	
高速加工 High-speed cutting	3DC-5DC	5DC-7DC	>7DC	高速加工 High-speed cutting	3DC-5DC	5DC-7DC	>7DC	高速加工 High-speed cutting	3DC-5DC	5DC-7DC	>7DC	高速加工 High-speed cutting	3DC-5DC	5DC-7DC	>7DC	
7,970	7,970	5,980	5,980	6,370	6,370	4,780	4,780	5,100	5,100	3,830	3,830	4,050	4,050	3,040	3,040	炭素鋼 合金鋼 (30HRC以下) Carbon steels Alloy steels (30HRC or less)
800	800	600	600	800	800	600	600	800	800	600	600	800	800	600	600	
3,990	3,990	2,100	2,100	3,830	3,830	2,010	2,010	3,570	3,570	1,880	1,880	3,240	3,240	1,710	1,710	
0.1	0.1	0.07	0.07	0.1	0.1	0.07	0.07	0.1	0.1	0.07	0.07	0.1	0.1	0.07	0.07	
2	1.5	1	0.7	2	1.5	1	0.7	2	2	1.5	1	2	2	1.5	1	
< 0.1	< 0.1	< 0.1	< 0.1	< 0.1	< 0.1	< 0.1	< 0.1	< 0.1	< 0.1	< 0.1	< 0.1	< 0.1	< 0.1	< 0.1	< 0.1	
11,950	9,960	8,960	7,970	9,560	7,970	7,170	6,370	7,650	6,370	5,740	5,100	6,070	5,060	4,550	4,050	鑄鉄 FC FCD Cast irons
1,200	1,000	900	800	1,200	1,000	900	800	1,200	1,000	900	800	1,200	1,000	900	800	
7,170	5,980	4,480	3,990	6,890	5,740	4,310	3,830	6,430	5,360	4,020	3,570	5,830	4,860	3,640	3,240	
0.12	0.12	0.1	0.1	0.12	0.12	0.1	0.1	0.12	0.12	0.1	0.1	0.12	0.12	0.1	0.1	
2	1.5	1	0.7	2	1.5	1	0.7	2	1.5	1	0.7	2	1.5	1	0.7	
< 0.1	< 0.1	< 0.1	< 0.1	< 0.1	< 0.1	< 0.1	< 0.1	< 0.1	< 0.1	< 0.1	< 0.1	< 0.1	< 0.1	< 0.1	< 0.1	

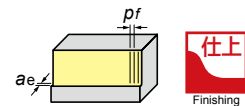

φ32(5枚刃) 5 Flutes				φ40(6枚刃) 6 Flutes				φ50(7枚刃) 7 Flutes				φ63(8枚刃) 8 Flutes				被削材 Work material
<3DC	モジュラー超硬シャンク Modular carbide shank			<3DC	モジュラー超硬シャンク Modular carbide shank			<3DC	3DC-5DC	5DC-7DC	>7DC	<3DC	3DC-5DC	5DC-7DC	>7DC	
高速加工 High-speed cutting	3DC-5DC	5DC-7DC	>7DC	高速加工 High-speed cutting	3DC-5DC	5DC-7DC	>7DC	高速加工 High-speed cutting	3DC-5DC	5DC-7DC	>7DC	高速加工 High-speed cutting	3DC-5DC	5DC-7DC	>7DC	
7,970	7,970	5,980	5,980	6,370	6,370	4,780	4,780	5,100	5,100	3,830	3,830	4,050	4,050	3,040	3,040	炭素鋼 合金鋼 (30HRC以下) Carbon steels Alloy steels (30HRC or less)
800	800	600	600	800	800	600	600	800	800	600	600	800	800	600	600	
3,990	3,990	2,100	2,100	3,830	3,830	2,010	2,010	3,570	3,570	2,690	2,690	3,240	3,240	2,440	2,440	
0.1	0.1	0.07	0.07	0.1	0.1	0.07	0.07	0.1	0.1	0.1	0.1	0.1	0.1	0.1	0.1	
< 0.8	< 0.8	< 0.8	< 0.8	< 0.88	< 0.88	< 0.88	< 0.88	< 1	< 1	< 1	< 1	< 1.12	< 1.12	< 1.12	< 1.12	
< 0.1	< 0.1	< 0.1	< 0.1	< 0.1	< 0.1	< 0.1	< 0.1	< 0.1	< 0.1	< 0.1	< 0.1	< 0.1	< 0.1	< 0.1	< 0.1	
11,950	9,960	8,960	7,970	9,560	7,970	7,170	6,370	7,650	6,370	5,740	5,100	6,070	5,060	4,550	4,050	鑄鉄 FC FCD Cast irons
1,200	1,000	900	800	1200	1000	900	800	1200	1000	900	800	1,200	1,000	900	800	
7,170	5,980	4,480	3,990	6,890	5,740	4,310	3,830	6,430	5,360	4,020	3,570	5,830	4,860	3,640	3,240	
0.12	0.12	0.1	0.1	0.12	0.12	0.1	0.1	0.12	0.12	0.1	0.1	0.12	0.12	0.1	0.1	
< 0.8	< 0.8	< 0.8	< 0.8	< 0.88	< 0.88	< 0.88	< 0.88	< 1	< 1	< 1	< 1	< 1.12	< 1.12	< 1.12	< 1.12	
< 0.1	< 0.1	< 0.1	< 0.1	< 0.1	< 0.1	< 0.1	< 0.1	< 0.1	< 0.1	< 0.1	< 0.1	< 0.1	< 0.1	< 0.1	< 0.1	

- [Note] ① These conditions are for general guidance; in actual machining conditions adjust the parameters according to your actual machine and work-piece conditions.
 ② To prevent tool breakage due to chips clogging tool flutes, always be sure to use an air blower, etc. to remove chips.
 ③ The evacuation of swarf can cause burns, cuts or damage to the eyes please ensure the correct safety cover is fitted around the machine, and necessary personal protection equipment is worn by the machine operator.
 ④ Please note that the JS Coating does not cause a reaction in conductive touch sensors.
 ⑤ Ensure to index the insert at the correct time to ensure safety of the tool-body.
 ⑥ Make settings so that the cutting depth and per-flute feed rate do not exceed the maximum values.
 ⑦ MZ1000 and BH250 are not suitable for wet cutting. Use them for dry cutting (air blow).
 ⑧ Due to fire risks do not use neat cutting oil as a coolant.
 ⑨ When using the BT30 arbor for modular mills, determine the cutting conditions using the standard cutting conditions table as a general guide. If vibrations are a concern due to the cutting conditions, adjust conditions by 1.reducing cutting depth (ap) or 2.reducing per-flute feed rate (fz).

アルファポリッシュミル Vタイプ ASPV

SD5010によるアルミニウム合金及び銅切削条件

Cutting conditions for cutting aluminum alloy and copper using SD5010

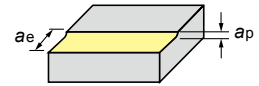

底面仕上げ標準切削条件 Cutting conditions for bottom finishing : $a_e=0.5DC\sim0.7DC$

被削材 Work material	切削条件 Cutting conditions	φ16	φ18	φ20	φ22	φ25	φ28	φ30	φ32	φ35	φ40	φ50	φ63
		2枚刃 ft.	2枚刃 ft.	3枚刃 ft.	3枚刃 ft.	4枚刃 ft.	4枚刃 ft.	4枚刃 ft.	5枚刃 ft.	5枚刃 ft.	6枚刃 ft.	7枚刃 ft.	8枚刃 ft.
アルミニウム合金展伸材 Expanded aluminum alloy material A5052,A7075 等, etc. (エアブローorウェット:水溶性) (Air-blow or wet: Water-soluble agent)	回転数 n (min ⁻¹)	15,900	15,900	15,900	15,900	15,300	13,640	12,730	11,940	10,910	9,550	7,640	6,060
	切削速度 V_c (m/min)	800	900	1,000	1,100	1,200	1,200	1,200	1,200	1,200	1,200	1,200	1,200
	一刃当の送り f_z (mm/t)	0.1	0.1	0.1	0.1	0.1	0.1	0.1	0.08	0.08	0.08	0.06	0.06
	送り速度 V_f (mm/min)	3,180	3,180	4,770	4,770	6,120	5,460	5,090	4,780	4,360	4,580	3,210	2,910
	軸方向切り込み a_p (mm)	0.2	0.2	0.2	0.2	0.2	0.2	0.2	0.2	0.2	0.2	0.2	0.2
アルミニウム合金鋳物 Cast aluminum alloy material AC4A,ADC12 等, etc. (エアブローorウェット:水溶性) (Air-blow or wet: Water-soluble agent)	回転数 n (min ⁻¹)	12,700	12,700	12,700	12,700	12,200	10,900	10,190	9,550	8,730	7,640	6,110	4,850
	切削速度 V_c (m/min)	640	720	800	880	960	960	960	960	960	960	960	960
	一刃当の送り f_z (mm/t)	0.1	0.1	0.1	0.1	0.1	0.1	0.1	0.08	0.08	0.08	0.06	0.06
	送り速度 V_f (mm/min)	2,540	2,540	3,810	3,810	4,900	4,360	4,080	3,820	3,490	3,670	2,570	2,330
	軸方向切り込み a_p (mm)	0.2	0.2	0.2	0.2	0.2	0.2	0.2	0.2	0.2	0.2	0.2	0.2
純銅 Pure copper C1100,C1020 等, etc. (ウェット:水溶性) (Wet: Water-soluble agent)	回転数 n (min ⁻¹)	5,970	5,300	4,770	4,340	3,820	3,410	3,180	2,980	2,730	2,390	1,910	1,520
	切削速度 V_c (m/min)	300	300	300	300	300	300	300	300	300	300	300	300
	一刃当の送り f_z (mm/t)	0.1	0.1	0.1	0.1	0.1	0.1	0.1	0.08	0.08	0.08	0.06	0.06
	送り速度 V_f (mm/min)	1,190	1,060	1,430	1,300	1,530	1,360	1,270	1,190	1,090	1,150	800	730
	軸方向切り込み a_p (mm)	0.2	0.2	0.2	0.2	0.2	0.2	0.2	0.2	0.2	0.2	0.2	0.2

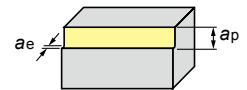

側面仕上げ標準切削条件 Cutting conditions for side finishing : $a_e=0.2\text{mm以下}$ $a_e\leq 0.2\text{mm}$

被削材 Work material	切削条件 Cutting conditions	φ16	φ18	φ20	φ22	φ25	φ28	φ30	φ32	φ35	φ40	φ50	φ63
		2枚刃 ft.	2枚刃 ft.	3枚刃 ft.	3枚刃 ft.	4枚刃 ft.	4枚刃 ft.	4枚刃 ft.	5枚刃 ft.	5枚刃 ft.	6枚刃 ft.	7枚刃 ft.	8枚刃 ft.
アルミニウム合金展伸材 Expanded aluminum alloy material A5052,A7075 等, etc. (エアブローorウェット:水溶性) (Air-blow or wet: Water-soluble agent)	回転数 n (min ⁻¹)	15,900	15,900	15,900	15,900	15,300	13,640	12,730	11,940	10,910	9,550	7,640	6,060
	切削速度 V_c (m/min)	800	900	1,000	1,100	1,200	1,200	1,200	1,200	1,200	1,200	1,200	1,200
	一刃当の送り f_z (mm/t)	0.15	0.15	0.15	0.15	0.15	0.15	0.15	0.15	0.15	0.15	0.18	0.2
	送り速度 V_f (mm/min)	4,770	4,770	7,160	7,160	9,180	8,180	7,640	8,960	8,180	10,300	10,700	9,700
	軸方向切り込み a_p (mm)	2	2	2	2	2	2	2	2	2	2	2	2
アルミニウム合金鋳物 Cast aluminum alloy material AC4A,ADC12 等, etc. (エアブローorウェット:水溶性) (Air-blow or wet: Water-soluble agent)	回転数 n (min ⁻¹)	12,700	12,700	12,700	12,700	12,200	10,900	10,190	9,550	8,730	7,640	6,110	4,850
	切削速度 V_c (m/min)	640	720	800	880	960	960	960	960	960	960	960	960
	一刃当の送り f_z (mm/t)	0.15	0.15	0.15	0.15	0.15	0.15	0.15	0.15	0.15	0.15	0.18	0.2
	送り速度 V_f (mm/min)	3,810	3,810	5,720	5,720	7,320	6,540	6,100	7,160	6,550	8,250	8,550	7,760
	軸方向切り込み a_p (mm)	2	2	2	2	2	2	2	2	2	2	2	2
純銅 Pure copper C1100,C1020 等, etc. (ウェット:水溶性) (Wet: Water-soluble agent)	回転数 n (min ⁻¹)	5,970	5,300	4,770	4,340	3,820	3,410	3,180	2,980	2,730	2,390	1,910	1,520
	切削速度 V_c (m/min)	300	300	300	300	300	300	300	300	300	300	300	300
	一刃当の送り f_z (mm/t)	0.15	0.15	0.15	0.15	0.15	0.15	0.15	0.15	0.15	0.2	0.25	0.25
	送り速度 V_f (mm/min)	1,790	1,590	2,150	1,950	2,290	2,050	1,910	2,240	2,730	2,870	3,340	3,040
	軸方向切り込み a_p (mm)	2	2	2	2	2	2	2	2	2	2	2	2

バーチカル荒加工標準切削条件 Cutting conditions for vertical roughing

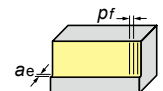

被削材 Work material	切削条件 Cutting conditions	φ16	φ18	φ20	φ22	φ25	φ28	φ30	φ32	φ35	φ40	φ50	φ63
		2枚刃 ft.	2枚刃 ft.	3枚刃 ft.	3枚刃 ft.	4枚刃 ft.	4枚刃 ft.	4枚刃 ft.	5枚刃 ft.	5枚刃 ft.	6枚刃 ft.	7枚刃 ft.	8枚刃 ft.
アルミニウム合金展伸材 Expanded aluminum alloy material A5052,A7075 等, etc. (エアブローorウェット:水溶性) (Air-blow or wet: Water-soluble agent)	回転数 n (min ⁻¹)	15,900	15,900	15,900	15,900	15,300	13,640	12,730	11,940	10,910	9,550	7,640	6,060
	切削速度 V_c (m/min)	800	900	1,000	1,100	1,200	1,200	1,200	1,200	1,200	1,200	1,200	1,200
	一刃当の送り f_z (mm/t)	0.15	0.15	0.15	0.15	0.15	0.15	0.15	0.15	0.15	0.15	0.15	0.15
	送り速度 V_f (mm/min)	4,770	4,770	7,160	7,160	9,180	8,180	7,640	8,960	8,180	8,600	8,020	7,270
	ピックフィード pf (mm)	3.5	4	4	4	4.5	4.5	5	5	5.5	6	6.5	7
	径方向切り込み a_e (mm)	4	4	4	4	4	4	4	4	4	4	4	4
アルミニウム合金鋳物 Cast aluminum alloy material AC4A,ADC12 等, etc. (エアブローorウェット:水溶性) (Air-blow or wet: Water-soluble agent)	回転数 n (min ⁻¹)	12,700	12,700	12,700	12,700	12,200	10,900	10,190	9,550	8,730	7,640	6,110	4,850
	切削速度 V_c (m/min)	640	720	800	880	960	960	960	960	960	960	960	960
	一刃当の送り f_z (mm/t)	0.15	0.15	0.15	0.15	0.15	0.15	0.15	0.15	0.15	0.15	0.15	0.15
	送り速度 V_f (mm/min)	3,810	3,810	5,720	5,720	7,320	6,540	6,100	7,160	6,550	6,880	6,420	5,820
	ピックフィード pf (mm)	3.5	4	4	4	4.5	4.5	5	5	5.5	6	6.5	7
	径方向切り込み a_e (mm)	4	4	4	4	4	4	4	4	4	4	4	4
純銅 Pure copper C1100,C1020 等, etc. (ウェット:水溶性) (Wet: Water-soluble agent)	回転数 n (min ⁻¹)	5,970	5,300	4,770	4,340	3,820	3,410	3,180	2,980	2,730	2,390	1,910	1,520
	切削速度 V_c (m/min)	300	300	300	300	300	300	300	300	300	300	300	300
	一刃当の送り f_z (mm/t)	0.15	0.15	0.15	0.15	0.15	0.15	0.15	0.15	0.15	0.15	0.15	0.15
	送り速度 V_f (mm/min)	1,790	1,590	2,150	1,950	2,290	2,050	1,910	2,240	2,050	2,150	2,000	1,820
	ピックフィード pf (mm)	3.5	4	4	4	4.5	4.5	5	5	5.5	6	6.5	7
	径方向切り込み a_e (mm)	4	4	4	4	4	4	4	4	4	4	4	4

- [注意]**
- ①この切削条件表は切削条件の目安を示すものです。実際の加工では加工形状、目的、使用機械等により条件を調整してください。
 - ②L/D=4以上の場合は回転数と送り速度を60%下げて(0.4倍して)ご使用ください。
 - ③スプラッシュガード付きの機械でご使用ください。ご使用に際しては保護めがね等の保護具を着用して、安全な環境で作業される事をお願いいたします。
 - ④上記条件表の回転数まで上がらない機械の場合は使用可能な回転数に設定して、送り速度は f_z 値で計算してください。
 - ⑤ご使用されるミーリングチャックの許容回転数以内でご使用ください。許容回転数が上記条件表の回転数未満の場合は使用可能な回転数に設定して、送り速度は f_z 値で計算してください。

- [Note]**
- ①These conditions are for general guidance; in actual machining conditions adjust the parameters according to your actual machine and work-piece conditions.
 - ②When L/D = 4 or higher, reduce the rotation speed and feed rate by 60% (set them to 0.4 times the values shown above).
 - ③Use on a machine equipped with splashguards. During use, be sure to wear protective equipment such as safety glasses, and always perform work in a safe environment.
 - ④When using a machine that cannot provide the rotation speed shown above, set the highest rotation speed possible and calculate the feed rate using the f_z value.
 - ⑤Be sure to use this tool at rotation speeds within the acceptable range for the milling chuck being used. If the acceptable rotation speed range is below the rotation speed shown above, set the highest acceptable rotation speed and calculate the feed rate using the f_z value.

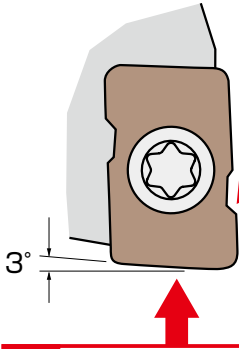

1 復路加工用切れ刃 Cutting edge for reciprocating machining

往復仕上げバーチカル加工の際に復路用切れ刃として作用します。
Used as the cutting edge when performing reciprocating finishing vertical machining.

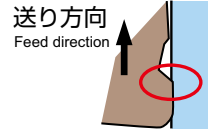

2 外周切れ刃 Peripheral cutting edge

側面加工時の外周切れ刃として作用します。
Used as the peripheral cutting edge when performing side machining.

3 正面切れ刃 Face cutting edge

底面仕上げ加工時に作用します。
Used when bottom finishing.

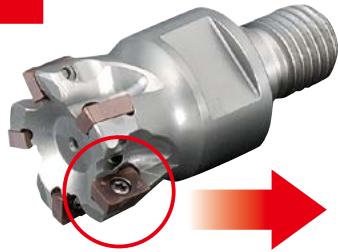

【副切れ刃付きインサート】

Insert with minor cutting edge
MPHW0603○○ZEL-0.5
MPHW0603○○ZEL-1.5



副切れ刃により送り
を上げて使用す
ることが可能です。

minor cutting edge
enables feed rate to be
increased.

【副切れ刃なしインサート】

Insert without minor cutting edge
MPHW0603○○ZEL



底面加工において、突出しの長い
(L/D=5以上)加工や主軸方向に剛
性の低い段取り状態で使用する場
合に適します。

For bottom machining, suitable for long overhang
(L/D= 5 or more) machining or for handling low
rigidity in main axis direction.

※バーチカル加工は副切れ刃
なしを推奨致します。

※For vertical machining, inserts without
minor cutting edge are recommended.

ダイレクトに彫り込み加工も可能 Cutting by direct milling is also possible.

中心まで切れ刃がないため傾斜角度と穴径は制限されますが、右図に示すように傾斜切削やヘリカル切削にて、下穴がなくてもダイレクトに彫り込み加工が可能です。

Since the cutting flute do not extend to the center, there are limitations on the ramp angle and hole diameter, but as shown right, cutting by direct milling without a pilot hole is possible for ramping and helical milling.

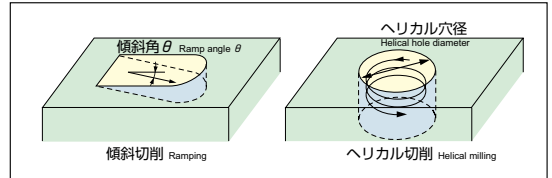

(mm)

使用インサート Inserts	MPN (H) W0603○○ZEL											
工具径DC Tool dia.	φ16	φ18	φ20	φ22	φ25	φ28	φ30	φ32	φ35	φ40	φ50	φ63
最大傾斜角θ Maximum ramp angle θ	2.5°	2.5°	2.5°	2.5°	2.1°	1.8°	1.7°	1.6°	1.4°	1.2°	1°	0.5°
ヘリカル穴径 Hole Dia.	22~30	26~34	30~38	34~42	40~48	46~54	50~58	54~62	60~68	70~78	90~98	116~124

[注意] ① 傾斜角θは上記範囲を超えない様に設定して下さい。0.5°以下での使用を推奨します。

② 穴径が上記範囲以外の場合は下穴を開けて加工して下さい。

[Note] ① The ramp angle θ should be set within the ranges listed above. Use at ramp angles of 0.5° or less is recommended.

② For hole diameters outside the ranges listed above, a pilot hole should be drilled before milling.

ザグリ加工用 ASPV-Z

- 既存の穴に、高効率ザグリ穴加工ができる!!
- ・ Can perform high-efficiency Z plunging of existing holes.



○は数字が入ります。 Numeric figure in a circle ○

ASPVM20○○R-○-Z モジュラータイプ Modular type

モジュラーミル用シャンクはD2頁を、締め付けトルクについてはD5頁を参照ください。 Refer page D2 about the shanks for Modular Mill, Refer page D5 about tightening torque

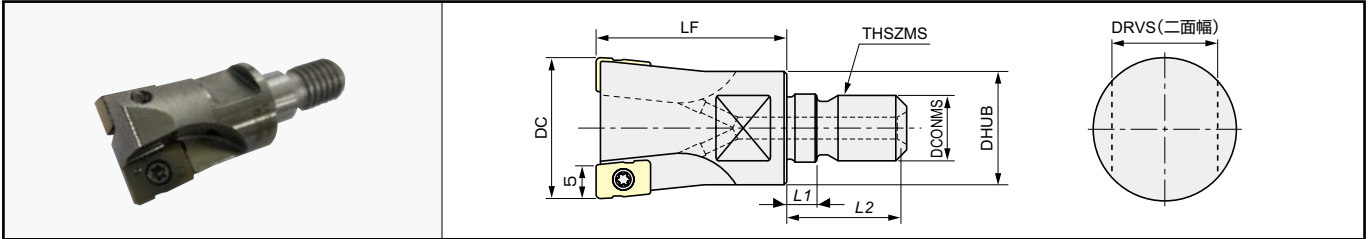

商品コード Item code	在庫 Stock	刃数 No. of flutes	寸法 Size (mm)								適用インサート Insert
			DC	LF	DCONMS	THSZMS	DHUB	L1	L2	DRVS	
ASPVM2016R-2-Z	○	2	16	25	8.5	M8	12.8	5.5	17	10	MPHW060308ZEL
ASPVM2018R-2-Z	○	2	18	25	8.5	M8	14.5	5.5	17	10	
ASPVM2020R-3-Z	○	3	20	30	10.5	M10	17.8	5.5	19	15	
ASPVM2026R-3-Z	○	3	26	35	12.5	M12	20.8	5.5	22	17	

【注意】モジュラーミル及び専用シャンクの「工具端面」「モジュラーねじ部」にグリースなどの潤滑剤は塗布しないでください。
【Note】 Do not apply lubricants such as grease, etc. to the "contact faces" and "modular screws" of the "modular mill" and "dedicated shanks".

インサート Inserts

商品コード Item code	精度 Tolerance class	AJコーティング AJ Coating		寸法 Size (mm)				希望小売価格 (円) Suggested retail price (¥)
		JP4105	JP4120	W1	S1	LE	RE	
MPHW060308ZEL	H級 H	●	●	6.35	3.18	3	0.8	1,430

部品番号 Parts

○は数字が入ります。 Numeric figure in a circle ○

部品名 Parts	クランプねじ Clamp screw	ドライバー Screw driver	ねじ焼き付き防止剤 Screw anti-seizure agent
形状 Shape			
適用カッター Cutter body	締付トルク Fastening torque (N·m)	希望小売価格(円) Suggested retail price (¥)	希望小売価格(円) Suggested retail price (¥)
ASPVM20○○R-○-Z	250-141	1.1	870
		希望小売価格(円) Suggested retail price (¥)	希望小売価格(円) Suggested retail price (¥)
		104-T8	1,800
			P-37
			1,010

【注意】クランプねじは消耗品です。使用環境により交換寿命は変化しますので早めの交換をお願い致します。

【Note】 The clamp screw is a consumable part. Since replacement life depends on the use environment, it is recommended that it be replaced at an early stage.

標準切削条件表 Recommended cutting conditions

※赤字は推奨材種です。 Red indicates primary recommended insert grade.

被削材 Work material	推奨材種 Recommended grade	n (min ⁻¹)	φ16 (2枚刃 Flutes)	φ18 (2枚刃 Flutes)	φ20 (3枚刃 Flutes)	φ26 (3枚刃 Flutes)
			60HRC プリハードン 開発鋼 (株プロテリアル製) SLD-f Pre-hardened development steel (made by Proterial, Ltd.)	JP4105 JP4120	vc (m/min)	1989
		vf (mm/min)	100	100	100	100
		fn (mm/rev)	80	71	96	73
		ステップ量 Step feed (mm)	0.04	0.04	0.06	0.06
		ステップ戻し量 Step back feed (mm)	0.5	0.5	0.5	0.5
		切削液 Coolant	1.0	1.0	1.0	1.0
			内部給油 Internal	内部給油 Internal	内部給油 Internal	内部給油 Internal
加工代(径): ザグリ穴加工径と既に空いている穴径の差 Machining amount (diametrical): Difference between existing hole diameter and Z plunging hole diameter			≤8	≤8	≤8	≤8

【注意】この切削条件表は切削条件の目安を示すものです。実際の加工では加工形状、目的、使用機械等により条件を調整してください。

【Note】 These conditions are for general guidance; in actual machining conditions adjust the parameters according to your actual machine and work-piece conditions.

●印：標準在庫品です。 ●：Stocked items. ○印：メーカー在庫品です。 ○：Manufacturer stocked items.

○ ご使用方法 How to use

既に空いている穴径に対して、径で+8mm以下のザグリ穴加工が可能。

(ザグリ穴径に対して径で-8mm以上の穴が既に空いている必要あり)

*貫通されていない穴は加工不可

例) $\phi 12$ の貫通穴に $\phi 18$ のザグリ穴加工をする場合

Z plunging up to 8mm larger than existing hole diameter is possible.
(For Z plunging, an existing hole of within -8mm of the Z plunging hole diameter is necessary.)

* Z plunging of blind holes is not possible.

Ex.) When performing a $\phi 18$ mm Z plunging of a $\phi 12$ mm through hole.

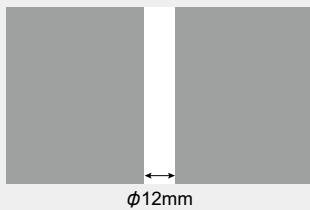

ガイドザグリ穴加工 (鋼シャンク使用)
Machining a guide hole (using a steel shank)

- ・加工深さ: 工具径 $\times 1 \sim 2$ 倍
- ・ステップ加工
- ・内部給油

- ・Machining depth: 1 to 2 times the tool diameter
- ・Step machining
- ・Internal coolant

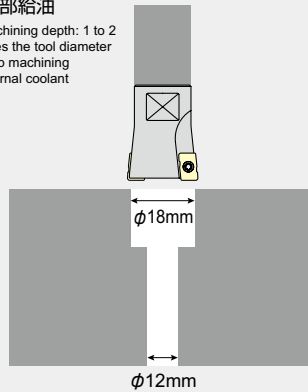

ザグリ穴加工 (超硬シャンク使用)
Z plunging (using a carbide shank)

- ・ステップ加工

- ・加工深さ:
超硬シャンク取り付け時の首下長未満

- ・内部給油

- ・Step machining
- ・Machining depth:
Less than under neck length when carbide shank is used together
- ・Internal coolant

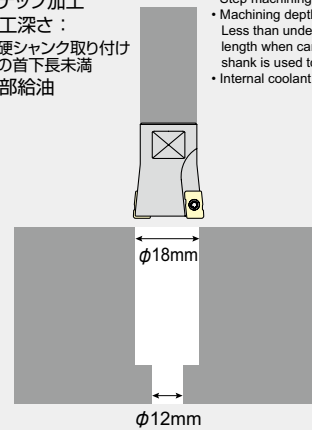

[注意] 穴内部での切りくずつまりを防止するため、ステップ加工と内部給油で切りくずを排出させながら加工を行ってください。

[Note] To prevent chip clogging inside the hole, perform machining while discharging chips by use of step machining and internal coolant.

Max1 刃先交換式エンドミル MX

- 底面切削では、安定した面粗さが得られ鏡面仕上げが可能です。
- 側面切削では、高能率加工ができます。
- ・ For bottom surface cutting even surface roughness is obtained, thus miller surface finish is available
- ・ For side surface cutting a highly efficient machining is available.



MX3 ○○○○(-○○)

○は数字が入ります。 Numeric figure in a circle ○

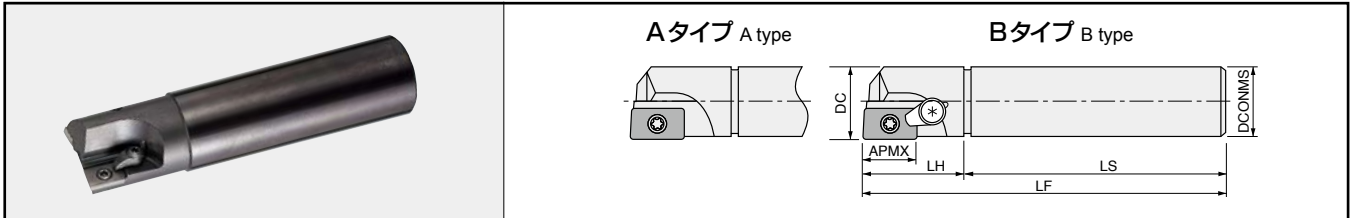

商品コード Item code	在庫 Stock	刃数 No. of flutes	寸法 Size (mm)						形状 Shape	適用インサート Inserts	希望小売価格(円) Suggested retail price(¥)
			DC	LF	DCONMS	APMX	LH	LS			
レギュラー Regular	●	1	10	70	10	8.5	20	50	A	MT0920○33	14,080
	●	1	12	80	12	8.5	25	55	A		14,670
	●	1	16	90	16	14	30	60	A	MT1530○33	20,300
	●	1	20	110	20	14	30	80	B		21,590
	●	2	25	120	25	14	40	80	B		35,190
	●	2	32	130	32	14	40	90	B		38,370
	●	2	40	150	32	14	40	110	B		40,470
ロングシャンク Long shank	●	1	20	200	20	14	50	150	A		25,350
	●	2	25	220	25	14	60	160	A		40,710
	●	2	32	250	32	14	80	170	A		43,530

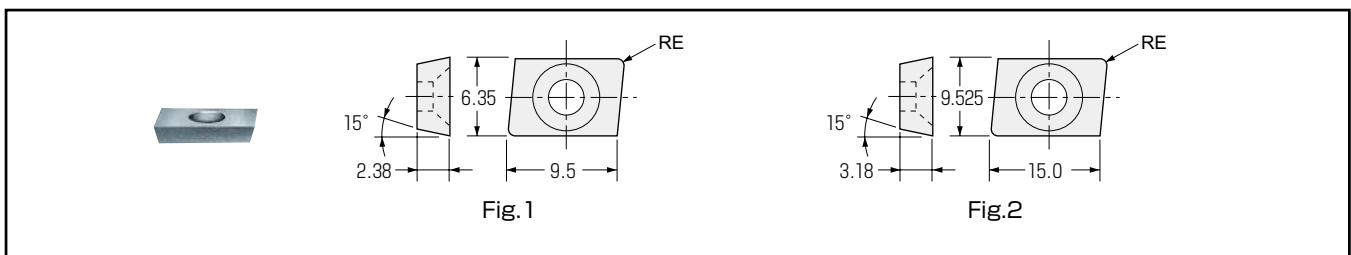

■ インサート Inserts



商品コード Item code	サーメット Cermet		コーナ半径 RE Corner radius	形状 Shape	希望小売価格 (円) Suggested retail price (¥)
	Max 1				
MT0920133	●		0.4	Fig. 1	1,560
MT0920233	●		0.8		1,560
MT1530133	●		0.4	Fig. 2	2,370
MT1530233	●		0.8		2,370

●印：標準在庫品です。 ●：Stocked items.

■ 部品番号 Parts

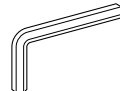
部品名 Parts	クランプ駒セット Clamp piece set	クランプねじ Clamp screw	レンチ Wrench			
適用カッタ Cutter body	形状 Shape					
	部品番号 Parts No.	希望小売価格(円) Suggested retail price(¥)	部品番号 Parts No.	希望小売価格(円) Suggested retail price(¥)	部品番号 Parts No.	希望小売価格(円) Suggested retail price(¥)
MX31100 MX31120	-	-	MXSS2T	570	MXLT8	350
MX31200 MX32250 MX32320 MX32400	MXCP2T	2,250	MXSS4T	570	MXLT15	350
MX31160 MX31200-20 MX32250-22 MX32320-25	-	-				

● 標準切削条件表 Recommended cutting conditions

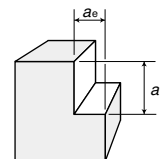

<肩削り> Shoulder milling

被削材 Work material	切削速度 m/min Cutting speed	一刃当りの送り mm/t Feed rate	φ 10		φ 12		φ 16		φ 20	
			回転数 min ⁻¹	送り速度 mm/min	回転数 min ⁻¹	送り速度 mm/min	回転数 min ⁻¹	送り速度 mm/min	回転数 min ⁻¹	送り速度 mm/min
一般構造用鋼 Mild steels (200HB 以下)	80 ~ 180	0.1 ~ 0.15	5,090	660	4,240	550	3,180	410	2,550	330
$v_c=160\text{m/min } f_z=0.13\text{mm/t } a_p=1\text{mm } a_e=0.8\text{DC}$										
炭素鋼・合金鋼 Carbon steels, Alloy steels (30HRC 以下)	60 ~ 150	0.1 ~ 0.15	3,820	500	3,180	410	2,390	310	1,910	250
$v_c=120\text{m/min } f_z=0.13\text{mm/t } a_p=0.5\text{mm } a_e=0.8\text{DC}$										
炭素鋼・合金鋼 Carbon steels, Alloy steels (40HRC 以下)	60 ~ 120	0.08 ~ 0.15	2,550	260	2,120	210	1,590	160	1,270	130
$v_c=80\text{m/min } f_z=0.1\text{mm/t } a_p=0.5\text{mm } a_e=0.8\text{DC}$										

被削材 Work material	切削速度 m/min Cutting speed	一刃当りの送り mm/t Feed rate	φ 25		φ 32		φ 40			
			回転数 min ⁻¹	送り速度 mm/min	回転数 min ⁻¹	送り速度 mm/min	回転数 min ⁻¹	送り速度 mm/min		
一般構造用鋼 Mild steels (200HB 以下)	80 ~ 180	0.1 ~ 0.15	2,040	530	1,590	410	1,270	330		
$v_c=160\text{m/min } f_z=0.13\text{mm/t } a_p=1\text{mm } a_e=0.8\text{DC}$										
炭素鋼・合金鋼 Carbon steels, Alloy steels (30HRC 以下)	60 ~ 150	0.1 ~ 0.15	1,530	400	1,190	310	950	250		
$v_c=120\text{m/min } f_z=0.13\text{mm/t } a_p=0.5\text{mm } a_e=0.8\text{DC}$										
炭素鋼・合金鋼 Carbon steels, Alloy steels (40HRC 以下)	60 ~ 120	0.08 ~ 0.15	1,020	200	800	160	640	130		
$v_c=80\text{m/min } f_z=0.1\text{mm/t } a_p=0.5\text{mm } a_e=0.8\text{DC}$										



ASDF 【高送りタイプ】 High-feed-rate type

- 高送り加工 (最大 $f_z=2.5\text{mm/t}$)
- 機械の最大能力を引き出す高能率荒加工に対応
 - ・ High-feed-rate cutting (Maximum $f_z=2.5\text{mm/t}$)
 - ・ Compatible with high-efficiency roughing that takes full advantage of machine capabilities.

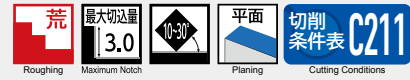

○は数字が入ります。Numeric figure in a circle○.

ASDF5○○○R(M)-○(U)

ボアタイプ用アーバはD11頁を参照ください。
Refer page D11 about the bore type arbor



Fig.1 (エア穴付き) (With air hole)

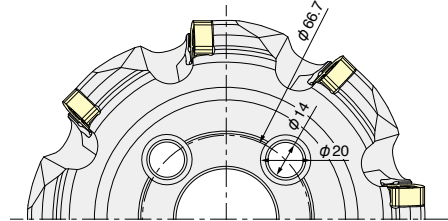

Fig.2 (エア穴無し) (Without air hole)

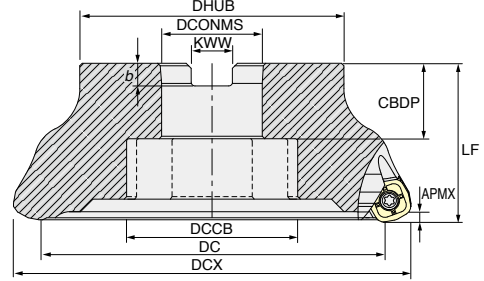
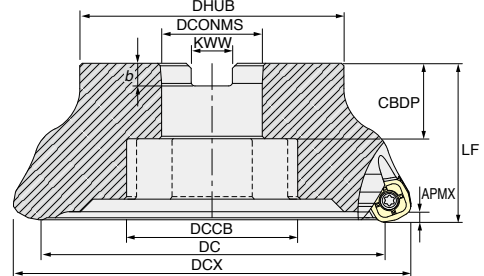
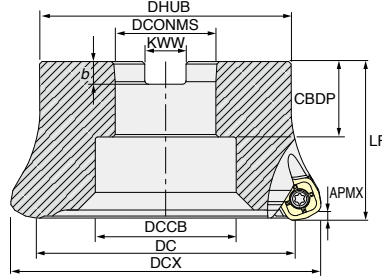
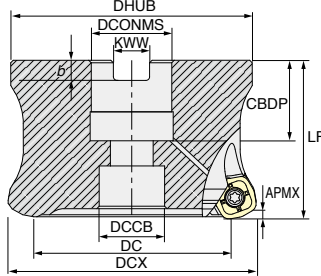

Fig.3 (エア穴無し) (Without air hole)



商品コード Item code	在庫 Stock	刃数 No. of flutes	寸法 Size (mm)											適用 インサート Inserts	希望小売 価格(円) Suggested Retail Price (¥)	
			工具径 Tool dia.		DHUB	LF	CBDP	キー幅 Key width		DCONMS	DCCB	APMX	形状 Figure			重量 Weight (kg)
			DC	DCX				KWW	b							
ボアタイプ Internal diameter inch size	ASDF5063R-4	●	4	42	63	60	50	19	8.4	5	22.225	17	3	Fig.1	0.7	77,660
	ASDF5063R-4U	●	4	42	63	60	50	19	8.4	5	22.225	17	3	Fig.1	0.7	77,660
	ASDF5080R-4	●	4	59	80	76	63	32	12.7	8	31.75	26	3	Fig.1	1.3	85,050
	ASDF5080R-4U	●	4	59	80	76	63	32	12.7	8	31.75	26	3	Fig.1	1.3	85,050
	ASDF5100R-5	●	5	79	100	96	63	32	12.7	8	31.75	26	3	Fig.1	2.4	104,870
	ASDF5100R-5U	●	5	79	100	96	63	32	12.7	8	31.75	26	3	Fig.1	2.4	104,870
	ASDF5125R-6	●	6	104	125	100	63	38	15.9	10	38.1	60	3	Fig.2	3.0	130,210
	ASDF5125R-6U	●	6	104	125	100	63	38	15.9	10	38.1	60	3	Fig.2	3.0	130,210
	ASDF5125R-8U	●	8	104	125	100	63	38	15.9	10	38.1	60	3	Fig.2	3.0	148,980
	ASDF5160R-8	●	8	139	160	105	63	38	19.1	11	50.8	80	3	Fig.3	4.3	172,440
内径ミリサイズ Internal diameter mm size	ASDF5160R-8U	●	8	139	160	105	63	38	19.1	11	50.8	80	3	Fig.3	4.3	172,440
	ASDF5160R-10U	●	10	139	160	105	63	38	19.1	11	50.8	80	3	Fig.3	4.3	193,550
	ASDF5063RM-4	●	4	42	63	60	50	20	10.4	6.3	22	17	3	Fig.1	0.7	77,660
	ASDF5063RM-4U	●	4	42	63	60	50	20	10.4	6.3	22	17	3	Fig.1	0.7	77,660
	ASDF5080RM-4	●	4	59	80	76	63	22	12.4	7	27	20	3	Fig.1	1.5	85,050
	ASDF5080RM-4U	●	4	59	80	76	63	22	12.4	7	27	20	3	Fig.1	1.5	85,050
	ASDF5100RM-5	●	5	79	100	96	63	32	14.4	8	32	26	3	Fig.1	2.4	104,870
	ASDF5100RM-5U	●	5	79	100	96	63	32	14.4	8	32	26	3	Fig.1	2.4	104,870
	ASDF5125RM-6	●	6	104	125	100	63	30	16.4	9	40	56	3	Fig.2	3.0	130,210
	ASDF5125RM-6U	●	6	104	125	100	63	30	16.4	9	40	56	3	Fig.2	3.0	130,210
ASDF5125RM-8U	●	8	104	125	100	63	30	16.4	9	40	56	3	Fig.2	3.0	148,980	
ASDF5160RM-8	●	8	139	160	105	63	30	16.4	9	40	68	3	Fig.3	4.3	172,440	
ASDF5160RM-8U	●	8	139	160	105	63	30	16.4	9	40	68	3	Fig.3	4.3	172,440	
ASDF5160RM-10U	●	10	139	160	105	63	30	16.4	9	40	68	3	Fig.3	4.3	193,550	

【注意】アーバ用ねじは付属しません。【Note】Arbor screw is not included.

※ASDF形は「工具最大径DCX」を刃径基準としています。ASDH形とは異なるので注意してください。

※ASDF type uses the maximum tool diameter DCX as the flute diameter standard. This is different than for ASDH type, so care should be taken.

商品コード末尾に「U」があるアイテムは、不等分割ピッチとなります。Items with a "U" at the end of the item code have an unequal pitch.

●印：標準在庫品です。 ●：Stocked items.

標準切削条件表 Recommended cutting conditions

ASDF 【高送りタイプ】 High-feed-rate type

※赤字は第一推奨材種です。
Red indicates primary recommended grade.

被削材 Work material	推奨材種 Recommended grade	切削速度 Vc(m/min) Cutting speed	一刃当りの送り fz(mm/t) feed rate	φ63-4枚刃 4 flutes		φ80-4枚刃 4 flutes		φ100-5枚刃 5 flutes		φ125-6枚刃 6 flutes		φ160-8枚刃 8 flutes	
				回転数 n(min ⁻¹)	送り速度 Vf(mm/min)	回転数 n(min ⁻¹)	送り速度 Vf(mm/min)	回転数 n(min ⁻¹)	送り速度 Vf(mm/min)	回転数 n(min ⁻¹)	送り速度 Vf(mm/min)	回転数 n(min ⁻¹)	送り速度 Vf(mm/min)
一般構造用鋼 Mild steels (200HB以下)	※ GX2140 JS4045	150~200	1.0~2.0	810	4850	640	3820	510	3820	410	3670	320	3820
				vc=160m/min fz=1.5mm/t ap=1.5mm ae=0.7×DCX									
炭素鋼・合金鋼 Carbon & Alloy steels (30HRC以下)	GX2140 JS4045	100~180	1.0~2.0	710	4240	560	3340	450	3340	360	3210	280	3340
				vc=140m/min fz=1.5mm/t ap=1.5mm ae=0.7×DCX									
炭素鋼・合金鋼 Carbon & Alloy steels (30~40HRC)	JP4120 JS4045 GX2140	100~160	1.0~2.0	610	3640	480	2870	380	2870	310	2750	240	2870
				vc=120m/min fz=1.5mm/t ap=1.5mm ae=0.7×DCX									
炭素鋼・合金鋼 Carbon & Alloy steels (40~45HRC)	JP4120 JS4045	80~120	0.4~0.8	460	1460	360	1150	290	1150	230	1100	180	1150
				vc=90m/min fz=0.8mm/t ap=1.0mm ae=0.7×DCX									
ステンレス鋼 Stainless steels SUS	JM4160 JP4120	80~100	0.8~1.2	460	1820	360	1430	290	1430	230	1380	180	1430
				vc=90m/min fz=1mm/t ap=1.0mm ae=0.7×DCX									
鋳鉄 Cast irons FC, FCD	JP4120 GX2120 JS4045	100~180	1.0~2.0	810	4850	640	3820	510	3820	410	3670	320	3820
				vc=160m/min fz=1.5mm/t ap=1.5mm ae=0.7×DCX									
焼入れ鋼 Hardened steels (45~50HRC)	JP4120	60~100	0.3~0.6	350	570	280	450	220	450	180	430	140	450
				vc=70m/min fz=0.4mm/t ap=0.8mm ae=0.7×DCX									

- 【注意】**
- ①GXコーティング、JSコーティングは通電式タッチセンサーに反応しませんのでご注意ください。
 - ②被削材、加工形状に合わせて、適切なクーラントを使用してください。
 - ③この切削条件表は切削条件の目安を示すものです。実際の加工では、加工形状、目的、使用機械等により条件を調整してください。
 - ④インサートの交換は早めに行い、過度の使用による破損を防止してください。
 - ⑤排出した切りくずは、飛散し作業者を切傷させ、やけどあるいは目に入って負傷させる恐れがありますので、ご使用に際してはその周囲に安全カバーを取付け、保護メガネなどの保護具を着用し、安全な環境で作業されることをお願い致します。
 - ⑥不水溶性切削油は、火災の恐れがありますので使用しないでください。

- 【Note】**
- ①Please note that the GX Coating and JS Coating don't cause a reaction in conductive touch sensors.
 - ②Use the appropriate coolant for the work material and machining shape.
 - ③These conditions are for general guidance; in actual machining conditions adjust the parameters according to your actual machine and work-piece conditions.
 - ④In order to avoid of insert breakage, please change insert earlier.
 - ⑤The steel chips may cause cuts, burns or damages to eyes. Be sure to install the safety cover around the tool and wear the safety glasses when carrying out any works.
 - ⑥Please don't use cutting oil as coolant.(It may be cause of fire.)

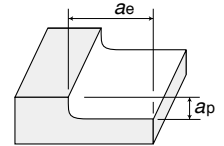

ASDF 形を形状加工で使用する場合 When using ASDF type for shaping cutting

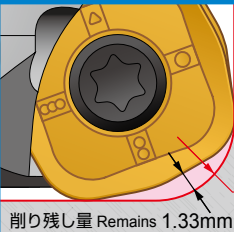

プログラム上の刃先形状定義は下記を参照ください。
Refer to the following for the flute tip condition definitions for programming.

プログラミングR Programming R definition = R6
削り残し量 Remains 1.33mm

- ※傾斜加工はφ63,φ80で0.5°以下、φ100以上では行わないで下さい。
- ※工具突出しが長い場合(L/D ≥ 3)はapを調整して下さい。
- ※For slanted cutting using φ63 or φ80, perform at 0.5° or less.
- Do not perform using φ100 or larger.
- ※When tool overhang length is long (L/D ≥ 3), adjust ap.

工具径と切削動力

Tool diameter and cutting power

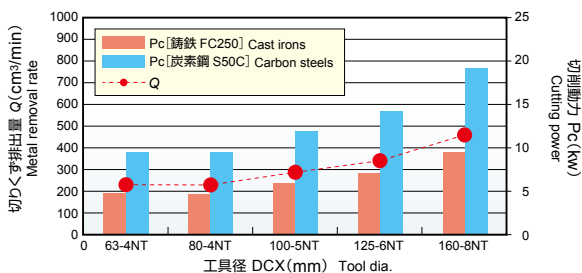

参考切削条件 ASDF形(高送り) ASDF type (High-feed-rate type)
Reference cutting condition Vc = 180m/min fz = 1.5mm/t ap × ae = 1.0 × 0.7DCX mm
エアブロー Air-blow

参考切削条件における各工具径ごとの必要切削動力Pcの算出結果です。工具径選定の目安としてご使用ください。
本数値は一般的な機械条件で算出している為、実際の数値と異なる場合があります。
The chart shows the calculated results for required cutting power Pc for each tool diameter under the reference cutting conditions. Please use as criteria when selecting tool diameter. These values are calculated from general machinery conditions, and may be different from actual values.



ASDH [高切込みタイプ] High-cutting-depth type

- 高切込み加工 (有効刃長 10mm)
- 鋳肌などの切込変動が大きい被削材
- テーブル送りが制限された環境
- 加工商品位を必要とする加工

- ・ High-cutting-depth machining. (Effective flute length: 10mm)
- ・ Work materials with large variations in cutting depth such as cast surfaces, etc.
- ・ Environments where table feed rate is limited.
- ・ Cutting when processed surface grade is required.



○は数字が入ります。 Numeric figure in a circle ○

ASDH5○○○R(M)-○○○

ボアタイプ用アーバはD11頁を参照ください。
Refer page D11 about the bore type arbor

刃先交換式工具
フェースミル

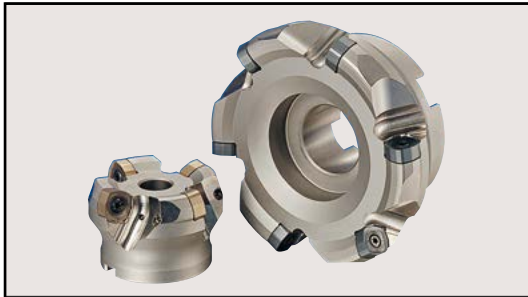

Fig.1 (エアーク付き) (With air hole)

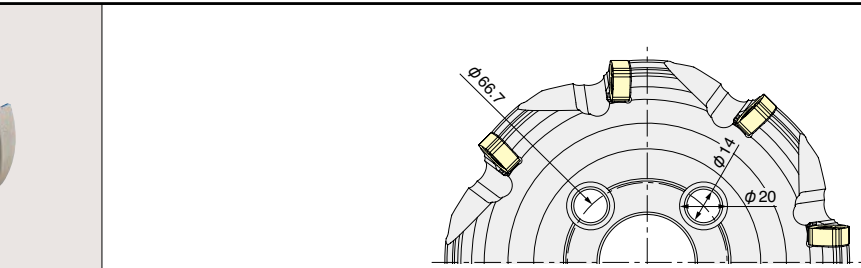

Fig.2 (エアーク無し) (Without air hole)

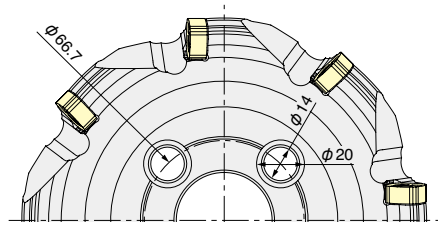
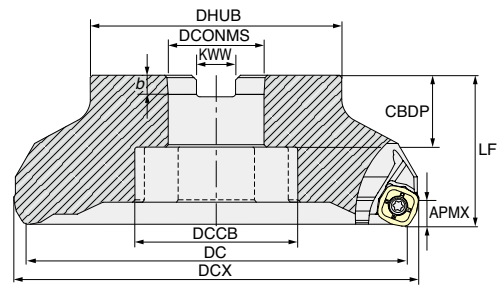
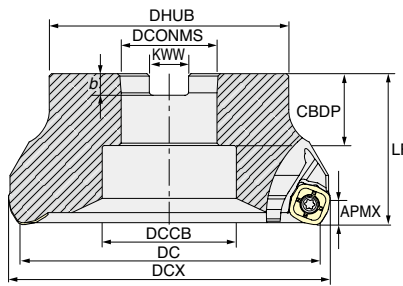
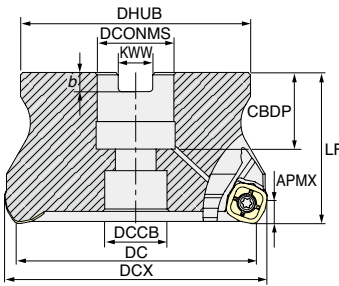

Fig.3 (エアーク無し) (Without air hole)



商品コード Item code	在庫 Stock	刃数 No. of flutes	寸法 Size (mm)										形状 Shape	重量 Weight (kg)	適用インサート Inserts	希望小売 価格(円) Suggested retail price (¥)
			工具径 Tool dia.		DHUB	LF	CBBP	キーク幅 Key width		DCONMS	DCCB	APMX				
			DC	DCX				KWW	b							
ASDH5063R-4	●	4	63	75	60	50	19	8.4	5	22.225	17	10	Fig.1	0.9	SNMU1607EN-C SNGU1607EN-C SNMU1607EN-B	77,660
ASDH5080R-4	●	4	80	92	76	63	32	12.7	8	31.75	26	10	Fig.1	1.7		85,050
ASDH5100R-5	●	5	100	112	96	63	32	12.7	8	31.75	26	10	Fig.1	2.8		104,870
ASDH5125R-6	●	6	125	137	100	63	38	15.9	10	38.1	60	10	Fig.2	3.6		130,210
ASDH5125R-8	●	8	125	137	100	63	38	15.9	10	38.1	60	10	Fig.2	3.6		151,320
ASDH5160R-8	●	8	160	172	105	63	38	19.1	11	50.8	80	10	Fig.2	5.2		172,440
ASDH5160R-10	●	10	160	172	105	63	38	19.1	11	50.8	80	10	Fig.2	5.1		193,550
ASDH5063RM-4	●	4	63	75	60	50	20	10.4	6.3	22	17	10	Fig.1	0.9		77,660
ASDH5080RM-4	●	4	80	92	76	63	22	12.4	7	27	20	10	Fig.1	1.8		85,050
ASDH5100RM-5	●	5	100	112	96	63	32	14.4	8	32	26	10	Fig.1	2.8		104,870
ASDH5125RM-6	●	6	125	137	100	63	30	16.4	9	40	56	10	Fig.2	3.6	130,210	
ASDH5125RM-8	●	8	125	137	100	63	30	16.4	9	40	56	10	Fig.2	3.5	151,320	
ASDH5160RM-8	●	8	160	172	105	63	30	16.4	9	40	68	10	Fig.3	5.2	172,440	
ASDH5160RM-10	●	10	160	172	105	63	30	16.4	9	40	68	10	Fig.3	5.1	193,550	

【注意】アーバ用ねじは付属しません。【Note】Arbor screw is not included.

※ASDH形は「工具先端径DC」を刃径基準としています。ASDF形とは異なるので注意してください。

※ASDH type uses the tool tip diameter DC as the flute diameter standard. This is different than for ASDF type, so care should be taken.

※ASDH形は形状加工には使用できません。

※ASDH type cannot be used for shaping cutting.

●印：標準在庫品です。 ●：Stocked items.

標準切削条件表 Recommended cutting conditions

ASDH 【高切込みタイプ】 High-cutting-depth type

※赤字は第一推奨材種です。
Red indicates primary recommended grade.

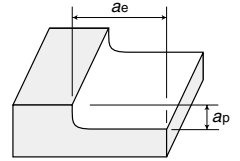

被削材 Work material	推奨材種 Recommended grade	切削速度 Vc(m/min) Cutting speed	一刃当りの送り fz(mm/t) feed rate	φ63-4枚刃 4 flutes		φ80-4枚刃 4 flutes		φ100-5枚刃 5 flutes		φ125-6枚刃 6 flutes		φ160-8枚刃 8 flutes	
				回転数 n(min ⁻¹)	送り速度 Vf(mm/min)	回転数 n(min ⁻¹)	送り速度 Vf(mm/min)	回転数 n(min ⁻¹)	送り速度 Vf(mm/min)	回転数 n(min ⁻¹)	送り速度 Vf(mm/min)	回転数 n(min ⁻¹)	送り速度 Vf(mm/min)
一般構造用鋼 Mild steels (200HB以下)	※ GX2140 JS4045	150~200	0.1~0.5	810	970	640	760	510	760	410	730	320	760
				vc=160m/min fz=0.3mm/t ap=5mm ae=0.7×DC									
炭素鋼・合金鋼 Carbon & Alloy steels (30HRC以下)	GX2140 JS4045	100~180	0.1~0.5	710	850	560	670	450	670	360	640	280	670
				vc=140m/min fz=0.3mm/t ap=4mm ae=0.7×DC									
炭素鋼・合金鋼 Carbon & Alloy steels (30~40HRC)	JP4120 JS4045 GX2140	100~160	0.1~0.3	610	490	480	380	380	380	310	370	240	380
				vc=120m/min fz=0.2mm/t ap=4mm ae=0.7×DC									
炭素鋼・合金鋼 Carbon & Alloy steels (40~45HRC)	JP4120 JS4045	80~120	0.1~0.15	460	220	360	170	290	170	230	170	180	170
				vc=90m/min fz=0.12mm/t ap=3mm ae=0.7×DC									
ステンレス鋼 Stainless steels SUS	JM4160 JP4120	80~100	0.1~0.4	460	550	360	430	290	430	230	410	180	430
				vc=90m/min fz=0.3mm/t ap=3mm ae=0.7×DC									
鋳鉄 Cast irons FC, FCD	JP4120 GX2120 JS4045	100~180	0.1~0.5	810	970	640	760	510	760	410	730	320	760
				vc=160m/min fz=0.3mm/t ap=5mm ae=0.7×DC									
焼入れ鋼 Hardened steels (45~50HRC)	JP4120	60~100	0.1~0.15	350	170	280	130	220	130	180	130	140	130
				vc=70m/min fz=0.12mm/t ap=2mm ae=0.7×DC									

- 【注意】**
- ①GXコーティング、JSコーティングは通電式タッチセンサーに反応しませんのでご注意ください。
 - ②被削材、加工形状に合わせて、適切なクーラントを使用してください。
 - ③この切削条件表は切削条件の目安を示すものです。実際の加工では、加工形状、目的、使用機械等により条件を調整してください。
 - ④インサートの交換は早めに行い、過度の使用による破損を防止してください。
 - ⑤排出した切りくずは、飛散し作業者を切傷させ、やけどあるいは目に入って負傷させる恐れがありますので、ご使用に際してはその周囲に安全カバーを取付け、保護メガネなどの保護具を着用し、安全な環境で作業されることをお願い致します。
 - ⑥不水溶性切削油は、火災の恐れがありますので使用しないでください。

- 【Note】**
- ①Please note that the GX Coating and JS Coating don't cause a reaction in conductive touch sensors.
 - ②Use the appropriate coolant for the work material and machining shape.
 - ③These conditions are for general guidance; in actual machining conditions adjust the parameters according to your actual machine and work-piece conditions.
 - ④In order to avoid of insert breakage, please change insert earlier.
 - ⑤The steel chips may cause cuts, burns or damages to eyes. Be sure to install the safty cover around the tool and wear the safty glasses when carrying out any works.
 - ⑥Please don't use cutting oil as coolant.(It may be cause of fire.)

工具径と切削動力

Tool diameter and cutting power

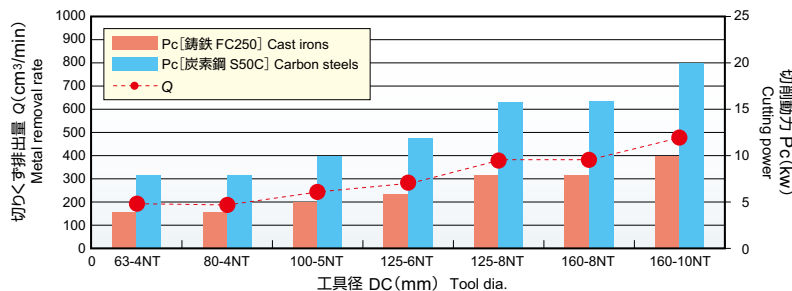

参考切削条件 ASDH形(高切込み) ASDH type (High-cutting-depth type)
Reference cutting condition Vc = 150m/min fz = 0.3mm/t
ap×ae = 5.0 × 0.7DC mm エアブロー Air-blow

参考切削条件における各工具径ごとの必要切削動力Pcの算出結果です。工具径選定の目安としてご使用ください。本数値は一般的な機械条件で算出している為、実際の数値と異なる場合があります。

The chart shows the calculated results for required cutting power Pc for each tool diameter under the reference cutting conditions. Please use as criteria when selecting tool diameter. These values are calculated from general machinery conditions, and may be different from actual values.

アルファデュアルフェースミル ASDF/ASDH

■ インサート Inserts



○ 快削Bブレーカ B breaker for lower cutting force

▶ 快削Bブレーカ追加による切削抵抗低減

B breaker for lower cutting force is now available.

- 切れ刃形状をポジティブ設定にすることで、切削抵抗を従来形状に比べ10%低減。
- 切削抵抗低減により、剛性が低い加工環境下においても、良好な切削を実現。

- ・ Positive edge geometry realizes 10% lower cutting force than before.
- ・ B breaker realizes better cutting performance in less rigidity set-up.

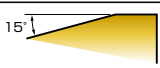
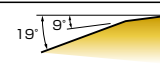
C ブレーカ C Breaker		B ブレーカ B Breaker	
SNMU1607EN-C SNGU1607EN-C	商品コード Item code	SNMU1607EN-B	
	ブレーカ形状 Breaker shape		
	断面形状 Cross-section shape		
<ul style="list-style-type: none"> ・ 金型など一般的な鋼加工 ・ 断続加工 ・ Suitable for general machining in steels ・ Interrupted machining 	用途 Application	<ul style="list-style-type: none"> ・ マシン剛性が低い加工 ・ 保持が不安定な部品加工 ・ ステンレス鋼など ・ Machining with less rigidity set-up ・ Parts-making in less rigidity cramping ・ Suitable for stainless steel machining 	

○ 振動抑制ポデー Anti-vibration body ASDF5○○R(M)-○U

▶ 不等分割ピッチによるビビリ振動対策

Anti-vibration bodies by unequal pitch.

- インサートを不等分割ピッチで配列することにより、ビビリ振動の主要因である自励振動を抑制。
- 従来品に比べ、ビビリ振動を抑制することで、切込み限界を改善する事が可能。

- ・ Unequal pitch reduces a vibration which is a main factor of chattering.
- ・ Less chatter vibration improve productivity.

図 各分割方法での限界切込深さ(6D)一切削テスト

Comparison of the maximum depth of cut (L/D=6).



図1. 切削テスト 限界切込深さ L/D=6 The maximum depth-of-cut evaluation



商品コード Item code	精度 Tolerance class	AJコーティング AJ Coating		JSコーティング JS Coating	GXコーティング GX Coating		寸法 Size(mm)		形状 Shape	希望小売価格 (円) Suggested retail price(¥)
		JP4120	JM4160	JS4045	GX2120	GX2140	IC	T		
SNMU1607EN-C	M級 M	●	●	●	●	●	φ16	6.6	Fig.1	1,900
SNMU1607EN-B		●	●	●	●	●			Fig.2	1,900
SNGU1607EN-C	G級 G	●	●	●	●	●			Fig.1	3,000

[注意] GXコーティング、JSコーティングは通電式タッチセンサーに反応しませんのでご注意ください。
 [Note] Please note that the GX Coating and JS Coating don't cause a reaction in conductive touch sensors.

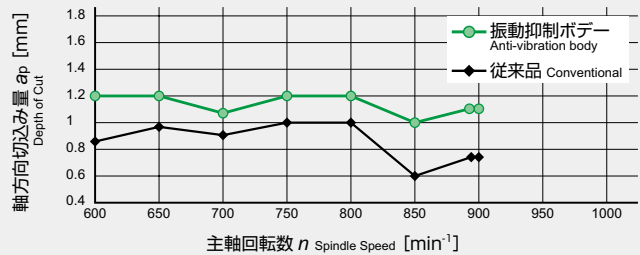
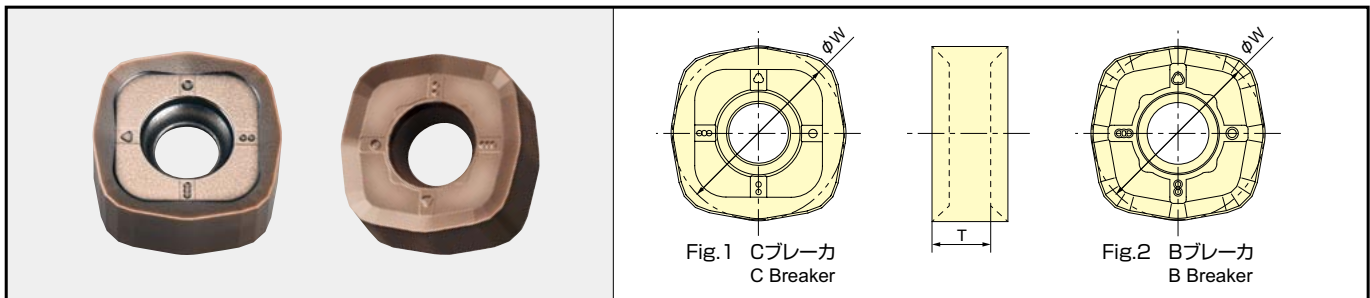
インサートの使い分け

How to select inserts

○は数字が入ります。Numeric figure in a circle ○.

	ブレーカ形状 Breaker shape	用途 Application
SN○U1607EN-C	汎用 General purpose	第一選択 Primary recommendation
SN○U1607EN-B	低抵抗 Low cutting force	ステンレス鋼などの切れ味が必要な被削材に適する。It is suitable for materials such as stainless steels.

●印：標準在庫品です。 ●：Stocked items.

部品番号 Parts

○は数字が入ります。 Numeric figure in a circle ○

部品名 Parts	クランプねじ Clamp screw	レンチ Wrench		ねじ焼き付き防止剤 Screw anti-seizure agent					
形状 Shape									
適用カット Cutter body	締付トルク Fastening torque (N·m)	希望小売 価格(円) Suggested retail price (¥)	希望小売 価格(円) Suggested retail price (¥)	希望小売 価格(円) Suggested retail price (¥)					
ASDF5○○○R(M)-○ ASDH5○○○R(M)-○	555-141	4.9	690	105-T20	2,120	105-T20L	2,120	P-37	1,010

【注意】 クランプねじは消耗品です。使用環境により交換寿命は変化しますので早めの交換をお願い致します。

【Note】 The clamp screw is a consumable part. Since replacement life depends on the use environment, it is recommended that it be replaced at an early stage.

ボデーの使い分けマップ Body usage map

● 加工環境にあわせて選択可能な2種のボデーをラインアップ

・ Lineup of two types of bodies so you can select the appropriate one for your working environment.

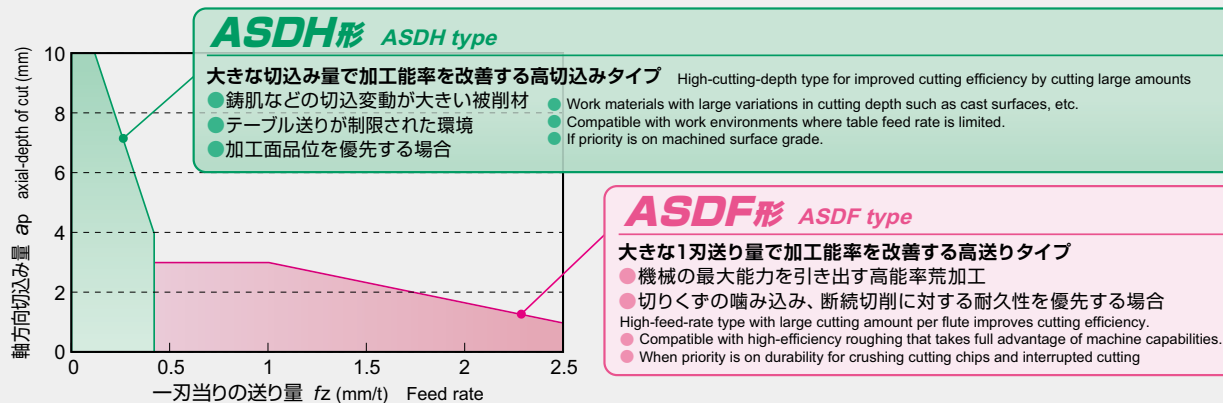

インサートの交換手順 Insert replacement procedure

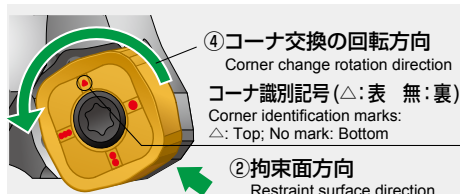

- ① インサート取付け部に切りくず等の異物が付着していないように清掃して下さい。
- ② クランプねじのネジ部に焼き付き防止剤を塗布し、インサートを拘束面方向に押当てながら適切なトルクで締付けて下さい。(推奨締付トルク4.9Nm)
- ③ 締付け後にインサートと座面及び拘束面に隙間が無いことを確認して下さい。
- ④ インサートのコーナ交換は反時計方向に回転させる順番で行って下さい。
 - ① Clean the place where the insert will be attached so that there are no foreign materials such as cutting chip stuck on.
 - ② Apply anti-seizure agent to the thread portion of the clamp screw, and while pressing the insert against the restraint surface, tighten the screw to the appropriate torque. (Recommended tightening torque: 4.9Nm)
 - ③ After tightening, check that there are no gaps between the insert and the base or the restraint surface.
 - ④ Change the insert corner by turning the insert counterclockwise direction.

アルファ高送り正面フライス ASF

- 常識を超えた切削送り速度で、従来品に比較し3~5倍の加工能率アップができ、加工時間短縮、加工費削減ができます。
 - インサートは独特のR形状で最大切込み深さは3mmです。
- ・ At higher-than-normal cutting feed rates, offers 3 to 5 times the cutting performance of conventional products, reducing cutting time and processing costs.
- ・ Insert has a unique R shape to enable maximum cutting depth of 3mm.



○は数字が入ります。Numeric figure in a circle.

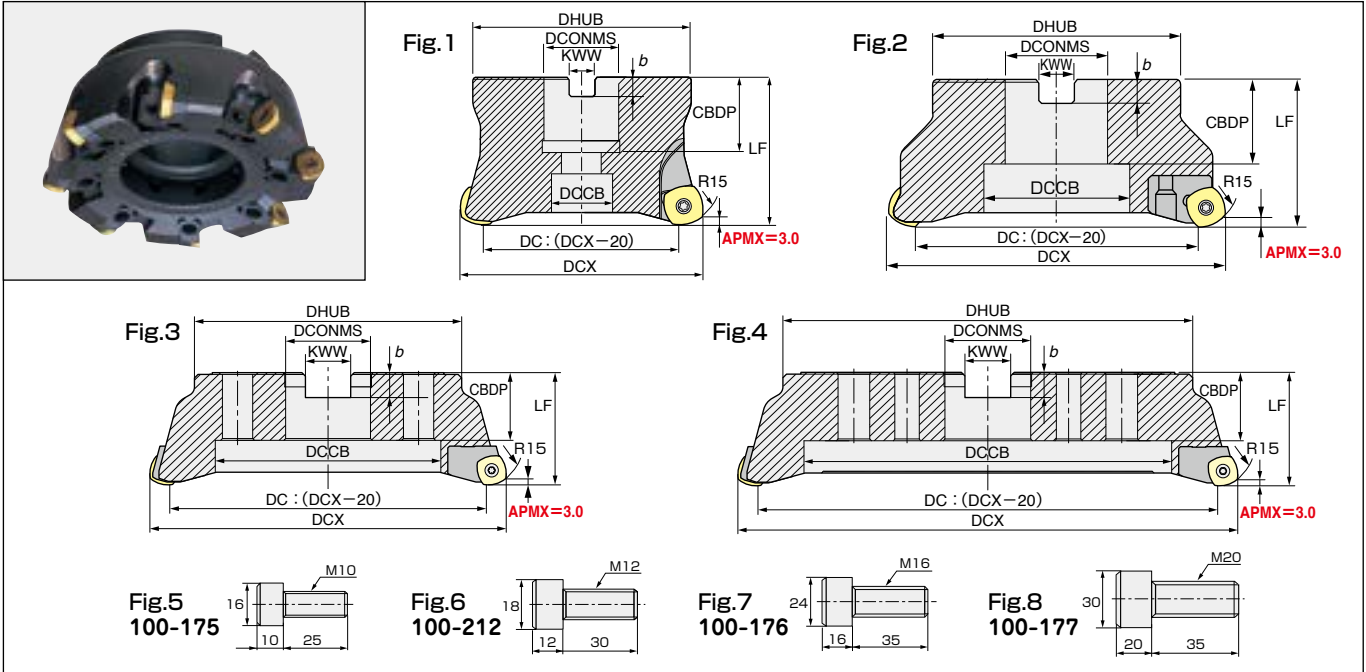

ASF5○○○R(-○) 内径インチサイズ Internal diameter inch size

ボアタイプ用アーバはD11頁を参照ください。
Refer page D11 about the bore type arbor

商品コード Item code	在庫 Stock	刃数 No. of flutes	寸法 Size (mm)								重量 Weight (kgf)	形状 Shape	アーバ用ねじ (六角穴付きボルト) Arbor screw (Hexagonal socket head bolt)	適用インサート Inserts	希望小売 価格(円) Suggested retail price(¥)	
			DCX	DC	LF	CBDP	KWW	b	DCONMS	DCCB						DHUB
ASF5063R	●	4	63	43	50	19	8.4	5	22.225	17	60	0.65	Fig.1	市販アーバ 部品 Commercial arbor parts	N級 N class SDNW1505 ZDTN-R15	71,100
ASF5080R	●	4	80	60	63	32	12.7	8	31.75	26	70	1.35				92,800
ASF5100R	●	5	100	80	63	32	12.7	8	31.75	26	90	2.26				127,860
ASF5125R	●	6	125	105	63	32	12.7	8	31.75	26	100	4.38				143,110
ASF5160R-6		6	160	140	63	38	19.1	11	50.8	69	105	4.60	Fig.2	M級 M class SDMT1505 ZDTN-R/	—	
ASF5160R	●	8	160	140	63	38	19.1	11	50.8	69	105	4.60			182,990	
ASF5200R-8		8	200	180	63	38	25.4	14	47.625	105	150	7.62	Fig.3	C15	—	
ASF5200R	●	10	200	180	63	38	25.4	14	47.625	105	150	7.62			256,890	
ASF5250R-9		9	250	230	63	38	25.4	14	47.625	140	200	13.44			—	
ASF5250R	●	12	250	230	63	38	25.4	14	47.625	140	200	13.44	Fig.4	E級 E class SDEW1505 ZDTN-R15	314,370	
ASF5315R		14	315	295	63	38	25.4	14	47.625	220	265	20.77			—	

ASF5○○○RM(-○) 内径ミリサイズ Internal diameter mm size

商品コード Item code	在庫 Stock	刃数 No. of flutes	寸法 Size (mm)								重量 Weight (kgf)	形状 Shape	アーバ用ねじ (六角穴付きボルト) Arbor screw (Hexagonal socket head bolt)	適用インサート Inserts	希望小売 価格(円) Suggested retail price(¥)	
			DCX	DC	LF	CBDP	KWW	b	DCONMS	DCCB						DHUB
ASF5063RM	●	4	63	43	50	20	10.4	6.3	22	17	60	0.65	Fig.1	市販アーバ 部品 Commercial arbor parts	N級 N class SDNW1505 ZDTN-R15	71,100
ASF5080RM	●	4	80	60	63	22	12.4	7	27	20	70	1.35				92,800
ASF5100RM	●	5	100	80	63	25.5	14.4	8	32	26	90	2.26				127,860
ASF5125RM	●	6	125	105	63	30	16.4	9	40	32	100	4.38				143,110
ASF5160RM-6		6	160	140	63	30	16.4	9.5	40	69	105	4.60	Fig.2	M級 M class SDMT1505 ZDTN-R/C15	—	
ASF5160RM	●	8	160	140	63	30	16.4	9.5	40	69	105	4.60			—	
ASF5200RM-8		8	200	180	63	32	25.7	14	60	105	150	7.62	Fig.3	C15	—	
ASF5200RM	●	10	200	180	63	32	25.7	14	60	105	150	7.62			—	
ASF5250RM-9		9	250	230	63	32	25.7	14	60	140	200	13.44			—	
ASF5250RM	●	12	250	230	63	32	25.7	14	60	140	200	13.44	Fig.4	E級 E class SDEW1505 ZDTN-R15	—	
ASF5315RM		14	315	295	63	32	25.7	14	60	220	265	20.77			—	

【注意】φ125以下のカット本体には、アーバ取り付け用ねじが付属しています。【Note】The cutter bodies under diameter 125mm include an arbor screw.

●印：標準在庫品です。 ●：Stocked items. 無印：弊社営業へお問合せください。 No mark：Contact with our sales department.

■ インサート Inserts

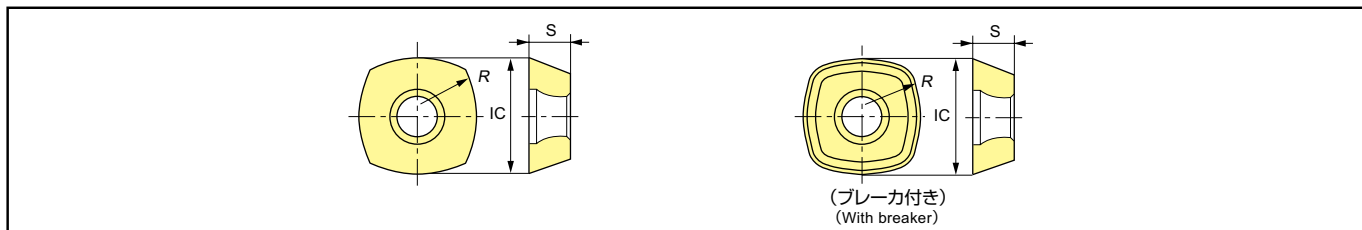

P	鋼	Carbon steels									■：一般切削・第一推奨 General cutting, First recommended				
	M	SUS等	SUS, etc.									□：一般切削・第二推奨 General cutting, Second recommended			
K	FC・FCD	Cast iron													
H	高硬度材	Hardened steels													
商品コード Item code	精度 Tolerance class	コーティング Coating							寸法 Size (mm)			希望小売価格(円) Suggested retail price (¥)			
		JP4105	JP4120	JM4160	GX2140	JS4045	JS4060	CY250	CH550	R	S	IC	AJ,GX, JS コーティング AJ,GX, JS Coating	CY250	CH550
SDNW1505ZDTN-R15	N級 N	●	●	●	●	●	●	●	●	●	●	●	1,900	1,730	—
SDMT1505ZDTN-R15 (ブレーカ付き) (With breaker)	M級 M	●	●	●	●	●	●	●	●	●	●	●	1,900	—	—
SDMT1505ZDTN-C15 (ブレーカ,ワイパー付き) (With breaker & wiper)	M級 M			●	●	●	●	●	●	●	●	●	1,900	1,730	1,340
SDEW1505ZDTN-R15	E級 E						●						3,000	2,720	—

【注意】 GX コーティング、JS コーティングは通電式タッチセンサーに反応しませんのでご注意ください。
 【Note】 Please note that the GX Coating and JS Coating do not cause a reaction in conductive touch sensors.

材種マップ (35HRC未達の鋼材)

Grade map for less than 35HRC

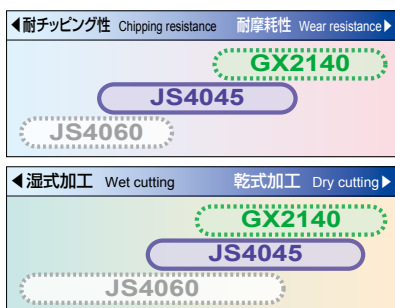

被削材別推奨材種マップ

Grade map for work material

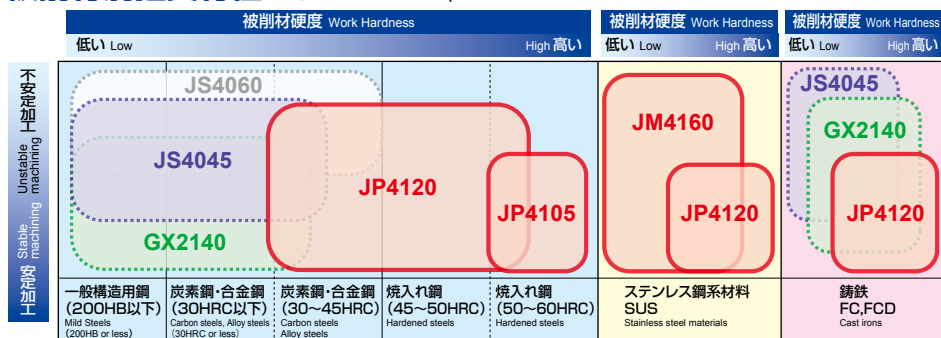

■ 部品番号 Parts

部品名称 Parts	クランプねじ Clamp screw			サポータ Locator		サポータ止めねじ Locator screw		ダブルスクリュー Double screw		クサビ Wedge		レンチ Wrench		ねじ焼き付き防止剤 Screw anti-seizure agent	
形状 Shape	締付トルク fastening torque (N・m)	希望小売 価格(円) Suggested retail price (¥)		希望小売 価格(円) Suggested retail price (¥)	希望小売 価格(円) Suggested retail price (¥)	希望小売 価格(円) Suggested retail price (¥)	希望小売 価格(円) Suggested retail price (¥)	希望小売 価格(円) Suggested retail price (¥)	希望小売 価格(円) Suggested retail price (¥)	希望小売 価格(円) Suggested retail price (¥)	形状 Shape	希望小売 価格(円) Suggested retail price (¥)	希望小売 価格(円) Suggested retail price (¥)	希望小売 価格(円) Suggested retail price (¥)	
適用カッタ Cutter body											A B				
ASF5063R/RM ~ASF5100R/RM											105-T20	A	2,120		
ASF5125R/RM	555-141	4.9	690			156-161 (適用レンチ: 100-221)	280 (950)	100-143 (適用レンチ: 100-221)	540 (950)	176-121	3,420			P-37	
ASF5160R/RM(-6) ~ASF5315R/RM				351-111	7,730							B	2,120	1,010	

【注意】 クランプねじは消耗品です。使用環境により交換寿命は変化しますので早めの交換をお願い致します。クランプねじはφ125までは予備が2本、φ160以上は予備が4本付属します。
 【Note】 The clamp screw is a consumable part. Since replacement life depends on the use environment, it is recommended that it be replaced at an early stage. Two spare clamp screws are provided for φ125 or less, and four for φ160 or more.

アルファ高送り正面フライス ASF

標準切削条件表 Recommended cutting conditions

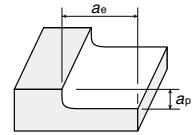

※赤字は第一推奨材種です。
Red indicates primary recommended grade.

被削材 Work material	推奨材種 Recommended grade	切削速度 Cutting speed Vc(m/min)	一刃当りの送り fz (mm/t) Feed rate	φ63 (4枚刃 Flutes)		φ100 (5枚刃 Flutes)		φ160 (8枚刃 Flutes)		φ200 (10枚刃 Flutes)		φ250 (12枚刃 Flutes)	
				回転数n min ⁻¹	送り速度vf mm/min	回転数n min ⁻¹	送り速度vf mm/min	回転数n min ⁻¹	送り速度vf mm/min	回転数n min ⁻¹	送り速度vf mm/min	回転数n min ⁻¹	送り速度vf mm/min
一般構造用鋼 Mild steels (200HB以下)	※ GX2140 JS4045 JS4060	150~200	1.0~2.0	910	5,460	570	4,300	360	4,320	290	4,350	230	4,140
		vc=180m/min fz=1.5mm/t ap=1.5mm ae=0.7DCX											
炭素鋼・合金鋼 Carbon steels, Alloy steels (30HRC以下)	JP4120 GX2140 JS4045	100~180	1.0~2.0	810	4,860	510	3,830	320	3,840	255	3,830	205	3,700
		vc=160m/min fz=1.5mm/t ap=1.5mm ae=0.7DCX											
炭素鋼・合金鋼 Carbon steels, Alloy steels (30~40HRC)	JP4120 GX2140 JS4045	100~160	1.0~2.0	810	4,860	510	3,830	320	3,840	255	3,830	205	3,700
		vc=160m/min fz=1.5mm/t ap=1.5mm ae=0.7DCX											
炭素鋼・合金鋼 Carbon steels, Alloy steels (40~45HRC)	JP4120 JS4045	80~120	0.4~0.8	505	1,620	320	1,280	200	1,280	160	1,280	127	1,220
		vc=100m/min fz=0.8mm/t ap=1.5mm ae=0.7DCX											
ステンレス鋼 Stainless steels	JM4160	100	1.0~2.0	455	1,820	286	1,430	180	1,430	143	1,430	115	1,400
		vc=90m/min fz=1.0mm/t ap=2.0mm ae=0.7DCX											
鋳鉄 Cast irons FC, FCD	GX2140 JS4045 JP4120	100~180	1.0~2.0	810	6,480	510	5,100	320	5,100	255	5,100	205	5,000
		vc=160m/min fz=2.0mm/t ap=1.0mm ae=1.0DCX											
焼入れ鋼 Hardened steels (45~50HRC)	JP4120 JP4105	80~120	0.2~0.4	455	550	286	430	180	430	143	430	115	415
		vc=90m/min fz=0.3mm/t ap=1.5mm ae=0.7DCX											
焼入れ鋼 Hardened steels (50~60HRC)	JP4105 JP4120	50~100	0.05~0.2	350	280	220	220	140	220	110	220	90	210
		vc=70m/min fz=0.2mm/t ap=1.0mm ae=0.7DCX											

【注意】 ① 被削材、加工形状に合わせて、適切なクーラントを使用してください。
② この切削条件表は切削条件の目安を示すものです。実際の加工では加工形状、目的、使用機械等により条件を調整してください。
③ GXコーティング、JSコーティングは通電式タッチセンサーに反応しませんのでご注意ください。
④ [JP4105]は高硬度鋼専用材種で、生材には適しません。

【Note】 ① Use the appropriate coolant for the work material and machining shape.
② These conditions are for general guidance; in actual machining conditions adjust the parameters according to your actual machine and work-piece conditions.
③ Please note that the GX Coating and JS Coating do not cause a reaction in conductive touch sensors.
④ [JP4105] insert's grade specialized in High hardened steel is not suitable for Non-heat-treated steel material.

特長 Features

アルファ 高送り正面フライス ASF形は、常識を超えた高効率加工を提案いたします。

Super Face Mill ASF proposes you tremendous high-efficiency machining.

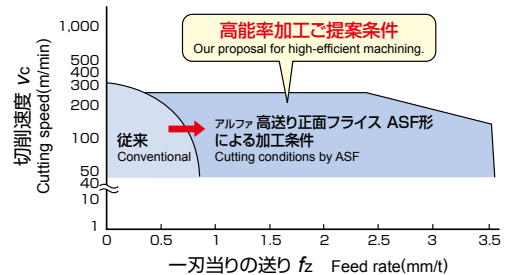

01 インサートは独特のR切刃形状 Unique R shaped insert

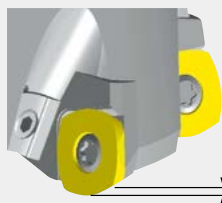

平面削り用として、インサートは4コーナ使用できます。また、最大切り込み深さはAPMX=3.0mmまで可能です。

Economical four-edge insert with max. depth of cut APMX=3.0mm

APMX=3.0

02 切りくず排出性を考慮した大きなチップポケット Large chip pocket for smooth chip-flow

大きく長い切りくずができる面削り加工でも、切りくずがクサビと干渉することなく優れた切りくず処理性があります。

When big and long chips are created, it is superior chip-removability without interference of chips on the wedges.



03 従来品に比較し、2~5倍の加工能率アップができ、加工時間短縮、加工費削減ができます。

Machining time and machining cost are reduced with 2-5 times higher efficiency compared with conventional face mill.

ご使用される加工機械との適合により、単位時間当りの切りくず排出量Qが1,000~2,000cm³/minと、驚異的な仕事量を示します。
(従来:Q=200~400cm³/min)
Superior higher production speed:Q=1,000~2,000cm³/min
(conventional:Q=200~400cm³/min)

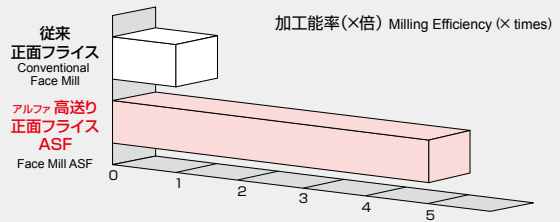

04 常識を超えた切削送り速度 Extraordinary High-feed

1刃当りの送りは、高送り(鋼切削: $f_z = 0.2 \sim 3.5 \text{ mm/t}$ 、鋳鉄切削: $f_z = 0.8 \sim 4.0 \text{ mm/t}$)で使用でき、加工機械の送り能力を最大限に引き出すことができます。

Cutting with high feed rate is applicable which maximizes the processing machine capability (Steel milling: $f_z = 0.2 \sim 3.5 \text{ mm/t}$, Cast iron milling: $f_z = 0.8 \sim 4.0 \text{ mm/t}$)

05 優れた断続切削性能 Superior Interrupted performance

穴のたくさんあいた激しい断続切削でも、従来品のような初期の欠損がなく、12倍以上の安定した寿命があります。
In case of heavy interrupted machining of work with many holes, it is not chipped at the beginning of cutting as conventional face mill, and shows 12 times longer tool life.

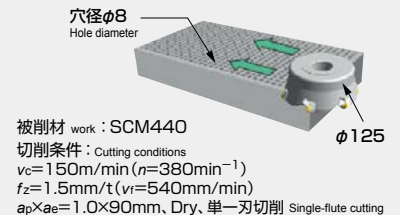

06 仕上げ面粗さ Surface finish

コーティングインサートでRz12.5以下。サーメット(CH550)では、Rz6.3以下の粗さとなります。仕上げ面粗さを重要視される加工にはサーメット(CH550)をご使用下さい。
Coated carbide inserts: under Rz12.5, Cermet inserts: under Rz6.3. Cermet (CH550) is recommended for better surface finish.

使用インサート Inserts	切削条件 Cutting conditions	仕上げ面精度測定結果 Surface roughness
SDNW1505ZDTN-R15 (コーティングインサート) Coating inserts	$v_c = 200 \text{ m/min}$ ($n = 510 \text{ min}^{-1}$) $v_f = 920 \text{ mm/min}$ ($f_z = 0.3 \text{ mm/t}$) $a_p = 0.3 \text{ mm}$	 Rz=9.5μm
SDMT1505ZDTN-C15 サーメットCH550 Cermet (ブレーカ、ワイパー付) (With breker & wiper)	$v_c = 250 \text{ m/min}$ ($n = 640 \text{ min}^{-1}$) $v_f = 570 \text{ mm/min}$ ($f_z = 0.15 \text{ mm/t}$) $a_p = 0.1 \text{ mm}$	 Rz=4.8μm

07 比切削抵抗 Specific cutting resistance

切削動力Hpを求める為の計算式と比切削抵抗Ksを次のグラフに示します。ご使用時の目安としてください。尚、ご使用される加工機械の、主軸回転域により、本来の動力が出ない場合がありますので、そのような場合は、回転数を上げるなどして調整して下さい。

Formula of cutting horse power Hp is shown in the graph with specific cutting resistance Ks.

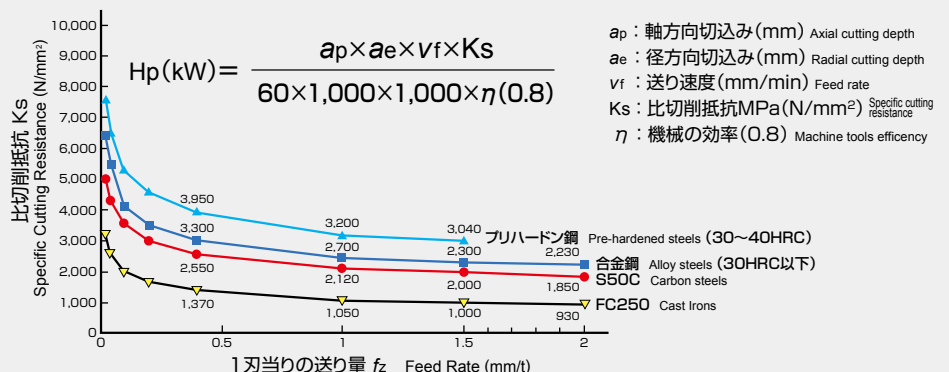

アルファ正面フライス AFE45

- 20° ポジインサート使用のハイレーキ刃形
 - インサートクランプはねじ止め式で切りくず排出性に優れます。
 - ユニークな超硬シート形状により低切削抵抗な刃形を表現。
- ・High-rake flute shape using 20° positive inserts.
 ・Insert clamps are screw-holding types for excellent chip discharge.
 ・Unique carbide sheet shape enables a low cutting resistance flute shape.



AFE45-4○○○R-○○

○は数字が入ります。Numeric figure in a circle ○.

ボアタイプ用アーバはD11頁を参照ください。
Refer page D11 about the bore type arbor

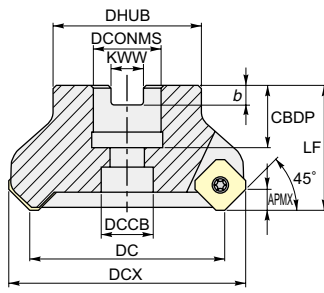

Fig. 1

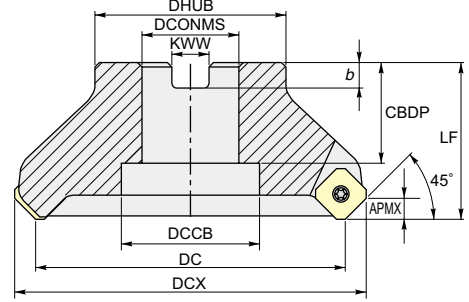

Fig. 2

商品コード Item code	在庫 Stock	刃数 No. of flutes	寸法 Size (mm)										重量 Weight (kg)	形状 Shape	適用インサート Inserts	希望小売 価格(円) Suggested retail price (¥)
			DC	LF	DCX	DCONMS	DCCB	CDBP	APMX	KWW	b	DHUB				
AFE45-4050R-3	●	3	50	40	63.4	22	17	20	6	10.4	6.3	48	0.5	Fig.1	SEET13T3AGTN SEET13T3AGIN-S	40,010
AFE45-4063R-4	●	4	63	40	76.6	22	17	20		10.4	6.3	48	0.6			46,920
AFE45-4080R-4	●	4	80	50	93.5	25.4	35	26		9.5	6	52	1.04			52,090
AFE45-4100R-5	●	5	100	50	113.5	31.75	45	32		12.7	8	62	1.58	Fig.2		64,520
AFE45-4125R-6	●	6	125	63	138.5	38.1	70	38		15.9	10	82	3.18			77,190
AFE45-4160R-8	●	8	160	63	173.4	50.8	80	40		19.1	11	101	5.17			103,000
AFE45-4050R-4	●	4	50	40	63.4	22	17	20	6	10.4	6.3	48	0.45	Fig.1		45,880
AFE45-4063R-5	●	5	63	40	76.6	22	17	20		10.4	6.3	48	0.56			57,250
AFE45-4080R-6	●	6	80	50	93.5	25.4	35	26		9.5	6	52	0.94			71,440
AFE45-4100R-7	●	7	100	50	113.5	31.75	45	32		12.7	8	62	1.48	Fig.2		84,120
AFE45-4125R-8	●	8	125	63	138.5	38.1	70	38		15.9	10	82	3.05		92,440	
AFE45-4160R-10	●	10	160	63	173.4	50.8	80	40		19.1	11	101	5.08		115,670	

【注意】アーバ用ねじは付属しません。【Note】Arbor screw is not included.

部品番号 Parts

○は数字が入ります。Numeric figure in a circle ○.

部品名 Parts	シート Seat	シート止めねじ Seat screw	クランプねじ Clamp screw	ドライバー Screw driver	シート用レンチ Wrench for seat						
形状 Shape											
適用カッタ Cutter body	希望小売 価格(円) Suggested retail price (¥)	希望小売 価格(円) Suggested retail price (¥)	トルクス プラス15IP Torx Plus 15IP	トルクスプラス15IP Torx Plus 15IP	希望小売 価格(円) Suggested retail price (¥)						
AFE45-4○○○R-○○	212-271	1,610	212-280	1,080	242-143	2.9	950	106-15IP	2,870	100-230	440

【注意】シートは、※面が必ずカッタ外周側にくるように取付けてください。
クランプねじは消耗品です。使用環境により交換寿命は変化しますので早めの交換をお願い致します。

【Note】The seat must be installed so that the surface indicated by ※ is facing the outside of the cutter.
The clamp screw is a consumable part. Since replacement life depends on the use environment, it is recommended that it be replaced at an early stage.

トルクス®、Torx Plus®は、米国アクュメント インテクチュアル プロパティーズ エルエルシー社の登録商標です。
Torx Plus® is a trademark of Acument Intellectual Properties LLC in the United States.

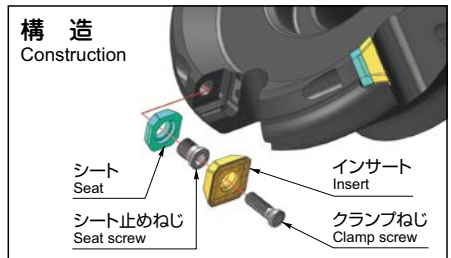

●印：標準在庫品です。 ●： Stocked items. 無印：弊社営業へお問合せください。 No mark： Contact with our sales department.

■ インサート Inserts



Fig.3 汎用
General purpose



Fig.4 低抵抗S形
Low cutting force type S

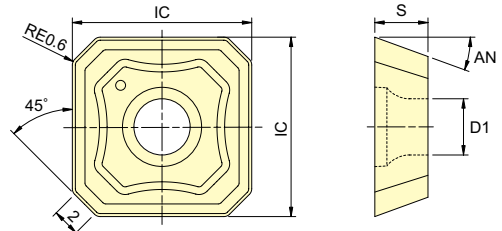

P 鋼 Carbon steels		■		■									
M SUS等 SUS, etc.		□	■										
K FC・FCD Cast irons		■		■									
N アルミニウム合金 Aluminum alloys											■		
S チタン合金 Titanium alloys		■											
H 高硬度材 Hardened steels		■※											

■ : 一般切削・第一推奨
General cutting, First recommended
□ : 一般切削・第二推奨
General cutting, Second recommended

商品コード Item code	精度 Tolerance class	AJコーティング AJ-Coating		JSコーティング JS-Coating	SDコーティング SD-Coating	寸法 Size (mm)				形状 Shape	希望小売 価格(円) Suggested retail price(¥)			
		JP4120	JM4160	JS4060	SD5010	IC	S	D1	AN					
SEMT13T3AGTN	M級 M	●	●	●		φ13.4	3.97	φ4.2	20° (ワイパ29°) (Wiper 29°)	Fig.3	1,090			
SEET13T3AGTN	E級 E	●		●										1,360
SEET13T3AGEN-S	E級 E	●	●										Fig.4	1,360
SEET13T3AGFN-S	E級 E				●									1,900

※ SEET13T13AGEN-Sは、H:高硬度材には推奨致しません。 SEET13T3AGEN-S is not recommended to H:Hardened steels.

[注意] JSコーティングは通電式タッチセンサーに反応しませんのでご注意ください。
[Note] Please note that the JS Coating does not cause a reaction in conductive touch sensors.

○ 標準切削条件表 Recommended cutting conditions

※赤字は第一推奨材種です。 Red indicates primary recommended grade.

被削材 Work material	硬さ Hardness	推奨材種 Recommended grade	切削速度 V_c Cutting speed (m/min)	一刃当りの送り f_z Feed per tooth (mm/t)	適用インサート Recommended insert
一般構造用鋼 Mild steels SS400,S10Cなど	≤180HB	※ JS4060	250 (220~300)	0.2 (0.1~0.3)	SEMT13T3AGTN SEET13T3AGTN
炭素鋼・合金鋼 Carbon & Alloy steels S50C,SCM440など	< 30HRC	JS4060	200 (190~260)	0.2 (0.1~0.3)	SEMT13T3AGTN SEET13T3AGTN
	30~40HRC	JS4060 JP4120	180 (140~220)	0.2 (0.1~0.3)	SEMT13T3AGTN SEET13T3AGTN
ステンレス鋼 Stainless steels SUS304など		JM4160 JP4120	220 (120~250)	0.2 (0.1~0.3)	SEET13T3AGEN-S
鋳鉄・ダクタイル鋳鉄 Cast irons & Ductile cast irons FC250,FCD400など		JS4060 JP4120	180 (140~220)	0.2 (0.1~0.3)	SEMT13T3AGTN SEET13T3AGTN
アルミニウム合金 Aluminum alloys A5052,A7075など		SD5010	500 (300~1000)	0.2 (0.1~0.3)	SEET13T3AGFN-S
耐熱合金 Heat resistant alloys Ni基超耐熱合金など Ni based alloys, etc.		JP4120	40 (20~50)	0.15 (0.1~0.2)	SEET13T3AGEN-S
プリハードン鋼 Pre-hardened steels	30~45HRC	JP4120	100 (80~120)	0.15 (0.1~0.2)	SEMT13T3AGTN SEET13T3AGTN
焼入れ鋼 Hardened steels	40~50HRC				

[注意] ① 被削材、加工形状に合わせて、適切なクーラントを使用してください。
② この切削条件表は切削条件の目安を示すものです。実際の加工では加工形状、目的、使用機械等により条件を調整してください。
③ JSコーティングは通電式タッチセンサーに反応しませんのでご注意ください。
④ インサートの交換は早めに行い、過度の使用による破損を防止してください。
⑤ 排出した切りくずは飛散し作業者を切傷させ、火傷あるいは目に入ると負傷させる恐れがありますので、ご使用に際してはその周囲に安全カバーを取り付け保護めがね等の保護具を着用して、安全な環境で作業される事をお願い致します。
⑥ 不水溶性切削油は、火災の恐れがありますので使用しないでください。

[Note] ① Use the appropriate coolant for the work material and machining shape.
② These conditions are for general guidance; in actual machining conditions adjust the parameters according to your actual machine and work-piece conditions.
③ Please note that the JS Coating does not cause a reaction in conductive touch sensors.
④ In order to avoid of insert breakage, please change insert earlier.
⑤ The steel chips may cause cuts, burns or damages to eyes. Be sure to install the safety cover around the tool and wear the safety glasses when carrying out any works.
⑥ Please don't use cutting oil as coolant.(It may be cause of fire.)

45 Face Mill A45E

アルファ45 フェースミル A45E

- 20° ポジインサート使用のハイレーキ刃形。
- 一般鋼、軟鋼、ステンレス鋼、軽合金切削の汎用カッタ。
- 高剛性設計、高い部品精度と不等分割刃の採用により、仕上げ面精度が良い。

・ High-rake flute shape using 20° positive inserts.
 ・ General-purpose cutter for common steel, soft steel, stainless steel, and light alloys.
 ・ Use of high-strength design, high-accuracy parts, and asymmetric flutes provide good finish surface accuracy.



A45E-○○○○R/L

○は数字が入ります。 Numeric figure in a circle ○. ポアタイプ用アーバはD11頁を参照ください。 Refer page D11 about the bore type arbor

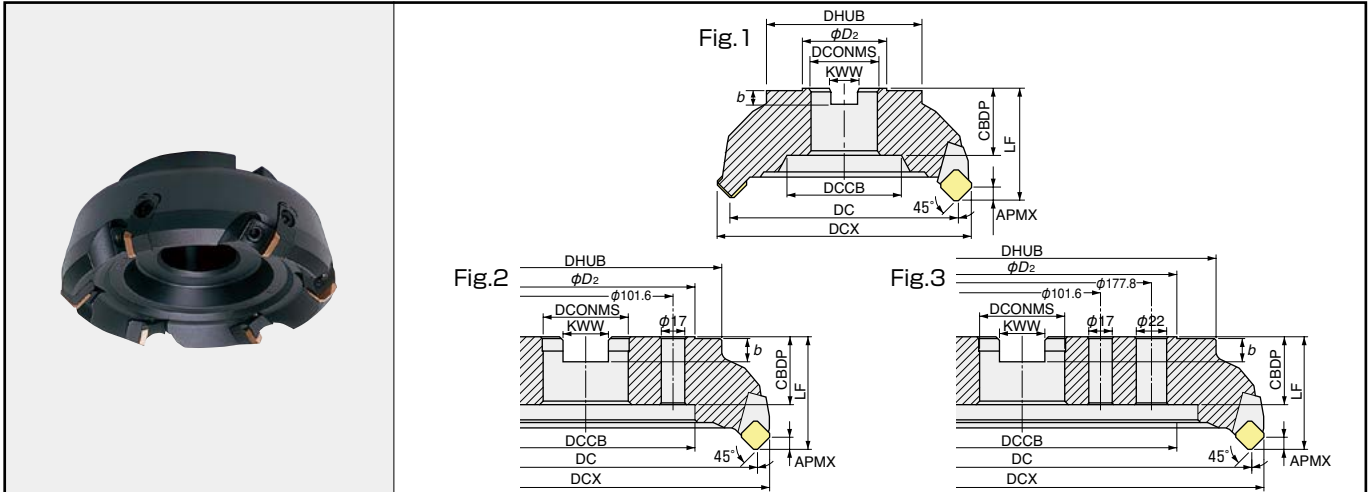

商品コード Item code	在庫 Stock		刃数 No. of flutes	寸法 Size (mm)											重量 Weight (kg)	形状 Shape	取付部 Mounting	適用インサート Inserts	希望小売 価格(円) Suggested retail price(¥)
	R	L		DC	LF	DCCB	DCONMS	DCCB	CBDB	APMX	KWW	b	φD ₂	DHUB					R
A45E-4080R/L	●		4	80	50	93	25.4	34	26	5.5	9.5	6	—	55	1.4	Fig.1	アーバ方式 Arbor type	SEK42N-19(○) SEKR42TN	78,840
A45E-4100R/L	●		5	100	63	113	31.75	45	32	5.5	12.7	8	—	65	2.4				99,120
A45E-4125R/L	●		6	125	63	138	38.1	63	38	5.5	15.9	10	—	85	3.6				118,480
A45E-4160R/L	●		8	160	63	173	50.8	90	38	5.5	19.1	11	—	105	5.5	Fig.2	センタリング プラグ方式 Direct-mounting type	SEK42N-19(○) SEKR42TN	152,490
A45E-4200R/L	●		10	200	63	213	47.625	130	38	5.5	25.4	14	130	160	9.0				214,660
A45E-4250R/L	●		12	250	63	263	47.625	140	38	5.5	25.4	14	130	200	14.9				261,580
A45E-4315R/L	●		14	315	63	328	47.625	220	38	5.5	25.4	14	220	260	22.0	Fig.3			365,980
A45E-5100R/L	●		5	100	63	118	31.75	45	32	7.5	12.7	8	—	75	2.9	Fig.1	アーバ方式 Arbor type	SEK53N-19(Y)	99,120
A45E-5125R/L	●		6	125	63	143	38.1	62	38	7.5	15.9	10	—	95	4.3				118,480
A45E-5160R/L	●		8	160	63	178	50.8	88	38	7.5	19.1	11	105	130	6.7				152,490
A45E-5200R/L	●		10	200	63	218	47.625	130	38	7.5	25.4	14	130	170	10.2	Fig.2	センタリング プラグ方式 Direct-mounting type		214,660
A45E-5250R/L	●		12	250	63	268	47.625	140	38	7.5	25.4	14	130	210	16.0				261,580

【注意】 アーバ用ねじは付属しません。 【Note】 Arbor screw is not included.

部品番号 Parts

○は数字が入ります。 Numeric figure in a circle ○

部品名 Parts	サポータ Locator	サポータ止めねじ Locator screw	クサビ Wedge	クランプねじ Clamp screw	レンチ Wrench					
形状 Shape										
適用カッタ Cutter body	希望小売 価格(円) Suggested retail price(¥)	希望小売 価格(円) Suggested retail price(¥)	希望小売 価格(円) Suggested retail price(¥)	希望小売 価格(円) Suggested retail price(¥)	希望小売 価格(円) Suggested retail price(¥)					
A45E-4○○○R	175-111	7,730	156-162 (左ねじ)	200	171-121	3,420	100-143	540	100-221	950
A45E-5○○○R	176-111	7,730		176-121	3,420	100-142	540			
A45E-4○○○L	175-112	—	156-161	280	171-122	—	100-143	540		
A45E-5○○○L	176-112	—			176-122	—	100-142	540		

●印：標準在庫品です。 ●：Stocked items. 無印：弊社営業へお問合せください。 No mark：Contact with our sales department.

■ インサート Inserts

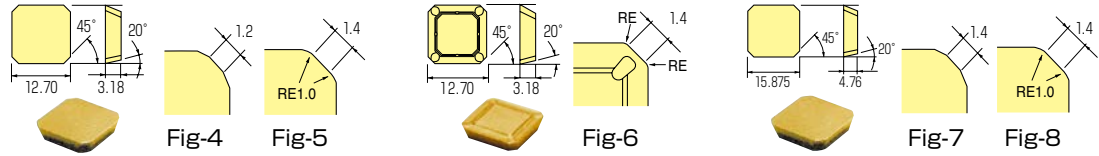

注1) サライ刃逃げ角
Note1) Flat drag clearance angle

-C9	26°
-G9Y,-G9	25°
-G9G	30°

商品コード (インチ系) Item code (Inch)	ISO形番 I.S.O. (metric)	精度 Tolerance class	AJコーティング AJ Coating		Cコーティング C Coating		GX	G	サーメット Cermets	超硬 Carbide		形状 Shape	希望小売価格(円) Suggested retail price(¥)	
			JP4120	JM4160	CY100H	CY25	CY250	GX2140	HC844	MZ1000	CH550		CH7030	EX35
SEE42TN-G9	SEEN1203AFTN-G9	E 級 E										Fig-5	—	940
SEE42TN-G9G	SEEN1203AFTN-G9G												—	940
SEE42TN-G9Y	SEEN1203AFTN-G9Y		●	●		●	●	●	●				1,210	1,450
SEE42TN-C9	SEEN1203AFTN-C9	K 級 K										Fig-4	1,210	940
SEE42FN-C9	SEEN1203AFFN-C9				●				●	●	●		1,210	940
SEK42TN-C9	SEKN1203AFTN-C9		●	●		●	●	●	●	●	●		1,090	840
SEK42TN-C9Y	SEKN1203AFTN-C9Y	E 級 E	●	●								Fig-6	1,090	—
SEK42FN-C9	SEKN1203AFFN-C9				●						●		1,090	840
SEKR42TN	SEKR1203AFTN		●	●									1,090	—
SEKR42TNY	SEKR1203AFTNY	K 級 K										Fig-7	2,310	1,780
SEE53TN-C9	SEEN1504AFTN-C9							●		●			—	—
SEE53FN-C9	SEEN1504AFFN-C9		●	●				●		●	●		2,080	1,610
SEK53TN-C9	SEKN1504AFTN-C9	E 級 E										Fig-8	2,080	—
SEK53TN-C9Y	SEKN1504AFTN-C9Y				●						●		2,080	1,610
SEK53FN-C9	SEKN1504AFFN-C9		●	●		●					●		2,310	—
SEK53TN-G9Y	SEEN1504AFTN-G9Y											—	—	

[注意] GX2140は通電式タッチセンサーに反応しませんのでご注意ください。 [Note] Please note that the GX2140 does not cause a reaction in conductive touch sensors.

○ 標準切削条件表 Recommended cutting conditions

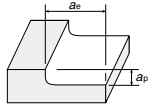

<面切削> Face milling ※赤字は第一推奨材種です。Red indicates primary recommended grade.

被削材 Work material	推奨材種 Recommended grade	切削速度 m/min Cutting speed	一刃当りの送り mm/t Feed rate	φ 80		φ 100		φ 125		φ 160	
				回転数 min ⁻¹	送り速度 mm/min	回転数 min ⁻¹	送り速度 mm/min	回転数 min ⁻¹	送り速度 mm/min	回転数 min ⁻¹	送り速度 mm/min
一般構造用鋼 Mild steels (200HB以下)	CH550 MZ1000 GX2140 CH7030	150 ~ 250	0.1 ~ 0.2	800	480	640	480	510	460	400	480
		v _c =200m/min f _z =0.15mm/t a _p =1.5mm a _e =0.8DC									
炭素鋼・合金鋼 Carbon steels, Alloy steels (30HRC以下)	CH550 MZ1000 GX2140 CH7030	100 ~ 200	0.1 ~ 0.2	640	380	510	380	410	370	320	380
		v _c =160m/min f _z =0.15mm/t a _p =1.5mm a _e =0.8DC									
炭素鋼・合金鋼 Carbon steels, Alloy steels (30 ~ 40HRC)	JP4120 CY250	80 ~ 150	0.1 ~ 0.2	480	290	380	290	310	280	240	290
		v _c =120m/min f _z =0.15mm/t a _p =1.5mm a _e =0.8DC									
ステンレス鋼 Stainless steels SUS	JM4160 HC844	120 ~ 220	0.1 ~ 0.3	720	430	570	430	460	410	360	430
		v _c =180m/min f _z =0.15mm/t a _p =1.5mm a _e =0.8DC									
鋳鉄 Cast irons FC, FCD	CY100H JP4120 GX2140	100 ~ 200	0.1 ~ 0.3	640	380	510	380	410	370	320	380
		v _c =160m/min f _z =0.15mm/t a _p =1.5mm a _e =0.8DC									
アルミ合金 Aluminium	WH10	300 ~ 600	0.05 ~ 0.2	1,590	950	1,270	950	1,020	920	800	960
		v _c =400m/min f _z =0.15mm/t a _p =1.5mm a _e =0.8DC									

被削材 Work material	推奨材種 Recommended grade	切削速度 m/min Cutting speed	一刃当りの送り mm/t Feed rate	φ 200		φ 250		φ 315	
				回転数 min ⁻¹	送り速度 mm/min	回転数 min ⁻¹	送り速度 mm/min	回転数 min ⁻¹	送り速度 mm/min
一般構造用鋼 Mild steels (200HB以下)	CH550 MZ1000 GX2140 CH7030	150 ~ 250	0.1 ~ 0.2	320	480	260	470	200	420
		v _c =200m/min f _z =0.15mm/t a _p =1.5mm a _e =0.8DC							
炭素鋼・合金鋼 Carbon steels, Alloy steels (30HRC以下)	CH550 MZ1000 GX2140 CH7030	100 ~ 200	0.1 ~ 0.2	250	380	200	360	160	340
		v _c =160m/min f _z =0.15mm/t a _p =1.5mm a _e =0.8DC							
炭素鋼・合金鋼 Carbon steels, Alloy steels (30 ~ 40HRC)	JP4120 CY250	80 ~ 150	0.1 ~ 0.2	190	290	150	270	120	250
		v _c =120m/min f _z =0.15mm/t a _p =1.5mm a _e =0.8DC							
ステンレス鋼 Stainless steels SUS	JM4160 HC844	120 ~ 220	0.1 ~ 0.3	290	430	230	410	180	380
		v _c =180m/min f _z =0.15mm/t a _p =1.5mm a _e =0.8DC							
鋳鉄 Cast irons FC, FCD	CY100H JP4120 GX2140	100 ~ 200	0.1 ~ 0.3	250	380	200	360	160	340
		v _c =160m/min f _z =0.15mm/t a _p =1.5mm a _e =0.8DC							
アルミ合金 Aluminium	WH10	300 ~ 600	0.05 ~ 0.2	640	960	510	920	400	840
		v _c =400m/min f _z =0.15mm/t a _p =1.5mm a _e =0.8DC							

[注意] ①被削材、加工形状に合わせて、適切なクーラントを使用してください。
②この標準切削条件表は切削条件の目安を示すものです。実際の加工では加工形状、目的、使用機械等により条件を調整してください。
③GX2140は、通電式タッチセンサーに反応しませんのでご注意ください。

[Note] ① Use the appropriate coolant for the work material and machining shape.
② These recommended cutting conditions indicate only the rule of a thumb for the cutting conditions. In actual machining, the condition should be adjusted according to the machining shape, purpose and the machine type.
③ Please note that the GX2140 does not cause a reaction in conductive touch sensors.

45 Face Mill A45D

アルファ45 フェースミル A45D

- 15° ポジティブサート使用。
 - ダイス鋼、合金工具鋼、鋳鉄切削の汎用カッタ。
 - 高剛性設計、高い部品精度と不等分割刃の採用により、仕上げ面精度が良い。
- ・ Uses 15° positive inserts.
- ・ General-purpose cutter for die steel, alloy tool steel, and cast iron.
- ・ Use of high-strength design, high-accuracy parts, and asymmetric flutes provide good finish surface accuracy.



A45D-4○○○R/L

○は数字が入ります。ポアタイプ用アーバはD11頁を参照ください。
 Numeric figure in a circle. Refer page D11 about the bore type arbor

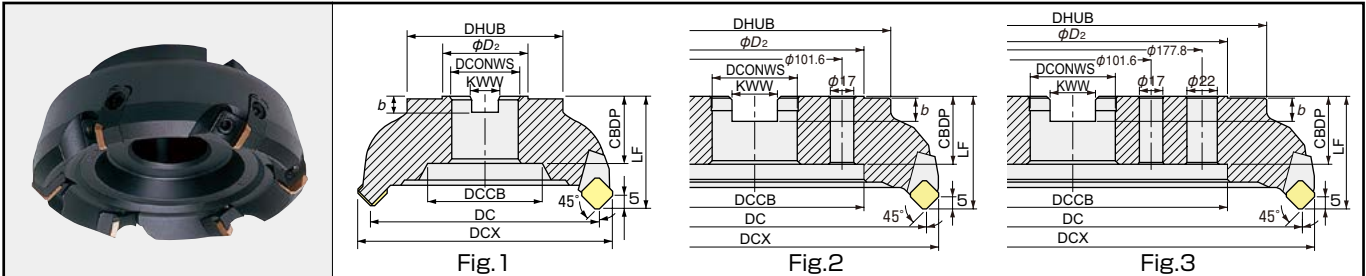

商品コード Item code	在庫 Stock		刃数 No. of flutes	寸法 Size(mm)										重量 Weight (kg)	形状 Shape	取付部 Mounting	適用インサート Inserts	希望小売 価格(円) Suggested retail price(¥)
	R	L		DC	LF	DCX	DCONWS	DCCB	CBDP	KWW	b	φD ₂	DHUB					
A45D-4080R/L	●		4	80	50	93	25.4	34	26	9.5	6	—	55	1.4	Fig.1	アーバ方式 Arbor type	SD42TN-C9(Y)	78,840
A45D-4100R/L	●		5	100	63	113	31.75	45	32	12.7	8	—	65	2.4				99,120
A45D-4125R/L	●		6	125	63	138	38.1	63	38	15.9	10	—	85	3.6				118,480
A45D-4160R/L	●		8	160	63	173	50.8	90	38	19.1	11	—	105	5.5	Fig.2	センタリング プラグ方式 Direct-mounting type	SDKR42TN	152,490
A45D-4200R/L	●		10	200	63	213	47.625	130	38	25.4	14	130	160	9.0				214,660
A45D-4250R/L	●		12	250	63	263	47.625	140	38	25.4	14	130	200	14.9	Fig.3			261,580
A45D-4315R/L	●		14	315	63	328	47.625	220	38	25.4	14	220	260	22.2				365,980

【注意】アーバ用ねじは付属しません。【Note】Arbor screw is not included.

インサート Inserts



商品コード (インチ系) Item code (Inch)	ISO形番 ISO (metric)	精度 Tolerance class	コーティング										形状 Shape	希望小売価格(円) Suggested retail price(¥)				
			AJコーティング AJ Coating	Cコーティング C Coating	GX コーティング GX Coating	G コーティング G Coating	サーメット Cermet	超硬 Carbide	P	K	AJ, C, Gコーティング AJ, C, G Coating	MZ1000 CH550, CH7030 EX35, WH10						
SDE42TN-G9	SDEN1203AETN-G9	E級 E														—	940	
SDE42TN-G9Y	SDEN1203AETN-G9Y																1,210	—
SDE42FN-G9	SDEN1203AEFN-G9																1,210	—
SDE42TN-C9	SDEN1203AETN-C9																—	940
SDE42TN-C9Y	SDEN1203AETN-C9Y																—	1,450
SDE42FN-C9	SDEN1203AEFN-C9																1,210	—
SDK42TN-C9	SDKN1203AETN-C9	K級 K															1,090	840
SDK42TN-C9Y	SDKN1203AETN-C9Y																1,090	—
SDK42FN-C9	SDKN1203AEFN-C9																1,090	840
SDKR42TN	SDKR1203AETN																1,090	—
SDKR42TNY	SDKR1203AETNY																1,090	—

【注意】GX2140は通電式タッチセンサーに反応しませんのでご注意ください。【Note】Please note that the GX2140 does not cause a reaction in conductive touch sensors.

部品番号 Parts

○は数字が入ります。 Numeric figure in a circle

部品名 Parts	サポータ Locator	サポータ止めねじ Locator screw	クサビ Wedge	クランプねじ Clamp screw	レンチ Wrench
形状 Shape					
適用カッタ Cutter body	希望小売 価格(円) Suggested retail price(¥)	希望小売 価格(円) Suggested retail price(¥)	希望小売 価格(円) Suggested retail price(¥)	希望小売 価格(円) Suggested retail price(¥)	希望小売 価格(円) Suggested retail price(¥)
A45D-4○○○R	171-111 7,730	156-162(左ねじ) 200	171-121 3,420	100-143 540	100-221 950
A45D-4○○○L	171-112 —	156-161 280	171-122 —		

●印：標準在庫品です。 ●：Stocked items. 無印：弊社営業へお問合せください。 No mark：Contact with our sales department.

標準切削条件表 Recommended cutting conditions

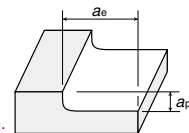

<面切削> Face milling

※赤字は第一推奨材種です。Red indicates primary recommended grade.

被削材 Work material	推奨材種 Recommended grade	切削速度 m/min Cutting speed	一刃当りの送り mm/t Feed rate	φ 80		φ 100		φ 125		φ 160	
				回転数 min ⁻¹	送り速度 mm/min	回転数 min ⁻¹	送り速度 mm/min	回転数 min ⁻¹	送り速度 mm/min	回転数 min ⁻¹	送り速度 mm/min
一般構造用鋼 Mild steels (200HB以下)	※CH550 MZ1000 GX2140 CH7030	150 ~	0.1 ~	800	480	640	480	510	460	400	480
		250	0.25	vc=200m/min fz=0.15mm/t ap=1.5mm ae=0.8DC							
炭素鋼・合金鋼 Carbon steels, Alloy steels (30HRC以下)	CH550 MZ1000 GX2140 CH7030	100 ~	0.1 ~	640	380	510	380	410	370	320	380
		200	0.25	vc=160m/min fz=0.15mm/t ap=1.5mm ae=0.8DC							
炭素鋼・合金鋼 Carbon steels, Alloy steels (30 ~ 40HRC)	JP4120 CY250	80 ~	0.1 ~	480	290	380	290	310	280	240	290
		150	0.25	vc=120m/min fz=0.15mm/t ap=1.5mm ae=0.8DC							
ダイス鋼 Die Tool steels (40 ~ 45HRC)	JP4120 CY250	60 ~	0.1 ~	320	190	250	190	200	180	160	190
		150	0.2	vc=80m/min fz=0.15mm/t ap=1.5mm ae=0.8DC							
ステンレス鋼 Stainless steels SUS	JM4160 HC844	120 ~	0.1 ~	720	430	570	430	460	410	360	430
		220	0.25	vc=180m/min fz=0.15mm/t ap=1.5mm ae=0.8DC							
鋳鉄 Cast irons FC, FCD	CY100H JP4120 GX2140	100 ~	0.1 ~	640	510	510	510	410	490	320	510
		200	0.3	vc=160m/min fz=0.2mm/t ap=1.5mm ae=0.8DC							

被削材 Work material	推奨材種 Recommended grade	切削速度 m/min Cutting speed	一刃当りの送り mm/t Feed rate	φ 200		φ 250		φ 315	
				回転数 min ⁻¹	送り速度 mm/min	回転数 min ⁻¹	送り速度 mm/min	回転数 min ⁻¹	送り速度 mm/min
一般構造用鋼 Mild steels (200HB以下)	※CH550 MZ1000 GX2140 CH7030	150 ~	0.1 ~	320	480	260	470	200	420
		250	0.25	vc=200m/min fz=0.15mm/t ap=1.5mm ae=0.8DC					
炭素鋼・合金鋼 Carbon steels, Alloy steels (30HRC以下)	CH550 MZ1000 GX2140 CH7030	100 ~	0.1 ~	250	380	200	360	160	340
		200	0.25	vc=160m/min fz=0.15mm/t ap=1.5mm ae=0.8DC					
炭素鋼・合金鋼 Carbon steels, Alloy steels (30 ~ 40HRC)	JP4120 CY250	80 ~	0.1 ~	190	290	150	270	120	250
		150	0.25	vc=120m/min fz=0.15mm/t ap=1.5mm ae=0.8DC					
ダイス鋼 Die Tool steels (40 ~ 45HRC)	JP4120 CY250	60 ~	0.1 ~	130	190	100	180	80	170
		150	0.2	vc=80m/min fz=0.15mm/t ap=1.5mm ae=0.8DC					
ステンレス鋼 Stainless steels SUS	JM4160 HC844	120 ~	0.1 ~	290	430	230	410	180	380
		220	0.25	vc=180m/min fz=0.15mm/t ap=1.5mm ae=0.8DC					
鋳鉄 Cast irons FC, FCD	CY100H JP4120 GX2140	100 ~	0.1 ~	250	500	200	480	160	450
		200	0.3	vc=160m/min fz=0.2mm/t ap=1.5mm ae=0.8DC					

- [注意]** ①被削材、加工形状に合わせ、適切なクーラントを使用してください。
 ②この標準切削条件表は切削条件の目安を示すものです。実際の加工では加工形状、目的、使用機械等により条件を調整してください。
 ③GX2140は、通電式タッチセンサーに反応しませんのでご注意ください。

- [Note]** ① Use the appropriate coolant for the work material and machining shape.
 ② These recommended cutting conditions indicate only the rule of a thumb for the cutting conditions. In actual machining, the condition should be adjusted according to the machining shape, purpose and the machine type.
 ③ Please note that the GX2140 does not cause a reaction in conductive touch sensors.

A45E, A45Dの使い方 How to use A45E and A45D

① インサート交換の手順 Insert replacement procedure

(1) 清掃 Cleaning

- サポータやクサビの各部分(A~D)をエアブローにより清掃してください。
- インサートは上下面(E)と外周部(F)とをウエス等で拭いてください。(切りくず等が強固に付着している場合でも、ハンドラッパー等で必ず取り除いてください。)

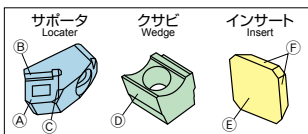

Clean areas A to D of locator and wedge using air blower. Wipe insert upper/lower surfaces E and perimeter F using rags, etc. (If cutting waste, etc. have hardened on insert, remove using hand wrapper, etc.)

(2) インサートの取り付け Attaching insert

- 右図のように、インサートをサポータの底面(A)と着座面(B)に沿ってすべらせて、サポータのインサート支持面(C)に押しあててください。(この操作を2~3回繰り返すと、さらに正確にセットされます。)

- インサートをインサート支持面(C)に押しつけたまま、クランプねじを付属のTレンチで軽く締めてください。
- 次にTレンチで強く本締めを行ってください。この時の締め付けトルクは約6.9N・mが最良です。

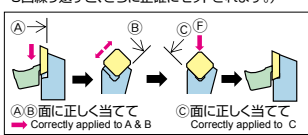

Slide insert along bottom surface A of locator and seat surface B, and press it against locator's insert support surface C as shown at right. (Repeat operation 2 or 3 times for higher setting accuracy.) While keeping insert pressed against insert support surface C, lightly tighten clamp screw using included T wrench. At this time, tightening torque of approx. 6.9N・m is best.

(3) 切れ刃の振れ測定 Measuring cutting edge deflection

- 正面切れ刃の振れ精度をチェックしてからご使用ください。(振れ精度が良い程仕上がりきれいに仕上がります。工具寿命も長持ちします。)

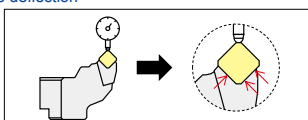

Check deflection accuracy of front cutting edge before use. (Higher deflection accuracy will result in cleaner finished surfaces and longer tool life.)

② 部品交換の手順 Part replacement procedure

(1) 部品交換の目安 General criteria for part replacement

- Tレンチ : クランプねじに差し込む六角形状が変形し、締め付けにくくなってきた場合。
- クランプねじ : ねじの六角穴が変形し、締め付けにくくなってきた場合。
- クサビ : インサートの締め付けが不安定になってきた場合。
- サポータ : サポータのインサート着座面のコーナ部が変形したり、傷ができて切れ刃振れ精度が悪化した場合。

T wrench: When hexagonal shape inserted into clamp screws is deformed making tightening difficult.
 Clamp screw: When hexagonal hole of screw is deformed making tightening difficult.

Wedge: When tightening against insert has become unstable.
 Locator: When corner of locator's insert seat surface is deformed or damaged and cutting edge deflection accuracy has worsened.

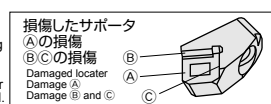

(2) サポータ交換の手順 Locator replacement procedure

- インサートとクサビをはずす。(クランプねじは右ねじです。)
- サポータをはずす。(右勝手用サポータの止めねじは左ねじですので右へ回すとゆるみます。)
- カッタ本体の溝をきれいに清掃し、新しいサポータを取り付けてください。(この場合も左ねじを使用していますので左へ回すと締まります。)
- 新サポータ取り付け後、同一インサートの同一コーナを使用してカッタ全体の正面振れを測定し、0.01mm程度に入れてください。

Remove insert and wedge. (Clamp screw is right-hand screw.) Remove locator. (Set screw of right-hand locator is a left-hand screw. Turn clockwise to loosen.) Clean cutter body groove well and install new locator. (Again, a left-hand screw is used. Turn counterclockwise to tighten.) After new locator installation, measure front surface deflection using the same insert and same corner, and get it to within about 0.01mm.

(3) サポータの購入方法 Purchasing locator

- アルファ45D、アルファ45Eシリーズは高い組立て精度にするために、カッター本体の溝精度に合わせたランク分けされたサポータを使用しております。交換する場合は破損したサポータに表示されたランク記号を付記してご発注ください。(サポータランク記号は検査成績表にも記入されております。)



90 Face Mill SE90

アルファ90 フェースミル SE90

- 切りくずの排出が安定したハイレキタイプの直角削りカッタ。
 - 鋼、ステンレス鋼の切削や薄肉ワークの加工に適します。
 - マシニングセンタや馬力の小さい機械の加工で能率アップ。
- ・ A high rake angle type cutter for cutting right angle material, which eject cutting chips steadily.
 ・ Suitable for cutting steel, stainless steel or thin works.
 ・ Reveals excellent cutting effect when used for machining center or a machine of small horse power.

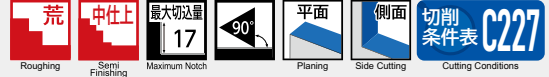

○は数字が入ります。 Numeric figure in a circle ○

ボアタイプ用アーバはD11頁を参照ください。
Refer page D11 about the bore type arbor

SE90-4○○○R

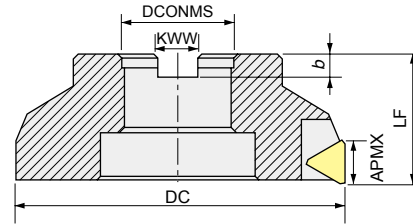

商品コード Item code	在庫 Stock	刃数 No. of flutes	寸法 Size (mm)						取付部 Mounting	適用インサート Inserts	希望小売価格 (円) Suggested retail price(¥)
			DC	LF	DCONMS	APMX	KWW	b			
SE90-4080R	●	4	80	50	25.4	17	9.5	6	アーバ方式 Arbor type	TE43R-G0(○)	97,250
SE90-4100R	●	5	100	63	31.75	17	12.7	8			113,790
SE90-4125R	●	6	125	63	38.1	17	15.9	10			137,250
SE90-4160R		8	160	63	50.8	17	19.1	11	センターリングプラグ方式 Direct-Mounting type		—
SE90-4200R		10	200	63	47.625	17	25.4	13.5			—
SE90-4250R		12	250	63	47.625	17	25.4	13.5			—

【注意】 アーバ用ねじは付属しません。

【Note】 Arbor screw is not included.

部品番号 Parts

部品名 Parts	サポータ Locator	サポータ止ねじ Locator screw	クサビ Wedge	クランプねじ Clamp screw	レンチ Wrench
形状 Shape					
適用カッタ Cutter body	希望小売価格(円) Suggested retail price(¥)	希望小売価格(円) Suggested retail price(¥)	希望小売価格(円) Suggested retail price(¥)	希望小売価格(円) Suggested retail price(¥)	希望小売価格(円) Suggested retail price(¥)
SE90-4080R ~ 4250R	232-111 6,420	156-162 (左ねじ) 200	232-121 2,190	100-143 540	100-221 950

ストレートアーバ Straight Arbor

形状 Shape	商品コード Item code	在庫 Stock	外径 Dc Tool dia.	アーバ寸法 (mm) Arbor						キー (mm) key		クランプボルト (mm) Clamp				
				DCONWS(h)	DCONMS	ℓ ₂	ℓ _S	ℓ ₁	BD2	KWW	b	呼び記号	M	φD ₁	L ₁	ℓ ₃
	AS32-25.4-20		80	25.4	32	20	80	22	55	9.5	5	MBA-M12	M12	33	30	10
	AS32-31.75-20		100	31.75	32	20	80	30	60	12.7	7	MBA-M16	M16	40	40	10
	AS32-38.1-20		125	38.1	32	20	80	34	80	15.9	9	MBA-M20	M20	50	50	14
	AS42-25.4-20		80	25.4	42	20	80	22	55	9.5	5	MBA-M12	M12	33	30	10
	AS42-31.75-20		100	31.75	42	20	80	30	60	12.7	7	MBA-M16	M16	40	40	10
	AS42-38.1-20		125	38.1	42	20	80	34	80	15.9	9	MBA-M20	M20	50	50	14

●印：標準在庫品です。 ●：Stocked items. 無印：弊社営業へお問合せください。 No mark：Contact with our sales department.

インサート Inserts

TEE43R-G0(□)

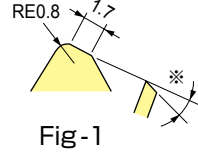
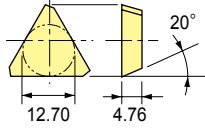

Fig-1

※	- G0E	23°
	- G0Y	23°
	- G0	20°

商品コード (インチ系) Item code (Inch)	ISO形番 ISO (metric)	精度 Tolerance class	AJコーティング AJ Coating		Cコーティング C Coating		GXコーティング GX Coating		Gコーティング G Coating		サーメット Cermet		超硬 Carbide		形状 Shape	希望小売価格(円) Suggested retail price(¥)	
			JP4120	JM4160	CY100H	CY25	CY250	GX2140	HC844	CH550	P	K	AJ,C,GX,G コーティング AJ,C,GX,G Coating	CH550 EX35 WH10			
TEE43TR-G0	TEEN2204PETR-G0	E級 E				●			●	●	●			Fig-1	1,790	1,380	
TEE43TR-G0Y	TEEN2204PETR-G0Y		●	●		●	●	●							1,790	—	
TEE43TR-G0E	TEEN2204PETR-G0E								●	●	●				1,790	1,380	
TEE43FR-G0E	TEEN2204PEFR-G0E	K級 K			●							●			1,790	1,380	
TEK43TR-G0E	TEKN2204PETR-G0E								●	●	●				1,620	1,260	
TEK43FR-G0E	TEKN2204PEFR-G0E				●								●		1,620	1,260	

【注意】GX2140は通電式タッチセンサーに反応しませんのでご注意ください。【Note】Please note that the GX2140 does not cause a reaction in conductive touch sensors.

標準切削条件表 Recommended cutting conditions

<面切削> Face milling

※赤字は第一推奨材種です。Red indicates primary recommended grade.

被削材 Work material	作業区分 Application	推奨材種 Recommended grade	標準切削条件 Recommended cutting conditions		適用インサート Insert
			切削速度 (m/min) Cutting speed v_c (m/min)	1刃当りの送り (mm/t) Feed rate f_z (mm/t)	
軟鋼 Mild steels SS,SM (200HB以下)	汎用 General	CH550,GX2140	150 ~ 200	0.15 ~ 0.25	TEE43TR-G0(□) TEK43TR-G0E
	荒用 Roughing	CY250,EX35 CY25,HC844	125 ~ 200	0.2 ~ 0.4	
炭素鋼・合金鋼 Carbon steels, Alloy steels S-C,SCM (30HRC以下)	汎用 General	CH550,GX2140	150 ~ 200	0.1 ~ 0.2	
	荒用 Roughing	CY250,EX35 CY25,HC844	120 ~ 160	0.1 ~ 0.3	
炭素鋼・合金鋼 Carbon steels, Alloy steels (30 ~ 40HRC)	汎用 General	JP4120,CY250 EX35,CY25,HC844	60 ~ 120	0.1 ~ 0.15	
	汎用 General	JM4160 CY250,EX35	150 ~ 200	0.1 ~ 0.2	
ステンレス鋼 Stainless steels SUS	汎用 General				
鋳鉄 Cast irons FC,FCD	汎用 General	CY100H,WH10 JP4120,GX2140	80 ~ 180	0.1 ~ 0.25	TEE43FR-G0(E) TEK43FR-G0E
	汎用 General	WH10	200 ~ 500	0.1 ~ 0.3	

【注意】①被削材、加工形状に合わせて、適切なクーラントを使用してください。
②この標準切削条件表は切削条件の目安を示すものです。実際の加工では加工形状、目的、使用機械等により条件を調整してください。

【Note】③GX2140は、通電式タッチセンサーに反応しませんのでご注意ください。

① Use the appropriate coolant for the work material and machining shape.

② These recommended cutting conditions indicate only the rule of a thumb for the cutting conditions. In actual machining, the condition should be adjusted according to the machining shape, purpose and the machine type.

③ Please note that the GX2140 does not cause a reaction in conductive touch sensors.

Chamfering Mill CPC

アルファ面取りカッタ CPC

- シャープな切れ刃で、軽快な切れ味を發揮します。
- 面取り角度 30°、45°、60° と先端径 5、10、20、35 mm をシリーズ化しました。各種寸法の面取り加工にお応えします。

・ With its sharp cutting edge, smooth and fine cutting effect is assured.
 ・ Chamfering angles 30°, 45° and 60° and tip dias 5, 10, 20 and 35 mm are made available in series. This performance responds well to chamfering process for various sizes.



CPC(L)○○-○○

○は数字が入ります。 Numeric figure in a circle ○

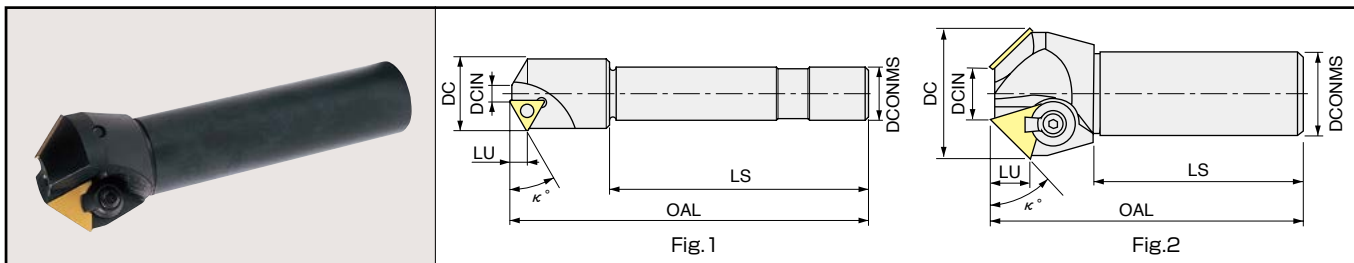

商品コード Item code	在庫 Stock	刃数 No. of flutes	寸法 Size (mm)								形状 Shape	適用インサート Inserts	希望小売 価格(円) Suggested retail price(¥)
			κ°	DCIN	DC	OAL	DCONMS	LU	LS				
レギュラー シャンク Regular Shank	CPC05-30	●	1	30	5	21.9	120	16	4.9	90	Fig.1	TPMT110204	30,970
	CPC10-30	●	2	30	10	34.9	120	25	7.1	90	Fig.2	TP○N1603○○(○○)	40,940
	CPC20-30	●	2	30	20	54.5	160	32	9.9	120		TPMN2204○○(○○)	52,440
	CPC35-30	●	3	30	35	69.5	160	32	9.9	120	TPMN2204○○(○○)	61,940	
	CPC05-45	●	1	45	5	18.6	120	16	7.0	90	Fig.1	TPMT110204	30,970
	CPC10-45	●	2	45	10	31.0	120	25	10.1	90	Fig.2	TP○N1603○○(○○)	40,940
	CPC20-45	●	2	45	20	48.8	160	32	14.0	120		TPMN2204○○(○○)	52,440
	CPC35-45	●	3	45	35	63.2	160	32	14.0	120	TPMN2204○○(○○)	61,940	
	CPC05-60	●	1	60	5	14.4	120	16	8.5	90	Fig.1	TPMT110204	30,970
	CPC10-60	●	1	60	10	24.1	120	25	12.1	90	Fig.2	TP○N1603○○(○○)	40,940
	CPC20-60	●	2	60	20	39.8	160	32	17.1	120		TPMN2204○○(○○)	52,440
	CPC35-60	●	3	60	35	55.0	160	32	17.1	120	TPMN2204○○(○○)	61,940	
ロング シャンク Long shank	CPCL05-30		1	30	5	21.9	160	16	4.9	130	Fig.1	TPMT110204	—
	CPCL10-30		2	30	10	34.9	180	25	7.1	150	Fig.2	TP○N1603○○(○○)	—
	CPCL20-30		2	30	20	54.5	220	32	9.9	180		TPMN2204○○(○○)	—
	CPCL35-30		3	30	35	69.5	220	32	9.9	180	TPMN2204○○(○○)	—	
	CPCL05-45	●	1	45	5	18.6	160	16	7.0	130	Fig.1	TPMT110204	34,020
	CPCL10-45	●	2	45	10	31.0	180	25	10.1	150	Fig.2	TP○N1603○○(○○)	44,940
	CPCL20-45	●	2	45	20	48.8	220	32	14.0	180		TPMN2204○○(○○)	57,840
	CPCL35-45	●	3	45	35	63.2	220	32	14.0	180	TPMN2204○○(○○)	68,170	
	CPCL05-60		1	60	5	14.4	160	16	8.5	130	Fig.1	TPMT110204	—
	CPCL10-60		1	60	10	24.1	180	25	12.1	150	Fig.2	TP○N1603○○(○○)	—
	CPCL20-60		2	60	20	39.8	220	32	17.1	180		TPMN2204○○(○○)	—
	CPCL35-60		3	60	35	55.0	220	32	17.1	180	TPMN2204○○(○○)	—	

部品番号 Parts

部品名 Parts	クランプねじ Clamp screw			クランプ駒セット Cramp piece set		ドライバー/レンチ Screw driver / Wrench			
形状 Shape	縮付トルク Fastening torque (N・m)	希望小売 価格(円) Suggested retail price(¥)	希望小売 価格(円) Suggested retail price(¥)	希望小売 価格(円) Suggested retail price(¥)	A	B	C	形状 Shape	希望小売 価格(円) Suggested retail price(¥)
適用カッタ Cutter body									
CPC(L)05-60	250-141	1.1	870	—	—	104-T8			A 1,800
CPC(L)05-30,45	251-141	1.1	870	—	—	105-T20			B 2,120
CPC(L)10-30,45,60	—	—	—	CM5-141	2,030	101-T25L			C 1,440
CPC(L)20-30,45,60	—	—	—	CM6-147	2,030				
CPC(L)35-30,45,60	—	—	—						

【注意】クランプねじは消耗品です。使用環境により交換寿命は変化しますので早めの交換をお願い致します。

【Note】The clamp screw is a consumable part. Since replacement life depends on the use environment, it is recommended that it be replaced at an early stage.

●印：標準在庫品です。 ●：Stocked items. 無印：弊社営業へお問合せください。 No mark：Contact with our sales department.

■ インサート Inserts

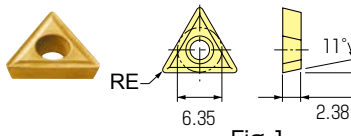
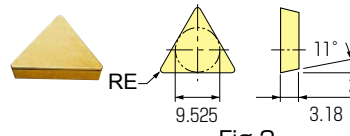
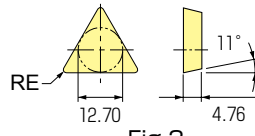
TPMT110204		TP□N16030○(□□)		TPMN22040○(□□)	
	RE 6.35 2.38 11° Fig-1		RE 9.525 3.18 11° Fig-2		RE 12.70 4.76 11° Fig-3
P 鋼 Carbon steels					
M SUS等 SUS, etc.					
K FC・FCD Cast irons					
N アルミニウム合金 Aluminum alloys					

■ : 一般切削・第一推奨
General cutting, First recommended

商品コード Item code	ISO形番 ISO (metric)	精度 Tolerance class	AJコーティング AJ Coating		Cコーティング C Coating		GX	G	サーメット Cermet	超硬 Carbide		寸法 Size (mm)	形状 Shape	希望小売価格(円) Suggested retail price(¥)			
			JP4120	JM4160	CY100H	CY25	GX2140	HC844	CH550	EX35	WH10			AJ,C,GX, Gコーティング AJ,C,GX, G Coating	CH550 EX35 WH10		
TPMT831	TPMT110204	M級							●	●	●	●	0.4	Fig-1	830	640	
TPP322	TPGN160308	G級								●			0.8	Fig-2	—	1,630	
TPMN321	TPMN160304	M級								●	●	●	0.4		—	820	
TPMN322	TPMN160308				●					●	●	●	0.8		1,040	820	
TPMN322Y	TPMN160308Y		●	●			●						0.8		1,040	—	
TPMN321TN	TPMN160304TN									●			0.4	—	820		
TPMN322TN	TPMN160308TN									●	●		0.8	—	820		
TPMN431	TPMN220404	M級								●	●		0.4	Fig-3	—	1,380	
TPMN432	TPMN220408				●					●	●	●	0.8		1,790	1,380	
TPMN432Y	TPMN220408Y		●	●		●							0.8		1,790	—	
TPMN433	TPMN220412				●						●	●	●		1.2	1,790	1,380
TPMN431TN	TPMN220404TN										●				0.4	—	1,380
TPMN432TN	TPMN220408TN									●	●		0.8	—	1,380		
TPMN433TN	TPMN220412TN									●			1.2	—	1,380		

【注意】 TN は角度付きネガホーニング、無印は丸ホーニング
GX2140は通電式タッチセンサーに反応しませんのでご注意ください。

【Note】 TN types have angled negative honing. Unmarked types have round honing.
Please note that the GX2140 does not cause a reaction in conductive touch sensors.

○ 標準切削条件表 Recommended cutting conditions

※赤字は第一推奨材種です。Red indicates primary recommended grade.

被削材 Work material	推奨材種 Recommended grade	切削速度 m/min Cutting speed	一刃当りの送り mm/t Feed rate	CPC05-45		CPC10-45		CPC20-45		CPC35-45	
				回転数 min ⁻¹	送り速度 mm/min	回転数 min ⁻¹	送り速度 mm/min	回転数 min ⁻¹	送り速度 mm/min	回転数 min ⁻¹	送り速度 mm/min
一般構造用鋼 Mild steels (200HB以下)	GX2140 JP4120 CH550	200 ~ 240	0.15 ~ 0.3	3,760	750	2,260	900	1,440	580	1,100	660
$v_c=220\text{m/min}$ $f_z=0.2\text{mm/t}$											
炭素鋼・合金鋼 Carbon steels Alloy steels (30HRC以下)	GX2140 JP4120 CH550	150 ~ 200	0.15 ~ 0.3	3,080	620	1,850	740	1,170	470	900	540
$v_c=180\text{m/min}$ $f_z=0.2\text{mm/t}$											
炭素鋼・合金鋼 Carbon steels Alloy steels (30 ~ 40HRC)	JP4120 HC844 EX35	100 ~ 140	0.1 ~ 0.2	2,050	310	1,230	370	780	230	600	270
$v_c=120\text{m/min}$ $f_z=0.15\text{mm/t}$											
ステンレス鋼 Stainless steels SUS	JM4160 HC844	180 ~ 240	0.15 ~ 0.25	3,760	750	2,260	900	1,440	580	1,100	660
$v_c=220\text{m/min}$ $f_z=0.2\text{mm/t}$											
鋳鉄 Cast irons FC, FCD	CY100H WH10 JP4120 GX2140	140 ~ 200	0.15 ~ 0.3	2,910	580	1,750	700	1,110	440	850	510
$v_c=170\text{m/min}$ $f_z=0.2\text{mm/t}$											
アルミ合金 Aluminium alloys	WH10	300 ~ 400	0.1 ~ 0.2	5,990	900	3,590	1,080	2,280	680	1,750	790
$v_c=350\text{m/min}$ $f_z=0.15\text{mm/t}$											

【注意】
①被削材、加工形状に合わせて、適切なクーラントを使用してください。
②この標準切削条件表は切削条件の目安を示すものです。実際の加工では加工形状、目的、使用機械等により条件を調整してください。
③GX2140は、通電式タッチセンサーに反応しませんのでご注意ください。
④上記回転数は切込み角 45° カッタの最大外径 (DC) を基準に算出しています。
⑤切込み角 30° 及び 60° カッタの切削条件は上記表 (45° カッタ) を適用してください。

【Note】
① Use the appropriate coolant for the work material and machining shape.
② These recommended cutting conditions indicate only the rule of a thumb for the cutting conditions. In actual machining, the condition should be adjusted according to the machining shape, purpose and the machine type.
③ Please note that the GX2140 does not cause a reaction in conductive touch sensors.
④ The rotation speeds above are calculated based on a cutter with a 45° cutting angle at the maximum outer diameter (DC).
⑤ For cutters with cutting angles of 30° or 60°, the above cutting conditions (for 45° cutter) are applicable.

Indexable End Mill EP

刃先交換式エンドミル EP

- 三角形 11° ポジインサート使用の汎用タイプ
- General-purpose type using triangular 11° positive inserts.

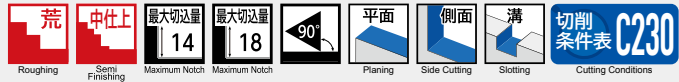

EP(L)00○○

○は数字が入ります。 Numeric figure in a circle ○

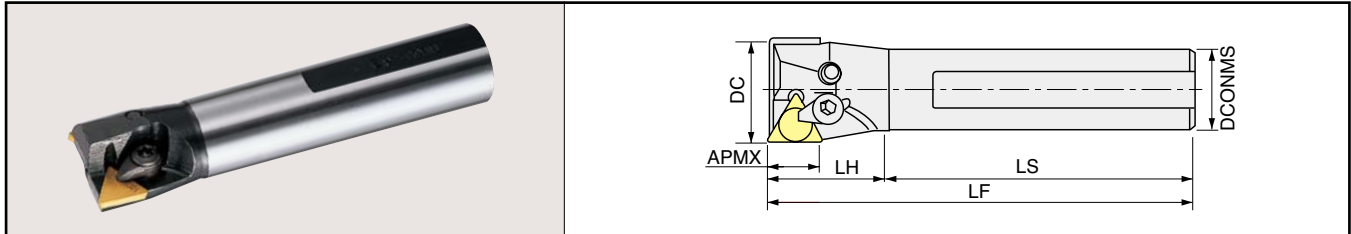

商品コード Item code	在庫 Stock	刃数 No. of flutes	寸法 Size (mm)						適用インサート Inserts	
			DC	LF	DCONMS	APMX	LH	LS		
標準 Regular shank	EP0020		1	20	110	20	14	30	80	TPN32R-0 TPN1603○○(○)
	EP0025		2	25	120	25	14	35	85	
	EP0030		2	30	125	25	14	35	90	
	EP0035		2	35	145	32	14	35	110	TPN43R-0 TPN2204○○(○)
	EP0040		2	40	155	32	18	40	115	
	EP0050		3	50	155	42	18	40	115	
ロング Long shank	EPL0020		1	20	185	20	14	30	155	TPN32R-0 TPN1603○○(○)
	EPL0025		2	25	220	25	14	35	185	
	EPL0030		2	30	220	25	14	35	185	
	EPL0035		2	35	235	32	14	35	200	TPN43R-0 TPN2204○○(○)
	EPL0040		2	40	240	32	18	40	200	
	EPL0050		3	50	250	42	18	40	210	

刃先交換式工具
その他の工具

標準切削条件表 Recommended cutting conditions

※赤字は第一推奨材種です。 Red indicates primary recommended grade.

被削材 Work material	作業区分 Application	推奨材種 Recommended grade	切削速度 (m/min) Cutting speed v_c	1 刃当りの送り (mm/t) Feed rate f_z	適用インサート Inserts	
					EP(L)0020 ~ 0035	EP(L)0040 ~ 0050
軟鋼 Mild steels SS, SM (200HB 以下)	汎用 General 荒用 Roughing	CH550, GX2140	150 ~ 200	0.1 ~ 0.25	TPC32TR-E0 TPC32TR-G0	TPC43TR-E0 TPC43TR-G0
		EX35 CY25, HC844	100 ~ 180	0.2 ~ 0.4		
炭素鋼・合金鋼 Carbon steels, Alloy steels S-C, SCM (30HRC 以下)	汎用 General 荒用 Roughing	CH550, GX2140	120 ~ 180	0.1 ~ 0.2	TPK32TR-E0 TPK32TR-G0	TPE43TR-G0Y
		EX35 CY25, HC844	100 ~ 150	0.2 ~ 0.4		
炭素鋼・合金鋼 Carbon steels, Alloy steels (30 ~ 40HRC)	汎用 General	JP4120 CY250 EX35	60 ~ 120	0.1 ~ 0.15	TPMN32○○(○)	TPK43TR-E0 TPK43TR-G0
ステンレス鋼 Stainless steels SUS	汎用 General	JM4160 HC844	150 ~ 200	0.1 ~ 0.2		
鋳鉄 Cast irons FC, FCD	汎用 General	CY100H, WH10 JP4120, GX2140	80 ~ 130	0.1 ~ 0.3	TPC32FR-E0 TPK32FR-E0	TPC43FR-E0 TPK43FR-E0

- 【注意】** ①被削材、加工形状に合わせて、適切なクーラントを使用してください。
 ②この標準切削条件表は切削条件の目安を示すものです。実際の加工では加工形状、目的、使用機械等により条件を調整してください。
 ③GX2140は、通電式タッチセンサーに反応しませんのでご注意ください。
- 【Note】** ① Use the appropriate coolant for the work material and machining shape.
 ② These recommended cutting conditions indicate only the rule of a thumb for the cutting conditions. In actual machining, the condition should be adjusted according to the machining shape, purpose and the machine type.
 ③ Please note that the GX2140 does not cause a reaction in conductive touch sensors.

●印：標準在庫品です。 ●：Stocked items. 無印：弊社営業へお問合せください。 No mark：Contact with our sales department.

■ インサート Inserts

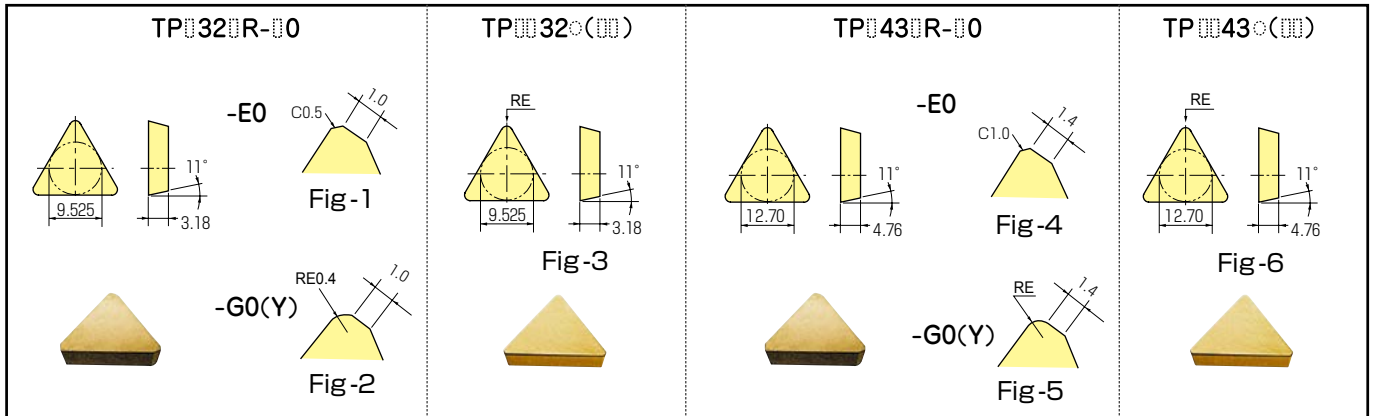

商品コード (インチ系) Item code (Inch)	ISO形番 ISO (metric)	精度 Tolerance class	AJコーティング AJ Coating		Cコーティング C Coating		GX コーティング Coating	G コーティング Coating	サ-メット Cermet	超硬 Carbide		寸法 Size(mm)	形状 Shape	希望小売価格(円) Suggested retail price(¥)	
			JP4120	JM4160	CY100H	CY25	CY250	GX2140	HC844	CH550	P			K	AJ,C,GX, Gコーティング AJ,C,GX, G Coating
TPP322	TPGN160308	G級										0.8	Fig-3	—	1,630
TPMN321	TPMN160304											0.4		—	820
TPMN322	TPMN160308	M級										0.8	1,040	820	
TPMN322Y	TPMN160308Y												0.8	1,040	—
TPMN321TN	TPMN160304TN											0.4	—	820	
TPMN322TN	TPMN160308TN											0.8	—	820	
TPMN431	TPMN220404	M級										0.4	Fig-6	—	1,380
TPMN432	TPMN220408											0.8		1,790	1,380
TPMN432Y	TPMN220408Y											0.8	1,790	—	
TPMN433	TPMN220412											1.2	1,790	1,380	
TPMN431TN	TPMN220404TN											0.4	—	1,380	
TPMN432TN	TPMN220408TN											0.8	—	1,380	
TPMN433TN	TPMN220412TN											1.2	—	1,380	
TPC32TR-E0	TPCN1603PPTR-E0	C級											Fig-1	—	1,760
TPC32FR-E0	TPCN1603PPFR-E0													—	—
TPE32TR-E0	TPEN1603PPTR-E0	E級											—	—	
TPK32TR-E0	TPKN1603PPTR-E0	K級											—	900	
TPK32FR-E0	TPKN1603PPFR-E0													—	900
TPK32TR-G0	TPKN1603PPTR-G0												Fig-2	1,150	—
TPK32TR-G0Y	TPKN1603PPTR-G0Y													1,150	—
TPC43TR-E0	TPCN2204PDTR-E0	C級											Fig-4	—	—
TPC43FR-E0	TPCN2204PDFR-E0													—	—
TPE43TR-E0	TPEN2204PDTR-E0	E級											Fig-5	—	—
TPE43TR-G0Y	TPEN2204PDTR-G0Y													1,780	—
TPK43TR-E0	TPKN2204PDTR-E0	K級											Fig-4	—	1,250
TPK43FR-E0	TPKN2204PDFR-E0														—
TPK43TR-G0	TPKN2204PDTR-G0												Fig-5	1,620	—
TPK43TR-G0Y	TPKN2204PDTR-G0Y													1,620	—
TPK43FR-G0	TPKN2204PDFR-G0												1,620	—	

【注意】GX2140は通電式タッチセンサーに反応しませんのでご注意ください。【Note】Please note that the GX2140 does not cause a reaction in conductive touch sensors.

■ 部品番号 Parts

部品名 Parts	クランプ駒セット Clamp piece set		レンチ Wrench		
適用カッタ Cutter body		希望小売価格(円) Suggested retail price(¥)		希望小売価格(円) Suggested retail price(¥)	
EP(L)0020		CB6-143		100-LT25	360
EP(L)0025		CB6-145			
EP(L)0030		CB6-147			
EP(L)0035					
EP(L)0040					
EP(L)0050					

Indexable Tools

Other Tools

アルファエンドミル "じゅうおう" AJU

● 下穴なしで縦送り(ドリル)加工から横送り(エンドミル)加工までを1本の工具でできる多機能・底刃つきエンドミルです。工具の種類をしぼり、交換時間を節約、段取り換えを減らします。

・ A multi-functional end mill with a bottom cutter, which can drill (vertical) or mill (horizontal) without making preparatory drilling. The tool types are not so many, thus exchanging time and setting up time can be saved.



AJU(L)○○×○○

○は数字が入ります。 Numeric figure in a circle ○

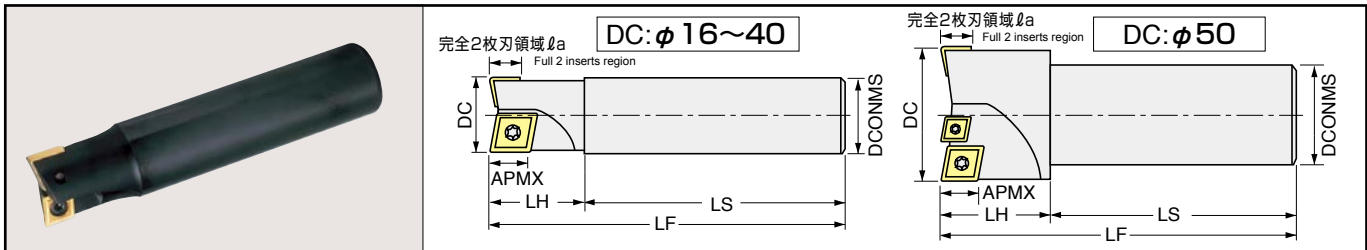

商品コード Item code	在庫 Stock	刃数 No. of inserts	寸法 Size (mm)							適用インサート Inserts	希望小売価格 (円) Suggested retail price (¥)	
			DC	LF	la	APMX	LH	LS	DCONMS			
標準 シャンク Regular Shank	AJU16×16	●	2	16	120	6	7	30	90	16	CCMT060204 CPMT080204Z	26,170
	AJU20×20	●	2	20	120	6	8.5	30	90	20	CCMT060204 CPMT090204Z	28,870
	AJU25×25	●	2	25	130	9	11.5	40	90	25	CPMT090308 CPMT120308Z	32,620
	AJU32×32	●	2	32	150	12	15	40	110	32	CPMT120408,120430 CPMT160408Z,160430Z	35,080
	AJU40×32	●	2	40	170	15	18	50	120	32	CPMT160408Z,160430Z CPMT190408Z,190430Z	38,710
	AJU50×42	●	2 ※(3)	50	170	12	15	50	120	42	CPMT090308 CPMT120408,120430 CPMT160408Z,160430Z	47,750
ロング シャンク Long Shank	AJUL16×16	●	2	16	175	6	7	40	135	16	CCMT060204 CPMT080204Z	28,740
	AJUL20×20	●	2	20	185	6	8.5	50	135	20	CCMT060204 CPMT090204Z	31,800
	AJUL25×25	●	2	25	220	9	11.5	70	150	25	CPMT090308 CPMT120308Z	35,910
	AJUL32×32	●	2	32	230	12	15	80	150	32	CPMT120408,120430 CPMT160408Z,160430Z	38,710
	AJUL40×32	●	2	40	240	15	18	50	190	32	CPMT160408Z,160430Z CPMT190408Z,190430Z	42,590
	AJUL50×42	●	2 ※(3)	50	250	12	15	50	200	42	CPMT090308 CPMT120408,120430 CPMT160408Z,160430Z	52,560

【注意】 ※()内はインサート数です。 【Note】 ※In the (), it is the number of inserts.

部品番号 Parts

部品名 Parts	クランプねじ Clamp screw	ドライバー Screw driver	レンチ Wrench				
形状 Shape							
適用カッタ Cutter body	締付トルク Fastening torque (N·m)	希望小売価格(円) Suggested retail price (¥)	希望小売価格(円) Suggested retail price (¥)				
AJU (L) 16×16	251-141	1.1	870	104-T8	1,800	—	—
AJU (L) 20×20	251-141	1.1	870	104-T8	1,800	—	—
	242-141	2.9	540	104-T15	2,060	—	—
AJU (L) 25×25	412-141	2.9	540	104-T15	2,060	—	—
AJU (L) 32×32	263-143	4.9	870	—	—	105-T20	2,120
AJU (L) 40×32	263-141	4.9	870	—	—	105-T20	2,120
	412-143	8.0	540	—	—	101-T25S	1,440
AJU (L) 50×42	412-141	2.9	540	104-T15	2,060	105-T20	2,120
	263-141	4.9	870				

【注意】 クランプねじは消耗品です。使用環境により交換寿命は変化しますので早めの交換をお願い致します。

【Note】 The clamp screw is a consumable part. Since replacement life depends on the use environment, it is recommended that it be replaced at an early stage.

●印：標準在庫品です。 ●： Stocked items. 無印：弊社営業へお問合せください。 No mark： Contact with our sales department.

■ インサート Inserts

CPMT		CPMT Z			
Fig-1		(子刃) (Sub insert)	Fig-2		(親刃) (Main insert)
RE		面取り付 Chamfered		RE	
P 鋼	Carbon steels	■	■	■	■
M SUS等	SUS, etc.	■	■	■	■
K FC-FCD	Cast irons	■	■	■	■

■ : 一般切削・第一推奨
General cutting, First recommended

商品コード Item Code	精度 Tolerance Class	C		G		超硬 Carbide		寸法 Size(mm)	形状 Shape	希望小売価格(円) Suggested retail price(¥)		
		コーティング C Coating		コーティング G Coating		K				RE	CY250 HC844	WH10
		CY250	HC844	WH10	K							
CCMT060204	M級 M	●	●	●				0.4	Fig-1	790	610	
CPMT090308		●	●	●				0.8		920	720	
CPMT120408		●	●	●				0.8		1,690	1,310	
CPMT120430		●	●	●				3.0		1,690	—	
CPMT080204Z	M級 M	●	●	●				0.4	Fig-2	830	640	
CPMT090204Z		●	●	●				0.4		870	680	
CPMT120308Z		●	●	●				0.8		1,310	990	
CPMT160408Z		●	●	●				0.8		2,310	1,780	
CPMT160430Z		●	●	●				3.0		2,310	—	
CPMT190408Z		●	●	●				0.8		2,940	2,250	
CPMT190430Z		●	●	●				3.0		2,940	—	

Indexable Tools Other Tools

○ 標準切削条件表 Recommended cutting conditions

*赤字は第一推奨材種です。 Red indicates primary recommended grade.

被削材 Work material	推奨材種 Recommended grade	切削速度 Cutting speed (m/min)	加工形態 Machining mode	外径DC Tool dia.											
				φ16		φ20		φ25		φ32		φ40		φ50	
				回転数 Revolutions min ⁻¹	送り速度 Table speed mm/min	回転数 Revolutions min ⁻¹	送り速度 Table speed mm/min	回転数 Revolutions min ⁻¹	送り速度 Table speed mm/min	回転数 Revolutions min ⁻¹	送り速度 Table speed mm/min	回転数 Revolutions min ⁻¹	送り速度 Table speed mm/min	回転数 Revolutions min ⁻¹	送り速度 Table speed mm/min
軟鋼 Mild steels SS, SM (200HB以下)	CY250 HC844	80~150	肩削り Side milling	2,980	420	2,400	384	1,910	382	1,500	450	1,200	430	960	290
			※ ² ヘリカル加工 Helical		1,200	1,150	1,150	1,350	1,290	870					
			※ ¹ ドリル加工 Drilling	1,600	130	1,600	130	1,270	130	1,500	150	1,200	120	960	96
炭素鋼・合金鋼 Carbon steels・Alloy steels S-C, SCM (30HRC以下)	CY250 HC844	65~120	肩削り Side milling	2,980	420	2,400	384	1,910	382	1,500	450	1,200	430	960	290
			※ ² ヘリカル加工 Helical		1,200	1,150	1,150	1,350	1,290	870					
			※ ¹ ドリル加工 Drilling	1,280	100	1,280	100	1,020	100	1,200	120	960	100	770	80
炭素鋼・合金鋼 Carbon steels・Alloy steels (30~40HRC)	CY250 HC844	40~80	肩削り Side milling	1,600	224	1,270	203	1,020	204	800	240	640	220	510	150
			※ ² ヘリカル加工 Helical		660	530	640	700	640	670	510	460			
			※ ¹ ドリル加工 Drilling	700	60	720	60	570	60	680	70	540	55	430	45
ステンレス鋼 Stainless steels SUS	CY250 HC844	60~110	肩削り Side milling	2,000	280	1,600	256	1,270	254	1,050	320	840	300	670	200
			※ ² ヘリカル加工 Helical		800	770	770	960	900	600					
			※ ¹ ドリル加工 Drilling	1,120	90	1,120	90	890	90	1,050	100	840	80	670	70
鋳鉄 Cast irons FC, FCD	WH10	40~80	肩削り Side milling	3,000	600	2,400	480	1,910	380	1,500	450	1,200	360	960	290
			※ ² ヘリカル加工 Helical		1,250	1,000	1,200	1,320	1,270	870					
			※ ¹ ドリル加工 Drilling	700	60	720	60	570	60	680	70	540	55	430	45

- 【注意】**
- ※1. ドリル加工で長い切りくずの出る材料を加工される場合は、切りくずの巻き込みや飛散などによる事故がないように必ずステップ送りを行ってください。また切りくずが思わぬ方向に飛び散りますので、適切な安全策を施してご使用ください。
 - ※2. 大径穴の加工にはCNC (NC制御) のヘリカル機能G02, G03を用いてヘリカル加工で切削した方が切りくずの巻き込みが無く安全です。また非常に高効率な加工ができます。最小加工径はエンドミル外径 (DC) の1.2倍、最大加工径はエンドミル外径 (DC) の1.8倍です。
 - ① 被削材、加工形状に合わせて、適切なクーラントを使用してください。
 - ② この標準切削条件表は切削条件の目安を示すものです。実際の加工では加工形状、目的、使用機械等により条件を調整してください。
 - ③ 上記切削条件はレギュラータイプをご使用の場合です。ロングタイプ (AJUL) は上記送り速度の70%にてご使用ください。
 - ④ 加工底面を平滑仕上げるには、ドリル加工後横送り加工を行うか、またはコンタリング加工を行ってください。
 - ⑤ ポケット加工など切りくずの滞留しやすい加工時はエアで飛ばしながらご使用ください。

- 【Note】**
- ※1. When cutting materials which will create long chips when drilling, perform step feed to avoid accidents due to wrapping of chips or flying out of chips. In addition, since chips may fly out in unexpected directions, be sure to take safety precautions.
 - ※2. For large-diameter hole cutting, performing helical cutting using G02 or G03 helical function of the CNC (NC control) will be safer and avoid chip wrapping. In addition, extremely high performance cutting can be performed. The minimum cutting diameter is 1.2 times the end mill flute diameter (Dc) and the maximum cutting diameter is 1.8 times the end mill flute diameter (Dc).
 - ① Use the appropriate coolant for the work material and machining shape.
 - ② These recommended cutting conditions indicate only the rule of a thumb for the cutting conditions.
 - ③ In actual machining, the condition should be adjusted according to the machining shape, purpose and the machine type.
 - ④ The cutting conditions above are for using regular-type products. For long-type (AJUL) products, the feed rate should be 70% of the above value.
 - ⑤ For flat smoothing of the lower cutting surface, perform horizontal-feed cutting or contour cutting after drilling.
 - ⑥ When performing cutting such as pocket cutting, etc. where chips are likely to remain, air should be used to blow chips away during cutting.

ショルダーミル SP

- 鋼・鋳鉄用の汎用ショルダーカッタです。
 - クランプ駒止めにより、大きなチップポケットを確保しました。
- ・ A general purpose shoulder cutter for steel and cast iron.
 ・ Due to its clamp dowel stopper, a large chip pocket is available.

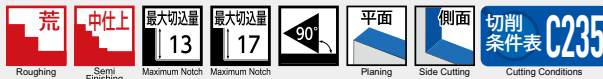

SPO○○○R(DX)B

○は数字が入ります。 Numeric figure in a circle ○

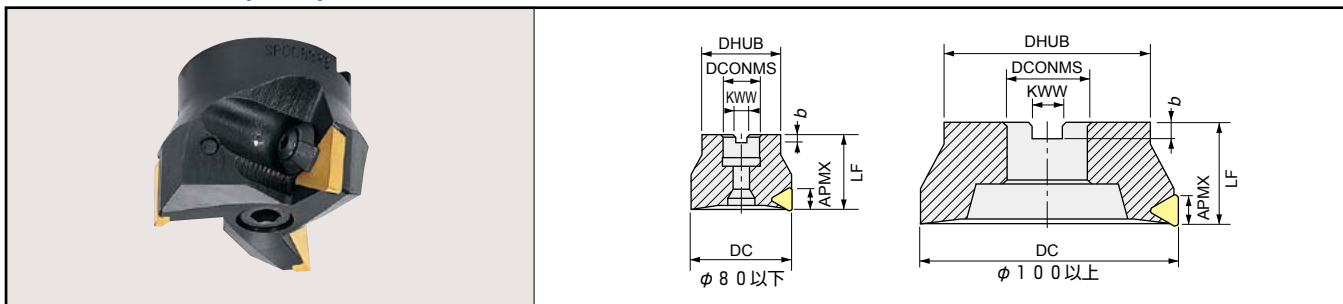

商品コード Item code	在庫 Stock	刃数 No. of flutes	寸法 Size (mm)							取付部 Mounting	適用インサート Inserts	
			DC	LF	DHUB	DCONMS	APMX	KWW	b			
SP0050RB		3	50	43	40	22.225	13	8.4	5	専用アーバ Dedicated Arbor	TP□32□R-□0 TP□N1603○○(□□)	
SP0050RDXB		3	50	43	40	22.225	13	8.4	5		アーバ方式 Arbor type	TP□43□R-□0(Y) TP□N2204○○(□□)
SP0063RB		3	63	47	50	22.225	17	8.4	5			
SP0063RDXB		3	63	47	50	22.225	17	8.4	5			
SP0080RB		4	80	50	65	25.4	17	9.5	6			
SP0100RB		5	100	50	85	31.75	17	12.7	8			
SP0125RB		6	125	63	93	38.1	17	15.9	10			
SP0160RB		7	160	63	128	50.8	17	19.1	11			

刃先交換式工具
その他の工具

部品番号 Parts

部品名 Parts	クランプ駒セット Clamp piece set	シート Seat	シート止ねじ Seat screw	レンチ Wrench	レンチ Wrench
形状 Shape					
適用カッタ Cutter body	希望小売価格(円) Suggested retail price(¥)	希望小売価格(円) Suggested retail price(¥)	希望小売価格(円) Suggested retail price(¥)	希望小売価格(円) Suggested retail price(¥)	希望小売価格(円) Suggested retail price(¥)
SP0050RB	CM5-141 2,030	-	-	-	101-T20 1,440
SP0050RDXB		831-170 1,590	831-180 500	100-225 200	
SP0063RB	CM6-147 2,030	-	-	-	101-T25S 1,440
SP0063RDXB		212-170 1,590	212-180 500	100-224 200	
SP0080RB					
SP0100RB					
SP0125RB				101-T25L 1,440	
SP0160RB					

[注意] ※ DX形はシート付きです。 **[Note]** Includes seat for DX type

専用ストレートアーバ Dedicated straight arbor

形状 Shape	商品コード Item Code	在庫 Stock	アーバ寸法 Size (mm)							適用カッタ Cutter body
			DCONWS	DCONMS	ℓs	LF	THSZWS	BD2		
	ショートタイプ Short type	100-231S	22.225	32	60	75	M10	45	SP0050RB/RDXB SP0063RB/RDXB	
	スタンダードタイプ Standard type	100-232	22.225	42	80	95	M10	48	SP0063RB/RDXB	
		100-233	25.4	M12	63	SP0080RB				
	ロングタイプ Long type	100-234	22.225	32	150	165	M10	45	SP0050RB/RDXB SP0063RB/RDXB	
		100-235	22.225	42	200	215	M10	48	SP0063RB/RDXB	
		100-236	25.4	M12	63	SP0080RB				

●印：標準在庫品です。 ●：Stocked items. 無印：弊社営業へお問合せください。 No mark：Contact with our sales department.

■ インサート Inserts

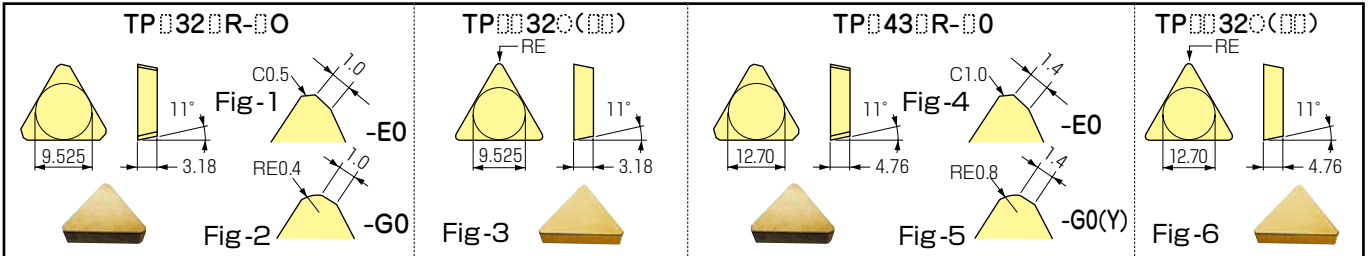

P 鋼 Carbon steels	M SUS等 SUS, etc.	K FC-FCD	
--------------------------	-------------------------	-----------------	--

商品コード (インチ系) Item code (Inch)	I.S.O.形番 I.S.O. (metric)	精度 Tolerance class	AJコート Cコート GXコート Gコート サーマット 超硬 Carbide										寸法 Size(mm)	形状 Shape	希望小売価格(円) Suggested retail price(¥)							
			AJ -Coated	C-Coated	GX-Coated	G-Coated	Cermet	P	K	CH550	EX35	WH10			RE	AJ,C,GX, Gコート	CH550 EX35 WH10					
TPMN321	TPMN160304	M級	●											●	●	●	0.4	Fig-3	—	820		
TPMN322	TPMN160308														●	●	●		0.8	1,040	820	
TPMN322Y	TPMN160308Y																		0.8	1,040	—	
TPMN321TN	TPMN160304TN														●				0.4	—	820	
TPMN322TN	TPMN160308TN														●	●			0.8	—	820	
TPMN431	TPMN220404														●	●			0.4	—	1,380	
TPMN432	TPMN220408														●	●	●		0.8	1,790	1,380	
TPMN432Y	TPMN220408Y														●	●			0.8	1,790	—	
TPMN433	TPMN220412		M級												●	●	●		1.2	Fig-6	1,790	1,380
TPMN431TN	TPMN220404TN															●					0.4	—
TPMN432TN	TPMN220408TN														●	●		0.8	—		1,380	
TPMN433TN	TPMN220412TN														●			1.2	—		1,380	
TPC32TR-E0	TPCN1603PPTR-E0	C級												●				Fig-1	—	1,760		
TPC32FR-E0	TPCN1603PPFR-E0	E級																	—	—		
TPE32TR-E0	TPEN1603PPTR-E0																		—	—		
TPK32TR-E0	TPKN1603PPTR-E0	K級												●	●				—	900		
TPK32FR-E0	TPKN1603PPFR-E0																		—	900		
TPK32TR-G0	TPKN1603PPTR-G0																		1,150	—		
TPK32TR-G0Y	TPKN1603PPTR-G0Y		●	●															1,150	—		
TPC43TR-E0	TPCN2204PDTR-E0	C級																	Fig-4	—	—	
TPC43FR-E0	TPCN2204PDFR-E0	E級																		—	—	
TPE43TR-E0	TPEN2204PDTR-E0																			—	—	
TPE43TR-G0Y	TPEN2204PDTR-G0Y																	1,780		—		
TPK43TR-E0	TPKN2204PDTR-E0	K級												●	●			—		1,250		
TPK43FR-E0	TPKN2204PDFR-E0																	—		1,250		
TPK43TR-G0	TPKN2204PDTR-G0																			1,620	—	
TPK43TR-G0Y	TPKN2204PDTR-G0Y			●	●															1,620	—	
TPK43FR-G0	TPKN2204PDFR-G0																	1,620		—		

【注意】GX2140は通電式タッチセンサーに反応しませんのでご注意ください。【Note】Please note that the GX2140 does not cause a reaction in conductive touch sensors.

○ 標準切削条件表 Recommended cutting conditions

<面切削> Face milling

※赤字は第一推奨材種です。Red indicates primary recommended grade.

被削材 Work material	作業区分 Application	推奨材種 Recommended grade	標準切削条件 Recommended cutting conditions		適用インサート Inserts			
			切削速度 (m/min) Cutting speed v_c (m/min)	1刃当りの送り (mm/t) Feed rate f_z (mm/t)	SPO050RB/RDXB	SPO063RB/RDXB ~ SPO160RB		
軟鋼 Mild steels SS, SM (200HB以下)	汎用 General	CH550, GX2140	150 ~ 200	0.1 ~ 0.25	TPC32TR-E0 TPC32TR-G0	TPC43TR-E0 TPC43TR-G0		
	荒用 Roughing	CY250, EX35 CY25, HC844	100 ~ 180	0.2 ~ 0.4				
炭素鋼・合金鋼 Carbon steels, Alloy steels S-C, SCM (30HRC以下)	汎用 General	CH550, GX2140	120 ~ 180	0.1 ~ 0.2			TPK32TR-E0 TPK32TR-G0	TPE43TR-G0Y
	荒用 Roughing	CY250, EX35 CY25, HC844	100 ~ 150	0.2 ~ 0.4				
炭素鋼・合金鋼 Carbon steels, Alloy steels (30 ~ 40HRC)	汎用 General	JP4120, CY250 EX35, CY25, HC844	60 ~ 120	0.1 ~ 0.15	TPMN320(E0)	TPK43TR-E0 TPK43TR-G0 TPMN430(E0)		
	汎用 General	JM4160 HC844	150 ~ 200	0.1 ~ 0.2				
ステンレス鋼 Stainless steels SUS	汎用 General							
鋳鉄 Cast irons FC, FCD	汎用 General	CY100H, WH10	80 ~ 130	0.1 ~ 0.3	TPC32FR-E0 TPK32FR-E0	TPC43FR-E0/G0 TPK43FR-E0/G0		
		JP4120, GX2140						

【注意】①被削材、加工形状に合わせて、適切なクーラントを使用してください。

②この標準切削条件表は切削条件の目安を示すものです。実際の加工では加工形状、目的、使用機械等により条件を調整してください。

【Note】③GX2140は、通電式タッチセンサーに反応しませんのでご注意ください。

① Use the appropriate coolant for the work material and machining shape.

② These recommended cutting conditions indicate the rule of a thumb for the cutting conditions. In actual machining, the condition should be adjusted according to the machining shape, purpose and the machine type.

③ Please note that the GX2140 does not cause a reaction in conductive touch sensors.

フライス切削用インサートの呼び方

刃先交換式工具
フライス切削用インサート

①形状記号 Insert shape	
記号 Symbol	形式 Insert shape
T	三角形 Triangle 60°
S	正四角形 Square 90°
R	円形 Round
E	75° ひし形 Diamond 75°
C	80° ひし形 Diamond 80°
O	正八角形 Octagonal 135°
A	平行四辺形 Parallelogram 85°
L	長方形 Rectangular 90°
Z	アルファボール、プレジジョン用 For Ball & Precisions
X	アルファボール用 For Ball End Mills
Y	アルファボール用 For Ball End Mills

②逃げ角記号 Normal clearance	
記号 Symbol	逃げ角 Clearance
C	7°
D	15°
E	20°
F	25°
N	0°
O	ネガ、ポジ Negative, Positive
P	11°

③精度記号 Tolerance class			
記号 Symbol	精度 Tolerances (mm)		
	内接円 Inscribed circle (d)	厚さ Thickness (s)	コーナ高さ Nose height (m)
A	±0.025	±0.025	±0.005
F	±0.013	±0.025	±0.005
C	±0.025	±0.025	±0.013
H	±0.013	±0.025	±0.013
E	±0.025	±0.025	±0.025
G(P)	±0.025	±0.13	±0.025
K	±0.05~0.13	±0.025	±0.013
M	±0.05~0.13	±0.13	±0.08~0.18
N	±0.05~0.13	±0.025	±0.08~0.18

インチ系
Inch Series

^①
S

^②
E

^③
E

4

2

メートル系
Metric Series

S

E

E

^④
N

^⑤
12

^⑥
03

^⑦
AF

④溝、穴記号 Fixing and/or chip breaker		
記号 Symbol	穴 Fixing	ブレーカ Chip breaker
F	なし Nil	両面にあり Both face
A	あり With hole	なし Nil
W*	あり With hole	なし Nil
G	あり With hole	両面にあり Both face
T*	あり With hole	片面にあり One face
M	あり With hole	片面にあり One face
X	—	—
N	なし Nil	なし Nil
R	なし Nil	両面にあり Both face

⑤切れ刃長さ記号と内接円記号 (メートル系) Edge length & diameter of inscribed circle (Metric series)									
R		S		C		T		内接円直径 Inscribed circle (mm)	内接円記号 Inscribed circle symbol (インチ系) (Inch)
記号 Symbol	寸法 Size (mm)	記号 Symbol	寸法 Size (mm)	記号 Symbol	寸法 Size (mm)	記号 Symbol	寸法 Size (mm)		
				E・A・L					
		06	6.35	06	6.5	11	11.0	6.35	2
		07	7.94	08	8.1	13	13.8	7.94	
09	9.525	09	9.525	09	9.7	16	16.5	9.525	3
10	10.0							10.0	
12	12.0							12.0	
12	12.70	12	12.7	12	12.9	22	22.0	12.70	4
15	15.875	15	15.875	16	16.1	27	27.5	15.875	5
16	16.0							16.0	
19	19.05	19	19.05	19	19.3	33	33.0	19.05	6

⑥厚さ記号 Thickness			
メートル系 Symbol (Metric)	厚み Thickness (mm)	インチ系 Symbol (Inch)	
		通常系列 Nomal Series	小形系列 Small Size Series
01	1.59	—	2
02	2.38	—	3
T2	2.78	—	—
03	3.18	2	4
T3	3.97	—	5
04	4.76	3	6
06	6.35	4	—
07	7.94	5	—
09	9.52	6	—

厚み記号には、近似する寸法を当てはめている場合あり

*穴の片側にテーパあり With tapered hole on one side

⑩ サライ刃形状区分記号 Wiper edge			
記号 Symbol	A	B	C
形状 Shape			
	2段チャンファー Two stepped chamfered	1段チャンファー Chamfered	3段チャンファー Three stepped chamfered
記号 Symbol	D	E	G
形状 Shape			
	2段チャンファー Two stepped chamfered	2段チャンファー Two stepped chamfered	1段チャンファー + コーナR One stepped chamfered and round

⑪ サライ刃角度記号 Cutting edge angle	
記号 Symbol	形状 Shape
0	
3	
5	
6	
9	
12	

⑭ ワイパー幅 Width of wiper edge	
記号 Symbol	W: 寸法 (mm) Size
1	1.0
2	1.2
3	1.4
4	1.6
5	1.8
6	2.0
7	2.2
8	2.5
9	2.8
0	3.2

W: 寸法

(ワイパーが特殊の場合記入)
(If the width of wiper edge is special, fill in.)

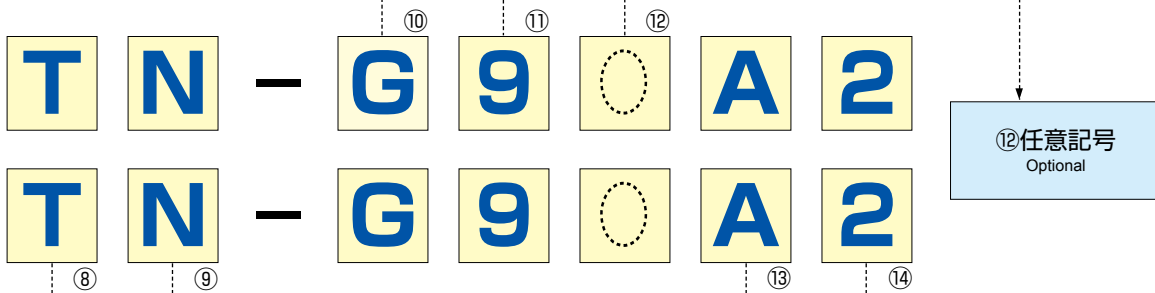

⑦ コーナ記号 (メートル系) Corner configuration (Metric series)						
コーナR Corner radius		コーナ角 Corner angle		切込み角 Depth angle	サライ刃 Wiper edge	
記号 Symbol	コーナ半径 Corner radius R (mm)	記号 Symbol	コーナ角 Corner angle	切込み角 Depth angle	記号 Symbol	サライ刃 Clearance
02	0.2	A	45°	45°	A	3°
04	0.4	D	30°	60°	B	5°
08	0.8	E	15°	75°	C	7°
12	1.2	F	5°	85°	D	15°
16	1.6	P	0°	90°	E	20°
20	2.0	Z	その他の角度 Others		F	25°
24	2.4				G	30°
					N	0°
					P	11°
					Z	その他の角度 Others

〔円形トップ〕 直径インチ寸法系の場合は00, メートル寸法系の場合はMOを適用する。(インチ系は0を使用する。)
Round top: 00 for inch-based diameter dimensions; M0 for metric dimensions. (Inch system uses 0.)

⑧ 刃先処理記号 Cutting edge condition	
記号 Symbol	形状 Shape
T	ネガホーニング Chamfered cutting edges
E	丸ホーニング Rounded cutting edges
F	ホーニングなし Sharp cutting edges
S	複合ホーニング Chamfered and rounded cutting edges

⑨ 勝手記号 Feed direction	
記号 Symbol	勝手 Feed direction
R	右勝手 Right hand
L	左勝手 Left hand
N	勝手なし Neutral

⑬ ワイパー切れ刃 ホーニング幅 Honing on wiper edge	
記号 Symbol	h: 寸法 (mm) Size
A	0.06
B	0.10
C	0.15
D	0.20

h: 寸法 (mm)
Size

※各記号に対応するインサート現品寸法は、製品仕様により必ずしも一致するわけではありません。

フライス切削用インサート







形状 Shape	商品コード Item code	ISO型番 ISO (metric)	精度 Tolerance class	コーティング Coating										適用カッタ Cutter 掲載頁 Page					
				AJコーティング AJ Coating		JSコーティング JS Coating		THコーティング TH Coating		PNコーティング PN Coating		Cコーティング C Coating			GXコーティング GX Coating		Gコーティング G Coating		
				JP4105	JP4120	JM4160	JS4030	JS4045	JS4060	TH308	TH315	PN215			CY250		GX2140		GF30
	XPHW0903R-20		H級 H						●	●									
	XPHW0903R-30								●	●									
	YPHW0903R-20								●	●									
	YPHW0903R-30								●	●									
	YPHW1203R-30		H級 H						●	●									
	TPHW0902-20		H級 H						●	●									
	TPHW1303-25								●	●									
	TPHW1403-30								●	●									
	ZPHW160-LB16		H級 H						●	●									
	ZPHW160-LB16-R5								●	●									
	ZPHW200-LB20								●	●									
	ZPHW200-LB20-R6								●	●									
	ZPHW250-LB25								●	●									
	ZPHW250-LB25-R8								●	●									
	ZPHW300-LB30								●	●									
	ZPHW300-LB30-R10		H級 H						●	●									
	ZDHW120-T43R1.2-30								●	●									
	ZDHW160-T43R1.6-40								●	●									
	ZDHW200-T43R2-50								●	●									
	ZDHW250-T43R2.5-62.5								●	●									
	ZDHW300-T43R3-75		H級 H						●	●									
	SDNW120520TR		N級 N	●	●	●		●					●						
	SDNW120520TR-P			●	●									●					
	SDNW150525ZTR		M級 M	●	●			●					●						
	SDMT120520TR			●	●			●					●						
	SDMT150525ZTR		M級 M	●	●			●					●						
	WOMU140620ER-FC			●	●	●		●					●						
	WOMU140620ER-FB			●	●	●		●					●						
	WOMU140630ER-HC		M級 M	●	●	●		●					●						
				●	●	●		●					●						
	ENMU0603ER-B		M級 M	●	●		●					●							
	ENMU0603ER-C			●	●		●						●						
	ENMU0603ER-C		G級 G	●															
	EPNW0803TN-10		N級 N	●	●	●		●	●			●		●					
	EDNW10T3TN-10			●	●	●		●	●			●		●		●			
	EDNW13T4TN-10			●	●	●		●	●			●		●		●			
	EDNW13T4TN-15			●	●	●		●	●			●		●		●			
	EDNW15T4TN-10			●	●	●		●	●			●		●		●			
	EDNW15T4TN-15			●	●	●		●	●			●		●		●			
	E級 E	EDEW13T4TN-10		E級 E					●				●						
		EDEW13T4TN-15							●				●						
		EDEW15T4TN-10							●				●						
		EDEW15T4TN-15							●				●						
		EDNW13T4TN-15Z			N級 N	●	●		●	●									
		EDNW15T4TN-15Z				●	●		●	●									
M級 M	EDMT13T4TN-15		M級 M		●		●	●				●		●					
	EDMT15T4TN-15				●		●	●				●		●					

刃先交換式工具
フライス切削用インサート





異形工具
Special shape tools

高送りラジアスマイル
High Feed Radius end mill

●印：標準在庫品です。 無印：弊社営業へお問合せください。 -印：製作致しません。
● : Stocked items. No mark : Contact with our sales department. - : Not Manufactured.

形状 Shape	商品コード Item code	ISO型番 ISO (metric)	精度 Tolerance class	コーティング Coating										適用カッタ Cutter 掲載頁 Page					
				AJコーティング AJ Coating		JSコーティング JS Coating		THコーティング TH Coating		Cコーティング C Coating		GXコーティング GX Coating			Gコーティング G Coating		非コーティング Non Coating		
				JP4105	JP4115	JP4120	JM4160	JS4045	JS4060	PTH08M		CY100H	CY25		CY250	GX2140		GF30	WH10
高送りラジアスマイル High Feed Radius end mill		WDNW09T320	N級 N	●		●	●	●	●				●						
	WDNW120420	●			●	●	●	●					●						
	WDNW140520	●			●	●	●	●					●						
	WDNT09T320						●	●					●						
	WDNT120420						●	●					●						
	WDNT140520						●	●					●						
	WDNT09T320-B				●	●	●	●					●						
	WDNT120420-B				●	●	●	●					●						
	WDNT140520-B				●	●	●	●					●						
	WDNW120420Z					●	●	●					●						
	WDNW140520Z					●	●	●					●						
	WDNT09T320ZH						●	●											
	WDNT120420ZH						●	●											
	WDNT140520ZH						●	●											
	SDNW1205ZDTN-R15		N級 N	●		●	●	●					●	●					
	SDMT1205ZDTN-R15		M級 M	●		●	●	●					●	●					
	SPNW07T2TR		N級 N	●		●	●	●					●						
	SPMT07T2TR		M級 M			●	●	●											
	SPMT07T2ER-LF					●	●												
	EPNW0603TN-8		N級 N	●		●	●	●	●				●						
	EDNW12T3TN-10		M級 M	●		●	●	●	●				●						
	EPMT0603TN-8			●		●	●	●	●				●						
	EDMT12T3TN-10			●		●	●	●	●				●						
	EPMT0603EN-8LF					●													
	EPHW0402TN-2		H級 H	●	●														
	ZDNW1204080TR		N級 N	●		●	●	●	●										
	ZDNW1505100TR		M級 M	●		●	●	●	●										
	ZDMT1204080TR			●		●	●	●	●										
	ZDMT1505100TR			●		●	●	●	●										
ラジアスマイル Radius end mill	RDMW0501M0EN		M級 M	●			●						●						
	RDMW0702M0EN		H級 H	●			●						●						
	RDHW0802M0TN						●	●					●						
	RDMT0802M0TN		M級 M	●		●	●	●	●				●	●					
	RDMT0802M0EN		H級 H														●		
	RDHW10T3M0TN						●						●						
	RDMT10T3M0TN		M級 M	●		●	●	●	●				●	●			●		
	RDMT10T3M0EN		H級 H										●				●		
	RDHW1204M0TN						●						●						
	RDMT1204M0TN		M級 M	●		●	●	●	●				●						
	RDMT1204M0EN		H級 H																
	RDHW1604M0TN						●						●						
	RDMX1604M0TN		M級 M																
	RDMX1604M0EN						●						●						
RDMT1604M0TN				●		●	●	●	●				●						

フライス切削用インサート

形状 Shape	商品コード Item code	ISO型番 ISO (metric)	精度 Tolerance class	コーティング Coating										非コーティング Non Coating	適用カット Cutter 掲載頁 Page		
				AJコーティング AJ Coating	AXコーティング AX Coating	JSコーティング JS Coating	THコーティング TH Coating	PNコーティング PN Coating	SDコーティング SD Coating	Cコーティング C Coating	GXコーティング GX Coating	超硬 Carbide	K				
				JP4105	JP4120	JM4160	AX2040	JS1025	JS4045	TH308	PN215	SD5010	CY100H	CY250		GX2160	WH10
	RDMT1604M0EN		M級 M							-	●			●		快削形アルファ ラジiasmil AR C72	
	RDHW1605M0TN		H級 H				●			-	●						
	RDMT1605M0TN		M級 M	●	●		●			-	●						
	RDMT1605M0EN		M級 M														
	RNMG1205M0EN-B16		M級 M		●	●							●			アルファ ラジiasmil RD16B C82	
	RNMG1606M0EN-B16		M級 M		●	●							●				
 	RPET10T3M0FN-A8		E級 E		-	-	●			●	-	-	-			アルファ ラジiasmil RV C86	
	RPMT10T3M0EN-B8		M級 M		●	●	-			-	-	-	●	-			
	RPMT10T3M0EN-C8		M級 M		●	●	-			-	-	-	●	-			
	RPHT10T3M0EN-B8		H級 H		●	●	●			-	-	-	●	-			
	RPHT10T3M0EN-C8		H級 H		●	●	-			-	-	-	●	-			
	RPET1204M0FN-A8		E級 E		-	-	●			●	-	-	-				
	RPMT1204M0EN-B8		M級 M		●	●	-			-	-	-	●	-			
	RPMT1204M0EN-C8		M級 M		●	●	-			-	-	-	●	-			
	RPHT1204M0EN-B8		H級 H		●	●	●			-	-	-	●	-		アルファラジiasmil プレジジョン ARPF C92	
	RPHT1204M0EN-C8		H級 H		●	●	-			-	-	-	●	-			
	ZCFG06NSG-R0.3		F級 F					●	●								
	ZCFG06NSG-R0.5							●	●								
	ZCFG06NSG-R1.0							●	●								
	ZCFG080SG-R0.3							●	●								
	ZCFG080SG-R0.5							●	●								
	ZCFG080SG-R1.0							●	●								
	ZCFG080SG-R1.5							●	●								
	ZCFG080SG-R2.0							●	●								
	ZCFG100SG-R0.3							●	●								
	ZCFG100SG-R0.5							●	●								
	ZCFG100SG-R1.0							●	●								
	ZCFG100SG-R1.5							●	●								
	ZCFG100SG-R2.0							●	●								
	ZCFG100SG-R3.0							●	●								
	ZCFG120SG-R0.3							●	●								
	ZCFG120SG-R0.5							●	●								
	ZCFG120SG-R1.0							●	●								
	ZCFG120SG-R1.5							●	●								
	ZCFG120SG-R2.0							●	●								
	ZCFG120SG-R3.0							●	●								
	ZCFG130SG-R0.3							●	●								
	ZCFG130SG-R0.5							●	●								
ZCFG130SG-R1.0							●	●									
ZCFG130SG-R1.5							●	●									
ZCFG130SG-R2.0						●	●										
ZCFG130SG-R3.0						●	●										
ZCFG160SG-R0.3						●	●										
ZCFG160SG-R0.5						●	●										
ZCFG160SG-R1.0						●	●										
ZCFG160SG-R1.5						●	●										
ZCFG160SG-R2.0						●	●										
ZCFG160SG-R3.0						●	●										

刃先交換式工具
フライス切削用インサート







ラジiasmil
Radius end mill

●印：標準在庫品です。 無印：弊社営業へお問合せください。 -印：製作致しません。
 ●：Stocked items. No mark：Contact with our sales department. -：Not Manufactured.

形状 Shape	商品コード Item code	ISO型番 ISO (metric)	精度 Tolerance class	コーティング Coating										ノンコーティング Non Coating			適用カッタ Cutter 掲載頁 Page		
				AJコーティング AJ Coating		JSコーティング JS Coating		THコーティング TH Coating	HDコーティング HD Coating	Cコーティング C Coating		Gコーティング G Coating		CBN	超硬 Carbide P K				
				JP4120		JS4030	JS4060	TH308	PTH08M	HD7010	PCA12M	CY250	CY9020		HC844	BH250		EX35	WH10
ラジ ア ス エ ン ド ミ ル Radius end mill	ZCFW160-R0.3		F級 F					●	●	●									
	ZCFW160-R0.5								●	●	●								
	ZCFW160-R1.0								●	●	●			●					
	ZCFW160-R1.5								●	●	●			●					
	ZCFW160-R2.0								●	●	●			●					
	ZCFW160-R3.0								●	●	●			●					
	ZCFW200-R0.3								●	●	●								
	ZCFW200-R0.5								●	●	●								
	ZCFW200-R1.0								●	●	●			●					
	ZCFW200-R1.5								●	●	●			●					
	ZCFW200-R2.0								●	●	●			●					
	ZCFW200-R3.0								●	●	●			●					
	ZCFW250-R0.3								●	—	●								
	ZCFW250-R0.5								●	—	●								
	ZCFW250-R1.0								●	—	●			●					
	ZCFW250-R2.0								●	—	●			●					
	ZCFW250-R3.0								●	—	●			●					
	ZCFW300-R0.3								●	—	●								
	ZCFW300-R0.5								●	—	●								
	ZCFW300-R1.0								●	—	●			●					
	ZCFW300-R2.0								●	—	●			●					
	ZCFW300-R3.0								●	—	●			●					
	ZCFW320-R0.3								●	—	●								
	ZCFW320-R0.5								●	—	●								
ZCFW320-R1.0							●	—	●										
ZCFW320-R2.0							●	—	●										
ZCFW320-R3.0							●	—	●										
ボ ー ル エ ン ド ミ ル Ball end mill	ZPET080R-B		E級 E	●		●	●												
	ZPET100R-B			●		●	●												
	ZPET125R-B			●		●	●												
	ZPET150R-B			●		●	●												
	ZPET160R-B			●		●	●												
	ZPET200R-B			●		●	●												
	ZPET250R-B			●		●	●												
	ZPET080R-C		E級 E	●			●												
	ZPET100R-C			●			●												
	ZPET125R-C			●			●												
	ZPET150R-C			●			●												
	ZPET160R-C			●			●												
	ZPET200R-C			●			●												
	ZPET250R-C		E級 E	●			●												
	ZPET200R-N			●		●	●	—											
	ZPET250R-N		●		●	●	—												
	CPMT070304		M級 M			●	—												
	CPMT090308					●	—												
CPMT120408					●	—													
ZCET080CE	ZCET080CE	E級 E	●							●									
ZCET100CE	ZCET100CE		●							●									
ZCEW100CE	ZCEW100CE									●	●			●					
ZCET125CE	ZCET125CE		●							●									
ZCEW125CE	ZCEW125CE									●	●			●					
ZCET150CE	ZCET150CE		●							●									
ZCEW150CE	ZCEW150CE									●	●			●					
ZCET160CE	ZCET160CE		●							●									
										●									

△印:在庫が無くなり次第受注生産品となるものです。 ー印:製作致しません。
△: When the stock is out, will become to produce on request. ー: Not Manufactured.





フライス切削用インサート

形状 Shape	商品コード Item code	ISO型番 ISO (metric)	精度 Tolerance class	コーティング Coating											ノンコーティング Non Coating		適用カッタ Cutter 掲載頁 Page		
				AJコーティング AJ Coating		JSコーティング JS Coating	THコーティング TH Coating			PNコーティング PN Coating		HDコーティング HD Coating	Cコーティング C Coating		Gコーティング G Coating			超硬 Carbide	
				JP4105	JP4120	JS4060	ATH08M	ATH10E	ATH80D	TH30S	PN08M	PN15M	HD7010	CY250	CY9020	HC844		EX35	WH10
	ZCEW200CE	ZCEW200CE	E級 E											●	●				
	ZCET080SE	ZCET080SE			●										●				
	ZCET100SE	ZCET100SE			●										●				
	ZCEW100SE	ZCEW100SE												●	●	●			
	ZCET125SE	ZCET125SE			●									●					
	ZCEW125SE	ZCEW125SE												●	●	●			
	ZCET150SE	ZCET150SE			●									●					
	ZCEW150SE	ZCEW150SE												●	●	●			
	ZCET160SE	ZCET160SE			●									●					
	ZCEW200SE	ZCEW200SE												●	●				
	CPMT080204	CPMT080204	M級 M										●	●					
	CPMT090308	CPMT090308											●	●				●	
	ZCET250CE		E級 E										●	●	●				
	ZCET250CE-N												●	●	●				
	ZPET200CE			●		●		●											
	ZPET200CE-N			●		●		●											
	ZPET250CE			●		●		●					●						
	ZPET250CE-N			●		●		●					●	●					
	ZPET250CE-N2			-		-		-					●	-					
	ZPET250CE-N3					●		-											
ZPET250CE-LH						-													
	ZCET250SE		E級 E																
	ZCET250SK												●	●	●				
	ZCET250SK-N												●	●	●				
	ZPET200SK			●		●		●											
	ZPET200SK-N			●		●		-											
	ZPET250SK			●		●		●					●						
	ZPET250SK-N			●		●		●					●	●					
	ZPET250SK-N2			-		-		-					●	-					
	ZPET250SK-N3					●		-											
	ZPET250SK-LH							-											
	CPMT090308	CPMT090308	M級 M										●	●				●	
	CPMT120408	CPMT120408											●	●				●	
	ZPFG06N-SH		F級 F																
	ZPFG080-SH																		
	ZPFG100-SH																		
	ZPFG120-SH																		
	ZPFG160-SH																		
	ZPFG200-SH																		
	ZPFG250-SH																		
	ZPFG300-SH																		
	ZDFG06N-ST		F級 F																
	ZDFG080-ST																		
	ZDFG100-ST																		
	ZDFG120-ST																		
	ZDFG160-ST																		
	ZDFG200-ST																		
	ZDFG250-ST																		
	ZDFG300-ST																		
ZDFG06N-SC	ZDFG080-SC		F級 F																
	ZDFG100-SC																		
	ZDFG120-SC																		
	ZDFG120-SC																		

刃先交換式工具
フライス切削用インサート

ボールエンドミル
Ball end mill

●印：標準在庫品です。 無印：弊社営業へお問合せください。 -印：製作致しません。
 ● : Stocked items. No mark : Contact with our sales department. - : Not Manufactured.

形状 Shape	商品コード Item code	ISO型番 ISO (metric)	精度 Tolerance class	コーティング Coating										ノンコーティング Non Coating	適用カッタ Cutter 掲載頁 Page				
				THコーティング TH Coating		CSコーティング CS Coating		PNコーティング PN Coating		HDコーティング HD Coating		Cコーティング C Coating		CBN					
				ATH10E	ATH80D	PTH08M	ACS05E	PN08M	PN15M	HD7010	PCA08M	PCA12M	BH200						
	ZDFG160-SC		F級 F																
	ZDFG200-SC																		
	ZDFG250-SC																		
	ZDFG300-SC																		
	ZDFG06N-SF		F級 F																
	ZDFG080-SF																		
	ZDFG100-SF																		
	ZDFG120-SF																		
	ZDFG160-SF																		
	ZDFG200-SF																		
	ZDFG250-SF																		
	ZDFG300-SF																		
	ZPFG080		F級 F																
	ZPFG100																		
	ZPFG120																		
	ZPFG160																		
	ZPFG200																		
	ZPFG250																		
	ZPFG300																		
ZPFG320																			
	ZPFG060-GF		F級 F																
	ZPFG080-GF																		
	ZPFG080-GH																		
	ZPFG100-GF																		
	ZPFG100-GH																		
	ZPFG120-GF																		
	ZPFG120-GH																		
	ZPFG160-GF																		
	ZPFG160-GH																		
	ZPFG200-GF																		
	ZPFG200-GH																		
	ZPFG250-GF																		
	ZPFG250-GH																		
	ZPFG300-GF																		
ZPFG300-GH																			
ZPFG320-GF																			
ZPFG320-GH																			
	ZDFG060-WF		F級 F																
	ZDFG060-WH																		
	ZDFG080-WF																		
	ZDFG080-WH																		
	ZDFG100-WF																		
	ZDFG100-WH																		
	ZDFG120-WF																		
	ZDFG120-WH																		
	ZDFG160-WF																		
	ZDFG160-WH																		
	ZDFG200-WF																		
	ZDFG200-WH																		
	ZDFG250-WF																		
	ZDFG250-WH																		
	ZDFG300-WF																		
	ZDFG300-WH																		
ZDFG320-WF																			
ZDFG320-WH																			





ボールエンドミル
Ball end mill

アルファボール
プレジジョンF
ABPF
C126





Indexable Tools

Milling Inserts

フライス切削用インサート

形状 Shape	商品コード Item code	ISO型番 ISO (metric)	精度 Tolerance class	コーティング Coating												適用カッタ Cutter 掲載頁 Page					
				AJコーティング AJ Coating		JSコーティング JS Coating		THコーティング TH Coating					PNコーティング PN Coating		SDコーティング SD Coating		GXコーティング GX Coating				
				JP4105	JP4120	JM4160	JS4045	JS4060	ATH10E	ATH80D	TH30S	PTH13S	PTH30E	PTH40H	PN215		PN15M	SD5010	GX2160		
	ZDFG06N-ST		F級 F																アルファボール プレジジョンF ABPFN C134		
	ZDFG08N-ST																				
	ZDFG10N-ST																				
	ZDFG12N-ST																				
	ZDFG16N-ST																				
	ZDFG20N-ST																				
	ZDFG25N-ST																				
	ZDFG30N-ST																				
	ZDFG200CE		F級 F																アルファボール プレジジョン マルチフルート ABP4F C136		
	ZDFG200CT																				
	ZDFG250CE																				
	ZDFG250CT																				
	ZDFG300CE																				
	ZDFG300CT																				
	ZDFG200SE																				
	ZDFG200SK																				
	ZDFG250SE																				
	ZDFG250SK																				
	ZDFG300SE																				
	ZDFG300SK																				
	ZDFG200SET																				
	ZDFG250SET																				
ZDFG300SET																					
	JDMT070202R		M級 M	●	●	●											●		アルファスーパー エクセレントミニ ASM C140		
	JDMT070204R			●	●	●												●			
	JDMT070208R			●	●	●												●			
	EDMT070220R-T			●	●	●															
	EDMT070220R			●	●	●															
	JDMT080304L		M級 M	●		●	●												アルファ快削 じゅうおう AHJ C160		
	JDMT080308L			●		●	●														
	JDMT090304R			●		●	●														
	JDMT090308R			●		●	●														
	JDMT100304L			●		●	●														
	JDMT100308L			●		●	●														
	JDMT100320L			●		●	●														
	JDMT12T308L			●		●	●														
	JDMT12T320L			●		●	●														
	JDMT12T330L			●		●	●														
	JDMT12T308R			●		●	●														
	JDMT12T320R			●		●	●														
	JDMT12T330R			●		●	●														
JDMT160508L		●		●	●																
JDMT160530L		●		●	●																
	JDMT100304R		M級 M	●		●	●												アルファ超快削 エンドミル AHU C146		
	JDMT100308R			●		●	●														
	JDMT100320R			●		●	●														
	JDMT100332R			●	●	●	●														
	JDMT100304R-FW			●		●	●														
	JDMT100308R-FW			●	●	●	●														
	JDMT100308R-B5			●	●																
	JDMT100308R-C5			●																●	
	JDMT100320R-B5			●	●																
	JDMT100320R-C5			●																●	
	JDMT100330R-B5			●	●																

●印：標準在庫品です。 無印：弊社営業へお問合せください。 -印：製作致しません。
 ● : Stocked items. No mark : Contact with our sales department. - : Not Manufactured.

形状 Shape	商品コード Item code	ISO型番 ISO (metric)	精度 Tolerance class	コーティング Coating												ノンコーティング Non Coating			適用カッタ Cutter 掲載頁 Page			
				AJコーティング AJ Coating		JSコーティング JS Coating		THコーティング TH Coating		HDコーティング HD Coating		SDコーティング SD Coating		Cコーティング C Coating		GXコーティング GX Coating		Gコーティング G Coating		サーメット Cermets	超硬 Carbide	
				JP4120	JM4160	JS4045	JS4060	PTH13S	PTH30E	PTH40H	HD7010	SD5010	CY100H	CY25	CY250	GX2140	GX2160	HC844		CH550	EX35	WH10
	JDMT100330R-C5		M級 M	●																アルファ超快削 エンドミル AHU C146		
	JDMT100332R-B5		M級 M	●	●																	
	JDMT100332R-C5		M級 M	●											●							
	JDMT150504R		M級 M	●		●	●	●												アルファ快削 じゅうおう AHJ C160		
	JDMT150508R		M級 M	●		●	●	●	●													
	JDMT150520R		M級 M	●		●	●	●	●													
	JDMT150530R		M級 M	●		●	●	●	●													
	JDMT150504R-FW		M級 M	●	●	●	●	●	●													
	JDMT150508R-FW		M級 M	●	●	●	●	●	●													
	JDMT150508R-TFW		M級 M	●	●	●	●	●	●													
	JDMT150508R-B7		M級 M	●	●																	
	JDMT150508R-C7		M級 M	●											●							
	JDMT150520R-B7		M級 M	●	●																	
	JDMT150520R-C7		M級 M	●	●										●							
	JDMT150530R-B7		M級 M	●	●																	
	JDMT150530R-C7		M級 M	●	●										●							
	JDET100304R-FF		E級 E			●		●	●											アルファ快削 シヨルダーミル 4コーナ SS4P C154		
	JDET100308R-FF		E級 E			●		●	●													
	JDET150504R-FF		E級 E			●		●	●													
	JDET150508R-FF		E級 E			●		●	●													
JDET100304R-FA		E級 E		-	-					●								●				
JDET150502R-FA		E級 E		-	-					●								●				
JDET150504R-FA		E級 E		-	-					●								●				
JDET150530R-FA		E級 E		-	-					●								●				
	SPMT100304R-FW		M級 M	●										●					アルファ快削 シヨルダーミル 4コーナ SS4P C154			
	SPMT100308R-FW		M級 M	●										●								
	SPMT100308R-TFW		M級 M	●										●								
	TEE32TR-GO	TEEN1603PETR-GO	E級 E									●			●	●			アルファ 90 SES90-3000			
	TEE32FR-GO	TEEN1603PEFR-GO	E級 E												●							
	TEK32TR-GO	TEKN1603PETR-GO	K級 K																アルファ 90 SE(L)90-4000 C156			
	TEK32FR-GO	TEKN1603PEFR-GO	K級 K																			
	TEE43TR-GO	TEEN2204PETR-GO	E級 E									●			●	●	●					
	TEE43TR-GOY	TEEN2204PETR-GOY	E級 E	●	●							●	●	●								
	TEE43FR-GO	TEEN2204PEFR-GO	E級 E																			
	TEE43TR-GOE	TEEN2204PETR-GOE	E級 E												●	●	●					
	TEE43FR-GOE	TEEN2204PEFR-GOE	E級 E												●	●	●					
	TEK43TR-GOE	TEKN2204PETR-GOE	K級 K												●	●	●					
TEK43FR-GOE	TEKN2204PEFR-GOE	K級 K												●	●	●						
	APET120202SR	APET120202SR	E級 E												●	●			快削 エンドミル UEX C158			
	APET120202ER	APET120202ER	E級 E															●				
	APET120202FR	APET120202FR	E級 E															●				
	APET120204SR	APET120204SR	E級 E												●	●		●				
	APET120204ER	APET120204ER	E級 E												●	●		●				
	APET120208SR	APET120208SR	E級 E												●	●		●				
	APET120208ER	APET120208ER	E級 E												●	●		●				
	APEW120204SR	APEW120204SR	E級 E															●				
	APNT120208SR	APNT120208SR	N級 N												●	●	●					
	APNT120208ER	APNT120208ER	N級 N												●	●	●					
	ADET160302SR	ADET160302SR	E級 E												●	●						
	ADET160302ER	ADET160302ER	E級 E												●	●						
	ADET160302FR	ADET160302FR	E級 E															●				
	ADET160304SR	ADET160304SR	E級 E												●	●						
ADET160304ER	ADET160304ER	E級 E												●	●							







スクエアエンドミル
Square end mill

Indexable Tools

Milling Inserts

フライス切削用インサート

刃先交換式工具
フライス切削用インサート

形状 Shape	商品コード Item code	ISO型番 ISO (metric)	精度 Tolerance Class	コーティング Coating						ノンコーティング Non Coating			適用カッタ Cutter 掲載頁 Page					
				AJコーティング AJ Coating		JSコーティング JS Coating		THコーティング TH Coating	Cコーティング C Coating		Gコーティング G Coating	サメット Cermet		超硬 Carbide	K			
				JM4160		JS1025	JS4045	JS4060	TH308		CY100H	CY250		CY250V	GF30	HC844	CH550	EX35
	ADET160308SR	ADET160308SR	E級 E										●				快削 エンドミル UEX C158	
	ADET160308ER	ADET160308ER							●									●
	ADEW160308SR	ADEW160308SR	N級 N															
	ADNT160308SR	ADNT160308SR											●					
	ADNT160308ER	ADNT160308ER							●									●
	ADMT080308L		M級 M						●	●							アルファスーパー じゅうおう ASJ C168 アルファ快削 エンドミル AHF	
	ADMT100308L								●	●								
	ADMT100320L										●							
	ADMT12T308L									●	●							
	ADMT12T320L									●	●							
	ADMT12T330L									●	●							
	APMT160408L									●	●							
	APMT160430L									●	●							
	APMT170408L									●	●							
	APMT170430L									●	●							
	APMT190508L									●	●							
	APMT190530L									●	●							
	APMT250508L									●	●							
APMT250530L								●	●									
	APMT090208R		M級 M						●	●							アルファ快削 エンドミル AHF	
	ACMT100304R								●	●								
	ACMT100308R								●	●								●
	ACMT100320R										●							
	APMT12T308R								●	●								
	APMT12T320R								●	●								
	APMT12T330R								●	●								
	APMT150408R								●	●								●
	APMT150420R								●	●								
	APMT150430R								●	●								
APET150408R-U		E級 E						●	●									
	MPHW09T308ZEL		H級 H			●				●							アルファスーパー バーチカルミル ASV C174	
	MPHW110408ZEL					●				●								
	MPHW120516ZEL					●				●	●							
	MPHW120516ZFL					●				●	●					●		
	APHW190616ZEL					●				●	●							
	APHW190616ZFL					●				●	●					●		
	MPMT09T308ZEL			M級 M			●				●	●						
	MPMT110408ZEL						●				●	●	●					
	MPMT120508ZEL						●				●	●	●					
	MPMT120516ZEL						●				●	●	●					
APMT190616ZEL				●				●	●	●								
	APMT120508R-FT		M級 M	●			●										アルファラフィング エンドミル AME C180	
	APMT120530R-FT			●			●											
	APMT120508R-N2			●			●											
	APMT120508R-N3			●			●											
	APMT120508R-RS					●												
	APMT120520R-RS					●												
APMT120530R-RS				●														
	MPHT040202ZEL		H級 H				●										アルファ ポリッシュミル Vタイプ ASPVmini C184	
	MPHT040202ZEL-0.5						●											
	MPHT040205ZEL						●											
	MPHT040205ZEL-0.5						●											
	MPHT040210ZEL						●											
	MPHT040210ZEL-0.5						●											

●印：標準在庫品です。 無印：弊社営業へお問合せください。 -印：製作致しません。
 ● : Stocked items. No mark : Contact with our sales department. - : Not Manufactured.

形状 Shape	商品コード Item code	ISO型番 ISO (metric)	精度 Tolerance Class	コーティング Coating										ノンコーティング Non Coating					適用カッタ Cutter 掲載頁 Page								
				AJコーティング AJ Coating		JSコーティング JS Coating		THコーティング Cermet Coating		SDコーティング C Coating		GXコーティング GX Coating		Gコーティング G Coating		CBN		サーメット Cermet		超硬 Carbide							
				JP4105	JP4120	JM4160	JS4045	JS4060	ATH08M	MZ1000	SD5010	CY100H	CY25	CY250	GX2120	GX2140	HC844	BH250		Max1	CH550	CH7030	EX35	WH10	P	K	
スクエアエンドミル Square end mill	MPHW060302ZEL		H級 H																						アルファ ポリッシュミル Vタイプ ASPV C192 ザグリ加工用 ASPV-Z C206		
	MPHW060302ZEL-0.5																										
	MPHW060304ZEL																										
	MPHW060304ZEL-0.5																										
	MPHW060304ZFL																										
	MPHW060308ZEL																										
	MPHW060308ZEL-1.5																										
	MPHW060308ZFL																										
	MPHW060320ZEL																										
	MPNW060308ZEL			N級 N																							
MPNW060320ZEL																											
スクエアエンドミル Square end mill	MT0920133		—																						Max1刃交換式 エンドミル MX C208		
	MT0920233																										
	MT1530133																										
	MT1530233																										
フェイスミル Face mill	SNGU1607EN-C		G級 G																						アルファデュアル フェースミル ASDF ASDH C210		
	SNMU1607EN-B		M級 M																								
	SNMU1607EN-C																										
	SDNW1505ZDTN-R15		N級 N																							アルファ高送り 正面フライス ASF C216	
	SDMT1505ZDTN-R15		M級 M																								
	SDMT1505ZDTN-C15		E級 E																								
	SDEW1505ZDTN-R15																										
	SEET13T3AGEN-S		E級 E																								アルファ正面 フライス AFE45 C220
	SEET13T3AGFN-S																										
	SEET13T3AGTN																										
SEMT13T3AGTN		M級 M																									
フェイスミル Face mill	SEC42FN-C9	SECN1203AFFN-C9	C級 C																						アルファ 45 A45E-4000 C222 FES45 -4000 FEM45 -4000		
	SEC42TN-C9	SECN1203AFTN-C9																									
	SEC42TN-G9A2	SECN1203AFTN-G9A2																									
	SEE42FN-C9	SEEN1203AFFN-C9		E級 E																							
	SEE42TN-C9	SEEN1203AFTN-C9																									
	SEE42TN-C9Y	SEEN1203AFTN-C9Y																									
	SEE42TN-G9	SEEN1203AFTN-G9																									
	SEE42TN-G9A2	SEEN1203AFTN-G9A2																									
	SEE42TN-G9C3	SEEN1203AFTN-G9C3																									
	SEE42TN-G9G	SEEN1203AFTN-G9G																									
	SEE42TN-G9Y	SEEN1203AFTN-G9Y																									
	SEE42TR-G3	SEEN1203EFTR-G3																									
	SEK42FN-C9	SEKN1203AFFN-C9		K級 K																							
	SEK42TN-C9	SEKN1203AFTN-C9																									
	SEK42TN-C9Y	SEKN1203AFTN-C9Y																									
	SEK42TR-G3	SEKN1203EFTR-G3																									
	SEKR42TN	SEKR1203AFTN																									
	SEKR42TNY	SEKR1203AFTNY																									
SEKR	SEE53TN-C9	SEEN1504AFTN-C9	E級 E																						アルファ 45 A45E-5000 C222 FEM45 -5000		
	SEE53TN-G9	SEEN1504AFTN-G9																									
	SEE53TN-G9Y	SEEN1504AFTN-G9Y																									
	SEE53FN-C9	SEEN1504AFFN-C9																									
	SEK53TN-C9	SEKN1504AFTN-C9		K級 K																							
	SEK53TN-C9Y	SEKN1504AFTN-C9Y																									
	SEK53FN-C9	SEKN1504AFFN-C9																									

フライス切削用インサート

刃先交換式工具
フライス切削用インサート

形状 Shape	商品コード Item code	ISO型番 ISO (metric)	精度 Tolerance Class	コーティング Coating										ノンコーティング Non Coating				適用カッタ Cutter 掲載頁 Page	
				AJコーティング AJ Coating		サーメットコーティング Cermet Coating	Cコーティング C Coating		GXコーティング GX Coating		Gコーティング G Coating		サーメット Cermet	超硬 Carbide					
				JP4120	JM4160	MZ1000		CY100H	CY25	CY250	GX2140		HC844		CH550	CH7030	EX35		WH10
フェースミル Face mill 	SDC42TN-G9C3	SDCN1203AETN-G9C3	C級																アルファ 45 A45D-4000 C224 フェースミル FP45-4000 CFP45
	SDE42FN-C9	SDEN1203AEFN-C9	E級					●											
	SDE42FN-G9	SDEN1203AEFN-G9						●											
	SDE42TN-C9	SDEN1203AETN-C9	E級											●					
	SDE42TN-C9A6	SDEN1203AETN-C9A6																	
	SDE42TN-C9Y	SDEN1203AETN-C9Y	E級			●									●	●			
	SDE42TN-G9	SDEN1203AETN-G9																	
	SDE42TN-G9C3	SDEN1203AETN-G9C3	E級																
	SDE42TN-G9Y	SDEN1203AETN-G9Y							●										
	SDK42FN-C9	SDKN1203AEFN-C9	K級						●									●	
	SDK42TN-B9	SDKN1203AETN-B39																	
	SDK42TN-C9	SDKN1203AETN-C9	K級							●	●	●		●			●	●	
	SDK42TN-C9Y	SDKN1203AETN-C9Y			●	●													
	SDK42TN-C9A2	SDKN1203AETN-C9A2	K級							●	●	●					●	●	
	SDK42TN-C9A6	SDKN1203AETN-C9A6																	
SDKR42TN	SDKR1203AETN	K級									●								
SDKR42TNY	SDKR1203AETNY			●	●														
その他の工具 Other tool	TPMT831	TPMT110204	M級											●		●	●	汎用 面取りカッタ CPC C228	
	TPP322	※TPGN160308	G級												●				
	TPMN321	※TPMN160304													●	●	●		
	TPMN322	※TPMN160308	G級							●			●		●	●	●		
	TPMN322Y	TPMN160308Y			●	●				●									
	TPMN321TN	TPMN160304TN	M級											●					
	TPMN322TN	TPMN160308TN												●		●			
	TPMN431	※TPMN220404	M級							●				●	●	●			
	TPMN432	※TPMN220408												●	●	●			
	TPMN432Y	TPMN220408Y	M級	●	●					●	●	●							
	TPMN433	※TPMN220412												●	●	●			
	TPMN431TN	TPMN220404TN	M級							●				●	●	●			
	TPMN432TN	TPMN220408TN												●	●	●			
	TPMN433TN	TPMN220412TN	M級											●					
	TPC32TR-E0	TPCN1603PPTR-E0		C級											●				
TPC32FR-E0	TPCN1603PPFR-E0	E級																	
TPE32TR-E0	TPEN1603PPTR-E0																		
TPK32TR-E0	TPKN1603PPTR-E0	K級												●	●				
TPK32FR-E0	TPKN1603PPFR-E0																●		
TPK32TR-G0	TPKN1603PPTR-G0	K級							●		●		●						
TPK32TR-G0Y	TPKN1603PPTR-G0Y			●	●														
TPC43TR-E0	TPCN2204PDTR-E0	C級																	
TPC43FR-E0	TPCN2204PDFR-E0	E級																	
TPE43TR-E0	TPEN2204PDTR-E0																		
TPE43TR-G0Y	TPEN2204PDTR-G0Y	E級								●									
TPK43TR-E0	TPKN2204PDTR-E0													●	●				
TPK43FR-E0	TPKN2204PDFR-E0	K級															●		
TPK43TR-G0	TPKN2204PDTR-G0									●	●	●		●					
TPK43TR-G0Y	TPKN2204PDTR-G0Y	K級	●	●															
TPK43FR-G0	TPKN2204PDFR-G0									●									

●印：標準在庫品です。 無印：弊社営業へお問合せください。 ※：旋削用はG20頁を参照ください。
 ●：Stocked items. No mark：Contact with our sales department. ※：For turning inserts, please refer p.G20

フライス切削用インサート材種選択基準

■ フライス切削用インサート材種選定の目安 Guide to Grades for Milling Inserts

JIS使用分類 JIS use classification (ISO)	コーティング Coating		超硬合金母材 Carbide alloy	サーメット 母材 Cermet	CBN	サーメット Cermets	超硬合金 Carbide
	仕上げ切削 Finishing	中切削 General					
P 鋼、普通鋼 Carbon steels Alloyed steels (SS, SCM, SCR) (SC, SNCM...) 工具鋼 高速度鋼 鋳鋼 ステンレス鋼 Tool steels, HSS Cast steels Stainless steels	01 仕上げ切削 Finishing		TH303, ATH80D, TH308, ATH08M, PCA08M, PN08M, PTH08M, ACS05E, TH315, PN215, PN15M, PCA12M, JP4105	MZ1000		CH550	
	10 仕上げ切削 Finishing		JP4115, JP4120, GX2120, CY9020			CH7030	
	20 中切削 General		PTH30E, JS4045, CY250, CY25, CY250V, HC844, GX2140, GF30, JS4030				EX35
	30 中切削 General						
40 重切削 Roughing			JS4060, JM4160, GX2160				
M 鋼、鋳鋼 Steels, Cast steels ステンレス鋼 Stainless steels (SUS304) マンガン鋼 鋳鉄、特殊鋳鋼 Mn steels, Cast irons Alloyed cast irons	01 仕上げ切削 Finishing		TH308, ATH08M, PN215, JP4105			CH550	
	10 仕上げ切削 Finishing		JP4120				
	20 中切削 General		PTH30E, JS4045, CY25, CY250, CY250V, GF30, HC844, PTH40H, AX2040, JS4060, GX2160, JM4160				EX35
	30 中切削 General						
40 重切削 Roughing							
K 鋳鉄、普通鋳鉄 Cast irons (FC250...) ダクタイル鋳鉄 Ductile cast irons (FCD450...)	01 仕上げ切削 Finishing		TH303, ATH80D, ATH08M, TH308, PTH08M, PN08M, PCA08M, ACS05E, ATH10E, TH315, PN215, PN15M, PCA12M, JP4105				WH10
	10 仕上げ切削 Finishing		CY100H, JP4120, CY9020, PTH13S, GX2120				
	20 中切削 General		JS4045, CY250, JS4030, PTH30E, JS4060, GX2160, GX2140				
	30 中切削 General						
N 非鉄金属 アルミニウム アルミ合金 銅合金 Non ferrous metals Aluminium Aluminium alloys Copper alloys	仕上げ切削 Finishing		PN08M, PN215, JP4120, PTH30E, SD5010, HD7010				WH10
	中切削 General						
S 超合金 チタン合金 Super alloys Titanium alloys	仕上げ切削 Finishing		ATH08M, JP4105, JP4120, JS1025, PTH30E, JM4160				
	中切削 General						
H 高硬度材 Hardened materials	仕上げ切削 Finishing		TH303, ATH80D, TH308, ATH08M, PTH08M, PN08M, PCA08M, ACS05E, PN215, PN15M, PCA12M, TH315, JP4105, JP4115, JP4120				
	中切削 General					BH200	

刃先交換式工具

フライス切削用インサート

フライス切削用コーティング材種

材種名 Grade name	コーティング名 Coating name 皮膜の種類 Coating type	母材硬度(HRA) Base material hardness (HRA) 母材抗折力(GPa) Base material bending strength (GPa)	用途 Application	特長 Features
JP4105	AJコーティング PVD	93.3 4.0	50HRC以上の高硬度材用 For hardened steel 50HRC or more	超微粒超硬合金とAJコーティングを採用。 50HRC以上の高硬度材の加工に優れる。 Uses ultra micro grain substrate and AJ Coating. Suitable for 50HRC or more high hardness material cutting.
JP4115	AJコーティング PVD	92.4 4.2	鋼一般用・焼入れ鋼用 General purpose for steel and hardened steel	超微粒超硬合金とAJコーティングを採用。 鋼一般～焼入れ鋼の加工に優れる。 Uses ultra micro grain substrate and AJ Coating. Suitable for cutting of common steels through hardened steels.
CY100H	Cコーティング PVD	92.0 2.6	鋳鉄用 For cast iron	TiAlNコーティングを採用し、鋳鉄切削に優れる。 Uses TiAlN coating; Excellent for cutting cast iron.
PTH13S	THコーティング PVD	91.3 2.8	鋳鉄用 For cast iron	ナノコンポジットコーティングを採用し、鋳鉄切削に優れる。 Uses nanocomposite coating; Excellent for cast iron.
CY9020	Cコーティング PVD	91.5 4.1	鋼一般用 General purpose for steel	TiAlNコーティングを採用し、中仕上げ切削に優れる。 Uses TiAlN coating; Suitable for semi-finishing
JP4120	AJコーティング PVD	91.0 4.0	35～50HRCの合金鋼・ 焼入れ鋼用 For hardened steel and alloy steel (35-50HRC)	微粒超硬合金とAJコーティングを採用。 鋼一般～焼入れ鋼の加工に優れる。 Uses micro grain substrate and AJ Coating. Suitable for cutting of common steels through hardened steels.
GX2120	GXコーティング CVD	91.0 4.0	鋳鉄材高速用 For high-speed cutting of cast iron	微粒超硬合金とGXコーティングを採用。 鋳鉄材の連続切削加工に優れる。 Uses micro grain substrate and GX Coating. Suitable for the continuous cutting of cast iron.
JS1025	JSコーティング PVD	91.0 4.0	チタン合金用 For titanium alloys	微粒超硬合金とチタン合金用JSコーティングを採用。 チタン合金の加工に優れる。 Uses micro grain substrate and JS Coating. Suitable for cutting of titanium alloy.
PTH30E	THコーティング PVD	90.5 3.8	鋼一般用・湿式用 For wet general purpose of steel	微粒超硬合金とナノコンポジットコーティングを採用。 湿式加工に優れる。 Uses micro grain substrate and nanocomposite coating. Suitable for wet cutting.
JS4045	JSコーティング PVD	90.6 2.7	鋼一般用 General purpose for steel	粗粒超硬合金とJSコーティングを採用。 鋼一般切削に優れる。 Uses coarse grain substrate and JS coating. Suitable for cutting of the common steels.
CY250	Cコーティング PVD	90.6 2.7	鋼一般用 General purpose for steel	粗粒超硬合金とTiAlNコーティングを採用。 汎用性に優れる。 Uses coarse grain substrate and TiAlN coating. Suitable for general purpose cutting.
CY25	PCコーティング PVD	90.6 2.7	鋼一般用 General purpose for steel	粗粒超硬合金とTiCNコーティングを採用。 汎用性に優れる。 Uses coarse grain substrate and TiCN coating. Suitable for general purpose cutting.
CY250V	PCコーティング PVD	90.6 2.7	鋼一般用 General purpose for steel	粗粒超硬合金とTiCNコーティングを採用。 汎用性に優れる。 Uses coarse grain substrate and TiCN coating. Suitable for general purpose cutting.
HC844	Gコーティング PVD	90.6 2.7	鋼一般用 General purpose for steel	粗粒超硬合金とTiNコーティングを採用。 汎用性に優れる。 Uses coarse grain substrate and TiN coating. Suitable for general purpose cutting.
GX2140	GXコーティング CVD	89.0 3.0	35HRC以下の鋼乾式高速用 Dry high speed cutting for Steel 35HRC or less	粗粒超硬合金とGXコーティングを採用。 軟鋼の乾式高速切削に優れる。 Uses coarse grain substrate and GX Coating. Suitable for dry high speed mild steel cutting.
AX2040	AXコーティング CVD	89.0 3.0	ステンレス鋼の乾式高速用 For dry high speed stainless steel cutting	粗粒超硬合金とAXコーティングを採用。 ステンレス鋼の乾式高速切削に優れる。 Uses coarse grain substrate and AX Coating. Suitable for dry high speed stainless steel cutting.
GX2160	GXコーティング CVD	89.0 3.0	ステンレス鋼の乾式高速用 For dry high speed stainless steel cutting	粗粒超硬合金とGXコーティングを採用。 ステンレス鋼の乾式高速切削に優れる。 Uses coarse grain substrate and GX Coating. Suitable for dry high speed stainless steel cutting.
GF30	GFコーティング CVD	89.0 3.0	鋼一般用・湿式用 For wet general purpose of steel	軟鋼の湿式切削に優れる。 Suitable for wet mild steel cutting.
JS4030	JSコーティング PVD	90.5 2.7	鋼一般用 General purpose for steel	粗粒超硬合金とJSコーティングを採用。 鋼一般切削に優れる。 Uses coarse grain substrate and JS coating. Suitable for cutting of the common steels.

各特性値は代表値を示しています。各材種のISO分類についてはC254をご確認下さい。
Each characteristic value represents a typical value. Please refer to C254 for ISO classification of each grades.

フライス切削用コーティング材種

材種名 Grade name	コーティング名 Coating name 皮膜の種類 Coating type	母材硬度 (HRA) Base material hardness (HRA) 母材抗折力 (GPa) Base material bending strength (GPa)	用途 Application	特長 Features
JS4060	JSコーティング PVD	89.0 3.0	不安定切削・湿式用 For wet unstable cutting	粗粒超硬合金とJSコーティングを採用。 軟鋼の不安定加工や湿式切削に優れる。 Uses coarse grain substrate and JS Coating. Suitable for unstable mild steel cutting and wet cutting
JM4160	AJコーティング PVD	89.0 3.8	ステンレス鋼一般用・湿式用 General purpose for wet stainless steel cutting	粗粒超硬合金とAJコーティングを採用。 ステンレス鋼の加工全般に優れる。 Uses coarse grain substrate and AJ Coating. Suitable for universal stainless cutting.
PTH40H	THコーティング PVD	89.0 3.8	ステンレス鋼一般用・湿式用 General purpose for wet stainless steel cutting	粗粒超硬合金とナノコンポジットコーティングを採用。 ステンレス鋼の加工に優れる。 Uses coarse grain substrate and nanocomposite coating. Suitable for stainless cutting.
ATH80D	ATHコーティング PVD	93.6 4.0	45~65HRCの 焼入れ鋼仕上げ用 Finishing for hardened steels (45-65HRC)	超微粒超硬合金とATHコーティングを採用。 耐摩耗性が高く、高硬度材の仕上げ加工に優れる。 Uses ultra micro grain substrate and ATH Coating. High wear resistance, Suitable for high hard material finishing.
TH303	TH3コーティング PVD	93.6 4.0	45~65HRCの 焼入れ鋼仕上げ用 Finishing for hardened steels (45-65HRC)	超微粒超硬合金とTH3コーティングを採用。 耐摩耗性が高く、高硬度材の仕上げ加工に優れる。 Uses ultra micro grain substrate and TH3 Coating. High wear resistance, Suitable for high hard material finishing.
TH308	TH3コーティング PVD	93.3 4.0	高硬度鋼の仕上げ用 Finishing for hardened steels	超微粒超硬合金とTH3コーティングを採用。 高硬度材仕上げ加工の汎用性に優れる。 Uses ultra micro grain substrate and TH3 Coating. Suitable for hardened steel general finishing.
ATH08M	ATHコーティング PVD	93.3 4.0	高硬度鋼の仕上げ用 Finishing for hardened steels	超微粒超硬合金とATHコーティングを採用。 耐摩耗性が高く、高硬度材の仕上げ加工に優れる。 Uses ultra micro grain substrate and ATH Coating. High wear resistance, Suitable for high hard material finishing.
PN08M	PNコーティング PVD	93.3 4.0	高硬度鋼の仕上げ用 Finishing for hardened steels	超微粒超硬合金とPNコーティングを採用。 鋼高速仕上げ加工に優れる。 Uses ultra micro grain substrate and PN Coating. Suitable for high speed steel finishing.
PTH08M	THコーティング PVD	93.3 4.0	高硬度鋼の仕上げ用 Finishing for hardened steels	超微粒超硬合金とナノコンポジットコーティングを採用。 鋼高速仕上げ加工に優れる。 Uses ultra micro grain substrate and nanocomposite coating. Suitable for high speed steel finishing.
PCA08M	Cコーティング PVD	93.3 4.0	鋼一般仕上げ用 Finishing for general steels	超微粒超硬合金とTiAlNコーティングを採用。 汎用性に優れる。 Uses ultra micro grain substrate and TiAlN coating. Suitable for general cutting.
ACS05E	ACSコーティング PVD	93.1 3.6	高硬度鋼の仕上げ用 Finishing for hardened steels	超微粒超硬合金とACSコーティングを採用。 鋼高速仕上げ加工に優れる。 Uses ultra micro grain substrate and ACS Coating. Suitable for high speed steel finishing.
ATH10E	ATHコーティング PVD	93.0 3.8	鋳鉄仕上げ用 Finishing for cast iron	微粒超硬合金とATHコーティングを採用。 鋳鉄の仕上げ加工に優れる。 Uses micro grain substrate and ATH Coating. Suitable for cast iron finishing.
TH315	TH3コーティング PVD	92.4 4.2	高硬度鋼の仕上げ用 Finishing for hardened steels	超微粒超硬合金とTH3コーティングを採用。 55HRCまでの高硬度材の仕上げ加工に優れる。 Uses ultra micro grain substrate and TH3 Coating. Excellent in finishing of high hardened materials up to 55HRC.
PN215	PN2コーティング PVD	92.4 4.2	鋼一般仕上げ用 Finishing for general steels	超微粒超硬合金とPN2コーティングを採用。 耐溶着性に優れ、鋼一般の仕上げ加工に優れる。 Uses ultra micro grain substrate and PN2 Coating. High adhesion resistance, Suitable for general steel finishing.
PN15M	PNコーティング PVD	92.4 4.2	鋼一般仕上げ用 Finishing for general steels	超微粒超硬合金とPNコーティングを採用。 鋼一般の仕上げ加工に優れる。 Uses ultra micro grain substrate and PN Coating. Suitable for general steel finishing.
PCA12M	Cコーティング PVD	92.4 4.2	鋼一般仕上げ用 Finishing for general steels	超微粒超硬合金とTiAlNコーティングを採用。 汎用性に優れる。 Uses ultra micro grain substrate and TiAlN coating. Suitable for general cutting.
MZ1000	THコーティング PVD	92.0 2.0	鋼の面削り用 For face milling of steel	サーメット母材とTHコーティングを採用。 仕上げ面に優れ、高速切削に優れる。 Uses cermet substrate and TH Coating. Suitable for finished surface and high speed cutting.
SD5010	SDコーティング PVD	92.0 2.6	アルミ合金及び非鉄金属用 For aluminum alloys and non ferrous metals	高硬度のDLCコーティングを採用。 アルミ合金等の非鉄金属加工に優れる。 Uses high hardness DLC Coating. Suitable for aluminum alloys etc. and non ferrous metals.
HD7010	HDコーティング CVD	91.3 2.8	グラファイト及び繊維強化プラスチック用 For graphites and fiber-reinforced plastics (FRP)	高硬度のダイヤモンドコーティングを採用。 耐摩耗性に優れ、グラファイト等の加工に優れる。 Uses high hardness diamond coating. Suitable for wear resistance and graphite cutting etc.

各特性値は代表値を示しています。各材種のISO分類についてはC254をご確認下さい。
Each characteristic value represents a typical value. Please refer to C254 for ISO classification of each grades.

モジュラーミル専用シャンク AVアーバ（防振アーバ） 刃先交換式工具用 部品

The Shanks for Modular Mill, AV Arbor (Damped Arbor)
Parts for Indexable Tools



モジュラーミル

Modular Mill

アルファモジュラーミルの特長	D2
Features of Modular Mill	
アルファモジュラーミル専用シャンク ASC,AS	D6
The Shanks of Modular Mill	
アルファモジュラーミル用アーバ BT30,BT40,HSK	D8
The Arbors for Modular Mill	

ボアタイプ用アーバ

Arbor for Bore type

BT50ボアタイプ用アーバ BT50	D11
BT50 Arbor for Bore type	

AVアーバ（防振アーバ）

AV Arbor (Damped Arbor)

AVユニット	DOO-AV	D12
Av Unit		
BT50本体アーバ	BT50	D13
BT50 Body Arbor		
HSK本体アーバ	HSK	D13
HSK Body Arbor		

刃先交換式工具用部品

Parts for Indexable Tools

サポータ	D16
Locater	
クサビ	D17
Wedge	
シート	D17
Seat	
ねじ	D18
Screw	
クランプ駒	D20
Clamp piece	
クランプ駒セット	D20
Clamp piece set	
スプリング	D20
Spring	
ドライバー・レンチ	D21
Driver, Wrench	
スパナ	D22
Spanner	
ねじ焼付き防止剤	D22
Screw anti-seizure agent	

アルファモジュラーミルの特長

■ カッタ(ヘッド)+シャンク、カッタ(ヘッド)+アーバの組合わせ Cutter(head) and shank, cutter(head) and arbor combinations

工程 process	工具 Tools				加工用途 Cutting Applications							
	カッタ Cutter	形状 Shape	外径DC,DCX Tool dia.	アイテム数 number of item								
粗加工 Roughing	TR4FM			φ32・φ40	2	平面 Planing	溝 Slotting	彫込み Die-sinking	曲面 Profiling	ヘリカル Helical	バーチカル Vertical	
	TD4N-M			φ16~φ42	10	平面 Planing	溝 Slotting	彫込み Die-sinking	曲面 Profiling	ヘリカル Helical		
	ASRM			φ20~φ40	6	平面 Planing	溝 Slotting	彫込み Die-sinking	曲面 Profiling	ヘリカル Helical		
	ASRTM			φ25~φ40	10	平面 Planing	溝 Slotting	彫込み Die-sinking	曲面 Profiling	ヘリカル Helical		
	ASRM (多刃タイプ) Multi-flutes Type			φ16~φ40	9	平面 Planing	溝 Slotting	彫込み Die-sinking	曲面 Profiling	ヘリカル Helical		
	ASRFM			φ20~φ40	7	平面 Planing	溝 Slotting	彫込み Die-sinking	曲面 Profiling	ヘリカル Helical		
半仕上げ Semi-Finishing	ARM			φ12~φ40	11	平面 Planing	溝 Slotting	彫込み Die-sinking	曲面 Profiling	ヘリカル Helical		
	RV-M			φ25~φ40	6	平面 Planing	溝 Slotting	彫込み Die-sinking	曲面 Profiling	ヘリカル Helical		
半仕上げ・仕上げ Roughing, Semi-Finishing, Finishing	GF1			φ16~φ25	7	側面 Side Cutting						
	GF2T			φ20~φ40	4	側面 Side Cutting						
	GF3L			φ20~φ30	3	曲面 Profiling						
	GP1LB			φ16~φ30	4	平面 Planing	側面 Side Cutting	曲面 Profiling				
	GP1T			φ12~φ30	5	曲面 Profiling						
	RH2P-M			φ8~φ32	7	平面 Planing	側面 Side Cutting	彫込み Die-sinking	ヘリカル Helical			
	AHUM			φ16~φ40	14	平面 Planing	側面 Side Cutting	溝 Slotting	彫込み Die-sinking	曲面 Profiling	ヘリカル Helical	
	ASMM			φ8~φ32	13	平面 Planing	側面 Side Cutting	溝 Slotting	彫込み Die-sinking	曲面 Profiling	ヘリカル Helical	
	ASPVM10			φ10~φ32	11	平面 Planing	側面 Side Cutting	溝 Slotting	彫込み Die-sinking	曲面 Profiling	ヘリカル Helical	バーチカル Vertical
	ASPVM20			φ16~φ40	18	平面 Planing	側面 Side Cutting	溝 Slotting	彫込み Die-sinking	曲面 Profiling	ヘリカル Helical	バーチカル Vertical
	ASPVM-Z			φ16~φ26	4	座ぐり Spot Facing						
粗加工 Roughing	AHJM			φ16~φ40	9	平面 Planing	側面 Side Cutting	溝 Slotting	彫込み Die-sinking	曲面 Profiling	ヘリカル Helical	穴あけ Drilling
仕上げ Finishing	ARPFM			φ10~φ32	14	平面 Planing	側面 Side Cutting	彫込み Die-sinking	曲面 Profiling	ヘリカル Helical		
半仕上げ Semi-Finishing	BR2PM			φ16~φ32 (R8~R16)	5	溝 Slotting	彫込み Die-sinking	曲面 Profiling	R Radius	ヘリカル Helical		
	BCFM			φ16~φ32 (R8~R16)	5	溝 Slotting	彫込み Die-sinking	曲面 Profiling	R Radius	ヘリカル Helical		
仕上げ Finishing	ABPFM			φ10~φ32 (R5~R16)	13	平面 Planing	側面 Side Cutting	彫込み Die-sinking	曲面 Profiling	R Radius	ヘリカル Helical	

部品・アーバ・シャンク
 取扱い説明書

掲載ページ Page
C10
C28
C34
C39
C55
C51
C72
C86
B4
B6
B8
B10
B12
C64
C147
C141
C185
C192
C206
C162
C92
C100
C113
C128

シャンク、アーバ Shank, Arbor	適用カッタ 外径 Cutter body Tool diameter	掲載ページ Page
超硬シャンク Carbide Shank 	φ8~φ40	D6
鋼シャンク Steel Shank 	φ10~φ40	D7
モジュラーミル用アーバ(BT30,BT40) Modular Mill Arbor (BT30,BT40)		φ8~φ40 D8
モジュラーミル用アーバ(HSK) Modular Mill Arbor (HSK)		φ20~φ40 D10
AVアーバ(防振アーバ)(D[○]-AV,BT50,HSK) AV Arbor (Damped Arbor) (D [○] -AV,BT50,HSK)		φ40 D12

Modular shank
AV Arbor, Parts

アルファモジュラーミルの特長

○ アルファモジュラーミル専用シャンク 取付対応表 Alpha Modular Mill Special Shank attachment compatibility table

工具径 Tool dia. DC DCX	接続 形状 Mounting shape 掲載頁 Page	アルファモジュラーミル Modular Mill											専用シャンク Special shanks					
		異形工具 Special shape tool					ラジラス Radius						シャンクの 干渉無し No interference at the shank ※	適用シャンク Shank ASC:超硬製 Carbide AS:鋼製 Steel ASC:P.D6, AS:P.D7	センタ スルー Center Through	シャンク径 Shank dia. DCONMS		
		GF1	GF2T	GF3L	GP1LB	GP1T	TR4F-M	TD4N-M	ASRM00	ASRTM	ASRFM	ASRM20					ARM	
φ8	M6														ASC(AS)10-6.5...	○ ^{*2}	φ10	
φ10														✓				
φ11														✓				
φ12	M6													●	ASC(AS)12-6.5...	○ ^{*2}	φ12	
φ16	M8	●			●	●		●					●	●		ASC(AS)16-8.5...	○	φ16
φ17															✓			
φ18														●	✓			
φ20	M10	●	●	●	●	●		●	●			●	●	●		ASC(AS)20-10.5...	○	φ20
φ21															✓			
φ22														●	✓			
φ25	M12	●	●	●	●	●		●	●	●		●	●	●		ASC(AS)25-12.5...	○	φ25
φ26															✓			
φ28														●	✓			
φ30	M16			●	●	●				●	●		●	●		ASC(AS)32-17...	○	φ32
φ32							●	●		●	●		●	●				
φ33															✓			
φ35			●												✓			
φ40			●					●	●	●	●	●	●	●	✓			
φ42								●						✓				

工具径 Tool dia. DC DCX	接続 形状 Mounting shape 掲載頁 Page	アルファモジュラーミル Modular Mill											専用シャンク Special shanks					
		ラジラス Radius			ショルダー Shoulder					ボール Ball			シャンクの 干渉無し No interference at the shank ※	適用シャンク Shank ASC:超硬製 Carbide AS:鋼製 Steel ASC:P.D6, AS:P.D7	センタ スルー Center Through	シャンク径 Shank dia. DCONMS		
		RV-M	RH2P-M	ARPFM	ASMM	AHUM	AHJM	ASPMV10	ASPMV20	ASPMV-Z	BR2P-M	BCFM					ABPFM	
φ8	M6		●			●										ASC(AS)10-6.5...	○ ^{*2}	φ10
φ10			●	●	●			●						●				
φ11															✓			
φ12	M6		●	●	●									●	ASC(AS)12-6.5...	○ ^{*2}	φ12	
φ13	M6														✓			
φ16	M8		●	●	●	●	●	●	●	○	●	●	●			ASC(AS)16-8.5...	○	φ16
φ17							●	●							✓			
φ18										●	○				✓			
φ20	M10		●	●	●	●	●	●	●	○	●	●	●			ASC(AS)20-10.5...	○	φ20
φ21							●	●							✓			
φ22										●					✓			
φ25	M12	●	●	●	●	●	●	●				●	●	●		ASC(AS)25-12.5...	○	φ25
φ26							●	●		○					✓			
φ28										●					✓			
φ30	M16			●	●	●	●	●	●			●	●	●		ASC(AS)32-17...	○	φ32
φ32		●	●	●	●	●	●	●	●			●	●	●				
φ33															✓			
φ35															✓			
φ40			●				●	●		●					✓			

●印：標準在庫品です。 ○印：メーカー在庫品です。
 ●： Stocked Items. ○： Manufacture stocked items.
 ※シャンクの干渉無し…「工具径DC,DCX>シャンク径 DCONMS」の組合せです。シャンク部が被削材と干渉するのを防ぎます。(次頁ポイント②参照)
 The combination whose tool diameter is bigger than a shank diameter does not have an interference of a shank and work piece. (Refer next page point ②)
 ※2 AS[○]はセンタースルーなしです。AS[○] is not center-through products.

○ 超硬シャンクの特長 Carbide shank features

ポイント Point

ロング、エキストラロングの突出し長さを要する加工に威力を発揮するシステムです。

This system demonstrates maximum benefits in long and extra long applications.



○ ヘッドと超硬シャンクの組合わせの特長 Head and carbide shank combinations and features

ポイント Point

刃径φ18、φ22、φ28、φ35のモジュラーヘッドは、シャンク部の干渉がありません。

Modular heads with diameters of Ø18, Ø22, Ø28 and Ø35 have no interference with shank section.

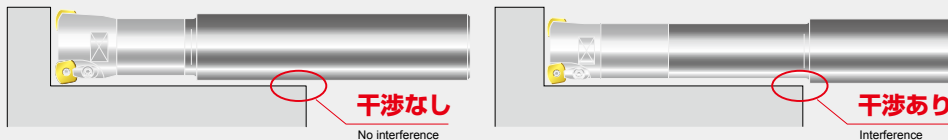

ポイント Point

ABPFM10をASC12-6.5の超硬シャンクへ取付けますと片角1.5°のテーパボールとして使用することができます。

Attaching ABPFM10 to ASC12-6.5 carbide shank enables use as a taper ball bit with a side angle of 1.5°.

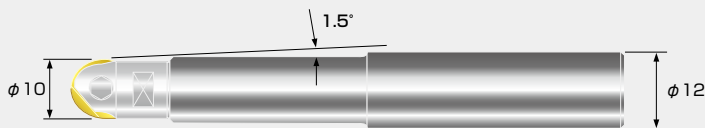

○ アーバ (BT, HSK) の特長 Arbor (BT, HSK) features

ポイント Point

ヘッド交換式工具用アーバ(BT, HSK)は、工具突出し長さを最短に出来るシステムですので、機械の剛性をフルに活用できます。

Maximum efficiency for BT, HSK spindle machines due to the reduction in the "actual" overhang in long and extra-long applications.

(例) 突出し長さの比較…最短の組合せ
Example : Overhang and Application Area

カッタ: AHUM1020R-3
Cutter
アーバ: BT30-10.5-20-18
Arbor

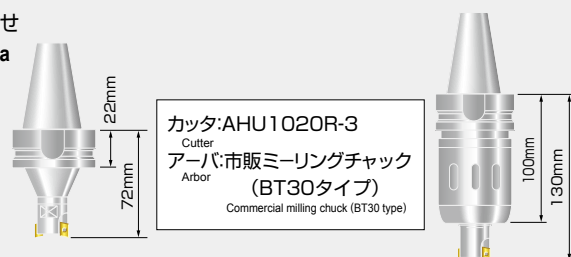

○ アルファモジュラーミルの締め付けトルクについて About tightening torque for modular mill

工具径 Tool Dia.	インロー径 Pilot diameter	取付ねじ Mounting screw	スパナ2面幅 Spanner 2-surface width	推奨締め付けトルク Recommended tightening torque
~φ12	φ6.5	M6	7mm	8.0N・m
φ16~φ18	φ8.5	M8	10mm	23N・m
φ20~φ22	φ10.5	M10	15mm	46N・m
φ25~φ28	φ12.5	M12	17mm	80N・m
φ30~	φ17	M16	22mm	90N・m

【注意】

- ①モジュラーミル及び専用シャンク、専用アーバの「工具端面」「インロー部」に傷や切りくずなどの付着物が無い事を確認してください。
- ②モジュラーミル及び専用シャンク、専用アーバの「工具端面」「モジュラーねじ部」にグリースなどの潤滑剤は塗布しないでください。(端面およびねじ部の摩擦係数が低くなると、回転トルクが大きな軸力(ねじを引っ張る力)を発生させ、ねじが破断する可能性があります。)
- ③締め付け後に、モジュラーミルと専用シャンク又は専用アーバの端面に隙間がないことを確認してください。

【Note】

1. Be sure to check that there are no scratches or adhered cutting chips on the modular mill or special shank, or on the tool end face or pilot area of the special arbor.
2. Do not apply lubricants such as grease, etc. to the modular mill or special shank, or on the tool end face or modular screw area of the special arbor. (If the friction coefficient of the end face or screw area is reduced, the rotational torque will generate a large axial force (force pulling on screw), which may cause the screw to fracture.)
3. After tightening, check that there is no gap between the modular mill and special shank or special arbor.

アルファモジュラーミル専用シャンク

超硬シャンク

Carbide Shank

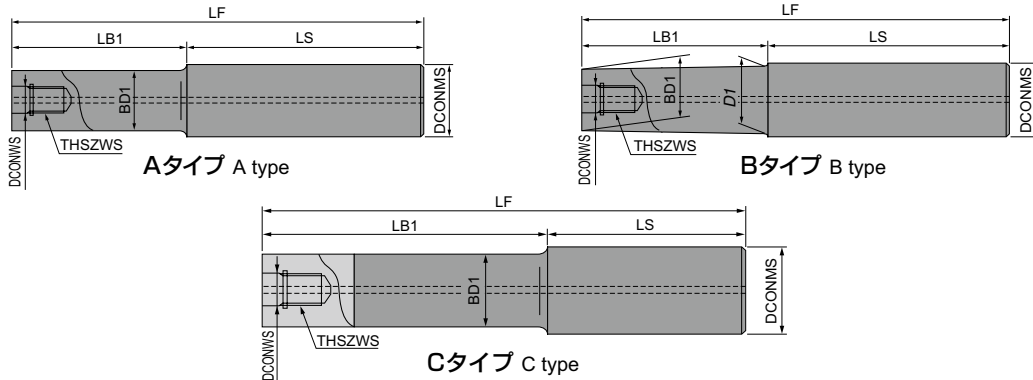

商品コード Item Code	在庫 Stock	寸法 Size(mm)								形状 Shape	適用カッタ Cutter body	エアーク 有無 With/without air hole	希望小売 価格(円) Suggested retail price (¥)
		DCONWS	THSZWS	LF	LB1	LS	BD1	DCONMS	D1				
ASC10-6.5-74-24Z	●	6.5	M6	74	24	50	9.3	10	-	A	φ8 ^{*1}	○	25,810
ASC10-6.5-84-34Z	●			84	34	50				φ10	○	27,930	
ASC10-6.5-114-49Z	●			114	49	65				φ11 ^{*2}	○	30,270	
ASC10-6.5-114-24Z	●			24	90	φ12 ^{*2}				○	30,270		
ASC12-6.5-74-24Z	●	6.5	M6	74	24	50	11	12	11.5	B	φ8 ^{*1}	○	36,020
ASC12-6.5-94-44Z	●			94	44	50				φ10 ^{*1}	○	37,430	
ASC12-6.5-129-64Z	●			129	64	65				φ11 ^{*1}	○	39,540	
ASC12-6.5-129-24Z	●			24	105	φ12				○	39,540		
ASC16-8.5-95-30Z	●	8.5	M8	95	30	65	14.5	16	15.5	B	φ16	○	48,100
ASC16-8.5-120-55Z	●			120	55	65					φ17 ^{*2}		52,560
ASC16-8.5-140-75Z	●			140	75	65					φ18 ^{*2}		55,960
ASC16-8.5-160-95Z	●			160	95	65					AHUM 1020R-2-M8 ^{*2}		58,900
ASC16-8.5-160-30Z	●			160	30	130					58,900		
ASC20-10.5-120-50Z	●	10.5	M10	120	50	70	18.5	20	19.5	B	φ20	○	56,780
ASC20-10.5-170-90Z	●			170	90	80					φ22 ^{*2}		63,590
ASC20-10.5-220-120Z	●			220	120	100					AHUM 1025R-2-M10 ^{*2}		69,920
ASC20-10.5-270-150Z	●			270	150	120					88,690		
ASC20-10.5-220-50Z	●	10.5	M10	220	50	170	18.5	20	19.5	B	GF1G 2025M-4-M10 ^{*2}	○	69,920
ASC20-10.5-270-50Z	●			270	220	88,690							
ASC25-12.5-145-65	●	12.5	M12	145	65	80	23	25	-	C	φ25	○	64,990
ASC25-12.5-215-115	●			215	115	100					φ28 ^{*2}		76,130
ASC25-12.5-265-145	●			265	145	120					AHUM 1030R-2-M12 ^{*2}		88,690
ASC25-12.5-315-195	●			315	195	120					114,370		
ASC25-12.5-265-65	●	12.5	M12	265	65	200	23	25	-	C	AHUM 1530R-2-M12 ^{*2}	○	88,690
ASC25-12.5-315-65	●			315	250	114,370							
ASC32-17-160-80	●	17	M16	160	80	80	28	32	-	C	φ30	○	98,540
ASC32-17-210-110	●			210	110	100					φ32		99,710
ASC32-17-260-140	●			260	140	120					φ35 ^{*2}		118,480
ASC32-17-310-190	●			310	190	120					φ40 ^{*2}		160,710
ASC32-17-360-240	●			360	240	120					202,930		
ASC32-17-260-80	●	17	M16	260	80	180	28	32	-	C	φ30	○	118,480
ASC32-17-310-80	●			310	230	160,710							
ASC32-17-360-80	●			360	280	202,930							

【注意】

- ①市販のミーリングチャック、焼ばめホルダーにて使用できます。
- ②※2018年2月20日から商品コードの末尾に「Z」が追加されました。
- ③※1 カッタ径がシャンク首下径(BD1、D1)より小さいため干渉が生じます。
- ④※2 カッタ径がシャンク径(DCONMS)より大きいためシャンクの干渉がありません。
- ⑤<φ40>寸法は、突出し長さ200mm以下を目安にご使用下さい。

【Note】

- ①Commercial milling chucks or shrink-fit holders can be used.
- ②For ※ from 20th Feb. 2018 "Z" is added to the end of item code.
- ③For ※1, since the cutter diameter is smaller than the shank neck diameter (BD1, D1), interference occurs at the shank.
- ④For ※2, since the cutter diameter is larger than the shank diameter (DCONMS), there is no interference at the shank.
- ⑤For the φ40 size, it is recommended that the protrusion length be 200mm or less.

●印：標準在庫品です。●：Stocked Items.

モジュラーミル専用シャンク

モジュラーミル専用シャンク・アーバ

鋼シャンク

Steel Shank

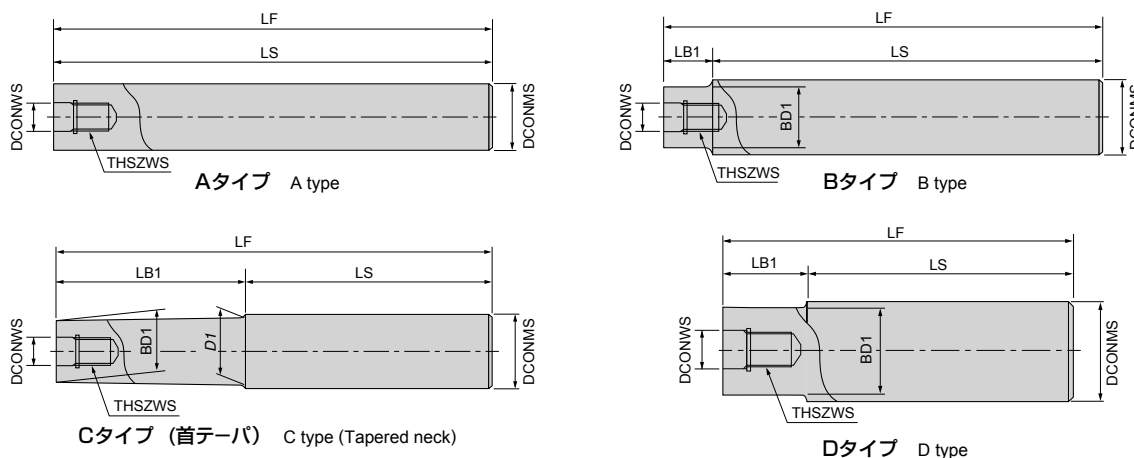

商品コード Item code	在庫 Stock	寸法 Size(mm)								形状 Shape	適用カッタ Cutter body	エア穴 有無 With/ without air hole	希望小売 価格(円) Suggested retail price (¥)
		DCONWS	THSZWS	LF	LB1	LS	BD1	DCONMS	D1				
AS10-6.5-74-0	●	6.5	M6	74	-	74	-	10	-	A	φ10 ^{※3}	-	20,890
AS12-6.5-84-4	●	6.5	M6	84	4	80	11	12	-	B	φ11 ^{※3} , φ12 ^{※3}	-	24,290
AS16-8.5-95-15	●	8.5	M8	95	15	80	14.5	16	15.5	C	φ16 ^{※3} φ18	○	28,160
AS20-10.5-100-20	●	10.5	M10	100	20	80	18	20	-	D	φ20 ^{※3} φ22	○	31,680
AS25-12.5-115-35	●	12.5	M12	115	35	80	23	25	-	D	φ25 ^{※3} φ28	○	35,440
AS32-17-110-30	●	17	M16	110	30	80	28	32	-	D	φ30 ^{※3} φ32 ^{※3} φ35 φ40	○	42,470

【注意】 ①市販のミーリングチャックにて使用できます。
②※3ではカッタ径がシャンク径より小さいため、シャンク首部の干渉が生じます。

【Note】 ① Commercial milling chucks can be used.
② For ※3, since the cutter diameter is smaller than the shank diameter, interference occurs at the shank.

鋼シャンク

Steel Shank

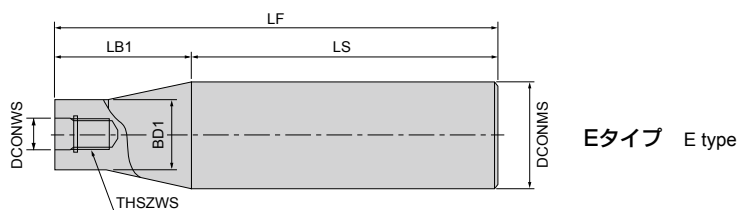

※首部及び全長は、ユーザ様にて追加加工可能です。
For neck section or total length, additional machining to user specifications is possible.

商品コード Item code	在庫 Stock	寸法 Size(mm)							適用カッタ Cutter body	エア穴 有無 With/ without air hole	希望小売 価格(円) Suggested retail price (¥)
		DCONWS	THSZWS	LF	LB1	LS	BD1	DCONMS			
AS42-17-360-90	●	17	M16	360	90	270	28	42	φ30 φ32 φ35 φ40	○	80,940

【注意】 市販のミーリングチャックにて使用できます。
【Note】 Commercial milling chucks can be used.

アルファモジュラーミル専用アーバ

BT30

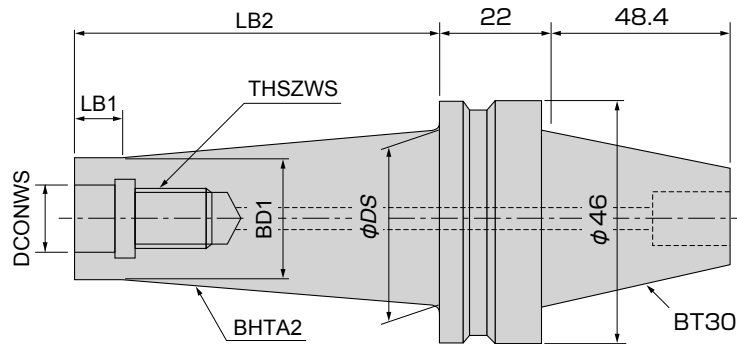

※首部は、ユーザ様にて追加加工可能です。For neck section, additional machining to user specifications is possible.

商品コード Item code	在庫 Stock	寸法 Size(mm)							エアーク 有無 With/ without air hole
		DCONWS	THSZWS	BD1	φDS	LB2	LB1	BHTA2	
BT30-6.5-30-9.7		6.5	M6	9.7	25	30	5	17°	-
BT30-6.5-55-9.7	55					10	9.6°		
BT30-6.5-80-9.7	80					10	6.2°		
BT30-8.5-25-15		8.5	M8	15	30	25	5	20.6°	○
BT30-8.5-50-15	50					10	10.6°		
BT30-8.5-75-15	75					10	6.6°		
BT30-10.5-20-18		10.5	M10	18	35	20	5	29.5°	○
BT30-10.5-45-18	45					10	13.7°		
BT30-10.5-70-18	70					10	8.1°		
BT30-12.5-15-21		12.5	M12	21	40	15	5	32.3°	○
BT30-12.5-40-21	40					10	17.6°		
BT30-12.5-65-21	65					10	9.8°		
BT30-12.5-85-21	85					10	7.2°		
BT30-17-10-28		17	M16	28	40	10	5	31°	○
BT30-17-35-28	35					10	13.5°		
BT30-17-60-28	60					10	6.8°		

【注意】

モジュラーミル用BT30アーバご使用の際は、標準切削条件表を目安に加工条件を決定して下さい。
加工状況により振動が懸念される場合は、1.切り込み深さ(a_p)を低減する 2.一刃当りの送り(f_z)を低減する方法で調整下さい。

【Note】

When using the BT30 arbor for modular mills, determine the cutting conditions using the standard cutting conditions table as a general guide.
If vibrations are a concern due to the cutting conditions, adjust conditions by 1.reducing cutting depth (a_p) or 2.reducing per-flute feed rate (f_z).

BT40

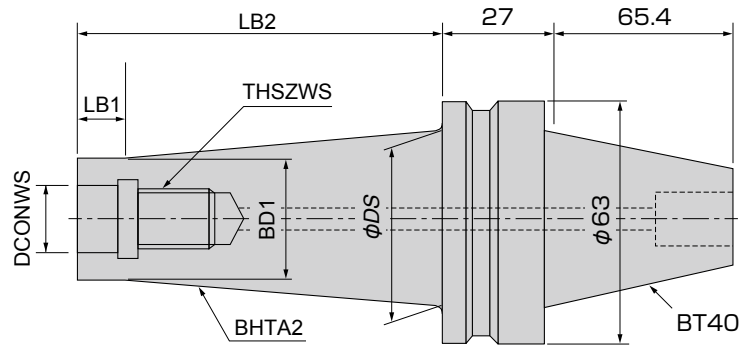

※首部分は、ユーザ様にて追加加工可能です。 For neck section, additional machining to user specifications is possible.

商品コード Item code	在庫 Stock	寸法 Size(mm)							エア一穴 有無 With/ without air hole
		DCONWS	THSZWS	BD1	ϕDS	LB2	LB1	BHTA2	
BT40-6.5-30-9.7		6.5	M6	9.7	25	30	5	17°	-
BT40-6.5-55-9.7	55					10	9.6°		
BT40-6.5-80-9.7	80					10	6.2°		
BT40-6.5-130-9.7	130					10	3.6°		
BT40-8.5-25-15		8.5	M8	15	30	25	5	20.6°	○
BT40-8.5-50-15	50					10	10.6°		
BT40-8.5-75-15	75					10	6.6°		
BT40-8.5-125-15	125					10	3.7°		
BT40-10.5-20-18		10.5	M10	18	35	20	5	29.5°	○
BT40-10.5-45-18	45					10	13.7°		
BT40-10.5-70-18	70					10	8.1°		
BT40-10.5-120-18	120					10	4.4°		
BT40-12.5-15-21		12.5	M12	21	40	15	5	32.3°	○
BT40-12.5-40-21	40					10	17.6°		
BT40-12.5-65-21	65					10	9.8°		
BT40-12.5-115-21	115					10	5.2°		
BT40-17-10-28		17	M16	28	48	10	5	45°	○
BT40-17-35-28	35					10	21.8°		
BT40-17-60-28	60					10	11.3°		
BT40-17-110-28	110					10	5.7°		

【注意】

加工状況により振動が懸念される場合は、1.切り込み深さ(a_p)を低減する 2.一刃当りの送り(f_z)を低減する方法で調整下さい。

【Note】

If vibrations are a concern due to the cutting conditions, adjust conditions by 1.reducing cutting depth (a_p) or 2.reducing per-flute feed rate (f_z).

アルファモジュラーミル専用アーバ

HSK

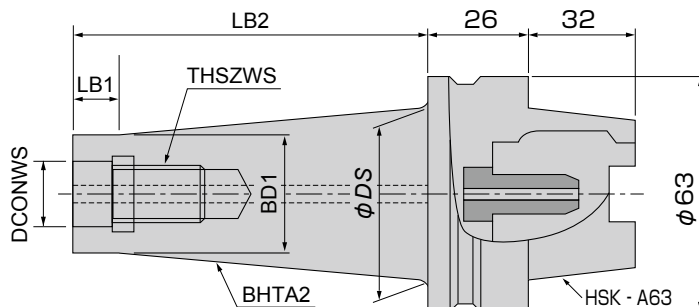

商品コード Item code	在庫 Stock	寸法 Size (mm)							エアーク 有無 With/ without air hole	希望小売 価格(円) Suggested retail price (¥)
		DCONWS	THSZWS	BD1	φDS	LB2	LB1	BHTA2		
HSK-A63-10.5-30-18	●	10.5	M10	18	20.8	30	-	3°	○	94,560
HSK-A63-10.5-70-18	●				25	70	10	3°		97,130
HSK-A63-10.5-70-18S					48	70	10	12°		-
HSK-A63-10.5-120-18	●				30.2	120	10	3°		101,350
HSK-A63-12.5-35-21	●	12.5	M12	21	24.3	35	-	3°		95,490
HSK-A63-12.5-65-21	●				27.5	65	10	3°		96,660
HSK-A63-12.5-65-21S					48	65	10	12°		-
HSK-A63-12.5-115-21	●				32.7	115	10	3°		101,710
HSK-A63-17-40-28	●	17	M16	28	31.8	40	-	3°		95,490
HSK-A63-17-60-28	●				33.9	60	10	3°		96,660
HSK-A63-17-60-28S					48	60	10	9.5°		-
HSK-A63-17-110-28	●				39.2	110	10	3°		101,120

[注意]クーラントパイプは付属しております。

[Note] Coolant Pipe is attached.

●印：標準在庫品です。 ●：Stocked Items. 無印：弊社営業へお問合せください。 No mark：Contact with our sales department.

モジュラーミル専用シャंक・アーバ

ボアタイプ用アーバ

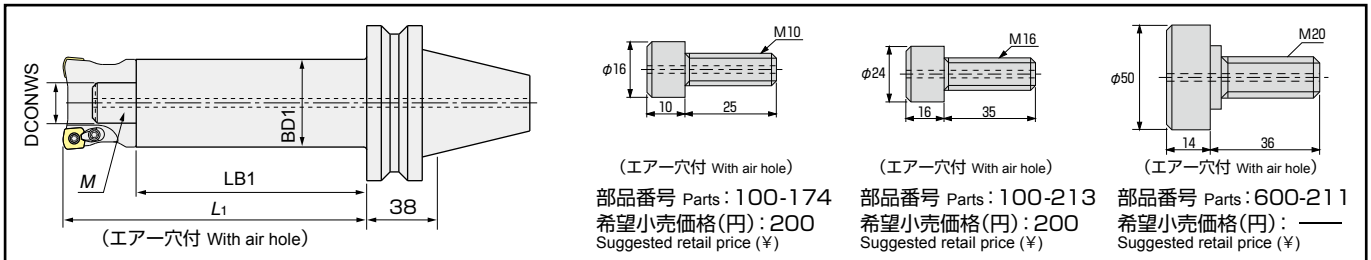

(エア-穴付 With air hole)

部品番号 Parts : 100-174
希望小売価格(円) : 200
Suggested retail price (¥)

(エア-穴付 With air hole)

部品番号 Parts : 100-213
希望小売価格(円) : 200
Suggested retail price (¥)

(エア-穴付 With air hole)

部品番号 Parts : 600-211
希望小売価格(円) : —
Suggested retail price (¥)

商品コード Item code	在庫 Stock	寸法 Size (mm)					重量(kgf) Weight	アーバ用ねじ Arbor screw	希望小売価格(円) Suggested retail price (¥)
		DCONWS	M	L ₁	LB1	BD1			
BT50-22.225- 50-50	●	22.225	M10	100	50	47	4.3	100-174	54,200
BT50-22.225-100-50	●			150	100		5.0		64,290
BT50-22.225-150-50	●			200	150		5.7		66,280
BT50-22.225-200-50	●			250	200		6.4		77,080
BT50-22.225-250-50	●			300	250		7.1		87,750
BT50-22.225- 50-63	●	22.225	M10	100	50	60	4.8	100-174	54,200
BT50-22.225-100-63	●			150	100		5.9		64,290
BT50-22.225-150-63	●			200	150		7.0		66,280
BT50-22.225-200-63	●			250	200		8.1		77,080
BT50-22.225-250-63	●			300	250		9.3		87,750
BT50-22.225-350-63	●			400	350		11.5		110,620
BT50-31.75- 7-80	●	31.75	M16	77	7	76	4.2	100-213 [※]	51,620
BT50-31.75- 80-80	●			150	80		6.8		56,780
BT50-31.75-130-80	●			200	130		8.5		67,110
BT50-31.75-180-80	●			250	180		10.2		68,750
BT50-31.75-260-80	●			330	260		12.9		83,870
BT50-31.75-330-80	●			400	330		15.4		109,450
BT50-31.75- 7-100	●	31.75	M16	77	7	96	4.2	100-213 [※]	51,620
BT50-31.75- 80-100	●			150	80		8.3		56,780
BT50-31.75-130-100	●			200	130		11.1		—
BT50-31.75-180-100	●			250	180		13.9		74,960
BT50-31.75-260-100	●			330	260		18.4		91,860
BT50-31.75-330-100	●			400	330		22.4		110,620
BT50-38.1-180-125	●	38.1	M20	250	180	98	14.8	600-211	74,960
BT50-38.1-260-125	●			330	260		19.7		91,860
BT50-38.1-330-125	●			400	330		24.0		110,620

●印：標準在庫品です。●： Stocked Items. 無印：弊社営業へお問合せください。No mark : Contact with our sales department.

【注意】 カッタ取付のアーバ用ねじは、アーバに付属しておりますが、カッタ本体には付属していません。

[Note] The arbor screw for attaching the cutter is included with the arbor, but is not included with the cutter itself.

※当社一部製品(AHU, AFE45, A45E, A45D, SE90 (ボア), SP)の取付けには、市販のフェースミル用締め付けボルトが必要となります。

A commercial face mill clamping bolt is required to mount some of our products (AHU, AFE45, A45E, A45D, SE90 [bore type], SP).

AVアーバ (防振アーバ)

AVユニット AV Unit

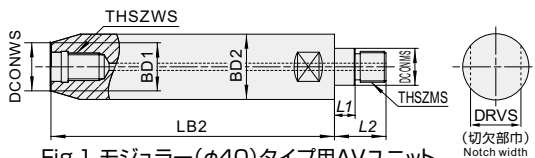

Fig.1 モジュラー(φ40)タイプ用AVユニット
AV Unit for Modular (φ40) type

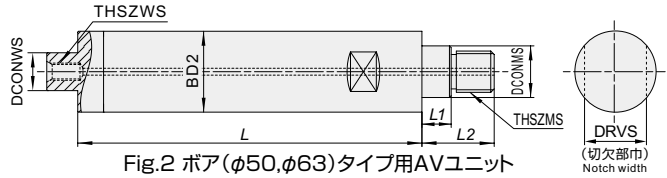

Fig.2 ボア(φ50,φ63)タイプ用AVユニット
AV Unit for Bore (φ50, φ63) type

商品コード Item code	在庫 Stock	寸法 Size(mm)											形状 Shape	適用アーバ Arbor body	重量 (kg) Weight
		工具径 Tool dia.	DCONWS	THSZWS	THSZMS	LB2	L	L1	L2	BD2	DCONMS	BD1			
D40-17-165-AV	□	40	17	M16	M18	165	12	30	38	21.5	28	35	Fig.1	BT50-95-38 HSK-A100-95-38	1.6
D50-22.225-200-AV	□	50	22.225	M10	M24	200	17	42	47	30	-	41	Fig.2	BT50-100-47 BT50-150-47 BT50-200-47 HSK-A100-150-47	3.4
D63-22.225-200-AV	□	63	22.225	M10	M27	200	23	46	60	40	-	55	Fig.2	BT50-100-60 BT50-150-60 BT50-240-60 HSK-A100-150-60	5.1
D50-22-200-AV	□	50	22	M10	M24	200	17	42	47	30	-	41	Fig.2	BT50-100-47 BT50-150-47 BT50-200-47 HSK-A100-150-47	3.4
D63-22-200-AV	□	63	22	M10	M27	200	23	46	60	40	-	55	Fig.2	BT50-100-60 BT50-150-60 BT50-240-60 HSK-A100-150-60	5.1

※AVユニットは分解しないでください。防振効果が失われます。 ※Do not disassemble the AV unit. Damping ability may be lost.
 ※長時間使用しない場合は立てて保管してください。 ※When it will not be used for a long period of time, please store it in an upright position.

● 適用カッタについて Applicable cutter body

AVユニットとご使用工具の取り付け部寸法をご確認の上、ご使用をお願い致します。 Please check the mounting part dimensions of the AV unit and the tool before using.

- 一部の製品ではAVユニットの適用工具径と異なる場合がありますが、取り付け部寸法が適合すれば、取り付けは可能です。
- ご使用の工具によってはボス径(取り付け部の径)が異なる場合があります。
- ご使用するAVユニットおよびアーバのシャンク径(BD2)よりも小さくなる工具径をご使用の場合シャンク部の干渉にご注意の上、ご使用をお願い致します。

商品コード Item code	適用カッタの例 Example of cutter body	
D40-17-165-AV	ASRM0040-4 ASRTM3040R- ASRM2040R-6 ASRFM3040R5-M16	ARM3040R-4 AHUM1040R-6 AHJM40RS
D50-22.225-200-AV	ARB4050R- ASR4050- ASRT4050R- ASRF4050R-	ASR3050R-5 ASR2052R-7* AHUB1550R-5 ASRFB3050R-7
D63-22.225-200-AV	ARB4063R- ARB5063R-3 AR5047R* ASR5060- ASR5063-	ASRT5063R-4 ASRF4063R- ASRFB3063R-8 ASR3063R-6 ASR2066R-8* AHUB1563R-6*

- *1 ASR2052R-7, ASR5060-, ASR2066R-8 は各AVユニットの適用工具径と異なりますが取り付け可能です。
- *2 AHUB1563R-6とAR5047Rはボス径(取り付け部の径)がφ47になっておりφ63AVユニットの筒径より小さくなっています。これによりボア取り付け部の径に差が生じますが、高い防振効果を得るためにはφ63AVユニットでの使用を推奨いたします。
- *3 D50-22-200-AV及びD63-22-200-AVはカッタ内径ミリサイズ品用です。
- *1 ASR2052R-7, ASR5060-, and ASR2066R-8 have different diameters than the applicable tool diameter for each AV unit, but tools can still be mounted.
- *2 The boss diameters (mounting area diameter) of AHUB1563R-6 and AR5047R are φ47, which is smaller than the tube diameter of the φ63AV unit. Although this will result in a diameter difference with the bore mounting area, it is recommended that the φ63AV unit be used to obtain high damping effect.
- *3 D50-22-200-AV and D63-22-200-AV are for metric bore bodies.

別売 部品番号 Parts

部品名 Parts	アーバ用ねじ Arbor screw		スパナ Spanner
形状 Shape			
適用ユニット Unit body	(エア-穴付き With air hole)	(エア-穴付き With air hole)	
D40-17-165-AV	-	-	SN-35
D50-22.225-200-AV D50-22-200-AV	100-174	100-178	SN-41
D63-22.225-200-AV D63-22-200-AV			SN-55

BT50アーバ BT50 Arbor

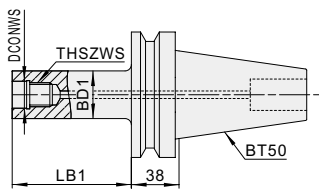

Fig.3 モジュラー(φ40)タイプ用アーバ
Arbor for Modular(φ40) type

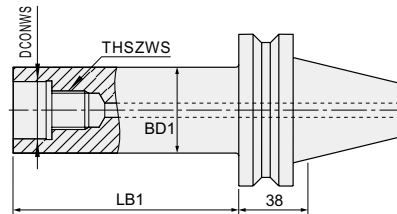

Fig.4 ボア(φ50,φ63)タイプ用アーバ
Arbor for Bore(φ50,φ63) type

商品コード Item code	在庫 Stock	寸法 Size(mm)				形状 Shape	適用AVユニット AV Unit body	重量 (kg) Weight
		DCONWS	THSZWS	LB1	BD1			
BT50-95-38	<input type="checkbox"/>	21.5	M18	95	38	Fig.3	D40-17-165-AV	4.6
BT50-100-47	<input type="checkbox"/>	30	M24	100	47	Fig.4	D50-22.225-200-AV D50-22-200-AV	4.8
BT50-150-47	<input type="checkbox"/>			150				5.5
BT50-200-47	<input type="checkbox"/>			200				6.1
BT50-100-60	<input type="checkbox"/>	40	M27	100	60	Fig.4	D63-22.225-200-AV D63-22-200-AV	5.5
BT50-150-60	<input type="checkbox"/>			150				6.6
BT50-240-60	<input type="checkbox"/>			240				8.5

HSKアーバ HSK Arbor

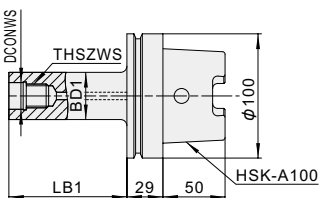

Fig.5 モジュラー(φ40)タイプ用アーバ
Arbor for Modular(φ40) type

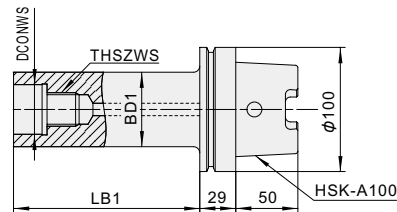

Fig.6 ボア(φ50,φ63)タイプ用アーバ
Arbor for Bore(φ50,φ63) type

商品コード Item code	在庫 Stock	寸法 Size(mm)				形状 Shape	適用AVユニット AV Unit body	重量 (kg) Weight
		DCONWS	THSZWS	LB1	BD1			
HSK-A100-95-38	<input type="checkbox"/>	21.5	M18	95	38	Fig.5	D40-17-165-AV	3.2
HSK-A100-150-47	<input type="checkbox"/>	30	M24	150	47	Fig.6	D50-22.225-200-AV D50-22-200-AV	4.2
HSK-A100-150-60	<input type="checkbox"/>	40	M27	150	60	Fig.6	D63-22.225-200-AV D63-22-200-AV	5.3

印：特定代理店在庫です。弊社営業へお問合せください。 : Stocked by specified distributor. Contact with our sales office.

AVアーバ (防振アーバ)

標準切削条件表 Recommended cutting conditions

※必ずエアブローまたはクーラントを使用して切削してください。(発熱による内部部品の劣化防止のため)
 詳細はAVアーバに添付の取り扱い説明書を確認してください。

※Be sure to use an air blower or coolant when cutting. (to prevent deterioration of internal parts due to generated heat)
 Please check the attached instruction manual for AV Arbor.

被削材 Work material	工具径D(適用AVユニット) Tool dia. (Applicable AV unit)	φ40 (D40-17-165-AV)		φ50 (D50-22.225-200-AV) D50-22-200-AV		
	適用カッタ例 Example of cutter body	ラジラスエンドミルシリーズ 高送りラジラスミルシリーズ Round insert cutter High Feed cutter [AR, ASR] [ASRT] [ASRF 等]	スクエアエンドミルシリーズ Right angle shoulder cutter [AHJ] [AHU 等]	ラジラスエンドミルシリーズ 高送りラジラスミルシリーズ Round insert cutter High Feed cutter [AR, ASR] [ASRT, ASRF 等]		
	突出し量 Overhang(mm)	300(7.5D)	300(7.5D)	350(7D)	400(8D)	450(9D)
一般構造用鋼 Mild steels (200HB以下)	切削速度 V_c (m/min)	80~120	70~100	80~120	80~120	80~120
	一刃当りの送り f_z (mm/t)	0.8~1.2	0.06~0.12	0.8~1.2	0.8~1.2	0.8~1.2
	軸方向の切込み量 a_p (mm)	0.2	1.5	0.5	0.3	0.2
炭素鋼・合金鋼 Carbon steels Alloy steels (30HRC以下)	切削速度 V_c (m/min)	80~120	70~100	80~120	80~120	80~120
	一刃当りの送り f_z (mm/t)	0.8~1.2	0.06~0.12	0.8~1.2	0.8~1.2	0.8~1.2
	軸方向の切込み量 a_p (mm)	0.2	1.5	0.5	0.3	0.2
炭素鋼・合金鋼 Carbon steels Alloy steels (30~40HRC以下)	切削速度 V_c (m/min)	70~100	50~80	70~100	70~100	70~100
	一刃当りの送り f_z (mm/t)	0.6~1.0	0.05~0.1	0.6~1.0	0.6~1.0	0.6~1.0
	軸方向の切込み量 a_p (mm)	0.2	1.5	0.5	0.3	0.2
ステンレス鋼 Stainless steels SUS	切削速度 V_c (m/min)	80~120	70~100	80~120	80~120	80~120
	一刃当りの送り f_z (mm/t)	0.6~1.0	0.05~0.1	0.6~1.0	0.6~1.0	0.6~1.0
	軸方向の切込み量 a_p (mm)	0.2	1.5	0.5	0.3	0.2
鋳鉄 Cast irons FC, FCD	切削速度 V_c (m/min)	80~120	70~100	80~120	80~120	80~120
	一刃当りの送り f_z (mm/t)	0.8~1.5	0.06~0.12	0.8~1.5	0.8~1.5	0.8~1.5
	軸方向の切込み量 a_p (mm)	0.2	1.5	0.5	0.3	0.2

- 【注意】** ①この切削条件表は切削条件の目安を示すものです。実際の加工では加工形状、目的、使用機械等により条件を調整してください。
 ②各工具の推奨材種は、工具毎の条件表に記載している材種を参考にしてください。
 ③本商品は必ず正回転(M03)で使用してください。逆回転(M04)で使用した場合、破損して危険です。
 ④丸駒カッタ(AR)は平面加工での使用を推奨いたします。掘り込み加工は高送り加工用カッタ(ASR, ASRT, ASRF)を使用してください。
 ⑤丸駒カッタと高送り加工用カッタの軸方向の切り込み量 a_p の推奨条件は径方向の切り込み量 a_e が工具径の80%の状態にて算出しております。

- 【Note】** ①These conditions are for general guidance, in actual machining conditions adjust the parameters according to your actual machine and work-piece conditions.
 ②The grade shown in each tool's conditions table should be used as a reference for the recommended grades for each tool.
 ③Be sure to use this tool with forward rotation (M03). There is a risk of breakage if it is used with reverse rotation (M04).
 ④Round insert cutters (AR shape) are recommended for face milling.
 For die-sinking, use cutters for high-feed machining (ASR shape, ASRT shape, ASRF shape).
 ⑤The recommended condition for depth of cut a_p for round insert cutters and high-feed machining cutters is calculated with the width of cut a_e being 80% of the tool diameter.

AVアーバ 防振アーバ

※必ず正回転(M03)で使用してください。逆回転(M04)で使用した場合、破損して危険です。

※Be sure to use this tool with forward rotation (M03). There is a risk of breakage if it is used with reverse rotation (M04).

φ50 (D50-22.225-200-AV) D50-22-200-AV			φ63 (D63-22.225-200-AV) D63-22-200-AV					
スクエアエンドミルシリーズ Right angle shoulder cutter [AHU 等]			ラジラスエンドミルシリーズ 高送りラジラスミルシリーズ Round insert cutter High Feed cutter [AR, ASR ASRT, ASRF 等]			スクエアエンドミルシリーズ Right angle shoulder cutter [AHU 等]		
350(7D)	400(8D)	450(9D)	350(5.5D)	400(6.3D)	490(7.7D)	350(5.5D)	400(6.3D)	490(7.7D)
70~100	70~100	70~100	80~120	80~120	80~120	70~100	70~100	70~100
0.06~0.12	0.06~0.12	0.06~0.12	0.8~1.2	0.8~1.2	0.8~1.2	0.06~0.12	0.06~0.12	0.06~0.12
1.7	1.1	0.9	0.7	0.5	0.3	3	2.5	1.7
70~100	70~100	70~100	80~120	80~120	80~120	70~100	70~100	70~100
0.06~0.12	0.06~0.12	0.06~0.12	0.8~1.2	0.8~1.2	0.8~1.2	0.06~0.12	0.06~0.12	0.06~0.12
1.7	1.1	0.9	0.7	0.5	0.3	3	2.5	1.7
50~80	50~80	50~80	70~100	70~100	70~100	50~80	50~80	50~80
0.05~0.1	0.05~0.1	0.05~0.1	0.6~1.0	0.6~1.0	0.6~1.0	0.05~0.1	0.05~0.1	0.05~0.1
1.7	1.1	0.9	0.7	0.5	0.3	3	2.5	1.7
70~100	70~100	70~100	80~120	80~120	80~120	70~100	70~100	70~100
0.05~0.1	0.05~0.1	0.05~0.1	0.6~1.0	0.6~1.0	0.6~1.0	0.05~0.1	0.05~0.1	0.05~0.1
1.7	1.1	0.9	0.7	0.5	0.3	3	2.5	1.7
70~100	70~100	70~100	80~120	80~120	80~120	70~100	70~100	70~100
0.06~0.12	0.06~0.12	0.06~0.12	0.8~1.5	0.8~1.5	0.8~1.5	0.06~0.12	0.06~0.12	0.06~0.12
1.7	1.1	0.9	0.7	0.5	0.3	3	2.5	1.7

Modular Shank
AV Arbor Parts
AV Arbor

○ オーバーホールについて Regarding overhaul

本商品の内部に消耗部品を使用しているため、使用頻度に応じて防振効果が劣化いたします。本商品の防振効果を維持するためにはオーバーホールが必要となります。常時使用時に約1年を目安として実施してください。

Since consumables are used in the internal of this product, the damping effect deteriorates with frequency of use. In order to maintain the damping effect of this product, periodic overhaul is necessary. Under always usage, overhaul is generally required approximately once per year.

※AVユニットは分解しないでください。防振効果が失われます。

※長時間使用しない場合は立てて保管してください。

※Do not disassemble the AV unit. Damping ability may be lost.

※When it will not be used for a long period of time, please store it in an upright position.

オーバーホールの詳細については弊社営業へお問合せください
For details regarding overhaul, contact with our sales office.

刃先交換式工具用 部品

サポータ (Locater)

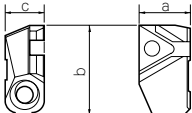
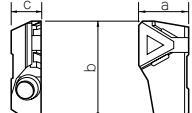
形状 Shape	商品コード (部品番号) Item code	寸法 Size(mm)						適用工具 Apply to tools	希望小売 価格 (円) Suggested retail price (¥)	
		a	b	c	d	e	f			
	351-111	20	31.05	12.2				ASF	7,730	
	171-111	16.2	28.46	10.7				A45D	7,730	
	171-112	16.2	28.46	10.7					—	
	175-111	16.2	28.21	10.7					7,730	
	175-112	16.2	28.21	10.7					—	
	176-111	18.8	31.88	12.2					A45E	7,730
	176-112	18.8	31.88	12.2					—	
	232-111	16.5	28.75	12.39				SE90	6,420	
	231-111	12.0	19.5	8.46				SE(S/L)	6,420	

モジュラーシステム
 インターフェイス
 刃先交換式工具用部品

在庫・納期等は最寄りの営業へお問い合わせください。
 If did you confirm the stocks, please contact to our sales office.

クサビ (Wedge)

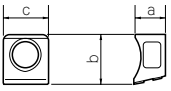
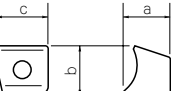
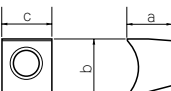
形状 Shape	商品コード (部品番号) Item code	寸法 Size(mm)						適用工具 Apply to tools	希望小売 価格 (円) Suggested retail price (¥)
		a	b	c	d	e	f		
	231-121	8	13.35	12.0				SE(S/L)	2,190
	232-121	12.35	13.0	15.0				SE90	2,190
	171-121	9.0	12.5	12.0				A45E,A45D	3,420
	171-122	9.0	12.5	12.0					—
	176-121	10.0	13.5	14.6				ASF,A45E	3,420
	176-122	10.0	13.5	14.6				A45E	—

シート (Seat)

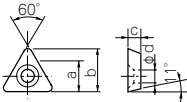
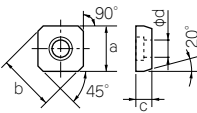
形状 Shape	商品コード (部品番号) Item code	寸法 Size(mm)						適用工具 Apply to tools	希望小売 価格 (円) Suggested retail price (¥)
		a	b	c	φd	e	f		
	212-170	10.85	15.5	3.18	4.8			SP	1,590
	831-170	8.28	11.6	3.18	3.8				1,590
	212-271	10.5	12.1	3.0	5.5			AFE45	1,610

刃先交換式工具用 部品

ねじ (Screw)

形状 Shape	商品コード (部品番号) Item code	締付トルク Fastening torque (N·m)	寸法 Size(mm)						適用工具 Apply to tools	希望小売 価格(円) Suggested retail price (¥)			
			a	φb	c	d	α	e			f		
	261-140	1.1	M3×0.5	4.0	5.7			43°		T8	AR	870	
	501-161	2.9	M4×0.7	5.1	7.5			43°		T15		870	
	541-161	9.8	M6×1.0	8.0	17.6			43°		T25	ASV	870	
	240-140	0.5	M1.8×0.35	2.5	4.0			55°		T6	RH2P,AR,ASM,ASPVmini	870	
	261-141	2.0	M3×0.5	4.2	9.0			55°		T10	BCF	870	
	262-141	2.9	M4×0.7	5.5	10.5			55°		T15	TR4F,BCF,ASB	870	
	262-142	2.9	M4×0.7	5.5	9.5			55°		T15	ASRT,ASRF,AHR,AR,RV,ASV	870	
	263-141	4.9	M5×0.8	7.2	12.5			55°		T20	AR,BCF,ASJ,ASV,AJU	870	
	263-143	4.9	M5×0.8	7.2	11.0			55°		T20	ASB,BCU,ASV,AJU	870	
	265-141	2.0	M3×0.5	4.2	7.5			55°		T10	RV,ABP4F,ASJ,ASV,AME	870	
	265-143	2.0	M3×0.5	4.2	6.3			55°		T10	GF2T,GF3L,ASRFmini,AHJ	870	
	223-141	4.9	M5×0.8	7.0	11.5			60°		T20	AR	870	
	242-141	2.9	M3.5×0.6	5.0	6.3			60°		T15	ASR,ASRT,UEX,AJU	540	
	250-140	0.5	M2×0.4	3.0	4.2			60°		T6	ABP4F,AHJ,ASJ	870	
	250-141	1.1	M2.5×0.45	3.45	5.5			53°		T8	GF1,TD4N,ASR多刃,AR,BCF,ABP4F AHU,ASJ,ASPV,ASPV-Z	870	
	251-141	1.1	M2.5×0.45	3.45	6.0					T8	GF3L,BCF,AHU,AHJ,ASJ,CPC,AJU	870	
	412-141	2.9	M4×0.7	5.5	7.5			60°		T15	GF3L,ASR,ASR多刃,AHU,SS4P,UEX AHJ,ASJ,AJU	540	
	412-143	8.0	M6×1.0	8.5	12.0			60°		T25	AJU	540	
	555-141	4.9	M5×0.8	7.0	10.5			60°		T20	ASR,ASRT,AHR,ASDF,ASDH,ASF	690	
	412-142	2.9	M4×0.7	5.5	9.6			60°		T15	RD16B	540	
	412-144	4.9	M5×0.8	6.6	12.0			60°		T20		540	
	MXSS2T		M2.5×0.45	3.5	4.6			60°		T8	MX3	570	
	MXSS4T		M4×0.7	5.5	6.6			60°		T15		570	
		581-140	0.5	M2×0.25	2.5	5.0			40°		T6	ARPF,ABPF,ABPFN	1,970
		581-141	1.1	M3×0.35	4.4	6.7			61°		T8		1,490
581-142		2.2	M3.5×0.35	5.7	8.1			61°		T10	ARPF,ABPF	1,490	
581-143		4.9	M5×0.5	6.8	9.8			61°		T20	GP1T,ARPF,ABPF	1,490	
581-144		4.9	M5×0.5	6.6	13.5			40°		T20	GP1LB,GP1T,ARPF,ABPF,ABPFN	1,490	
581-145		6.9	M6×0.75	8.0	16.7			40°		T25		1,490	
581-146		9.8	M6×0.75	9.5	21.8			40°		T30		1,710	
581-147		9.8	M8×0.75	12.0	25.0			40°		T30		1,710	
581-149		0.9	M2.5×0.35	3.3	6.7			40°		T7		1,490	
581-150		1.1	M3.0×0.35	3.8	7.6			40°		T8		1,490	
581-151		2.2	M3.5×0.35	4.7	9.8			40°		T10	ABPFN	1,490	
581-152		2.9	M4×0.5	5.7	13.5			40°		T15		1,490	
155-158		2.2	M3.5×0.35	4.8	14.8			40°		T15	ABP4F	1,880	
155-159		2.9	M4×0.7	6.1	19.4			40°		T15		1,920	
155-160	4.9	M5×0.5	6.6	22.9			40°		T20	2,020			
	P08-2507	1.1	M2.5×0.45	3.7	6.7			60°		8IP	BR2P	1,110	
	P10-3007	2.0	M3×0.5	4.2	6.5			60°		10IP		1,200	
	P10-3008	2.0	M3×0.5	4.2	8			60°		10IP		1,130	
	P15-4008	2.9	M4×0.7	5.5	8			60°		15IP		1,250	
	P15-4011	2.9	M4×0.7	6	10.5			60°		15IP		1,280	
	P20-5011	4.9	M5×0.8	7.2	11			60°		20IP		1,180	
	P20-5013	4.9	M5×0.8	6.8	13			60°		20IP		1,280	
	P25-6016	8.0	M6×1.0	8.6	16			60°		25IP		1,660	
	P30-6019	9.8	M6×1.0	9.5	18.8			60°		30IP		2,140	
	242-143	2.9	M3.5×0.6	5.0	12.0			60°		15IP		AFE45	950

在庫・納期等は最寄りの営業へお問い合わせください。If did you confirm the stocks, please contact to our sales office.

ねじ (Screw)

形状 Shape	商品コード (部品番号) Item code	寸法 Size(mm)							適用工具 Apply to tools	希望小売 価格 (円) Suggested retail price (¥)	
		a	φb	c	d	α	e	f			
	212-180	M4×0.7	5.8	9.0		90°		2	SP	500	
	831-180	M3×0.5	4.8	7.3		90°		1.5		500	
	212-280	M5×0.5	6.3	7.0	M3.5			3.5	AFE45	1,080	
	100-142	M8×1.0		20	8		8	4	A45E	540	
	100-143	M8×1.0		17	6.5		6.5	4	ASF,A45E,A45D,SE90	540	
	231-140	M8×1.0		13.5	5		5	4	SE(S/L)	540	
	231-160	M3×0.5	5.35	8	6			2	SE(S/L)	200	
	W50-1031	(d側)M10×1.0 (e側)M10×1.5		31	14			12	5	TD6N	2,090
	100-211	M10×1.5	16	45		60°	35	8	SP,AR	200	
	151-162	M5×0.8左	8.5	15		92°	10	4	SE90	200	
	156-161	M5×0.8	8.5	15		90°	10	4	ASF,A45E,A45D	280	
	156-162	M5×0.8左	8.5	15		92°	10	4	A45E,A45D,SE90	200	
	200-150	M6×1.0	8.5	20.5		120°	17.5	T20	AR	540	
	571-141A	M6×1.0	8.7	18.5		60°	12.4	T30	BCF,ASB,BCU	870	
	571-142	M6×1.0	8.7	14.9		60°	9	T25	ASB	1,360	
	100-174	M10×1.5	16	35	25			8	ASR,ASRT,ASRF,ASR多刃,AHR ASV,ASF,AVアーバ	200	
	100-175	M10×1.5	16	35	25			8	AHU,ASF	200	
	100-176	M16×2.0	24	51	35			14	ASF	200	
	100-177	M20×2.5	30	55	35			17	ASF	200	
	100-178	M10×1.5	16	35	25			8	TR4F,ASRT,ASRF,ASR多刃,RD16B RV,ASPV,AVアーバ	1,760	
	100-179	M12×1.75	18	42	30			10	TR4F,ASRT,ASRF,RD16B,RV	1,760	
	100-180	M16×2.0	24	51	35			14		1,760	
	100-182	M10×1.5	16	45	35			8	AME	3,060	
	100-183	M8×1.25	13	33	25				RV	1,760	
	100-184	M8×1.25	11	33	25			6	RD16B	3,060	
	100-212	M12×1.75	18	42	30			10	AHU,ASF,SP	200	
	100-213	M16×2.0	24	51	35			14	ASR,ASRT,ASRF,AHR,ASV,ASF	200	
	600-211	M20×2.5	50	50	36			17	ASV	—	

刃先交換式工具用 部品

クランプ駒 (Clamp piece)

形状 Shape	商品コード (部品番号) Item code	寸法 Size(mm)						適用工具 Apply to tools	希望小売 価格 (円) Suggested retail price (¥)
		a	b	c	d	e	f		
	215-192		11.8	12.5	16	7.0		AR	1,360

クランプ駒セット (Clamp piece set)

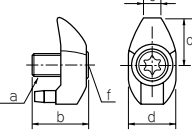
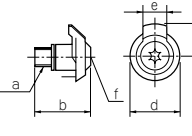
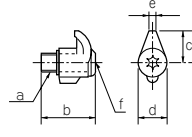
形状 Shape	商品コード (部品番号) Item code	締付トルク Fastening torque (N·m)	寸法 Size(mm)						適用工具 Apply to tools	希望小売 価格 (円) Suggested retail price (¥)	
			a	b	c	d	e	f			
	CM3.5-141	2.9	M3.5×0.6	9.7	6.5	7.6	3.0	T15	ASR,ASRT,ASR多刃,AR	2,030	
	CM4-141	2.9	M4×0.7	12.7	8	8.2	3.0	T15	ASRT,ASRF,AHR,AR	2,030	
	CM5-147	4.9	M5×0.8	13.0	9	9.0	3.0	T20	ASR,ASRT,AHR,AR	2,030	
	CM5-148	4.9	M5×0.8	13.0	9	9.0	3.0	T25	ASB	2,030	
	CM5-141	4.9	M5×0.8	16.3	7.5	12.0	6.0	T20	CPC,SP	2,030	
	CM6-147	8.0	M6×1.0	22	9.8	15	7.0	T25		2,030	
	CB6-143	6.9	M6×0.75	17	10	9	3.0	T25	EP	2,030	
	CB6-145	6.9	M6×0.75	19.5	10	9	3.0	T25		2,030	
	CB6-147	8.0	M6×1.0	22	10	9	3.0	T25		2,030	
	CB8-161	9.8	M8×1.25	22.3	13.5	11	4.0	T30		ASB,BCU	2,030
	MXCP2T	2.9	M5×0.8	15.2	8.5	7.0	2.5	T15		MX3	2,250

スプリング (Spring)

形状 Shape	商品コード (部品番号) Item code	寸法 Size(mm)						適用工具 Apply to tools	希望小売 価格 (円) Suggested retail price (¥)
		a	b	c	d	e	f		
	715-201	3.8	9.0					AR	120

在庫・納期等は最寄りの営業へお問い合わせください。 If did you confirm the stocks, please contact to our sales office.

モジュラーシステム
インサート部品
刃先交換式工具用部品

ドライバー／レンチ (Screw driver / Wrench)

形状 Shape	商品コード (部品番号) Item code	寸法 Size(mm)						適用工具 Apply to tools	希望小売 価格 (円) Suggested retail price (¥)
		a	b	c	d	e	f		
	100-224	58	16	2				SP	200
	100-225	45	14	1.5					200
	100-230	68	22	3.5				AFE45	440
	100-LT25	72	45	T25				EP	360
	MXLT8	48	16	T8				MX3	350
	MXLT15	52	18	T15					350
	100-221	83	33	4				SE(S/L),ASF,A45E,A45D,SE90	950
	101-T20	100	50	T20				ASV,SP	1,440
	101-T25L	120	70	T25				ASV,CPC,SP	1,440
	105-T20L	145	100	T20				ASDF,ASDH,ASF	2,120
	101-T25S	105	80	T25				GP1LB,GP1T,ARPF,ASB,ABPF,AJU SP	1,440
	105-T15	105	80	T15				TR4F,ASRT,ASRF,ASR多刃,AHR,AR RV,AHU	2,120
	105-T20	105	80	T20				GP1LB,GP1T,ASR,ASRT,AHR,AR RD16B,ARPF,BCF,ASB,BCU,ABPF ABPFN,ABP4F,ASV,ASDF,ASDH ASF,CPC,AJU	2,120
	105-T30A	132	101	T30				GP1LB,GP1T,ARPF,BCF,ASB,BCU ABPF,ABPFN	2,120
	105-20IP	132	100	20IP					4,890
	105-25IP	182	150	25IP				BR2P	5,450
	105-30IP	182	150	30IP					6,020
	102-T20	190	90	T20				ASJ	2,270
	104-T6	115	45	T6				RH2P,AR,ARPF,ABPF,ABPFN ABP4F,ASM,AHJ,ASJ,ASPVmini	1,800
	104-T7	164	64	T7				ABPFN	2,060
	104-T8	136	60	T8				GF1,GF3L,TD4N,ASR多刃,AR,ARPF BCF,ABPF,ABPFN,ABP4F,AHU,AHJ ASJ,ASPV,ASPV-Z,CPC,AJU	1,800
	104-T10	176	80	T10				GF2T,GF3L,ASRFmini,RV,ARPF, BCF,ABPF,ABPFN,ABP4F,AHJ,ASJ ASV,AME	1,920
	104-T15	176	80	T15				GF3L,ASR,ASRT,AR,RD16B,RV BCF,ASB,ABPFN,ABP4F,AHU,SS4P UEX,AHJ,ASJ,ASV,AJU	2,060
	106-8IP	164	60	8IP				BR2P	2,500
	106-10IP	191	80	10IP					2,740
	106-15IP	191	80	15IP				BR2P,AFE45	2,870

トルクス プラス®、Torx Plus®は、米国アクUMENT インテクチュアル プロパティーズ エルエルシー社の登録商標です。
Torx Plus® is a trademark of Acument Intellectual Properties LLC in the United States.

スパナ (Spanner)

形状 Shape	商品コード (部品番号) Item code	適用工具 Apply to tools
	SN-35 SN-41 SN-55	AVアーバ

ねじ焼付き防止剤 (Screw anti-seizure agent)

形状 Shape	商品コード (部品番号) Item code	適用工具 Apply to tools	希望小売価格(円) Suggested retail price (¥)
	P-37	GF1,GF2T,GF3L,GP1LB,GP1T,TR4F,TD4N,ASR ASRT,ASRF,ASRFmini,ASR多刃,RH2P,AHR,AR RD16B,RV,ARPF,BR2P,BCF,ASB,BCU,ABPF,ABPFN ABP4F,ASM,AHU,SS4P,AHJ,AME,ASPV-mini ASPV,ASPV-Z,ASDF,ASDH,ASF	1,010

在庫・納期等は最寄りの営業へお問い合わせください。
If did you confirm the stocks, please contact to our sales office.

穴あけ工具

Boring Tools



超硬NSB・超硬ドリル選定基準表	E2
Selection standard table for Carbide NSB & Carbide Drills	
直径別寸法早見表	E6
Quick dimension reference table by mill diameter	
超硬ノンステップボーラー(NSB)	E20
Carbide Non Step Borer (NSB)	
その他のドリル	E56
Other Drills	

種類別(カタログ掲載順) By type (catalog listing order)

超硬ノンステップボーラー Carbide Non Step Borer

03WHNSB-TH	E20
05WHNSB-TH	E21
08WHNSB-TH	E23
10WHNSB-TH	E25
15WHNSB-TH	E26
20WHNSB-TH	E27
25WHNSB-TH	E28
30WHNSB-TH	E29
40WHNSB-TH	E31
50WHNSB-TH	E32
02WNSB-TH	E35
04WNSB-TH	E36
03FWHNSB-TH	E38
05FWHNSB-TH	E39
10FWHNSB-TH	E40
15FWHNSB-TH	E41

20FWHNSB-TH	E42
30FWHNSB-TH	E43
03WHNSB-SD	E45
05WHNSB-SD	E46
15WHNSB-SD	E47
20WHNSB-SD	E47
25WHNSB-SD	E47
30WHNSB-SD	E47
NSBH-ATH	E49

その他のドリル Other Drills

WHSR-ATH	E56
WHMB-TH	E63
EMSBS-TH	E68
EMSBS-SD	E68
EMST-TH	E72
EMSBH-ATH	E74
EPDBEH-ATH	E78
EHSE-TH	E80
STBH-ATH	E82
STB-ATH	E83
ZPB-TH	E85
ZPBL-TH	E87
EWSS	E90
EWSR	E91

商品コード別(アルファベット順) By item code (alphabetical order)

02WNSB-TH	E35
03FWHNSB-TH	E38
03WHNSB-SD	E45
03WHNSB-TH	E20
04WNSB-TH	E36
05FWHNSB-TH	E39
05WHNSB-SD	E46
05WHNSB-TH	E21
08WHNSB-TH	E23
10FWHNSB-TH	E40
10WHNSB-TH	E25
15FWHNSB-TH	E41
15WHNSB-SD	E47

15WHNSB-TH	E26
20FWHNSB-TH	E42
20WHNSB-SD	E47
20WHNSB-TH	E27
25WHNSB-SD	E47
25WHNSB-TH	E28
30FWHNSB-TH	E43
30WHNSB-SD	E47
30WHNSB-TH	E29
40WHNSB-TH	E31
50WHNSB-TH	E32
EHSE-TH	E80
EMSBH-ATH	E74

EMSBS-SD	E68
EMSBS-TH	E68
EMST-TH	E72
EPDBEH-ATH	E78
EWSR	E91
EWSS	E90
NSBH-ATH	E49
STB-ATH	E83
STBH-ATH	E82
WHMB-TH	E63
WHSR-ATH	E56
ZPB-TH	E85
ZPBL-TH	E87

























超硬NSB・超硬ドリル 選定基準表



超硬ノンステップボーラー Carbide Non Step Borer





























商品名称 Product	オイルホール Oilhole ○：あり With oil hole -：なし Without oil hole	直径 Tool dia DC(mm)	商品コード Item Code	穴深さ Drilling depth														
				~2D	~3D	~4D	~5D	~8D	~10D	~15D	~20D	~25D	~30D	~40D	~50D	~100D		
超硬OHノンステップボーラー Carbide Oil Hole Non Step Borer	○	2.0~13.0	03WHNSB-TH	3D														
		2.0~13.0	05WHNSB-TH	5D														
		2.0~13.0	08WHNSB-TH	8D														
		2.0~13.0	10WHNSB-TH	10D														
		2.0~13.0	15WHNSB-TH	15D														
		2.0~13.0	20WHNSB-TH	20D														
		2.0~13.0	25WHNSB-TH	25D														
		2.0~12.0	30WHNSB-TH	30D														
		2.5~10.0	40WHNSB-TH	40D														
		2.5~8.0	50WHNSB-TH	50D														
超硬ノンステップボーラー Carbide Non Step Borer	-	3.0~13.0	02WNSB-TH	2D														
		1.0~13.0	04WNSB-TH	4D														
鋳鉄用 超硬OHノンステップボーラー Carbide Oil Hole Non Step Borer for Cast Iron	○	3.0~13.0	03FWHNSB-TH	3D														
		3.0~13.0	05FWHNSB-TH	5D														
		3.0~13.0	10FWHNSB-TH	10D														
		3.0~13.0	15FWHNSB-TH	15D														
		3.0~12.0	20FWHNSB-TH	20D														
		3.0~10.0	30FWHNSB-TH	30D														
アルミ用 超硬OHノンステップボーラー Carbide Oil Hole Non Step Borer for Aluminium	○	3.0~10.03	03WHNSB-SD	3D														
		2.0~10.03	05WHNSB-SD	5D														
		3.0~10.0	15WHNSB-SD	15D														
		3.0~8.0	20WHNSB-SD	20D														
		3.0~8.0	25WHNSB-SD	25D														
		3.0~6.0	30WHNSB-SD	30D														

穴あけ工具

選定基準表

	適用被削材材質 Work material											形状 Shape	コーティング Coating	掲載頁 Page			
	P				H			M	S	K				N		寸法表 Size List	切削条件 Cutting Conditions
	軟鋼 Mild steels	炭素鋼 Carbon steels	合金鋼 Alloy steels	硬化鋼 Hardened steels	工具鋼 Tool steels	焼入れ鋼 Hardened steels	焼入れ鋼 Hardened steels	45 HRC~	ステンレス鋼 Stainless steels	高温合金 Heat resistant alloy	鋳鉄 Cast iron			鋳鉄 Cast iron	アルミ合金 Aluminum alloy		
SS	S00C	SCM SCr	SKD SKS	~40 HRC	~45 HRC	45 HRC~	SUS	Inconel Ti Alloy	FC	FCD	Al	Cu					
<input type="checkbox"/>	<input type="checkbox"/>	<input type="checkbox"/>	<input type="checkbox"/>	<input type="checkbox"/>	<input type="checkbox"/>	<input type="checkbox"/>	<input type="checkbox"/>	<input type="checkbox"/>	<input type="checkbox"/>	<input type="checkbox"/>	<input type="checkbox"/>	<input type="checkbox"/>	<input type="checkbox"/>		TH	E20	E22
<input type="checkbox"/>	<input type="checkbox"/>	<input type="checkbox"/>	<input type="checkbox"/>	<input type="checkbox"/>	<input type="checkbox"/>	<input type="checkbox"/>	<input type="checkbox"/>	<input type="checkbox"/>	<input type="checkbox"/>	<input type="checkbox"/>	<input type="checkbox"/>	<input type="checkbox"/>	<input type="checkbox"/>		TH	E21	E22
<input type="checkbox"/>	<input type="checkbox"/>	<input type="checkbox"/>	<input type="checkbox"/>	<input type="checkbox"/>	<input type="checkbox"/>	<input type="checkbox"/>	<input type="checkbox"/>	<input type="checkbox"/>	<input type="checkbox"/>	<input type="checkbox"/>	<input type="checkbox"/>	<input type="checkbox"/>	<input type="checkbox"/>		TH	E23	E24
<input type="checkbox"/>	<input type="checkbox"/>	<input type="checkbox"/>	<input type="checkbox"/>	<input type="checkbox"/>	<input type="checkbox"/>	<input type="checkbox"/>	<input type="checkbox"/>	<input type="checkbox"/>	<input type="checkbox"/>	<input type="checkbox"/>	<input type="checkbox"/>	<input type="checkbox"/>	<input type="checkbox"/>		TH	E25	E30
<input type="checkbox"/>	<input type="checkbox"/>	<input type="checkbox"/>	<input type="checkbox"/>	<input type="checkbox"/>	<input type="checkbox"/>	<input type="checkbox"/>	<input type="checkbox"/>	<input type="checkbox"/>	<input type="checkbox"/>	<input type="checkbox"/>	<input type="checkbox"/>	<input type="checkbox"/>	<input type="checkbox"/>		TH	E26	E30
<input type="checkbox"/>	<input type="checkbox"/>	<input type="checkbox"/>	<input type="checkbox"/>	<input type="checkbox"/>	<input type="checkbox"/>	<input type="checkbox"/>	<input type="checkbox"/>	<input type="checkbox"/>	<input type="checkbox"/>	<input type="checkbox"/>	<input type="checkbox"/>	<input type="checkbox"/>	<input type="checkbox"/>		TH	E27	E30
<input type="checkbox"/>	<input type="checkbox"/>	<input type="checkbox"/>	<input type="checkbox"/>	<input type="checkbox"/>	<input type="checkbox"/>	<input type="checkbox"/>	<input type="checkbox"/>	<input type="checkbox"/>	<input type="checkbox"/>	<input type="checkbox"/>	<input type="checkbox"/>	<input type="checkbox"/>	<input type="checkbox"/>		TH	E28	E30
<input type="checkbox"/>	<input type="checkbox"/>	<input type="checkbox"/>	<input type="checkbox"/>	<input type="checkbox"/>	<input type="checkbox"/>	<input type="checkbox"/>	<input type="checkbox"/>	<input type="checkbox"/>	<input type="checkbox"/>	<input type="checkbox"/>	<input type="checkbox"/>	<input type="checkbox"/>	<input type="checkbox"/>		TH	E29	E30
<input type="checkbox"/>	<input type="checkbox"/>	<input type="checkbox"/>	<input type="checkbox"/>	<input type="checkbox"/>	<input type="checkbox"/>	<input type="checkbox"/>	<input type="checkbox"/>	<input type="checkbox"/>	<input type="checkbox"/>	<input type="checkbox"/>	<input type="checkbox"/>	<input type="checkbox"/>	<input type="checkbox"/>		TH	E31	E33
<input type="checkbox"/>	<input type="checkbox"/>	<input type="checkbox"/>	<input type="checkbox"/>	<input type="checkbox"/>	<input type="checkbox"/>	<input type="checkbox"/>	<input type="checkbox"/>	<input type="checkbox"/>	<input type="checkbox"/>	<input type="checkbox"/>	<input type="checkbox"/>	<input type="checkbox"/>	<input type="checkbox"/>		TH	E32	E33
<input type="checkbox"/>	<input type="checkbox"/>	<input type="checkbox"/>	<input type="checkbox"/>	<input type="checkbox"/>	<input type="checkbox"/>	<input type="checkbox"/>	<input type="checkbox"/>	<input type="checkbox"/>	<input type="checkbox"/>	<input type="checkbox"/>	<input type="checkbox"/>	<input type="checkbox"/>	<input type="checkbox"/>		TH	E35	E37
<input type="checkbox"/>	<input type="checkbox"/>	<input type="checkbox"/>	<input type="checkbox"/>	<input type="checkbox"/>	<input type="checkbox"/>	<input type="checkbox"/>	<input type="checkbox"/>	<input type="checkbox"/>	<input type="checkbox"/>	<input type="checkbox"/>	<input type="checkbox"/>	<input type="checkbox"/>	<input type="checkbox"/>		TH	E36	E37
<input type="checkbox"/>	<input type="checkbox"/>	<input type="checkbox"/>	<input type="checkbox"/>	<input type="checkbox"/>	<input type="checkbox"/>	<input type="checkbox"/>	<input type="checkbox"/>	<input type="checkbox"/>	<input type="checkbox"/>	<input type="checkbox"/>	<input type="checkbox"/>	<input type="checkbox"/>	<input type="checkbox"/>		TH	E38	E44
<input type="checkbox"/>	<input type="checkbox"/>	<input type="checkbox"/>	<input type="checkbox"/>	<input type="checkbox"/>	<input type="checkbox"/>	<input type="checkbox"/>	<input type="checkbox"/>	<input type="checkbox"/>	<input type="checkbox"/>	<input type="checkbox"/>	<input type="checkbox"/>	<input type="checkbox"/>	<input type="checkbox"/>		TH	E39	E44
<input type="checkbox"/>	<input type="checkbox"/>	<input type="checkbox"/>	<input type="checkbox"/>	<input type="checkbox"/>	<input type="checkbox"/>	<input type="checkbox"/>	<input type="checkbox"/>	<input type="checkbox"/>	<input type="checkbox"/>	<input type="checkbox"/>	<input type="checkbox"/>	<input type="checkbox"/>	<input type="checkbox"/>		TH	E40	E44
<input type="checkbox"/>	<input type="checkbox"/>	<input type="checkbox"/>	<input type="checkbox"/>	<input type="checkbox"/>	<input type="checkbox"/>	<input type="checkbox"/>	<input type="checkbox"/>	<input type="checkbox"/>	<input type="checkbox"/>	<input type="checkbox"/>	<input type="checkbox"/>	<input type="checkbox"/>	<input type="checkbox"/>		TH	E41	E44
<input type="checkbox"/>	<input type="checkbox"/>	<input type="checkbox"/>	<input type="checkbox"/>	<input type="checkbox"/>	<input type="checkbox"/>	<input type="checkbox"/>	<input type="checkbox"/>	<input type="checkbox"/>	<input type="checkbox"/>	<input type="checkbox"/>	<input type="checkbox"/>	<input type="checkbox"/>	<input type="checkbox"/>		TH	E42	E44
<input type="checkbox"/>	<input type="checkbox"/>	<input type="checkbox"/>	<input type="checkbox"/>	<input type="checkbox"/>	<input type="checkbox"/>	<input type="checkbox"/>	<input type="checkbox"/>	<input type="checkbox"/>	<input type="checkbox"/>	<input type="checkbox"/>	<input type="checkbox"/>	<input type="checkbox"/>	<input type="checkbox"/>		TH	E43	E44
<input type="checkbox"/>	<input type="checkbox"/>	<input type="checkbox"/>	<input type="checkbox"/>	<input type="checkbox"/>	<input type="checkbox"/>	<input type="checkbox"/>	<input type="checkbox"/>	<input type="checkbox"/>	<input type="checkbox"/>	<input type="checkbox"/>	<input type="checkbox"/>	<input type="checkbox"/>	<input type="checkbox"/>		SD	E45	E48
<input type="checkbox"/>	<input type="checkbox"/>	<input type="checkbox"/>	<input type="checkbox"/>	<input type="checkbox"/>	<input type="checkbox"/>	<input type="checkbox"/>	<input type="checkbox"/>	<input type="checkbox"/>	<input type="checkbox"/>	<input type="checkbox"/>	<input type="checkbox"/>	<input type="checkbox"/>	<input type="checkbox"/>		SD	E46	E48
<input type="checkbox"/>	<input type="checkbox"/>	<input type="checkbox"/>	<input type="checkbox"/>	<input type="checkbox"/>	<input type="checkbox"/>	<input type="checkbox"/>	<input type="checkbox"/>	<input type="checkbox"/>	<input type="checkbox"/>	<input type="checkbox"/>	<input type="checkbox"/>	<input type="checkbox"/>	<input type="checkbox"/>		SD	E47	E48
<input type="checkbox"/>	<input type="checkbox"/>	<input type="checkbox"/>	<input type="checkbox"/>	<input type="checkbox"/>	<input type="checkbox"/>	<input type="checkbox"/>	<input type="checkbox"/>	<input type="checkbox"/>	<input type="checkbox"/>	<input type="checkbox"/>	<input type="checkbox"/>	<input type="checkbox"/>	<input type="checkbox"/>		SD	E47	E48
<input type="checkbox"/>	<input type="checkbox"/>	<input type="checkbox"/>	<input type="checkbox"/>	<input type="checkbox"/>	<input type="checkbox"/>	<input type="checkbox"/>	<input type="checkbox"/>	<input type="checkbox"/>	<input type="checkbox"/>	<input type="checkbox"/>	<input type="checkbox"/>	<input type="checkbox"/>	<input type="checkbox"/>		SD	E47	E48
<input type="checkbox"/>	<input type="checkbox"/>	<input type="checkbox"/>	<input type="checkbox"/>	<input type="checkbox"/>	<input type="checkbox"/>	<input type="checkbox"/>	<input type="checkbox"/>	<input type="checkbox"/>	<input type="checkbox"/>	<input type="checkbox"/>	<input type="checkbox"/>	<input type="checkbox"/>	<input type="checkbox"/>		SD	E47	E48

適用被削材材質 Work material											形状 Shape	コーティング Coating	掲載頁 Page			
P		H		M	S	K	N		寸法表 Size List	切削条件 Cutting Conditions						
軟鋼 Mild steels	炭素鋼 Carbon steels	合金鋼 Alloy steels	工具鋼 Tool steels	焼入れ鋼 Hardened steels	ステンレス鋼 Stainless steels	Ti合金 Ti alloy Heat resistant alloy	铸铁 Cast iron	ダクタイル Ductile cast iron					銅合金 Copper alloy	アルミ合金 Aluminum alloy		
SS	S00C	SCM SCr	SKD SKS	~40 HRC	~45 HRC	45 HRC~	SUS	Inconel Ti Alloy	FC	FCD	Al	Cu			E49	E54

適用被削材材質 Work material											形状 Shape	コーティング Coating	掲載頁 Page			
P		H		M	S	K	N		寸法表 Size List	切削条件 Cutting Conditions						
軟鋼 Mild steels	炭素鋼 Carbon steels	合金鋼 Alloy steels	工具鋼 Tool steels	焼入れ鋼 Hardened steels	ステンレス鋼 Stainless steels	Ti合金 Ti alloy Heat resistant alloy	铸铁 Cast iron	ダクタイル Ductile cast iron					銅合金 Copper alloy	アルミ合金 Aluminum alloy		
SS	S00C	SCM SCr	SKD SKS	~40 HRC	~45 HRC	45 HRC~	SUS	Inconel Ti Alloy	FC	FCD	Al	Cu			E56	E62
															E63	E66
															E68	E71
															E68	E71
															E72	E72
															E74	E76
															E78	E79
															E80	E81
															E82	E84
															E83	E84
															E85	E89
															E87	E89
															E90	E92
															E91	E92

Quick dimension reference table by tool diameter

直径別寸法早見表

φ0.04~φ1.75

単位 unit : mm

商品コード Item code	在庫 Stock	直径 Tool dia.	溝長 Flute length	全長 Overall length	シャンク径 Shank dia.	ページ Page	商品コード Item code	在庫 Stock	直径 Tool dia.	溝長 Flute length	全長 Overall length	シャンク径 Shank dia.	ページ Page	商品コード Item code	在庫 Stock	直径 Tool dia.	溝長 Flute length	全長 Overall length	シャンク径 Shank dia.	ページ Page	商品コード Item code	在庫 Stock	直径 Tool dia.	溝長 Flute length	全長 Overall length	シャンク径 Shank dia.	ページ Page							
EMST0004-TH	●	0.04	0.04	45	3	E72	EMSB0010-7.5-SD	□	0.1	0.5	45	3	E68	EMSBH0060-18-ATH	●	0.6	3	55	3	E74	EMSB0030-15-SD	□	0.3	1.5	55	3	E68	EMSBH0060-30-SD	□	0.6	3	75	3	E68
EMSB0004-0.4-SD	□	0.04	0.2	40	3	E68	EMSB0010-7.5-TH	●	0.1	0.5	45	3	E68	EMSB0030-15-TH	●	0.3	1.5	55	3	E68	EMSB0060-30-SD	□	0.6	3	75	3	E68	EMSBH0060-30-TH	●	0.6	3	75	3	E68
EMSB0004-0.4-TH	●	0.04	0.2	40	3	E68	EMSB0010-10-SD	□	0.1	0.5	45	3	E68	EMSB0030-22.5-SD	□	0.3	1.5	65	3	E68	EMSB0060-45-SD	□	0.6	3	95	3	E68	EMSBH0060-45-SD	□	0.6	3	95	3	E68
EMSB0004-0.8-SD	□	0.04	0.2	40	3	E68	EMSB0010-10-TH	□	0.1	0.5	45	3	E68	EMSB0030-22.5-TH	□	0.3	1.5	65	3	E68	EMSB0060-60-SD	□	0.6	3	95	3	E68	EMSBH0060-60-SD	□	0.6	3	95	3	E68
EMSB0004-0.8-TH	●	0.04	0.2	40	3	E68	EMSBH0010-1-ATH	●	0.1	0.5	45	3	E74	EMSB0030-30-SD	□	0.3	1.5	65	3	E68	EMSB0060-60-TH	□	0.6	3	95	3	E68	EMSBH0060-60-TH	□	0.6	3	95	3	E68
EMSB0004-1.2-SD	□	0.04	0.2	40	3	E68	EMSBH0010-2-ATH	●	0.1	0.5	45	3	E74	EMSB0030-30-TH	□	0.3	1.5	65	3	E68	EMST0061-TH	□	0.61	0.61	45	3	E72	EMSBH0061-12-ATH	□	0.61	3	55	3	E74
EMSB0004-1.2-TH	●	0.04	0.2	40	3	E68	EMSBH0010-3-ATH	●	0.1	0.5	45	3	E74	EMST0031-TH	□	0.31	0.31	45	3	E72	EMSBH0061-18-ATH	□	0.61	3	55	3	E74	EMSBH0062-6-ATH	□	0.62	3	55	3	E74
EMST0005-TH	●	0.05	0.05	45	3	E72	EMST0011-TH	●	0.11	0.11	45	3	E72	EMSBH0031-3-ATH	□	0.31	1.5	45	3	E74	EMST0061-TH	□	0.61	0.61	45	3	E72	EMSBH0062-12-ATH	□	0.62	3	55	3	E74
EMSB0005-0.5-SD	□	0.05	0.25	40	3	E68	EMSBH0011-1-ATH	□	0.11	0.55	45	3	E74	EMSBH0031-6-ATH	□	0.31	1.5	45	3	E74	EMSBH0062-18-ATH	□	0.62	3	55	3	E74	EMSBH0062-18-ATH	□	0.62	3	55	3	E74
EMSB0005-0.5-TH	●	0.05	0.25	40	3	E68	EMSBH0011-2-ATH	□	0.11	0.55	45	3	E74	EMSBH0031-9-ATH	□	0.31	1.5	45	3	E74	EMST0069-TH	□	0.69	0.69	45	4	E72	EMST0070-TH	●	0.7	0.7	45	4	E72
EMSB0005-1-SD	□	0.05	0.25	40	3	E68	EMSBH0011-3-ATH	□	0.11	0.55	45	3	E74	EMSBH0032-3-ATH	□	0.32	1.5	45	3	E74	EMSB0070-7-SD	□	0.7	3.5	60	4	E68	EMSB0070-7-TH	●	0.7	3.5	60	4	E68
EMSB0005-1-TH	●	0.05	0.25	40	3	E68	EMST0012-TH	●	0.12	0.12	45	3	E72	EMSBH0032-6-ATH	□	0.32	1.5	45	3	E74	EMSB0070-14-SD	□	0.7	3.5	60	4	E68	EMSB0070-14-TH	□	0.7	3.5	60	4	E68
EMSB0005-1.5-SD	□	0.05	0.25	40	3	E68	EMSBH0012-1-ATH	□	0.12	0.6	45	3	E74	EMSBH0032-9-ATH	□	0.32	1.5	45	3	E74	EMSB0070-21-SD	□	0.7	3.5	60	4	E68	EMSB0070-21-TH	●	0.7	3.5	60	4	E68
EMSB0005-1.5-TH	●	0.05	0.25	40	3	E68	EMSBH0012-2-ATH	□	0.12	0.6	45	3	E74	EMST0039-TH	□	0.39	0.39	45	3	E72	EMSB0070-35-SD	□	0.7	3.5	80	4	E68	EMSB0070-35-TH	●	0.7	3.5	80	4	E68
EMSB0005-2-SD	□	0.05	0.25	40	3	E68	EMSBH0012-3-ATH	□	0.12	0.6	45	3	E74	EMST0040-TH	●	0.4	0.4	45	3	E72	EMSB0070-52.5-SD	□	0.7	3.5	105	4	E68	EMSB0070-52.5-TH	□	0.7	3.5	105	4	E68
EMSB0005-2-TH	□	0.05	0.25	40	3	E68	EMST0013-TH	●	0.13	0.13	45	3	E72	EMSB0040-4-SD	□	0.4	2	50	3	E68	EMSB0070-70-SD	□	0.7	3.5	105	4	E68	EMSB0070-70-TH	□	0.7	3.5	105	4	E68
EMSB0005-2.5-SD	□	0.05	0.25	40	3	E68	EMST0014-TH	●	0.14	0.14	45	3	E72	EMSB0040-4-TH	●	0.4	2	50	3	E68	EMST0071-TH	□	0.71	0.71	45	4	E72	EMSBH0071-7-ATH	●	0.71	3.5	60	4	E74
EMSB0005-2.5-TH	□	0.05	0.25	40	3	E68	EMST0015-TH	●	0.15	0.15	45	3	E72	EMSB0040-8-SD	□	0.4	2	50	3	E68	EMSBH0071-14-ATH	●	0.71	3.5	60	4	E74	EMSBH0071-21-ATH	□	0.71	3.5	60	4	E74
EMST0006-TH	●	0.06	0.06	45	3	E72	EMSBH0015-1.5-ATH	□	0.15	0.75	45	3	E74	EMSB0040-8-TH	□	0.4	2	50	3	E68	EMSBH0071-35-SD	□	0.7	3.5	80	4	E68	EMSBH0072-7-ATH	□	0.72	3.5	60	4	E74
EMSB0006-0.6-SD	□	0.06	0.3	40	3	E68	EMSBH0015-3-ATH	□	0.15	0.75	45	3	E74	EMSB0040-12-SD	□	0.4	2	50	3	E68	EMSBH0072-14-ATH	□	0.72	3.5	60	4	E74	EMSBH0072-21-ATH	□	0.72	3.5	60	4	E74
EMSB0006-0.6-TH	●	0.06	0.3	40	3	E68	EMSBH0015-4.5-ATH	□	0.15	0.75	45	3	E74	EMSB0040-12-TH	●	0.4	2	50	3	E68	EMSB0070-70-SD	□	0.7	3.5	105	4	E68	EMSB0070-70-TH	□	0.7	3.5	105	4	E68
EMSB0006-1.2-SD	□	0.06	0.3	40	3	E68	EMSB0015-1.5-SD	□	0.15	0.75	50	3	E68	EMSBH0040-4-ATH	●	0.4	2	50	3	E74	EMST0041-TH	□	0.41	0.41	45	3	E72	EMSB0080-8-SD	□	0.8	4	60	4	E68
EMSB0006-1.2-TH	□	0.06	0.3	40	3	E68	EMSB0015-1.5-TH	●	0.15	0.75	50	3	E68	EMSBH0040-8-ATH	●	0.4	2	50	3	E74	EMSB0080-8-TH	●	0.8	4	60	4	E68	EMSB0080-16-SD	□	0.8	4	60	4	E68
EMSB0006-1.8-SD	□	0.06	0.3	40	3	E68	EMSB0015-3-SD	□	0.15	0.75	50	3	E68	EMSBH0040-12-ATH	●	0.4	2	50	3	E74	EMSB0080-16-TH	□	0.8	4	60	4	E68	EMSB0080-24-SD	□	0.8	4	60	4	E68
EMSB0006-1.8-TH	●	0.06	0.3	40	3	E68	EMSB0015-3-TH	□	0.15	0.75	50	3	E68	EMSBH0040-18-ATH	●	0.4	2	60	3	E74	EMSB0080-24-TH	□	0.8	4	60	4	E68	EMSB0080-24-TH	●	0.8	4	60	4	E68
EMSB0006-2.4-SD	□	0.06	0.3	40	3	E68	EMSB0015-4.5-SD	□	0.15	0.75	50	3	E68	EMSB0040-20-SD	□	0.4	2	60	3	E68	EMSB0080-35-SD	□	0.7	3.5	80	4	E68	EMSBH0080-8-ATH	●	0.8	4	60	4	E75
EMSB0006-2.4-TH	□	0.06	0.3	40	3	E68	EMSB0015-4.5-TH	●	0.15	0.75	50	3	E68	EMSB0040-20-TH	●	0.4	2	60	3	E68	EMSB0080-35-TH	●	0.7	3.5	80	4	E68	EMSBH0080-16-ATH	●	0.8	4	60	4	E75
EMSB0006-3-SD	□	0.06	0.3	40	3	E68	EMSB0015-7.5-SD	□	0.15	0.75	50	3	E68	EMSB0040-30-SD	□	0.4	2	75	3	E68	EMSB0070-52.5-SD	□	0.7	3.5	105	4	E68	EMSBH0080-24-ATH	●	0.8	4	60	4	E75
EMSB0006-3-TH	□	0.06	0.3	40	3	E68	EMSB0015-7.5-TH	●	0.15	0.75	50	3	E68	EMSB0040-30-TH	□	0.4	2	75	3	E68	EMSB0070-70-SD	□	0.7	3.5	105	4	E68	EMSBH0080-24-ATH	●	0.8	4	60	4	E75
EMST0007-TH	●	0.07	0.07	45	3	E72	EMSB0015-11.25-SD	□	0.15	0.75	50	3	E68	EMSB0040-40-SD	□	0.4	2	75	3	E68	EMSB0070-70-TH	□	0.7	3.5	105	4	E68	EMSBH0080-35-ATH	●	0.8	4	60	4	E75
EMSB0007-0.7-SD	□	0.07	0.35	40	3	E68	EMSB0015-11.25-TH	□	0.15	0.75	50	3	E68	EMSB0040-40-TH	□	0.4	2	75	3	E68	EMSB0080-80-SD	□	0.8	4	115	4	E68	EMSBH0080-35-ATH	●	0.8	4	60	4	E75
EMSB0007-0.7-TH	●	0.07	0.35	40	3	E68	EMSB0015-15-SD	□	0.15	0.75	50	3	E68	EMST0041-TH	□	0.41	0.41	45	3	E72	EMSB0080-80-TH	□	0.8	4	115	4	E68	EMSBH0080-40-SD	□	0.8	4	85	4	E68
EMSB0007-1.4-SD	□	0.07	0.35	40	3	E68	EMSB0015-15-TH	□	0.15	0.75	50	3	E68	EMSBH0041-4-ATH	□	0.41	2	50	3	E74	EMSB0080-80-TH	□	0.8	4	115	4	E68	EMSBH0080-40-TH	●	0.8	4	85	4	E68
EMSB0007-1.4-TH	□	0.07	0.35	40	3	E68	EMSB0015-15-TH	□	0.15	0.75	50	3	E68	EMSBH0041-8-ATH	□	0.41	2	50	3	E74	EMSB0080-80-TH	□	0.8	4	115	4	E68	EMSBH0080-40-TH	●	0.8	4	85	4	E68
EMSB0007-2.1-SD	□	0.07	0.35	40	3	E68	EMST0016-TH	●	0.16	0.16	45	3	E72	EMSBH0041-12-ATH	□	0.41	2	50	3	E74	EMSB0080-80-TH	□	0.8	4	115	4	E68	EMSBH0080-40-TH	●	0.8	4	85	4	E68
EMSB0007-2.1-TH	●	0.07	0.35	40	3	E68	EMST0017-TH	●	0.17	0.17	45	3	E72	EMSBH0042-4-ATH	□	0.42	2	50	3	E74	EMSB0080-80-TH	□	0.8	4	115	4	E68	EMSBH0080-40-TH	●	0.8	4	85	4	E68
EMSB0007-2.8-SD	□	0.07	0.35	40	3	E68	EMST0018-TH	●	0.18	0.18	45	3	E72	EMSBH0042-8-ATH	□	0.42	2	50	3	E74	EMSB0080-80-TH	□	0.8	4	115	4	E68	EMSBH0080-40-TH	●	0.8	4	85	4	E68
EMSB0007-2.8-TH	□	0.07	0.35	40	3	E68	EMST0019-TH	●	0.19	0.19	45	3	E72	EMSBH0042-12-ATH	□	0.42	2	50	3	E74	EMSB0080-80-TH	□	0.8	4	115	4	E68	EMSBH0080-40-TH	●	0.8	4	85	4	E68
EMSB0007-3.5-SD	□	0.07	0.35	40	3	E68	EMST0020-TH	●	0.2	0.2	45	3	E72	EMSBH0042-18-ATH	□	0.42	2	50	3	E74	EMSB0080-80-TH	□	0.8	4	115	4	E68	EMSBH0080-40-TH	●	0.8	4	85	4	E68
EMSB0007-3.5-TH	□	0.07	0.35	40	3	E68	EMSB0020-10-SD	□	0.2	1	45	3	E68	EMST0049-TH	□	0.49	0.49	45	3	E72	EMSB0080-80-TH	□	0.8	4	115	4	E68	EMSBH0080-40-TH	●	0.8	4	85		

単位 unit : mm

商品コード Item code	在庫 Stock	直径 Tool da.	溝長 Flute length	全長 Overall length	シャンク径 Shank dia.	ページ Page	商品コード Item code	在庫 Stock	直径 Tool da.	溝長 Flute length	全長 Overall length	シャンク径 Shank dia.	ページ Page	商品コード Item code	在庫 Stock	直径 Tool da.	溝長 Flute length	全長 Overall length	シャンク径 Shank dia.	ページ Page	商品コード Item code	在庫 Stock	直径 Tool da.	溝長 Flute length	全長 Overall length	シャンク径 Shank dia.	ページ Page
EMSBH0090-18-ATH	●	0.9	4.5	65	4	E75	05WHMB0110-TH	●	1.1	11	55	3	E63	03WHMB0132-TH	□	1.32	7	55	3	E63	10WHMB0152-TH	□	1.52	22	60	3	E64
EMSBH0090-27-ATH	●	0.9	4.5	65	4	E75	10WHMB0110-TH	●	1.1	17	55	3	E63	05WHMB0132-TH	□	1.32	14	55	3	E63	20WHMB0152-TH	□	1.52	37	75	3	E64
EMSB0090-45-SD	□	0.9	4.5	90	4	E68	15WHMB0110-TH	●	1.1	22	60	3	E63	10WHMB0132-TH	□	1.32	21	60	3	E63	30WHMB0152-TH	□	1.52	52	90	3	E64
EMSB0090-45-TH	●	0.9	4.5	90	4	E68	20WHMB0110-TH	●	1.1	26	65	3	E63	20WHMB0132-TH	□	1.32	33	70	3	E63	03WHMB0153-TH	□	1.53	8	55	3	E64
EMSB0090-67.5-SD	□	0.9	4.5	125	4	E68	25WHMB0110-TH	●	1.1	32	70	3	E63	30WHMB0132-TH	□	1.32	45	85	3	E63	05WHMB0153-TH	□	1.53	16	55	3	E64
EMSB0090-67.5-TH	□	0.9	4.5	125	4	E68	30WHMB0110-TH	●	1.1	37	75	3	E63	03WHMB0133-TH	□	1.33	7	55	3	E63	10WHMB0153-TH	□	1.53	22	60	3	E64
EMSB0090-90-SD	□	0.9	4.5	125	4	E68	03WHMB0111-TH	□	1.11	6	55	3	E63	05WHMB0133-TH	□	1.33	14	55	3	E63	20WHMB0153-TH	□	1.53	37	75	3	E64
EMSB0090-90-TH	□	0.9	4.5	125	4	E68	05WHMB0111-TH	□	1.11	11	55	3	E63	10WHMB0133-TH	□	1.33	21	60	3	E63	30WHMB0153-TH	□	1.53	52	90	3	E64
EMST0091-TH	□	0.91	0.91	45	4	E72	10WHMB0111-TH	□	1.11	18	60	3	E63	20WHMB0133-TH	□	1.33	33	70	3	E63	03WHMB0155-TH	●	1.55	8	55	3	E64
EMSBH0091-9-ATH	□	0.91	4.5	65	4	E75	20WHMB0111-TH	□	1.11	28	70	3	E63	30WHMB0133-TH	□	1.33	45	85	3	E63	05WHMB0155-TH	●	1.55	16	55	3	E64
EMSBH0091-18-ATH	□	0.91	4.5	65	4	E75	30WHMB0111-TH	□	1.11	38	75	3	E63	03WHMB0135-TH	●	1.35	7	55	3	E63	10WHMB0155-TH	●	1.55	22	60	3	E64
EMSBH0091-27-ATH	□	0.91	4.5	65	4	E75	03WHMB0112-TH	□	1.12	6	55	3	E63	05WHMB0135-TH	●	1.35	14	55	3	E63	15WHMB0155-TH	●	1.55	32	70	3	E64
EMSBH0092-9-ATH	□	0.92	4.5	65	4	E75	05WHMB0112-TH	□	1.12	11	55	3	E63	10WHMB0135-TH	●	1.35	21	60	3	E63	20WHMB0155-TH	●	1.55	37	75	3	E64
EMSBH0092-18-ATH	□	0.92	4.5	65	4	E75	10WHMB0112-TH	□	1.12	18	60	3	E63	15WHMB0135-TH	●	1.35	26	70	3	E63	25WHMB0155-TH	●	1.55	44	85	3	E64
EMSBH0092-27-ATH	□	0.92	4.5	65	4	E75	20WHMB0112-TH	□	1.12	28	70	3	E63	20WHMB0135-TH	●	1.35	33	70	3	E63	30WHMB0155-TH	●	1.55	52	90	3	E64
EMST0099-TH	□	0.99	0.99	45	4	E72	30WHMB0112-TH	□	1.12	38	75	3	E63	25WHMB0135-TH	●	1.35	37	75	3	E63	03WHMB0160-TH	●	1.6	8	55	3	E64
EMST0100-TH	●	1	1	45	4	E72	03WHMB0113-TH	□	1.13	6	55	3	E63	30WHMB0135-TH	●	1.35	45	85	3	E63	04WNSB0160-TH	●	1.6	12	50	3	E36
EMSB0100-10-SD	□	1	5	70	4	E68	05WHMB0113-TH	□	1.13	11	55	3	E63	03WHMB0140-TH	●	1.4	7	55	3	E64	05WHMB0160-TH	●	1.6	17	55	3	E64
EMSB0100-10-TH	●	1	5	70	4	E68	10WHMB0113-TH	□	1.13	18	60	3	E63	04WNSB0140-TH	●	1.4	10	50	3	E36	10WHMB0160-TH	●	1.6	26	65	3	E64
EMSB0100-20-SD	□	1	5	70	4	E68	20WHMB0113-TH	□	1.13	28	70	3	E63	05WHMB0140-TH	●	1.4	15	55	3	E64	15WHMB0160-TH	●	1.6	33	70	3	E64
EMSB0100-20-TH	□	1	5	70	4	E68	30WHMB0113-TH	□	1.13	38	75	3	E63	10WHMB0140-TH	●	1.4	22	60	3	E64	20WHMB0160-TH	●	1.6	37	75	3	E64
EMSB0100-30-SD	□	1	5	70	4	E68	03WHMB0115-TH	●	1.15	6	55	3	E63	15WHMB0140-TH	●	1.4	27	70	3	E64	25WHMB0160-TH	●	1.6	45	85	3	E64
EMSB0100-30-TH	●	1	5	70	4	E68	05WHMB0115-TH	●	1.15	11	55	3	E63	20WHMB0140-TH	●	1.4	33	70	3	E64	30WHMB0160-TH	●	1.6	53	90	3	E64
EMSBH0100-10-ATH	●	1	5	70	4	E75	10WHMB0115-TH	●	1.15	18	60	3	E63	25WHMB0140-TH	●	1.4	38	75	3	E64	03WHMB0161-TH	□	1.61	8	55	3	E64
EMSBH0100-20-ATH	●	1	5	70	4	E75	15WHMB0115-TH	●	1.15	23	60	3	E63	30WHMB0140-TH	●	1.4	47	85	3	E64	05WHMB0161-TH	□	1.61	17	55	3	E64
EMSBH0100-30-ATH	●	1	5	70	4	E75	20WHMB0115-TH	●	1.15	28	70	3	E63	03WHMB0141-TH	□	1.41	7	55	3	E64	10WHMB0161-TH	□	1.61	26	65	3	E64
EMSB0100-50-TH	●	1	5	100	4	E68	25WHMB0115-TH	●	1.15	33	70	3	E63	05WHMB0141-TH	□	1.41	15	55	3	E64	20WHMB0161-TH	□	1.61	38	75	3	E64
EMSB0100-50-SD	□	1	5	100	4	E68	30WHMB0115-TH	●	1.15	38	75	3	E63	10WHMB0141-TH	□	1.41	23	60	3	E64	30WHMB0161-TH	□	1.61	55	95	3	E64
EMSB0100-75-TH	□	1	5	135	4	E68	03WHMB0120-TH	●	1.2	6	55	3	E63	20WHMB0141-TH	□	1.41	35	75	3	E64	03WHMB0162-TH	□	1.62	8	55	3	E64
EMSB0100-100-TH	□	1	5	135	4	E68	04WNSB0120-TH	●	1.2	9	50	3	E36	30WHMB0141-TH	□	1.41	49	85	3	E64	05WHMB0162-TH	□	1.62	17	55	3	E64
EMSB0100-75-SD	□	1	5	135	4	E68	05WHMB0120-TH	●	1.2	12	55	3	E63	03WHMB0142-TH	□	1.42	7	55	3	E64	10WHMB0162-TH	□	1.62	26	65	3	E64
EMSB0100-100-SD	□	1	5	135	4	E68	10WHMB0120-TH	●	1.2	18	60	3	E63	05WHMB0142-TH	□	1.42	15	55	3	E64	20WHMB0162-TH	□	1.62	38	75	3	E64
03WHMB0100-TH	●	1	6	55	3	E63	15WHMB0120-TH	●	1.2	23	60	3	E63	10WHMB0142-TH	□	1.42	23	60	3	E64	30WHMB0162-TH	□	1.62	55	95	3	E64
04WNSB0100-TH	●	1	8	50	3	E36	20WHMB0120-TH	●	1.2	29	70	3	E63	20WHMB0142-TH	□	1.42	35	75	3	E64	03WHMB0163-TH	□	1.63	8	55	3	E64
05WHMB0100-TH	●	1	10	55	3	E63	25WHMB0120-TH	●	1.2	35	75	3	E63	30WHMB0142-TH	□	1.42	49	85	3	E64	05WHMB0163-TH	□	1.63	17	55	3	E64
10WHMB0100-TH	●	1	15	55	3	E63	30WHMB0120-TH	●	1.2	40	80	3	E63	03WHMB0143-TH	□	1.43	7	55	3	E64	10WHMB0163-TH	□	1.63	26	65	3	E64
15WHMB0100-TH	●	1	20	60	3	E63	03WHMB0121-TH	□	1.21	7	55	3	E63	05WHMB0143-TH	□	1.43	15	55	3	E64	20WHMB0163-TH	□	1.63	38	75	3	E64
20WHMB0100-TH	●	1	24	65	3	E63	05WHMB0121-TH	□	1.21	13	55	3	E63	10WHMB0143-TH	□	1.43	23	60	3	E64	30WHMB0163-TH	□	1.63	55	95	3	E64
25WHMB0100-TH	●	1	28	65	3	E63	10WHMB0121-TH	□	1.21	20	60	3	E63	20WHMB0143-TH	□	1.43	35	75	3	E64	03WHMB0165-TH	●	1.65	8	55	3	E64
30WHMB0100-TH	●	1	33	70	3	E63	20WHMB0121-TH	□	1.21	31	70	3	E63	30WHMB0143-TH	□	1.43	49	85	3	E64	05WHMB0165-TH	□	1.65	17	55	3	E64
EMST0101-TH	□	1.01	1.01	45	4	E72	30WHMB0121-TH	□	1.21	42	80	3	E63	03WHMB0145-TH	□	1.45	7	55	3	E64	10WHMB0165-TH	□	1.65	26	65	3	E64
EMSBH0101-10-ATH	□	1.01	5	70	4	E75	03WHMB0122-TH	□	1.22	7	55	3	E63	05WHMB0145-TH	●	1.45	15	55	3	E64	15WHMB0165-TH	●	1.65	33	70	3	E64
EMSBH0101-20-ATH	□	1.01	5	70	4	E75	05WHMB0122-TH	□	1.22	13	55	3	E63	10WHMB0145-TH	●	1.45	23	60	3	E64	20WHMB0165-TH	●	1.65	38	75	3	E64
EMSBH0101-30-ATH	□	1.01	5	70	4	E75	10WHMB0122-TH	□	1.22	20	60	3	E63	15WHMB0145-TH	●	1.45	30	70	3	E64	25WHMB0165-TH	●	1.65	46	90	3	E64
03WHMB0101-TH	□	1.01	6	55	3	E63	20WHMB0122-TH	□	1.22	31	70	3	E63	20WHMB0145-TH	□	1.45	35	75	3	E64	30WHMB0165-TH	□	1.65	55	95	3	E64
05WHMB0101-TH	□	1.01	10	55	3	E63	30WHMB0122-TH	□	1.22	42	80	3	E63	25WHMB0145-TH	●	1.45	42	80	3	E64	03WHMB0170-TH	●	1.7	8	55	3	E64
10WHMB0101-TH	□	1.01	16	55	3	E63	03WHMB0123-TH	□	1.23	7	55	3	E63	30WHMB0145-TH	●	1.45	49	85	3	E64	04WNSB0170-TH	●	1.7	14	50	3	E36
20WHMB0101-TH	□	1.01	25	65	3	E63	05WHMB0123-TH	□	1.23	13	55	3	E63	03WHMB0150-TH	□	1.5	8	55	3	E64	05WHMB0170-TH	●	1.7	18	55	3	E64
30WHMB0101-TH	□	1.01	35	75	3	E63	10WHMB0123-TH	□	1.23	20	60	3	E63	04WNSB0150-TH	●	1.5	12	50	3	E36	10WHMB0170-TH	●	1.7	27	65	3	E64
EMSBH0102-10-ATH	□	1.02	5	70	4	E75	20WHMB0123-TH	□	1.23	31	70	3	E63	EMSBH0150-15-ATH	●	1.5	15	70	4	E75	15WHMB0170-TH	●	1.7	34	70	3	E64
EMSBH0102-20-ATH	□	1.02	5	70	4	E75	30WHMB0123-TH	□	1.23	42	80	3	E63	EMSBH0150-30-ATH	●	1.5	15	70	4	E75	20WHMB0170-TH	●	1.7	40	80	3	E64
EMSBH0102-30-ATH	□	1.02	5	70	4	E75	03WHMB0125-TH	●	1.25	7	55	3	E63	EMSBH0150-45-ATH	●	1.5	15	100									

Quick dimension reference table by tool diameter

直径別寸法早見表

φ1.75~φ3.8

単位 unit : mm

商品コード Item code	在庫 Stock	直径 Tool dia.	溝長 Flute length	全長 Overall length	シャンク径 Shank dia.	ページ Page	商品コード Item code	在庫 Stock	直径 Tool dia.	溝長 Flute length	全長 Overall length	シャンク径 Shank dia.	ページ Page	商品コード Item code	在庫 Stock	直径 Tool dia.	溝長 Flute length	全長 Overall length	シャンク径 Shank dia.	ページ Page
15WHMB0175-TH	●	1.75	34	75	3	E64	05WHMB0200-TH	●	2	20	60	3	E25	NSBH0260-20-ATH	●	2.6	20	70	4	E49
20WHMB0175-TH	●	1.75	41	80	3	E64	05WHNSB0200-TH	●	2	20	66	3	E61	05WHNSB0260-TH	●	2.6	29	79	3	E21
25WHMB0175-TH	●	1.75	50	90	3	E64	05WHNSB0200-SD	●	2	20	66	3	E46	05WHNSB0260-SD	●	2.6	29	79	3	E46
30WHMB0175-TH	●	1.75	58	95	3	E64	NSBH0200-20-ATH	●	2	20	70	4	E49	08WHNSB0260-TH	●	2.6	33	80	3	E23
03WHMB0180-TH	●	1.8	10	55	3	E65	EMSBH0200-20-ATH	●	2	20	70	4	E75	10WHNSB0260-TH	●	2.6	35	85	3	E25
04WHNSB0180-TH	●	1.8	14	50	3	E36	EMSBH0200-40-ATH	●	2	20	100	4	E75	NSBH0260-40-ATH	□	2.6	40	90	4	E49
05WHMB0180-TH	●	1.8	19	60	3	E66	EMSBH0200-60-ATH	●	2	20	100	4	E75	05WHNSB0260-SD	●	2.6	29	79	3	E46
10WHMB0180-TH	●	1.8	28	65	3	E65	08WHNSB0200-TH	●	2	25	75	3	E23	08WHNSB0260-TH	●	2.6	33	80	3	E23
15WHMB0180-TH	●	1.8	36	75	3	E65	10WHMB0200-TH	●	2	30	70	3	E65	10WHNSB0260-TH	●	2.6	35	85	3	E25
20WHMB0180-TH	●	1.8	43	80	3	E65	10WHNSB0200-TH	●	2	30	80	3	E25	10WHNSB0260-TH	●	2.6	35	85	3	E25
25WHMB0180-TH	●	1.8	51	90	3	E65	15WHNSB0200-TH	●	2	40	83	3	E26	15WHNSB0260-TH	●	2.6	54	102	3	E29
30WHMB0180-TH	●	1.8	60	100	3	E65	NSBH0200-40-ATH	●	2	40	90	4	E49	NSBH0260-60-ATH	□	2.6	60	110	4	E49
03WHMB0181-TH	□	1.81	10	55	3	E65	15WHMB0200-TH	●	2	41	80	3	E65	20WHNSB0260-TH	●	2.6	67	110	3	E27
05WHMB0181-TH	□	1.81	20	60	3	E65	20WHMB0200-TH	●	2	47	85	3	E65	20WHNSB0260-TH	●	2.6	67	110	3	E27
10WHMB0181-TH	□	1.81	29	70	3	E65	20WHNSB0200-TH	●	2	50	93	3	E27	25WHNSB0260-TH	●	2.6	76	119	3	E28
20WHMB0181-TH	□	1.81	45	85	3	E65	25WHMB0200-TH	●	2	57	95	3	E65	30WHNSB0260-TH	●	2.6	94	137	3	E29
30WHMB0181-TH	□	1.81	61	100	3	E65	25WHNSB0200-TH	●	2	57	100	3	E28	40WHNSB0260-TH	□	2.6	117	168	3	E31
03WHMB0182-TH	□	1.82	10	55	3	E65	NSBH0200-60-ATH	●	2	60	110	4	E49	50WHNSB0260-TH	□	2.6	144	195	3	E32
05WHMB0182-TH	□	1.82	20	60	3	E65	30WHMB0200-TH	●	2	67	105	3	E29	03WHNSB0263-TH	●	2.63	19	69	3	E20
10WHMB0182-TH	□	1.82	29	70	3	E65	30WHNSB0200-TH	●	2	70	113	3	E65	03WHNSB0263-TH	□	2.7	10	50	4	E85
20WHMB0182-TH	□	1.82	45	85	3	E65	03WHMB0201-TH	□	2.01	10	55	3	E65	NSBH0270-10-ATH	●	2.7	10	60	4	E49
30WHMB0182-TH	□	1.82	61	100	3	E65	EMSBH0201-20-ATH	□	2.01	20	70	4	E75	ZPBL0270-TH	□	2.7	10	80	4	E87
03WHMB0183-TH	□	1.83	10	55	3	E65	EMSBH0201-40-ATH	□	2.01	20	100	4	E75	04WHNSB0270-TH	●	2.7	19	50	3	E36
05WHMB0183-TH	□	1.83	20	60	3	E65	EMSBH0201-60-ATH	□	2.01	20	100	4	E75	05WHNSB0270-SD	●	2.3	24	74	3	E46
10WHMB0183-TH	□	1.83	29	70	3	E65	05WHMB0201-TH	□	2.01	21	60	3	E65	08WHNSB0270-TH	●	2.3	28	75	3	E23
20WHMB0183-TH	□	1.83	45	85	3	E65	10WHMB0201-TH	□	2.01	31	70	3	E65	10WHNSB0270-TH	●	2.3	33	80	3	E25
30WHMB0183-TH	□	1.83	61	100	3	E65	20WHMB0201-TH	□	2.01	49	90	3	E65	NSBH0230-40-ATH	□	2.3	40	90	4	E49
03WHMB0185-TH	●	1.85	10	55	3	E65	30WHMB0201-TH	□	2.01	69	110	3	E65	15WHNSB0270-TH	●	2.3	50	93	3	E26
05WHMB0185-TH	●	1.85	20	60	3	E65	03WHMB0202-TH	□	2.02	10	55	3	E65	NSBH0230-60-ATH	□	2.3	60	110	4	E49
10WHMB0185-TH	●	1.85	29	70	3	E65	EMSBH0202-20-ATH	□	2.02	20	70	4	E75	20WHNSB0270-TH	●	2.3	62	105	3	E27
15WHMB0185-TH	●	1.85	38	75	3	E65	EMSBH0202-40-ATH	□	2.02	20	100	4	E75	25WHNSB0270-TH	●	2.3	71	114	3	E28
20WHMB0185-TH	●	1.85	45	85	3	E65	EMSBH0202-60-ATH	□	2.02	20	100	4	E75	30WHNSB0270-TH	●	2.3	87	130	3	E29
25WHMB0185-TH	●	1.85	53	90	3	E65	05WHMB0202-TH	□	2.02	21	60	3	E65	03WHNSB0233-TH	●	2.33	19	69	3	E20
30WHMB0185-TH	●	1.85	61	100	3	E65	10WHMB0202-TH	□	2.02	31	70	3	E65	ZPBL0240-TH	□	2.4	8	50	4	E85
03WHMB0190-TH	●	1.9	10	55	3	E65	20WHMB0202-TH	□	2.02	49	90	3	E65	ZPBL0240-TH	□	2.4	8	50	4	E87
04WHNSB0190-TH	●	1.9	16	50	3	E36	30WHMB0202-TH	□	2.02	69	110	3	E65	04WHNSB0240-TH	●	2.4	17	50	3	E36
05WHMB0190-TH	●	1.9	20	60	3	E65	03WHMB0203-TH	□	2.03	10	55	3	E65	EHSE2.4-TH	●	2.4	17	50	3	E80
10WHMB0190-TH	●	1.9	29	70	3	E65	03WHNSB0203-TH	□	2.03	16	69	3	E20	03WHNSB0240-TH	●	2.4	19	69	3	E20
15WHMB0190-TH	●	1.9	39	75	3	E65	05WHMB0203-TH	□	2.03	21	60	3	E65	NSBH0240-20-ATH	□	2.4	20	70	4	E49
20WHMB0190-TH	●	1.9	45	85	3	E65	05WHNSB0203-SD	●	2.03	24	74	3	E46	NSBH0240-40-ATH	□	2.4	20	70	4	E49
25WHMB0190-TH	●	1.9	55	95	3	E65	10WHMB0203-TH	□	2.03	31	70	3	E65	04WHNSB0240-TH	●	2.4	17	50	3	E36
30WHMB0190-TH	●	1.9	63	100	3	E65	20WHMB0203-TH	□	2.03	49	90	3	E65	EHSE2.4-TH	●	2.4	17	50	3	E80
03WHMB0191-TH	□	1.91	10	55	3	E65	30WHMB0203-TH	□	2.03	69	110	3	E65	03WHNSB0240-TH	●	2.4	19	69	3	E20
05WHMB0191-TH	□	1.91	20	60	3	E65	ZPBL0210-TH	□	2.1	8	50	4	E85	NSBH0240-60-ATH	□	2.4	60	110	4	E49
10WHMB0191-TH	□	1.91	30	70	3	E65	ZPBL0210-TH	□	2.1	8	50	4	E87	20WHNSB0240-TH	●	2.4	62	105	3	E27
20WHMB0191-TH	□	1.91	47	85	3	E65	NSBH0210-10-ATH	□	2.1	10	60	4	E87	25WHNSB0240-TH	●	2.4	71	114	3	E28
30WHMB0191-TH	□	1.91	65	105	3	E65	EHSE2.1-TH	●	2.1	15	50	3	E40	30WHNSB0240-TH	●	2.4	87	130	3	E29
03WHMB0192-TH	□	1.92	10	55	3	E65	04WHNSB0210-TH	●	2.1	17	50	3	E36	03WHNSB0243-TH	●	2.43	19	69	3	E20
05WHMB0192-TH	□	1.92	20	60	3	E65	03WHNSB0210-TH	●	2.1	17	69	3	E20	ZPBL0250-TH	□	2.5	10	50	4	E85
10WHMB0192-TH	□	1.92	30	70	3	E65	NSBH0210-20-ATH	□	2.1	20	70	4	E49	NSBH0250-10-ATH	□	2.5	10	60	4	E49
20WHMB0192-TH	□	1.92	47	85	3	E65	05WHNSB0210-TH	●	2.1	24	74	3	E21	ZPBL0250-TH	□	2.5	10	80	4	E87
30WHMB0192-TH	□	1.92	65	105	3	E65	05WHNSB0210-SD	●	2.1	24	74	3	E46	04WHNSB0250-TH	●	2.5	17	50	3	E36
03WHMB0193-TH	□	1.93	10	55	3	E65	08WHNSB0210-TH	●	2.1	25	75	3	E23	EHSE2.5-TH	●	2.5	17	55	3	E80
05WHMB0193-TH	□	1.93	20	60	3	E65	10WHNSB0210-TH	●	2.1	30	80	3	E25	03WHNSB0250-TH	●	2.5	19	69	3	E20
10WHMB0193-TH	□	1.93	30	70	3	E65	NSBH0210-40-ATH	□	2.1	40	90	4	E49	NSBH0250-20-ATH	□	2.5	20	70	4	E49
20WHMB0193-TH	□	1.93	47	85	3	E65	15WHNSB0210-TH	●	2.1	44	87	3	E26	05WHNSB0250-TH	●	2.5	24	74	3	E21
30WHMB0193-TH	□	1.93	65	105	3	E65	20WHNSB0210-TH	●	2.1	55	98	3	E27	05WHNSB0250-SD	●	2.5	24	74	3	E46
03WHMB0195-TH	●	1.95	10	55	3	E65	NSBH0210-60-ATH	□	2.1	60	110	4	E49	08WHNSB0250-TH	●	2.5	28	75	3	E23
05WHMB0195-TH	●	1.95	20	60	3	E65	25WHNSB0210-TH	●	2.1	62	105	3	E28	10WHNSB0250-TH	●	2.5	33	80	3	E25
10WHMB0195-TH	●	1.95	30	70	3	E65	30WHNSB0210-TH	●	2.1	77	120	3	E29	NSBH0250-40-ATH	□	2.5	40	90	4	E49
15WHMB0195-TH	●	1.95	41	80	3	E65	03WHNSB0213-TH	●	2.13	17	69	3	E20	15WHNSB0250-TH	●	2.5	50	93	3	E26
20WHMB0195-TH	●	1.95	47	85	3	E65	ZPBL0220-TH	□	2.2	8	50	4	E85	NSBH0250-60-ATH	□	2.5	60	110	4	E49
25WHMB0195-TH	●	1.95	56	95	3	E65	ZPBL0220-TH	□	2.2	8	50	4	E87	20WHNSB0250-TH	●	2.5	62	105	3	E27
30WHMB0195-TH	●	1.95	65	105	3	E65	NSBH0220-10-ATH	□	2.2	10	60	4	E49	25WHNSB0250-TH	●	2.5	71	114	3	E28
ZPBL0200-TH	□	2	8	80	4	E87	EHSE2.2-TH	●	2.2	16	50	3	E40	30WHNSB0250-TH	●	2.5	87	130	3	E29
ZPBL0200-TH	□	2	8	80	4	E87	04WHNSB0220-TH	●	2.2	17	50	3	E36	40WHNSB0250-TH	◎	2.5	108	159	3	E31
03WHMB0200-TH	●	2	10	55	3	E65	03WHNSB0220-TH	●	2.2	17	69	3	E20	50WHNSB0250-TH	□	2.5	133	184	3	E32
NSBH0200-10-ATH	●	2	10	60	4	E49	NSBH0220-20-ATH	□	2.2	20	70	4	E49	03WHNSB0253-TH	●	2.53	19	69	3	E20

単位 unit : mm

商品コード Item code	在庫 Stock	直径 Tool dia.	溝長 Flute length	全長 Overall length	シャンク 径 Shank dia.	ページ Page	商品コード Item code	在庫 Stock	直径 Tool dia.	溝長 Flute length	全長 Overall length	シャンク 径 Shank dia.	ページ Page	商品コード Item code	在庫 Stock	直径 Tool dia.	溝長 Flute length	全長 Overall length	シャンク 径 Shank dia.	ページ Page	商品コード Item code	在庫 Stock	直径 Tool dia.	溝長 Flute length	全長 Overall length	シャンク 径 Shank dia.	ページ Page
40WHNSB0290-TH	□	2.9	129	180	3	E31	ZPB0320-TH	□	3.2	12	50	4	E85	STBH034M-ATH	●	3.4	30	80	6	E82	10WHNSB0360-TH	●	3.6	52	101	4	E25
50WHNSB0290-TH	□	2.9	159	210	3	E32	ZPBL0320-TH	□	3.2	12	100	6	E87	STB034M-ATH	●	3.4	30	80	6	E83	10FWHNSB0360-TH	□	3.6	52	101	4	E40
03WHNSB0293-TH	●	2.93	19	69	3	E20	EWSS3.2	□	3.2	18	49	4	E90	05WHNSB0340-TH	●	3.4	37	87	4	E21	NSBH0360-60-ATH	□	3.6	60	110	4	E49
ZPB0300-TH	●	3	12	50	4	E85	02WNSB0320-TH	□	3.2	18	52	4	E35	05FWHNSB0340-TH	●	3.4	37	87	4	E39	15WHNSB0360-TH	●	3.6	72	121	4	E26
ZPBL0300-TH	□	3	12	100	6	E87	NSBH0320-20-ATH	●	3.2	20	70	4	E49	05WHNSB0340-SD	□	3.4	37	87	4	E46	15FWHNSB0360-TH	□	3.6	72	121	4	E41
02WNSB0300-TH	□	3	15	47	3	E35	04WNSB0320-TH	●	3.2	23	58	4	E36	NSBH0340-40-ATH	●	3.4	40	90	4	E49	NSBH0360-90-ATH	□	3.6	90	140	4	E49
EWSS3.0	□	3	16	46	3	E90	03WHNSB0320-TH	●	3.2	23	73	4	E20	08WHNSB0340-TH	●	3.4	42	94	4	E23	20WHNSB0360-TH	●	3.6	92	141	4	E27
04WNSB0300-TH	●	3	19	50	3	E36	03FWHNSB0320-TH	□	3.2	23	73	4	E38	10WHNSB0340-TH	●	3.4	46	94	4	E25	20FWHNSB0360-TH	□	3.6	92	141	4	E42
03WHNSB0300-TH	●	3	19	69	3	E20	03WHNSB0320-SD	□	3.2	23	73	4	E45	10FWHNSB0340-TH	□	3.4	46	94	4	E40	25WHNSB0360-TH	●	3.6	113	162	4	E28
03FWHNSB0300-TH	□	3	19	69	3	E38	EWSR3.2	□	3.2	24	60	3.2	E91	NSBH0340-60-ATH	□	3.4	60	110	4	E49	NSBH0360-120-ATH	□	3.6	120	170	4	E49
03WHNSB0300-SD	●	3	19	69	3	E45	EHSE3.2-TH	●	3.2	24	60	4	E80	15WHNSB0340-TH	●	3.4	63	111	4	E26	30WHNSB0360-TH	●	3.6	132	181	4	E29
NSBH0300-20-ATH	●	3	20	70	4	E49	05WHNSB0320-TH	●	3.2	37	87	4	E21	15FWHNSB0340-TH	□	3.4	63	111	4	E41	30FWHNSB0360-TH	□	3.6	132	181	4	E43
EHSE3.0-TH	●	3	21	60	3	E80	05FWHNSB0320-TH	●	3.2	37	87	4	E39	20WHNSB0340-TH	●	3.4	81	129	4	E27	40WHNSB0360-TH	□	3.6	155	208	4	E31
EWSR3.0	□	3	21	60	3	E91	05WHNSB0320-SD	□	3.2	37	87	4	E46	20FWHNSB0340-TH	□	3.4	81	129	4	E42	50WHNSB0360-TH	□	3.6	191	244	4	E32
05WHNSB0300-TH	●	3	29	79	3	E21	NSBH0320-40-ATH	●	3.2	40	90	4	E49	NSBH0340-90-ATH	□	3.4	90	140	4	E49	ZPB0370-TH	□	3.7	14	50	4	E85
05FWHNSB0300-TH	●	3	29	79	3	E39	08WHNSB0320-TH	●	3.2	42	94	4	E23	25WHNSB0340-TH	●	3.4	98	146	4	E28	ZPBL0370-TH	□	3.7	14	100	6	E87
05WHNSB0300-SD	●	3	29	79	3	E46	10WHNSB0320-TH	●	3.2	46	94	4	E25	30WHNSB0340-TH	●	3.4	116	164	4	E29	02WNSB0370-TH	□	3.7	20	52	4	E35
08WHNSB0300-TH	●	3	35	83	3	E23	10FWHNSB0320-TH	□	3.2	46	94	4	E40	30FWHNSB0340-TH	□	3.4	116	164	4	E43	EWSS3.7	□	3.7	20	52	4	E90
08WHSR0300-ATH	●	3	37	85	4	E56	NSBH0320-60-ATH	□	3.2	60	110	4	E49	40WHNSB0340-TH	□	3.4	155	208	4	E31	03WH0370-20-ATH	□	3.7	20	70	4	E49
10WHNSB0300-TH	●	3	39	87	3	E25	15WHNSB0320-TH	●	3.2	63	111	4	E26	50WHNSB0340-TH	□	3.4	191	244	4	E32	NSBH0370-30-TH	●	3.7	23	73	4	E20
10FWHNSB0300-TH	●	3	39	87	3	E40	15FWHNSB0320-TH	□	3.2	63	111	4	E41	ZPB0350-TH	□	3.5	14	50	4	E85	03FWHNSB0370-TH	□	3.7	23	73	4	E38
NSBH0300-40-ATH	●	3	40	90	4	E49	20WHNSB0320-TH	●	3.2	81	129	4	E27	ZPBL0350-TH	□	3.5	14	100	6	E87	03WHNSB0370-SD	□	3.7	23	73	4	E45
15WHNSB0300-TH	●	3	54	102	3	E26	20FWHNSB0320-TH	□	3.2	81	129	4	E42	02WNSB0350-TH	□	3.5	18	52	4	E35	04WHNSB0370-TH	●	3.7	26	58	4	E36
15FWHNSB0300-TH	●	3	54	102	3	E41	25WHNSB0320-TH	●	3.2	90	138	4	E28	EWSS3.5	□	3.5	20	52	4	E90	EWSR3.7	□	3.7	27	60	3.7	E91
15WHNSB0300-SD	●	3	54	102	3	E47	NSBH0320-90-ATH	□	3.2	90	140	4	E49	NSBH0350-20-ATH	□	3.5	20	70	4	E49	EHSE3.7-TH	●	3.7	27	60	4	E80
NSBH0300-60-ATH	●	3	60	110	4	E49	30WHNSB0320-TH	●	3.2	116	164	4	E29	04WNSB0350-TH	●	3.5	23	58	4	E36	05WHNSB0370-TH	●	3.7	37	87	4	E21
20WHNSB0300-TH	●	3	69	117	3	E27	30FWHNSB0320-TH	□	3.2	116	164	4	E43	03WHNSB0350-TH	●	3.5	23	73	4	E20	05FWHNSB0370-TH	□	3.7	37	87	4	E39
20FWHNSB0300-TH	●	3	69	117	3	E42	40WHNSB0320-TH	□	3.2	142	195	4	E31	03FWHNSB0350-TH	□	3.5	23	73	4	E38	05WHNSB0370-SD	□	3.7	37	87	4	E46
20WHNSB0300-SD	●	3	69	117	3	E47	50WHNSB0320-TH	□	3.2	175	228	4	E32	03WHNSB0350-SD	□	3.5	23	73	4	E45	NSBH0370-40-ATH	□	3.7	40	90	4	E49
20WHSR0300-ATH	●	3	71	119	4	E56	ZPB0330-TH	□	3.3	14	50	4	E85	EWSR3.5	□	3.5	24	60	3.5	E91	08WHNSB0370-TH	●	3.7	46	94	4	E23
25WHNSB0300-TH	●	3	84	132	3	E28	ZPBL0330-TH	□	3.3	14	100	6	E87	EHSE3.5-TH	●	3.5	24	60	4	E80	10WHNSB0370-TH	□	3.7	52	101	4	E25
25WHNSB0300-SD	●	3	84	132	3	E47	EWSS3.3	□	3.3	18	49	4	E90	05WHNSB0350-TH	●	3.5	37	87	4	E21	10FWHNSB0370-TH	□	3.7	52	101	4	E40
NSBH0300-90-ATH	●	3	90	140	4	E49	02WNSB0330-TH	□	3.3	18	52	4	E35	05FWHNSB0350-TH	●	3.5	37	87	4	E39	30FWHNSB0370-TH	□	3.7	60	110	4	E49
30WHNSB0300-TH	●	3	99	147	3	E29	NSBH0330-20-ATH	●	3.3	20	70	4	E49	05WHNSB0350-SD	□	3.5	37	87	4	E46	15WHNSB0370-TH	●	3.7	72	121	4	E26
30FWHNSB0300-TH	●	3	99	147	3	E43	04WNSB0330-TH	●	3.3	23	58	4	E36	NSBH0350-40-ATH	□	3.5	40	90	4	E49	15FWHNSB0370-TH	□	3.7	72	121	4	E41
30WHNSB0300-SD	●	3	99	147	3	E47	03WHNSB0330-TH	●	3.3	23	73	4	E20	08WHNSB0350-TH	●	3.5	42	94	4	E23	NSBH0370-90-ATH	□	3.7	90	140	4	E49
30WHSR0300-ATH	●	3	101	149	4	E56	03FWHNSB0330-TH	□	3.3	23	73	4	E38	10WHNSB0350-TH	●	3.5	46	94	4	E25	20WHNSB0370-TH	●	3.7	92	141	4	E27
40WHNSB0300-TH	○	3	129	180	3	E31	03WHNSB0330-SD	□	3.3	23	73	4	E45	10FWHNSB0350-TH	□	3.5	46	94	4	E40	20FWHNSB0370-TH	□	3.7	92	141	4	E42
50WHNSB0300-TH	○	3	159	210	3	E32	EWSR3.3	□	3.3	24	60	3.3	E91	NSBH0350-60-ATH	□	3.5	60	110	4	E49	25WHNSB0370-TH	●	3.7	113	162	4	E28
03WHNSB0303-SD	●	3.03	23	73	4	E45	EHSE3.3-TH	●	3.3	24	60	4	E80	15WHNSB0350-TH	●	3.5	63	111	4	E26	NSBH0370-120-ATH	□	3.7	120	170	4	E49
05WHNSB0303-SD	●	3.03	37	87	4	E46	05WHNSB0330-TH	●	3.3	37	87	4	E21	15WHNSB0350-TH	□	3.5	63	111	4	E41	30WHNSB0370-TH	●	3.7	132	181	4	E29
03WHNSB0305-TH	●	3.05	23	73	4	E20	05FWHNSB0330-TH	●	3.3	37	87	4	E39	05FWHNSB0350-SD	□	3.5	63	111	4	E47	30FWHNSB0370-TH	□	3.7	132	181	4	E43
ZPB0310-TH	□	3.1	12	50	4	E85	05WHNSB0330-SD	□	3.3	37	87	4	E46	20WHNSB0350-TH	●	3.5	81	129	4	E27	40WHNSB0370-TH	□	3.7	172	225	4	E31
ZPBL0310-TH	□	3.1	12	100	6	E87	NSBH0330-40-ATH	●	3.3	40	90	4	E49	20FWHNSB0350-TH	□	3.5	81	129	4	E42	50WHNSB0370-TH	□	3.7	212	265	4	E32
EWSS3.1	□	3.1	18	49	4	E90	08WHNSB0330-TH	●	3.3	42	94	4	E23	20WHNSB0350-SD	□	3.5	81	129	4	E47	ZPB0380-TH	□	3.8	16	50	4	E85
02WNSB0310-TH	□	3.1	18	52	4	E35	10WHNSB0330-TH	●	3.3	46	94	4	E25	NSBH0350-90-ATH	□	3.5	90	140	4	E49	ZPBL0380-TH	□	3.8	16	100	6	E87
NSBH0310-20-ATH	□	3.1	20	70	4	E49	10FWHNSB0330-TH	□	3.3	46	94	4	E40	25WHNSB0350-TH	●	3.5	98	146	4	E28	02WNSB0380-TH	□	3.8	20	52	4	E35
04WNSB0310-TH	●	3.1	23	58	4	E36	NSBH0330-60-ATH	□	3.3	60	110	4	E49	25WHNSB0350-SD	□	3.5	98	146	4	E47	NSBH0380-20-ATH	□	3.8	20	70	4	E49
03WHNSB0310-TH	●	3.1	23	73	4	E20	15WHNSB0330-TH	●	3.3	63	111	4	E26	30WHNSB0350-TH	●	3.5	116	164	4	E29	EWSS3.8	□	3.8	22	55	4	E90
03FWHNSB0310-TH	□	3.1	23	73	4	E38	15FWHNSB0330-TH	□	3.3	63	111	4	E41	30FWHNSB0350-TH	□	3.5	116	164	4	E43	03WHNSB0380-TH	●	3.8	23	73	4	E20
03WHNSB0310-SD	□	3.1	23	73	4	E45	20WHNSB0330-TH	●	3.3	81	129	4	E27	40WHNSB0350-TH	□	3.5	155	208	4	E31	03FWHNSB0380-TH	□	3.8	23	73	4	E38
EWSR3.1	□	3.1	24	60	3.1	E91	20FWHNSB0330-TH	□	3.																		

Quick dimension reference table by tool diameter

直径別寸法早見表

φ3.8~φ5.6

単位 unit : mm

商品コード Item code	在庫 Stock	直径 Tool dia.	溝長 Flute length	全長 Overall length	シャンク径 Shank dia.	ページ Page	商品コード Item code	在庫 Stock	直径 Tool dia.	溝長 Flute length	全長 Overall length	シャンク径 Shank dia.	ページ Page	商品コード Item code	在庫 Stock	直径 Tool dia.	溝長 Flute length	全長 Overall length	シャンク径 Shank dia.	ページ Page	商品コード Item code	在庫 Stock	直径 Tool dia.	溝長 Flute length	全長 Overall length	シャンク径 Shank dia.	ページ Page
30FWHNSB0380-TH	□	3.8	132	181	4	E43	05WHNSB0403-SD	●	4.03	47	100	5	E46	03FWHNSB0430-TH	□	4.3	29	82	5	E38	10WHNSB0450-TH	●	4.5	59	110	5	E25
40WHNSB0380-TH	□	3.8	172	225	4	E31	03WHNSB0405-TH	●	4.05	29	82	5	E40	03WHNSB0430-SD	□	4.3	29	82	5	E45	10FWHNSB0450-TH	□	4.5	59	110	5	E40
50WHNSB0380-TH	□	3.8	212	265	4	E32	ZPB0410-TH	□	4.1	16	50	6	E85	STBH043S-ATH	●	4.3	30	85	7	E82	NSBH0450-60-ATH	□	4.5	60	110	6	E49
ZPB0390-TH	□	3.9	16	50	4	E85	ZPBL0410-TH	□	4.1	16	100	6	E87	STB043S-ATH	●	4.3	30	85	7	E83	15WHNSB0450-TH	●	4.5	81	132	5	E26
ZPBL0390-TH	□	3.9	16	100	6	E87	NSBH0410-20-ATH	●	4.1	20	70	6	E49	STBH043M-ATH	●	4.3	35	85	7	E82	15FWHNSB0450-TH	□	4.5	81	132	5	E41
02WHNSB0390-TH	□	3.9	20	52	4	E35	EWSS4.1	□	4.1	22	55	5	E90	STB043M-ATH	●	4.3	35	85	7	E83	15WHNSB0450-SD	□	4.5	81	132	5	E47
NSBH0390-20-ATH	□	3.9	20	70	4	E49	02WHNSB0410-TH	□	4.1	23	59	5	E35	NSBH0430-40-ATH	●	4.3	40	90	6	E49	NSBH0450-90-ATH	□	4.5	90	140	6	E49
EWSS3.9	□	3.9	22	55	4	E90	EWSS4.1	□	4.1	29	63	4.1	E91	05WHNSB0430-TH	●	4.3	47	100	5	E21	20WHNSB0450-TH	●	4.5	104	155	5	E27
03WHNSB0390-TH	●	3.9	23	73	4	E20	EHSE4.1-TH	●	4.1	29	63	5	E80	05FWHNSB0430-TH	●	4.3	47	100	5	E39	20FWHNSB0450-TH	□	4.5	104	155	5	E42
03FWHNSB0390-TH	□	3.9	23	73	4	E38	04WNSB0410-TH	●	4.1	29	64	5	E36	05WHNSB0430-SD	□	4.3	47	100	5	E46	20WHNSB0450-SD	□	4.5	104	155	5	E47
03WHNSB0390-SD	□	3.9	23	73	4	E45	03WHNSB0410-TH	●	4.1	29	82	5	E23	08WHNSB0430-TH	●	4.3	55	110	5	E23	NSBH0450-120-ATH	□	4.5	120	170	6	E49
04WNSB0390-TH	●	3.9	26	58	4	E36	03FWHNSB0410-TH	□	4.1	29	82	5	E38	10WHNSB0430-TH	●	4.3	59	110	5	E25	25WHNSB0450-TH	●	4.5	127	178	5	E28
EWSS3.9	□	3.9	27	60	3.9	E91	03WHNSB0410-SD	□	4.1	29	82	5	E45	10FWHNSB0430-TH	□	4.3	59	110	5	E40	25WHNSB0450-SD	□	4.5	127	178	5	E47
EHSE3.9-TH	●	3.9	27	60	4	E81	NSBH0410-40-ATH	□	4.1	40	90	6	E49	NSBH0430-60-ATH	□	4.3	60	110	6	E49	30WHNSB0450-TH	●	4.5	149	200	5	E29
05WHNSB0390-TH	□	3.9	37	87	4	E20	05WHNSB0410-TH	●	4.1	47	100	5	E41	15WHNSB0430-TH	□	4.3	81	132	5	E26	30FWHNSB0450-TH	□	4.5	149	200	5	E43
05FWHNSB0390-TH	●	3.9	37	87	4	E39	05FWHNSB0410-TH	●	4.1	47	100	5	E39	NSBH0430-90-ATH	□	4.3	81	132	5	E41	30WHNSB0450-SD	□	4.5	149	200	5	E47
05WHNSB0390-SD	□	3.9	37	87	4	E46	05WHNSB0410-SD	●	4.1	47	100	5	E46	20WHNSB0430-TH	●	4.3	104	155	5	E27	40WHNSB0450-TH	□	4.5	198	251	5	E31
NSBH0390-40-ATH	□	3.9	40	90	4	E49	08WHNSB0410-TH	●	4.1	55	110	5	E23	20FWHNSB0430-TH	□	4.3	104	155	5	E42	50WHNSB0450-TH	□	4.5	244	297	5	E32
08WHNSB0390-TH	●	3.9	46	94	4	E23	10WHNSB0410-TH	●	4.1	59	110	5	E25	20FWHNSB0430-SD	□	4.3	104	155	5	E49	03WHNSB0453-SD	□	4.53	29	82	5	E45
10WHNSB0390-TH	●	3.9	52	101	4	E25	10FWHNSB0410-TH	□	4.1	59	110	5	E40	NSBH0430-120-ATH	□	4.3	120	170	6	E49	05WHNSB0453-SD	●	4.53	47	100	5	E46
10FWHNSB0390-TH	□	3.9	52	101	4	E40	NSBH0410-60-ATH	□	4.1	60	110	6	E49	25WHNSB0430-TH	●	4.3	127	178	5	E28	ZPB0460-TH	□	4.6	18	50	6	E85
NSBH0390-60-ATH	□	3.9	60	110	4	E49	15WHNSB0410-TH	●	4.1	81	132	5	E26	30WHNSB0430-TH	●	4.3	149	200	5	E29	ZPBL0460-TH	□	4.6	18	100	6	E87
15WHNSB0390-TH	□	3.9	72	121	4	E26	15FWHNSB0410-TH	□	4.1	81	132	5	E41	30FWHNSB0430-TH	□	4.3	149	200	5	E43	NSBH0460-20-ATH	□	4.6	20	70	6	E49
15FWHNSB0390-TH	□	3.9	72	121	4	E41	NSBH0410-90-ATH	□	4.1	90	140	6	E49	40WHNSB0430-TH	□	4.3	185	238	5	E31	EWSS4.6	□	4.6	24	58	5	E90
NSBH0390-90-ATH	□	3.9	90	140	4	E49	20WHNSB0410-TH	●	4.1	104	155	5	E27	50WHNSB0430-TH	□	4.3	228	281	5	E32	02WNSB0460-TH	□	4.6	25	59	5	E35
20WHNSB0390-TH	●	3.9	92	141	4	E27	20FWHNSB0410-TH	□	4.1	104	155	5	E42	ZPB0440-TH	□	4.4	18	50	6	E85	03WHNSB0460-TH	●	4.6	29	82	5	E20
20FWHNSB0390-TH	□	3.9	92	141	4	E42	NSBH0410-120-ATH	□	4.1	120	170	6	E49	ZPBL0440-TH	□	4.4	18	100	6	E87	03FWHNSB0460-TH	□	4.6	29	82	5	E38
25WHNSB0390-TH	□	3.9	113	162	4	E28	25WHNSB0410-TH	●	4.1	127	178	5	E28	NSBH0440-20-ATH	□	4.4	20	70	6	E49	03WHNSB0460-SD	□	4.6	29	82	5	E45
NSBH0390-120-ATH	□	3.9	120	170	4	E49	30WHNSB0410-TH	●	4.1	149	200	5	E29	02WNSB0440-TH	□	4.4	23	59	5	E35	04WNSB0460-TH	●	4.6	32	64	5	E36
30WHNSB0390-TH	●	3.9	132	181	4	E29	30FWHNSB0410-TH	□	4.1	149	200	5	E43	EWSS4.4	□	4.4	24	58	5	E90	EWSR4.6	□	4.6	32	68	4.6	E91
30FWHNSB0390-TH	□	3.9	132	181	4	E43	40WHNSB0410-TH	□	4.1	185	238	5	E31	EHSE4.4-TH	●	4.4	29	63	5	E80	NSBH0460-40-ATH	□	4.6	40	90	6	E49
40WHNSB0390-TH	□	3.9	172	225	4	E31	50WHNSB0410-TH	□	4.1	228	281	5	E32	04WNSB0440-TH	●	4.4	29	64	5	E36	05WHNSB0460-TH	●	4.6	47	100	5	E21
50WHNSB0390-TH	□	3.9	212	265	4	E32	ZPB0420-TH	□	4.2	16	50	6	E85	03WHNSB0440-TH	●	4.4	29	82	5	E20	05FWHNSB0460-TH	●	4.6	47	100	5	E39
ZPB0400-TH	●	4	16	50	4	E85	ZPBL0420-TH	□	4.2	16	100	6	E87	03FWHNSB0440-TH	□	4.4	29	82	5	E38	05WHNSB0460-SD	□	4.6	47	100	5	E46
ZPBL0400-TH	□	4	16	100	6	E87	NSBH0420-20-ATH	●	4.2	20	70	6	E49	03WHNSB0440-SD	□	4.4	29	82	5	E45	08WHNSB0460-TH	●	4.6	59	110	5	E23
02WNSB0400-TH	□	4	20	52	4	E35	EWSS4.2	□	4.2	22	55	5	E90	NSBH0440-40-ATH	□	4.4	40	90	6	E49	NSBH0460-60-ATH	□	4.6	60	110	6	E49
NSBH0400-20-ATH	□	4	20	70	6	E49	02WNSB0420-TH	□	4.2	23	59	5	E35	05WHNSB0440-TH	●	4.4	47	100	5	E21	10WHNSB0460-TH	□	4.6	66	117	5	E25
EWSS4.0	□	4	22	55	4	E90	EHSE4.2-TH	●	4.2	29	63	5	E80	05FWHNSB0440-TH	●	4.4	47	100	5	E39	10FWHNSB0460-TH	□	4.6	66	117	5	E40
03WHNSB0400-TH	●	4	23	73	4	E20	04WNSB0420-TH	●	4.2	29	64	5	E36	05WHNSB0440-SD	□	4.4	47	100	5	E46	NSBH0460-90-ATH	□	4.6	90	140	6	E49
03FWHNSB0400-TH	□	4	23	73	4	E38	03WHNSB0420-TH	●	4.2	29	82	5	E20	08WHNSB0440-TH	□	4.4	55	110	5	E23	15WHNSB0460-TH	●	4.6	91	142	5	E26
03WHNSB0400-SD	□	4	23	73	4	E45	03FWHNSB0420-TH	□	4.2	29	82	5	E38	10WHNSB0440-TH	□	4.4	59	110	5	E25	15FWHNSB0460-TH	□	4.6	91	142	5	E41
04WNSB0400-TH	●	4	26	58	4	E36	03WHNSB0420-SD	□	4.2	29	82	5	E40	10FWHNSB0440-TH	□	4.4	59	110	5	E40	20WHNSB0460-TH	●	4.6	116	167	5	E27
EHSE4.0-TH	●	4	27	60	4	E80	NSBH0420-40-ATH	●	4.2	40	90	6	E49	NSBH0440-60-ATH	□	4.4	60	110	6	E49	20FWHNSB0460-TH	□	4.6	116	167	5	E42
EWSR4.0	□	4	27	60	4	E91	05WHNSB0420-TH	●	4.2	47	100	5	E21	15WHNSB0440-TH	●	4.4	81	132	5	E26	NSBH0460-120-ATH	□	4.6	120	170	6	E49
05WHNSB0400-TH	●	4	37	87	4	E21	05FWHNSB0420-TH	●	4.2	47	100	5	E39	15FWHNSB0440-TH	□	4.4	81	132	5	E41	25WHNSB0460-TH	□	4.6				

単位 unit : mm

商品コード Item code	在庫 Stock	直径 Tool da.	溝長 Flute length	全長 Overall length	シャンク径 Shank dia.	ページ Page	商品コード Item code	在庫 Stock	直径 Tool da.	溝長 Flute length	全長 Overall length	シャンク径 Shank dia.	ページ Page	商品コード Item code	在庫 Stock	直径 Tool da.	溝長 Flute length	全長 Overall length	シャンク径 Shank dia.	ページ Page	商品コード Item code	在庫 Stock	直径 Tool da.	溝長 Flute length	全長 Overall length	シャンク径 Shank dia.	ページ Page
15WHNSB0470-TH	●	4.7	91	142	5	E26	40WHNSB0490-TH	□	4.9	215	268	5	E31	NSBH0510-150-ATH	□	5.1	150	205	6	E50	03FWHNSB0540-TH	□	5.4	29	82	6	E38
15FWHNSB0470-TH	□	4.7	91	142	5	E41	50WHNSB0490-TH	□	4.9	265	318	5	E32	25WHNSB0510-TH	●	5.1	155	206	6	E28	03WHNSB0540-SD	□	5.4	29	82	6	E45
20WHNSB0470-TH	●	4.7	116	167	5	E27	ZPB0500-TH	●	5	20	60	6	E85	30WHNSB0510-TH	●	5.1	182	233	6	E29	NSBH0540-30-ATH	□	5.4	30	85	6	E50
20FWHNSB0470-TH	□	4.7	116	167	5	E42	ZPBL0500-TH	□	5	20	110	6	E87	30FWHNSB0510-TH	□	5.1	182	233	6	E43	EWSR5.4	□	5.4	34	72	5.4	E91
NSBH0470-120-ATH	□	4.7	120	170	6	E50	02WNSB0500-TH	●	5	25	59	5	E35	40WHNSB0510-TH	□	5.1	237	290	6	E31	EHSE5.4-TH	●	5.4	34	72	6	E80
25WHNSB0470-TH	●	4.7	141	192	5	E28	NSBH0500-25-ATH	●	5	25	80	6	E50	50WHNSB0510-TH	□	5.1	292	345	6	E32	04WNSB0540-TH	●	5.4	36	78	6	E36
NSBH0470-150-ATH	□	4.7	150	205	6	E50	EWSS5.0	□	5	26	62	5	E90	ZPB0520-TH	□	5.2	20	60	6	E85	05WHNSB0540-TH	●	5.4	47	100	6	E21
30WHNSB0470-TH	●	4.7	166	217	5	E29	03WHNSB0500-TH	●	5	29	82	5	E20	ZPBL0520-TH	□	5.2	20	110	6	E87	05FWHNSB0540-TH	●	5.4	47	100	6	E39
30FWHNSB0470-TH	□	4.7	166	217	5	E43	03FWHNSB0500-TH	●	5	29	82	5	E38	02WNSB0520-TH	●	5.2	25	64	6	E35	05WHNSB0540-SD	□	5.4	47	100	6	E46
40WHNSB0470-TH	□	4.7	215	268	5	E31	03WHNSB0500-SD	●	5	29	82	5	E45	EWSS5.2	□	5.2	26	62	6	E90	NSBH0540-60-ATH	□	5.4	60	115	6	E50
50WHNSB0470-TH	□	4.7	265	318	5	E32	04WNSB0500-TH	●	5	32	64	5	E36	03WHNSB0520-TH	●	5.2	29	82	6	E20	08WHNSB0540-TH	●	5.4	62	118	6	E23
ZPB0480-TH	□	4.8	20	60	6	E85	EHSE5.0-TH	●	5	32	68	5	E80	03FWHNSB0520-TH	□	5.2	29	82	6	E38	10WHNSB0540-TH	●	5.4	72	123	6	E25
NSBH0480-20-ATH	□	4.8	20	70	6	E50	EWSR5.0	□	5	32	68	5	E91	03WHNSB0520-SD	□	5.2	29	82	6	E45	10FWHNSB0540-TH	□	5.4	72	123	6	E40
ZPBL0480-TH	□	4.8	20	110	6	E87	NSBH0500-40-ATH	●	5	40	95	6	E50	NSBH0520-30-ATH	□	5.2	30	85	6	E50	NSBH0540-90-ATH	□	5.4	90	145	6	E50
02WNSB0480-TH	□	4.8	25	59	5	E35	05WHNSB0500-TH	●	5	47	100	5	E21	EHSE5.2-TH	●	5.2	34	72	5.2	E91	15WHNSB0540-TH	●	5.4	100	151	6	E26
EWSS4.8	□	4.8	26	62	5	E90	05FWHNSB0500-TH	●	5	47	100	5	E39	04WNSB0520-TH	●	5.2	36	78	6	E36	15FWHNSB0540-TH	□	5.4	100	151	6	E41
03WHNSB0480-TH	●	4.8	29	82	5	E20	05WHNSB0500-SD	●	5	47	100	5	E46	05WHNSB0520-TH	●	5.2	47	100	6	E21	NSBH0540-120-ATH	□	5.4	120	175	6	E50
03FWHNSB0480-TH	□	4.8	29	82	5	E38	08WHNSB0500-TH	●	5	59	110	5	E23	05FWHNSB0520-TH	●	5.2	47	100	6	E39	20WHNSB0540-TH	●	5.4	127	178	6	E27
03WHNSB0480-SD	□	4.8	29	82	5	E45	NSBH0500-60-ATH	●	5	60	115	6	E50	05WHNSB0520-SD	□	5.2	47	100	6	E46	20FWHNSB0540-TH	□	5.4	127	178	6	E42
04WNSB0480-TH	●	4.8	32	64	5	E36	08WHSR0500-ATH	●	5	62	114	6	E56	NSBH0520-60-ATH	□	5.2	60	115	6	E50	NSBH0540-150-ATH	□	5.4	150	205	6	E50
EWSR4.8	□	4.8	32	68	4.8	E91	10WHNSB0500-TH	●	5	66	117	5	E25	08WHNSB0520-TH	●	5.2	62	118	6	E23	25WHNSB0540-TH	●	5.4	155	206	6	E28
EHSE4.8-TH	●	4.8	32	68	5	E80	10FWHNSB0500-TH	●	5	66	117	5	E40	10WHNSB0520-TH	●	5.2	62	118	6	E25	30WHNSB0540-TH	●	5.4	182	233	6	E29
NSBH0480-40-ATH	□	4.8	40	90	6	E50	NSBH0500-90-ATH	●	5	90	145	6	E50	10FWHNSB0520-TH	□	5.2	72	123	6	E25	30FWHNSB0540-TH	□	5.4	182	233	6	E43
05WHNSB0480-TH	●	4.8	47	100	5	E21	15WHNSB0500-TH	●	5	91	142	5	E26	10WHNSB0520-TH	□	5.2	72	123	6	E40	40WHNSB0540-TH	□	5.4	237	290	6	E31
05FWHNSB0480-TH	●	4.8	47	100	5	E39	15FWHNSB0500-TH	●	5	91	142	5	E41	NSBH0520-90-ATH	□	5.2	90	145	6	E50	50WHNSB0540-TH	□	5.4	292	345	6	E32
05WHNSB0480-SD	□	4.8	47	100	5	E46	15WHNSB0500-SD	●	5	91	142	5	E47	15WHNSB0520-TH	●	5.2	100	151	6	E26	ZPB0550-TH	●	5.5	22	60	6	E85
08WHNSB0480-TH	●	4.8	59	110	5	E23	20WHNSB0500-TH	●	5	116	167	5	E27	15FWHNSB0520-TH	□	5.2	100	151	6	E41	ZPBL0550-TH	□	5.5	22	110	6	E87
NSBH0480-60-ATH	□	4.8	60	110	6	E50	20FWHNSB0500-TH	●	5	116	167	5	E42	NSBH0520-120-ATH	□	5.2	120	175	6	E50	02WNSB0550-TH	●	5.5	25	64	6	E35
10WHNSB0480-TH	●	4.8	66	117	5	E25	20WHNSB0500-SD	●	5	116	167	5	E47	20WHNSB0520-TH	●	5.2	127	178	6	E27	EWSS5.5	□	5.5	28	66	6	E90
10FWHNSB0480-TH	□	4.8	66	117	5	E40	20WHSR0500-ATH	●	5	119	171	6	E56	20FWHNSB0520-TH	□	5.2	127	178	6	E42	03WHNSB0550-TH	●	5.5	29	82	6	E20
NSBH0480-90-ATH	□	4.8	90	140	6	E50	NSBH0500-120-ATH	●	5	120	175	6	E50	NSBH0520-150-ATH	□	5.2	150	205	6	E50	03FWHNSB0550-TH	●	5.5	29	82	6	E38
15WHNSB0480-TH	●	4.8	91	142	5	E26	25WHNSB0500-TH	●	5	141	192	5	E28	25WHNSB0520-TH	●	5.2	155	206	6	E28	03WHNSB0550-SD	□	5.5	29	82	6	E45
15FWHNSB0480-TH	□	4.8	91	142	5	E41	25WHNSB0500-SD	●	5	141	192	5	E47	30WHNSB0520-TH	●	5.2	182	233	6	E29	03WHNS0550-30-ATH	□	5.5	30	85	6	E50
20WHNSB0480-TH	●	4.8	116	167	5	E27	NSBH0500-150-ATH	●	5	150	205	6	E50	30FWHNSB0520-TH	□	5.2	182	233	6	E43	EWSR5.5	□	5.5	34	72	5.5	E91
20FWHNSB0480-TH	□	4.8	116	167	5	E42	30WHNSB0500-TH	●	5	166	217	5	E29	40WHNSB0520-TH	□	5.2	237	290	6	E31	EHSE5.5-TH	●	5.5	34	72	6	E80
NSBH0480-120-ATH	□	4.8	120	170	6	E50	30FWHNSB0500-TH	●	5	166	217	5	E43	50WHNSB0520-TH	□	5.2	292	345	6	E32	04WNSB0550-TH	●	5.5	36	78	6	E36
25WHNSB0480-TH	●	4.8	141	192	5	E28	30WHNSB0500-SD	●	5	166	217	5	E46	ZPB0530-TH	□	5.3	20	60	6	E85	05WHNSB0550-TH	●	5.5	47	100	6	E21
NSBH0480-150-ATH	□	4.8	150	205	6	E50	30WHSR0500-ATH	●	5	169	221	6	E57	ZPBL0530-TH	□	5.3	20	110	6	E87	05FWHNSB0550-TH	●	5.5	47	100	6	E39
30WHNSB0480-TH	●	4.8	166	217	5	E29	40WHNSB0500-TH	○	5	215	268	5	E31	02WNSB0530-TH	□	5.3	25	64	6	E35	05WHNSB0550-SD	□	5.5	47	100	6	E46
30FWHNSB0480-TH	□	4.8	166	217	5	E43	50WHNSB0500-TH	○	5	265	318	5	E32	EWSS5.3	□	5.3	26	62	6	E90	NSBH0550-60-ATH	□	5.5	60	115	6	E50
40WHNSB0480-TH	□	4.8	215	268	5	E31	03WHNSB0503-SD	●	5.03	29	82	6	E45	03WHNSB0530-TH	●	5.3	29	82	6	E20	08WHNSB0550-TH	●	5.5	62	118	6	E23
50WHNSB0480-TH	□	4.8	265	318	5	E32	05WHNSB0503-SD	●	5.03	47	100	6	E46	03FWHNSB0530-TH	□	5.3	29	82	6	E38	10WHNSB0550-TH	□	5.5	72	123	6	E25
ZPB0490-TH	□	4.9	20	60	6	E85	03WHNSB0505-TH	●	5.05	29	82	6	E20	NSBH0530-30-ATH	□	5.3	30	85	6	E50	10FWHNSB0550-TH	●	5.5	72	123	6	E40
NSBH0490-20-ATH	□	4.9	20	70	6	E50	ZPB0510-TH	□	5.1	20	60	6	E85	EWSR5.3	□	5.3	34	72	5.3	E91	NSBH0550-90-ATH	□	5.5	90	145	6	E50
ZPBL0490-TH	□	4.9	20	110	6	E87	ZPBL0510-TH	□	5.1	20	110	6	E87	EHSE5.3-TH	●	5.3	34	72	6	E80	25WHNSB0550-SD	□	5.5	155	206	6	E47
02WNSB0490-TH	□	4.9	25	59	5	E35	02WNSB0510-TH	□	5.1	25	64	6	E35	04WNSB0530-TH	●	5.3	36	78	6	E36	NSBH0550-120-ATH	□	5.5	120	175	6	E50
EWSS4.9	□	4.9	26	62	5	E90	EWSS5.1	□	5.1	26	62	6	E90	05WHNSB0530-TH	□	5.3	47	100	6	E21	20WHNSB0550-TH	●	5.5	127	178	6	E27
03WHNSB0490-TH	●	4.9	29	82	5	E20	03WHNSB0510-TH	□	5.1	29	82	6	E20	05FWHNSB0530-TH	□	5.3	47	100	6	E39	20FWHNSB0550-TH	□	5.5	127	178	6	E42
03FWHNSB0490-TH	□	4.9	29	82	5	E38	03FWHNSB0510-TH	□	5.1	29	82	6	E38	05WHNSB0530-SD	□	5.3	47	100	6	E46	05WHNSB0550-SD	□	5.5	127	178	6	E47
03WHNSB0490-SD	□	4.9	29	82	5	E45	03WHNSB0510-SD	□	5.1	29	82	6	E45	NSBH0530-60-ATH	□	5.3	60	115	6	E50	NSBH0550-150-ATH	□	5.5	150	205	6	E50
04WNSB0490-TH	●	4.9	32	64	5	E36	NSBH0510-30-ATH	●	5.1	30	85	6	E50	08WHNSB0530-TH	●	5.3	62	118	6	E23	25WHNSB0550-TH	●	5.5	155	206	6	E28
EWSR4.9	□	4.9	32	6																							

直径別寸法早見表

φ5.6~φ7.4

単位 unit : mm

商品コード Item code	在庫 Stock	直径 Tool dia.	溝長 Flute length	全長 Overall length	シャンク径 Shank dia.	ページ Page	商品コード Item code	在庫 Stock	直径 Tool dia.	溝長 Flute length	全長 Overall length	シャンク径 Shank dia.	ページ Page	商品コード Item code	在庫 Stock	直径 Tool dia.	溝長 Flute length	全長 Overall length	シャンク径 Shank dia.	ページ Page
EHSE5.6-TH	●	5.6	36	74	6	E80	15FWHNSB0580-TH	□	5.8	109	160	6	E41	30WHNSB0600-TH	●	6	199	250	6	E29
04WNSB0560-TH	●	5.6	39	78	6	E36	NSBH0580-120-ATH	□	5.8	120	175	6	E50	03FWHNSB0600-TH	●	6	199	250	6	E43
05WHNSB0560-TH	●	5.6	47	100	6	E21	20WHNSB0580-TH	●	5.8	139	190	6	E27	30WHNSB0600-SD	●	6	199	250	6	E47
05FWHNSB0560-TH	●	5.6	47	100	6	E39	20FWHNSB0580-TH	□	5.8	139	190	6	E42	30WHSR0600-ATH	●	6	202	255	6	E56
05WHNSB0560-SD	□	5.6	47	100	6	E46	NSBH0580-150-ATH	□	5.8	150	205	6	E50	40WHNSB0600-TH	◎	6	258	311	6	E31
NSBH0560-60-ATH	□	5.6	60	115	6	E60	25WHNSB0580-TH	□	5.8	169	220	6	E28	50WHNSB0600-TH	◎	6	318	371	6	E32
08WHNSB0560-TH	●	5.6	67	118	6	E23	30WHNSB0580-TH	●	5.8	199	250	6	E29	03WHNSB0603-SD	◎	6.03	34	89	7	E45
10WHNSB0560-TH	●	5.6	79	130	6	E25	30FWHNSB0580-TH	□	5.8	199	250	6	E43	05WHNSB0603-SD	◎	6.03	55	110	7	E46
10FWHNSB0560-TH	□	5.6	79	130	6	E40	40WHNSB0580-TH	□	5.8	258	311	6	E31	03WHNSB0605-TH	●	6.05	34	89	7	E20
NSBH0560-90-ATH	□	5.6	90	145	6	E50	50WHNSB0580-TH	□	5.8	318	371	6	E32	ZPB0610-TH	□	6.1	24	70	8	E85
05WHNSB0560-TH	●	5.6	109	160	6	E26	ZPB0590-TH	□	5.9	22	60	6	E85	ZPBL0610-TH	□	6.1	24	120	6	E87
15FWHNSB0560-TH	□	5.6	109	160	6	E41	ZPBL0590-TH	□	5.9	22	110	6	E87	02WNSB0610-TH	□	6.1	29	71	7	E35
NSBH0560-120-ATH	□	5.6	120	175	6	E50	02WNSB0590-TH	□	5.9	25	64	6	E35	NSBH0610-30-ATH	□	6.1	30	85	8	E50
20WHNSB0560-TH	●	5.6	139	190	6	E27	EWSS5.9	□	5.9	28	66	6	E90	EWSS6.1	□	6.1	31	70	7	E90
20FWHNSB0560-TH	□	5.6	139	190	6	E42	03WHNSB0590-TH	●	5.9	29	82	6	E20	03WHNSB0610-TH	□	6.1	34	89	7	E28
NSBH0560-150-ATH	□	5.6	150	205	6	E50	03FWHNSB0590-TH	□	5.9	29	82	6	E38	03FWHNSB0610-TH	□	6.1	34	89	7	E38
25WHNSB0560-TH	●	5.6	169	220	6	E28	03WHNSB0590-SD	□	5.9	29	82	6	E45	03WHNSB0610-SD	□	6.1	34	89	7	E45
30WHNSB0560-TH	●	5.6	199	250	6	E29	NSBH0590-30-ATH	□	5.9	30	85	6	E50	EWSS6.1	□	6.1	41	81	6.1	E91
30FWHNSB0560-TH	□	5.6	199	250	6	E43	EWSS5.9	□	5.9	36	74	5.9	E91	04WNSB0610-TH	●	6.1	41	83	7	E36
40WHNSB0560-TH	□	5.6	258	311	6	E31	EHSE5.9-TH	●	5.9	36	74	6	E80	05WHNSB0610-TH	●	6.1	55	110	7	E21
50WHNSB0560-TH	□	5.6	318	371	6	E32	04WNSB0590-TH	●	5.9	39	78	6	E36	05FWHNSB0610-TH	●	6.1	55	110	7	E39
ZPB0570-TH	□	5.7	22	60	6	E85	05WHNSB0590-TH	●	5.9	47	100	6	E21	05WHNSB0610-SD	□	6.1	55	110	7	E46
ZPBL0570-TH	□	5.7	22	110	6	E87	05FWHNSB0590-TH	●	5.9	47	100	6	E39	NSBH0610-60-ATH	□	6.1	60	115	8	E50
02WNSB0570-TH	□	5.7	25	64	6	E35	05WHNSB0590-SD	□	5.9	47	100	6	E46	08WHNSB0610-TH	●	6.1	73	132	7	E23
EWSS5.7	□	5.7	28	66	6	E90	NSBH0590-60-ATH	□	5.9	60	115	6	E50	10WHNSB0610-TH	●	6.1	85	138	7	E25
03WHNSB0570-TH	●	5.7	29	82	6	E20	08WHNSB0590-TH	●	5.9	67	118	6	E23	10FWHNSB0610-TH	□	6.1	85	138	7	E40
03FWHNSB0570-TH	□	5.7	29	82	6	E38	10WHNSB0590-TH	●	5.9	79	130	6	E25	NSBH0610-90-ATH	□	6.1	90	145	8	E50
03WHNSB0570-SD	□	5.7	29	82	6	E45	10FWHNSB0590-TH	□	5.9	79	130	6	E40	15WHNSB0610-TH	●	6.1	118	171	7	E26
NSBH0570-30-ATH	□	5.7	30	85	6	E50	NSBH0590-90-ATH	□	5.9	90	145	6	E50	15FWHNSB0610-TH	□	6.1	118	171	7	E41
EWSS5.7	□	5.7	36	74	5.7	E91	15WHNSB0590-TH	●	5.9	109	160	6	E26	NSBH0610-120-ATH	□	6.1	120	175	8	E50
EHSE5.7-TH	●	5.7	36	74	6	E80	15FWHNSB0590-TH	□	5.9	109	160	6	E41	20WHNSB0610-TH	●	6.1	150	203	7	E27
04WNSB0570-TH	●	5.7	39	78	6	E36	NSBH0590-120-ATH	□	5.9	120	175	6	E50	20FWHNSB0610-TH	□	6.1	150	203	7	E42
05WHNSB0570-TH	●	5.7	47	100	6	E21	20WHNSB0590-TH	●	5.9	139	190	6	E27	NSBH0610-150-ATH	□	6.1	150	205	8	E50
05FWHNSB0570-TH	●	5.7	47	100	6	E39	20FWHNSB0590-TH	□	5.9	139	190	6	E42	25WHNSB0610-TH	●	6.1	183	236	7	E28
05WHNSB0570-SD	□	5.7	47	100	6	E46	NSBH0590-150-ATH	□	5.9	150	205	6	E50	30WHNSB0610-TH	●	6.1	215	268	7	E29
NSBH0570-60-ATH	□	5.7	60	115	6	E50	25WHNSB0590-TH	●	5.9	169	220	6	E28	30FWHNSB0610-TH	□	6.1	215	268	7	E43
08WHNSB0570-TH	●	5.7	67	118	6	E23	30WHNSB0590-TH	●	5.9	199	250	6	E29	40WHNSB0610-TH	□	6.1	280	333	7	E31
10WHNSB0570-TH	●	5.7	79	130	6	E25	30FWHNSB0590-TH	□	5.9	199	250	6	E43	50WHNSB0610-TH	□	6.1	345	398	7	E32
10FWHNSB0570-TH	□	5.7	79	130	6	E40	40WHNSB0590-TH	□	5.9	258	311	6	E31	ZPB0620-TH	□	6.2	24	70	8	E85
NSBH0570-90-ATH	□	5.7	90	145	6	E50	50WHNSB0590-TH	□	5.9	318	371	6	E32	ZPBL0620-TH	□	6.2	24	120	6	E87
15WHNSB0570-TH	●	5.7	109	160	6	E26	ZPB0600-TH	●	6	22	60	6	E85	02WNSB0620-TH	□	6.2	29	71	7	E35
15FWHNSB0570-TH	□	5.7	109	160	6	E41	ZPBL0600-TH	□	6	22	120	6	E87	NSBH0620-30-ATH	□	6.2	30	85	8	E50
NSBH0570-120-ATH	□	5.7	120	175	6	E50	02WNSB0600-TH	●	6	25	64	6	E35	EWSS6.2	□	6.2	31	70	7	E90
20WHNSB0570-TH	●	5.7	139	190	6	E27	EWSS6.0	□	6	28	66	6	E90	03WHNSB0620-TH	●	6.2	34	89	7	E20
20FWHNSB0570-TH	□	5.7	139	190	6	E42	03WHNSB0600-TH	●	6	29	82	6	E20	03FWHNSB0620-TH	□	6.2	34	89	7	E38
NSBH0570-150-ATH	□	5.7	150	205	6	E50	03FWHNSB0600-TH	●	6	29	82	6	E38	03WHNSB0620-SD	□	6.2	34	89	7	E45
25WHNSB0570-TH	●	5.7	169	220	6	E28	03WHNSB0600-SD	□	6	29	82	6	E45	EWSS6.2	□	6.2	41	81	6.2	E91
30WHNSB0570-TH	●	5.7	199	250	6	E29	NSBH0600-30-ATH	●	6	30	85	8	E50	04WNSB0620-TH	●	6.2	41	83	7	E36
30FWHNSB0570-TH	□	5.7	199	250	6	E43	04WNSB0600-TH	●	6	39	78	6	E36	05WHNSB0620-TH	●	6.2	55	110	7	E21
40WHNSB0570-TH	□	5.7	258	311	6	E31	EHSE6.0-TH	□	6	41	81	6	E80	05FWHNSB0620-TH	●	6.2	55	110	7	E39
50WHNSB0570-TH	□	5.7	318	371	6	E32	EWSS6.0	□	6	41	81	6	E91	05WHNSB0620-SD	□	6.2	55	110	7	E46
ZPB0580-TH	□	5.8	22	60	6	E85	05WHNSB0600-TH	●	6	47	100	6	E21	NSBH0620-60-ATH	□	6.2	60	115	8	E50
ZPBL0580-TH	□	5.8	22	110	6	E87	05FWHNSB0600-TH	●	6	47	100	6	E39	08WHNSB0620-TH	●	6.2	73	132	7	E23
02WNSB0580-TH	□	5.8	25	64	6	E35	05WHNSB0600-SD	□	6	47	100	6	E46	10WHNSB0620-TH	●	6.2	85	138	7	E25
EWSS5.8	□	5.8	28	66	6	E90	NSBH0600-60-ATH	□	6	60	115	8	E50	10FWHNSB0620-TH	□	6.2	85	138	7	E40
03WHNSB0580-TH	●	5.8	29	82	6	E20	08WHNSB0600-TH	●	6	67	118	6	E23	NSBH0620-90-ATH	□	6.2	90	145	8	E50
03FWHNSB0580-TH	●	5.8	29	82	6	E38	08WHSR0600-ATH	●	6	70	123	6	E56	15WHNSB0620-TH	●	6.2	118	171	7	E26
03WHNSB0580-SD	□	5.8	29	82	6	E45	10WHNSB0600-TH	●	6	79	130	6	E25	15FWHNSB0620-TH	□	6.2	118	171	7	E41
NSBH0580-30-ATH	□	5.8	30	85	6	E50	10FWHNSB0600-TH	□	6	79	130	6	E40	NSBH0620-120-ATH	□	6.2	120	175	8	E50
EWSS5.8	□	5.8	36	74	5.8	E91	NSBH0600-90-ATH	●	6	90	145	8	E50	20WHNSB0620-TH	□	6.2	150	203	7	E27
EHSE5.8-TH	●	5.8	36	74	6	E80	15WHNSB0600-TH	●	6	109	160	6	E26	20FWHNSB0620-TH	□	6.2	150	203	7	E42
04WNSB0580-TH	●	5.8	39	78	6	E36	15FWHNSB0600-TH	●	6	109	160	6	E41	NSBH0620-150-ATH	□	6.2	150	205	8	E50
05WHNSB0580-TH	●	5.8	47	100	6	E21	15WHNSB0600-SD	□	6	109	160	6	E47	25WHNSB0620-TH	●	6.2	183	236	7	E28
05FWHNSB0580-TH	●	5.8	47	100	6	E39	NSBH0600-120-ATH	□	6	120	175	8	E50	30WHNSB0620-TH	●	6.2	215	268	7	E29
05WHNSB0580-SD	□	5.8	47	100	6	E46	20WHNSB0600-TH	●	6	139	190	6	E27	30FWHNSB0620-TH	□	6.2	215	268	7	E43
NSBH0580-60-ATH	□	5.8	60	115	6	E50	20FWHNSB0600-TH	□	6	139	190	6	E42	40WHNSB0620-TH	□	6.2	280	333	7	E31
08WHNSB0580-TH	●	5.8	67	118	6	E23	20WHNSB0600-SD	□	6	139	190	6	E47	50WHNSB0620-TH	□	6.2	345	398	7	E32
10WHNSB0580-TH	●	5.8	79																	

単位 unit : mm

商品コード Item code	在庫 Stock	直径 Tool dia.	溝長 Flute length	全長 Overall length	シャンク径 Shank dia.	ページ Page	商品コード Item code	在庫 Stock	直径 Tool dia.	溝長 Flute length	全長 Overall length	シャンク径 Shank dia.	ページ Page	商品コード Item code	在庫 Stock	直径 Tool dia.	溝長 Flute length	全長 Overall length	シャンク径 Shank dia.	ページ Page	商品コード Item code	在庫 Stock	直径 Tool dia.	溝長 Flute length	全長 Overall length	シャンク径 Shank dia.	ページ Page
10FWHNSB0650-TH	●	6.5	85	138	7	E40	20WHNSB0670-TH	●	6.7	162	215	7	E27	25WHNSB0690-TH	●	6.9	197	250	7	E28	25WHNSB0710-TH	●	7.1	211	266	8	E28
NSBH0650-90-ATH	□	6.5	90	145	8	E50	20FWHNSB0670-TH	□	6.7	162	215	7	E42	NSBH0690-200-ATH	□	6.9	200	255	8	E51	30WHNSB0710-TH	●	7.1	248	303	8	E29
15WHNSB0650-TH	●	6.5	118	171	7	E26	25WHNSB0670-TH	●	6.7	197	250	7	E28	30WHNSB0690-TH	●	6.9	232	285	7	E29	30FWHNSB0710-TH	□	7.1	248	303	8	E43
15FWHNSB0650-TH	●	6.5	118	171	7	E41	NSBH0670-200-ATH	□	6.7	200	255	8	E50	30FWHNSB0690-TH	□	6.9	232	285	7	E43	40WHNSB0710-TH	□	7.1	323	380	8	E31
15WHNSB0650-SD	□	6.5	118	171	7	E47	30WHNSB0670-TH	●	6.7	232	285	7	E29	40WHNSB0690-TH	□	6.9	301	354	7	E31	50WHNSB0710-TH	□	7.1	398	451	8	E32
NSBH0650-120-ATH	□	6.5	120	175	8	E50	30FWHNSB0670-TH	□	6.7	232	285	7	E43	50WHNSB0690-TH	□	6.9	371	424	7	E32	ZPB0720-TH	□	7.2	26	70	8	E85
20WHNSB0650-TH	●	6.5	150	203	7	E27	40WHNSB0670-TH	□	6.7	301	354	7	E31	ZPB0700-TH	●	7	26	70	8	E85	ZPBL0720-TH	□	7.2	26	120	6	E87
20FWHNSB0650-TH	●	6.5	150	203	7	E42	50WHNSB0670-TH	□	6.7	371	424	7	E32	ZPBL0700-TH	□	7	26	120	6	E87	02WNSB0720-TH	□	7.2	32	76	8	E35
20WHNSB0650-SD	□	6.5	150	203	7	E47	ZPB0680-TH	□	6.8	26	70	8	E85	EWSS7.0	□	7	31	71	7	E35	EWSS7.2	□	7.2	34	74	8	E90
NSBH0650-150-ATH	□	6.5	150	205	8	E50	ZPBL0680-TH	□	6.8	26	120	6	E87	04WHNSB0700-TH	□	7	34	74	7	E90	NSBH0720-35-ATH	□	7.2	35	90	8	E51
25WHNSB0650-TH	●	6.5	183	236	7	E28	NSBH0680-30-ATH	●	6.8	30	85	8	E50	03WHNSB0700-TH	□	7	34	89	7	E20	03WHNSB0720-TH	●	7.2	39	95	8	E20
25WHNSB0650-SD	□	6.5	183	236	7	E47	02WNSB0680-TH	●	6.8	31	71	7	E35	03FWHNSB0700-TH	□	7	34	89	7	E38	03FWHNSB0720-TH	□	7.2	39	95	8	E38
30WHNSB0650-TH	●	6.5	215	268	7	E29	EWSS6.8	□	6.8	34	74	7	E90	03WHNSB0700-SD	□	7	34	89	7	E45	03WHNSB0720-SD	□	7.2	39	95	8	E45
30FWHNSB0650-TH	□	6.5	215	268	7	E43	03WHNSB0680-TH	□	6.8	34	89	7	E20	NSBH0700-35-ATH	□	7	35	90	8	E51	EWSS7.2	□	7.2	45	87	7.2	E91
40WHNSB0650-TH	□	6.5	280	333	7	E31	03FWHNSB0680-TH	●	6.8	34	89	7	E38	03WHNSB0700-TH	●	7	43	83	7	E36	04WHNSB0720-TH	●	7.2	45	90	8	E36
50WHNSB0650-TH	□	6.5	345	398	7	E32	03WHNSB0680-SD	□	6.8	34	89	7	E45	EHSE7.0-TH	●	7	43	83	7	E80	NSBH0720-60-ATH	□	7.2	60	115	8	E51
03WHNSB0653-SD	●	6.53	34	89	7	E45	EWSR6.8	□	6.8	43	83	6.8	E91	EWSR7.0	□	7	43	83	7	E91	05WHNSB0720-TH	●	7.2	63	119	8	E21
05WHNSB0653-SD	●	6.53	55	110	7	E46	04WHNSB0680-TH	□	6.8	43	83	7	E36	05WHNSB0700-TH	□	7	55	110	7	E21	05FWHNSB0720-TH	□	7.2	63	119	8	E39
03WHNSB0655-TH	●	6.55	34	89	7	E20	EHSE6.8-TH	●	6.8	43	83	7	E80	05FWHNSB0700-TH	□	7	55	110	7	E39	05WHNSB0720-SD	□	7.2	63	119	8	E46
ZPB0660-TH	□	6.6	26	70	8	E85	STBH068S-ATH	□	6.8	45	100	10	E82	05WHNSB0700-SD	□	7	55	110	7	E46	08WHNSB0720-TH	□	7.2	84	144	8	E23
ZPBL0660-TH	□	6.6	26	120	6	E87	STB068S-ATH	●	6.8	45	100	10	E83	NSBH0700-60-ATH	●	7	60	115	8	E51	NSBH0720-90-ATH	□	7.2	90	145	8	E51
NSBH0660-30-ATH	□	6.6	30	85	8	E50	STBH068M-ATH	●	6.8	50	105	10	E82	08WHNSB0700-TH	□	7	77	132	7	E23	10WHNSB0720-TH	●	7.2	98	153	8	E25
EWSS6.6	□	6.6	31	70	7	E90	STB068M-ATH	□	6.8	50	105	10	E83	08WHSR0700-ATH	□	7	81	133	8	E56	10FWHNSB0720-TH	□	7.2	98	153	8	E40
02WNSB0660-TH	□	6.6	31	71	7	E35	05WHNSB0680-TH	□	6.8	55	110	7	E21	08WHNSB0700-TH	□	7	90	145	8	E51	10FWHNSB0720-ATH	□	7.2	120	175	8	E51
03WHNSB0660-TH	●	6.6	34	89	7	E20	05FWHNSB0680-TH	□	6.8	55	110	7	E39	10WHNSB0700-TH	□	7	92	145	7	E25	15WHNSB0720-TH	●	7.2	136	191	8	E26
03FWHNSB0660-TH	□	6.6	34	89	7	E38	05WHNSB0680-SD	□	6.8	55	110	7	E46	10FWHNSB0700-TH	□	7	92	145	7	E40	15FWHNSB0720-TH	□	7.2	136	191	8	E41
03WHNSB0660-SD	□	6.6	34	89	7	E45	NSBH0680-60-ATH	●	6.8	60	115	8	E50	NSBH0700-120-ATH	●	7	120	175	8	E51	NSBH0720-150-ATH	□	7.2	150	205	8	E51
EWSR6.6	□	6.6	43	83	6.6	E91	08WHNSB0680-TH	□	6.8	77	132	7	E23	15WHNSB0700-TH	□	7	127	180	7	E26	20WHNSB0720-TH	●	7.2	173	228	8	E27
04WHNSB0660-TH	●	6.6	43	83	7	E36	NSBH0680-90-ATH	□	6.8	90	145	8	E50	15FWHNSB0700-TH	□	7	127	180	7	E41	20FWHNSB0720-TH	□	7.2	173	228	8	E42
05WHNSB0660-TH	□	6.6	55	110	7	E21	10WHNSB0680-TH	□	6.8	92	145	7	E25	15WHNSB0700-SD	□	7	127	180	7	E47	NSBH0720-200-ATH	□	7.2	200	255	8	E51
05FWHNSB0660-TH	□	6.6	55	110	7	E39	10FWHNSB0680-TH	□	6.8	92	145	7	E40	NSBH0700-150-ATH	●	7	150	205	8	E51	25WHNSB0720-TH	●	7.2	211	266	8	E28
05WHNSB0660-SD	□	6.6	55	110	7	E46	NSBH0680-120-ATH	□	6.8	120	175	8	E50	20WHNSB0700-TH	□	7	162	215	7	E27	30WHNSB0720-TH	□	7.2	248	303	8	E29
NSBH0660-60-ATH	□	6.6	60	115	8	E50	15WHNSB0680-TH	□	6.8	127	180	7	E26	20FWHNSB0700-TH	□	7	162	215	7	E42	30FWHNSB0720-TH	□	7.2	248	303	8	E43
08WHNSB0660-TH	●	6.6	77	132	7	E23	15FWHNSB0680-TH	□	6.8	127	180	7	E41	20WHNSB0700-SD	□	7	162	215	7	E47	40WHNSB0720-TH	□	7.2	323	380	8	E31
NSBH0660-90-ATH	□	6.6	90	145	8	E50	15WHNSB0680-SD	□	6.8	127	180	7	E47	20WHSR0700-ATH	□	7	166	218	8	E56	50WHNSB0720-TH	□	7.2	398	451	8	E32
10WHNSB0660-TH	●	6.6	92	145	7	E25	NSBH0680-150-ATH	□	6.8	150	205	8	E50	25WHNSB0700-TH	□	7	197	250	7	E28	ZPB0730-TH	□	7.3	26	70	8	E85
10FWHNSB0660-TH	□	6.6	92	145	7	E40	20WHNSB0680-TH	●	6.8	162	215	7	E27	25WHNSB0700-SD	□	7	197	250	7	E47	ZPBL0730-TH	□	7.3	26	120	6	E87
NSBH0660-120-ATH	□	6.6	120	175	8	E50	20FWHNSB0680-TH	□	6.8	162	215	7	E42	NSBH0700-200-ATH	□	7	200	255	8	E51	02WNSB0730-TH	□	7.3	32	76	8	E35
15WHNSB0660-TH	●	6.6	127	180	7	E26	20WHNSB0680-SD	□	6.8	162	215	7	E47	30WHNSB0700-TH	□	7	232	285	7	E29	EWSS7.3	□	7.3	34	74	8	E90
15FWHNSB0660-TH	□	6.6	127	180	7	E41	25WHNSB0680-SD	□	6.8	191	244	7	E47	30FWHNSB0700-TH	□	7	232	285	7	E43	NSBH0730-35-ATH	□	7.3	35	90	8	E51
NSBH0660-150-ATH	□	6.6	150	205	8	E50	25WHNSB0680-TH	●	6.8	197	250	7	E28	30WHSR0700-ATH	□	7	236	288	8	E56	03WHNSB0730-TH	●	7.3	39	95	8	E20
20WHNSB0660-TH	□	6.6	162	215	7	E27	NSBH0680-200-ATH	□	6.8	200	255	8	E50	40WHNSB0700-TH	□	7	301	354	7	E31	03FWHNSB0730-TH	□	7.3	39	95	8	E38
NSBH0660-200-ATH	□	6.6	162	215	7	E27	30WHNSB0680-TH	●	6.8	232	285	7	E29	50WHNSB0700-TH	□	7	371	424	7	E32	03WHNSB0730-SD	□	7.3	39	95	8	E45
20FWHNSB0660-TH	□	6.6	162	215	7	E42	30FWHNSB0680-TH	□	6.8	232	285	7	E43	03WHNSB0703-SD	□	7.03	39	95	8	E45	04WNSB0730-TH	●	7.3	45	90	8	E36
25WHNSB0660-TH	●	6.6	197	250	7	E28	40WHNSB0680-TH	□	6.8	301	354	7	E31	05WHNSB0703-SD	□	7.03	63	119	8	E46	04WHNSB0730-TH	●	7.3	45	90	8	E36
NSBH0660-200-ATH	□	6.6	200	255	8	E50	50WHNSB0680-TH	□	6.8	371	424	7	E32	03WHNSB0705-TH	□	7.05	39	95	8	E20	05WHNSB0730-TH	●	7.3	63	119	8	E39
30WHNSB0660-TH	●	6.6	232	285	7	E29	ZPB0690-TH	□	6.9	26	70	8	E85	ZPB0710-TH	□	7.1	26	70	8	E85	05WHNSB0730-SD	□	7.3	63	119	8	E46
30FWHNSB0660-TH	□	6.6	232	285	7	E43	ZPBL0690-TH	□	6.9	26	120	6	E87	ZPBL0710-TH	□	7.1	26	120	6	E87	08WHNSB0730-TH	□	7.3	84	144	8	E23
40WHNSB0660-TH	□	6.6	301	354	7	E31	NSBH0690-30-ATH	●	6.9	30	85	8	E51	ZPBL0710-TH	□	7.1	26	120	6	E87	NSBH0730-150-ATH	□	7.3	136	191	8	E26
50WHNSB0660-TH	□	6.6	371	424	7	E32	02WNSB0690-TH	□	6.9	31	71	7	E35	EWSS7.1	□	7.1	34	74	8	E90	15FWHNSB0730-TH	□	7.3	136	191	8	E41
ZPB070-TH	□	6.7	26	70	8	E85	EWSS6.9	□	6.9	34	74	7	E90	NSBH0710-35-ATH	□	7.1	35	90	8	E51	20WHNSB0730-TH	□</					

Quick dimension reference table by tool diameter

直径別寸法早見表

φ7.4~φ9.1

単位 unit : mm

商品コード Item code	在庫 Stock	直径 Tool dia.	溝長 Flute length	全長 Overall length	シャンク径 Shank dia.	ページ Page	商品コード Item code	在庫 Stock	直径 Tool dia.	溝長 Flute length	全長 Overall length	シャンク径 Shank dia.	ページ Page	商品コード Item code	在庫 Stock	直径 Tool dia.	溝長 Flute length	全長 Overall length	シャンク径 Shank dia.	ページ Page	商品コード Item code	在庫 Stock	直径 Tool dia.	溝長 Flute length	全長 Overall length	シャンク径 Shank dia.	ページ Page
03FWHNSB0740-TH	□	7.4	39	95	8	E38	05FWHNSB0760-TH	●	7.6	63	119	8	E21	15WHSNB0780-TH	●	7.8	145	200	8	E26	20WHSR0800-ATH	●	8	189	242	8	E56
03WHNSB0740-SD	□	7.4	39	95	8	E48	05FWHNSB0760-TH	●	7.6	63	119	8	E39	15FWHNSB0780-TH	□	7.8	145	200	8	E41	NSBH0800-200-ATH	●	8	200	255	10	E51
EWSR7.4	□	7.4	45	87	7.4	E91	05WHNSB0760-SD	□	7.6	63	119	8	E46	NSBH0780-150-ATH	□	7.8	150	205	8	E51	25WHNSB0800-TH	●	8	225	280	8	E28
04WNSB0740-TH	●	7.4	45	90	8	E36	08WHNSB0760-TH	●	7.6	88	144	8	E23	20WHNSB0780-TH	●	7.8	185	240	8	E27	25WHNSB0800-SD	●	8	225	280	8	E47
NSBH0740-60-ATH	□	7.4	60	115	8	E31	NSBH0760-90-ATH	□	7.6	90	145	8	E51	20FWHNSB0780-TH	□	7.8	185	240	8	E42	NSBH0800-250-ATH	●	8	250	305	10	E51
05WHNSB0740-TH	●	7.4	63	119	8	E21	10WHNSB0760-TH	●	7.6	105	160	8	E25	NSBH0780-200-ATH	□	7.8	200	255	8	E51	30WHNSB0800-TH	●	8	265	320	8	E29
05FWHNSB0740-TH	●	7.4	63	119	8	E39	10FWHNSB0760-TH	□	7.6	105	160	8	E40	25WHNSB0780-TH	●	7.8	225	280	8	E28	30FWHNSB0800-TH	●	8	265	320	8	E43
05WHNSB0740-SD	□	7.4	63	119	8	E46	NSBH0760-120-ATH	□	7.6	120	175	8	E51	NSBH0780-250-ATH	□	7.8	250	305	8	E51	30WHSR0800-ATH	●	8	269	322	8	E56
08WHNSB0740-TH	●	7.4	84	144	8	E23	15WHNSB0760-TH	●	7.6	145	200	8	E26	30WHNSB0780-TH	●	7.8	265	320	8	E29	40WHNSB0800-TH	◎	8	344	401	8	E31
NSBH0740-90-ATH	□	7.4	90	145	8	E23	15FWHNSB0760-TH	□	7.6	145	200	8	E41	30FWHNSB0780-TH	□	7.8	265	320	8	E43	50WHNSB0800-TH	◎	8	424	481	8	E32
10WHNSB0740-TH	●	7.4	98	153	8	E25	NSBH0760-150-ATH	□	7.6	150	205	8	E51	40WHNSB0780-TH	□	7.8	344	401	8	E31	03WHNSB0803-SD	●	8.03	44	101	9	E45
10FWHNSB0740-TH	□	7.4	98	153	8	E40	20WHNSB0760-TH	●	7.6	185	240	8	E27	50WHNSB0780-TH	□	7.8	424	481	8	E32	05WHNSB0803-SD	●	8.03	71	128	9	E46
NSBH0740-120-ATH	□	7.4	120	175	8	E51	20FWHNSB0760-TH	□	7.6	185	240	8	E42	ZPB0790-TH	□	7.9	28	70	8	E85	03WHNSB0805-TH	●	8.05	44	101	9	E20
15WHNSB0740-TH	●	7.4	136	191	8	E26	NSBH0760-200-ATH	□	7.6	200	255	8	E51	ZPBL0790-TH	□	7.9	28	120	6	E87	ZPB0810-TH	□	8.1	28	80	10	E86
15FWHNSB0740-TH	□	7.4	136	191	8	E41	25WHNSB0760-TH	●	7.6	225	280	8	E25	02WNSB0790-TH	□	7.9	34	76	8	E35	ZPBL0810-TH	□	8.1	28	130	8	E88
NSBH0740-150-ATH	□	7.4	150	205	8	E51	NSBH0760-250-ATH	□	7.6	250	305	8	E51	NSBH0790-35-ATH	□	7.9	35	90	8	E51	02WNSB0810-TH	□	8.1	36	80	9	E35
20WHNSB0740-TH	●	7.4	173	228	8	E27	30WHNSB0760-TH	●	7.6	265	320	8	E29	EWSS7.9	□	7.9	37	79	8	E90	EWSS8.1	□	8.1	37	79	9	E90
20FWHNSB0740-TH	□	7.4	173	228	8	E42	30FWHNSB0760-TH	□	7.6	265	320	8	E43	03WHNSB0790-TH	●	7.9	39	95	8	E20	03WHNSB0810-TH	●	8.1	44	101	9	E20
NSBH0740-200-ATH	□	7.4	200	255	8	E51	40WHNSB0760-TH	□	7.6	344	401	8	E31	03FWHNSB0790-TH	□	7.9	39	95	8	E48	03FWHNSB0810-TH	□	8.1	44	101	9	E38
25WHNSB0740-TH	●	7.4	211	266	8	E28	50WHNSB0760-TH	□	7.6	424	481	8	E32	03WHNSB0790-SD	□	7.9	39	95	8	E45	03WHNSB0810-SD	□	8.1	44	101	9	E45
30WHNSB0740-TH	●	7.4	248	303	8	E29	ZPB0770-TH	□	7.7	28	70	8	E85	EWSR7.9	□	7.9	48	90	7.9	E91	NSBH0810-45-ATH	□	8.1	45	105	10	E51
30FWHNSB0740-TH	□	7.4	248	303	8	E43	ZPBL0770-TH	□	7.7	28	120	6	E87	04WNSB0790-TH	●	7.9	48	90	8	E36	04WNSB0810-TH	●	8.1	52	96	9	E36
40WHNSB0740-TH	□	7.4	323	380	8	E31	02WNSB0770-TH	□	7.7	34	76	8	E35	NSBH0790-60-ATH	□	7.9	60	115	8	E51	EWSR8.1	□	8.1	53	96	8.1	E91
50WHNSB0740-TH	□	7.4	398	451	8	E32	NSBH0770-35-ATH	□	7.7	35	90	8	E51	05WHNSB0790-TH	●	7.9	63	119	8	E21	05WHNSB0810-TH	●	8.1	71	128	9	E21
ZPB0750-TH	□	7.5	26	70	8	E85	EWSS7.7	□	7.7	37	79	8	E90	05FWHNSB0790-TH	●	7.9	63	119	8	E39	05FWHNSB0810-TH	●	8.1	71	128	9	E39
ZPBL0750-TH	□	7.5	26	120	6	E87	03WHNSB0770-TH	●	7.7	39	95	8	E20	05WHNSB0790-SD	□	7.9	63	119	8	E46	05WHNSB0810-SD	□	8.1	71	128	9	E46
02WNSB0750-TH	●	7.5	32	76	8	E35	03FWHNSB0770-TH	□	7.7	39	95	8	E38	08WHNSB0790-TH	●	7.9	88	144	8	E23	NSBH0810-90-ATH	□	8.1	90	150	10	E51
EWSS7.5	□	7.5	34	74	8	E90	03WHNSB0770-SD	□	7.7	39	95	8	E48	NSBH0790-90-ATH	□	7.9	90	145	8	E51	08WHNSB0810-TH	□	8.1	94	156	9	E23
NSBH0750-35-ATH	□	7.5	35	90	8	E51	EWSR7.7	□	7.7	48	90	7.7	E91	10WHNSB0790-TH	□	7.9	105	160	8	E25	10WHNSB0810-TH	□	8.1	111	166	9	E25
03WHNSB0750-TH	●	7.5	39	95	8	E20	04WNSB0770-TH	●	7.7	48	90	8	E36	10FWHNSB0790-TH	□	7.9	105	160	8	E40	10FWHNSB0810-TH	□	8.1	111	166	9	E40
03FWHNSB0750-TH	●	7.5	39	95	8	E38	NSBH0770-60-ATH	□	7.7	60	115	8	E51	NSBH0790-120-ATH	□	7.9	120	175	8	E51	NSBH0810-120-ATH	□	8.1	120	180	10	E51
03WHNSB0750-SD	●	7.5	39	95	8	E45	05WHNSB0770-TH	●	7.7	63	119	8	E21	15WHNSB0790-TH	□	7.9	145	200	8	E26	NSBH0810-150-ATH	□	8.1	150	210	10	E51
EWSR7.5	□	7.5	45	87	7.5	E91	05FWHNSB0770-TH	□	7.7	63	119	8	E39	15FWHNSB0790-TH	□	7.9	145	200	8	E41	15WHNSB0810-TH	□	8.1	154	209	9	E26
EHSE7.5-TH	●	7.5	45	87	8	E80	05WHNSB0770-SD	□	7.7	63	119	8	E46	NSBH0790-150-ATH	□	7.9	150	205	8	E51	15FWHNSB0810-TH	□	8.1	154	209	9	E41
04WNSB0750-TH	●	7.5	45	90	8	E36	08WHNSB0770-TH	●	7.7	88	144	8	E23	20WHNSB0790-TH	●	7.9	185	240	8	E27	20WHNSB0810-TH	□	8.1	196	251	9	E27
NSBH0750-60-ATH	□	7.5	60	115	8	E51	NSBH0770-90-ATH	□	7.7	90	145	8	E51	20FWHNSB0790-TH	□	7.9	185	240	8	E42	20FWHNSB0810-TH	□	8.1	196	251	9	E42
05WHNSB0750-TH	●	7.5	63	119	8	E21	10WHNSB0770-TH	●	7.7	105	160	8	E25	NSBH0790-200-ATH	□	7.9	200	255	8	E51	NSBH0810-200-ATH	□	8.1	200	260	10	E51
05FWHNSB0750-TH	●	7.5	63	119	8	E39	10FWHNSB0770-TH	□	7.7	105	160	8	E40	25WHNSB0790-TH	□	7.9	225	280	8	E28	25WHNSB0810-TH	□	8.1	239	294	9	E28
05WHNSB0750-SD	●	7.5	63	119	8	E46	NSBH0770-120-ATH	□	7.7	120	175	8	E51	NSBH0790-250-ATH	□	7.9	250	305	8	E51	NSBH0810-250-ATH	□	8.1	250	310	10	E51
08WHNSB0750-TH	●	7.5	84	144	8	E23	15WHNSB0770-TH	●	7.7	145	200	8	E26	30WHNSB0790-TH	●	7.9	265	320	8	E29	30WHNSB0810-TH	□	8.1	281	336	9	E29
NSBH0750-90-ATH	□	7.5	90	145	8	E23	15FWHNSB0770-TH	□	7.7	145	200	8	E41	30FWHNSB0790-TH	□	7.9	265	320	8	E43	30FWHNSB0810-TH	□	8.1	281	336	9	E43
10WHNSB0750-TH	●	7.5	98	153	8	E25	NSBH0770-150-ATH	□	7.7	150	205	8	E51	40WHNSB0790-TH	□	7.9	344	401	8	E31	40WHNSB0810-TH	□	8.1	366	423	9	E31
10FWHNSB0750-TH	□	7.5	98	153	8	E40	20WHNSB0770-TH	●	7.7	185	240	8	E27	50WHNSB0790-TH	□	7.9	424	481	8	E32	ZPB0820-TH	□	8.2	28	80	10	E86
NSBH0750-120-ATH	□	7.5	120	175	8	E51	20FWHNSB0770-TH	□	7.7	185	240	8	E42	ZPB0800-TH	●	8	28	70	8	E86	ZPBL0820-TH	□	8.2	28	130	8	E88
15WHNSB0750-TH	●	7.5	136	191	8	E26	NS																				

単位 unit : mm

商品コード Item code	在庫 Stock	直径 Tool dia.	溝長 Flute length	全長 Overall length	シャンク 径 Shank dia.	ページ Page	商品コード Item code	在庫 Stock	直径 Tool dia.	溝長 Flute length	全長 Overall length	シャンク 径 Shank dia.	ページ Page	商品コード Item code	在庫 Stock	直径 Tool dia.	溝長 Flute length	全長 Overall length	シャンク 径 Shank dia.	ページ Page	商品コード Item code	在庫 Stock	直径 Tool dia.	溝長 Flute length	全長 Overall length	シャンク 径 Shank dia.	ページ Page
ZPB0830-TH	□	8.3	28	80	10	E86	STBH085M-ATH	●	8.5	60	125	12	E82	05WHNSB0870-SD	□	8.7	71	128	9	E46	NSBH0890-250-ATH	□	8.9	250	310	10	E52
ZPBL0830-TH	□	8.3	28	130	8	E88	STB085M-ATH	●	8.5	60	125	12	E83	NSBH0870-90-ATH	□	8.7	90	150	10	E51	25WHNSB0890-TH	□	8.9	254	309	9	E28
02WNSB0830-TH	□	8.3	36	80	9	E35	05WHNSB0850-TH	●	8.5	71	128	9	E21	08WHNSB0870-TH	□	8.7	99	156	9	E23	30WHNSB0890-TH	●	8.9	298	353	9	E29
EWSS8.3	□	8.3	37	79	9	E90	05FWHNSB0850-TH	●	8.5	71	128	9	E39	10WHNSB0870-TH	□	8.7	118	173	9	E25	30FWHNSB0890-TH	□	8.9	298	353	9	E43
03WHNSB0830-TH	●	8.3	44	101	9	E20	05WHNSB0850-SD	●	8.5	71	128	9	E46	10FWHNSB0870-TH	□	8.7	118	173	9	E40	40WHNSB0890-TH	□	8.9	387	444	9	E31
03FWHNSB0830-TH	●	8.3	44	101	9	E38	NSBH0850-90-ATH	●	8.5	90	150	10	E51	NSBH0870-120-ATH	□	8.7	120	180	10	E51	ZPB0900-TH	●	9	28	80	10	E86
03WHNSB0830-SD	□	8.3	44	101	9	E45	08WHNSB0850-TH	●	8.5	94	156	9	E23	NSBH0870-150-ATH	□	8.7	150	210	10	E51	ZPBL0900-TH	□	9	28	130	8	E88
NSBH0830-45-ATH	□	8.3	45	105	10	E51	08WHSR0850-ATH	●	8.5	99	154	10	E56	15WHNSB0870-TH	□	8.7	163	218	9	E26	02WNSB0900-TH	●	9	38	80	9	E35
04WNSB0830-TH	●	8.3	52	96	9	E36	10WHNSB0850-TH	●	8.5	111	166	9	E25	15FWHNSB0870-TH	□	8.7	163	218	9	E41	EWSS9.0	□	9	40	84	9	E90
EWSR8.3	□	8.3	53	96	8.3	E91	10FWHNSB0850-TH	□	8.5	111	166	9	E40	NSBH0870-200-ATH	□	8.7	200	260	10	E51	03WHNSB0900-TH	●	9	44	101	9	E20
05WHNSB0830-TH	●	8.3	71	128	9	E21	NSBH0850-120-ATH	□	8.5	120	180	10	E51	NSBH0870-200-TH	□	8.7	208	263	9	E27	03FWHNSB0900-TH	●	9	44	101	9	E38
05FWHNSB0830-TH	●	8.3	71	128	9	E39	NSBH0850-150-ATH	●	8.5	150	210	10	E51	20FWHNSB0870-TH	□	8.7	208	263	9	E42	03WHNSB0900-SD	●	9	44	101	9	E45
05WHNSB0830-SD	□	8.3	71	128	9	E46	15WHNSB0850-TH	●	8.5	154	209	9	E26	NSBH0870-250-ATH	□	8.7	250	310	10	E51	NSBH0900-45-ATH	●	9	45	105	10	E52
NSBH0830-90-ATH	□	8.3	90	150	10	E51	15FWHNSB0850-TH	□	8.5	154	209	9	E41	25WHNSB0870-TH	□	8.7	254	309	9	E28	04WNSB0900-TH	●	9	54	96	9	E36
03FWHNSB0830-TH	●	8.3	94	156	9	E23	15WHNSB0850-SD	□	8.5	154	209	9	E47	30WHNSB0870-TH	□	8.7	298	353	9	E29	EHSE9.0-TH	□	9	55	98	9	E80
03WHNSB0830-SD	□	8.3	94	156	9	E45	20WHNSB0850-TH	●	8.5	196	251	9	E27	30FWHNSB0870-TH	□	8.7	298	353	9	E43	EWSR9.0	□	9	55	98	9	E91
NSBH0830-45-ATH	□	8.3	111	166	9	E25	20FWHNSB0850-TH	□	8.5	196	251	9	E42	40WHNSB0870-TH	□	8.7	387	444	9	E31	05WHNSB0900-TH	●	9	71	128	9	E21
10WHNSB0830-TH	●	8.3	111	166	9	E40	NSBH0850-200-ATH	●	8.5	200	260	10	E51	ZPB0880-TH	□	8.8	28	80	10	E86	05FWHNSB0900-TH	□	9	71	128	9	E39
10FWHNSB0830-TH	□	8.3	111	166	9	E40	20WHSR0850-ATH	●	8.5	201	256	10	E56	ZPBL0880-TH	□	8.8	28	130	8	E88	NSBH0900-SD	●	9	71	128	9	E46
NSBH0830-120-ATH	□	8.3	120	180	10	E51	25WHNSB0850-TH	●	8.5	239	294	9	E28	02WNSB0880-TH	●	8.8	38	80	9	E35	NSBH0900-90-ATH	●	9	90	150	10	E52
NSBH0830-150-ATH	□	8.3	150	210	10	E51	NSBH0850-250-ATH	●	8.5	250	310	10	E51	EWSS8.8	□	8.8	40	84	9	E90	08WHNSB0900-TH	●	9	99	156	9	E23
15WHNSB0830-TH	●	8.3	154	209	9	E26	30WHNSB0850-TH	●	8.5	281	336	9	E29	03WHNSB0880-TH	□	8.8	44	101	9	E20	08WHSR0900-ATH	●	9	104	158	10	E56
15FWHNSB0830-TH	□	8.3	154	209	9	E41	30FWHNSB0850-TH	□	8.5	281	336	9	E43	03FWHNSB0880-TH	□	8.8	44	101	9	E38	10WHNSB0900-TH	●	9	118	173	9	E25
20WHNSB0830-TH	●	8.3	196	251	9	E27	30WHSR0850-ATH	●	8.5	286	341	10	E56	NSBH0880-SD	●	8.8	44	101	9	E45	10FWHNSB0900-TH	●	9	118	173	9	E40
20FWHNSB0830-TH	□	8.3	196	251	9	E42	40WHNSB0850-TH	◎	8.5	366	423	9	E31	NSBH0880-45-ATH	●	8.8	45	105	10	E52	NSBH0900-120-ATH	●	9	120	180	10	E52
NSBH0830-200-ATH	□	8.3	200	260	10	E51	03WHNSB0853-SD	●	8.53	44	101	9	E45	04WNSB0880-TH	□	8.8	54	96	9	E36	NSBH0900-150-ATH	●	9	150	210	10	E52
25WHNSB0830-TH	●	8.3	239	294	9	E28	05WHNSB0853-SD	●	8.53	71	128	9	E46	EWSR8.8	□	8.8	55	98	8.8	E91	15WHNSB0900-TH	●	9	163	218	9	E26
NSBH0830-250-ATH	□	8.3	250	310	10	E51	ZPB0860-TH	□	8.6	28	80	10	E86	EHSE8.8-TH	●	8.8	55	98	9	E80	15FWHNSB0900-TH	●	9	163	218	9	E41
30WHNSB0830-TH	●	8.3	281	336	9	E29	ZPBL0860-TH	□	8.6	28	130	8	E88	05WHNSB0880-TH	□	8.8	71	128	9	E21	05WHNSB0900-SD	●	9	163	218	9	E47
30FWHNSB0830-TH	□	8.3	281	336	9	E43	02WNSB0860-TH	□	8.6	38	80	9	E35	05FWHNSB0880-TH	□	8.8	71	128	9	E39	NSBH0900-200-ATH	●	9	200	260	10	E52
40WHNSB0830-TH	□	8.3	366	423	9	E31	EWSS8.6	□	8.6	40	84	9	E90	05WHNSB0880-SD	□	8.8	71	128	9	E46	20WHNSB0900-TH	●	9	208	263	9	E27
ZPB0840-TH	□	8.4	28	80	10	E86	03WHNSB0860-TH	□	8.6	44	101	9	E20	NSBH0880-90-ATH	□	8.8	90	150	10	E52	20FWHNSB0900-TH	□	9	208	263	9	E42
ZPBL0840-TH	□	8.4	28	130	8	E88	03FWHNSB0860-TH	●	8.6	44	101	9	E38	08WHNSB0880-TH	●	8.8	99	156	9	E23	20WHSR0900-ATH	●	9	213	267	10	E56
02WNSB0840-TH	●	8.4	36	80	9	E35	03WHNSB0860-SD	□	8.6	44	101	9	E45	10WHNSB0880-TH	□	8.8	118	173	9	E25	NSBH0900-250-ATH	●	9	250	310	10	E52
EWSS8.4	□	8.4	37	79	9	E90	NSBH0860-45-ATH	□	8.6	45	105	10	E51	10FWHNSB0880-TH	□	8.8	118	173	9	E40	25WHNSB0900-TH	●	9	254	309	9	E28
03WHNSB0840-TH	●	8.4	44	101	9	E20	04WNSB0860-TH	□	8.6	54	96	9	E36	NSBH0880-120-ATH	□	8.8	120	180	10	E52	30WHNSB0900-TH	●	9	298	353	9	E29
03FWHNSB0840-TH	□	8.4	44	101	9	E38	EWSR8.6	□	8.6	55	98	8.6	E91	NSBH0880-150-ATH	□	8.8	150	210	10	E52	30FWHNSB0900-TH	●	9	298	353	9	E43
03WHNSB0840-SD	□	8.4	44	101	9	E45	EHSE8.6-TH	□	8.6	55	98	9	E80	15WHNSB0880-TH	□	8.8	163	218	9	E26	30WHSR0900-ATH	●	9	303	357	10	E56
NSBH0840-45-ATH	□	8.4	45	105	10	E51	05WHNSB0860-TH	□	8.6	71	128	9	E21	15FWHNSB0880-TH	□	8.8	163	218	9	E41	40WHNSB0900-TH	□	9	387	444	9	E31
04WNSB0840-TH	●	8.4	52	96	9	E36	05FWHNSB0860-TH	□	8.6	71	128	9	E39	NSBH0880-200-ATH	□	8.8	200	260	10	E52	03WHNSB0903-SD	●	9.03	49	107	10	E45
EWSR8.4	□	8.4	53	96	8.4	E91	05WHNSB0860-SD	□	8.6	71	128	9	E46	20WHNSB0880-TH	●	8.8	208	263	9	E27	05WHNSB0903-SD	□	9.03	79	137	10	E46
05WHNSB0840-TH	□	8.4	71	128	9	E21	NSBH0860-90-ATH	□	8.6	90	150	10	E51	02WHNSB0880-TH	□	8.8	208	263	9	E42	ZPB0910-TH	□	9.1	30	80	10	E86
05FWHNSB0840-TH	□	8.4	71	128	9	E39	08WHNSB0860-TH	□	8.6	99	156	9	E23	NSBH0880-250-ATH	□	8.8	250	310	10	E52	ZPBL0910-TH	□	9.1	30	130	8	E88
05WHNSB0840-SD	□	8.4	71	128	9	E46	10WHNSB0860-TH	□	8.6	118	173	9	E25	25WHNSB0880-TH	□	8.8	254	309	9	E28	EWSS9.1	□	9.1	40	84	10	E90
NSBH0840-90-ATH	□	8.4	90	150	10	E51	10FWHNSB0860-TH	□	8.6	118	173	9	E40	30WHNSB0880-TH	●	8.8	298	353	9	E29	02WNSB0910-TH	□	9.1	40	85	10	E35
08WHNSB0840-TH	●	8.4	94	156	9	E23	NSBH0860-120-ATH	□	8.6	120	180	10	E51	40WHNSB0880-TH	□	8.8	387	444	9	E31	03WHNSB0910-TH	□	9.1	49	107	10	E20
10WHNSB0840-TH	●	8.4	111	166	9	E25	NSBH0860-150-ATH	□	8.6	150	210	10	E51	ZPB0890-TH	□	8.9	28	80	10	E86	03FWHNSB0910-TH	□	9.1	49	107	10	E38
10FWHNSB0840-TH	□	8.4	111	166	9	E40	15WHNSB0860-TH	□	8.6	163	218	9	E26	ZPBL0890-TH	□	8.9	28	130	8	E88	03WHNSB0910-SD	□	9.1	49	107	10	E45
NSBH0840-120-ATH	□	8.4	120	180	10	E51	15FWHNSB0860-TH	□	8.6	163	218	9	E41	02WNSB0890-TH	□	8.9	38	80	9	E35	NSBH0910-50-ATH	□	9.1	50	110	10	E52
NSBH0840-150-ATH	□	8.4	150	210	10	E51	15WHNSB0860-SD	□	8.6	163	218	9	E47	EWSS8.9	□	8.9	40	84	9	E90	04WNSB0910-TH	●	9.1	57	104	10	E36
15WHNSB0840-TH	●	8.4	154	209	9	E26	NSBH0860-200-ATH	□	8.6																		

Quick dimension reference table by tool diameter

直径別寸法早見表

φ9.2~φ11.1

単位 unit : mm

商品コード Item code	在庫 Stock	直径 Tool dia.	溝長 Flute length	全長 Overall length	シャンク径 Shank dia.	ページ Page	商品コード Item code	在庫 Stock	直径 Tool dia.	溝長 Flute length	全長 Overall length	シャンク径 Shank dia.	ページ Page	商品コード Item code	在庫 Stock	直径 Tool dia.	溝長 Flute length	全長 Overall length	シャンク径 Shank dia.	ページ Page
ZPB0920-TH	□	9.2	30	80	10	E86	05FWHNSB0940-TH	●	9.4	79	137	10	E39	25WHSNSB0980-TH	●	9.8	282	337	10	E28
ZPBL0920-TH	□	9.2	30	130	8	E88	05WHSNSB0940-SD	□	9.4	79	137	10	E46	10WHSNSB0960-TH	□	9.6	131	186	10	E25
EWSS9.2	□	9.2	40	84	10	E90	NSBH0940-90-ATH	□	9.4	90	150	10	E52	10FWHNSB0960-TH	□	9.6	131	186	10	E40
02WHSNSB0920-TH	□	9.2	40	85	10	E35	08WHSNSB0940-TH	●	9.4	105	168	10	E23	NSBH0960-150-ATH	□	9.6	150	210	10	E52
03WHSNSB0920-TH	□	9.2	49	107	10	E20	NSBH0940-120-ATH	□	9.4	120	180	10	E52	15WHSNSB0960-TH	□	9.6	181	236	10	E26
03FWHNSB0920-TH	□	9.2	49	107	10	E38	10WHSNSB0940-TH	●	9.4	124	179	10	E25	15FWHNSB0960-TH	□	9.6	181	236	10	E41
03WHSNSB0920-SD	□	9.2	49	107	10	E45	10FWHNSB0940-TH	□	9.4	124	179	10	E40	NSBH0960-200-ATH	□	9.6	200	260	10	E52
NSBH0920-50-ATH	□	9.2	50	110	10	E52	NSBH0940-150-ATH	□	9.4	150	210	10	E52	20WHSNSB0960-TH	□	9.6	231	286	10	E27
04WHSNSB0920-TH	●	9.2	57	104	10	E36	15WHSNSB0940-TH	●	9.4	172	227	10	E26	20FWHNSB0960-TH	□	9.6	231	286	10	E42
EWSR9.2	□	9.2	58	102	9.2	E91	15FWHNSB0940-TH	□	9.4	172	227	10	E41	NSBH0960-250-ATH	□	9.6	250	310	10	E52
05WHSNSB0920-TH	□	9.2	79	137	10	E21	NSBH0940-200-ATH	□	9.4	200	260	10	E52	25WHSNSB0960-TH	□	9.6	282	337	10	E28
05FWHNSB0920-TH	●	9.2	79	137	10	E39	20WHSNSB0940-TH	●	9.4	219	274	10	E27	NSBH0960-300-ATH	□	9.6	300	360	10	E52
05WHSNSB0920-SD	□	9.2	79	137	10	E46	20FWHNSB0940-TH	□	9.4	219	274	10	E42	30WHSNSB0960-TH	□	9.6	331	386	10	E29
NSBH0920-90-ATH	□	9.2	90	150	10	E52	NSBH0940-250-ATH	□	9.4	250	310	10	E52	30FWHNSB0960-TH	□	9.6	331	386	10	E43
08WHSNSB0920-TH	□	9.2	105	168	10	E23	25WHSNSB0940-TH	●	9.4	268	323	10	E28	40WHSNSB0960-TH	□	9.6	430	487	10	E31
NSBH0920-120-ATH	□	9.2	120	180	10	E52	NSBH0940-300-ATH	□	9.4	300	360	10	E52	ZPB0970-TH	□	9.7	32	80	10	E86
10WHSNSB0920-TH	□	9.2	124	179	10	E25	30WHSNSB0940-TH	●	9.4	314	369	10	E29	ZPBL0970-TH	□	9.7	32	130	8	E88
10FWHNSB0920-TH	□	9.2	124	179	10	E40	30FWHNSB0940-TH	□	9.4	314	369	10	E43	02WNSB0970-TH	□	9.7	41	85	10	E35
NSBH0920-150-ATH	□	9.2	150	210	10	E52	40WHSNSB0940-TH	□	9.4	409	466	10	E31	EWSR9.7	□	9.7	43	89	10	E90
15WHSNSB0920-TH	□	9.2	172	227	10	E26	ZPB0950-TH	●	9.5	30	80	10	E86	03WHSNSB0970-TH	□	9.7	49	107	10	E20
15FWHNSB0920-TH	□	9.2	172	227	10	E41	ZPBL0950-TH	□	9.5	30	130	8	E88	03FWHNSB0970-TH	□	9.7	49	107	10	E38
NSBH0920-200-ATH	□	9.2	200	260	10	E52	EWSR9.5	□	9.5	40	84	10	E90	03WHSNSB0970-SD	□	9.7	49	107	10	E45
20WHSNSB0920-TH	□	9.2	219	274	10	E27	02WNSB0950-TH	●	9.5	40	85	10	E35	NSBH0970-50-ATH	□	9.7	50	110	10	E52
20FWHNSB0920-TH	□	9.2	219	274	10	E42	03WHSNSB0950-TH	□	9.5	49	107	10	E20	03WHSNSB0970-TH	●	9.7	60	104	10	E36
NSBH0920-250-ATH	□	9.2	250	310	10	E52	03FWHNSB0950-TH	●	9.5	49	107	10	E38	EWSR9.7	□	9.7	60	105	9.7	E91
25WHSNSB0920-TH	□	9.2	268	323	10	E28	03WHSNSB0950-SD	●	9.5	49	107	10	E45	05WHSNSB0970-TH	□	9.7	79	137	10	E21
NSBH0920-300-ATH	□	9.2	300	360	10	E52	NSBH0950-50-ATH	□	9.5	50	110	10	E52	05FWHNSB0970-TH	●	9.7	79	137	10	E39
30WHSNSB0920-TH	□	9.2	314	369	10	E29	04WNSB0950-TH	●	9.5	57	104	10	E36	05WHSNSB0970-SD	□	9.7	79	137	10	E46
30FWHNSB0920-TH	□	9.2	314	369	10	E43	ZPB0950-TH	□	9.5	58	102	9.5	E91	NSBH0970-90-ATH	□	9.7	90	150	10	E52
40WHSNSB0920-TH	□	9.2	409	466	10	E31	EHSE9.5-TH	●	9.5	58	102	10	E80	08WHSNSB0970-TH	□	9.7	110	168	10	E23
ZPB0930-TH	□	9.3	30	80	10	E86	05WHSNSB0950-TH	●	9.5	79	137	10	E21	NSBH0970-120-ATH	□	9.7	120	180	10	E52
ZPBL0930-TH	□	9.3	30	130	8	E88	05FWHNSB0950-TH	●	9.5	79	137	10	E39	10WHSNSB0970-TH	□	9.7	131	186	10	E25
EWSR9.3	□	9.3	40	84	10	E90	05WHSNSB0950-SD	□	9.5	79	137	10	E46	10FWHNSB0970-TH	□	9.7	131	186	10	E40
02WNSB0930-TH	□	9.3	40	85	10	E35	NSBH0950-90-ATH	□	9.5	90	150	10	E52	NSBH0970-150-ATH	□	9.7	150	210	10	E52
03WHSNSB0930-TH	●	9.3	49	107	10	E20	08WHSNSB0950-TH	●	9.5	105	168	10	E23	15WHSNSB0970-TH	□	9.7	181	236	10	E26
03FWHNSB0930-TH	□	9.3	49	107	10	E38	08WHSR0950-ATH	●	9.5	110	165	10	E56	15FWHNSB0970-TH	□	9.7	181	236	10	E41
03WHSNSB0930-SD	□	9.3	49	107	10	E45	NSBH0950-120-ATH	□	9.5	120	180	10	E52	NSBH0970-200-ATH	□	9.7	200	260	10	E27
NSBH0930-50-ATH	□	9.3	50	110	10	E52	10WHSNSB0950-TH	□	9.5	124	179	10	E25	20WHSNSB0970-TH	□	9.7	231	286	10	E27
04WNSB0930-TH	●	9.3	57	104	10	E36	10FWHNSB0950-TH	□	9.5	124	179	10	E40	20FWHNSB0970-TH	□	9.7	231	286	10	E42
EWSR9.3	□	9.3	58	102	9.3	E91	NSBH0950-150-ATH	□	9.5	150	210	10	E52	NSBH0970-250-ATH	□	9.7	250	310	10	E52
05WHSNSB0930-TH	□	9.3	79	137	10	E21	15WHSNSB0950-TH	●	9.5	172	227	10	E26	25WHSNSB0970-TH	□	9.7	282	337	10	E28
05FWHNSB0930-TH	●	9.3	79	137	10	E39	15FWHNSB0950-TH	□	9.5	172	227	10	E41	NSBH0970-300-ATH	□	9.7	300	360	10	E52
05WHSNSB0930-SD	□	9.3	79	137	10	E46	15WHSNSB0950-SD	□	9.5	172	227	10	E47	30WHSNSB0970-TH	□	9.7	331	386	10	E29
NSBH0930-90-ATH	□	9.3	90	150	10	E52	NSBH0950-200-ATH	□	9.5	200	260	10	E52	30FWHNSB0970-TH	□	9.7	331	386	10	E43
08WHSNSB0930-TH	●	9.3	105	168	10	E23	20WHSNSB0950-TH	●	9.5	219	274	10	E27	40WHSNSB0970-TH	□	9.7	430	487	10	E31
NSBH0930-120-ATH	□	9.3	120	180	10	E52	20FWHNSB0950-TH	□	9.5	219	274	10	E42	ZPB0980-TH	□	9.8	32	80	10	E86
10WHSNSB0930-TH	□	9.3	124	179	10	E25	20WHSR0950-ATH	●	9.5	224	279	10	E56	ZPBL0980-TH	□	9.8	32	130	8	E88
10FWHNSB0930-TH	□	9.3	124	179	10	E40	NSBH0950-250-ATH	□	9.5	250	310	10	E52	02WNSB0980-TH	●	9.8	41	85	10	E35
NSBH0930-150-ATH	□	9.3	150	210	10	E52	25WHSNSB0950-TH	●	9.5	268	323	10	E28	EWSR9.8	□	9.8	43	89	10	E90
15WHSNSB0930-TH	●	9.3	172	227	10	E26	NSBH0950-300-ATH	□	9.5	300	360	10	E52	03WHSNSB0980-TH	●	9.8	49	107	10	E20
15FWHNSB0930-TH	□	9.3	172	227	10	E41	30WHSNSB0950-TH	□	9.5	314	369	10	E29	03FWHNSB0980-TH	●	9.8	49	107	10	E38
NSBH0930-200-ATH	□	9.3	200	260	10	E52	30FWHNSB0950-TH	□	9.5	314	369	10	E43	03WHSNSB0980-SD	□	9.8	49	107	10	E45
20WHSNSB0930-TH	●	9.3	219	274	10	E27	30WHSR0950-ATH	●	9.5	320	374	10	E56	NSBH0980-50-ATH	□	9.8	50	110	10	E52
20FWHNSB0930-TH	□	9.3	219	274	10	E42	40WHSNSB0950-TH	□	9.5	409	466	10	E31	04WNSB0980-TH	●	9.8	60	104	10	E36
NSBH0930-250-ATH	□	9.3	250	310	10	E52	03WHSNSB0953-SD	●	9.53	49	107	10	E45	EWSR9.8	□	9.8	60	105	9.8	E91
25WHSNSB0930-TH	●	9.3	268	323	10	E28	05WHSNSB0953-SD	●	9.53	79	137	10	E46	EHSE9.8-TH	□	9.8	60	105	10	E80
NSBH0930-300-ATH	□	9.3	300	360	10	E52	ZPB0960-TH	□	9.6	32	80	10	E86	05WHSNSB0980-TH	●	9.8	79	137	10	E21
30WHSNSB0930-TH	●	9.3	314	369	10	E29	ZPBL0960-TH	□	9.6	32	130	8	E88	05FWHNSB0980-TH	●	9.8	79	137	10	E39
30FWHNSB0930-TH	□	9.3	314	369	10	E43	02WNSB0960-TH	□	9.6	41	85	10	E35	05WHSNSB0980-SD	□	9.8	79	137	10	E46
40WHSNSB0930-TH	□	9.3	409	466	10	E31	EWSR9.6	□	9.6	43	89	10	E90	NSBH0980-90-ATH	□	9.8	90	150	10	E52
ZPB0940-TH	□	9.4	30	80	10	E86	03WHSNSB0960-TH	□	9.6	49	107	10	E20	08WHSNSB0980-TH	●	9.8	110	168	10	E23
ZPBL0940-TH	□	9.4	30	130	8	E88	03FWHNSB0960-TH	□	9.6	49	107	10	E38	NSBH0980-120-ATH	□	9.8	120	180	10	E52
EWSR9.4	□	9.4	40	84	10	E90	03WHSNSB0960-SD	□	9.6	49	107	10	E45	10WHSNSB0980-TH	□	9.8	131	186	10	E25
02WNSB0940-TH	□	9.4	40	85	10	E35	NSBH0960-50-ATH	□	9.6	50	110	10	E52	10FWHNSB0980-TH	□	9.8	131	186	10	E40
03WHSNSB0940-TH	●	9.4	49	107	10	E20	04WNSB0960-TH	●	9.6	60	104	10	E36	NSBH0980-150-ATH	□	9.8	150	210		

単位 unit : mm

商品コード Item code	在庫 Stock	直径 Tool dia.	溝長 Flute length	全長 Overall length	シャンク 径 Shank dia.	ページ Page	商品コード Item code	在庫 Stock	直径 Tool dia.	溝長 Flute length	全長 Overall length	シャンク 径 Shank dia.	ページ Page	商品コード Item code	在庫 Stock	直径 Tool dia.	溝長 Flute length	全長 Overall length	シャンク 径 Shank dia.	ページ Page	商品コード Item code	在庫 Stock	直径 Tool dia.	溝長 Flute length	全長 Overall length	シャンク 径 Shank dia.	ページ Page
05WHNSB1003-SD	●	10.03	87	150	11	E46	NSBH1030-120-ATH	□	10.3	120	180	12	E52	ZPBL1060-TH	□	10.6	33	150	10	E88	NSBH1080-200-ATH	□	10.8	200	260	12	E53
ZPB1010-TH	□	10.1	33	90	12	E86	10WHNSB1030-TH	●	10.3	138	193	11	E25	EWSS10.6	□	10.6	43	89	11	E90	NSBH1080-250-ATH	□	10.8	250	310	12	E53
ZPBL1010-TH	□	10.1	33	150	10	E88	10FWHNSB1030-TH	□	10.3	138	193	11	E40	02WNSB1060-TH	●	10.6	44	90	11	E35	20WHNSB1080-TH	●	10.8	254	315	11	E27
02WNSB1010-TH	□	10.1	42	90	11	E35	NSBH1030-150-ATH	□	10.3	150	210	12	E52	NSBH1060-50-ATH	●	10.6	50	110	12	E53	20FWHNSB1080-TH	□	10.8	254	315	11	E42
EWSS10.1	□	10.1	43	89	11	E90	15WHNSB1030-TH	●	10.3	190	245	11	E26	03WHNSB1060-TH	□	10.6	54	117	11	E20	NSBH1080-300-ATH	□	10.8	300	360	12	E53
NSBH1010-50-ATH	□	10.1	50	110	12	E52	15FWHNSB1030-TH	□	10.3	190	245	11	E41	03FWHNSB1060-TH	□	10.6	54	117	11	E38	25WHNSB1080-TH	●	10.8	310	371	11	E28
03WHNSB1010-TH	□	10.1	54	117	11	E20	NSBH1030-200-ATH	□	10.3	200	260	12	E52	04WNSB1060-TH	●	10.6	66	112	11	E36	30WHNSB1080-TH	●	10.8	364	425	11	E29
03FWHNSB1010-TH	□	10.1	54	117	11	E38	20WHNSB1030-TH	●	10.3	243	298	11	E27	EWSR10.6	□	10.6	68	114	10.6	E91	ZPB1090-TH	□	10.9	33	90	12	E86
04WNSB1010-TH	●	10.1	63	112	11	E36	20FWHNSB1030-TH	□	10.3	243	298	11	E42	05WHNSB1060-TH	□	10.6	87	150	11	E21	ZPBL1090-TH	□	10.9	33	150	10	E88
EWSR10.1	□	10.1	66	112	10.1	E91	NSBH1030-250-ATH	□	10.3	250	310	12	E52	05FWHNSB1060-TH	□	10.6	87	150	11	E39	02WNSB1090-TH	□	10.9	44	90	11	E35
05WHNSB1010-TH	□	10.1	87	150	11	E21	25WHNSB1030-TH	●	10.3	297	358	11	E28	NSBH1060-90-ATH	□	10.6	90	150	12	E53	EWSS10.9	□	10.9	47	95	11	E90
05FWHNSB1010-TH	□	10.1	87	150	11	E39	NSBH1030-300-ATH	□	10.3	300	360	12	E52	NSBH1060-120-ATH	□	10.6	120	180	12	E53	NSBH1090-50-ATH	●	10.9	50	110	12	E53
NSBH1010-90-ATH	□	10.1	90	150	12	E52	30WHNSB1030-TH	●	10.3	348	403	11	E29	08WHNSB1060-TH	□	10.6	121	184	11	E23	03WHNSB1090-TH	●	10.9	54	117	11	E20
08WHNSB1010-TH	□	10.1	116	184	11	E23	ZPB1040-TH	□	10.4	33	90	12	E86	10WHNSB1060-TH	□	10.6	144	205	11	E25	03FWHNSB1090-TH	□	10.9	54	117	11	E38
NSBH1010-120-ATH	□	10.1	120	180	12	E52	ZPBL1040-TH	□	10.4	33	150	10	E88	10FWHNSB1060-TH	□	10.6	144	205	11	E40	04WNSB1090-TH	●	10.9	66	112	11	E36
10WHNSB1010-TH	□	10.1	138	193	11	E25	02WNSB1040-TH	□	10.4	42	90	11	E35	NSBH1060-150-ATH	□	10.6	150	210	12	E53	EWSR10.9	□	10.9	68	114	10.9	E91
10FWHNSB1010-TH	□	10.1	138	193	11	E40	EWSS10.4	□	10.4	43	89	11	E90	15WHNSB1060-TH	□	10.6	199	260	11	E41	05WHNSB1090-TH	●	10.9	87	150	11	E21
NSBH1010-150-ATH	□	10.1	150	210	12	E52	NSBH1040-50-ATH	●	10.4	50	110	12	E52	15FWHNSB1060-TH	□	10.6	199	260	11	E41	05FWHNSB1090-TH	□	10.9	87	150	11	E39
15WHNSB1010-TH	□	10.1	190	245	11	E26	03WHNSB1040-TH	●	10.4	54	117	11	E20	NSBH1060-200-ATH	□	10.6	200	260	12	E53	NSBH1090-90-ATH	□	10.9	90	150	12	E53
15FWHNSB1010-TH	□	10.1	190	245	11	E41	03FWHNSB1040-TH	□	10.4	54	117	11	E38	NSBH1060-250-ATH	□	10.6	250	310	12	E53	NSBH1090-120-ATH	□	10.9	120	180	12	E53
NSBH1010-200-ATH	□	10.1	200	260	12	E52	04WNSB1040-TH	●	10.4	63	112	11	E36	20WHNSB1060-TH	□	10.6	254	315	11	E27	08WHNSB1090-TH	●	10.9	121	184	11	E23
20WHNSB1010-TH	□	10.1	243	298	11	E27	EWSR10.4	□	10.4	66	112	10.4	E91	20FWHNSB1060-TH	□	10.6	254	315	11	E42	10WHNSB1090-TH	●	10.9	144	205	11	E25
20FWHNSB1010-TH	□	10.1	243	298	11	E42	EHSE10.4-TH	□	10.4	66	112	11	E80	NSBH1060-300-ATH	□	10.6	300	360	12	E53	10FWHNSB1090-TH	□	10.9	144	205	11	E40
NSBH1010-250-ATH	□	10.1	250	310	12	E52	05WHNSB1040-TH	□	10.4	87	150	11	E21	10FWHNSB1060-TH	□	10.6	310	371	11	E28	NSBH1090-150-ATH	□	10.9	150	210	12	E53
25WHNSB1010-TH	□	10.1	297	358	11	E28	05FWHNSB1040-TH	□	10.4	87	150	11	E39	30WHNSB1060-TH	□	10.6	364	425	11	E29	15WHNSB1090-TH	●	10.9	199	260	11	E26
NSBH1010-300-ATH	□	10.1	300	360	12	E52	NSBH1040-90-ATH	□	10.4	90	150	12	E52	ZPB1070-TH	□	10.7	33	90	12	E86	15FWHNSB1090-TH	□	10.9	199	260	11	E41
30WHNSB1010-TH	□	10.1	348	403	11	E29	08WHNSB1040-TH	●	10.4	116	184	11	E23	ZPBL1070-TH	□	10.7	33	150	10	E88	NSBH1090-200-ATH	□	10.9	200	260	12	E53
ZPB1020-TH	□	10.2	33	90	12	E86	NSBH1040-120-ATH	□	10.4	120	180	12	E52	02WNSB1070-TH	□	10.7	44	90	11	E35	NSBH1090-250-ATH	□	10.9	250	310	12	E53
ZPBL1020-TH	□	10.2	33	150	10	E88	10WHNSB1040-TH	●	10.4	138	193	11	E25	EWSS10.7	□	10.7	47	95	11	E90	20WHNSB1090-TH	●	10.9	254	315	11	E27
02WNSB1020-TH	●	10.2	42	90	11	E35	10FWHNSB1040-TH	□	10.4	138	193	11	E40	NSBH1070-50-ATH	□	10.7	50	110	12	E53	20FWHNSB1090-TH	□	10.9	254	315	11	E42
EWSS10.2	□	10.2	43	89	11	E90	NSBH1040-150-ATH	□	10.4	150	210	12	E52	03WHNSB1070-TH	□	10.7	54	117	11	E20	NSBH1090-300-ATH	□	10.9	300	360	12	E53
NSBH1020-50-ATH	□	10.2	50	110	12	E52	15WHNSB1040-TH	●	10.4	190	245	11	E26	03FWHNSB1070-TH	□	10.7	54	117	11	E38	25WHNSB1090-TH	●	10.9	310	371	11	E28
03WHNSB1020-TH	●	10.2	54	117	11	E20	15FWHNSB1040-TH	□	10.4	190	245	11	E41	04WNSB1070-TH	●	10.7	66	112	11	E36	30WHNSB1090-TH	●	10.9	364	425	11	E29
03FWHNSB1020-TH	●	10.2	54	117	11	E38	NSBH1040-200-ATH	□	10.4	200	260	12	E52	EWSR10.7	□	10.7	68	114	10.7	E91	ZPB1100-TH	●	11	33	90	12	E86
04WNSB1020-TH	●	10.2	63	112	11	E36	20WHNSB1040-TH	●	10.4	243	298	11	E27	05WHNSB1070-TH	□	10.7	87	150	11	E21	ZPBL1100-TH	□	11	33	150	10	E88
EWSR10.2	□	10.2	66	112	10.2	E91	20FWHNSB1040-TH	□	10.4	243	298	11	E42	05FWHNSB1070-TH	□	10.7	87	150	11	E39	02WNSB1100-TH	●	11	44	90	11	E35
05WHNSB1020-TH	●	10.2	87	150	11	E21	NSBH1040-250-ATH	□	10.4	250	310	12	E52	NSBH1070-90-ATH	□	10.7	90	150	12	E53	EWSS11.0	□	11	47	95	11	E90
05FWHNSB1020-TH	●	10.2	87	150	11	E39	25WHNSB1040-TH	●	10.4	297	358	11	E28	NSBH1070-120-ATH	□	10.7	120	180	12	E53	NSBH1100-100-TH	□	11	54	117	11	E20
NSBH1020-90-ATH	□	10.2	90	150	12	E52	NSBH1040-300-ATH	□	10.4	300	360	12	E52	08WHNSB1070-TH	●	10.7	121	184	11	E23	03FWHNSB1100-TH	□	11	54	117	11	E38
08WHNSB1020-TH	●	10.2	116	184	11	E23	30WHNSB1040-TH	●	10.4	348	403	11	E29	10WHNSB1070-TH	□	10.7	144	205	11	E25	NSBH1100-55-ATH	●	11	55	120	12	E53
NSBH1020-120-ATH	□	10.2	120	180	12	E52	ZPB1050-TH	□	10.5	33	90	12	E86	10FWHNSB1070-TH	□	10.7	144	205	11	E40	04WNSB1100-TH	●	11	66	112	11	E36
10WHNSB1020-TH	□	10.2	138	193	11	E25	ZPBL1050-TH	□	10.5	33	150	10	E88	NSBH1070-150-ATH	□	10.7	150	210	12	E53	EHSE11.0-TH	●	11	68	114	11	E80
10FWHNSB1020-TH	□	10.2	138	193	11	E40	02WNSB1050-TH	●	10.5	42	90	11	E35	15WHNSB1070-TH	□	10.7	199	260	11	E26	EWSR11.0	□	11	68	114	11	E91
NSBH1020-150-ATH	□	10.2	150	210	12	E52	EWSS10.5	□	10.5	43	89	11	E90	15FWHNSB1070-TH	□	10.7	199	260	11	E41	05WHNSB1100-TH	□	11	87	150	11	E21
15WHNSB1020-TH	□	10.2	190	245	11	E26	NSBH1050-50-ATH	●	10.5	50	110	12	E52	NSBH1070-200-ATH	□	10.7	200	260	12	E53	05FWHNSB1100-TH	□	11	87	150	11	E39
15FWHNSB1020-TH	□	10.2	190	245	11	E41	03WHNSB1050-TH	□	10.5	54	117	11	E20	NSBH1070-250-ATH	□	10.7	250	310	12	E53	NSBH1100-90-ATH	□	11	90	155	12	E53
NSBH1020-200-ATH	□	10.2	200	260	12	E52	03FWHNSB1050-TH	●	10.5	54	117	11	E38	20WHNSB1070-TH	□	10.7	254	315	11	E27	NSBH1100-120-ATH	□	11	120	185	12	E53
20WHNSB1020-TH	□	10.2	243	298	11	E27	04WNSB1050-TH	●	10.5	63	112	11	E36	20FWHNSB1070-TH	□	10.7	254	315	11	E42	08WHNSB1100-TH	●	11	121	184	11	E23
20FWHNSB1020-TH	□	10.2	243	298	11	E42	EWSR10.5	□	10.5	66	112	10.5	E91	NSBH1070-300-ATH	□	10.7	300										

Quick dimension reference table by tool diameter

直径別寸法早見表

φ11.1~φ20

単位 unit : mm

商品コード Item code	在庫 Stock	直径 Tool dia.	溝長 Flute length	全長 Overall length	シャンク径 Shank dia.	ページ Page	商品コード Item code	在庫 Stock	直径 Tool dia.	溝長 Flute length	全長 Overall length	シャンク径 Shank dia.	ページ Page	商品コード Item code	在庫 Stock	直径 Tool dia.	溝長 Flute length	全長 Overall length	シャンク径 Shank dia.	ページ Page	商品コード Item code	在庫 Stock	直径 Tool dia.	溝長 Flute length	全長 Overall length	シャンク径 Shank dia.	ページ Page
04WNSB1110-TH	●	11.1	71	121	12	E36	ZPBL1140-TH	●	11.4	34	150	10	E88	10FWHNSB1160-TH	□	11.6	157	218	12	E40	04WNSB1190-TH	●	11.9	73	121	12	E36
NSBH1110-90-ATH	□	11.1	90	155	12	E53	02WNSB1140-TH	●	11.4	46	94	12	E35	NSBH1160-200-ATH	□	11.6	200	265	12	E53	NSBH1190-90-ATH	□	11.9	90	155	12	E53
05WHNSB1110-TH	□	11.1	93	156	12	E21	EWSS11.4	□	11.4	47	95	12	E90	15WHNSB1160-TH	□	11.6	217	278	12	E26	05WHNSB1190-TH	●	11.9	93	156	12	E21
05FWHNSB1110-TH	□	11.1	93	156	12	E39	NSBH1140-55-ATH	□	11.4	55	120	12	E53	15FWHNSB1160-TH	□	11.6	217	278	12	E41	05FWHNSB1190-TH	□	11.9	93	156	12	E39
NSBH1110-120-ATH	□	11.1	120	185	12	E53	03WHNSB1140-TH	●	11.4	59	123	12	E20	NSBH1160-250-ATH	□	11.6	250	315	12	E53	NSBH1190-120-ATH	□	11.9	120	185	12	E53
08WHNSB1110-TH	□	11.1	127	195	12	E23	03FWHNSB1140-TH	□	11.4	59	123	12	E38	20WHNSB1160-TH	□	11.6	277	338	12	E27	08WHNSB1190-TH	●	11.9	132	195	12	E23
NSBH1110-150-ATH	□	11.1	150	215	12	E53	EWRSR11.4	□	11.4	71	118	11.4	E91	NSBH1160-300-ATH	□	11.6	300	365	12	E53	NSBH1190-150-ATH	□	11.9	150	215	12	E53
10WHNSB1110-TH	□	11.1	151	212	12	E25	04WNSB1140-TH	●	11.4	71	121	12	E36	NSBH1160-300-ATH	□	11.6	300	365	12	E53	10WHNSB1190-TH	●	11.9	157	218	12	E25
10FWHNSB1110-TH	□	11.1	151	212	12	E40	NSBH1140-90-ATH	□	11.4	90	155	12	E53	25WHNSB1160-TH	□	11.6	338	399	12	E28	10FWHNSB1190-TH	□	11.9	157	218	12	E40
NSBH1110-200-ATH	□	11.1	200	265	12	E53	05WHNSB1140-TH	●	11.4	93	156	12	E21	30WHNSB1160-TH	□	11.6	397	458	12	E29	NSBH1190-200-ATH	□	11.9	200	265	12	E53
15WHNSB1110-TH	□	11.1	208	269	12	E26	05FWHNSB1140-TH	□	11.4	93	156	12	E39	ZPB1170-TH	□	11.7	38	90	12	E86	15WHNSB1190-TH	●	11.9	217	278	12	E26
15FWHNSB1110-TH	□	11.1	208	269	12	E41	NSBH1140-120-ATH	□	11.4	120	185	12	E53	ZPBL1170-TH	□	11.7	38	150	10	E88	15FWHNSB1190-TH	□	11.9	217	278	12	E41
NSBH1110-250-ATH	□	11.1	250	315	12	E53	08WHNSB1140-TH	●	11.4	127	195	12	E23	02WNSB1170-TH	□	11.7	46	94	12	E35	NSBH1190-250-ATH	□	11.9	250	315	12	E53
20WHNSB1110-TH	□	11.1	266	327	12	E27	NSBH1140-150-ATH	□	11.4	150	215	12	E53	EWSS11.7	□	11.7	47	95	12	E90	20WHNSB1190-TH	●	11.9	277	338	12	E27
20FWHNSB1110-TH	□	11.1	266	327	12	E42	10WHNSB1140-TH	□	11.4	151	212	12	E25	03WHNSB1170-TH	□	11.7	59	123	12	E20	20FWHNSB1190-TH	□	11.9	277	338	12	E42
NSBH1110-300-ATH	□	11.1	300	365	12	E53	10FWHNSB1140-TH	□	11.4	151	212	12	E40	03FWHNSB1170-TH	□	11.7	59	123	12	E38	NSBH1190-300-ATH	□	11.9	300	365	12	E53
25WHNSB1110-TH	□	11.1	324	385	12	E28	NSBH1140-200-ATH	□	11.4	200	265	12	E53	NSBH1170-60-ATH	□	11.7	60	125	12	E53	25WHNSB1190-TH	●	11.9	338	399	12	E28
30WHNSB1110-TH	□	11.1	381	442	12	E29	15WHNSB1140-TH	●	11.4	208	269	12	E26	EWRSR11.7	□	11.7	73	121	11.7	E91	30WHNSB1190-TH	●	11.9	397	458	12	E29
ZPB1120-TH	□	11.2	34	90	12	E86	15FWHNSB1140-TH	□	11.4	208	269	12	E41	04WNSB1170-TH	●	11.7	73	121	12	E36	ZPB1200-TH	●	12	38	90	12	E86
ZPBL120-TH	□	11.2	34	150	10	E88	05WHNSB1140-TH	□	11.4	250	315	12	E53	NSBH1170-90-ATH	□	11.7	90	155	12	E53	ZPBL1200-TH	□	12	38	150	12	E88
02WNSB1120-TH	□	11.2	46	94	12	E35	NSBH1140-250-ATH	□	11.4	250	315	12	E53	05WHNSB1170-TH	□	11.7	93	156	12	E21	02WNSB1200-TH	●	12	46	94	12	E35
EWSS11.2	□	11.2	47	95	12	E90	20WHNSB1140-TH	●	11.4	266	327	12	E27	05FWHNSB1170-TH	□	11.7	93	156	12	E39	EWSS12.0	□	12	51	102	12	E90
NSBH1120-55-ATH	□	11.2	55	120	12	E53	20FWHNSB1140-TH	□	11.4	266	327	12	E42	NSBH1170-120-ATH	□	11.7	120	185	12	E53	03WHNSB1200-TH	●	12	59	123	12	E20
03WHNSB1120-TH	□	11.2	59	123	12	E20	NSBH1140-300-ATH	□	11.4	300	365	12	E53	08WHNSB1170-TH	□	11.7	132	195	12	E23	03FWHNSB1200-TH	□	12	59	123	12	E38
03FWHNSB1120-TH	□	11.2	59	123	12	E38	25WHNSB1140-TH	□	11.4	324	385	12	E28	NSBH1170-150-ATH	□	11.7	150	215	12	E53	NSBH1200-60-ATH	●	12	60	125	12	E53
EWRSR11.2	□	11.2	71	118	11.2	E91	30WHNSB1140-TH	●	11.4	381	442	12	E29	10WHNSB1170-TH	□	11.7	157	218	12	E25	04WNSB1200-TH	●	12	73	121	12	E36
04WNSB1120-TH	●	11.2	71	121	12	E36	ZPB1150-TH	□	11.5	34	90	12	E86	10FWHNSB1170-TH	□	11.7	157	218	12	E40	EHSE12.0-TH	●	12	73	121	12	E80
NSBH1120-90-ATH	□	11.2	90	155	12	E53	ZPBL1150-TH	□	11.5	34	150	10	E88	NSBH1170-200-ATH	□	11.7	200	265	12	E53	EWRSR12.0	□	12	73	121	12	E91
05WHNSB1120-TH	□	11.2	93	156	12	E21	02WNSB1150-TH	□	11.5	46	94	12	E35	15WHNSB1170-TH	□	11.7	217	278	12	E26	NSBH1200-90-ATH	□	12	90	155	12	E53
05FWHNSB1120-TH	□	11.2	93	156	12	E39	EWSS11.5	□	11.5	47	95	12	E90	15FWHNSB1170-TH	□	11.7	217	278	12	E41	05WHNSB1200-TH	●	12	93	156	12	E21
NSBH1120-120-ATH	□	11.2	120	185	12	E53	03WHNSB1150-TH	●	11.5	59	123	12	E20	NSBH1170-250-ATH	□	11.7	250	315	12	E53	05FWHNSB1200-TH	●	12	93	156	12	E39
08WHNSB1120-TH	□	11.2	127	195	12	E23	03FWHNSB1150-TH	●	11.5	59	123	12	E38	20WHNSB1170-TH	□	11.7	277	338	12	E27	NSBH1200-120-ATH	□	12	120	185	12	E53
NSBH1120-150-ATH	□	11.2	150	215	12	E53	NSBH1150-60-ATH	□	11.5	60	125	12	E53	NSBH1170-300-ATH	□	11.7	300	365	12	E42	08WHNSB1200-TH	●	12	132	195	12	E23
10WHNSB1120-TH	□	11.2	151	212	12	E25	EWRSR11.5	□	11.5	71	118	11.5	E91	25WHNSB1170-TH	□	11.7	338	399	12	E28	NSBH1200-150-ATH	●	12	150	215	12	E53
10FWHNSB1120-TH	□	11.2	151	212	12	E40	EHSE11.5-TH	●	11.5	71	118	12	E80	30WHNSB1170-TH	□	11.7	397	458	12	E29	10WHNSB1200-TH	□	12	157	218	12	E25
NSBH1120-200-ATH	□	11.2	200	265	12	E53	04WNSB1150-TH	●	11.5	71	121	12	E36	ZPB1180-TH	□	11.8	38	90	12	E86	10FWHNSB1200-TH	□	12	157	218	12	E40
15WHNSB1120-TH	□	11.2	208	269	12	E26	NSBH1150-90-ATH	□	11.5	90	155	12	E53	ZPBL1180-TH	□	11.8	38	150	10	E88	NSBH1200-200-ATH	□	12	200	265	12	E53
15FWHNSB1120-TH	□	11.2	208	269	12	E41	05WHNSB1150-TH	●	11.5	93	156	12	E21	ZPBL1180-TH	□	11.8	38	150	10	E86	15WHNSB1200-TH	●	12	217	278	12	E26
NSBH1120-250-ATH	□	11.2	250	315	12	E53	05FWHNSB1150-TH	□	11.5	93	156	12	E39	02WNSB1180-TH	●	11.8	46	94	12	E35	15FWHNSB1200-TH	●	12	217	278	12	E41
20WHNSB1120-TH	□	11.2	266	327	12	E27	NSBH1150-120-ATH	□	11.5	120	185	12	E53	EWSS11.8	□	11.8	47	95	12	E90	NSBH1200-250-ATH	□	12	250	315	12	E53
20FWHNSB1120-TH	□	11.2	266	327	12	E42	08WHSR1150-ATH	□	11.5	133	192	12	E56	03WHNSB1180-TH	□	11.8	59	123	12	E20	03WHNSB1200-TH	□	12	277	338	12	E27
NSBH1120-300-ATH	□	11.2	300	365	12	E53	NSBH1150-150-ATH	□	11.5	150	215	12	E53	03FWHNSB1180-TH	□	11.8	59	123	12	E38	20FWHNSB1200-TH	●	12	277	338	12	E42
25WHNSB1120-TH	□	11.2	324	385	12	E28	NSBH1150-200-ATH	□	11.5	200	265	12	E53	NSBH1180-60-ATH	□	11.8	60	125	12	E53	20WHSR1200-ATH	●	12	283	342	12	E56

単位 unit : mm

商品コード Item code	在庫 Stock	直径 Tool da.	溝長 Flute length	全長 Overall length	シャンク径 Shank dia.	ページ Page	商品コード Item code	在庫 Stock	直径 Tool da.	溝長 Flute length	全長 Overall length	シャンク径 Shank dia.	ページ Page	商品コード Item code	在庫 Stock	直径 Tool da.	溝長 Flute length	全長 Overall length	シャンク径 Shank dia.	ページ Page	商品コード Item code	在庫 Stock	直径 Tool da.	溝長 Flute length	全長 Overall length	シャンク径 Shank dia.	ページ Page	
05WHNSB1220-TH	□	12.2	104	169	13	E21	20WHNSB1260-TH	□	12.6	300	366	13	E27	EWSS13.4	□	13.4	54	107	14	E90	EWSS19.0	□	19	64	127	19	E90	
05FWHNSB1220-TH	●	12.2	104	169	13	E39	25WHNSB1260-TH	□	12.6	367	433	13	E28	EWSR13.4	□	13.4	84	144	13.4	E91	EWSR19.0	□	19	114	179	19	E91	
08WHNSB1220-TH	□	12.2	138	208	13	E23	02WNSB1270-TH	□	12.7	49	100	13	E35	ZPB1350-TH	□	13.5	40	100	12	E86	EWSS19.5	□	19.5	66	131	20	E90	
10WHNSB1220-TH	□	12.2	164	225	13	E25	EWSS12.7	□	12.7	51	102	13	E90	ZPBL1350-TH	□	13.5	40	150	12	E88	EWSR19.5	□	19.5	114	179	19.5	E91	
10FWHNSB1220-TH	□	12.2	164	225	13	E40	03WHNSB1270-TH	□	12.7	64	129	13	E20	EWSS13.5	□	13.5	54	107	14	E90	EWSS20.0	□	20	66	131	20	E90	
15WHNSB1220-TH	□	12.2	226	287	13	E26	03FWHNSB1270-TH	□	12.7	64	129	13	E38	EWSR13.5	□	13.5	84	144	13.5	E91	EWSR20.0	□	20	114	179	20	E91	
15FWHNSB1220-TH	□	12.2	226	287	13	E41	04WNSB1270-TH	●	12.7	76	128	13	E36	EHSE13.5-TH	□	13.5	84	144	14	E80								
20WHNSB1220-TH	□	12.2	289	350	13	E27	EWSR12.7	□	12.7	78	137	12.7	E91	EWSS13.6	□	13.6	54	107	14	E90								
25WHNSB1220-TH	□	12.2	353	414	13	E28	05WHNSB1270-TH	□	12.7	104	169	13	E21	EWSR13.6	□	13.6	86	147	13.6	E91								
02WNSB1230-TH	□	12.3	49	100	13	E35	05FWHNSB1270-TH	□	12.7	104	169	13	E39	EWSS13.7	□	13.7	54	107	14	E90								
EWSS12.3	□	12.3	51	102	13	E90	08WHNSB1270-TH	□	12.7	143	208	13	E23	EWSR13.7	□	13.7	86	147	13.7	E91								
03WHNSB1230-TH	□	12.3	64	129	13	E20	10WHNSB1270-TH	□	12.7	170	236	13	E25	EWSS13.8	□	13.8	54	107	14	E90								
03FWHNSB1230-TH	□	12.3	64	129	13	E38	10FWHNSB1270-TH	□	12.7	170	236	13	E40	EWSR13.8	□	13.8	86	147	13.8	E91								
04WNSB1230-TH	●	12.3	76	128	13	E36	15WHNSB1270-TH	□	12.7	235	301	13	E26	EWSS13.9	□	13.9	54	107	14	E90								
EWSR12.3	□	12.3	76	135	12.3	E91	15FWHNSB1270-TH	□	12.7	235	301	13	E41	EWSR13.9	□	13.9	86	147	13.9	E91								
05WHNSB1230-TH	□	12.3	104	169	13	E21	20WHNSB1270-TH	□	12.7	300	366	13	E27	ZPB1400-TH	□	14	40	100	12	E86								
05FWHNSB1230-TH	□	12.3	104	169	13	E39	25WHNSB1270-TH	□	12.7	367	433	13	E28	ZPBL1400-TH	□	14	40	150	12	E88								
08WHNSB1230-TH	□	12.3	138	208	13	E23	02WNSB1280-TH	□	12.8	49	100	13	E35	EWSS14.0	□	14	54	107	14	E90								
10WHNSB1230-TH	□	12.3	164	225	13	E25	EWSS12.8	□	12.8	51	102	13	E90	EHSE14.0-TH	□	14	86	147	14	E80								
10FWHNSB1230-TH	□	12.3	164	225	13	E40	03WHNSB1280-TH	□	12.8	64	129	13	E20	EWSR14.0	□	14	86	147	14	E91								
15WHNSB1230-TH	□	12.3	226	287	13	E26	03FWHNSB1280-TH	□	12.8	64	129	13	E38	EWSS14.1	□	14.1	56	111	15	E90								
15FWHNSB1230-TH	□	12.3	226	287	13	E41	04WNSB1280-TH	●	12.8	76	128	13	E36	EWSR14.1	□	14.1	89	151	14.1	E91								
20WHNSB1230-TH	□	12.3	289	350	13	E27	EWSR12.8	□	12.8	78	137	12.8	E91	EHSE14.1-TH	●	14.1	89	151	15	E80								
25WHNSB1230-TH	□	12.3	353	414	13	E28	05WHNSB1280-TH	□	12.8	104	169	13	E21	EWSS14.2	□	14.2	56	111	15	E90								
02WNSB1240-TH	□	12.4	49	100	13	E35	05FWHNSB1280-TH	□	12.8	104	169	13	E39	EWSR14.2	□	14.2	89	151	14.2	E91								
EWSS12.4	□	12.4	51	102	13	E90	08WHNSB1280-TH	□	12.8	143	208	13	E23	EHSE14.2-TH	□	14.2	89	151	15	E80								
03WHNSB1240-TH	□	12.4	64	129	13	E20	10WHNSB1280-TH	□	12.8	170	236	13	E25	EWSS14.3	□	14.3	56	111	15	E90								
03FWHNSB1240-TH	□	12.4	64	129	13	E38	10FWHNSB1280-TH	□	12.8	170	236	13	E40	EWSR14.3	□	14.3	89	151	14.3	E91								
04WNSB1240-TH	●	12.4	76	128	13	E36	15WHNSB1280-TH	□	12.8	235	301	13	E26	EWSS14.4	□	14.4	56	111	15	E90								
EWSR12.4	□	12.4	76	135	12.4	E91	15FWHNSB1280-TH	□	12.8	235	301	13	E41	EWSR14.4	□	14.4	89	151	14.4	E91								
05WHNSB1240-TH	□	12.4	104	169	13	E21	20WHNSB1280-TH	□	12.8	300	366	13	E27	ZPB1450-TH	□	14.5	40	105	12	E86								
05FWHNSB1240-TH	□	12.4	104	169	13	E39	25WHNSB1280-TH	□	12.8	367	433	13	E28	ZPBL1450-TH	□	14.5	40	150	12	E88								
08WHNSB1240-TH	□	12.4	138	208	13	E23	02WNSB1290-TH	□	12.9	49	100	13	E35	EWSS14.5	□	14.5	56	111	15	E90								
10WHNSB1240-TH	□	12.4	164	225	13	E25	EWSS12.9	□	12.9	51	102	13	E90	EWSR14.5	□	14.5	89	151	14.5	E91								
10FWHNSB1240-TH	□	12.4	164	225	13	E40	03WHNSB1290-TH	□	12.9	64	129	13	E20	EHSE14.5-TH	□	14.5	89	151	15	E80								
15WHNSB1240-TH	□	12.4	226	287	13	E26	03FWHNSB1290-TH	□	12.9	64	129	13	E38	EWSS14.6	□	14.6	56	111	15	E90								
15FWHNSB1240-TH	□	12.4	226	287	13	E41	04WNSB1290-TH	●	12.9	76	128	13	E36	EWSR14.6	□	14.6	91	153	14.6	E91								
20WHNSB1240-TH	□	12.4	289	350	13	E27	EWSR12.9	□	12.9	78	137	12.9	E91	EHSE14.6-TH	●	14.6	91	153	15	E80								
25WHNSB1240-TH	□	12.4	353	414	13	E28	05WHNSB1290-TH	□	12.9	104	169	13	E21	EWSS14.7	□	14.7	56	111	15	E90								
ZPB1250-TH	□	12.5	40	100	12	E86	05FWHNSB1290-TH	□	12.9	104	169	13	E39	EWSR14.7	□	14.7	91	153	14.7	E91								
ZPBL1250-TH	□	12.5	40	150	12	E88	08WHNSB1290-TH	□	12.9	143	208	13	E23	EWSS14.8	□	14.8	56	111	15	E90								
02WNSB1250-TH	●	12.5	49	100	13	E35	10WHNSB1290-TH	□	12.9	170	236	13	E25	EWSR14.8	□	14.8	91	153	14.8	E91								
EWSS12.5	□	12.5	51	102	13	E90	10FWHNSB1290-TH	□	12.9	170	236	13	E40	EWSS14.9	□	14.9	56	111	15	E90								
03WHNSB1250-TH	●	12.5	64	129	13	E20	15WHNSB1290-TH	□	12.9	235	301	13	E26	EWSR14.9	□	14.9	91	153	14.9	E91								
03FWHNSB1250-TH	●	12.5	64	129	13	E38	15FWHNSB1290-TH	□	12.9	235	301	13	E41	ZPB1500-TH	□	15	40	105	12	E86								
04WNSB1250-TH	●	12.5	76	128	13	E36	20WHNSB1290-TH	□	12.9	300	366	13	E27	ZPBL1500-TH	□	15	40	150	12	E88								
EWSR12.5	□	12.5	76	135	12.5	E91	25WHNSB1290-TH	□	12.9	367	433	13	E28	EWSS15.0	□	15	56	111	15	E90								
EHSE12.5-TH	●	12.5	76	135	13	E80	ZPB1300-TH	□	13	40	100	12	E86	EHSE15.0-TH	□	15	91	153	15	E80								
05WHNSB1250-TH	●	12.5	104	169	13	E21	ZPBL1300-TH	□	13	40	150	12	E88	EWSR15.0	□	15	91	153	15	E91								
05FWHNSB1250-TH	●	12.5	104	169	13	E39	02WNSB1300-TH	●	13	49	100	13	E35	ZPB1550-TH	□	15.5	42	110	12	E86								
08WHNSB1250-TH	●	12.5	138	208	13	E23	EWSS13.0	□	13	51	102	13	E90	ZPBL1550-TH	□	15.5	42	150	12	E88								
10WHNSB1250-TH	●	12.5	164	225	13	E25	03WHNSB1300-TH	●	13	64	129	13	E20	EWSS15.5	□	15.5	58	115	16	E90								
10FWHNSB1250-TH	□	12.5	164	225	13	E40	03FWHNSB1300-TH	●	13	64	129	13	E38	EWSR15.5	□	15.5	94	157	15.5	E91								
15WHNSB1250-TH	●	12.5	226	287	13	E26	04WNSB1300-TH	●	13	76	128	13	E36	EHSE15.5-TH	□	15.5	94	157	16	E80								
15FWHNSB1250-TH	□	12.5	226	287	13	E41	EHSE13.0-TH	●	13	78	137	13	E80	EHSE15.6-TH	●	15.6	96	160	16	E80								
20WHNSB1250-TH	●	12.5	289	350	13	E27	EWSR13.0	□	13																			

Carbide Oil Hole Non Step Borer 3D

超硬OHノンステップボーラー3D

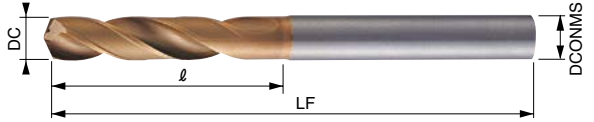

03WHNSB-TH



商品コード Item code	在庫 Stock	寸法 Size (mm)				希望小売価格 (円) Suggested retail price(¥)
		直径 Tool dia. DC	溝長 Flute length ℓ	全長 Overall length LF	シャンク径 Shank dia. DCONMS	
03WHNSB0200-TH	●	2.0	16	69	3.0	12,800
03WHNSB0203-TH	●	2.03	16	69	3.0	12,800
03WHNSB0210-TH	●	2.10	17	69	3.0	12,800
03WHNSB0213-TH	●	2.13	17	69	3.0	12,800
03WHNSB0220-TH	●	2.2	17	69	3.0	12,800
03WHNSB0223-TH	●	2.23	17	69	3.0	12,800
03WHNSB0230-TH	●	2.3	19	69	3.0	12,800
03WHNSB0233-TH	●	2.33	19	69	3.0	12,800
03WHNSB0240-TH	●	2.4	19	69	3.0	12,800
03WHNSB0243-TH	●	2.43	19	69	3.0	12,800
03WHNSB0250-TH	●	2.5	19	69	3.0	12,800
03WHNSB0253-TH	●	2.53	19	69	3.0	12,800
03WHNSB0260-TH	●	2.6	19	69	3.0	12,800
03WHNSB0263-TH	●	2.63	19	69	3.0	12,800
03WHNSB0270-TH	●	2.7	19	69	3.0	12,800
03WHNSB0273-TH	●	2.73	19	69	3.0	12,800
03WHNSB0280-TH	●	2.8	19	69	3.0	12,800
03WHNSB0283-TH	●	2.83	19	69	3.0	12,800
03WHNSB0290-TH	●	2.9	19	69	3.0	12,800
03WHNSB0293-TH	●	2.93	19	69	3.0	12,800
03WHNSB0300-TH	●	3.0	19	69	3.0	12,800
03WHNSB0305-TH	●	3.05	23	73	4.0	13,140
03WHNSB0310-TH	●	3.1	23	73	4.0	13,140
03WHNSB0320-TH	●	3.2	23	73	4.0	13,140
03WHNSB0330-TH	●	3.3	23	73	4.0	13,140
03WHNSB0340-TH	●	3.4	23	73	4.0	13,140
03WHNSB0350-TH	●	3.5	23	73	4.0	13,140
03WHNSB0360-TH	●	3.6	23	73	4.0	13,360
03WHNSB0370-TH	●	3.7	23	73	4.0	13,360
03WHNSB0380-TH	●	3.8	23	73	4.0	13,360
03WHNSB0390-TH	●	3.9	23	73	4.0	13,360
03WHNSB0400-TH	●	4.0	23	73	4.0	13,360
03WHNSB0405-TH	●	4.05	29	82	5.0	13,700
03WHNSB0410-TH	●	4.1	29	82	5.0	13,700
03WHNSB0420-TH	●	4.2	29	82	5.0	13,700
03WHNSB0430-TH	●	4.3	29	82	5.0	13,700
03WHNSB0440-TH	●	4.4	29	82	5.0	13,700
03WHNSB0450-TH	●	4.5	29	82	5.0	13,700
03WHNSB0460-TH	●	4.6	29	82	5.0	13,810
03WHNSB0470-TH	●	4.7	29	82	5.0	13,810
03WHNSB0480-TH	●	4.8	29	82	5.0	13,810
03WHNSB0490-TH	●	4.9	29	82	5.0	13,810
03WHNSB0500-TH	●	5.0	29	82	5.0	13,810

商品コード Item code	在庫 Stock	寸法 Size (mm)				希望小売価格 (円) Suggested retail price(¥)
		直径 Tool dia. DC	溝長 Flute length ℓ	全長 Overall length LF	シャンク径 Shank dia. DCONMS	
03WHNSB0505-TH	●	5.05	29	82	6.0	14,590
03WHNSB0510-TH	●	5.1	29	82	6.0	14,590
03WHNSB0520-TH	●	5.2	29	82	6.0	14,590
03WHNSB0530-TH	●	5.3	29	82	6.0	14,590
03WHNSB0540-TH	●	5.4	29	82	6.0	14,590
03WHNSB0550-TH	●	5.5	29	82	6.0	14,590
03WHNSB0555-TH	●	5.55	29	82	6.0	14,930
03WHNSB0560-TH	●	5.6	29	82	6.0	14,930
03WHNSB0570-TH	●	5.7	29	82	6.0	14,930
03WHNSB0580-TH	●	5.8	29	82	6.0	14,930
03WHNSB0590-TH	●	5.9	29	82	6.0	14,930
03WHNSB0600-TH	●	6.0	29	82	6.0	14,930
03WHNSB0605-TH	●	6.05	34	89	7.0	15,940
03WHNSB0610-TH	●	6.1	34	89	7.0	15,940
03WHNSB0620-TH	●	6.2	34	89	7.0	15,940
03WHNSB0630-TH	●	6.3	34	89	7.0	15,940
03WHNSB0640-TH	●	6.4	34	89	7.0	15,940
03WHNSB0650-TH	●	6.5	34	89	7.0	15,940
03WHNSB0655-TH	●	6.55	34	89	7.0	16,270
03WHNSB0660-TH	●	6.6	34	89	7.0	16,270
03WHNSB0670-TH	●	6.7	34	89	7.0	16,270
03WHNSB0680-TH	●	6.8	34	89	7.0	16,270
03WHNSB0690-TH	●	6.9	34	89	7.0	16,270
03WHNSB0700-TH	●	7.0	34	89	7.0	16,270
03WHNSB0705-TH	●	7.05	39	95	8.0	17,740
03WHNSB0710-TH	●	7.1	39	95	8.0	17,740
03WHNSB0720-TH	●	7.2	39	95	8.0	17,740
03WHNSB0730-TH	●	7.3	39	95	8.0	17,740
03WHNSB0740-TH	●	7.4	39	95	8.0	17,740
03WHNSB0750-TH	●	7.5	39	95	8.0	17,740
03WHNSB0760-TH	●	7.6	39	95	8.0	18,080
03WHNSB0770-TH	●	7.7	39	95	8.0	18,080
03WHNSB0780-TH	●	7.8	39	95	8.0	18,080
03WHNSB0790-TH	●	7.9	39	95	8.0	18,080
03WHNSB0800-TH	●	8.0	39	95	8.0	18,080
03WHNSB0805-TH	●	8.05	44	101	9.0	19,310
03WHNSB0810-TH	●	8.1	44	101	9.0	19,310
03WHNSB0820-TH	●	8.2	44	101	9.0	19,310
03WHNSB0830-TH	●	8.3	44	101	9.0	19,310
03WHNSB0840-TH	●	8.4	44	101	9.0	19,310
03WHNSB0850-TH	●	8.5	44	101	9.0	19,310
03WHNSB0860-TH	●	8.6	44	101	9.0	19,640
03WHNSB0870-TH	●	8.7	44	101	9.0	19,640

商品コード Item code	在庫 Stock	寸法 Size (mm)				希望小売価格 (円) Suggested retail price(¥)
		直径 Tool dia. DC	溝長 Flute length ℓ	全長 Overall length LF	シャンク径 Shank dia. DCONMS	
03WHNSB0880-TH	●	8.8	44	101	9.0	19,640
03WHNSB0890-TH	●	8.9	44	101	9.0	19,640
03WHNSB0900-TH	●	9.0	44	101	9.0	19,640
03WHNSB0910-TH	□	9.1	49	107	10.0	-
03WHNSB0920-TH	□	9.2	49	107	10.0	-
03WHNSB0930-TH	●	9.3	49	107	10.0	20,990
03WHNSB0940-TH	●	9.4	49	107	10.0	20,990
03WHNSB0950-TH	●	9.5	49	107	10.0	20,990
03WHNSB0960-TH	□	9.6	49	107	10.0	-
03WHNSB0970-TH	□	9.7	49	107	10.0	-
03WHNSB0980-TH	●	9.8	49	107	10.0	21,440
03WHNSB0990-TH	●	9.9	49	107	10.0	21,440
03WHNSB1000-TH	●	10.0	49	107	10.0	21,440
03WHNSB1010-TH	□	10.1	54	117	11.0	-
03WHNSB1020-TH	●	10.2	54	117	11.0	22,790
03WHNSB1030-TH	●	10.3	54	117	11.0	22,790
03WHNSB1040-TH	●	10.4	54	117	11.0	22,790
03WHNSB1050-TH	●	10.5	54	117	11.0	22,790
03WHNSB1060-TH	□	10.6	54	117	11.0	-
03WHNSB1070-TH	□	10.7	54	117	11.0	-
03WHNSB1080-TH	●	10.8	54	117	11.0	23,350
03WHNSB1090-TH	●	10.9	54	117	11.0	23,350
03WHNSB1100-TH	●	11.0	54	117	11.0	23,350
03WHNSB1110-TH	□	11.1	59	123	12.0	-
03WHNSB1120-TH	□	11.2	59	123	12.0	-
03WHNSB1130-TH	●	11.3	59	123	12.0	24,580
03WHNSB1140-TH	●	11.4	59	123	12.0	24,580
03WHNSB1150-TH	●	11.5	59	123	12.0	24,580
03WHNSB1160-TH	□	11.6	59	123	12.0	-
03WHNSB1170-TH	□	11.7	59	123	12.0	-
03WHNSB1180-TH	●	11.8	59	123	12.0	25,250
03WHNSB1190-TH	●	11.9	59	123	12.0	25,250
03WHNSB1200-TH	●	12.0	59	123	12.0	25,250
03WHNSB1210-TH	□	12.1	64	129	13.0	-
03WHNSB1220-TH	□	12.2	64	129	13.0	-
03WHNSB1230-TH	□	12.3	64	129	13.0	-
03WHNSB1240-TH	□	12.4	64	129	13.0	-
03WHNSB1250-TH	●	12.5	64	129	13.0	27,720
03WHNSB1260-TH	□	12.6	64	129	13.0	-
03WHNSB1270-TH	□	12.7	64	129	13.0	-
03WHNSB1280-TH	□	12.8	64	129	13.0	-
03WHNSB1290-TH	□	12.9	64	129	13.0	-
03WHNSB1300-TH	●	13.0	64	129	13.0	29,630

○ 対応被削材

Applicable work material

軟鋼 Mild steel SS	炭素鋼 Carbon steel S〇〇C	合金鋼 Alloy steel SCM, SCr	調質鋼 Heat-treated steel SKD, SKS	工具鋼 Tool steel ~40HRC	焼入れ鋼 Hardened steel ~45HRC 45HRC~	ステンレス鋼 Stainless steel SUS	耐熱鋼 Ti合金 Heat-resistant steel, Ti alloy Inconel	鋳鉄 Cast iron FC	ダクタイル鋳鉄 Ductile cast iron FCD	アルミ合金 Aluminum alloy Al	銅合金 Copper alloy Cu
○	○	○	○	○	○	○	○	○	○	○	○

●印：標準在庫品です。□印：特定代理店在庫です。弊社営業へお問い合わせください。
●：Stocked items. □：Stocked by specified distributor. Contact with our sales department.

○ 再研磨対応外径範囲

Re-grinding compatibility range

商品コード Item code	エンド End (mm)
03WHNSB-TH	2 ~ 13

Carbide Oil Hole Non Step Borer 5D

超硬OHノンステップボーラー 5D



0 ~ -0.01 (mm)



平面二段 S-X 形ジニング
Plane, S-X thinning

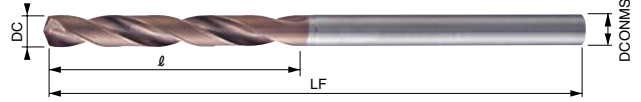

切削条件表 E22
Cutting Conditions

05WHNSB-TH

商品コード Item code	在庫 Stock	寸法 Size (mm)				希望小売価格 (円) Suggested retail price(¥)
		直径 Tool dia. DC	溝長 Flutel length ℓ	全長 Overall length LF	シャンク径 Shank dia. DCONMS	
05WHNSB0200-TH	●	2.0	20	66	3.0	14,590
05WHNSB0210-TH	●	2.1	24	74	3.0	14,590
05WHNSB0220-TH	●	2.2	24	74	3.0	14,590
05WHNSB0230-TH	●	2.3	24	74	3.0	14,590
05WHNSB0240-TH	●	2.4	24	74	3.0	14,590
05WHNSB0250-TH	●	2.5	24	74	3.0	14,590
05WHNSB0260-TH	●	2.6	29	79	3.0	14,590
05WHNSB0270-TH	●	2.7	29	79	3.0	14,590
05WHNSB0280-TH	●	2.8	29	79	3.0	14,590
05WHNSB0290-TH	●	2.9	29	79	3.0	14,590
05WHNSB0300-TH	●	3.0	29	79	3.0	14,590
05WHNSB0310-TH	●	3.1	37	87	4.0	15,040
05WHNSB0320-TH	●	3.2	37	87	4.0	15,040
05WHNSB0330-TH	●	3.3	37	87	4.0	15,040
05WHNSB0340-TH	●	3.4	37	87	4.0	15,040
05WHNSB0350-TH	●	3.5	37	87	4.0	15,040
05WHNSB0360-TH	●	3.6	37	87	4.0	15,150
05WHNSB0370-TH	●	3.7	37	87	4.0	15,150
05WHNSB0380-TH	●	3.8	37	87	4.0	15,150
05WHNSB0390-TH	●	3.9	37	87	4.0	15,150
05WHNSB0400-TH	●	4.0	37	87	4.0	15,150
05WHNSB0410-TH	●	4.1	47	100	5.0	15,600
05WHNSB0420-TH	●	4.2	47	100	5.0	15,600
05WHNSB0430-TH	●	4.3	47	100	5.0	15,600
05WHNSB0440-TH	●	4.4	47	100	5.0	15,600
05WHNSB0450-TH	●	4.5	47	100	5.0	15,600
05WHNSB0460-TH	●	4.6	47	100	5.0	15,940
05WHNSB0470-TH	●	4.7	47	100	5.0	15,940
05WHNSB0480-TH	●	4.8	47	100	5.0	15,940
05WHNSB0490-TH	●	4.9	47	100	5.0	15,940
05WHNSB0500-TH	●	5.0	47	100	5.0	15,940
05WHNSB0510-TH	●	5.1	47	100	6.0	16,830
05WHNSB0520-TH	●	5.2	47	100	6.0	16,830
05WHNSB0530-TH	●	5.3	47	100	6.0	16,830
05WHNSB0540-TH	●	5.4	47	100	6.0	16,830
05WHNSB0550-TH	●	5.5	47	100	6.0	16,830
05WHNSB0560-TH	●	5.6	47	100	6.0	17,070
05WHNSB0570-TH	●	5.7	47	100	6.0	17,070
05WHNSB0580-TH	●	5.8	47	100	6.0	17,070
05WHNSB0590-TH	●	5.9	47	100	6.0	17,070
05WHNSB0600-TH	●	6.0	47	100	6.0	17,070
05WHNSB0610-TH	●	6.1	55	110	7.0	18,190
05WHNSB0620-TH	●	6.2	55	110	7.0	18,190

商品コード Item code	在庫 Stock	寸法 Size (mm)				希望小売価格 (円) Suggested retail price(¥)
		直径 Tool dia. DC	溝長 Flutel length ℓ	全長 Overall length LF	シャンク径 Shank dia. DCONMS	
05WHNSB0630-TH	●	6.3	55	110	7.0	18,190
05WHNSB0640-TH	●	6.4	55	110	7.0	18,190
05WHNSB0650-TH	●	6.5	55	110	7.0	18,190
05WHNSB0660-TH	●	6.6	55	110	7.0	18,640
05WHNSB0670-TH	●	6.7	55	110	7.0	18,640
05WHNSB0680-TH	●	6.8	55	110	7.0	18,640
05WHNSB0690-TH	●	6.9	55	110	7.0	18,640
05WHNSB0700-TH	●	7.0	55	110	7.0	18,640
05WHNSB0710-TH	●	7.1	63	119	8.0	20,090
05WHNSB0720-TH	●	7.2	63	119	8.0	20,090
05WHNSB0730-TH	●	7.3	63	119	8.0	20,090
05WHNSB0740-TH	●	7.4	63	119	8.0	20,090
05WHNSB0750-TH	●	7.5	63	119	8.0	20,090
05WHNSB0760-TH	●	7.6	63	119	8.0	20,650
05WHNSB0770-TH	●	7.7	63	119	8.0	20,650
05WHNSB0780-TH	●	7.8	63	119	8.0	20,650
05WHNSB0790-TH	●	7.9	63	119	8.0	20,650
05WHNSB0800-TH	●	8.0	63	119	8.0	20,650
05WHNSB0810-TH	●	8.1	71	128	9.0	22,000
05WHNSB0820-TH	●	8.2	71	128	9.0	22,000
05WHNSB0830-TH	●	8.3	71	128	9.0	22,000
05WHNSB0840-TH	●	8.4	71	128	9.0	22,000
05WHNSB0850-TH	●	8.5	71	128	9.0	22,000
05WHNSB0860-TH	●	8.6	71	128	9.0	22,570
05WHNSB0870-TH	●	8.7	71	128	9.0	22,570
05WHNSB0880-TH	●	8.8	71	128	9.0	22,570
05WHNSB0890-TH	●	8.9	71	128	9.0	22,570
05WHNSB0900-TH	●	9.0	71	128	9.0	22,570
05WHNSB0910-TH	□	9.1	79	137	10.0	-
05WHNSB0920-TH	□	9.2	79	137	10.0	-
05WHNSB0930-TH	●	9.3	79	137	10.0	24,020
05WHNSB0940-TH	●	9.4	79	137	10.0	24,020
05WHNSB0950-TH	●	9.5	79	137	10.0	24,020
05WHNSB0960-TH	□	9.6	79	137	10.0	-
05WHNSB0970-TH	□	9.7	79	137	10.0	-
05WHNSB0980-TH	●	9.8	79	137	10.0	24,360
05WHNSB0990-TH	●	9.9	79	137	10.0	24,360
05WHNSB1000-TH	●	10.0	79	137	10.0	24,360
05WHNSB1010-TH	□	10.1	87	150	11.0	-
05WHNSB1020-TH	●	10.2	87	150	11.0	26,040
05WHNSB1030-TH	●	10.3	87	150	11.0	26,040
05WHNSB1040-TH	●	10.4	87	150	11.0	26,040
05WHNSB1050-TH	●	10.5	87	150	11.0	26,040

商品コード Item code	在庫 Stock	寸法 Size (mm)				希望小売価格 (円) Suggested retail price(¥)
		直径 Tool dia. DC	溝長 Flutel length ℓ	全長 Overall length LF	シャンク径 Shank dia. DCONMS	
05WHNSB1060-TH	□	10.6	87	150	11.0	-
05WHNSB1070-TH	□	10.7	87	150	11.0	-
05WHNSB1080-TH	●	10.8	87	150	11.0	26,490
05WHNSB1090-TH	●	10.9	87	150	11.0	26,490
05WHNSB1100-TH	●	11.0	87	150	11.0	26,490
05WHNSB1110-TH	□	11.1	93	156	12.0	-
05WHNSB1120-TH	□	11.2	93	156	12.0	-
05WHNSB1130-TH	●	11.3	93	156	12.0	28,180
05WHNSB1140-TH	●	11.4	93	156	12.0	28,180
05WHNSB1150-TH	●	11.5	93	156	12.0	28,180
05WHNSB1160-TH	□	11.6	93	156	12.0	-
05WHNSB1170-TH	□	11.7	93	156	12.0	-
05WHNSB1180-TH	●	11.8	93	156	12.0	28,850
05WHNSB1190-TH	●	11.9	93	156	12.0	28,850
05WHNSB1200-TH	●	12.0	93	156	12.0	28,850
05WHNSB1210-TH	□	12.1	104	169	13.0	-
05WHNSB1220-TH	□	12.2	104	169	13.0	-
05WHNSB1230-TH	□	12.3	104	169	13.0	-
05WHNSB1240-TH	□	12.4	104	169	13.0	-
05WHNSB1250-TH	●	12.5	104	169	13.0	31,650
05WHNSB1260-TH	□	12.6	104	169	13.0	-
05WHNSB1270-TH	□	12.7	104	169	13.0	-
05WHNSB1280-TH	□	12.8	104	169	13.0	-
05WHNSB1290-TH	□	12.9	104	169	13.0	-
05WHNSB1300-TH	●	13.0	104	169	13.0	33,790

Boring Tools

Non Step Borer

○ 対応被削材

Applicable work material

軟鋼 Mild steel SS	炭素鋼 Carbon steel S〇〇C	合金鋼 Alloy steel SCM, SCr	調質鋼 Heat-treated steel SKD SKS	工具鋼 Tool steel ~40HRC	焼入れ鋼 Hardened steel ~45HRC 45HRC~	ステンレス鋼 Stainless steel SUS	耐熱鋼 Ti合金 Heat-resistant steel, Ti alloy Inconel	鋳鉄 Cast iron FC	ダクタイル鋳鉄 Ductile cast iron FCD	アルミ合金 Aluminum alloy Al	銅合金 Copper alloy Cu
○	○	○	○	○	○	○	○	○	○	○	○

○ 再研磨対応外径範囲

Re-grinding compatibility range

商品コード Item code	エンド End (mm)
05WHNSB-TH	2 ~ 13

超硬OHノンステップボーラー 3D・5D

標準切削条件表 Recommended cutting conditions

O3WHNSB-TH | O5WHNSB-TH

被削材 Work material	構造用鋼 Structural steels (~180HB) SS				炭素鋼 Carbon steels (~200HB) S100C				合金鋼 Alloy steels (~30HRC) SCM			
	内部クーラント Internal coolant 50~120~180		MQL(ミスト) MQL (mist) 50~120~180		内部クーラント Internal coolant 50~120~180		MQL(ミスト) MQL (mist) 50~120~180		内部クーラント Internal coolant 50~120~180		MQL(ミスト) MQL (mist) 50~120~180	
直径 Tool dia.	回転数 <i>n</i> (min ⁻¹)	送り量 <i>f</i> (mm/rev)	回転数 <i>n</i> (min ⁻¹)	送り量 <i>f</i> (mm/rev)	回転数 <i>n</i> (min ⁻¹)	送り量 <i>f</i> (mm/rev)	回転数 <i>n</i> (min ⁻¹)	送り量 <i>f</i> (mm/rev)	回転数 <i>n</i> (min ⁻¹)	送り量 <i>f</i> (mm/rev)	回転数 <i>n</i> (min ⁻¹)	送り量 <i>f</i> (mm/rev)
Φ2.0	16,000	0.05~0.1	16,000	0.05~0.1	16,000	0.05~0.1	16,000	0.05~0.1	16,000	0.05~0.1	16,000	0.05~0.1
Φ4.0	9,500	0.1~0.16	9,500	0.1~0.16	9,500	0.1~0.16	9,500	0.1~0.16	9,500	0.1~0.16	9,500	0.1~0.16
Φ6.0	6,300	0.15~0.24	6,300	0.15~0.24	6,300	0.15~0.24	6,300	0.15~0.24	6,300	0.15~0.24	6,300	0.15~0.24
Φ8.0	4,800	0.18~0.3	4,800	0.18~0.3	4,800	0.18~0.3	4,800	0.18~0.3	4,800	0.18~0.3	4,800	0.18~0.3
Φ10.0	3,800	0.2~0.35	3,800	0.2~0.35	3,800	0.2~0.35	3,800	0.2~0.35	3,800	0.2~0.35	3,800	0.2~0.35
Φ12.0	3,200	0.22~0.4	3,200	0.22~0.4	3,200	0.22~0.4	3,200	0.22~0.4	3,200	0.22~0.4	3,200	0.22~0.4

被削材 Work material	ステンレス鋼 Stainless steels SUS300系 SUS400系		Ti合金 Titanium alloys Ti-6Al-4V		プリハードン鋼 Pre-hardened steels (~40HRC)				プリハードン鋼 Pre-hardened steels (~50HRC) SKD			
	内部クーラント Internal coolant 50~100~150		内部クーラント Internal coolant 50~80~100		内部クーラント Internal coolant 40~60~100		MQL(ミスト) MQL (mist) 40~60~100		内部クーラント Internal coolant 30~40~50		MQL(ミスト) MQL (mist) 20~30~40	
直径 Tool dia.	回転数 <i>n</i> (min ⁻¹)	送り量 <i>f</i> (mm/rev)	回転数 <i>n</i> (min ⁻¹)	送り量 <i>f</i> (mm/rev)	回転数 <i>n</i> (min ⁻¹)	送り量 <i>f</i> (mm/rev)	回転数 <i>n</i> (min ⁻¹)	送り量 <i>f</i> (mm/rev)	回転数 <i>n</i> (min ⁻¹)	送り量 <i>f</i> (mm/rev)	回転数 <i>n</i> (min ⁻¹)	送り量 <i>f</i> (mm/rev)
Φ2.0	11,000	0.03~0.06	9,500	0.02~0.04	9,500	0.04~0.06	8,000	0.04~0.06	6,500	0.03~0.05	4,500	0.03~0.05
Φ4.0	8,000	0.06~0.1	6,400	0.06~0.08	4,800	0.08~0.13	4,800	0.08~0.13	3,200	0.05~0.1	2,400	0.05~0.1
Φ6.0	5,300	0.12~0.19	4,200	0.09~0.12	3,200	0.12~0.19	3,200	0.12~0.19	2,100	0.08~0.14	1,600	0.08~0.14
Φ8.0	4,000	0.14~0.24	3,200	0.12~0.16	2,400	0.14~0.24	2,400	0.14~0.24	1,600	0.12~0.18	1,200	0.12~0.18
Φ10.0	3,200	0.16~0.28	2,550	0.13~0.2	1,900	0.16~0.28	1,900	0.16~0.28	1,300	0.15~0.2	1,000	0.15~0.2
Φ12.0	2,650	0.17~0.31	2,100	0.14~0.24	1,600	0.18~0.32	1,600	0.18~0.32	1,050	0.17~0.24	800	0.17~0.24

被削材 Work material	ダクタイル鋳鉄 Ductile irons FCD500				鋳物 Casting FC250				耐熱鋼 INCONEL718 Heatproof steels	
	内部クーラント Internal coolant 50~100~150		MQL(ミスト) MQL (mist) 50~100~150		内部クーラント Internal coolant 50~120~180		MQL(ミスト) MQL (mist) 50~120~180		内部クーラント Internal coolant 20~30~40	
直径 Tool dia.	回転数 <i>n</i> (min ⁻¹)	送り量 <i>f</i> (mm/rev)	回転数 <i>n</i> (min ⁻¹)	送り量 <i>f</i> (mm/rev)	回転数 <i>n</i> (min ⁻¹)	送り量 <i>f</i> (mm/rev)	回転数 <i>n</i> (min ⁻¹)	送り量 <i>f</i> (mm/rev)	回転数 <i>n</i> (min ⁻¹)	送り量 <i>f</i> (mm/rev)
Φ2.0	13,000	0.05~0.1	13,000	0.05~0.1	16,000	0.05~0.1	16,000	0.05~0.1	4,000	0.02~0.03
Φ4.0	8,000	0.1~0.16	8,000	0.1~0.16	9,500	0.1~0.16	9,500	0.1~0.16	2,400	0.06~0.08
Φ6.0	5,300	0.15~0.24	5,300	0.15~0.24	6,300	0.15~0.24	6,300	0.15~0.24	1,600	0.09~0.12
Φ8.0	4,000	0.18~0.3	4,000	0.18~0.3	4,800	0.18~0.3	4,800	0.18~0.3	1,200	0.12~0.16
Φ10.0	3,200	0.2~0.35	3,200	0.2~0.35	3,800	0.2~0.35	3,800	0.2~0.35	950	0.13~0.2
Φ12.0	2,650	0.22~0.4	2,650	0.22~0.4	3,200	0.22~0.4	3,200	0.22~0.4	800	0.14~0.24

【切削条件の選定について】 Setting of Cutting Conditions

- ※被削材、加工形状に合わせて、適切なクーラントを使用してください。
- ※この標準切削条件表は切削条件の目安を示すものです。実際の加工では加工形状、目的、使用機械等により条件を調整してください。
- ※この内部クーラント切削条件基準は希釈倍率20倍以下の水溶性切削油剤を使用する場合のもので、20倍を超える場合は切削速度範囲の下限を目安に使用してください。又クーラントの供給圧はφ5.0以下は2.0MPa以上を、φ5.0を超える物は1.5MPa以上を推奨いたします。
- ※MQL(ミスト)加工の場合は工具からの吐出量や吐出の状態により切削速度を下げないと加工できない場合があります。
- ※工具装着の際は傷や汚れの無いコレットを用い、工具の振れは0.02 mm以下に抑えてください。
- ※この切削条件は工具径の5倍までの穴深さに適用ください。
- ※油性の切削油剤を使用する場合は切削速度範囲の下限より低速の条件でご使用ください。また、切りくずおよび工具の発熱による発煙・引火にご注意ください。
- ※被削材は変形、たわみ、振動が起らないようにしっかりと保持してください。
- ※条件表よりも低い回転数でご使用することもできます。
- ※Use the appropriate coolant for the work material and machining shape.
- ※These Recommended Cutting Conditions indicate only the rule of a thumb for the cutting conditions. In actual machining, the condition should be adjusted according to the machining shape, purpose and the machine type.
- ※The above cutting conditions are based on the use of a water-soluble coolant diluted to a maximum of 20 times. When coolant dilution exceeds 20 times, decrease the cutting speed to the lowest in the specified range. When the tool diameter is φ5.0 or less, the coolant pressure should be 2.0 MPa or higher, and when the diameter is over φ5.0, the pressure should be 1.5 MPa or higher.
- ※When performing MQL (mist) machining, depending on the amount or status of spray from the tool, it may be necessary to reduce the cutting speed in order to perform machining.
- ※When changing the tool, use collet free from flaws and stains and attach the tool firmly so that its runout is 0.02mm or less.
- ※The above conditions apply to a hole-depth of 5 times the diameter or less.
- ※When cutting fluid is used, reduce the cutting speed to a speed lower than the lowest speed in the specified range. Take the greatest care to avoid smoke or ignition due to heating of chips and the tool.
- ※Works should be gripped firmly to prevent deformation, deflection and vibration.
- ※You can use borers at a revolution speed lower than the above values.

穴めけ工具 ノンステップボーラー

超硬OHノンステップボーラー 8D



0~0.01

(mm)



平面二段・S-X形シンニング
Plane, S-X thinning

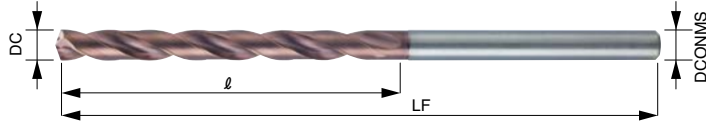

08WHNSB-TH

切削条件表 E24
Cutting Conditions

商品コード Item code	在庫 Stock	寸法 Size (mm)				希望小売価格 (円) Suggested retail price(¥)
		直径 Tool dia. DC	溝長 Flutel length ℓ	全長 Overall length LF	シャンク径 Shank dia. DCONMS	
08WHNSB0200-TH	●	2.0	25	75	3.0	19,200
08WHNSB0210-TH	●	2.1	25	75	3.0	19,200
08WHNSB0220-TH	●	2.2	25	75	3.0	19,200
08WHNSB0230-TH	●	2.3	28	75	3.0	19,200
08WHNSB0240-TH	●	2.4	28	75	3.0	19,200
08WHNSB0250-TH	●	2.5	28	75	3.0	19,200
08WHNSB0260-TH	●	2.6	33	80	3.0	19,200
08WHNSB0270-TH	●	2.7	33	80	3.0	19,200
08WHNSB0280-TH	●	2.8	35	83	3.0	19,200
08WHNSB0290-TH	●	2.9	35	83	3.0	19,200
08WHNSB0300-TH	●	3.0	35	83	3.0	19,200
08WHNSB0310-TH	●	3.1	42	94	4.0	19,640
08WHNSB0320-TH	●	3.2	42	94	4.0	19,640
08WHNSB0330-TH	●	3.3	42	94	4.0	19,640
08WHNSB0340-TH	●	3.4	42	94	4.0	19,640
08WHNSB0350-TH	●	3.5	42	94	4.0	19,640
08WHNSB0360-TH	●	3.6	46	94	4.0	19,870
08WHNSB0370-TH	●	3.7	46	94	4.0	19,870
08WHNSB0380-TH	●	3.8	46	94	4.0	19,870
08WHNSB0390-TH	●	3.9	46	94	4.0	19,870
08WHNSB0400-TH	●	4.0	46	94	4.0	19,870
08WHNSB0410-TH	●	4.1	55	110	5.0	20,540
08WHNSB0420-TH	●	4.2	55	110	5.0	20,540
08WHNSB0430-TH	●	4.3	55	110	5.0	20,540
08WHNSB0440-TH	●	4.4	55	110	5.0	20,540
08WHNSB0450-TH	●	4.5	55	110	5.0	20,540
08WHNSB0460-TH	●	4.6	59	110	5.0	20,760
08WHNSB0470-TH	●	4.7	59	110	5.0	20,760
08WHNSB0480-TH	●	4.8	59	110	5.0	20,760
08WHNSB0490-TH	●	4.9	59	110	5.0	20,760
08WHNSB0500-TH	●	5.0	59	110	5.0	20,760
08WHNSB0510-TH	●	5.1	62	118	6.0	21,770
08WHNSB0520-TH	●	5.2	62	118	6.0	21,770
08WHNSB0530-TH	●	5.3	62	118	6.0	21,770
08WHNSB0540-TH	●	5.4	62	118	6.0	21,770
08WHNSB0550-TH	●	5.5	62	118	6.0	21,770
08WHNSB0560-TH	●	5.6	67	118	6.0	22,220

商品コード Item code	在庫 Stock	寸法 Size (mm)				希望小売価格 (円) Suggested retail price(¥)
		直径 Tool dia. DC	溝長 Flutel length ℓ	全長 Overall length LF	シャンク径 Shank dia. DCONMS	
08WHNSB0570-TH	●	5.7	67	118	6.0	22,220
08WHNSB0580-TH	●	5.8	67	118	6.0	22,220
08WHNSB0590-TH	●	5.9	67	118	6.0	22,220
08WHNSB0600-TH	●	6.0	67	118	6.0	22,220
08WHNSB0610-TH	●	6.1	73	132	7.0	23,460
08WHNSB0620-TH	●	6.2	73	132	7.0	23,460
08WHNSB0630-TH	●	6.3	73	132	7.0	23,460
08WHNSB0640-TH	●	6.4	73	132	7.0	23,460
08WHNSB0650-TH	●	6.5	73	132	7.0	23,460
08WHNSB0660-TH	●	6.6	77	132	7.0	23,800
08WHNSB0670-TH	●	6.7	77	132	7.0	23,800
08WHNSB0680-TH	●	6.8	77	132	7.0	23,800
08WHNSB0690-TH	●	6.9	77	132	7.0	23,800
08WHNSB0700-TH	●	7.0	77	132	7.0	23,800
08WHNSB0710-TH	●	7.1	84	144	8.0	25,590
08WHNSB0720-TH	●	7.2	84	144	8.0	25,590
08WHNSB0730-TH	●	7.3	84	144	8.0	25,590
08WHNSB0740-TH	●	7.4	84	144	8.0	25,590
08WHNSB0750-TH	●	7.5	84	144	8.0	25,590
08WHNSB0760-TH	●	7.6	88	144	8.0	26,040
08WHNSB0770-TH	●	7.7	88	144	8.0	26,040
08WHNSB0780-TH	●	7.8	88	144	8.0	26,040
08WHNSB0790-TH	●	7.9	88	144	8.0	26,040
08WHNSB0800-TH	●	8.0	88	144	8.0	26,040
08WHNSB0810-TH	□	8.1	94	156	9.0	-
08WHNSB0820-TH	□	8.2	94	156	9.0	-
08WHNSB0830-TH	●	8.3	94	156	9.0	28,050
08WHNSB0840-TH	●	8.4	94	156	9.0	28,050
08WHNSB0850-TH	●	8.5	94	156	9.0	28,050
08WHNSB0860-TH	□	8.6	99	156	9.0	-
08WHNSB0870-TH	□	8.7	99	156	9.0	-
08WHNSB0880-TH	●	8.8	99	156	9.0	28,740
08WHNSB0890-TH	●	8.9	99	156	9.0	28,740
08WHNSB0900-TH	●	9.0	99	156	9.0	28,740
08WHNSB0910-TH	□	9.1	105	168	10.0	-
08WHNSB0920-TH	□	9.2	105	168	10.0	-
08WHNSB0930-TH	●	9.3	105	168	10.0	31,310

商品コード Item code	在庫 Stock	寸法 Size (mm)				希望小売価格 (円) Suggested retail price(¥)
		直径 Tool dia. DC	溝長 Flutel length ℓ	全長 Overall length LF	シャンク径 Shank dia. DCONMS	
08WHNSB0940-TH	●	9.4	105	168	10.0	31,310
08WHNSB0950-TH	●	9.5	105	168	10.0	31,310
08WHNSB0960-TH	□	9.6	110	168	10.0	-
08WHNSB0970-TH	□	9.7	110	168	10.0	-
08WHNSB0980-TH	●	9.8	110	168	10.0	31,980
08WHNSB0990-TH	●	9.9	110	168	10.0	31,980
08WHNSB1000-TH	●	10.0	110	168	10.0	31,980
08WHNSB1010-TH	□	10.1	116	184	11.0	-
08WHNSB1020-TH	●	10.2	116	184	11.0	35,470
08WHNSB1030-TH	●	10.3	116	184	11.0	35,470
08WHNSB1040-TH	●	10.4	116	184	11.0	35,470
08WHNSB1050-TH	●	10.5	116	184	11.0	35,470
08WHNSB1060-TH	□	10.6	121	184	11.0	-
08WHNSB1070-TH	●	10.7	121	184	11.0	36,140
08WHNSB1080-TH	●	10.8	121	184	11.0	36,140
08WHNSB1090-TH	●	10.9	121	184	11.0	36,140
08WHNSB1100-TH	●	11.0	121	184	11.0	36,140
08WHNSB1110-TH	□	11.1	127	195	12.0	-
08WHNSB1120-TH	□	11.2	127	195	12.0	-
08WHNSB1130-TH	●	11.3	127	195	12.0	40,070
08WHNSB1140-TH	●	11.4	127	195	12.0	40,070
08WHNSB1150-TH	●	11.5	127	195	12.0	40,070
08WHNSB1160-TH	●	11.6	132	195	12.0	40,630
08WHNSB1170-TH	□	11.7	132	195	12.0	-
08WHNSB1180-TH	●	11.8	132	195	12.0	40,630
08WHNSB1190-TH	●	11.9	132	195	12.0	40,630
08WHNSB1200-TH	●	12.0	132	195	12.0	40,630
08WHNSB1210-TH	□	12.1	138	208	13.0	-
08WHNSB1220-TH	□	12.2	138	208	13.0	-
08WHNSB1230-TH	□	12.3	138	208	13.0	-
08WHNSB1240-TH	□	12.4	138	208	13.0	-
08WHNSB1250-TH	●	12.5	138	208	13.0	47,130
08WHNSB1260-TH	□	12.6	143	208	13.0	-
08WHNSB1270-TH	□	12.7	143	208	13.0	-
08WHNSB1280-TH	□	12.8	143	208	13.0	-
08WHNSB1290-TH	□	12.9	143	208	13.0	-
08WHNSB1300-TH	●	13.0	143	208	13.0	47,920

○ 対応被削材

Applicable work material

軟鋼 Mild steel	炭素鋼 Carbon steel	合金鋼 Alloy steel	調質鋼 Heat-treated steel	工具鋼 Tool steel	焼入れ鋼 Hardened steel	ステンレス鋼 Stainless steel	耐熱鋼 Ti合金 Heat-resistant steel, Ti alloy	鋳鉄 Cast iron	ダクタイル鋳鉄 Ductile cast iron	アルミ合金 Aluminum alloy	銅合金 Copper alloy
SS	SCOC	SCM, SCr	SKD, SKS	~40HRC	~45HRC 45HRC~	SUS	Inconel	FC	FCD	Al	Cu
○	○	○	○	○	○	○	○	○	○	○	○

●印：標準在庫品です。 □印：特定代理店在庫です。弊社営業へお問い合わせください。
● : Stocked items. □ : Stocked by specified distributor. Contact with our sales department.

○ 再研磨対応外径範囲

Re-grinding compatibility range

商品コード Item code	エンド End (mm)
08WHNSB-TH	2 ~ 13

Boring Tools
Non Step Borer

超硬OHノンステップボーラー 8D

標準切削条件表 Recommended cutting conditions

08WHNSB-TH

被削材 Work material	構造用鋼 Structural steels (~180HB) SS				炭素鋼 Carbon steels (~200HB) S○○○				合金鋼 Alloy steels (~30HRC) SCM			
	内部クーラント Internal coolant 70~120~150		MQL (ミスト) MQL (mist) 50~90~120		内部クーラント Internal coolant 70~120~150		MQL (ミスト) MQL (mist) 50~90~120		内部クーラント Internal coolant 70~120~150		MQL (ミスト) MQL (mist) 50~90~120	
直径 Tool dia.	回転数 <i>n</i> (min ⁻¹)	送り量 <i>f</i> (mm/rev)	回転数 <i>n</i> (min ⁻¹)	送り量 <i>f</i> (mm/rev)	回転数 <i>n</i> (min ⁻¹)	送り量 <i>f</i> (mm/rev)	回転数 <i>n</i> (min ⁻¹)	送り量 <i>f</i> (mm/rev)	回転数 <i>n</i> (min ⁻¹)	送り量 <i>f</i> (mm/rev)	回転数 <i>n</i> (min ⁻¹)	送り量 <i>f</i> (mm/rev)
Φ2.0	16,000	0.05~0.1	13,000	0.05~0.1	16,000	0.05~0.1	13,000	0.05~0.1	16,000	0.05~0.1	13,000	0.05~0.1
Φ4.0	9,500	0.1~0.16	7,200	0.1~0.16	9,500	0.1~0.16	7,200	0.1~0.16	9,500	0.1~0.16	7,200	0.1~0.16
Φ6.0	6,300	0.15~0.24	4,800	0.15~0.24	6,300	0.15~0.24	4,800	0.15~0.24	6,300	0.15~0.24	4,800	0.15~0.24
Φ8.0	4,800	0.18~0.3	3,600	0.18~0.3	4,800	0.18~0.3	3,600	0.18~0.3	4,800	0.18~0.3	3,600	0.18~0.3
Φ10.0	3,800	0.2~0.35	2,900	0.2~0.35	3,800	0.2~0.35	2,900	0.2~0.35	3,800	0.2~0.35	2,900	0.2~0.35
Φ12.0	3,200	0.22~0.4	2,400	0.22~0.4	3,200	0.22~0.4	2,400	0.22~0.4	3,200	0.22~0.4	2,400	0.22~0.4

被削材 Work material	ステンレス鋼 Stainless steels SUS300系 SUS400系		Ti合金 Titanium alloys Ti-6Al-4V		プリハードン鋼 Pre-hardened steels (~40HRC)				プリハードン鋼 Pre-hardened steels (~50HRC) SKD			
	内部クーラント Internal coolant 50~90~120		内部クーラント Internal coolant 40~60~80		内部クーラント Internal coolant 40~60~80		MQL (ミスト) MQL (mist) 30~50~70		内部クーラント Internal coolant 30~40~50		MQL (ミスト) MQL (mist) 10~20~30	
直径 Tool dia.	回転数 <i>n</i> (min ⁻¹)	送り量 <i>f</i> (mm/rev)	回転数 <i>n</i> (min ⁻¹)	送り量 <i>f</i> (mm/rev)	回転数 <i>n</i> (min ⁻¹)	送り量 <i>f</i> (mm/rev)	回転数 <i>n</i> (min ⁻¹)	送り量 <i>f</i> (mm/rev)	回転数 <i>n</i> (min ⁻¹)	送り量 <i>f</i> (mm/rev)	回転数 <i>n</i> (min ⁻¹)	送り量 <i>f</i> (mm/rev)
Φ2.0	11,000	0.03~0.06	9,500	0.02~0.04	9,500	0.04~0.06	8,000	0.04~0.06	6,500	0.03~0.05	4,500	0.03~0.05
Φ4.0	7,200	0.08~0.13	4,800	0.06~0.08	4,800	0.08~0.13	4,000	0.08~0.13	3,200	0.05~0.1	1,600	0.05~0.1
Φ6.0	4,800	0.12~0.19	3,200	0.09~0.12	3,200	0.12~0.19	2,650	0.12~0.19	2,100	0.08~0.14	1,050	0.08~0.14
Φ8.0	3,600	0.14~0.24	2,400	0.12~0.16	2,400	0.14~0.24	2,000	0.14~0.24	1,600	0.12~0.18	800	0.12~0.18
Φ10.0	2,900	0.16~0.28	1,900	0.13~0.2	1,900	0.16~0.28	1,600	0.16~0.28	1,300	0.15~0.2	650	0.15~0.2
Φ12.0	2,400	0.17~0.31	1,600	0.14~0.24	1,600	0.18~0.32	1,350	0.18~0.32	1,050	0.17~0.22	550	0.17~0.22

被削材 Work material	ダクタイル鋳鉄 Ductile irons FCD500				鋳物 Casting FC250				耐熱鋼 INCONEL718 Heatproof steels	
	内部クーラント Internal coolant 70~100~120		MQL (ミスト) MQL (mist) 50~90~120		内部クーラント Internal coolant 70~120~150		MQL (ミスト) MQL (mist) 50~90~120		内部クーラント Internal coolant 20~30~40	
直径 Tool dia.	回転数 <i>n</i> (min ⁻¹)	送り量 <i>f</i> (mm/rev)	回転数 <i>n</i> (min ⁻¹)	送り量 <i>f</i> (mm/rev)	回転数 <i>n</i> (min ⁻¹)	送り量 <i>f</i> (mm/rev)	回転数 <i>n</i> (min ⁻¹)	送り量 <i>f</i> (mm/rev)	回転数 <i>n</i> (min ⁻¹)	送り量 <i>f</i> (mm/rev)
Φ2.0	16,000	0.05~0.1	13,000	0.05~0.1	16,000	0.05~0.1	13,000	0.05~0.1	4,000	0.02~0.03
Φ4.0	8,000	0.1~0.16	7,200	0.1~0.16	9,500	0.1~0.16	7,200	0.1~0.16	2,400	0.04~0.08
Φ6.0	5,300	0.15~0.24	4,800	0.15~0.24	6,300	0.15~0.24	4,800	0.15~0.24	1,600	0.06~0.12
Φ8.0	4,000	0.18~0.3	3,600	0.18~0.3	4,800	0.18~0.3	3,600	0.18~0.3	1,200	0.08~0.16
Φ10.0	3,200	0.2~0.35	2,900	0.2~0.35	3,800	0.2~0.35	2,900	0.2~0.35	950	0.1~0.2
Φ12.0	2,600	0.22~0.4	2,400	0.22~0.4	3,200	0.22~0.4	2,400	0.22~0.4	800	0.12~0.2

【切削条件の選定について】 Setting of Cutting Conditions

*被削材、加工形状に合わせて、適切なクーラントを使用してください。
 *この標準切削条件表は切削条件の目安を示すものです。実際の加工では加工形状、目的、使用機械等により条件を調整してください。
 *この内部クーラント切削条件基準は希釈倍率20倍以下の水溶性切削油剤を使用する場合のものです。20倍を超える場合は切削速度範囲の下限を目安に使用してください。また、クーラントの供給圧はφ5.0以下は2.0MPa以上を、φ5.0を超えるものは1.5MPa以上を推奨いたします。
 *MQL (ミスト) 加工の場合は工具からの吐出量や吐出の状態により切削速度を下げない加工できない場合があります。
 *工具装着の際は傷や汚れの無いコレットを用い、工具の振れは0.02mm以下に抑えてください。
 *この切削条件は工具径の8倍までの穴深さに適用ください。
 *油性の切削油剤を使用する場合は切削速度範囲の下限より低速の条件でご使用ください。
 *また、切りくずおよび工具の発熱による発煙・引火にご注意ください。
 *被削材は変形、たわみ、振動が起こらないようにしっかりと保持してください。
 *条件表よりも低い回転数で使用することもできます。

※E30頁の加工方法を必ず参照ください。 Be sure to refer to the boring procedure (P.E30) when selecting a tool.
 ※Use the appropriate coolant for the work material and machining shape.
 ※These Recommended Cutting Conditions indicate only the rule of a thumb for the cutting conditions. In actual machining, the condition should be adjusted according to the machining shape, purpose and the machine type.
 ※The above cutting conditions are based on the use of a water-soluble coolant diluted to a maximum of 20 times. When coolant dilution exceeds 20 times, decrease the cutting speed to the lowest in the specified range. When the tool diameter is φ5.0 or less, the coolant pressure should be 2.0 MPa or higher, and when the diameter is over φ5.0, the pressure should be 1.5 MPa or higher.
 ※When performing MQL (mist) machining, depending on the amount or status of spray from the tool, it may be necessary to reduce the cutting speed in order to perform machining.
 ※When changing the tool, use collet free from flaws and stains and attach the tool firmly so that its runout is 0.02mm or less.
 ※The above conditions apply to a hole-depth of 8 times the diameter or less.
 ※When cutting fluid is used, reduce the cutting speed to a speed lower than the lowest speed in the specified range. Take the greatest care to avoid smoke or ignition due to heating of chips and the tool.
 ※Works should be gripped firmly to prevent deformation, deflection and vibration.
 ※You can use borers at a revolution speed lower than the above values.

穴あけ工具 ノンステップボーラー

Carbide Oil Hole Non Step Borer 10D

超硬OHノンステップボーラー 10D



※1印：溝全体コーティングです。
Completely coated

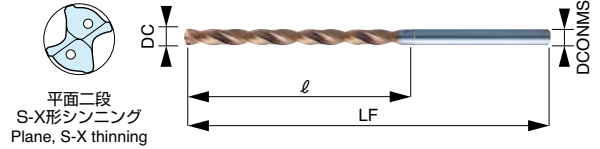

直径公差 下表を参照
Refer to under table



(mm)

10WHNSB-TH

切削条件表 E30
Cutting Conditions

商品コード Item code	在庫 Stock	寸法 Size (mm)				希望小売価格 (円) Suggested retail price(¥)
		直径 Tool dia. DC	溝長 Flutel length ℓ	全長 Overall length LF	シャンク径 Shank dia. DCONMS	
10WHNSB0200-TH	●	2.0	30	80	3.0	23,570
10WHNSB0210-TH	●	2.1	30	80	3.0	23,570
10WHNSB0220-TH	●	2.2	30	80	3.0	23,570
10WHNSB0230-TH	●	2.3	33	80	3.0	23,570
10WHNSB0240-TH	●	2.4	33	80	3.0	23,570
10WHNSB0250-TH	●	2.5	33	80	3.0	23,570
10WHNSB0260-TH	●	2.6	35	85	3.0	23,570
10WHNSB0270-TH	●	2.7	35	85	3.0	23,570
10WHNSB0280-TH	●	2.8	39	85	3.0	23,570
10WHNSB0290-TH	●	2.9	39	87	3.0	23,570
10WHNSB0300-TH	●	3.0	39	87	3.0	23,570
10WHNSB0310-TH	●	3.1	46	94	4.0	23,910
10WHNSB0320-TH	●	3.2	46	94	4.0	23,910
10WHNSB0330-TH	●	3.3	46	94	4.0	23,910
10WHNSB0340-TH	●	3.4	46	94	4.0	23,910
10WHNSB0350-TH	●	3.5	46	94	4.0	23,910
10WHNSB0360-TH	●	3.6	52	101	4.0	24,250
10WHNSB0370-TH	●	3.7	52	101	4.0	24,250
10WHNSB0380-TH	●	3.8	52	101	4.0	24,250
10WHNSB0390-TH	●	3.9	52	101	4.0	24,250
10WHNSB0400-TH	●	4.0	52	101	4.0	24,250
10WHNSB0410-TH	●	4.1	59	110	5.0	24,810
10WHNSB0420-TH	●	4.2	59	110	5.0	24,810
10WHNSB0430-TH	●	4.3	59	110	5.0	24,810
10WHNSB0440-TH	●	4.4	59	110	5.0	24,810
10WHNSB0450-TH	●	4.5	59	110	5.0	24,810
10WHNSB0460-TH	●	4.6	66	117	5.0	25,370
10WHNSB0470-TH	●	4.7	66	117	5.0	25,370
10WHNSB0480-TH	●	4.8	66	117	5.0	25,370
10WHNSB0490-TH	●	4.9	66	117	5.0	25,370
10WHNSB0500-TH	●	5.0	66	117	5.0	25,370
10WHNSB0510-TH	●	5.1	72	123	6.0	27,050
10WHNSB0520-TH	●	5.2	72	123	6.0	27,050
10WHNSB0530-TH	●	5.3	72	123	6.0	27,050
10WHNSB0540-TH	●	5.4	72	123	6.0	27,050
10WHNSB0550-TH	●	5.5	72	123	6.0	27,050
10WHNSB0560-TH	●	5.6	79	130	6.0	28,620
10WHNSB0570-TH	●	5.7	79	130	6.0	28,620
10WHNSB0580-TH	●	5.8	79	130	6.0	28,620
10WHNSB0590-TH	●	5.9	79	130	6.0	28,620
10WHNSB0600-TH	●	6.0	79	130	6.0	28,620
10WHNSB0610-TH	●	6.1	85	138	7.0	30,750
10WHNSB0620-TH	●	6.2	85	138	7.0	30,750

商品コード Item code	在庫 Stock	寸法 Size (mm)				希望小売価格 (円) Suggested retail price(¥)
		直径 Tool dia. DC	溝長 Flutel length ℓ	全長 Overall length LF	シャンク径 Shank dia. DCONMS	
10WHNSB0630-TH	●	6.3	85	138	7.0	30,750
10WHNSB0640-TH	●	6.4	85	138	7.0	30,750
10WHNSB0650-TH	●	6.5	85	138	7.0	30,750
10WHNSB0660-TH	●	6.6	92	145	7.0	32,770
10WHNSB0670-TH	●	6.7	92	145	7.0	32,770
10WHNSB0680-TH	●	6.8	92	145	7.0	32,770
10WHNSB0690-TH	●	6.9	92	145	7.0	32,770
10WHNSB0700-TH	●	7.0	92	145	7.0	32,770
10WHNSB0710-TH	●	7.1	98	153	8.0	34,570
10WHNSB0720-TH	●	7.2	98	153	8.0	34,570
10WHNSB0730-TH	●	7.3	98	153	8.0	34,570
10WHNSB0740-TH	●	7.4	98	153	8.0	34,570
10WHNSB0750-TH	●	7.5	98	153	8.0	34,570
10WHNSB0760-TH	●	7.6	105	160	8.0	36,250
10WHNSB0770-TH	●	7.7	105	160	8.0	36,250
10WHNSB0780-TH	●	7.8	105	160	8.0	36,250
10WHNSB0790-TH	●	7.9	105	160	8.0	36,250
10WHNSB0800-TH	●	8.0	105	160	8.0	36,250
10WHNSB0810-TH	□	8.1	111	166	9.0	-
10WHNSB0820-TH	□	8.2	111	166	9.0	-
10WHNSB0830-TH	●	8.3	111	166	9.0	38,270
10WHNSB0840-TH	●	8.4	111	166	9.0	38,270
10WHNSB0850-TH	●	8.5	111	166	9.0	38,270
10WHNSB0860-TH	□	8.6	118	173	9.0	-
10WHNSB0870-TH	□	8.7	118	173	9.0	-
10WHNSB0880-TH	●	8.8	118	173	9.0	40,180
10WHNSB0890-TH	●	8.9	118	173	9.0	40,180
10WHNSB0900-TH	●	9.0	118	173	9.0	40,180
10WHNSB0910-TH	□	9.1	124	179	10.0	-
10WHNSB0920-TH	□	9.2	124	179	10.0	-
10WHNSB0930-TH	●	9.3	124	179	10.0	41,640
10WHNSB0940-TH	●	9.4	124	179	10.0	41,640
10WHNSB0950-TH	●	9.5	124	179	10.0	41,640
10WHNSB0960-TH	□	9.6	131	186	10.0	-
10WHNSB0970-TH	□	9.7	131	186	10.0	-
10WHNSB0980-TH	●	9.8	131	186	10.0	43,650
10WHNSB0990-TH	●	9.9	131	186	10.0	43,650
10WHNSB1000-TH	●	10.0	131	186	10.0	43,650
10WHNSB1010-TH	□	10.1	138	193	11.0	-
10WHNSB1020-TH	□	10.2	138	193	11.0	-
10WHNSB1030-TH	●	10.3	138	193	11.0	48,480
10WHNSB1040-TH	●	10.4	138	193	11.0	48,480
10WHNSB1050-TH	●	10.5	138	193	11.0	48,480

商品コード Item code	在庫 Stock	寸法 Size (mm)				希望小売価格 (円) Suggested retail price(¥)
		直径 Tool dia. DC	溝長 Flutel length ℓ	全長 Overall length LF	シャンク径 Shank dia. DCONMS	
10WHNSB1060-TH	□	10.6	144	205	11.0	-
10WHNSB1070-TH	□	10.7	144	205	11.0	-
10WHNSB1080-TH	●	10.8	144	205	11.0	50,490
10WHNSB1090-TH	●	10.9	144	205	11.0	50,490
10WHNSB1100-TH	●	11.0	144	205	11.0	50,490
10WHNSB1110-TH	□	11.1	151	212	12.0	-
10WHNSB1120-TH	□	11.2	151	212	12.0	-
10WHNSB1130-TH	●	11.3	151	212	12.0	53,750
10WHNSB1140-TH	●	11.4	151	212	12.0	53,750
10WHNSB1150-TH	●	11.5	151	212	12.0	53,750
10WHNSB1160-TH	□	11.6	157	218	12.0	-
10WHNSB1170-TH	□	11.7	157	218	12.0	-
10WHNSB1180-TH	●	11.8	157	218	12.0	55,660
10WHNSB1190-TH	●	11.9	157	218	12.0	55,660
10WHNSB1200-TH	●	12.0	157	218	12.0	55,660
10WHNSB1210-TH	□	12.1	164	225	13.0	-
10WHNSB1220-TH	□	12.2	164	225	13.0	-
10WHNSB1230-TH	□	12.3	164	225	13.0	-
10WHNSB1240-TH	□	12.4	164	225	13.0	-
10WHNSB1250-TH	●	12.5	164	225	13.0	60,930
10WHNSB1260-TH	□	12.6	170	236	13.0	-
10WHNSB1270-TH	□	12.7	170	236	13.0	-
10WHNSB1280-TH	□	12.8	170	236	13.0	-
10WHNSB1290-TH	□	12.9	170	236	13.0	-
10WHNSB1300-TH	●	13.0	170	236	13.0	63,070

10WHNSB直径公差表

Table of Tolerance on tool dia.

直径2.0~3.0、3.5、4.0、4.5、5.0、5.5、6.0、6.5、7.0、7.5、8.0、8.5、9.0、10.0、11.0、12.0、13.0はh8となります。

上記以外のアイテムは下表の直径公差になります。

h8 for diameters of 2.0 to 3.0, 3.5, 4.0, 4.5, 5.0, 5.5, 6.0, 6.5, 7.0, 7.5, 8.0, 8.5, 9.0, 10.0, 11.0, 12.0, and 13.0. For other items, the diameter tolerance will be as in the table below.

10WHNSB			
	3.0<DC<6.0	6.0<DC<10.0	10.0<DC<13.0
上限 Max	-0.020	-0.024	-0.030
下限 Min	-0.036	-0.045	-0.053

対応被削材

Applicable work material

軟鋼 Mild steel	炭素鋼 Carbon steel	合金鋼 Alloy steel	調質鋼 Heat-treated steel	工具鋼 Tool steel	焼入れ鋼 Hardened steel	ステンレス鋼 Stainless steel	耐熱鋼 Ti合金 Heat-resistant steel, Ti alloy	鋳鉄 Cast iron	ダクタイル鋳鉄 Ductile cast iron	アルミ合金 Aluminum alloy	銅合金 Copper alloy
SS	SCOC	SCM, SCr	SKD, SKS	~40HRC	~45HRC, 45HRC~	SUS	Inconel	FC	FCD	Al	Cu
○	○	○	○	○	○	○	○	○	○	○	○

●印：標準在庫品です。□印：特定代理店在庫です。弊社営業へお問い合わせください。
● : Stocked items. □ : Stocked by specified distributor. Contact with our sales department.

再研磨対応外径範囲

Re-grinding compatibility range

商品コード Item code	エンド End (mm)
10WHNSB-TH	2 ~ 13

Boring Tools
Non Step Borer

Carbide Oil Hole Non Step Borer 15D

超硬OHノンステップボーラー 15D

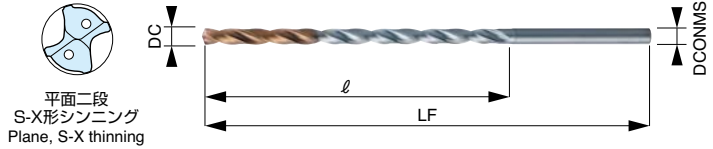
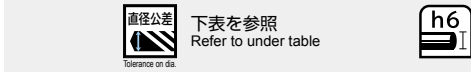

15WHNSB-TH



商品コード Item code	在庫 Stock	寸法 Size (mm)				希望小売価格 (円) Suggested retail price(¥)
		直径 Tool dia. DC	溝長 Flutel length ℓ	全長 Overall length LF	シャンク径 Shank dia. DCONMS	
15WHNSB0200-TH	●	2.0	40	83	3.0	25,700
15WHNSB0210-TH	●	2.1	44	87	3.0	25,700
15WHNSB0220-TH	●	2.2	44	87	3.0	25,700
15WHNSB0230-TH	●	2.3	50	93	3.0	25,700
15WHNSB0240-TH	●	2.4	50	93	3.0	25,700
15WHNSB0250-TH	●	2.5	50	93	3.0	25,700
15WHNSB0260-TH	●	2.6	54	102	3.0	25,700
15WHNSB0270-TH	●	2.7	54	102	3.0	25,700
15WHNSB0280-TH	●	2.8	54	102	3.0	25,700
15WHNSB0290-TH	●	2.9	54	102	3.0	25,700
15WHNSB0300-TH	●	3.0	54	102	3.0	25,700
15WHNSB0310-TH	●	3.1	63	111	4.0	26,040
15WHNSB0320-TH	●	3.2	63	111	4.0	26,040
15WHNSB0330-TH	●	3.3	63	111	4.0	26,040
15WHNSB0340-TH	●	3.4	63	111	4.0	26,040
15WHNSB0350-TH	●	3.5	63	111	4.0	26,040
15WHNSB0360-TH	●	3.6	72	121	4.0	26,370
15WHNSB0370-TH	●	3.7	72	121	4.0	26,370
15WHNSB0380-TH	●	3.8	72	121	4.0	26,370
15WHNSB0390-TH	●	3.9	72	121	4.0	26,370
15WHNSB0400-TH	●	4.0	72	121	4.0	26,370
15WHNSB0410-TH	●	4.1	81	132	5.0	27,050
15WHNSB0420-TH	●	4.2	81	132	5.0	27,050
15WHNSB0430-TH	●	4.3	81	132	5.0	27,050
15WHNSB0440-TH	●	4.4	81	132	5.0	27,050
15WHNSB0450-TH	●	4.5	81	132	5.0	27,050
15WHNSB0460-TH	●	4.6	91	142	5.0	27,610
15WHNSB0470-TH	●	4.7	91	142	5.0	27,610
15WHNSB0480-TH	●	4.8	91	142	5.0	27,610
15WHNSB0490-TH	●	4.9	91	142	5.0	27,610
15WHNSB0500-TH	●	5.0	91	142	5.0	27,610
15WHNSB0510-TH	●	5.1	100	151	6.0	29,410
15WHNSB0520-TH	●	5.2	100	151	6.0	29,410
15WHNSB0530-TH	●	5.3	100	151	6.0	29,410
15WHNSB0540-TH	●	5.4	100	151	6.0	29,410
15WHNSB0550-TH	●	5.5	100	151	6.0	29,410
15WHNSB0560-TH	●	5.6	109	160	6.0	31,200
15WHNSB0570-TH	●	5.7	109	160	6.0	31,200
15WHNSB0580-TH	●	5.8	109	160	6.0	31,200
15WHNSB0590-TH	●	5.9	109	160	6.0	31,200
15WHNSB0600-TH	●	6.0	109	160	6.0	31,200
15WHNSB0610-TH	●	6.1	118	171	7.0	33,550
15WHNSB0620-TH	●	6.2	118	171	7.0	33,550

商品コード Item code	在庫 Stock	寸法 Size (mm)				希望小売価格 (円) Suggested retail price(¥)
		直径 Tool dia. DC	溝長 Flutel length ℓ	全長 Overall length LF	シャンク径 Shank dia. DCONMS	
15WHNSB0630-TH	●	6.3	118	171	7.0	33,550
15WHNSB0640-TH	●	6.4	118	171	7.0	33,550
15WHNSB0650-TH	●	6.5	118	171	7.0	33,550
15WHNSB0660-TH	●	6.6	127	180	7.0	35,800
15WHNSB0670-TH	●	6.7	127	180	7.0	35,800
15WHNSB0680-TH	●	6.8	127	180	7.0	35,800
15WHNSB0690-TH	●	6.9	127	180	7.0	35,800
15WHNSB0700-TH	●	7.0	127	180	7.0	35,800
15WHNSB0710-TH	●	7.1	136	191	8.0	37,710
15WHNSB0720-TH	●	7.2	136	191	8.0	37,710
15WHNSB0730-TH	●	7.3	136	191	8.0	37,710
15WHNSB0740-TH	●	7.4	136	191	8.0	37,710
15WHNSB0750-TH	●	7.5	136	191	8.0	37,710
15WHNSB0760-TH	●	7.6	145	200	8.0	39,510
15WHNSB0770-TH	●	7.7	145	200	8.0	39,510
15WHNSB0780-TH	●	7.8	145	200	8.0	39,510
15WHNSB0790-TH	●	7.9	145	200	8.0	39,510
15WHNSB0800-TH	●	8.0	145	200	8.0	39,510
15WHNSB0810-TH	□	8.1	154	209	9.0	-
15WHNSB0820-TH	□	8.2	154	209	9.0	-
15WHNSB0830-TH	●	8.3	154	209	9.0	41,750
15WHNSB0840-TH	●	8.4	154	209	9.0	41,750
15WHNSB0850-TH	●	8.5	154	209	9.0	41,750
15WHNSB0860-TH	□	8.6	163	218	9.0	-
15WHNSB0870-TH	□	8.7	163	218	9.0	-
15WHNSB0880-TH	●	8.8	163	218	9.0	43,880
15WHNSB0890-TH	●	8.9	163	218	9.0	43,880
15WHNSB0900-TH	●	9.0	163	218	9.0	43,880
15WHNSB0910-TH	□	9.1	172	227	10.0	-
15WHNSB0920-TH	□	9.2	172	227	10.0	-
15WHNSB0930-TH	●	9.3	172	227	10.0	45,450
15WHNSB0940-TH	●	9.4	172	227	10.0	45,450
15WHNSB0950-TH	●	9.5	172	227	10.0	45,450
15WHNSB0960-TH	□	9.6	181	236	10.0	-
15WHNSB0970-TH	□	9.7	181	236	10.0	-
15WHNSB0980-TH	●	9.8	181	236	10.0	47,690
15WHNSB0990-TH	●	9.9	181	236	10.0	47,690
15WHNSB1000-TH	●	10.0	181	236	10.0	47,690
15WHNSB1010-TH	□	10.1	190	245	11.0	-
15WHNSB1020-TH	□	10.2	190	245	11.0	-
15WHNSB1030-TH	●	10.3	190	245	11.0	59,140
15WHNSB1040-TH	●	10.4	190	245	11.0	59,140
15WHNSB1050-TH	●	10.5	190	245	11.0	59,140

商品コード Item code	在庫 Stock	寸法 Size (mm)				希望小売価格 (円) Suggested retail price(¥)
		直径 Tool dia. DC	溝長 Flutel length ℓ	全長 Overall length LF	シャンク径 Shank dia. DCONMS	
15WHNSB1060-TH	□	10.6	199	260	11.0	-
15WHNSB1070-TH	□	10.7	199	260	11.0	-
15WHNSB1080-TH	●	10.8	199	260	11.0	61,380
15WHNSB1090-TH	●	10.9	199	260	11.0	61,380
15WHNSB1100-TH	●	11.0	199	260	11.0	61,380
15WHNSB1110-TH	□	11.1	208	269	12.0	-
15WHNSB1120-TH	□	11.2	208	269	12.0	-
15WHNSB1130-TH	●	11.3	208	269	12.0	66,760
15WHNSB1140-TH	●	11.4	208	269	12.0	66,760
15WHNSB1150-TH	●	11.5	208	269	12.0	66,760
15WHNSB1160-TH	□	11.6	217	278	12.0	-
15WHNSB1170-TH	□	11.7	217	278	12.0	-
15WHNSB1180-TH	●	11.8	217	278	12.0	69,010
15WHNSB1190-TH	●	11.9	217	278	12.0	69,010
15WHNSB1200-TH	●	12.0	217	278	12.0	69,010
15WHNSB1210-TH	□	12.1	226	287	13.0	-
15WHNSB1220-TH	□	12.2	226	287	13.0	-
15WHNSB1230-TH	□	12.3	226	287	13.0	-
15WHNSB1240-TH	□	12.4	226	287	13.0	-
15WHNSB1250-TH	●	12.5	226	287	13.0	79,340
15WHNSB1260-TH	□	12.6	235	301	13.0	-
15WHNSB1270-TH	□	12.7	235	301	13.0	-
15WHNSB1280-TH	□	12.8	235	301	13.0	-
15WHNSB1290-TH	□	12.9	235	301	13.0	-
15WHNSB1300-TH	●	13.0	235	301	13.0	81,580

15WHNSB直径公差表

Table of Tolerance on tool dia.

直径2.0~3.0、3.5、4.0、4.5、5.0、5.5、6.0、6.5、7.0、7.5、8.0、8.5、9.0、10.0、11.0、12.0、13.0はh8となります。
上記以外のアイテムは下表の直径公差になります。

h8 for diameters of 2.0 to 3.0, 3.5, 4.0, 4.5, 5.0, 5.5, 6.0, 6.5, 7.0, 7.5, 8.0, 8.5, 9.0, 10.0, 11.0, 12.0 and 13.0. For other items, the diameter tolerance will be as in the table below.

15WHNSB			
	3.0<DC<6.0	6.0<DC<10.0	10.0<DC≤13.0
上限 Max	-0.020	-0.024	-0.030
下限 Min	-0.036	-0.045	-0.053

対応被削材

Applicable work material

軟鋼 Mild steel SS	炭素鋼 Carbon steel S〇〇C	合金鋼 Alloy steel SCM, SCr	調質鋼 Heat-treated steel SKD, SKS	工具鋼 Tool steel ~40HRC	焼入れ鋼 Hardened steel ~45HRC, 45HRC~	ステンレス鋼 Stainless steel SUS	耐熱鋼 Ti合金 Heat-resistant steel, Ti alloy Inconel	鋳鉄 Cast iron FC	ダクタイル鋳鉄 Ductile cast iron FCD	アルミ合金 Aluminum alloy Al	銅合金 Copper alloy Cu
○	○	○	○	○	○	○	○	○	○	○	○

●印：標準在庫品です。□印：特定代理店在庫です。弊社営業へお問い合わせください。
●：Stocked items. □：Stocked by specified distributor. Contact with our sales department.

再研磨対応外径範囲

Re-grinding compatibility range

商品コード Item code	エンド End (mm)
15WHNSB-TH	2 ~ 13

Carbide Oil Hole Non Step Borer 20D

超硬OHノンステップボーラー 20D



直径公差 下表を参照 Refer to under table



(mm)

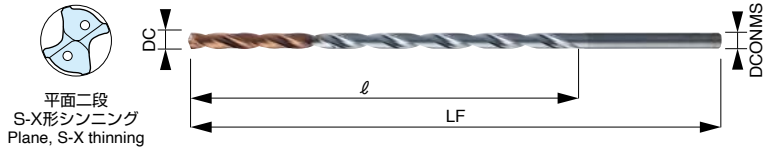

20WHNSB-TH

切削条件表 E30 Cutting Conditions

商品コード Item code	在庫 Stock	寸法 Size (mm)				希望小売価格 (円) Suggested retail price(¥)
		直径 Tool dia. DC	溝長 Flutlet length ℓ	全長 Overall length LF	シャンク径 Shank dia. DCONMS	
20WHNSB0200-TH	●	2.0	50	93	3.0	29,630
20WHNSB0210-TH	●	2.1	55	98	3.0	29,630
20WHNSB0220-TH	●	2.2	55	98	3.0	29,630
20WHNSB0230-TH	●	2.3	62	105	3.0	29,630
20WHNSB0240-TH	●	2.4	62	105	3.0	29,630
20WHNSB0250-TH	●	2.5	62	105	3.0	29,630
20WHNSB0260-TH	●	2.6	67	110	3.0	29,630
20WHNSB0270-TH	●	2.7	67	110	3.0	29,630
20WHNSB0280-TH	●	2.8	69	115	3.0	29,630
20WHNSB0290-TH	●	2.9	69	115	3.0	29,630
20WHNSB0300-TH	●	3.0	69	117	3.0	29,630
20WHNSB0310-TH	●	3.1	81	129	4.0	30,080
20WHNSB0320-TH	●	3.2	81	129	4.0	30,080
20WHNSB0330-TH	●	3.3	81	129	4.0	30,080
20WHNSB0340-TH	●	3.4	81	129	4.0	30,080
20WHNSB0350-TH	●	3.5	81	129	4.0	30,080
20WHNSB0360-TH	●	3.6	92	141	4.0	30,420
20WHNSB0370-TH	●	3.7	92	141	4.0	30,420
20WHNSB0380-TH	●	3.8	92	141	4.0	30,420
20WHNSB0390-TH	●	3.9	92	141	4.0	30,420
20WHNSB0400-TH	●	4.0	92	141	4.0	30,420
20WHNSB0410-TH	●	4.1	104	155	5.0	31,090
20WHNSB0420-TH	●	4.2	104	155	5.0	31,090
20WHNSB0430-TH	●	4.3	104	155	5.0	31,090
20WHNSB0440-TH	●	4.4	104	155	5.0	31,090
20WHNSB0450-TH	●	4.5	104	155	5.0	31,090
20WHNSB0460-TH	●	4.6	116	167	5.0	31,760
20WHNSB0470-TH	●	4.7	116	167	5.0	31,760
20WHNSB0480-TH	●	4.8	116	167	5.0	31,760
20WHNSB0490-TH	●	4.9	116	167	5.0	31,760
20WHNSB0500-TH	●	5.0	116	167	5.0	31,760
20WHNSB0510-TH	●	5.1	127	178	6.0	33,900
20WHNSB0520-TH	●	5.2	127	178	6.0	33,900
20WHNSB0530-TH	●	5.3	127	178	6.0	33,900
20WHNSB0540-TH	●	5.4	127	178	6.0	33,900
20WHNSB0550-TH	●	5.5	127	178	6.0	33,900
20WHNSB0560-TH	●	5.6	139	190	6.0	35,910
20WHNSB0570-TH	●	5.7	139	190	6.0	35,910
20WHNSB0580-TH	●	5.8	139	190	6.0	35,910
20WHNSB0590-TH	●	5.9	139	190	6.0	35,910
20WHNSB0600-TH	●	6.0	139	190	6.0	35,910
20WHNSB0610-TH	●	6.1	150	203	7.0	38,490
20WHNSB0620-TH	●	6.2	150	203	7.0	38,490

商品コード Item code	在庫 Stock	寸法 Size (mm)				希望小売価格 (円) Suggested retail price(¥)
		直径 Tool dia. DC	溝長 Flutlet length ℓ	全長 Overall length LF	シャンク径 Shank dia. DCONMS	
20WHNSB0630-TH	●	6.3	150	203	7.0	38,490
20WHNSB0640-TH	●	6.4	150	203	7.0	38,490
20WHNSB0650-TH	●	6.5	150	203	7.0	38,490
20WHNSB0660-TH	●	6.6	162	215	7.0	40,960
20WHNSB0670-TH	●	6.7	162	215	7.0	40,960
20WHNSB0680-TH	●	6.8	162	215	7.0	40,960
20WHNSB0690-TH	●	6.9	162	215	7.0	40,960
20WHNSB0700-TH	●	7.0	162	215	7.0	40,960
20WHNSB0710-TH	●	7.1	173	228	8.0	43,320
20WHNSB0720-TH	●	7.2	173	228	8.0	43,320
20WHNSB0730-TH	●	7.3	173	228	8.0	43,320
20WHNSB0740-TH	●	7.4	173	228	8.0	43,320
20WHNSB0750-TH	●	7.5	173	228	8.0	43,320
20WHNSB0760-TH	●	7.6	185	240	8.0	45,570
20WHNSB0770-TH	●	7.7	185	240	8.0	45,570
20WHNSB0780-TH	●	7.8	185	240	8.0	45,570
20WHNSB0790-TH	●	7.9	185	240	8.0	45,570
20WHNSB0800-TH	●	8.0	185	240	8.0	45,570
20WHNSB0810-TH	□	8.1	196	251	9.0	-
20WHNSB0820-TH	□	8.2	196	251	9.0	-
20WHNSB0830-TH	●	8.3	196	251	9.0	52,860
20WHNSB0840-TH	●	8.4	196	251	9.0	52,860
20WHNSB0850-TH	●	8.5	196	251	9.0	52,860
20WHNSB0860-TH	□	8.6	208	263	9.0	-
20WHNSB0870-TH	□	8.7	208	263	9.0	-
20WHNSB0880-TH	●	8.8	208	263	9.0	55,540
20WHNSB0890-TH	●	8.9	208	263	9.0	55,540
20WHNSB0900-TH	●	9.0	208	263	9.0	55,540
20WHNSB0910-TH	□	9.1	219	274	10.0	-
20WHNSB0920-TH	□	9.2	219	274	10.0	-
20WHNSB0930-TH	●	9.3	219	274	10.0	57,680
20WHNSB0940-TH	●	9.4	219	274	10.0	57,680
20WHNSB0950-TH	●	9.5	219	274	10.0	57,680
20WHNSB0960-TH	□	9.6	231	286	10.0	-
20WHNSB0970-TH	□	9.7	231	286	10.0	-
20WHNSB0980-TH	●	9.8	231	286	10.0	60,480
20WHNSB0990-TH	●	9.9	231	286	10.0	60,480
20WHNSB1000-TH	●	10.0	231	286	10.0	60,480
20WHNSB1010-TH	□	10.1	243	298	11.0	-
20WHNSB1020-TH	□	10.2	243	298	11.0	-
20WHNSB1030-TH	●	10.3	243	298	11.0	67,780
20WHNSB1040-TH	●	10.4	243	298	11.0	67,780
20WHNSB1050-TH	●	10.5	243	298	11.0	67,780

商品コード Item code	在庫 Stock	寸法 Size (mm)				希望小売価格 (円) Suggested retail price(¥)
		直径 Tool dia. DC	溝長 Flutlet length ℓ	全長 Overall length LF	シャンク径 Shank dia. DCONMS	
20WHNSB1060-TH	□	10.6	254	315	11.0	-
20WHNSB1070-TH	□	10.7	254	315	11.0	-
20WHNSB1080-TH	●	10.8	254	315	11.0	75,070
20WHNSB1090-TH	●	10.9	254	315	11.0	75,070
20WHNSB1100-TH	●	11.0	254	315	11.0	75,070
20WHNSB1110-TH	□	11.1	266	327	12.0	-
20WHNSB1120-TH	□	11.2	266	327	12.0	-
20WHNSB1130-TH	●	11.3	266	327	12.0	78,540
20WHNSB1140-TH	●	11.4	266	327	12.0	78,540
20WHNSB1150-TH	●	11.5	266	327	12.0	78,540
20WHNSB1160-TH	□	11.6	277	338	12.0	-
20WHNSB1170-TH	□	11.7	277	338	12.0	-
20WHNSB1180-TH	●	11.8	277	338	12.0	82,250
20WHNSB1190-TH	●	11.9	277	338	12.0	82,250
20WHNSB1200-TH	●	12.0	277	338	12.0	82,250
20WHNSB1210-TH	□	12.1	289	350	13.0	-
20WHNSB1220-TH	□	12.2	289	350	13.0	-
20WHNSB1230-TH	□	12.3	289	350	13.0	-
20WHNSB1240-TH	□	12.4	289	350	13.0	-
20WHNSB1250-TH	●	12.5	289	350	13.0	98,970
20WHNSB1260-TH	□	12.6	300	366	13.0	-
20WHNSB1270-TH	□	12.7	300	366	13.0	-
20WHNSB1280-TH	□	12.8	300	366	13.0	-
20WHNSB1290-TH	□	12.9	300	366	13.0	-
20WHNSB1300-TH	●	13.0	300	366	13.0	102,670

20WHNSB直径公差表

Table of Tolerance on tool dia.

直径2.0~3.0, 3.5, 4.0, 4.5, 5.0, 5.5, 6.0, 6.5, 7.0, 7.5, 8.0, 8.5, 9.0, 10.0, 11.0, 12.0, 13.0はh8となります。

上記以外のアイテムは下表の直径公差になります。

h8 for diameters of 2.0 to 3.0, 3.5, 4.0, 4.5, 5.0, 5.5, 6.0, 6.5, 7.0, 7.5, 8.0, 8.5, 9.0, 10.0, 11.0, 12.0 and 13.0. For other items, the diameter tolerance will be as in the table below.

(mm)

20WHNSB			
	3.0<DC<6.0	6.0<DC<10.0	10.0<DC≤13.0
上限 Max	-0.020	-0.024	-0.030
下限 Min	-0.036	-0.045	-0.053

対応被削材

Applicable work material

軟鋼 Mild steel	炭素鋼 Carbon steel	合金鋼 Alloy steel	調質鋼 Heat-treated steel	工具鋼 Tool steel	焼入れ鋼 Hardened steel	ステンレス鋼 Stainless steel	耐熱鋼 Ti合金 Heat-resistant steel, Ti alloy	鋳鉄 Cast iron	ダクタイル鋳鉄 Ductile cast iron	アルミ合金 Aluminum alloy	銅合金 Copper alloy
SS	SCOC	SCM, SCr	SKD, SKS	~40HRC	~45HRC, 45HRC~	SUS	Inconel	FC	FCD	Al	Cu

再研磨対応外径範囲

Re-grinding compatibility range

商品コード Item code	エンド End (mm)
20WHNSB-TH	2 ~ 13

Boring Tools

Non Step Borer

Carbide Oil Hole Non Step Borer 25D

超硬OHノンステップボーラー 25D

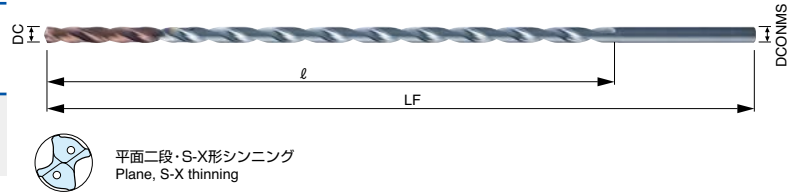

直径公差 下表を参照 Refer to under table



平面二段・S-X形シンニング Plane, S-X thinning

25WHNSB-TH

切削条件表 E30 Cutting Conditions

商品コード Item code	在庫 Stock	寸法 Size (mm)				希望小売価格 (円) Suggested retail price(¥)
		直径 Tool dia. DC	溝長 Flute length ℓ	全長 Overall length LF	シャンク径 Shank dia. DCONMS	
25WHNSB0200-TH	●	2.0	57	100	3.0	31,090
25WHNSB0210-TH	●	2.1	62	105	3.0	31,090
25WHNSB0220-TH	●	2.2	62	105	3.0	31,090
25WHNSB0230-TH	●	2.3	71	114	3.0	31,090
25WHNSB0240-TH	●	2.4	71	114	3.0	31,090
25WHNSB0250-TH	●	2.5	71	114	3.0	31,090
25WHNSB0260-TH	●	2.6	76	119	3.0	31,090
25WHNSB0270-TH	●	2.7	76	119	3.0	31,090
25WHNSB0280-TH	●	2.8	84	132	3.0	31,090
25WHNSB0290-TH	●	2.9	84	132	3.0	31,090
25WHNSB0300-TH	●	3.0	84	132	3.0	31,090
25WHNSB0310-TH	●	3.1	90	138	4.0	31,870
25WHNSB0320-TH	●	3.2	90	138	4.0	31,870
25WHNSB0330-TH	●	3.3	98	146	4.0	31,870
25WHNSB0340-TH	●	3.4	98	146	4.0	31,870
25WHNSB0350-TH	●	3.5	98	146	4.0	31,870
25WHNSB0360-TH	●	3.6	113	162	4.0	35,350
25WHNSB0370-TH	●	3.7	113	162	4.0	35,350
25WHNSB0380-TH	●	3.8	113	162	4.0	35,350
25WHNSB0390-TH	●	3.9	113	162	4.0	35,350
25WHNSB0400-TH	●	4.0	113	162	4.0	35,350
25WHNSB0410-TH	●	4.1	127	178	5.0	37,930
25WHNSB0420-TH	●	4.2	127	178	5.0	37,930
25WHNSB0430-TH	●	4.3	127	178	5.0	37,930
25WHNSB0440-TH	●	4.4	127	178	5.0	37,930
25WHNSB0450-TH	●	4.5	127	178	5.0	37,930
25WHNSB0460-TH	●	4.6	141	192	5.0	40,400
25WHNSB0470-TH	●	4.7	141	192	5.0	40,400
25WHNSB0480-TH	●	4.8	141	192	5.0	40,400
25WHNSB0490-TH	●	4.9	141	192	5.0	40,400
25WHNSB0500-TH	●	5.0	141	192	5.0	40,400
25WHNSB0510-TH	●	5.1	155	206	6.0	44,210
25WHNSB0520-TH	●	5.2	155	206	6.0	44,210
25WHNSB0530-TH	●	5.3	155	206	6.0	44,210
25WHNSB0540-TH	●	5.4	155	206	6.0	44,210
25WHNSB0550-TH	●	5.5	155	206	6.0	44,210
25WHNSB0560-TH	●	5.6	169	220	6.0	46,570
25WHNSB0570-TH	●	5.7	169	220	6.0	46,570
25WHNSB0580-TH	●	5.8	169	220	6.0	46,570
25WHNSB0590-TH	●	5.9	169	220	6.0	46,570
25WHNSB0600-TH	●	6.0	169	220	6.0	46,570
25WHNSB0610-TH	●	6.1	183	236	7.0	51,740
25WHNSB0620-TH	●	6.2	183	236	7.0	51,740

商品コード Item code	在庫 Stock	寸法 Size (mm)				希望小売価格 (円) Suggested retail price(¥)
		直径 Tool dia. DC	溝長 Flute length ℓ	全長 Overall length LF	シャンク径 Shank dia. DCONMS	
25WHNSB0630-TH	●	6.3	183	236	7.0	51,740
25WHNSB0640-TH	●	6.4	183	236	7.0	51,740
25WHNSB0650-TH	●	6.5	183	236	7.0	51,740
25WHNSB0660-TH	●	6.6	197	250	7.0	53,750
25WHNSB0670-TH	●	6.7	197	250	7.0	53,750
25WHNSB0680-TH	●	6.8	197	250	7.0	53,750
25WHNSB0690-TH	●	6.9	197	250	7.0	53,750
25WHNSB0700-TH	●	7.0	197	250	7.0	53,750
25WHNSB0710-TH	●	7.1	211	266	8.0	60,820
25WHNSB0720-TH	●	7.2	211	266	8.0	60,820
25WHNSB0730-TH	●	7.3	211	266	8.0	60,820
25WHNSB0740-TH	●	7.4	211	266	8.0	60,820
25WHNSB0750-TH	●	7.5	211	266	8.0	60,820
25WHNSB0760-TH	●	7.6	225	280	8.0	63,180
25WHNSB0770-TH	●	7.7	225	280	8.0	63,180
25WHNSB0780-TH	●	7.8	225	280	8.0	63,180
25WHNSB0790-TH	●	7.9	225	280	8.0	63,180
25WHNSB0800-TH	●	8.0	225	280	8.0	63,180
25WHNSB0810-TH	□	8.1	239	294	9.0	-
25WHNSB0820-TH	□	8.2	239	294	9.0	-
25WHNSB0830-TH	●	8.3	239	294	9.0	71,030
25WHNSB0840-TH	●	8.4	239	294	9.0	71,030
25WHNSB0850-TH	●	8.5	239	294	9.0	71,030
25WHNSB0860-TH	□	8.6	254	309	9.0	-
25WHNSB0870-TH	□	8.7	254	309	9.0	-
25WHNSB0880-TH	●	8.8	254	309	9.0	76,860
25WHNSB0890-TH	●	8.9	254	309	9.0	76,860
25WHNSB0900-TH	●	9.0	254	309	9.0	76,860
25WHNSB0910-TH	□	9.1	268	323	10.0	-
25WHNSB0920-TH	□	9.2	268	323	10.0	-
25WHNSB0930-TH	●	9.3	268	323	10.0	82,920
25WHNSB0940-TH	●	9.4	268	323	10.0	82,920
25WHNSB0950-TH	●	9.5	268	323	10.0	82,920
25WHNSB0960-TH	□	9.6	282	337	10.0	-
25WHNSB0970-TH	□	9.7	282	337	10.0	-
25WHNSB0980-TH	●	9.8	282	337	10.0	89,760
25WHNSB0990-TH	●	9.9	282	337	10.0	89,760
25WHNSB1000-TH	●	10.0	282	337	10.0	89,760
25WHNSB1010-TH	□	10.1	297	358	11.0	-
25WHNSB1020-TH	□	10.2	297	358	11.0	-
25WHNSB1030-TH	●	10.3	297	358	11.0	101,780
25WHNSB1040-TH	●	10.4	297	358	11.0	101,780
25WHNSB1050-TH	●	10.5	297	358	11.0	101,780

商品コード Item code	在庫 Stock	寸法 Size (mm)				希望小売価格 (円) Suggested retail price(¥)
		直径 Tool dia. DC	溝長 Flute length ℓ	全長 Overall length LF	シャンク径 Shank dia. DCONMS	
25WHNSB1060-TH	□	10.6	310	371	11.0	-
25WHNSB1070-TH	□	10.7	310	371	11.0	-
25WHNSB1080-TH	●	10.8	310	371	11.0	112,200
25WHNSB1090-TH	●	10.9	310	371	11.0	112,200
25WHNSB1100-TH	●	11.0	310	371	11.0	112,200
25WHNSB1110-TH	□	11.1	324	385	12.0	-
25WHNSB1120-TH	□	11.2	324	385	12.0	-
25WHNSB1130-TH	●	11.3	324	385	12.0	117,810
25WHNSB1140-TH	●	11.4	324	385	12.0	117,810
25WHNSB1150-TH	●	11.5	324	385	12.0	117,810
25WHNSB1160-TH	□	11.6	338	399	12.0	-
25WHNSB1170-TH	□	11.7	338	399	12.0	-
25WHNSB1180-TH	●	11.8	338	399	12.0	123,420
25WHNSB1190-TH	●	11.9	338	399	12.0	123,420
25WHNSB1200-TH	●	12.0	338	399	12.0	123,420
25WHNSB1210-TH	□	12.1	353	414	13.0	-
25WHNSB1220-TH	□	12.2	353	414	13.0	-
25WHNSB1230-TH	□	12.3	353	414	13.0	-
25WHNSB1240-TH	□	12.4	353	414	13.0	-
25WHNSB1250-TH	●	12.5	353	414	13.0	143,620
25WHNSB1260-TH	□	12.6	367	433	13.0	-
25WHNSB1270-TH	□	12.7	367	433	13.0	-
25WHNSB1280-TH	□	12.8	367	433	13.0	-
25WHNSB1290-TH	□	12.9	367	433	13.0	-
25WHNSB1300-TH	●	13.0	367	433	13.0	148,110

25WHNSB直径公差表

Table of Tolerance on tool dia.

直径2.0~3.0、3.5、4.0、4.5、5.0、5.5、6.0、6.5、7.0、7.5、8.0、8.5、9.0、10.0、11.0、12.0、13.0はh8となります。

上記以外のアイテムは下表の直径公差になります。

h8 for diameters of 2.0 to 3.0, 3.5, 4.0, 4.5, 5.0, 5.5, 6.0, 6.5, 7.0, 7.5, 8.0, 8.5, 9.0, 10.0, 11.0, 12.0, and 13.0 For other items, the diameter tolerance will be as in the table below.

25WHNSB			
	3.0<DC<6.0	6.0<DC<10.0	10.0<DC≤13.0
上限 Max	-0.020	-0.024	-0.030
下限 Min	-0.036	-0.045	-0.053

対応被削材

Applicable work material

軟鋼 Mild steel	炭素鋼 Carbon steel	合金鋼 Alloy steel	調質鋼 Heat-treated steel	工具鋼 Tool steel	焼入れ鋼 Hardened steel	ステンレス鋼 Stainless steel	耐熱鋼 Ti alloy	鋳鉄 Cast iron	ダクタイル鋳鉄 Ductile cast iron	アルミ合金 Aluminum alloy	銅合金 Copper alloy
SS	SOOC	SCM, SCr	SKD, SKS	~40HRC	~45HRC, 45HRC~	SUS	Inconel	FC	FCD	Al	Cu

●印：標準在庫品です。 □印：特定代理店在庫です。弊社営業へお問い合わせください。
● : Stocked items. □ : Stocked by specified distributor. Contact with our sales department.

再研磨対応外径範囲

Re-grinding compatibility range

商品コード Item code	エンド End (mm)
25WHNSB-TH	2 ~ 13

Carbide Oil Hole Non Step Borer 30D

超硬OHノンステップボーラー 30D

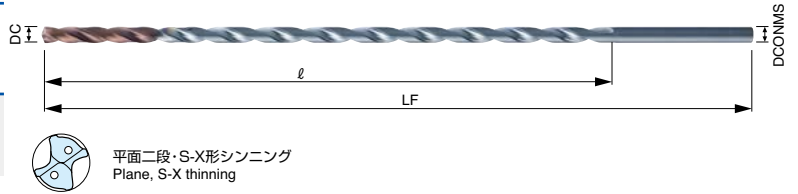

直径公差 下表を参照
Refer to under table



(mm)



平面二段・S-X形シンニング
Plane, S-X thinning

切削条件表 E30
Cutting Conditions

30WHNSB-TH

商品コード Item code	在庫 Stock	寸法 Size (mm)				希望小売価格 (円) Suggested retail price(¥)
		直径 Tool dia. DC	溝長 Flutel length ℓ	全長 Overall length LF	シャンク径 Shank dia. DCONMS	
30WHNSB0200-TH	●	2.0	70	113	3.0	32,430
30WHNSB0210-TH	●	2.1	77	120	3.0	32,430
30WHNSB0220-TH	●	2.2	77	120	3.0	32,430
30WHNSB0230-TH	●	2.3	87	130	3.0	32,430
30WHNSB0240-TH	●	2.4	87	130	3.0	32,430
30WHNSB0250-TH	●	2.5	87	130	3.0	32,430
30WHNSB0260-TH	●	2.6	94	137	3.0	32,430
30WHNSB0270-TH	●	2.7	94	137	3.0	32,430
30WHNSB0280-TH	●	2.8	99	144	3.0	32,430
30WHNSB0290-TH	●	2.9	99	144	3.0	32,430
30WHNSB0300-TH	●	3.0	99	147	3.0	32,430
30WHNSB0310-TH	●	3.1	116	164	4.0	33,660
30WHNSB0320-TH	●	3.2	116	164	4.0	33,660
30WHNSB0330-TH	●	3.3	116	164	4.0	33,660
30WHNSB0340-TH	●	3.4	116	164	4.0	33,660
30WHNSB0350-TH	●	3.5	116	164	4.0	33,660
30WHNSB0360-TH	●	3.6	132	181	4.0	40,290
30WHNSB0370-TH	●	3.7	132	181	4.0	40,290
30WHNSB0380-TH	●	3.8	132	181	4.0	40,290
30WHNSB0390-TH	●	3.9	132	181	4.0	40,290
30WHNSB0400-TH	●	4.0	132	181	4.0	40,290
30WHNSB0410-TH	●	4.1	149	200	5.0	44,660
30WHNSB0420-TH	●	4.2	149	200	5.0	44,660
30WHNSB0430-TH	●	4.3	149	200	5.0	44,660
30WHNSB0440-TH	●	4.4	149	200	5.0	44,660
30WHNSB0450-TH	●	4.5	149	200	5.0	44,660
30WHNSB0460-TH	●	4.6	166	217	5.0	48,930
30WHNSB0470-TH	●	4.7	166	217	5.0	48,930
30WHNSB0480-TH	●	4.8	166	217	5.0	48,930
30WHNSB0490-TH	●	4.9	166	217	5.0	48,930
30WHNSB0500-TH	●	5.0	166	217	5.0	48,930
30WHNSB0510-TH	●	5.1	182	233	6.0	54,540
30WHNSB0520-TH	●	5.2	182	233	6.0	54,540
30WHNSB0530-TH	●	5.3	182	233	6.0	54,540
30WHNSB0540-TH	●	5.4	182	233	6.0	54,540
30WHNSB0550-TH	●	5.5	182	233	6.0	54,540
30WHNSB0560-TH	●	5.6	199	250	6.0	57,120
30WHNSB0570-TH	●	5.7	199	250	6.0	57,120
30WHNSB0580-TH	●	5.8	199	250	6.0	57,120
30WHNSB0590-TH	●	5.9	199	250	6.0	57,120
30WHNSB0600-TH	●	6.0	199	250	6.0	57,120
30WHNSB0610-TH	●	6.1	215	268	7.0	64,860
30WHNSB0620-TH	●	6.2	215	268	7.0	64,860

商品コード Item code	在庫 Stock	寸法 Size (mm)				希望小売価格 (円) Suggested retail price(¥)
		直径 Tool dia. DC	溝長 Flutel length ℓ	全長 Overall length LF	シャンク径 Shank dia. DCONMS	
30WHNSB0630-TH	●	6.3	215	268	7.0	64,860
30WHNSB0640-TH	●	6.4	215	268	7.0	64,860
30WHNSB0650-TH	●	6.5	215	268	7.0	64,860
30WHNSB0660-TH	●	6.6	232	285	7.0	66,540
30WHNSB0670-TH	●	6.7	232	285	7.0	66,540
30WHNSB0680-TH	●	6.8	232	285	7.0	66,540
30WHNSB0690-TH	●	6.9	232	285	7.0	66,540
30WHNSB0700-TH	●	7.0	232	285	7.0	66,540
30WHNSB0710-TH	●	7.1	248	303	8.0	78,210
30WHNSB0720-TH	●	7.2	248	303	8.0	78,210
30WHNSB0730-TH	●	7.3	248	303	8.0	78,210
30WHNSB0740-TH	●	7.4	248	303	8.0	78,210
30WHNSB0750-TH	●	7.5	248	303	8.0	78,210
30WHNSB0760-TH	●	7.6	265	320	8.0	80,680
30WHNSB0770-TH	●	7.7	265	320	8.0	80,680
30WHNSB0780-TH	●	7.8	265	320	8.0	80,680
30WHNSB0790-TH	●	7.9	265	320	8.0	80,680
30WHNSB0800-TH	●	8.0	265	320	8.0	80,680
30WHNSB0810-TH	□	8.1	281	336	9.0	-
30WHNSB0820-TH	□	8.2	281	336	9.0	-
30WHNSB0830-TH	●	8.3	281	336	9.0	89,200
30WHNSB0840-TH	●	8.4	281	336	9.0	89,200
30WHNSB0850-TH	●	8.5	281	336	9.0	89,200
30WHNSB0860-TH	□	8.6	298	353	9.0	-
30WHNSB0870-TH	□	8.7	298	353	9.0	-
30WHNSB0880-TH	●	8.8	298	353	9.0	98,180
30WHNSB0890-TH	●	8.9	298	353	9.0	98,180
30WHNSB0900-TH	●	9.0	298	353	9.0	98,180
30WHNSB0910-TH	□	9.1	314	369	10.0	-
30WHNSB0920-TH	□	9.2	314	369	10.0	-
30WHNSB0930-TH	●	9.3	314	369	10.0	108,170
30WHNSB0940-TH	●	9.4	314	369	10.0	108,170
30WHNSB0950-TH	●	9.5	314	369	10.0	108,170
30WHNSB0960-TH	□	9.6	331	386	10.0	-
30WHNSB0970-TH	□	9.7	331	386	10.0	-
30WHNSB0980-TH	●	9.8	331	386	10.0	118,940
30WHNSB0990-TH	●	9.9	331	386	10.0	118,940
30WHNSB1000-TH	●	10.0	331	386	10.0	118,940
30WHNSB1010-TH	□	10.1	348	403	11.0	-
30WHNSB1020-TH	□	10.2	348	403	11.0	-
30WHNSB1030-TH	●	10.3	348	403	11.0	135,770
30WHNSB1040-TH	●	10.4	348	403	11.0	135,770
30WHNSB1050-TH	●	10.5	348	403	11.0	135,770

商品コード Item code	在庫 Stock	寸法 Size (mm)				希望小売価格 (円) Suggested retail price(¥)
		直径 Tool dia. DC	溝長 Flutel length ℓ	全長 Overall length LF	シャンク径 Shank dia. DCONMS	
30WHNSB1060-TH	□	10.6	364	425	11.0	-
30WHNSB1070-TH	□	10.7	364	425	11.0	-
30WHNSB1080-TH	●	10.8	364	425	11.0	150,350
30WHNSB1090-TH	●	10.9	364	425	11.0	150,350
30WHNSB1100-TH	●	11.0	364	425	11.0	150,350
30WHNSB1110-TH	□	11.1	381	442	12.0	-
30WHNSB1120-TH	□	11.2	381	442	12.0	-
30WHNSB1130-TH	●	11.3	381	442	12.0	157,080
30WHNSB1140-TH	●	11.4	381	442	12.0	157,080
30WHNSB1150-TH	●	11.5	381	442	12.0	157,080
30WHNSB1160-TH	□	11.6	397	458	12.0	-
30WHNSB1170-TH	□	11.7	397	458	12.0	-
30WHNSB1180-TH	●	11.8	397	458	12.0	164,940
30WHNSB1190-TH	●	11.9	397	458	12.0	164,940
30WHNSB1200-TH	●	12.0	397	458	12.0	164,940

30WHNSB直径公差表 Table of Tolerance on tool dia.

直径2.0~3.0, 3.5, 4.0, 4.5, 5.0, 5.5, 6.0, 6.5, 7.0, 7.5, 8.0, 8.5, 9.0, 10.0, 11.0, 12.0はh8となります。
上記以外のアイテムは下表の直径公差になります。
h8 for diameters of 2.0 to 3.0, 3.5, 4.0, 4.5, 5.0, 5.5, 6.0, 6.5, 7.0, 7.5, 8.0, 8.5, 9.0, 10.0, 11.0, and 12.0. For other items, the diameter tolerance will be as in the table below. (mm)

30WHNSB			
	3.0<DC<6.0	6.0<DC<10.0	10.0<DC≤12.0
上限 Max	-0.020	-0.024	-0.030
下限 Min	-0.036	-0.045	-0.053

対応被削材

Applicable work material

軟鋼 Mild steel	炭素鋼 Carbon steel	合金鋼 Alloy steel	調質鋼 Heat-treated steel	工具鋼 Tool steel	焼入れ鋼 Hardened steel	ステンレス鋼 Stainless steel	耐熱鋼 Ti合金 Heat-resistant steel, Ti alloy	鋳鉄 Cast iron	ダクタイル鋳鉄 Ductile cast iron	アルミ合金 Aluminum alloy	銅合金 Copper alloy
SS	SCOC	SCM, SCr	SKD, SKS	~40HRC	~45HRC, 45HRC~	SUS	Inconel	FC	FCD	Al	Cu
○	○	○	○	○	○	○	○	○	○	○	○

再研磨対応外径範囲

Re-grinding compatibility range

商品コード Item code	エンド End (mm)
30WHNSB-TH	2 ~ 12

Boring Tools

Non Step Borer

標準切削条件表 Recommended cutting conditions

10WHNSB-TH | 15WHNSB-TH | 20WHNSB-TH | 25WHNSB-TH | 30WHNSB-TH





被削材 Work material	構造用鋼 Structural steels (~180HB) SS				炭素鋼 Carbon steels (~200HB) S○○○				合金鋼 Alloy steels (~30HRC) SCM, SKD			
	内部クーラント Internal coolant 40~120		MQL (ミスト) MQL (mist) 40~110		内部クーラント Internal coolant 40~120		MQL (ミスト) MQL (mist) 40~110		内部クーラント Internal coolant 40~100		MQL (ミスト) MQL (mist) 40~90	
直径 Tool dia.	回転数 <i>n</i> (min ⁻¹)	送り量 <i>f</i> (mm/rev)	回転数 <i>n</i> (min ⁻¹)	送り量 <i>f</i> (mm/rev)	回転数 <i>n</i> (min ⁻¹)	送り量 <i>f</i> (mm/rev)	回転数 <i>n</i> (min ⁻¹)	送り量 <i>f</i> (mm/rev)	回転数 <i>n</i> (min ⁻¹)	送り量 <i>f</i> (mm/rev)	回転数 <i>n</i> (min ⁻¹)	送り量 <i>f</i> (mm/rev)
Φ2.0	8,000	0.05~0.08	8,000	0.05~0.08	8,000	0.05~0.1	8,000	0.05~0.1	8,000	0.05~0.08	8,000	0.05~0.08
Φ4.0	7,000	0.1~0.16	5,500	0.1~0.16	7,000	0.1~0.16	5,500	0.1~0.16	6,300	0.08~0.12	5,000	0.08~0.12
Φ6.0	4,800	0.15~0.24	4,300	0.15~0.24	4,800	0.15~0.24	4,700	0.15~0.24	4,500	0.12~0.20	3,700	0.12~0.20
Φ8.0	3,600	0.18~0.3	3,200	0.18~0.3	3,600	0.18~0.3	3,600	0.18~0.3	3,400	0.16~0.24	2,900	0.16~0.24
Φ10.0	2,900	0.2~0.3	2,600	0.2~0.30	2,900	0.2~0.3	2,900	0.2~0.30	2,700	0.20~0.30	2,400	0.20~0.30
Φ12.0	2,400	0.22~0.35	2,200	0.22~0.35	2,400	0.22~0.35	2,400	0.22~0.35	2,400	0.22~0.32	2,100	0.22~0.32

被削材 Work material	ステンレス鋼 Stainless steels SUS300系 SUS400系		プリハードン鋼 Pre-hardened steels		ダクタイル鋳鉄 Ductile irons FCD500		鋳物 Casting FC250	
	内部クーラント Internal coolant 30~100		内部クーラント Internal coolant 20~50		内部クーラント Internal coolant 40~120		MQL (ミスト) MQL (mist) 40~100	
直径 Tool dia.	回転数 <i>n</i> (min ⁻¹)	送り量 <i>f</i> (mm/rev)	回転数 <i>n</i> (min ⁻¹)	送り量 <i>f</i> (mm/rev)	回転数 <i>n</i> (min ⁻¹)	送り量 <i>f</i> (mm/rev)	回転数 <i>n</i> (min ⁻¹)	送り量 <i>f</i> (mm/rev)
Φ2.0	6,000	0.03~0.05	4,500	0.03~0.04	8,000	0.05~0.08	8,000	0.05~0.08
Φ4.0	4,800	0.08~0.12	2,400	0.04~0.08	7,000	0.1~0.16	6,300	0.1~0.16
Φ6.0	3,700	0.12~0.20	1,600	0.06~0.09	4,800	0.15~0.24	4,500	0.15~0.24
Φ8.0	2,700	0.16~0.24	1,200	0.08~0.12	3,600	0.18~0.3	3,400	0.18~0.3
Φ10.0	2,200	0.20~0.30	950	0.1~0.15	2,900	0.2~0.35	2,700	0.2~0.35
Φ12.0	1,800	0.22~0.32	800	0.1~0.15	2,400	0.22~0.35	2,400	0.22~0.35

【切削条件の選定について】 Setting of Cutting Conditions ※下記の加工方法を必ず参照ください。 Be sure to refer to the boring procedure (under) when selecting a tool.

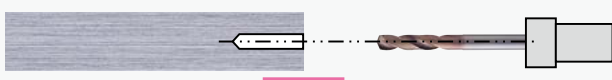
- ※被削材、加工形状に合わせて、適切なクーラントを使用してください。
- ※この標準切削条件表は切削条件の目安を示すものです。実際の加工では加工形状、目的、使用機械等により条件を調整してください。
- ※この内部クーラント切削条件基準は希釈倍率20倍以下の水溶性切削油剤を使用する場合のもので、20倍を超える場合は切削速度範囲の下限を目安に使用してください。
- ※φ5.0以下はクーラント圧は2.0MPa以上を、φ5.0を超える物は1.5MPa以上を推奨いたします。
- ※MQL (ミスト) 加工の場合は工具からの吐出量や吐出の状態により切削速度を下げない加工できない場合があります。
- ※工具装着の際は傷や汚れの無いコレットを用い、工具の振れは0.02mm以下に抑えてください。
- ※油性の切削油剤を使用する場合は切削速度範囲の下限より低速の条件でご使用ください。また、切りくずおよび工具の発熱による発煙・引火にご注意ください。
- ※被削材は変形、たわみ、振動が起らないようしっかりと保持してください。
- ※Use the appropriate coolant for the work material and machining shape.
- ※These Recommended Cutting Conditions indicate only the rule of a thumb for the cutting conditions. In actual machining, the condition should be adjusted according to the machining shape, purpose and the machine type.
- ※The above cutting conditions are based on the use of a water-soluble coolant diluted to a maximum of 20 times. When coolant dilution exceeds 20 times, decrease the cutting speed to the lowest in the specified range. When the tool diameter is φ5.0 or less, the coolant pressure should be 2.0 MPa or higher, and when the diameter is over φ5.0, the pressure should be 1.5 MPa or higher.
- ※When performing MQL (mist) machining, depending on the amount or status of spray from the tool, it may be necessary to reduce the cutting speed in order to perform machining.
- ※When changing the tool, use collet free from flaws and stains and attach the tool firmly so that its runout is 0.02mm or less.
- ※When cutting fluid is used, reduce the cutting speed to a speed lower than the lowest speed in the specified range. Take the greatest care to avoid smoke or ignition due to heating of chips and the tool.
- ※Works should be gripped firmly to prevent deformation, deflection and vibration.

切削加工方法 Drilling Method

- 1 下穴(ガイド穴)加工 (03WHNSB-TH, 05WHNSB-TH)** Drilling of pilot hole (guide hole) (03WHNSB-TH, 05WHNSB-TH)
 - 穴深さ Hole depth : 工具径×2倍~5倍 tool diameter ×2~5 times
 - 加工穴径 Machining diameter : 08~30WHNSB工具径の+0.03~+0.10mm
08~30WHNSB diameter + 0.03~0.10mm
 - 推奨工具 Recommended tools : 03WHNSB-TH, (超硬スタブ型プラス公差受注生産)
0.3WHNSB-TH, Carbide stub type, MTO by customized allowance
- 2 低速回転、クーラントON (08~30WHNSB-TH)** Supplying coolant during low-speed revolution (08~30WHNSB-TH)
 - 低速回転でガイド穴へ (*n*=0~500min⁻¹)
Leading to the guide hole at low speed (*n*=0~500 min⁻¹)
 - ガイド穴加工終了面より2.0~5.0mm手前で送りをストップ
Stop feed 2.0~5.0 mm before the end of the guide hole.
 - ※ 工具刃長が200mm以上の場合は、回転数*n*=200min⁻¹以下でガイド穴へ
When a long tool (200mm or longer) is used, position the tool to the guide hole at low revolution speed (*n*=200min⁻¹ or less).
- 3 切削回転、切削送り (08~30WHNSB-TH)** High-speed revolution for drilling feed (08~30WHNSB-TH)
 - 回転数が正規に上がるの確認し切削送り開始
After confirming that the revolution speed is increasing at the specified rate, start feeding.
- 4 加工終了 Machining completion**
 - 低速回転にて工具を抜く (*n*=0~500min⁻¹)
Withdraw the tool at low speed. (*n*=0~500 min⁻¹)
 - ※ 工具刃長が200mm以上の場合は、回転数*n*=200min⁻¹以下で抜く
When a long tool (200mm or longer) is used, withdraw the tool at low revolution speed (*n*=200min⁻¹ or less).

穴あけ工具 ノンステップボーラー

Carbide Oil Hole Non Step Borer 40D

超硬OHノンステップボーラー40D

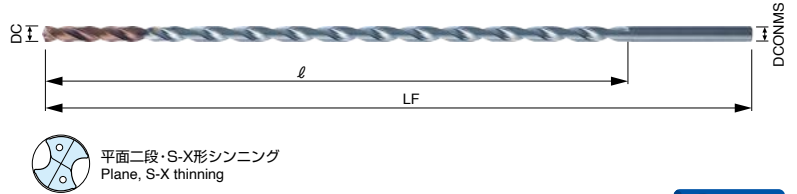

直径公差 下表を参照 Refer to under table
h6 I (mm)

切削条件表 E33
Cutting Conditions

40WHNSB-TH

商品コード Item code	在庫 Stock	寸法 Size (mm)			
		直径 Tool dia. DC	溝長 Flute length ℓ	全長 Overall length LF	シャンク径 Shank dia. DCONMS
40WHNSB0250-TH	◎	2.5	108	159	3.0
40WHNSB0260-TH	□	2.6	117	168	3.0
40WHNSB0270-TH	□	2.7	117	168	3.0
40WHNSB0280-TH	□	2.8	129	180	3.0
40WHNSB0290-TH	□	2.9	129	180	3.0
40WHNSB0300-TH	◎	3.0	129	180	3.0
40WHNSB0310-TH	□	3.1	142	195	4.0
40WHNSB0320-TH	□	3.2	142	195	4.0
40WHNSB0330-TH	□	3.3	142	195	4.0
40WHNSB0340-TH	□	3.4	155	208	4.0
40WHNSB0350-TH	□	3.5	155	208	4.0
40WHNSB0360-TH	□	3.6	155	208	4.0
40WHNSB0370-TH	□	3.7	172	225	4.0
40WHNSB0380-TH	□	3.8	172	225	4.0
40WHNSB0390-TH	□	3.9	172	225	4.0
40WHNSB0400-TH	◎	4.0	172	225	4.0
40WHNSB0410-TH	□	4.1	185	238	5.0
40WHNSB0420-TH	□	4.2	185	238	5.0
40WHNSB0430-TH	□	4.3	185	238	5.0
40WHNSB0440-TH	□	4.4	198	251	5.0
40WHNSB0450-TH	□	4.5	198	251	5.0
40WHNSB0460-TH	□	4.6	198	251	5.0
40WHNSB0470-TH	□	4.7	215	268	5.0
40WHNSB0480-TH	□	4.8	215	268	5.0
40WHNSB0490-TH	□	4.9	215	268	5.0
40WHNSB0500-TH	◎	5.0	215	268	5.0
40WHNSB0510-TH	□	5.1	237	290	6.0
40WHNSB0520-TH	□	5.2	237	290	6.0
40WHNSB0530-TH	□	5.3	237	290	6.0
40WHNSB0540-TH	□	5.4	237	290	6.0
40WHNSB0550-TH	□	5.5	237	290	6.0
40WHNSB0560-TH	□	5.6	258	311	6.0
40WHNSB0570-TH	□	5.7	258	311	6.0
40WHNSB0580-TH	□	5.8	258	311	6.0
40WHNSB0590-TH	□	5.9	258	311	6.0
40WHNSB0600-TH	◎	6.0	258	311	6.0
40WHNSB0610-TH	□	6.1	280	333	7.0
40WHNSB0620-TH	□	6.2	280	333	7.0
40WHNSB0630-TH	□	6.3	280	333	7.0
40WHNSB0640-TH	□	6.4	280	333	7.0
40WHNSB0650-TH	□	6.5	280	333	7.0
40WHNSB0660-TH	□	6.6	301	354	7.0

商品コード Item code	在庫 Stock	寸法 Size (mm)			
		直径 Tool dia. DC	溝長 Flute length ℓ	全長 Overall length LF	シャンク径 Shank dia. DCONMS
40WHNSB0670-TH	□	6.7	301	354	7.0
40WHNSB0680-TH	□	6.8	301	354	7.0
40WHNSB0690-TH	□	6.9	301	354	7.0
40WHNSB0700-TH	□	7.0	301	354	7.0
40WHNSB0710-TH	□	7.1	323	380	8.0
40WHNSB0720-TH	□	7.2	323	380	8.0
40WHNSB0730-TH	□	7.3	323	380	8.0
40WHNSB0740-TH	□	7.4	323	380	8.0
40WHNSB0750-TH	□	7.5	323	380	8.0
40WHNSB0760-TH	□	7.6	344	401	8.0
40WHNSB0770-TH	□	7.7	344	401	8.0
40WHNSB0780-TH	□	7.8	344	401	8.0
40WHNSB0790-TH	□	7.9	344	401	8.0
40WHNSB0800-TH	◎	8.0	344	401	8.0
40WHNSB0810-TH	□	8.1	366	423	9.0
40WHNSB0820-TH	□	8.2	366	423	9.0
40WHNSB0830-TH	□	8.3	366	423	9.0
40WHNSB0840-TH	□	8.4	366	423	9.0
40WHNSB0850-TH	◎	8.5	366	423	9.0
40WHNSB0860-TH	□	8.6	387	444	9.0
40WHNSB0870-TH	□	8.7	387	444	9.0
40WHNSB0880-TH	□	8.8	387	444	9.0
40WHNSB0890-TH	□	8.9	387	444	9.0
40WHNSB0900-TH	□	9.0	387	444	9.0
40WHNSB0910-TH	□	9.1	409	466	10.0
40WHNSB0920-TH	□	9.2	409	466	10.0
40WHNSB0930-TH	□	9.3	409	466	10.0
40WHNSB0940-TH	□	9.4	409	466	10.0
40WHNSB0950-TH	□	9.5	409	466	10.0
40WHNSB0960-TH	□	9.6	430	487	10.0
40WHNSB0970-TH	□	9.7	430	487	10.0
40WHNSB0980-TH	□	9.8	430	487	10.0
40WHNSB0990-TH	□	9.9	430	487	10.0
40WHNSB1000-TH	◎	10.0	430	487	10.0

■ 40WHNSB直径公差表 Table of Tolerance on tool dia.
直径2.5~3.0、3.5、4.0、4.5、5.0、5.5、6.0、6.5、7.0、7.5、8.0、8.5、9.0、10.0はh8となります。上記以外のアイテムは下表の直径公差になります。
h8 for diameters of 2.5 to 3.0, 3.5, 4.0, 4.5, 5.0, 5.5, 6.0, 6.5, 7.0, 7.5, 8.0, 8.5, 9.0 and 10.0
For other items, the diameter tolerance will be as in the table below. (mm)

	3.0<DC<6.0	6.0<DC<10.0
上限 Max	-0.020	-0.024
下限 Min	-0.036	-0.045

掲載品以外の工具寸法品に関しては、別途ご相談に応じます。弊社営業にお問い合わせ下さい。
For products with tool dimensions other than listed items, separate consultation is needed. Please contact our sales office.

○ 対応被削材

Applicable work material

軟鋼 Mild steel SS	炭素鋼 Carbon steel S○○○	合金鋼 Alloy steel SCM, SCr	調質鋼 Heat-treated steel SKD, SKS	工具鋼 Tool steel ~40HRC	焼入れ鋼 Hardened steel ~45HRC 45HRC~	ステンレス鋼 Stainless steel SUS	耐熱鋼 Ti合金 Heat-resistant steel, Ti alloy Inconel	鋳鉄 Cast iron FC	ダクタイル鋳鉄 Ductile cast iron FCD	アルミ合金 Aluminum alloy Al	銅合金 Copper alloy Cu
◎	◎	◎	◎	◎	○	◎	○	○	○		

◎印：メーカー在庫です。 □印：特定代理店在庫です。弊社営業へお問い合わせください。
◎：Manufacturer stocked items. □：Stocked by specified distributor. Contact with our sales department.

○ 再研磨対応外径範囲

Re-grinding compatibility range

商品コード Item code	エンド End (mm)
40WHNSB-TH	2.5 ~ 10

超硬OHノンステップボーラー50D



下表を参照
Refer to under table



(mm)



平面二段・S-X形シンニング
Plane, S-X thinning

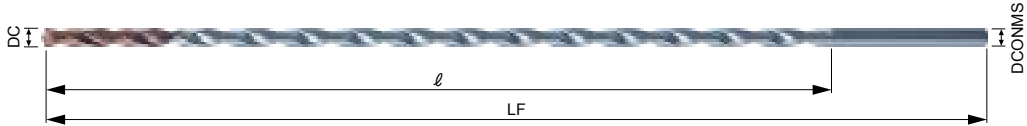

50WHNSB-TH



商品コード Item code	在庫 Stock	寸法 Size (mm)			
		直径 Tool dia. DC	溝長 Flute length ℓ	全長 Overall length LF	シャンク径 Shank dia. DCONMS
50WHNSB0250-TH	◎	2.5	133	184	3.0
50WHNSB0260-TH	□	2.6	144	195	3.0
50WHNSB0270-TH	□	2.7	144	195	3.0
50WHNSB0280-TH	□	2.8	159	210	3.0
50WHNSB0290-TH	□	2.9	159	210	3.0
50WHNSB0300-TH	◎	3.0	159	210	3.0
50WHNSB0310-TH	□	3.1	175	228	4.0
50WHNSB0320-TH	□	3.2	175	228	4.0
50WHNSB0330-TH	□	3.3	175	228	4.0
50WHNSB0340-TH	□	3.4	191	244	4.0
50WHNSB0350-TH	□	3.5	191	244	4.0
50WHNSB0360-TH	□	3.6	191	244	4.0
50WHNSB0370-TH	□	3.7	212	265	4.0
50WHNSB0380-TH	□	3.8	212	265	4.0
50WHNSB0390-TH	□	3.9	212	265	4.0
50WHNSB0400-TH	◎	4.0	212	265	4.0
50WHNSB0410-TH	□	4.1	228	281	5.0
50WHNSB0420-TH	□	4.2	228	281	5.0
50WHNSB0430-TH	□	4.3	228	281	5.0
50WHNSB0440-TH	□	4.4	244	297	5.0
50WHNSB0450-TH	□	4.5	244	297	5.0
50WHNSB0460-TH	□	4.6	244	297	5.0
50WHNSB0470-TH	□	4.7	265	318	5.0
50WHNSB0480-TH	□	4.8	265	318	5.0
50WHNSB0490-TH	□	4.9	265	318	5.0
50WHNSB0500-TH	◎	5.0	265	318	5.0
50WHNSB0510-TH	□	5.1	292	345	6.0
50WHNSB0520-TH	□	5.2	292	345	6.0
50WHNSB0530-TH	□	5.3	292	345	6.0
50WHNSB0540-TH	□	5.4	292	345	6.0
50WHNSB0550-TH	□	5.5	292	345	6.0
50WHNSB0560-TH	□	5.6	318	371	6.0
50WHNSB0570-TH	□	5.7	318	371	6.0
50WHNSB0580-TH	□	5.8	318	371	6.0

商品コード Item code	在庫 Stock	寸法 Size (mm)			
		直径 Tool dia. DC	溝長 Flute length ℓ	全長 Overall length LF	シャンク径 Shank dia. DCONMS
50WHNSB0590-TH	□	5.9	318	371	6.0
50WHNSB0600-TH	◎	6.0	318	371	6.0
50WHNSB0610-TH	□	6.1	345	398	7.0
50WHNSB0620-TH	□	6.2	345	398	7.0
50WHNSB0630-TH	□	6.3	345	398	7.0
50WHNSB0640-TH	□	6.4	345	398	7.0
50WHNSB0650-TH	□	6.5	345	398	7.0
50WHNSB0660-TH	□	6.6	371	424	7.0
50WHNSB0670-TH	□	6.7	371	424	7.0
50WHNSB0680-TH	□	6.8	371	424	7.0
50WHNSB0690-TH	□	6.9	371	424	7.0
50WHNSB0700-TH	□	7.0	371	424	7.0
50WHNSB0710-TH	□	7.1	398	451	8.0
50WHNSB0720-TH	□	7.2	398	451	8.0
50WHNSB0730-TH	□	7.3	398	451	8.0
50WHNSB0740-TH	□	7.4	398	451	8.0
50WHNSB0750-TH	□	7.5	398	451	8.0
50WHNSB0760-TH	□	7.6	424	481	8.0
50WHNSB0770-TH	□	7.7	424	481	8.0
50WHNSB0780-TH	□	7.8	424	481	8.0
50WHNSB0790-TH	□	7.9	424	481	8.0
50WHNSB0800-TH	◎	8.0	424	481	8.0

50WHNSB直径公差表 Table of Tolerance on tool dia.

直径2.5~3.0、3.5、4.0、4.5、5.0、5.5、6.0、6.5、7.0、7.5、8.0はh8となり
ます。上記以外のアイテムは下表の直径公差になります。

h8 for diameters of 2.5 to 3.0, 3.5, 4.0, 4.5, 5.0, 5.5, 6.0, 6.5, 7.0, 7.5 and 8.0 For other items,
the diameter tolerance will be as in the table below. (mm)

	3.0<DC<6.0	6.0<DC<8.0
上限 Max	-0.020	-0.024
下限 Min	-0.036	-0.045

掲載品以外の工具寸法品に関しては、別途ご相談に応じます。弊社営業にお問い合わせ下さい。

For products with tool dimensions other than listed items, separate consultation is needed. Please contact our sales office.

○ 対応被削材

Applicable work material

軟鋼 Mild steel SS	炭素鋼 Carbon steel S○○C	合金鋼 Alloy steel SCM, SCr	調質鋼 Heat-treated steel SKD SKS	工具鋼 Tool steel ~40HRC	焼入れ鋼 Hardened steel ~45HRC 45HRC~	ステン レス鋼 Stainless steel SUS	耐熱鋼 Ti合金 Heat-resistant steel, Ti alloy Inconel	鋳鉄 Cast iron FC	ダクタ イル鋳鉄 Ductile cast iron FCD	アルミ 合金 Aluminum alloy Al	銅合金 Copper alloy Cu
◎	◎	◎	◎	◎	○	◎	○	○	○	○	○

◎印：メーカー在庫です。

○：Manufacturer stocked items.

□印：特定代理店在庫です。弊社営業へお問い合わせください。

□：Stocked by specified distributor. Contact with our sales department.

○ 再研磨対応外径範囲

Re-grinding compatibility range

商品コード Item code	エンド End (mm)
50WHNSB-TH	2.5 ~ 8

Carbide Oil Hole Non Step Borer 40,50D

超硬OHノンステップボーラー40・50D

標準切削条件表 Recommended cutting conditions

40WHNSB-TH 50WHNSB-TH

被削材 Work material	構造用鋼・炭素鋼 Structural steels (~200HB) SS, S〇〇C			合金鋼 Alloy steels (~30HRC) SCM			工具鋼 Tool steels (~35HRC) SKD		
切削速度 Cutting speed Vc (m/min)	40~65~80			40~65~80			25~45~55		
直径 Tool dia.	回転数 n (min ⁻¹)	送り速度 vf (mm/min)	送り量 f (mm/rev)	回転数 n (min ⁻¹)	送り速度 vf (mm/min)	送り量 f (mm/rev)	回転数 n (min ⁻¹)	送り速度 vf (mm/min)	送り量 f (mm/rev)
Φ2.5	8,300	520	0.05~0.08	8,300	520	0.05~0.08	5,700	185	0.025~0.04
Φ3	6,900	520	0.06~0.09	6,900	520	0.06~0.09	4,800	185	0.03~0.05
Φ4	5,200	520	0.08~0.12	5,200	520	0.08~0.12	3,600	185	0.04~0.07
Φ5	4,100	520	0.10~0.15	4,100	520	0.10~0.15	2,900	185	0.05~0.08
Φ6	3,500	520	0.12~0.18	3,500	520	0.12~0.18	2,400	185	0.06~0.10
Φ8	2,600	520	0.16~0.24	2,600	520	0.16~0.24	1,800	185	0.08~0.13
Φ8.5	2,400	520	0.17~0.26	2,400	520	0.17~0.26	1,700	185	0.09~0.14
Φ10	2,100	520	0.20~0.30	2,100	520	0.20~0.30	1,400	185	0.10~0.16

被削材 Work material	工具鋼・プリハードン鋼 Tool steels, Pre-hardened steels (35~45HRC)			ステンレス鋼 Stainless steels SUS			鋳鉄・ダクタイル鋳鉄 Cast irons, Ductile cast irons FC, FCD		
切削速度 Cutting speed Vc (m/min)	25~40~50			30~50~60			40~65~80		
直径 Tool dia.	回転数 n (min ⁻¹)	送り速度 vf (mm/min)	送り量 f (mm/rev)	回転数 n (min ⁻¹)	送り速度 vf (mm/min)	送り量 f (mm/rev)	回転数 n (min ⁻¹)	送り速度 vf (mm/min)	送り量 f (mm/rev)
Φ2.5	5,100	165	0.025~0.04	6,400	320	0.04~0.06	8,300	630	0.06~0.09
Φ3	4,200	165	0.03~0.05	5,300	320	0.05~0.07	6,900	630	0.07~0.11
Φ4	3,200	165	0.04~0.07	4,000	320	0.06~0.09	5,200	630	0.10~0.14
Φ5	2,500	165	0.05~0.08	3,200	320	0.08~0.12	4,100	630	0.12~0.18
Φ6	2,100	165	0.06~0.10	2,700	320	0.10~0.14	3,500	630	0.15~0.21
Φ8	1,600	165	0.08~0.13	2,000	320	0.13~0.18	2,600	520	0.16~0.24
Φ8.5	1,500	165	0.09~0.14	1,900	320	0.14~0.20	2,400	520	0.17~0.26
Φ10	1,300	165	0.10~0.16	1,600	320	0.16~0.23	2,100	520	0.20~0.30

【切削条件の選定について】

- この標準切削条件表は切削条件の目安を示すものです。実際の加工では加工形状、目的、使用機械等により条件を調整してください。
- 工具装着の際は傷や汚れの無いコレットを用い、工具の振れは0.02mm以下に抑えてください。
- 被削材は変形、たわみ、振動が起こらないようしっかりと保持してください。
- 40HRC以上の焼入れ鋼、ステンレス鋼、アルミ合金の加工は、クーラントの使用を推奨します。
- この標準切削条件表は希釈倍率20倍以下の水溶性切削油剤を使用する場合のものです。希釈倍率20倍を超える場合は切削速度範囲の下限を目安に使用してください。また、Φ5.0以下はクーラント圧2.0MPa以上を、Φ5.0を超える場合は1.5MPa以上を推奨いたします。
- ミスト加工の場合は工具の吐出量や状態により切削速度を下げないと加工できない場合があります。
- 油性の切削油剤を使用する場合は切削速度範囲の下限より低速の条件でご使用ください。また、切りくずおよび工具の発熱による発煙・引火にご注意ください。

【Setting of Cutting Conditions】

- The cutting conditions provided in the Recommended Cutting Conditions table are guidelines. For actual machining, adjust conditions based on machining shape, purpose, and machine type.
- When changing the tool, use a collet free of flaws and stains. Attach the tool securely so that the runout is 0.02 mm or less.
- Make sure the workpiece is gripped firmly to prevent deformation, deflection, and vibration.
- We recommend using coolant when machining stainless steels, aluminum alloys, or hardened steels of 40HRC or greater.
- The cutting conditions assume use of water-soluble cutting fluid diluted not more than 20-fold (5%). If the cutting fluid is diluted more than 20-fold, reduce the cutting speed to the lowest in the specified range. If the tool diameter is Φ5.0 or less, coolant pressure should be at least 2.0 MPa. If the tool diameter exceeds Φ5.0, coolant pressure should be at least 1.5 MPa.
- For mist machining, depending on tool spray rate and actual conditions, you may need to reduce cutting speed.
- If you are using oil-based cutting fluid, set the cutting speed below the lowest value of the specified range. Watch for and take adequate steps to avoid fire or smoke generation due to overheating of the tool and chips.

【加工時の注意点について】

- ガイド性を上げるため、ガイド穴は05WHNSB (穴深さ=直径×5が目安)の使用を推奨します。
(例) 05WHNSB0500-THの場合、穴深さ=Φ5.0×5=25mm
使用工具:①ガイド 05WHNSB0500-TH、②ロング 50WHNSB0500-TH
- 40~50WHNSBの加工前に、10~20WHNSB (穴深さ=直径×10~20が目安)で中間加工しますと、穴曲がりなど加工トラブルが減少します。
(例)使用工具:①ガイド 05WHNSB0500-TH、②中間 10WHNSB0500-TH、③ロング 50WHNSB0500-TH
- 初回は、ステップ加工(ステップ量=直径が目安)を行い、クーラント吐出量・切削音・切りくず排出・切りくず形状・ロードメータなど問題が無いか確認することを推奨します。
- 交差穴、通り穴の場合、送り量を下限条件を目安に調整してください。

【Machining Precautions】

- To improve guiding characteristics, we recommend using 05WHNSB (as a guide, hole depth = diameter × 5) for the guide hole.
Example: For 05WHNSB0500-TH, hole depth = Φ5.0 × 5 = 25 mm.
Tools used: ① guide: 05WHNSB0500-TH, ② long: 50WHNSB0500-TH
- Intermediate machining with the 10-20WHNSB (as a guide, hole depth = diameter × 10 - 20) before machining with the 40-50WHNSB will minimize hole bending and other problems.
Example: Tools used: ① Guide: 05WHNSB0500-TH, ② Intermediate machining: 10WHNSB0500-TH, ③ Long: 50WHNSB0500-TH
- We recommend starting with step machining (starting with a step amount equal to diameter) to confirm there are no issues with coolant spray rate, cutting noise, chip evacuation, chip shape, or the load meter.
- As a general rule, adjust the feed rate to the minimum value for intersecting holes and through holes.

○ 切削加工方法 Drilling Method

1 下穴(ガイド穴)加工(05WHNSB-TH) Drilling of pilot hole (guide hole) (05WHNSB-TH)

- 穴深さ Hole depth : 工具径×5倍 tool diameter ×5 times
- 加工穴径 Machining diameter : 40~50WHNSB-TH工具径の0~+0.03mm
40~50WHNSB-TH diameter 0~+0.03mm

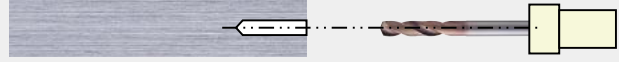

2 低速回転、クーラントON(40~50WHNSB-TH) Supplying coolant during low-speed revolution (40~50WHNSB-TH)

- 低速回転でガイド穴へ($n=0\sim 200\text{min}^{-1}$)
Leading to the guide hole at low speed ($n=0\sim 200\text{ min}^{-1}$)
- ガイド穴加工終了面より2.0~5.0mm手前で送りをストップ
Stop feed 2.0~5.0 mm before the end of the guide hole.



3 切削回転、切削送り(40~50WHNSB-TH) High-speed revolution for drilling feed (40~50WHNSB-TH)

- 回転数が正規に上がるの確認し切削送り開始
After confirming that the revolution speed is increasing at the specified rate, start feeding.

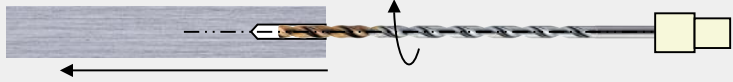

4 加工終了 Machining completion

- 低速回転にて工具を抜く($n=0\sim 200\text{min}^{-1}$)
Withdraw the tool at low speed. ($n=0\sim 200\text{ min}^{-1}$)



超硬ノンステップボーラー 2D

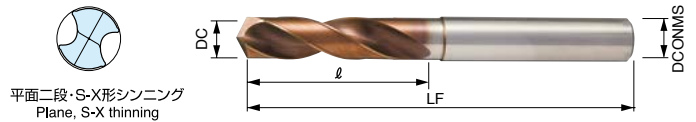

02WNSB-O-O-O-O-TH

切削条件表 E37
Cutting Conditions

商品コード Item code	在庫 Stock	寸法 Size (mm)				希望小売 価格(円) Suggested retail price(¥)
		直径 Tool dia. DC	溝長 Flute length ℓ	全長 Overall length LF	シャンク径 Shank dia. DCONMS	
02WNSB0300-TH	<input type="checkbox"/>	3.0	15	47	3.0	-
02WNSB0310-TH	<input type="checkbox"/>	3.1	18	52	4.0	-
02WNSB0320-TH	<input type="checkbox"/>	3.2	18	52	4.0	-
02WNSB0330-TH	<input type="checkbox"/>	3.3	18	52	4.0	-
02WNSB0340-TH	<input type="checkbox"/>	3.4	18	52	4.0	-
02WNSB0350-TH	<input type="checkbox"/>	3.5	18	52	4.0	-
02WNSB0360-TH	<input type="checkbox"/>	3.6	20	52	4.0	-
02WNSB0370-TH	<input type="checkbox"/>	3.7	20	52	4.0	-
02WNSB0380-TH	<input type="checkbox"/>	3.8	20	52	4.0	-
02WNSB0390-TH	<input type="checkbox"/>	3.9	20	52	4.0	-
02WNSB0400-TH	<input type="checkbox"/>	4.0	20	52	4.0	-
02WNSB0410-TH	<input type="checkbox"/>	4.1	23	59	5.0	-
02WNSB0420-TH	<input type="checkbox"/>	4.2	23	59	5.0	-
02WNSB0430-TH	<input type="checkbox"/>	4.3	23	59	5.0	-
02WNSB0440-TH	<input type="checkbox"/>	4.4	23	59	5.0	-
02WNSB0450-TH	<input type="checkbox"/>	4.5	23	59	5.0	-
02WNSB0460-TH	<input type="checkbox"/>	4.6	25	59	5.0	-
02WNSB0470-TH	<input type="checkbox"/>	4.7	25	59	5.0	-
02WNSB0480-TH	<input type="checkbox"/>	4.8	25	59	5.0	-
02WNSB0490-TH	<input type="checkbox"/>	4.9	25	59	5.0	-
02WNSB0500-TH	<input checked="" type="checkbox"/>	5.0	25	59	5.0	8,820
02WNSB0510-TH	<input checked="" type="checkbox"/>	5.1	25	64	6.0	9,340
02WNSB0520-TH	<input checked="" type="checkbox"/>	5.2	25	64	6.0	9,340
02WNSB0530-TH	<input type="checkbox"/>	5.3	25	64	6.0	-
02WNSB0540-TH	<input checked="" type="checkbox"/>	5.4	25	64	6.0	9,340
02WNSB0550-TH	<input checked="" type="checkbox"/>	5.5	25	64	6.0	9,340
02WNSB0560-TH	<input type="checkbox"/>	5.6	25	64	6.0	-
02WNSB0570-TH	<input type="checkbox"/>	5.7	25	64	6.0	-
02WNSB0580-TH	<input checked="" type="checkbox"/>	5.8	25	64	6.0	9,770
02WNSB0590-TH	<input type="checkbox"/>	5.9	25	64	6.0	-
02WNSB0600-TH	<input checked="" type="checkbox"/>	6.0	25	64	6.0	9,770
02WNSB0610-TH	<input type="checkbox"/>	6.1	29	71	7.0	-
02WNSB0620-TH	<input checked="" type="checkbox"/>	6.2	29	71	7.0	9,770
02WNSB0630-TH	<input type="checkbox"/>	6.3	29	71	7.0	-
02WNSB0640-TH	<input type="checkbox"/>	6.4	29	71	7.0	-
02WNSB0650-TH	<input checked="" type="checkbox"/>	6.5	29	71	7.0	9,770
02WNSB0660-TH	<input type="checkbox"/>	6.6	31	71	7.0	-
02WNSB0670-TH	<input type="checkbox"/>	6.7	31	71	7.0	-
02WNSB0680-TH	<input checked="" type="checkbox"/>	6.8	31	71	7.0	10,380
02WNSB0690-TH	<input checked="" type="checkbox"/>	6.9	31	71	7.0	10,380
02WNSB0700-TH	<input checked="" type="checkbox"/>	7.0	31	71	7.0	10,380
02WNSB0710-TH	<input type="checkbox"/>	7.1	32	76	8.0	-
02WNSB0720-TH	<input type="checkbox"/>	7.2	32	76	8.0	-
02WNSB0730-TH	<input checked="" type="checkbox"/>	7.3	32	76	8.0	10,970
02WNSB0740-TH	<input type="checkbox"/>	7.4	32	76	8.0	-
02WNSB0750-TH	<input checked="" type="checkbox"/>	7.5	32	76	8.0	10,970
02WNSB0760-TH	<input type="checkbox"/>	7.6	34	76	8.0	-
02WNSB0770-TH	<input type="checkbox"/>	7.7	34	76	8.0	-
02WNSB0780-TH	<input checked="" type="checkbox"/>	7.8	34	76	8.0	11,570
02WNSB0790-TH	<input checked="" type="checkbox"/>	7.9	34	76	8.0	11,570
02WNSB0800-TH	<input checked="" type="checkbox"/>	8.0	34	76	8.0	11,570

商品コード Item code	在庫 Stock	寸法 Size (mm)				希望小売 価格(円) Suggested retail price(¥)
		直径 Tool dia. DC	溝長 Flute length ℓ	全長 Overall length LF	シャンク径 Shank dia. DCONMS	
02WNSB0810-TH	<input type="checkbox"/>	8.1	36	80	9.0	-
02WNSB0820-TH	<input type="checkbox"/>	8.2	36	80	9.0	-
02WNSB0830-TH	<input type="checkbox"/>	8.3	36	80	9.0	-
02WNSB0840-TH	<input checked="" type="checkbox"/>	8.4	36	80	9.0	12,240
02WNSB0850-TH	<input checked="" type="checkbox"/>	8.5	36	80	9.0	12,240
02WNSB0860-TH	<input checked="" type="checkbox"/>	8.6	38	80	9.0	12,800
02WNSB0870-TH	<input type="checkbox"/>	8.7	38	80	9.0	-
02WNSB0880-TH	<input checked="" type="checkbox"/>	8.8	38	80	9.0	12,800
02WNSB0890-TH	<input type="checkbox"/>	8.9	38	80	9.0	-
02WNSB0900-TH	<input checked="" type="checkbox"/>	9.0	38	80	9.0	12,800
02WNSB0910-TH	<input type="checkbox"/>	9.1	40	85	10.0	-
02WNSB0920-TH	<input type="checkbox"/>	9.2	40	85	10.0	-
02WNSB0930-TH	<input type="checkbox"/>	9.3	40	85	10.0	-
02WNSB0940-TH	<input checked="" type="checkbox"/>	9.4	40	85	10.0	13,360
02WNSB0950-TH	<input checked="" type="checkbox"/>	9.5	40	85	10.0	13,360
02WNSB0960-TH	<input type="checkbox"/>	9.6	41	85	10.0	-
02WNSB0970-TH	<input type="checkbox"/>	9.7	41	85	10.0	-
02WNSB0980-TH	<input checked="" type="checkbox"/>	9.8	41	85	10.0	14,030
02WNSB0990-TH	<input type="checkbox"/>	9.9	41	85	10.0	-
02WNSB1000-TH	<input checked="" type="checkbox"/>	10.0	41	85	10.0	14,030
02WNSB1010-TH	<input type="checkbox"/>	10.1	42	90	11.0	-
02WNSB1020-TH	<input checked="" type="checkbox"/>	10.2	42	90	11.0	14,590
02WNSB1030-TH	<input checked="" type="checkbox"/>	10.3	42	90	11.0	14,590
02WNSB1040-TH	<input type="checkbox"/>	10.4	42	90	11.0	-
02WNSB1050-TH	<input checked="" type="checkbox"/>	10.5	42	90	11.0	14,590
02WNSB1060-TH	<input checked="" type="checkbox"/>	10.6	44	90	11.0	15,270
02WNSB1070-TH	<input type="checkbox"/>	10.7	44	90	11.0	-
02WNSB1080-TH	<input checked="" type="checkbox"/>	10.8	44	90	11.0	15,270
02WNSB1090-TH	<input type="checkbox"/>	10.9	44	90	11.0	-
02WNSB1100-TH	<input checked="" type="checkbox"/>	11.0	44	90	11.0	15,270
02WNSB1110-TH	<input type="checkbox"/>	11.1	46	94	12.0	-
02WNSB1120-TH	<input type="checkbox"/>	11.2	46	94	12.0	-
02WNSB1130-TH	<input type="checkbox"/>	11.3	46	94	12.0	-
02WNSB1140-TH	<input checked="" type="checkbox"/>	11.4	46	94	12.0	15,940
02WNSB1150-TH	<input checked="" type="checkbox"/>	11.5	46	94	12.0	15,940
02WNSB1160-TH	<input checked="" type="checkbox"/>	11.6	46	94	12.0	16,390
02WNSB1170-TH	<input type="checkbox"/>	11.7	46	94	12.0	-
02WNSB1180-TH	<input checked="" type="checkbox"/>	11.8	46	94	12.0	16,390
02WNSB1190-TH	<input type="checkbox"/>	11.9	46	94	12.0	-
02WNSB1200-TH	<input checked="" type="checkbox"/>	12.0	46	94	12.0	16,390
02WNSB1210-TH	<input type="checkbox"/>	12.1	49	100	13.0	-
02WNSB1220-TH	<input checked="" type="checkbox"/>	12.2	49	100	13.0	17,070
02WNSB1230-TH	<input type="checkbox"/>	12.3	49	100	13.0	-
02WNSB1240-TH	<input type="checkbox"/>	12.4	49	100	13.0	-
02WNSB1250-TH	<input checked="" type="checkbox"/>	12.5	49	100	13.0	17,070
02WNSB1260-TH	<input checked="" type="checkbox"/>	12.6	49	100	13.0	17,630
02WNSB1270-TH	<input type="checkbox"/>	12.7	49	100	13.0	-
02WNSB1280-TH	<input type="checkbox"/>	12.8	49	100	13.0	-
02WNSB1290-TH	<input type="checkbox"/>	12.9	49	100	13.0	-
02WNSB1300-TH	<input checked="" type="checkbox"/>	13.0	49	100	13.0	17,630

●印：標準在庫品です。 □印：特定代理店在庫です。弊社営業へお問い合わせください。
● : Stocked items. □ : Stocked by specified distributor. Contact with our sales department.

Carbide Non Step Borer 4D

超硬ノンステップボーラー 4D



0~0.01 (mm)

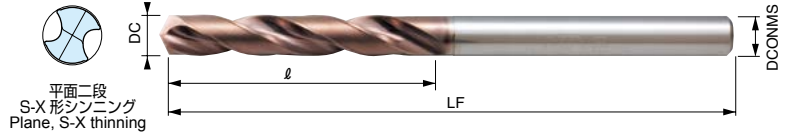

04WNSB-TH

切削条件表 E37
Cutting Conditions

商品コード Item code	在庫 Stock	寸法 Size (mm)				希望小売価格 (円) Suggested retail price (¥)
		直径 Tool dia. DC	溝長 Fluted length ℓ	全長 Overall length LF	シャブ径 Shank dia. DCONMS	
04WNSB0100-TH	●	1.0	8	50	3.0	8,050
04WNSB0110-TH	●	1.1	9	50	3.0	8,050
04WNSB0120-TH	●	1.2	9	50	3.0	8,050
04WNSB0130-TH	●	1.3	10	50	3.0	8,050
04WNSB0140-TH	●	1.4	10	50	3.0	8,050
04WNSB0150-TH	●	1.5	12	50	3.0	8,050
04WNSB0160-TH	●	1.6	12	50	3.0	8,050
04WNSB0170-TH	●	1.7	14	50	3.0	8,050
04WNSB0180-TH	●	1.8	14	50	3.0	8,050
04WNSB0190-TH	●	1.9	16	50	3.0	8,050
04WNSB0200-TH	●	2.0	16	50	3.0	8,050
04WNSB0210-TH	●	2.1	17	50	3.0	8,050
04WNSB0220-TH	●	2.2	17	50	3.0	8,050
04WNSB0230-TH	●	2.3	17	50	3.0	8,050
04WNSB0240-TH	●	2.4	17	50	3.0	8,050
04WNSB0250-TH	●	2.5	17	50	3.0	8,050
04WNSB0260-TH	●	2.6	19	50	3.0	8,050
04WNSB0270-TH	●	2.7	19	50	3.0	8,050
04WNSB0280-TH	●	2.8	19	50	3.0	8,050
04WNSB0290-TH	●	2.9	19	50	3.0	8,050
04WNSB0300-TH	●	3.0	19	50	3.0	8,050
04WNSB0310-TH	●	3.1	23	58	4.0	8,650
04WNSB0320-TH	●	3.2	23	58	4.0	8,650
04WNSB0330-TH	●	3.3	23	58	4.0	8,650
04WNSB0340-TH	●	3.4	23	58	4.0	8,650
04WNSB0350-TH	●	3.5	23	58	4.0	8,650
04WNSB0360-TH	●	3.6	26	58	4.0	9,090
04WNSB0370-TH	●	3.7	26	58	4.0	9,090
04WNSB0380-TH	●	3.8	26	58	4.0	9,090
04WNSB0390-TH	●	3.9	26	58	4.0	9,090
04WNSB0400-TH	●	4.0	26	58	4.0	9,090
04WNSB0410-TH	●	4.1	29	64	5.0	9,760
04WNSB0420-TH	●	4.2	29	64	5.0	9,760
04WNSB0430-TH	●	4.3	29	64	5.0	9,760
04WNSB0440-TH	●	4.4	29	64	5.0	9,760
04WNSB0450-TH	●	4.5	29	64	5.0	9,760
04WNSB0460-TH	●	4.6	32	64	5.0	10,370
04WNSB0470-TH	●	4.7	32	64	5.0	10,370
04WNSB0480-TH	●	4.8	32	64	5.0	10,370
04WNSB0490-TH	●	4.9	32	64	5.0	10,370
04WNSB0500-TH	●	5.0	32	64	5.0	10,370
04WNSB0510-TH	●	5.1	36	78	6.0	10,980
04WNSB0520-TH	●	5.2	36	78	6.0	10,980

商品コード Item code	在庫 Stock	寸法 Size (mm)				希望小売価格 (円) Suggested retail price (¥)
		直径 Tool dia. DC	溝長 Fluted length ℓ	全長 Overall length LF	シャブ径 Shank dia. DCONMS	
04WNSB0530-TH	●	5.3	36	78	6.0	10,980
04WNSB0540-TH	●	5.4	36	78	6.0	10,980
04WNSB0550-TH	●	5.5	36	78	6.0	10,980
04WNSB0560-TH	●	5.6	39	78	6.0	11,460
04WNSB0570-TH	●	5.7	39	78	6.0	11,460
04WNSB0580-TH	●	5.8	39	78	6.0	11,460
04WNSB0590-TH	●	5.9	39	78	6.0	11,460
04WNSB0600-TH	●	6.0	39	78	6.0	11,460
04WNSB0610-TH	●	6.1	41	83	7.0	11,460
04WNSB0620-TH	●	6.2	41	83	7.0	11,460
04WNSB0630-TH	●	6.3	41	83	7.0	11,460
04WNSB0640-TH	●	6.4	41	83	7.0	11,460
04WNSB0650-TH	●	6.5	41	83	7.0	11,460
04WNSB0660-TH	●	6.6	43	83	7.0	12,130
04WNSB0670-TH	●	6.7	43	83	7.0	12,130
04WNSB0680-TH	●	6.8	43	83	7.0	12,130
04WNSB0690-TH	●	6.9	43	83	7.0	12,130
04WNSB0700-TH	●	7.0	43	83	7.0	12,130
04WNSB0710-TH	●	7.1	45	90	8.0	13,030
04WNSB0720-TH	●	7.2	45	90	8.0	13,030
04WNSB0730-TH	●	7.3	45	90	8.0	13,030
04WNSB0740-TH	●	7.4	45	90	8.0	13,030
04WNSB0750-TH	●	7.5	45	90	8.0	13,030
04WNSB0760-TH	●	7.6	48	90	8.0	13,590
04WNSB0770-TH	●	7.7	48	90	8.0	13,590
04WNSB0780-TH	●	7.8	48	90	8.0	13,590
04WNSB0790-TH	●	7.9	48	90	8.0	13,590
04WNSB0800-TH	●	8.0	48	90	8.0	13,590
04WNSB0810-TH	●	8.1	52	96	9.0	14,480
04WNSB0820-TH	●	8.2	52	96	9.0	14,480
04WNSB0830-TH	●	8.3	52	96	9.0	14,480
04WNSB0840-TH	●	8.4	52	96	9.0	14,480
04WNSB0850-TH	●	8.5	52	96	9.0	14,480
04WNSB0860-TH	●	8.6	54	96	9.0	14,930
04WNSB0870-TH	●	8.7	54	96	9.0	14,930
04WNSB0880-TH	●	8.8	54	96	9.0	14,930
04WNSB0890-TH	●	8.9	54	96	9.0	14,930
04WNSB0900-TH	●	9.0	54	96	9.0	14,930
04WNSB0910-TH	●	9.1	57	104	10.0	15,830
04WNSB0920-TH	●	9.2	57	104	10.0	15,830
04WNSB0930-TH	●	9.3	57	104	10.0	15,830
04WNSB0940-TH	●	9.4	57	104	10.0	15,830
04WNSB0950-TH	●	9.5	57	104	10.0	15,830

商品コード Item code	在庫 Stock	寸法 Size (mm)				希望小売価格 (円) Suggested retail price (¥)
		直径 Tool dia. DC	溝長 Fluted length ℓ	全長 Overall length LF	シャブ径 Shank dia. DCONMS	
04WNSB0960-TH	●	9.6	60	104	10.0	16,270
04WNSB0970-TH	●	9.7	60	104	10.0	16,270
04WNSB0980-TH	●	9.8	60	104	10.0	16,270
04WNSB0990-TH	●	9.9	60	104	10.0	16,270
04WNSB1000-TH	●	10.0	60	104	10.0	16,270
04WNSB1010-TH	●	10.1	63	112	11.0	17,180
04WNSB1020-TH	●	10.2	63	112	11.0	17,180
04WNSB1030-TH	●	10.3	63	112	11.0	17,180
04WNSB1040-TH	●	10.4	63	112	11.0	17,180
04WNSB1050-TH	●	10.5	63	112	11.0	17,180
04WNSB1060-TH	●	10.6	66	112	11.0	17,960
04WNSB1070-TH	●	10.7	66	112	11.0	17,960
04WNSB1080-TH	●	10.8	66	112	11.0	17,960
04WNSB1090-TH	●	10.9	66	112	11.0	17,960
04WNSB1100-TH	●	11.0	66	112	11.0	17,960
04WNSB1110-TH	●	11.1	71	121	12.0	18,410
04WNSB1120-TH	●	11.2	71	121	12.0	18,410
04WNSB1130-TH	●	11.3	71	121	12.0	18,410
04WNSB1140-TH	●	11.4	71	121	12.0	18,410
04WNSB1150-TH	●	11.5	71	121	12.0	18,410
04WNSB1160-TH	●	11.6	73	121	12.0	19,310
04WNSB1170-TH	●	11.7	73	121	12.0	19,310
04WNSB1180-TH	●	11.8	73	121	12.0	19,310
04WNSB1190-TH	●	11.9	73	121	12.0	19,310
04WNSB1200-TH	●	12.0	73	121	12.0	19,310
04WNSB1210-TH	●	12.1	76	128	13.0	19,760
04WNSB1220-TH	●	12.2	76	128	13.0	19,760
04WNSB1230-TH	●	12.3	76	128	13.0	19,760
04WNSB1240-TH	●	12.4	76	128	13.0	19,760
04WNSB1250-TH	●	12.5	76	128	13.0	19,760
04WNSB1260-TH	●	12.6	76	128	13.0	20,650
04WNSB1270-TH	●	12.7	76	128	13.0	20,650
04WNSB1280-TH	●	12.8	76	128	13.0	20,650
04WNSB1290-TH	●	12.9	76	128	13.0	20,650
04WNSB1300-TH	●	13.0	76	128	13.0	20,650

02WNSB-TH, 04WNSB-THの対応被削材

Applicable work material of 02WNSB-TH, 04WNSB-TH

軟鋼 Mild steel SS	炭素鋼 Carbon steel S ^{OC}	合金鋼 Alloy steel SCM, SCr	調質鋼 Heat-treated steel SKD SKS	工具鋼 Tool steel ~40HRC	焼入れ鋼 Hardened steel ~45HRC 45HRC~	ステンレス鋼 Stainless steel SUS	耐熱鋼 Ti合金 Heat-resistant steel, Ti alloy Inconel	鋳鉄 Cast iron FC	ダクタイル鋳鉄 Ductile cast iron FCD	アルミ合金 Aluminum alloy Al	銅合金 Copper alloy Cu
○	○	○	○	○	○	○	○	○	○	○	○

再研磨対応外径範囲

Re-grinding compatibility range

商品コード Item code	エンド End (mm)
02WNSB-TH	3 ~ 13
04WNSB-TH	2 ~ 13

●印：標準在庫品です。●：Stocked items.

標準切削条件表 Recommended cutting conditions

O2WNSB-TH | O4WNSB-TH

被削材 Work material	構造用鋼 Structural steels (~180HB) SS				炭素鋼 Carbon steels (~200HB) S〇〇C				合金鋼 Alloy steels (~30HRC) SCM			
	クーラント coolant 70~100~150		MQL (ミスト) MQL (mist) 70~100~150		クーラント coolant 70~100~150		MQL (ミスト) MQL (mist) 70~100~150		クーラント coolant 70~100~150		MQL (ミスト) MQL (mist) 50~80~130	
直径 Tool dia.	回転数 <i>n</i> (min ⁻¹)	送り量 <i>f</i> (mm/rev)	回転数 <i>n</i> (min ⁻¹)	送り量 <i>f</i> (mm/rev)	回転数 <i>n</i> (min ⁻¹)	送り量 <i>f</i> (mm/rev)	回転数 <i>n</i> (min ⁻¹)	送り量 <i>f</i> (mm/rev)	回転数 <i>n</i> (min ⁻¹)	送り量 <i>f</i> (mm/rev)	回転数 <i>n</i> (min ⁻¹)	送り量 <i>f</i> (mm/rev)
Φ1.0	22,000	0.03~0.06	22,000	0.03~0.06	22,000	0.03~0.06	22,000	0.03~0.06	22,000	0.03~0.05	16,000	0.03~0.05
Φ2.0	16,000	0.05~0.1	16,000	0.05~0.1	16,000	0.05~0.1	16,000	0.05~0.1	16,000	0.05~0.08	12,800	0.05~0.08
Φ4.0	8,000	0.1~0.16	8,000	0.1~0.16	8,000	0.1~0.16	8,000	0.1~0.16	8,000	0.1~0.16	6,400	0.1~0.16
Φ6.0	5,300	0.15~0.24	5,300	0.15~0.24	5,300	0.15~0.24	5,300	0.15~0.24	5,300	0.15~0.24	4,300	0.15~0.24
Φ8.0	4,000	0.18~0.3	4,000	0.18~0.3	4,000	0.18~0.3	4,000	0.18~0.3	4,000	0.18~0.3	3,200	0.18~0.3
Φ10.0	3,200	0.2~0.35	3,200	0.2~0.35	3,200	0.2~0.35	3,200	0.2~0.35	3,200	0.2~0.35	2,550	0.2~0.35
Φ12.0	2,650	0.22~0.4	2,650	0.22~0.4	2,650	0.22~0.4	2,650	0.22~0.4	2,650	0.22~0.4	2,100	0.22~0.4

被削材 Work material	SKD61 (~30HRC) Alloy steels プリハードン鋼 (~40HRC) Pre-hardened steels				プリハードン鋼 Pre-hardened steels (~50HRC) SKD	
	クーラント coolant 30~50~80		MQL (ミスト) MQL (mist) 20~40~60		クーラント coolant 20~30~40	
直径 Tool dia.	回転数 <i>n</i> (min ⁻¹)	送り量 <i>f</i> (mm/rev)	回転数 <i>n</i> (min ⁻¹)	送り量 <i>f</i> (mm/rev)	回転数 <i>n</i> (min ⁻¹)	送り量 <i>f</i> (mm/rev)
Φ1.0	9,500	0.02~0.04	6,300	0.02~0.04	6,300	0.01~0.03
Φ2.0	8,000	0.04~0.07	6,400	0.04~0.07	4,800	0.03~0.05
Φ4.0	4,000	0.08~0.13	3,200	0.08~0.13	2,400	0.05~0.1
Φ6.0	2,650	0.12~0.19	2,100	0.12~0.19	1,600	0.08~0.14
Φ8.0	2,000	0.14~0.24	1,600	0.14~0.24	1,200	0.12~0.18
Φ10.0	1,600	0.16~0.28	1,250	0.16~0.28	1,000	0.15~0.2
Φ12.0	1,300	0.18~0.32	1,050	0.18~0.32	800	0.17~0.24

被削材 Work material	ダクタイル鋳鉄 Ductile irons FCD500				鋳物 Casting FC250			
	クーラント coolant 50~80~130		MQL (ミスト) MQL (mist) 50~80~130		クーラント coolant 70~100~150		MQL (ミスト) MQL (mist) 70~100~150	
直径 Tool dia.	回転数 <i>n</i> (min ⁻¹)	送り量 <i>f</i> (mm/rev)	回転数 <i>n</i> (min ⁻¹)	送り量 <i>f</i> (mm/rev)	回転数 <i>n</i> (min ⁻¹)	送り量 <i>f</i> (mm/rev)	回転数 <i>n</i> (min ⁻¹)	送り量 <i>f</i> (mm/rev)
Φ1.0	16,000	0.03~0.06	16,000	0.03~0.06	22,000	0.03~0.06	22,000	0.03~0.06
Φ2.0	12,800	0.05~0.1	12,800	0.05~0.1	16,000	0.05~0.1	16,000	0.05~0.1
Φ4.0	6,400	0.1~0.16	6,400	0.1~0.16	8,000	0.1~0.16	8,000	0.1~0.16
Φ6.0	4,300	0.15~0.24	4,300	0.15~0.24	5,300	0.15~0.24	5,300	0.15~0.24
Φ8.0	3,200	0.18~0.3	3,200	0.18~0.3	4,000	0.18~0.3	4,000	0.18~0.3
Φ10.0	2,550	0.2~0.35	2,550	0.2~0.35	3,200	0.2~0.35	3,200	0.2~0.35
Φ12.0	2,100	0.22~0.4	2,100	0.22~0.4	2,650	0.22~0.4	2,650	0.22~0.4

【切削条件の選定について】 Setting of Cutting Conditions

- ※ 被削材、加工形状に合わせて、適切なクーラントを使用してください。
- ※ この標準切削条件表は切削条件の目安を示すものです。実際の加工では加工形状、目的、使用機械等により条件を調整してください。
- ※ このクーラント切削条件基準は水溶性切削油剤を使用する場合のものです。
- ※ MQL (ミスト) 加工の場合はミストの吐出量や吐出の状態、配管経路等により切削速度を下げないと加工できない場合があります。
- ※ 工具装着の際は傷や汚れの無いコレットを用い、工具の振れは0.02mm以下に抑えてください。
- ※ この切削条件は工具径の4倍までの穴深さに適用ください。
- ※ 油性の切削油剤を使用する場合は切削速度下限値の70%を目安にご使用ください。
- ※ ワークの保持状況、機械剛性によって、条件を適宜調整ください。
- ※ **条件表よりも低い回転数でご使用することもできます。**
- ※ Use the appropriate coolant for the work material and machining shape.
- ※ These Recommended Cutting Conditions indicate only the rule of a thumb for the cutting conditions. In actual machining, the condition should be adjusted according to the machining shape, purpose and the machine type.
- ※ The above cutting conditions are based on the use of a water-soluble coolant.
- ※ When performing MQL (mist) machining, depending on the amount or status of spray from the tool, the piping route, etc., it may be necessary to reduce the cutting speed in order to perform machining.
- ※ When changing the tool, use a collet free from flaws and stains, and attach the tool firmly so that its runout is 0.02mm or less.
- ※ The above conditions apply to a hole-depth of 4 times the diameter or less.
- ※ When cutting fluid is used, reduce the cutting speed to 70% of the lowest speed.
- ※ Adjust the cutting conditions according to work gripping conditions and rigidity of the machine.
- ※ **You can use borers at a revolution speed lower than the above values.**

Boring Tools

Non Step Borer

Carbide Oil Hole Non Step Borer for Cast Iron (3D)

鑄鉄用 超硬OHノンステップボーラー (3D)



平面二段・S-X形シンニング
Plane, S-X thinning

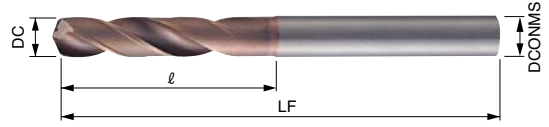

0~0.01 (mm)

切削条件表 E44

03FWHNSB-TH

商品コード Item code	在庫 Stock	寸法 Size (mm)				希望小売 価格(円) Suggested retail price(¥)
		直径 Tool dia. DC	溝長 Flute length ℓ	全長 Overall length LF	シャンク径 Shank dia. DCONMS	
03FWHNSB0300-TH	□	3.0	19	69	3.0	-
03FWHNSB0310-TH	□	3.1	23	73	4.0	-
03FWHNSB0320-TH	□	3.2	23	73	4.0	-
03FWHNSB0330-TH	□	3.3	23	73	4.0	-
03FWHNSB0340-TH	□	3.4	23	73	4.0	-
03FWHNSB0350-TH	□	3.5	23	73	4.0	-
03FWHNSB0360-TH	□	3.6	23	73	4.0	-
03FWHNSB0370-TH	□	3.7	23	73	4.0	-
03FWHNSB0380-TH	□	3.8	23	73	4.0	-
03FWHNSB0390-TH	□	3.9	23	73	4.0	-
03FWHNSB0400-TH	□	4.0	23	73	4.0	-
03FWHNSB0410-TH	□	4.1	29	82	5.0	-
03FWHNSB0420-TH	□	4.2	29	82	5.0	-
03FWHNSB0430-TH	□	4.3	29	82	5.0	-
03FWHNSB0440-TH	□	4.4	29	82	5.0	-
03FWHNSB0450-TH	□	4.5	29	82	5.0	-
03FWHNSB0460-TH	□	4.6	29	82	5.0	-
03FWHNSB0470-TH	□	4.7	29	82	5.0	-
03FWHNSB0480-TH	□	4.8	29	82	5.0	-
03FWHNSB0490-TH	□	4.9	29	82	5.0	-
03FWHNSB0500-TH	●	5.0	29	82	5.0	13,810
03FWHNSB0510-TH	●	5.1	29	82	6.0	14,590
03FWHNSB0520-TH	□	5.2	29	82	6.0	-
03FWHNSB0530-TH	□	5.3	29	82	6.0	-
03FWHNSB0540-TH	□	5.4	29	82	6.0	-
03FWHNSB0550-TH	●	5.5	29	82	6.0	14,590
03FWHNSB0560-TH	□	5.6	29	82	6.0	-
03FWHNSB0570-TH	□	5.7	29	82	6.0	-
03FWHNSB0580-TH	●	5.8	29	82	6.0	14,930
03FWHNSB0590-TH	□	5.9	29	82	6.0	-
03FWHNSB0600-TH	●	6.0	29	82	6.0	14,930
03FWHNSB0610-TH	□	6.1	34	89	7.0	-
03FWHNSB0620-TH	□	6.2	34	89	7.0	-
03FWHNSB0630-TH	□	6.3	34	89	7.0	-
03FWHNSB0640-TH	□	6.4	34	89	7.0	-
03FWHNSB0650-TH	●	6.5	34	89	7.0	15,940
03FWHNSB0660-TH	□	6.6	34	89	7.0	-
03FWHNSB0670-TH	□	6.7	34	89	7.0	-
03FWHNSB0680-TH	●	6.8	34	89	7.0	16,270
03FWHNSB0690-TH	●	6.9	34	89	7.0	16,270
03FWHNSB0700-TH	●	7.0	34	89	7.0	16,270
03FWHNSB0710-TH	□	7.1	39	95	8.0	-
03FWHNSB0720-TH	□	7.2	39	95	8.0	-
03FWHNSB0730-TH	□	7.3	39	95	8.0	-
03FWHNSB0740-TH	□	7.4	39	95	8.0	-
03FWHNSB0750-TH	●	7.5	39	95	8.0	17,740
03FWHNSB0760-TH	□	7.6	39	95	8.0	-
03FWHNSB0770-TH	□	7.7	39	95	8.0	-
03FWHNSB0780-TH	●	7.8	39	95	8.0	18,080
03FWHNSB0790-TH	□	7.9	39	95	8.0	-
03FWHNSB0800-TH	●	8.0	39	95	8.0	18,080

商品コード Item code	在庫 Stock	寸法 Size (mm)				希望小売 価格(円) Suggested retail price(¥)
		直径 Tool dia. DC	溝長 Flute length ℓ	全長 Overall length LF	シャンク径 Shank dia. DCONMS	
03FWHNSB0810-TH	□	8.1	44	101	9.0	-
03FWHNSB0820-TH	●	8.2	44	101	9.0	19,310
03FWHNSB0830-TH	●	8.3	44	101	9.0	19,310
03FWHNSB0840-TH	□	8.4	44	101	9.0	-
03FWHNSB0850-TH	●	8.5	44	101	9.0	19,310
03FWHNSB0860-TH	●	8.6	44	101	9.0	19,640
03FWHNSB0870-TH	□	8.7	44	101	9.0	-
03FWHNSB0880-TH	●	8.8	44	101	9.0	19,640
03FWHNSB0890-TH	□	8.9	44	101	9.0	-
03FWHNSB0900-TH	●	9.0	44	101	9.0	19,640
03FWHNSB0910-TH	□	9.1	49	107	10.0	-
03FWHNSB0920-TH	□	9.2	49	107	10.0	-
03FWHNSB0930-TH	□	9.3	49	107	10.0	-
03FWHNSB0940-TH	□	9.4	49	107	10.0	-
03FWHNSB0950-TH	●	9.5	49	107	10.0	20,990
03FWHNSB0960-TH	□	9.6	49	107	10.0	-
03FWHNSB0970-TH	□	9.7	49	107	10.0	-
03FWHNSB0980-TH	●	9.8	49	107	10.0	21,440
03FWHNSB0990-TH	□	9.9	49	107	10.0	-
03FWHNSB1000-TH	●	10.0	49	107	10.0	21,440
03FWHNSB1010-TH	□	10.1	54	117	11.0	-
03FWHNSB1020-TH	□	10.2	54	117	11.0	22,790
03FWHNSB1030-TH	●	10.3	54	117	11.0	22,790
03FWHNSB1040-TH	□	10.4	54	117	11.0	-
03FWHNSB1050-TH	●	10.5	54	117	11.0	22,790
03FWHNSB1060-TH	□	10.6	54	117	11.0	-
03FWHNSB1070-TH	□	10.7	54	117	11.0	-
03FWHNSB1080-TH	●	10.8	54	117	11.0	23,350
03FWHNSB1090-TH	□	10.9	54	117	11.0	-
03FWHNSB1100-TH	●	11.0	54	117	11.0	23,350
03FWHNSB1110-TH	□	11.1	59	123	12.0	-
03FWHNSB1120-TH	□	11.2	59	123	12.0	-
03FWHNSB1130-TH	□	11.3	59	123	12.0	-
03FWHNSB1140-TH	□	11.4	59	123	12.0	-
03FWHNSB1150-TH	●	11.5	59	123	12.0	24,580
03FWHNSB1160-TH	□	11.6	59	123	12.0	-
03FWHNSB1170-TH	□	11.7	59	123	12.0	-
03FWHNSB1180-TH	●	11.8	59	123	12.0	25,250
03FWHNSB1190-TH	□	11.9	59	123	12.0	-
03FWHNSB1200-TH	●	12.0	59	123	12.0	25,250
03FWHNSB1210-TH	□	12.1	64	129	13.0	-
03FWHNSB1220-TH	●	12.2	64	129	13.0	30,530
03FWHNSB1230-TH	□	12.3	64	129	13.0	-
03FWHNSB1240-TH	□	12.4	64	129	13.0	-
03FWHNSB1250-TH	●	12.5	64	129	13.0	27,720
03FWHNSB1260-TH	□	12.6	64	129	13.0	-
03FWHNSB1270-TH	□	12.7	64	129	13.0	-
03FWHNSB1280-TH	□	12.8	64	129	13.0	-
03FWHNSB1290-TH	□	12.9	64	129	13.0	-
03FWHNSB1300-TH	●	13.0	64	129	13.0	29,630

対応被削材 Applicable work materia

軟鋼 Mild steel SS	炭素鋼 Carbon steel S/SCC	合金鋼 Alloy steel SCM, SCr	調質鋼 Heat-treated steel SKD SKS	工具鋼 Tool steel ~40HRC	焼入れ鋼 Hardened steel ~45HRC 45HRC~	ステンレス鋼 Stainless steel SUS	耐熱鋼 Ti合金 Heat-resistant steel, Ti alloy Inconel	鑄鉄 Cast iron FC	ダクタイル鑄鉄 Ductile cast iron FCD	アルミ合金 Aluminum alloy Al	銅合金 Copper alloy Cu
------------------------	------------------------------	--------------------------------	--------------------------------------	-----------------------------	---	----------------------------------	--	-----------------------	-------------------------------------	-------------------------------	---------------------------

再研磨対応外径範囲 Re-grinding compatibility range

商品コード Item code	エンド End (mm)
03FWHNSB-TH	3 ~ 13

●印：標準在庫品です。●：Stocked items。□印：特定代理店在庫です。弊社営業へお問い合わせください。□：Stocked by specified distributor. Contact with our sales department.

Carbide Oil Hole Non Step Borer for Cast Iron (5D)

鑄鉄用 超硬OHノンステップボーラー (5D)

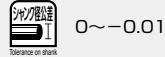

(mm)

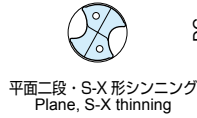

切削条件表 E44

05FWHNSB-TH

商品コード Item code	在庫 Stock	寸法 Size (mm)				希望小売 価格(円) Suggested retail price(¥)
		直径 Tool dia. DC	溝長 Flute length ℓ	全長 Overall length LF	シャンク径 Shank dia. DCONMS	
05FWHNSB0300-TH	●	3.0	29	79	3.0	14,590
05FWHNSB0310-TH	●	3.1	37	87	4.0	15,040
05FWHNSB0320-TH	●	3.2	37	87	4.0	15,040
05FWHNSB0330-TH	●	3.3	37	87	4.0	15,040
05FWHNSB0340-TH	●	3.4	37	87	4.0	15,040
05FWHNSB0350-TH	●	3.5	37	87	4.0	15,040
05FWHNSB0360-TH	●	3.6	37	87	4.0	15,150
05FWHNSB0370-TH	●	3.7	37	87	4.0	15,150
05FWHNSB0380-TH	●	3.8	37	87	4.0	15,150
05FWHNSB0390-TH	●	3.9	37	87	4.0	15,150
05FWHNSB0400-TH	●	4.0	37	87	4.0	15,150
05FWHNSB0410-TH	●	4.1	47	100	5.0	15,600
05FWHNSB0420-TH	●	4.2	47	100	5.0	15,600
05FWHNSB0430-TH	●	4.3	47	100	5.0	15,600
05FWHNSB0440-TH	●	4.4	47	100	5.0	15,600
05FWHNSB0450-TH	●	4.5	47	100	5.0	15,600
05FWHNSB0460-TH	●	4.6	47	100	5.0	15,940
05FWHNSB0470-TH	●	4.7	47	100	5.0	15,940
05FWHNSB0480-TH	●	4.8	47	100	5.0	15,940
05FWHNSB0490-TH	●	4.9	47	100	5.0	15,940
05FWHNSB0500-TH	●	5.0	47	100	5.0	15,940
05FWHNSB0510-TH	●	5.1	47	100	6.0	16,830
05FWHNSB0520-TH	●	5.2	47	100	6.0	16,830
05FWHNSB0530-TH	●	5.3	47	100	6.0	16,830
05FWHNSB0540-TH	●	5.4	47	100	6.0	16,830
05FWHNSB0550-TH	●	5.5	47	100	6.0	16,830
05FWHNSB0560-TH	●	5.6	47	100	6.0	17,070
05FWHNSB0570-TH	●	5.7	47	100	6.0	17,070
05FWHNSB0580-TH	●	5.8	47	100	6.0	17,070
05FWHNSB0590-TH	●	5.9	47	100	6.0	17,070
05FWHNSB0600-TH	●	6.0	47	100	6.0	17,070
05FWHNSB0610-TH	●	6.1	55	110	7.0	18,190
05FWHNSB0620-TH	●	6.2	55	110	7.0	18,190
05FWHNSB0630-TH	●	6.3	55	110	7.0	18,190
05FWHNSB0640-TH	●	6.4	55	110	7.0	18,190
05FWHNSB0650-TH	●	6.5	55	110	7.0	18,190
05FWHNSB0660-TH	●	6.6	55	110	7.0	18,640
05FWHNSB0670-TH	●	6.7	55	110	7.0	18,640
05FWHNSB0680-TH	●	6.8	55	110	7.0	18,640
05FWHNSB0690-TH	●	6.9	55	110	7.0	18,640
05FWHNSB0700-TH	●	7.0	55	110	7.0	18,640
05FWHNSB0710-TH	●	7.1	63	119	8.0	20,090
05FWHNSB0720-TH	●	7.2	63	119	8.0	20,090
05FWHNSB0730-TH	●	7.3	63	119	8.0	20,090
05FWHNSB0740-TH	●	7.4	63	119	8.0	20,090
05FWHNSB0750-TH	●	7.5	63	119	8.0	20,090
05FWHNSB0760-TH	●	7.6	63	119	8.0	20,650
05FWHNSB0770-TH	●	7.7	63	119	8.0	20,650
05FWHNSB0780-TH	●	7.8	63	119	8.0	20,650
05FWHNSB0790-TH	●	7.9	63	119	8.0	20,650
05FWHNSB0800-TH	●	8.0	63	119	8.0	20,650

商品コード Item code	在庫 Stock	寸法 Size (mm)				希望小売 価格(円) Suggested retail price(¥)
		直径 Tool dia. DC	溝長 Flute length ℓ	全長 Overall length LF	シャンク径 Shank dia. DCONMS	
05FWHNSB0810-TH	●	8.1	71	128	9.0	22,000
05FWHNSB0820-TH	●	8.2	71	128	9.0	22,000
05FWHNSB0830-TH	●	8.3	71	128	9.0	22,000
05FWHNSB0840-TH	●	8.4	71	128	9.0	22,000
05FWHNSB0850-TH	●	8.5	71	128	9.0	22,000
05FWHNSB0860-TH	●	8.6	71	128	9.0	22,570
05FWHNSB0870-TH	●	8.7	71	128	9.0	22,570
05FWHNSB0880-TH	●	8.8	71	128	9.0	22,570
05FWHNSB0890-TH	●	8.9	71	128	9.0	22,570
05FWHNSB0900-TH	●	9.0	71	128	9.0	22,570
05FWHNSB0910-TH	●	9.1	79	137	10.0	24,020
05FWHNSB0920-TH	●	9.2	79	137	10.0	24,020
05FWHNSB0930-TH	●	9.3	79	137	10.0	24,020
05FWHNSB0940-TH	●	9.4	79	137	10.0	24,020
05FWHNSB0950-TH	●	9.5	79	137	10.0	24,020
05FWHNSB0960-TH	●	9.6	79	137	10.0	24,360
05FWHNSB0970-TH	●	9.7	79	137	10.0	24,360
05FWHNSB0980-TH	●	9.8	79	137	10.0	24,360
05FWHNSB0990-TH	●	9.9	79	137	10.0	24,360
05FWHNSB1000-TH	●	10.0	79	137	10.0	24,360
05FWHNSB1010-TH	□	10.1	87	150	11.0	-
05FWHNSB1020-TH	●	10.2	87	150	11.0	26,040
05FWHNSB1030-TH	●	10.3	87	150	11.0	26,040
05FWHNSB1040-TH	□	10.4	87	150	11.0	-
05FWHNSB1050-TH	●	10.5	87	150	11.0	26,040
05FWHNSB1060-TH	□	10.6	87	150	11.0	-
05FWHNSB1070-TH	□	10.7	87	150	11.0	-
05FWHNSB1080-TH	●	10.8	87	150	11.0	26,490
05FWHNSB1090-TH	□	10.9	87	150	11.0	-
05FWHNSB1100-TH	●	11.0	87	150	11.0	26,490
05FWHNSB1110-TH	□	11.1	93	156	12.0	-
05FWHNSB1120-TH	□	11.2	93	156	12.0	-
05FWHNSB1130-TH	□	11.3	93	156	12.0	-
05FWHNSB1140-TH	□	11.4	93	156	12.0	-
05FWHNSB1150-TH	●	11.5	93	156	12.0	28,180
05FWHNSB1160-TH	□	11.6	93	156	12.0	-
05FWHNSB1170-TH	□	11.7	93	156	12.0	-
05FWHNSB1180-TH	●	11.8	93	156	12.0	28,850
05FWHNSB1190-TH	□	11.9	93	156	12.0	-
05FWHNSB1200-TH	●	12.0	93	156	12.0	28,850
05FWHNSB1210-TH	□	12.1	104	169	13.0	-
05FWHNSB1220-TH	●	12.2	104	169	13.0	34,910
05FWHNSB1230-TH	□	12.3	104	169	13.0	-
05FWHNSB1240-TH	□	12.4	104	169	13.0	-
05FWHNSB1250-TH	●	12.5	104	169	13.0	31,650
05FWHNSB1260-TH	□	12.6	104	169	13.0	-
05FWHNSB1270-TH	□	12.7	104	169	13.0	-
05FWHNSB1280-TH	□	12.8	104	169	13.0	-
05FWHNSB1290-TH	□	12.9	104	169	13.0	-
05FWHNSB1300-TH	●	13.0	104	169	13.0	33,790

Boring Tools

Non Step Borer

○ 対応被削材 Applicable work materia

軟鋼 Mild steel SS	炭素鋼 Carbon steel S〇〇C	合金鋼 Alloy steel SCM, SCr	調質鋼 Heat-treated steel SKD SKS	工具鋼 Tool steel ~40HRC	焼入れ鋼 Hardened steel ~45HRC 45HRC~	ステン レス鋼 Stainless steel SUS	耐熱鋼 Ti合金 Heat-resistant steel, Ti alloy Inconel	鑄鉄 Cast iron FC	ダクタイル 鑄鉄 Ductile cast iron FCD	アルミ 合金 Aluminum alloy Al	銅合金 Copper alloy Cu
------------------------	--------------------------------	-----------------------------------	--	-----------------------------	---	---	---	-----------------------	--	--------------------------------------	------------------------------

○ 再研磨対応外径範囲 Re-grinding compatibility range

商品コード Item code	エンド End (mm)
05FWHNSB-TH	3 ~ 13

●印：標準在庫品です。●：Stocked items。□印：特定代理店在庫です。弊社営業へお問い合わせください。□：Stocked by specified distributor. Contact with our sales department.

Carbide Oil Hole Non Step Borer for Cast Iron (10D)

鑄鉄用 超硬OHノンステップボーラー (10D)



平面二段・S-X形シンニング
Plane, S-X thinning

※1印
溝全体コーティングです。
Completely coated

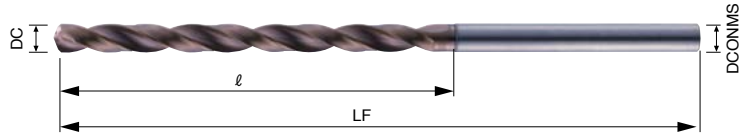

直径公差 下表を参照
Refer to under table



10FWHNSB-TH

切削条件表 E44
Cutting Conditions

商品コード Item code	在庫 Stock	寸法 Size (mm)				希望小売価格 (円) Suggested retail price(¥)
		直径 Tool dia. DC	溝長 Flutel length ℓ	全長 Overall length LF	シャンク径 Shank dia. DCONMS	
10FWHNSB0300-TH	●	3.0	39	87	3.0	23,570
10FWHNSB0310-TH	□	3.1	46	94	4.0	-
10FWHNSB0320-TH	□	3.2	46	94	4.0	-
10FWHNSB0330-TH	□	3.3	46	94	4.0	-
10FWHNSB0340-TH	□	3.4	46	94	4.0	-
10FWHNSB0350-TH	□	3.5	46	94	4.0	-
10FWHNSB0360-TH	□	3.6	52	101	4.0	-
10FWHNSB0370-TH	□	3.7	52	101	4.0	-
10FWHNSB0380-TH	□	3.8	52	101	4.0	-
10FWHNSB0390-TH	□	3.9	52	101	4.0	-
10FWHNSB0400-TH	●	4.0	52	101	4.0	24,250
10FWHNSB0410-TH	□	4.1	59	110	5.0	-
10FWHNSB0420-TH	□	4.2	59	110	5.0	-
10FWHNSB0430-TH	□	4.3	59	110	5.0	-
10FWHNSB0440-TH	□	4.4	59	110	5.0	-
10FWHNSB0450-TH	□	4.5	59	110	5.0	-
10FWHNSB0460-TH	□	4.6	66	117	5.0	-
10FWHNSB0470-TH	□	4.7	66	117	5.0	-
10FWHNSB0480-TH	□	4.8	66	117	5.0	-
10FWHNSB0490-TH	□	4.9	66	117	5.0	-
10FWHNSB0500-TH	●	5.0	66	117	5.0	25,370
10FWHNSB0510-TH	□	5.1	72	123	6.0	-
10FWHNSB0520-TH	□	5.2	72	123	6.0	-
10FWHNSB0530-TH	□	5.3	72	123	6.0	-
10FWHNSB0540-TH	□	5.4	72	123	6.0	-
10FWHNSB0550-TH	●	5.5	72	123	6.0	27,050
10FWHNSB0560-TH	□	5.6	79	130	6.0	-
10FWHNSB0570-TH	□	5.7	79	130	6.0	-
10FWHNSB0580-TH	□	5.8	79	130	6.0	-
10FWHNSB0590-TH	□	5.9	79	130	6.0	-
10FWHNSB0600-TH	●	6.0	79	130	6.0	28,620
10FWHNSB0610-TH	□	6.1	85	138	7.0	-
10FWHNSB0620-TH	□	6.2	85	138	7.0	-
10FWHNSB0630-TH	□	6.3	85	138	7.0	-
10FWHNSB0640-TH	□	6.4	85	138	7.0	-
10FWHNSB0650-TH	●	6.5	85	138	7.0	30,750
10FWHNSB0660-TH	□	6.6	92	145	7.0	-
10FWHNSB0670-TH	□	6.7	92	145	7.0	-
10FWHNSB0680-TH	□	6.8	92	145	7.0	-
10FWHNSB0690-TH	□	6.9	92	145	7.0	-
10FWHNSB0700-TH	●	7.0	92	145	7.0	32,770
10FWHNSB0710-TH	□	7.1	98	153	8.0	-
10FWHNSB0720-TH	□	7.2	98	153	8.0	-

商品コード Item code	在庫 Stock	寸法 Size (mm)				希望小売価格 (円) Suggested retail price(¥)
		直径 Tool dia. DC	溝長 Flutel length ℓ	全長 Overall length LF	シャンク径 Shank dia. DCONMS	
10FWHNSB0730-TH	□	7.3	98	153	8.0	-
10FWHNSB0740-TH	□	7.4	98	153	8.0	-
10FWHNSB0750-TH	□	7.5	98	153	8.0	-
10FWHNSB0760-TH	□	7.6	105	160	8.0	-
10FWHNSB0770-TH	□	7.7	105	160	8.0	-
10FWHNSB0780-TH	□	7.8	105	160	8.0	-
10FWHNSB0790-TH	□	7.9	105	160	8.0	-
10FWHNSB0800-TH	●	8.0	105	160	8.0	36,250
10FWHNSB0810-TH	□	8.1	111	166	9.0	-
10FWHNSB0820-TH	□	8.2	111	166	9.0	-
10FWHNSB0830-TH	□	8.3	111	166	9.0	-
10FWHNSB0840-TH	□	8.4	111	166	9.0	-
10FWHNSB0850-TH	□	8.5	111	166	9.0	-
10FWHNSB0860-TH	□	8.6	118	173	9.0	-
10FWHNSB0870-TH	□	8.7	118	173	9.0	-
10FWHNSB0880-TH	□	8.8	118	173	9.0	-
10FWHNSB0890-TH	□	8.9	118	173	9.0	-
10FWHNSB0900-TH	●	9.0	118	173	9.0	40,180
10FWHNSB0910-TH	□	9.1	124	179	10.0	-
10FWHNSB0920-TH	□	9.2	124	179	10.0	-
10FWHNSB0930-TH	□	9.3	124	179	10.0	-
10FWHNSB0940-TH	□	9.4	124	179	10.0	-
10FWHNSB0950-TH	□	9.5	124	179	10.0	-
10FWHNSB0960-TH	□	9.6	131	186	10.0	-
10FWHNSB0970-TH	□	9.7	131	186	10.0	-
10FWHNSB0980-TH	□	9.8	131	186	10.0	-
10FWHNSB0990-TH	□	9.9	131	186	10.0	-
10FWHNSB1000-TH	●	10.0	131	186	10.0	43,650
10FWHNSB1010-TH	□	10.1	138	193	11.0	-
10FWHNSB1020-TH	□	10.2	138	193	11.0	-
10FWHNSB1030-TH	□	10.3	138	193	11.0	-
10FWHNSB1040-TH	□	10.4	138	193	11.0	-
10FWHNSB1050-TH	□	10.5	138	193	11.0	-
10FWHNSB1060-TH	□	10.6	144	205	11.0	-
10FWHNSB1070-TH	□	10.7	144	205	11.0	-
10FWHNSB1080-TH	□	10.8	144	205	11.0	-
10FWHNSB1090-TH	□	10.9	144	205	11.0	-
10FWHNSB1100-TH	●	11.0	144	205	11.0	50,490
10FWHNSB1110-TH	□	11.1	151	212	12.0	-
10FWHNSB1120-TH	□	11.2	151	212	12.0	-
10FWHNSB1130-TH	□	11.3	151	212	12.0	-
10FWHNSB1140-TH	□	11.4	151	212	12.0	-
10FWHNSB1150-TH	□	11.5	151	212	12.0	-

商品コード Item code	在庫 Stock	寸法 Size (mm)				希望小売価格 (円) Suggested retail price(¥)
		直径 Tool dia. DC	溝長 Flutel length ℓ	全長 Overall length LF	シャンク径 Shank dia. DCONMS	
10FWHNSB1160-TH	□	11.6	157	218	12.0	-
10FWHNSB1170-TH	□	11.7	157	218	12.0	-
10FWHNSB1180-TH	□	11.8	157	218	12.0	-
10FWHNSB1190-TH	□	11.9	157	218	12.0	-
10FWHNSB1200-TH	●	12.0	157	218	12.0	55,660
10FWHNSB1210-TH	□	12.1	164	225	13.0	-
10FWHNSB1220-TH	□	12.2	164	225	13.0	-
10FWHNSB1230-TH	□	12.3	164	225	13.0	-
10FWHNSB1240-TH	□	12.4	164	225	13.0	-
10FWHNSB1250-TH	□	12.5	164	225	13.0	-
10FWHNSB1260-TH	□	12.6	170	236	13.0	-
10FWHNSB1270-TH	□	12.7	170	236	13.0	-
10FWHNSB1280-TH	□	12.8	170	236	13.0	-
10FWHNSB1290-TH	□	12.9	170	236	13.0	-
10FWHNSB1300-TH	□	13.0	170	236	13.0	-

10~30FWHNSB直径公差表 Table of Tolerance on tool dia.

□印: 特定代理店在庫の10~30FWHNSB直径公差
□: Tool diameter tolerance of 10 to 30FWHNSB for stock of specified distributors (mm)

10~30FWHNSB				
	DC ≤ 3.0	3.0 < DC ≤ 6.0	6.0 < DC ≤ 10.0	10.0 < DC ≤ 14.0
上限 Max	-0.015	-0.020	-0.024	-0.030
下限 Min	-0.028	-0.036	-0.045	-0.053

●印: 標準在庫品の10~30FWHNSB直径公差はh8

●: Tool dia. tolerance of stocked items 10 to 30 FWHNSB is h8.

対応被削材 Applicable work materia

Applicable work material of 10FWHNSB-TH

軟鋼 Mild steel SS	炭素鋼 Carbon steel SCCC	合金鋼 Alloy steel SCM, SCr	調質鋼 Heat-treated steel SKD SKS	工具鋼 Tool steel ~40HRC	焼入れ鋼 Hardened steel ~45HRC 45HRC~	ステンレス鋼 Stainless steel SUS	耐熱鋼 Ti合金 Heat-resistant steel, Ti alloy Inconel	鑄鉄 Cast iron FC	ダクタイル鑄鉄 Ductile cast iron FCD	アルミ合金 Aluminum alloy Al	銅合金 Copper alloy Cu
------------------------	-----------------------------	--------------------------------	--------------------------------------	-----------------------------	---	----------------------------------	--	-----------------------	-------------------------------------	-------------------------------	---------------------------

再研磨対応外径範囲

Re-grinding compatibility range

商品コード Item code	エンド End (mm)
10FWHNSB-TH	3 ~ 13

●印: 標準在庫品です。●: Stocked items. □印: 特定代理店在庫です。弊社営業へお問い合わせください。□: Stocked by specified distributor. Contact with our sales department.

Carbide Oil Hole Non Step Borer for Cast Iron (15D)

鑄鉄用 超硬OHノンステップボーラー (15D)

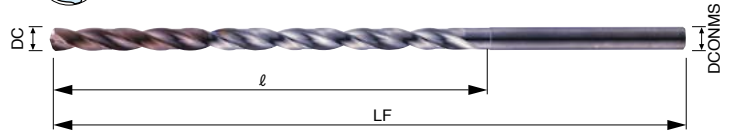
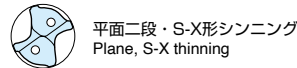

15FWHNSB-TH

切削条件表 E44 Cutting Conditions

商品コード Item code	在庫 Stock	寸法 Size (mm)				希望小売価格 (円) Suggested retail price (¥)
		直径 Tool dia. DC	溝長 Flutel length ℓ	全長 Overall length LF	シャンク径 Shank dia. DCONMS	
15FWHNSB0300-TH	●	3.0	54	102	3.0	25,700
15FWHNSB0310-TH	□	3.1	63	111	4.0	-
15FWHNSB0320-TH	□	3.2	63	111	4.0	-
15FWHNSB0330-TH	□	3.3	63	111	4.0	-
15FWHNSB0340-TH	□	3.4	63	111	4.0	-
15FWHNSB0350-TH	□	3.5	63	111	4.0	-
15FWHNSB0360-TH	□	3.6	72	121	4.0	-
15FWHNSB0370-TH	□	3.7	72	121	4.0	-
15FWHNSB0380-TH	□	3.8	72	121	4.0	-
15FWHNSB0390-TH	□	3.9	72	121	4.0	-
15FWHNSB0400-TH	●	4.0	72	121	4.0	26,370
15FWHNSB0410-TH	□	4.1	81	132	5.0	-
15FWHNSB0420-TH	□	4.2	81	132	5.0	-
15FWHNSB0430-TH	□	4.3	81	132	5.0	-
15FWHNSB0440-TH	□	4.4	81	132	5.0	-
15FWHNSB0450-TH	□	4.5	81	132	5.0	-
15FWHNSB0460-TH	□	4.6	91	142	5.0	-
15FWHNSB0470-TH	□	4.7	91	142	5.0	-
15FWHNSB0480-TH	□	4.8	91	142	5.0	-
15FWHNSB0490-TH	□	4.9	91	142	5.0	-
15FWHNSB0500-TH	●	5.0	91	142	5.0	27,610
15FWHNSB0510-TH	□	5.1	100	151	6.0	-
15FWHNSB0520-TH	□	5.2	100	151	6.0	-
15FWHNSB0530-TH	□	5.3	100	151	6.0	-
15FWHNSB0540-TH	□	5.4	100	151	6.0	-
15FWHNSB0550-TH	●	5.5	100	151	6.0	29,410
15FWHNSB0560-TH	□	5.6	109	160	6.0	-
15FWHNSB0570-TH	□	5.7	109	160	6.0	-
15FWHNSB0580-TH	□	5.8	109	160	6.0	-
15FWHNSB0590-TH	□	5.9	109	160	6.0	-
15FWHNSB0600-TH	●	6.0	109	160	6.0	31,200
15FWHNSB0610-TH	□	6.1	118	171	7.0	-
15FWHNSB0620-TH	□	6.2	118	171	7.0	-
15FWHNSB0630-TH	□	6.3	118	171	7.0	-
15FWHNSB0640-TH	□	6.4	118	171	7.0	-
15FWHNSB0650-TH	●	6.5	118	171	7.0	33,550
15FWHNSB0660-TH	□	6.6	127	180	7.0	-
15FWHNSB0670-TH	□	6.7	127	180	7.0	-
15FWHNSB0680-TH	□	6.8	127	180	7.0	-
15FWHNSB0690-TH	□	6.9	127	180	7.0	-
15FWHNSB0700-TH	●	7.0	127	180	7.0	35,800
15FWHNSB0710-TH	□	7.1	136	191	8.0	-
15FWHNSB0720-TH	□	7.2	136	191	8.0	-

商品コード Item code	在庫 Stock	寸法 Size (mm)				希望小売価格 (円) Suggested retail price (¥)
		直径 Tool dia. DC	溝長 Flutel length ℓ	全長 Overall length LF	シャンク径 Shank dia. DCONMS	
15FWHNSB0730-TH	□	7.3	136	191	8.0	-
15FWHNSB0740-TH	□	7.4	136	191	8.0	-
15FWHNSB0750-TH	□	7.5	136	191	8.0	-
15FWHNSB0760-TH	□	7.6	145	200	8.0	-
15FWHNSB0770-TH	□	7.7	145	200	8.0	-
15FWHNSB0780-TH	□	7.8	145	200	8.0	-
15FWHNSB0790-TH	□	7.9	145	200	8.0	-
15FWHNSB0800-TH	●	8.0	145	200	8.0	39,510
15FWHNSB0810-TH	□	8.1	154	209	9.0	-
15FWHNSB0820-TH	□	8.2	154	209	9.0	-
15FWHNSB0830-TH	□	8.3	154	209	9.0	-
15FWHNSB0840-TH	□	8.4	154	209	9.0	-
15FWHNSB0850-TH	□	8.5	154	209	9.0	-
15FWHNSB0860-TH	□	8.6	163	218	9.0	-
15FWHNSB0870-TH	□	8.7	163	218	9.0	-
15FWHNSB0880-TH	□	8.8	163	218	9.0	-
15FWHNSB0890-TH	□	8.9	163	218	9.0	-
15FWHNSB0900-TH	●	9.0	163	218	9.0	43,880
15FWHNSB0910-TH	□	9.1	172	227	10.0	-
15FWHNSB0920-TH	□	9.2	172	227	10.0	-
15FWHNSB0930-TH	□	9.3	172	227	10.0	-
15FWHNSB0940-TH	□	9.4	172	227	10.0	-
15FWHNSB0950-TH	□	9.5	172	227	10.0	-
15FWHNSB0960-TH	□	9.6	181	236	10.0	-
15FWHNSB0970-TH	□	9.7	181	236	10.0	-
15FWHNSB0980-TH	□	9.8	181	236	10.0	-
15FWHNSB0990-TH	□	9.9	181	236	10.0	-
15FWHNSB1000-TH	●	10.0	181	236	10.0	47,690
15FWHNSB1010-TH	□	10.1	190	245	11.0	-
15FWHNSB1020-TH	□	10.2	190	245	11.0	-
15FWHNSB1030-TH	□	10.3	190	245	11.0	-
15FWHNSB1040-TH	□	10.4	190	245	11.0	-
15FWHNSB1050-TH	□	10.5	190	245	11.0	-
15FWHNSB1060-TH	□	10.6	199	260	11.0	-
15FWHNSB1070-TH	□	10.7	199	260	11.0	-
15FWHNSB1080-TH	□	10.8	199	260	11.0	-
15FWHNSB1090-TH	□	10.9	199	260	11.0	-
15FWHNSB1100-TH	●	11.0	199	260	11.0	61,380
15FWHNSB1110-TH	□	11.1	208	269	12.0	-
15FWHNSB1120-TH	□	11.2	208	269	12.0	-
15FWHNSB1130-TH	□	11.3	208	269	12.0	-
15FWHNSB1140-TH	□	11.4	208	269	12.0	-
15FWHNSB1150-TH	□	11.5	208	269	12.0	-

商品コード Item code	在庫 Stock	寸法 Size (mm)				希望小売価格 (円) Suggested retail price (¥)
		直径 Tool dia. DC	溝長 Flutel length ℓ	全長 Overall length LF	シャンク径 Shank dia. DCONMS	
15FWHNSB1160-TH	□	11.6	217	278	12.0	-
15FWHNSB1170-TH	□	11.7	217	278	12.0	-
15FWHNSB1180-TH	□	11.8	217	278	12.0	-
15FWHNSB1190-TH	□	11.9	217	278	12.0	-
15FWHNSB1200-TH	●	12.0	217	278	12.0	69,010
15FWHNSB1210-TH	□	12.1	226	287	13.0	-
15FWHNSB1220-TH	□	12.2	226	287	13.0	-
15FWHNSB1230-TH	□	12.3	226	287	13.0	-
15FWHNSB1240-TH	□	12.4	226	287	13.0	-
15FWHNSB1250-TH	□	12.5	226	287	13.0	-
15FWHNSB1260-TH	□	12.6	235	301	13.0	-
15FWHNSB1270-TH	□	12.7	235	301	13.0	-
15FWHNSB1280-TH	□	12.8	235	301	13.0	-
15FWHNSB1290-TH	□	12.9	235	301	13.0	-
15FWHNSB1300-TH	□	13.0	235	301	13.0	-

10~30FWHNSB直径公差表 Table of Tolerance on tool dia.

① □印: 特定代理店在庫の10~30FWHNSB直径公差
□: Tool diameter tolerance of 10 to 30FWHNSB for stock of specified distributors (mm)

10~30FWHNSB				
	DC ≤ 3.0	3.0 < DC ≤ 6.0	6.0 < DC ≤ 10.0	10.0 < DC ≤ 14.0
上限 Max	-0.015	-0.020	-0.024	-0.030
下限 Min	-0.028	-0.036	-0.045	-0.053

② ●印: 標準在庫品の10~30FWHNSB 直径公差はh8

●: Tool dia. tolerance of stoked items 10 to 30 FWHNSB is h8.

○ 対応被削材 Applicable work materia

Applicable work material of 15FWHNSB-TH

軟鋼 Mild steel SS	炭素鋼 Carbon steel S	合金鋼 Alloy steel SCM, ScR	調質鋼 Heat-treated steel SKD SKS	工具鋼 Tool steel ~40HRC	焼入れ鋼 Hardened steel ~45HRC 45HRC~	ステンレス鋼 Stainless steel SUS	耐熱鋼 Ti合金 Heat-resistant steel, Ti alloy Inconel	鋳鉄 Cast iron FC	ダクタイル鋳鉄 Ductile cast iron FCD	アルミ合金 Aluminum alloy Al	銅合金 Copper alloy Cu
○	○	○	○	○	○	○	○	○	○	○	○

○ 再研磨対応外径範囲

Re-grinding compatibility range

商品コード Item code	エンド End (mm)
15FWHNSB-TH	3 ~ 13

Boring Tools Non Step Borer

Carbide Oil Hole Non Step Borer for Cast Iron (20D)

鑄鉄用 超硬OHノンステップボーラー (20D)

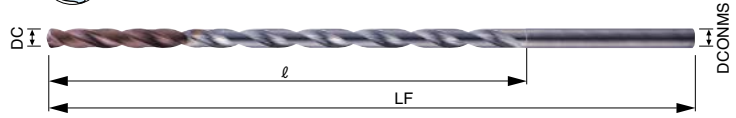
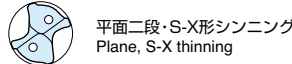

20FWHNSB-TH

切削条件表 E44

商品コード Item code	在庫 Stock	寸法 Size (mm)				希望小売 価格(円) Suggested retail price(¥)
		直径 Tool dia. DC	溝長 Flute length ℓ	全長 Overall length LF	シャフト径 Shank dia. DCONMS	
20FWHNSB0300-TH	●	3.0	69	117	3.0	29,630
20FWHNSB0310-TH	□	3.1	81	129	4.0	-
20FWHNSB0320-TH	□	3.2	81	129	4.0	-
20FWHNSB0330-TH	□	3.3	81	129	4.0	-
20FWHNSB0340-TH	□	3.4	81	129	4.0	-
20FWHNSB0350-TH	□	3.5	81	129	4.0	-
20FWHNSB0360-TH	□	3.6	92	141	4.0	-
20FWHNSB0370-TH	□	3.7	92	141	4.0	-
20FWHNSB0380-TH	□	3.8	92	141	4.0	-
20FWHNSB0390-TH	□	3.9	92	141	4.0	-
20FWHNSB0400-TH	●	4.0	92	141	4.0	30,420
20FWHNSB0410-TH	□	4.1	104	155	5.0	-
20FWHNSB0420-TH	□	4.2	104	155	5.0	-
20FWHNSB0430-TH	□	4.3	104	155	5.0	-
20FWHNSB0440-TH	□	4.4	104	155	5.0	-
20FWHNSB0450-TH	□	4.5	104	155	5.0	-
20FWHNSB0460-TH	□	4.6	116	167	5.0	-
20FWHNSB0470-TH	□	4.7	116	167	5.0	-
20FWHNSB0480-TH	□	4.8	116	167	5.0	-
20FWHNSB0490-TH	□	4.9	116	167	5.0	-
20FWHNSB0500-TH	●	5.0	116	167	5.0	31,760
20FWHNSB0510-TH	□	5.1	127	178	6.0	-
20FWHNSB0520-TH	□	5.2	127	178	6.0	-
20FWHNSB0530-TH	□	5.3	127	178	6.0	-
20FWHNSB0540-TH	□	5.4	127	178	6.0	-
20FWHNSB0550-TH	●	5.5	127	178	6.0	33,900
20FWHNSB0560-TH	□	5.6	139	190	6.0	-
20FWHNSB0570-TH	□	5.7	139	190	6.0	-
20FWHNSB0580-TH	□	5.8	139	190	6.0	-
20FWHNSB0590-TH	□	5.9	139	190	6.0	-
20FWHNSB0600-TH	●	6.0	139	190	6.0	35,910
20FWHNSB0610-TH	□	6.1	150	203	7.0	-
20FWHNSB0620-TH	□	6.2	150	203	7.0	-
20FWHNSB0630-TH	□	6.3	150	203	7.0	-
20FWHNSB0640-TH	□	6.4	150	203	7.0	-
20FWHNSB0650-TH	●	6.5	150	203	7.0	38,490
20FWHNSB0660-TH	□	6.6	162	215	7.0	-
20FWHNSB0670-TH	□	6.7	162	215	7.0	-
20FWHNSB0680-TH	□	6.8	162	215	7.0	-
20FWHNSB0690-TH	□	6.9	162	215	7.0	-
20FWHNSB0700-TH	●	7.0	162	215	7.0	40,960
20FWHNSB0710-TH	□	7.1	173	228	8.0	-
20FWHNSB0720-TH	□	7.2	173	228	8.0	-
20FWHNSB0730-TH	□	7.3	173	228	8.0	-
20FWHNSB0740-TH	□	7.4	173	228	8.0	-
20FWHNSB0750-TH	□	7.5	173	228	8.0	-

商品コード Item code	在庫 Stock	寸法 Size (mm)				希望小売 価格(円) Suggested retail price(¥)
		直径 Tool dia. DC	溝長 Flute length ℓ	全長 Overall length LF	シャフト径 Shank dia. DCONMS	
20FWHNSB0760-TH	□	7.6	185	240	8.0	-
20FWHNSB0770-TH	□	7.7	185	240	8.0	-
20FWHNSB0780-TH	□	7.8	185	240	8.0	-
20FWHNSB0790-TH	□	7.9	185	240	8.0	-
20FWHNSB0800-TH	●	8.0	185	240	8.0	45,570
20FWHNSB0810-TH	□	8.1	196	251	9.0	-
20FWHNSB0820-TH	□	8.2	196	251	9.0	-
20FWHNSB0830-TH	□	8.3	196	251	9.0	-
20FWHNSB0840-TH	□	8.4	196	251	9.0	-
20FWHNSB0850-TH	□	8.5	196	251	9.0	-
20FWHNSB0860-TH	□	8.6	208	263	9.0	-
20FWHNSB0870-TH	□	8.7	208	263	9.0	-
20FWHNSB0880-TH	□	8.8	208	263	9.0	-
20FWHNSB0890-TH	□	8.9	208	263	9.0	-
20FWHNSB0900-TH	●	9.0	208	263	9.0	55,540
20FWHNSB0910-TH	□	9.1	219	274	10.0	-
20FWHNSB0920-TH	□	9.2	219	274	10.0	-
20FWHNSB0930-TH	□	9.3	219	274	10.0	-
20FWHNSB0940-TH	□	9.4	219	274	10.0	-
20FWHNSB0950-TH	□	9.5	219	274	10.0	-
20FWHNSB0960-TH	□	9.6	231	286	10.0	-
20FWHNSB0970-TH	□	9.7	231	286	10.0	-
20FWHNSB0980-TH	□	9.8	231	286	10.0	-
20FWHNSB0990-TH	□	9.9	231	286	10.0	-
20FWHNSB1000-TH	●	10.0	231	286	10.0	60,480
20FWHNSB1010-TH	□	10.1	243	298	11.0	-
20FWHNSB1020-TH	□	10.2	243	298	11.0	-
20FWHNSB1030-TH	□	10.3	243	298	11.0	-
20FWHNSB1040-TH	□	10.4	243	298	11.0	-
20FWHNSB1050-TH	□	10.5	243	298	11.0	-
20FWHNSB1060-TH	□	10.6	254	315	11.0	-
20FWHNSB1070-TH	□	10.7	254	315	11.0	-
20FWHNSB1080-TH	□	10.8	254	315	11.0	-
20FWHNSB1090-TH	□	10.9	254	315	11.0	-
20FWHNSB1100-TH	●	11.0	254	315	11.0	75,070
20FWHNSB1110-TH	□	11.1	266	327	12.0	-
20FWHNSB1120-TH	□	11.2	266	327	12.0	-
20FWHNSB1130-TH	□	11.3	266	327	12.0	-
20FWHNSB1140-TH	□	11.4	266	327	12.0	-
20FWHNSB1150-TH	□	11.5	266	327	12.0	-
20FWHNSB1160-TH	□	11.6	277	338	12.0	-
20FWHNSB1170-TH	□	11.7	277	338	12.0	-
20FWHNSB1180-TH	□	11.8	277	338	12.0	-
20FWHNSB1190-TH	□	11.9	277	338	12.0	-
20FWHNSB1200-TH	●	12.0	277	338	12.0	82,250

対応被削材 Applicable work materia

軟鋼 Mild steel SS	炭素鋼 Carbon steel S ₀ CC	合金鋼 Alloy steel SCM, SCr	調質鋼 Heat-treated steel SKD SKS	工具鋼 Tool steel ~40HRC	焼入れ鋼 Hardened steel ~45HRC 45HRC~	ステン レス鋼 Stainless steel SUS	耐熱鋼 Ti合金 Heat-resistant steel, Ti alloy Inconel	鑄鉄 Cast iron FC	ダクタイル 鑄鉄 Ductile cast iron FCD	アルミ 合金 Aluminum alloy Al	銅合金 Copper alloy Cu
------------------------	---	-----------------------------------	--	-----------------------------	---	---	---	-----------------------	--	--------------------------------------	------------------------------

再研磨対応外径範囲 Re-grinding compatibility range

商品コード Item code	エンド End (mm)
20FWHNSB-TH	3 ~ 12

Carbide Oil Hole Non Step Borer for Cast Iron (20D)

鑄鉄用 超硬OHノンステップボーラー (30D)



平面二段・S-X形シンニング
Plane, S-X thinning

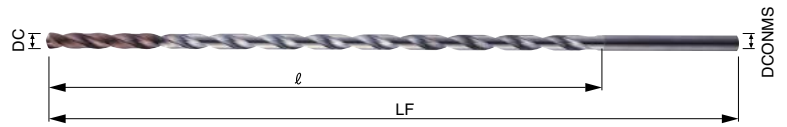

30FWHNSB-TH

商品コード Item code	在庫 Stock	寸法 Size (mm)				希望小売 価格(円) Suggested retail price(¥)
		直径 Tool dia. DC	溝長 Flute length ℓ	全長 Overall length LF	シャンク径 Shank dia. DCONMS	
30FWHNSB0300-TH	●	3.0	99	147	3.0	32,430
30FWHNSB0310-TH	□	3.1	116	164	4.0	-
30FWHNSB0320-TH	□	3.2	116	164	4.0	-
30FWHNSB0330-TH	□	3.3	116	164	4.0	-
30FWHNSB0340-TH	□	3.4	116	164	4.0	-
30FWHNSB0350-TH	□	3.5	116	164	4.0	-
30FWHNSB0360-TH	□	3.6	132	181	4.0	-
30FWHNSB0370-TH	□	3.7	132	181	4.0	-
30FWHNSB0380-TH	□	3.8	132	181	4.0	-
30FWHNSB0390-TH	□	3.9	132	181	4.0	-
30FWHNSB0400-TH	●	4.0	132	181	4.0	40,290
30FWHNSB0410-TH	□	4.1	149	200	5.0	-
30FWHNSB0420-TH	□	4.2	149	200	5.0	-
30FWHNSB0430-TH	□	4.3	149	200	5.0	-
30FWHNSB0440-TH	□	4.4	149	200	5.0	-
30FWHNSB0450-TH	□	4.5	149	200	5.0	-
30FWHNSB0460-TH	□	4.6	166	217	5.0	-
30FWHNSB0470-TH	□	4.7	166	217	5.0	-
30FWHNSB0480-TH	□	4.8	166	217	5.0	-
30FWHNSB0490-TH	□	4.9	166	217	5.0	-
30FWHNSB0500-TH	●	5.0	166	217	5.0	48,930
30FWHNSB0510-TH	□	5.1	182	233	6.0	-
30FWHNSB0520-TH	□	5.2	182	233	6.0	-
30FWHNSB0530-TH	□	5.3	182	233	6.0	-
30FWHNSB0540-TH	□	5.4	182	233	6.0	-
30FWHNSB0550-TH	●	5.5	182	233	6.0	54,540
30FWHNSB0560-TH	□	5.6	199	250	6.0	-
30FWHNSB0570-TH	□	5.7	199	250	6.0	-
30FWHNSB0580-TH	□	5.8	199	250	6.0	-
30FWHNSB0590-TH	□	5.9	199	250	6.0	-
30FWHNSB0600-TH	●	6.0	199	250	6.0	57,120
30FWHNSB0610-TH	□	6.1	215	268	7.0	-
30FWHNSB0620-TH	□	6.2	215	268	7.0	-
30FWHNSB0630-TH	□	6.3	215	268	7.0	-
30FWHNSB0640-TH	□	6.4	215	268	7.0	-
30FWHNSB0650-TH	●	6.5	215	268	7.0	64,860

商品コード Item code	在庫 Stock	寸法 Size (mm)				希望小売 価格(円) Suggested retail price(¥)
		直径 Tool dia. DC	溝長 Flute length ℓ	全長 Overall length LF	シャンク径 Shank dia. DCONMS	
30FWHNSB0660-TH	□	6.6	232	285	7.0	-
30FWHNSB0670-TH	□	6.7	232	285	7.0	-
30FWHNSB0680-TH	□	6.8	232	285	7.0	-
30FWHNSB0690-TH	□	6.9	232	285	7.0	-
30FWHNSB0700-TH	●	7.0	232	285	7.0	66,540
30FWHNSB0710-TH	□	7.1	248	303	8.0	-
30FWHNSB0720-TH	□	7.2	248	303	8.0	-
30FWHNSB0730-TH	□	7.3	248	303	8.0	-
30FWHNSB0740-TH	□	7.4	248	303	8.0	-
30FWHNSB0750-TH	□	7.5	248	303	8.0	-
30FWHNSB0760-TH	□	7.6	265	320	8.0	-
30FWHNSB0770-TH	□	7.7	265	320	8.0	-
30FWHNSB0780-TH	□	7.8	265	320	8.0	-
30FWHNSB0790-TH	□	7.9	265	320	8.0	-
30FWHNSB0800-TH	●	8.0	265	320	8.0	80,680
30FWHNSB0810-TH	□	8.1	281	336	9.0	-
30FWHNSB0820-TH	□	8.2	281	336	9.0	-
30FWHNSB0830-TH	□	8.3	281	336	9.0	-
30FWHNSB0840-TH	□	8.4	281	336	9.0	-
30FWHNSB0850-TH	□	8.5	281	336	9.0	-
30FWHNSB0860-TH	□	8.6	298	353	9.0	-
30FWHNSB0870-TH	□	8.7	298	353	9.0	-
30FWHNSB0880-TH	□	8.8	298	353	9.0	-
30FWHNSB0890-TH	□	8.9	298	353	9.0	-
30FWHNSB0900-TH	●	9.0	298	353	9.0	98,180
30FWHNSB0910-TH	□	9.1	314	369	10.0	-
30FWHNSB0920-TH	□	9.2	314	369	10.0	-
30FWHNSB0930-TH	□	9.3	314	369	10.0	-
30FWHNSB0940-TH	□	9.4	314	369	10.0	-
30FWHNSB0950-TH	□	9.5	314	369	10.0	-
30FWHNSB0960-TH	□	9.6	331	386	10.0	-
30FWHNSB0970-TH	□	9.7	331	386	10.0	-
30FWHNSB0980-TH	□	9.8	331	386	10.0	-
30FWHNSB0990-TH	□	9.9	331	386	10.0	-
30FWHNSB1000-TH	●	10.0	331	386	10.0	118,940

10~30FWHNSB直径公差表 Table of Tolerance on tool dia.

① □印：特定代理店在庫の10~30FWHNSB直径公差 □：Tool diameter tolerance of 10 to 30FWHNSB for stock of specified distributor (mm)

	DC ≤ 3.0	3.0 < DC ≤ 6.0	6.0 < DC ≤ 10.0	10.0 < DC ≤ 14.0
上限 Max	-0.015	-0.020	-0.024	-0.030
下限 Min	-0.028	-0.036	-0.045	-0.053

② ●：標準在庫品の10~30FWHNSB直径公差はh8 ●：Tool dia. tolerance of stoked items 10 to 30 FWHNSB is h8.

対応被削材 Applicable work materia

軟鋼 Mild steel SS	炭素鋼 Carbon steel S/OC	合金鋼 Alloy steel SCM, SCr	調質鋼 Heat-treated steel SKD SKS	工具鋼 Tool steel ~40HRC	焼入れ鋼 Hardened steel ~45HRC 45HRC~	ステン レス鋼 Stainless steel SUS	耐熱鋼 Ti合金 Heat-resistant steel, Ti alloy Inconel	鑄鉄 Cast iron FC	ダクタイル 鑄鉄 Ductile cast iron FCD	アルミ 合金 Aluminum alloy Al	銅合金 Copper alloy Cu
								◎	◎		

再研磨対応外径範囲 Re-grinding compatibility range

商品コード Item code	エンド End (mm)
30FWHNSB-TH	3 ~ 10

●印：標準在庫品です。●：Stocked items. □印：特定代理店在庫です。弊社営業へお問い合わせください。□：Stocked by specified distributor. Contact with our sales department.

Carbide Oil Hole Non Step Borer for Cast Iron 鑄鉄用 超硬OHノンステップボーラー

標準切削条件表 Recommended cutting conditions

03FWHNSB-TH 05FWHNSB-TH

10FWHNSB-TH 15FWHNSB-TH 20FWHNSB-TH 30FWHNSB-TH

被削材 Work material	ダクタイル鑄鉄 Ductile irons FCD700				ダクタイル鑄鉄 Ductile irons FCD500				鑄鉄 Cast irons FC			
	内部クーラント Internal coolant		MQL (ミスト) MQL (mist)		内部クーラント Internal coolant		MQL (ミスト) MQL (mist)		内部クーラント Internal coolant		MQL (ミスト) MQL (mist)	
切削速度 V_c Cutting speed (m/min)	70~100~150		70~100~150		70~100~150		70~100~150		70~100~180		70~100~180	
直径 Tool dia.	回転数 n (min^{-1})	送り量 f (mm/rev)	回転数 n (min^{-1})	送り量 f (mm/rev)	回転数 n (min^{-1})	送り量 f (mm/rev)	回転数 n (min^{-1})	送り量 f (mm/rev)	回転数 n (min^{-1})	送り量 f (mm/rev)	回転数 n (min^{-1})	送り量 f (mm/rev)
$\Phi 4.0$	8,000	0.1~0.24	8,000	0.1~0.24	8,000	0.1~0.32	8,000	0.1~0.32	8,000	0.1~0.32	8,000	0.1~0.32
$\Phi 6.0$	5,300	0.15~0.36	5,300	0.15~0.36	5,300	0.15~0.48	5,300	0.15~0.48	5,300	0.15~0.48	5,300	0.15~0.48
$\Phi 8.0$	4,000	0.18~0.48	4,000	0.18~0.48	4,000	0.18~0.64	4,000	0.18~0.64	4,000	0.18~0.64	4,000	0.18~0.64
$\Phi 10.0$	3,200	0.2~0.5	3,200	0.2~0.5	3,200	0.2~0.7	3,200	0.2~0.7	3,200	0.2~0.7	3,200	0.2~0.7
$\Phi 12.0$	2,650	0.22~0.54	2,650	0.22~0.54	2,650	0.22~0.78	2,650	0.22~0.78	2,650	0.22~0.78	2,650	0.22~0.78

【切削条件の選定について】 Setting of Cutting Conditions ※下記の加工方法を必ず参照ください。 Be sure to refer to the boring procedure (under) when selecting a tool.

- 被削材、加工形状に合わせて、適切なクーラントを使用してください。
- この標準切削条件表は切削条件の目安を示すものです。実際の加工では加工形状、目的、使用機械等により条件を調整してください。
- この内部クーラント切削条件基準は水溶性切削油剤を使用する場合のもです。又 $\Phi 5.0$ 以下はクーラント圧は2.0MPa以上必要です。
- 工具直径の10~20倍の穴加工の送り量は工具径の7.0%以下を、20~30倍は工具径の6.0%以下を目安にご使用ください。
- MQL(ミスト)加工の場合はミスト装置や工具からの吐出量により切削速度を下げないと加工できない場合があります。
- 工具装着の際は傷や汚れの無いコレットを用い、工具の振れは0.02mm以下に抑えてください。
- 油性の切削油剤を使用する場合は切削速度下限値の70%を目安にご使用ください。
- 条件表よりも低い回転数で使用することもできます。

- Use the appropriate coolant for the work material and machining shape.
- These Recommended Cutting Conditions indicate only the rule of a thumb for the cutting conditions. In actual machining, the condition should be adjusted according to the machining shape, purpose and the machine type.
- These internal coolant cutting conditions are for when using a water-soluble cutting lubricant. Further, for diameters of $\Phi 5.0$ or less, a coolant pressure of at least 2.0MPa is required.
- As general criteria, feed rate should be set to 7.0% of tool diameter or less when machining holes of $10 \times$ to $20 \times$ tool diameter and to 6.0% of tool diameter or less when machining holes of $20 \times$ to $30 \times$ tool diameter.
- When performing MQL (mist) machining, depending on the mist equipment or discharge amount from tool, it may be necessary to reduce feed rate to perform cutting.
- When mounting tool, use a collet without scratches or stains, and suppress tool vibration to 0.02mm or less.
- When using oil-based cutting lubricants, set cutting speed to 70% of cutting speed lower limit as general criteria.
- Rotation speeds of slower than those shown in the condition table can also be used.

切削加工方法 Drilling Method

1 下穴(ガイド穴)加工 (03WHNSB-TH, 05WHNSB-TH) Drilling of pilot hole (guide hole) (03WHNSB-TH, 05WHNSB-TH)

- 穴深さ Hole depth : 工具径 $\times 2$ 倍~5倍 tool diameter $\times 2\sim 5$ times
- 加工穴径 Machining diameter : 10~30FWHNSB工具径の $+0.03\sim +0.10\text{mm}$
10~30FWHNSB diameter + 0.03~0.10mm
- 推奨工具 Recommended tools : 03WHNSB-TH、(超硬スタブ型プラス公差受注生産) 0.3WHNSB-TH, Carbide stub type, MTO by customized allowance

2 低速回転、クーラントON (10~30FWHNSB-TH) Supplying coolant during low-speed revolution (10~30FWHNSB-TH)

- 低速回転でガイド穴へ ($n=0\sim 500\text{min}^{-1}$)
Leading to the guide hole at low speed ($n=0\sim 500\text{min}^{-1}$)
- ガイド穴加工終了面より2.0~5.0mm手前で送りをストップ
Stop feed 2.0~5.0 mm before the end of the guide hole.
※工具刃長が200mm以上の場合は、回転数 $n=200\text{min}^{-1}$ 以下でガイド穴へ
When a long tool (200mm or longer) is used, position the tool to the guide hole at low revolution speed ($n=200\text{min}^{-1}$ or less).

3 切削回転、切削送り (10~30FWHNSB-TH)

- High-speed revolution for drilling feed (10~30FWHNSB-TH)
- 回転数が正規に上がるの確認し切削送り開始
After confirming that the revolution speed is increasing at the specified rate, start feeding.

4 加工終了 Machining completion

- 低速回転にて工具を抜く ($n=0\sim 500\text{min}^{-1}$)
Withdraw the tool at low speed. ($n=0\sim 500\text{min}^{-1}$)
※工具刃長が200mm以上の場合は、回転数 $n=200\text{min}^{-1}$ 以下で抜く
When a long tool (200mm or longer) is used, withdraw the tool at low revolution speed ($n=200\text{min}^{-1}$ or less).

穴あけ工具 ノンステップボーラー

Carbide Oil Hole Non Step Borer for Aluminium (3D)

アルミ用 超硬OHノンステップボーラー(3D)



0~-0.01 (mm)

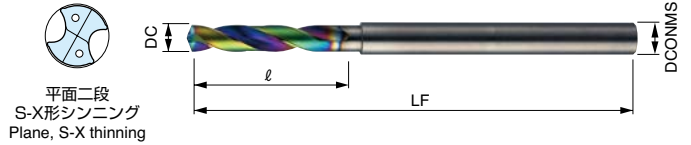

切削条件表 E48
Cutting Conditions

03WHNSB-SD

商品コード Item code	在庫 Stock	寸法 Size (mm)				希望小売 価格(円) Suggested retail price(¥)
		直径 Tool dia. DC	溝長 Flute length ℓ	全長 Overall length LF	シャンク径 Shank dia. DCONMS	
03WHNSB0300-SD	●	3.0	19	69	3.0	15,380
03WHNSB0303-SD	●	3.03	23	73	4.0	15,710
03WHNSB0310-SD	□	3.1	23	73	4.0	-
03WHNSB0320-SD	□	3.2	23	73	4.0	-
03WHNSB0330-SD	□	3.3	23	73	4.0	-
03WHNSB0340-SD	□	3.4	23	73	4.0	-
03WHNSB0350-SD	□	3.5	23	73	4.0	-
03WHNSB0353-SD	□	3.53	23	73	4.0	-
03WHNSB0360-SD	□	3.6	23	73	4.0	-
03WHNSB0370-SD	□	3.7	23	73	4.0	-
03WHNSB0380-SD	□	3.8	23	73	4.0	-
03WHNSB0390-SD	□	3.9	23	73	4.0	-
03WHNSB0400-SD	●	4.0	23	73	4.0	16,050
03WHNSB0403-SD	●	4.03	29	82	5.0	16,390
03WHNSB0410-SD	□	4.1	29	82	5.0	-
03WHNSB0420-SD	□	4.2	29	82	5.0	-
03WHNSB0430-SD	□	4.3	29	82	5.0	-
03WHNSB0440-SD	□	4.4	29	82	5.0	-
03WHNSB0450-SD	□	4.5	29	82	5.0	-
03WHNSB0453-SD	□	4.53	29	82	5.0	-
03WHNSB0460-SD	□	4.6	29	82	5.0	-
03WHNSB0470-SD	□	4.7	29	82	5.0	-
03WHNSB0480-SD	□	4.8	29	82	5.0	-
03WHNSB0490-SD	□	4.9	29	82	5.0	-
03WHNSB0500-SD	●	5.0	29	82	5.0	16,610
03WHNSB0503-SD	●	5.03	29	82	6.0	17,520
03WHNSB0510-SD	●	5.1	29	82	6.0	17,520
03WHNSB0520-SD	□	5.2	29	82	6.0	-
03WHNSB0530-SD	□	5.3	29	82	6.0	-
03WHNSB0540-SD	□	5.4	29	82	6.0	-
03WHNSB0550-SD	●	5.5	29	82	6.0	17,520
03WHNSB0553-SD	●	5.53	29	82	6.0	17,960
03WHNSB0560-SD	□	5.6	29	82	6.0	-
03WHNSB0570-SD	□	5.7	29	82	6.0	-
03WHNSB0580-SD	□	5.8	29	82	6.0	-
03WHNSB0590-SD	□	5.9	29	82	6.0	-
03WHNSB0600-SD	●	6.0	29	82	6.0	17,960
03WHNSB0603-SD	●	6.03	34	89	7.0	19,080
03WHNSB0610-SD	□	6.1	34	89	7.0	-
03WHNSB0620-SD	□	6.2	34	89	7.0	-
03WHNSB0630-SD	□	6.3	34	89	7.0	-
03WHNSB0640-SD	□	6.4	34	89	7.0	-
03WHNSB0650-SD	●	6.5	34	89	7.0	19,080
03WHNSB0653-SD	●	6.53	34	89	7.0	19,530
03WHNSB0660-SD	□	6.6	34	89	7.0	-

商品コード Item code	在庫 Stock	寸法 Size (mm)				希望小売 価格(円) Suggested retail price(¥)
		直径 Tool dia. DC	溝長 Flute length ℓ	全長 Overall length LF	シャンク径 Shank dia. DCONMS	
03WHNSB0670-SD	□	6.7	34	89	7.0	-
03WHNSB0680-SD	●	6.8	34	89	7.0	19,530
03WHNSB0690-SD	□	6.9	34	89	7.0	-
03WHNSB0700-SD	●	7.0	34	89	7.0	19,530
03WHNSB0703-SD	●	7.03	39	95	8.0	21,320
03WHNSB0710-SD	□	7.1	39	95	8.0	-
03WHNSB0720-SD	□	7.2	39	95	8.0	-
03WHNSB0730-SD	●	7.3	39	95	8.0	21,320
03WHNSB0740-SD	□	7.4	39	95	8.0	-
03WHNSB0750-SD	●	7.5	39	95	8.0	21,320
03WHNSB0753-SD	●	7.53	39	95	8.0	21,660
03WHNSB0760-SD	□	7.6	39	95	8.0	-
03WHNSB0770-SD	□	7.7	39	95	8.0	-
03WHNSB0780-SD	□	7.8	39	95	8.0	-
03WHNSB0790-SD	□	7.9	39	95	8.0	-
03WHNSB0800-SD	●	8.0	39	95	8.0	21,660
03WHNSB0803-SD	●	8.03	44	101	9.0	23,130
03WHNSB0810-SD	□	8.1	44	101	9.0	-
03WHNSB0820-SD	□	8.2	44	101	9.0	-
03WHNSB0830-SD	□	8.3	44	101	9.0	-
03WHNSB0840-SD	□	8.4	44	101	9.0	-
03WHNSB0850-SD	●	8.5	44	101	9.0	23,130
03WHNSB0853-SD	●	8.53	44	101	9.0	23,570
03WHNSB0860-SD	●	8.6	44	101	9.0	23,570
03WHNSB0870-SD	□	8.7	44	101	9.0	-
03WHNSB0880-SD	●	8.8	44	101	9.0	23,570
03WHNSB0890-SD	□	8.9	44	101	9.0	-
03WHNSB0900-SD	●	9.0	44	101	9.0	23,570
03WHNSB0903-SD	●	9.03	49	107	10.0	25,140
03WHNSB0910-SD	□	9.1	49	107	10.0	-
03WHNSB0920-SD	□	9.2	49	107	10.0	-
03WHNSB0930-SD	□	9.3	49	107	10.0	-
03WHNSB0940-SD	□	9.4	49	107	10.0	-
03WHNSB0950-SD	●	9.5	49	107	10.0	25,140
03WHNSB0953-SD	●	9.53	49	107	10.0	25,700
03WHNSB0960-SD	□	9.6	49	107	10.0	-
03WHNSB0970-SD	□	9.7	49	107	10.0	-
03WHNSB0980-SD	□	9.8	49	107	10.0	-
03WHNSB0990-SD	□	9.9	49	107	10.0	-
03WHNSB1000-SD	●	10.0	49	107	10.0	25,700
03WHNSB1003-SD	●	10.03	54	117	11.0	27,380

Boring Tools

Non Step Borer

○ 対応被削材 Applicable work materia

軟鋼 Mild steel SS	炭素鋼 Carbon steel S〇〇C	合金鋼 Alloy steel SCM, Scr	調質鋼 Heat-treated steel SKD SKS	工具鋼 Tool steel ~40HRC	焼入れ鋼 Hardened steel ~45HRC 45HRC~	ステン レス鋼 Stainless steel SUS	耐熱鋼 Ti合金 Heat-resistant steel, Ti alloy Inconel	鋳鉄 Cast iron FC	ダクタイル 鋳鉄 Ductile cast iron FCD	アルミ 合金 Aluminum alloy Al	銅合金 Copper alloy Cu
------------------------	--------------------------------	-----------------------------------	--	-----------------------------	---	---	---	-----------------------	--	--------------------------------------	------------------------------

○ 再研磨対応外径範囲 Re-grinding compatibility range

商品コード Item code	エンド End (mm)
03WHNSB-SD	3 ~ 10.03

●印：標準在庫品です。●：Stocked items。□印：特定代理店在庫です。弊社営業へお問い合わせください。□：Stocked by specified distributor. Contact with our sales department.

Carbide Oil Hole Non Step Borer for Aluminium (5D)

アルミ用 超硬OHノンステップボーラー (5D)

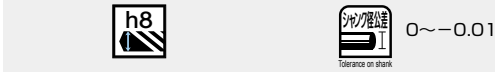

平面二段
S-X形シンニング
Plane, S-X thinning

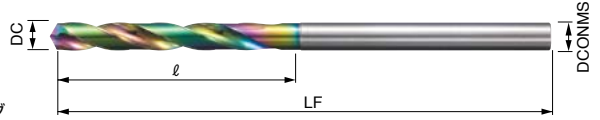

切削条件表 E48
Cutting Conditions

05WHNSB-SD

商品コード Item code	在庫 Stock	寸法 Size (mm)				希望小売 価格(円) Suggested retail price(¥)
		直径 Tool dia. DC	溝長 Flute length ℓ	全長 Overall length LF	シャンク径 Shank dia. DCONMS	
05WHNSB0200-SD	●	2.0	20	66	3.0	17,520
05WHNSB0203-SD	●	2.03	24	74	3.0	17,520
05WHNSB0210-SD	●	2.1	24	74	3.0	17,520
05WHNSB0220-SD	●	2.2	24	74	3.0	17,520
05WHNSB0230-SD	●	2.3	24	74	3.0	17,520
05WHNSB0240-SD	●	2.4	24	74	3.0	17,520
05WHNSB0250-SD	●	2.5	24	74	3.0	17,520
05WHNSB0253-SD	●	2.53	29	79	3.0	17,520
05WHNSB0260-SD	●	2.6	29	79	3.0	17,520
05WHNSB0270-SD	●	2.7	29	79	3.0	17,520
05WHNSB0280-SD	●	2.8	29	79	3.0	17,520
05WHNSB0290-SD	●	2.9	29	79	3.0	17,520
05WHNSB0300-SD	●	3.0	29	79	3.0	17,520
05WHNSB0303-SD	●	3.03	37	87	4.0	18,080
05WHNSB0310-SD	□	3.1	37	87	4.0	-
05WHNSB0320-SD	□	3.2	37	87	4.0	-
05WHNSB0330-SD	□	3.3	37	87	4.0	-
05WHNSB0340-SD	□	3.4	37	87	4.0	-
05WHNSB0350-SD	●	3.5	37	87	4.0	18,080
05WHNSB0353-SD	●	3.53	37	87	4.0	18,190
05WHNSB0360-SD	□	3.6	37	87	4.0	-
05WHNSB0370-SD	□	3.7	37	87	4.0	-
05WHNSB0380-SD	□	3.8	37	87	4.0	-
05WHNSB0390-SD	□	3.9	37	87	4.0	-
05WHNSB0400-SD	●	4.0	37	87	4.0	18,190
05WHNSB0403-SD	●	4.03	47	100	5.0	18,750
05WHNSB0410-SD	●	4.1	47	100	5.0	18,750
05WHNSB0420-SD	●	4.2	47	100	5.0	18,750
05WHNSB0430-SD	●	4.3	47	100	5.0	18,750
05WHNSB0440-SD	□	4.4	47	100	5.0	-
05WHNSB0450-SD	●	4.5	47	100	5.0	18,750
05WHNSB0453-SD	●	4.53	47	100	5.0	19,080
05WHNSB0460-SD	□	4.6	47	100	5.0	-
05WHNSB0470-SD	□	4.7	47	100	5.0	-
05WHNSB0480-SD	□	4.8	47	100	5.0	-
05WHNSB0490-SD	□	4.9	47	100	5.0	-
05WHNSB0500-SD	●	5.0	47	100	5.0	19,080
05WHNSB0503-SD	●	5.03	47	100	6.0	20,200
05WHNSB0510-SD	●	5.1	47	100	6.0	20,200
05WHNSB0520-SD	□	5.2	47	100	6.0	-
05WHNSB0530-SD	□	5.3	47	100	6.0	-
05WHNSB0540-SD	□	5.4	47	100	6.0	-
05WHNSB0550-SD	●	5.5	47	100	6.0	20,200
05WHNSB0553-SD	●	5.53	47	100	6.0	20,430
05WHNSB0560-SD	□	5.6	47	100	6.0	-
05WHNSB0570-SD	□	5.7	47	100	6.0	-
05WHNSB0580-SD	□	5.8	47	100	6.0	-
05WHNSB0590-SD	□	5.9	47	100	6.0	-
05WHNSB0600-SD	●	6.0	47	100	6.0	20,430

商品コード Item code	在庫 Stock	寸法 Size (mm)				希望小売 価格(円) Suggested retail price(¥)
		直径 Tool dia. DC	溝長 Flute length ℓ	全長 Overall length LF	シャンク径 Shank dia. DCONMS	
05WHNSB0603-SD	●	6.03	55	110	7.0	21,770
05WHNSB0610-SD	□	6.1	55	110	7.0	-
05WHNSB0620-SD	□	6.2	55	110	7.0	-
05WHNSB0630-SD	□	6.3	55	110	7.0	-
05WHNSB0640-SD	□	6.4	55	110	7.0	-
05WHNSB0650-SD	●	6.5	55	110	7.0	21,770
05WHNSB0653-SD	●	6.53	55	110	7.0	22,330
05WHNSB0660-SD	□	6.6	55	110	7.0	-
05WHNSB0670-SD	□	6.7	55	110	7.0	-
05WHNSB0680-SD	●	6.8	55	110	7.0	22,330
05WHNSB0690-SD	□	6.9	55	110	7.0	-
05WHNSB0700-SD	●	7.0	55	110	7.0	22,330
05WHNSB0703-SD	●	7.03	63	119	8.0	24,130
05WHNSB0710-SD	□	7.1	63	119	8.0	-
05WHNSB0720-SD	□	7.2	63	119	8.0	-
05WHNSB0730-SD	□	7.3	63	119	8.0	-
05WHNSB0740-SD	□	7.4	63	119	8.0	-
05WHNSB0750-SD	●	7.5	63	119	8.0	24,130
05WHNSB0753-SD	●	7.53	63	119	8.0	24,810
05WHNSB0760-SD	□	7.6	63	119	8.0	-
05WHNSB0770-SD	□	7.7	63	119	8.0	-
05WHNSB0780-SD	●	7.8	63	119	8.0	24,810
05WHNSB0790-SD	□	7.9	63	119	8.0	-
05WHNSB0800-SD	●	8.0	63	119	8.0	24,810
05WHNSB0803-SD	●	8.03	71	128	9.0	26,370
05WHNSB0810-SD	□	8.1	71	128	9.0	-
05WHNSB0820-SD	□	8.2	71	128	9.0	-
05WHNSB0830-SD	□	8.3	71	128	9.0	-
05WHNSB0840-SD	□	8.4	71	128	9.0	-
05WHNSB0850-SD	●	8.5	71	128	9.0	26,370
05WHNSB0853-SD	●	8.53	71	128	9.0	27,050
05WHNSB0860-SD	●	8.6	71	128	9.0	27,050
05WHNSB0870-SD	□	8.7	71	128	9.0	-
05WHNSB0880-SD	●	8.8	71	128	9.0	27,050
05WHNSB0890-SD	□	8.9	71	128	9.0	-
05WHNSB0900-SD	●	9.0	71	128	9.0	27,050
05WHNSB0903-SD	●	9.03	79	137	10.0	28,850
05WHNSB0910-SD	□	9.1	79	137	10.0	-
05WHNSB0920-SD	□	9.2	79	137	10.0	-
05WHNSB0930-SD	□	9.3	79	137	10.0	-
05WHNSB0940-SD	□	9.4	79	137	10.0	-
05WHNSB0950-SD	●	9.5	79	137	10.0	28,850
05WHNSB0953-SD	●	9.53	79	137	10.0	29,180
05WHNSB0960-SD	□	9.6	79	137	10.0	-
05WHNSB0970-SD	□	9.7	79	137	10.0	-
05WHNSB0980-SD	●	9.8	79	137	10.0	29,180
05WHNSB0990-SD	□	9.9	79	137	10.0	-
05WHNSB1000-SD	●	10.0	79	137	10.0	29,180
05WHNSB1003-SD	●	10.03	87	150	11.0	31,200

穴あけ工具
ノンステップボーラー

○ 対応被削材 Applicable work materia

軟鋼 Mild steel SS	炭素鋼 Carbon steel S00C	合金鋼 Alloy steel SCM, SCr	調質鋼 Heat-treated steel SKD SKS	工具鋼 Tool steel ~40HRC	焼入れ鋼 Hardened steel ~45HRC 45HRC~	ステン レス 鋼 Stainless steel SUS	耐熱鋼 Ti合金 Heat-resistant steel, Ti alloy Inconel	鋳鉄 Cast iron FC	ダクタ イル 鋳鉄 Ductile cast iron FCD	アルミ 合金 Aluminum alloy Al	銅合金 Copper alloy Cu
------------------------	--------------------------------	-----------------------------------	--	-----------------------------	---	---	---	-----------------------	--	--------------------------------------	------------------------------

○ 再研磨対応外径範囲 Re-grinding compatibility range

商品コード Item code	エンド End (mm)
05WHNSB-SD	2 ~ 10.03

Carbide Oil Hole Non Step Borer for Aluminium (15~30D)

アルミ用 超硬OHノンステップボーラー (15~30D)



直径公差 Tolerance on dia.	φ3 φ3.5~φ6 φ6.5 φ6.8 φ7~φ8.5 φ8.6 φ9~φ10	0~-0.014 0~-0.018 0~-0.022 -0.024~-0.045 0~-0.022 -0.024~-0.045 0~-0.022	h6
---------------------------	--	--	----

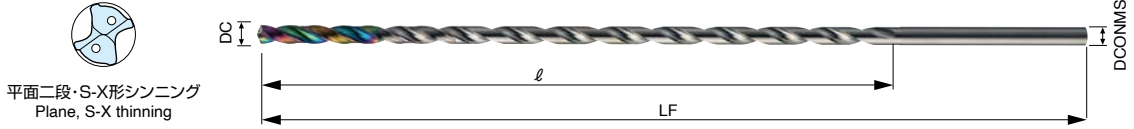

15WHNSB-SD



商品コード Item code	在庫 Stock	寸法 Size (mm)				希望小売 価格(円) Suggested retail price(¥)
		直径 Tool dia. DC	溝長 Flute length ℓ	全長 Overall length LF	シャンク径 Shank dia. DCONMS	
15WHNSB0300-SD	●	3.0	54	102	3.0	30,860
15WHNSB0350-SD	□	3.5	63	111	4.0	-
15WHNSB0400-SD	●	4.0	72	121	4.0	31,650
15WHNSB0450-SD	□	4.5	81	132	5.0	-
15WHNSB0500-SD	●	5.0	91	142	5.0	33,100
15WHNSB0550-SD	●	5.5	100	151	6.0	35,240
15WHNSB0600-SD	●	6.0	109	160	6.0	37,480
15WHNSB0650-SD	□	6.5	118	171	7.0	-
15WHNSB0680-SD	□	6.8	127	180	7.0	-
15WHNSB0700-SD	●	7.0	127	180	7.0	42,980
15WHNSB0750-SD	□	7.5	136	191	8.0	-
15WHNSB0800-SD	●	8.0	145	200	8.0	47,360
15WHNSB0850-SD	□	8.5	154	209	9.0	-
15WHNSB0860-SD	□	8.6	163	218	9.0	-
15WHNSB0900-SD	●	9.0	163	218	9.0	52,630
15WHNSB0950-SD	□	9.5	172	227	10.0	-
15WHNSB1000-SD	●	10.0	181	236	10.0	57,230

20WHNSB-SD



商品コード Item code	在庫 Stock	寸法 Size (mm)				希望小売 価格(円) Suggested retail price(¥)
		直径 Tool dia. DC	溝長 Flute length ℓ	全長 Overall length LF	シャンク径 Shank dia. DCONMS	
20WHNSB0300-SD	●	3.0	69	117	3.0	35,580
20WHNSB0350-SD	□	3.5	81	129	4.0	-
20WHNSB0400-SD	●	4.0	92	141	4.0	36,470
20WHNSB0450-SD	□	4.5	104	155	5.0	-
20WHNSB0500-SD	●	5.0	116	167	5.0	38,150
20WHNSB0550-SD	●	5.5	127	178	6.0	40,630
20WHNSB0600-SD	●	6.0	139	190	6.0	43,090
20WHNSB0650-SD	□	6.5	150	203	7.0	-
20WHNSB0680-SD	□	6.8	162	215	7.0	-
20WHNSB0700-SD	●	7.0	162	215	7.0	49,150
20WHNSB0750-SD	□	7.5	173	228	8.0	-
20WHNSB0800-SD	●	8.0	185	240	8.0	54,650

25WHNSB-SD



商品コード Item code	在庫 Stock	寸法 Size (mm)				希望小売 価格(円) Suggested retail price(¥)
		直径 Tool dia. DC	溝長 Flute length ℓ	全長 Overall length LF	シャンク径 Shank dia. DCONMS	
25WHNSB0300-SD	●	3.0	84	132	3.0	37,260
25WHNSB0350-SD	□	3.5	98	146	4.0	-
25WHNSB0400-SD	●	4.0	113	162	4.0	40,180
25WHNSB0450-SD	□	4.5	127	178	5.0	-
25WHNSB0500-SD	●	5.0	141	192	5.0	41,860
25WHNSB0550-SD	●	5.5	155	206	6.0	44,660
25WHNSB0600-SD	●	6.0	169	220	6.0	47,360
25WHNSB0650-SD	□	6.5	183	236	7.0	-
25WHNSB0680-SD	□	6.8	191	244	7.0	-
25WHNSB0700-SD	●	7.0	197	250	7.0	54,090
25WHNSB0750-SD	□	7.5	211	266	8.0	-
25WHNSB0800-SD	●	8.0	225	280	8.0	60,150

30WHNSB-SD



商品コード Item code	在庫 Stock	寸法 Size (mm)				希望小売 価格(円) Suggested retail price(¥)
		直径 Tool dia. DC	溝長 Flute length ℓ	全長 Overall length LF	シャンク径 Shank dia. DCONMS	
30WHNSB0300-SD	●	3.0	99	147	3.0	38,940
30WHNSB0350-SD	□	3.5	116	164	4.0	-
30WHNSB0400-SD	●	4.0	132	181	4.0	48,370
30WHNSB0450-SD	□	4.5	149	200	5.0	-
30WHNSB0500-SD	●	5.0	166	217	5.0	58,690
30WHNSB0550-SD	●	5.5	182	233	6.0	65,420
30WHNSB0600-SD	●	6.0	199	250	6.0	68,570

○ 対応被削材 Applicable work materia

軟鋼 Mild steel SS	炭素鋼 Carbon steel S	合金鋼 Alloy steel SCM, SCr	調質鋼 Heat-treated steel SKD SKS	工具鋼 Tool steel ~40HRC	焼入れ鋼 Hardened steel ~45HRC 45HRC~	ステン レス鋼 Stainless steel SUS	耐熱鋼 Ti合金 Heat-resistant steel, Ti alloy Inconel	鋳鉄 Cast iron FC	ダクタイル 鋳鉄 Ductile cast iron FCD	アルミ 合金 Aluminum alloy Al	銅合金 Copper alloy Cu
------------------------	-----------------------------	-----------------------------------	--	-----------------------------	---	---	---	-----------------------	--	--------------------------------------	------------------------------

○ 再研磨対応外径範囲 Re-grinding compatibility range

商品コード Item code	エンド End (mm)
15WHNSB-SD	3 ~ 10
20WHNSB-SD	3 ~ 8
25WHNSB-SD	3 ~ 8
30WHNSB-SD	3 ~ 6

●印：標準在庫品です。●：Stocked items。□印：特定代理店在庫です。弊社営業へお問い合わせください。□：Stocked by specified distributor. Contact with our sales department.

Carbide Oil Hole Non Step Borer for Aluminium アルミ用 超硬OHノンステップボーラー

標準切削条件表 Recommended cutting conditions

03WHNSB-SD 05WHNSB-SD

15WHNSB-SD 20WHNSB-SD 25WHNSB-SD 30WHNSB-SD

水溶性内部クーラント切削条件 Cutting Conditions (Water base internal coolant)

被削材 Work material	アルミ合金 Aluminium alloy material Mg系 (5052)		アルミ合金 Aluminium alloy material Zn-Mg系 (7075)		アルミ合金鋳物 Cast aluminium alloy material AC \cdot 、ADC		銅合金 Copper alloys	
	切削速度 v_c (m/min)	送り量 f (mm/rev)	切削速度 v_c (m/min)	送り量 f (mm/rev)	切削速度 v_c (m/min)	送り量 f (mm/rev)	切削速度 v_c (m/min)	送り量 f (mm/rev)
$\phi 2.0$	80~180	0.04~0.08	60~150	0.06~0.10	80~160	0.06~0.10	60~150	0.04~0.08
$\phi 4.0$	80~200	0.08~0.16	60~150	0.12~0.20	80~160	0.12~0.20	60~150	0.08~0.16
$\phi 6.0$	80~200	0.12~0.24	80~180	0.18~0.30	80~180	0.18~0.30	80~180	0.12~0.24
$\phi 8.0$	80~200	0.16~0.30	80~180	0.24~0.40	80~180	0.24~0.40	80~180	0.16~0.30
$\phi 10.0$	80~200	0.18~0.35	80~180	0.25~0.50	80~200	0.25~0.50	80~180	0.18~0.35

【切削条件の選定について】 Setting of Cutting Conditions

- *被削材、加工形状に合わせて、適切なクーラントを使用してください。
- *この標準切削条件表は切削条件の目安を示すものです。実際の加工では加工形状、目的、使用機械等により条件を調整してください。
- *この内部クーラント切削条件基準は水溶性切削油剤を使用する場合のものです。又 $\phi 5.0$ 以下はクーラント圧2.0MPa以上が必要です。
- *MQL(ミスト)加工の場合はミスト装置や工具からの吐出量により切削速度を下げないと加工できない場合があります。
- *MQL(ミスト)加工にてA7075を加工する場合はご相談願います。
- *工具装着の際は傷や汚れのないコレットを用い、工具の振れは0.02mm以下に抑えてください。

- Use the appropriate coolant for the work material and machining shape.
- These Recommended Cutting Conditions indicate only the rule of a thumb for the cutting conditions. In actual machining, the condition should be adjusted according to the machining shape, purpose and the machine type.
- Internal coolant cutting condition standards above are when water-soluble cutting lubricant is used. In addition, for $\phi 5.0$ or less, coolant pressure of 2.0MPa or more is required.
- For MQL (mist) machining, depending on the mist equipment and amount discharged by the tool, it may be necessary to reduce cutting speed in order to perform machining.
- For MQL (mist) machining of A7075, please consult us.
- When mounting the tool, use a collet without scratches or stains and suppress tool vibration to 0.02mm or less.

15~30WHNSB-SD加工方法 How to use 15~30WHNSB-SD

1 下穴(ガイド穴)加工 (03~05WHNSB-SD)

Drilling of pilot hole (guide hole) (03~05WHNSB-SD)

- 穴深さ：工具径 $\times 2$ 倍~5倍
Hole depth : tool diameter $\times 2.0$ ~5.0 times

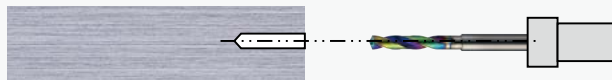

2 低速回転、クーラントON (15~30WHNSB-SD)

Supplying coolant during low-speed revolution (15~30WHNSB-SD)

- 低速回転でガイド穴へ ($n=0\sim 500\text{min}^{-1}$)
Leading to the guide hole at low speed ($n=0\sim 500\text{min}^{-1}$)
- ガイド穴加工終了面より2.0~5.0mm手前で送りをストップ
Stop feed 2.0~5.0 mm before the end of the guide hole.
※工具刃長が200mm以上の場合は、回転数 $n=200\text{min}^{-1}$ 以下でガイド穴へ
When a long tool (200mm or longer) is used, position the tool to the guide hole at low revolution speed ($n=200\text{min}^{-1}$ or less).



3 切削回転、切削送り (15~30WHNSB-SD)

High-speed revolution for drilling feed (15~30WHNSB-SD)

- 回転数が正規に上がるの確認し切削送り開始
After confirming that the revolution speed is increasing at the specified rate, start feeding.



4 加工終了

Machining completion

- 低速回転にて工具を抜く ($n=0\sim 500\text{min}^{-1}$)
Withdraw the tool at low speed. ($n=0\sim 500\text{min}^{-1}$)



穴あけ工具

ノンステップボーラー

Carbide Oil Hole Non Step Borer H for High Hardness Material

高硬度用超硬OHノンステップボーラーH



(mm)

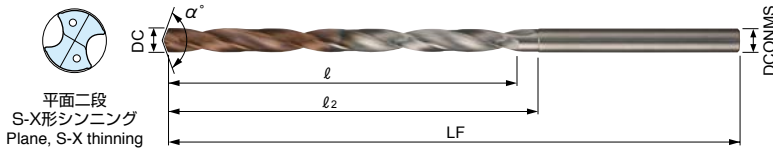

■ NSBH-ATHの直径公差
Tool dia. tolerance -NSBH-ATH (mm)

工具径 Tool dia.	2.0 ≤ DC ≤ 6.0	6.0 < DC ≤ 10.0	10.0 < DC ≤ 12.0
公差 Tolerance	+0.012 0	+0.015 0	+0.015 -0.003

NSBH-ATH

加工深さについては「溝長-DC×2」以下を目安に設定してください。
Cutting depth should be set to "under flute length-2xDC" as a general rule.

切削条件表 E54
Cutting Conditions

商品コード Item code	在庫 Stock	寸法 Size (mm)					先端角 α Point angle	希望小売 価格(円) Suggested retail price (¥)
		直径 Tool dia. DC	溝長 Flute length ℓ	全長 Overall length LF	首下長 Under neck length ℓ ₂	シャンク径 Shank dia. DCONMS		
NSBH0200-10-ATH	●	2.0	10	60	14	4	140	14,480
NSBH0200-20-ATH	●	2.0	20	70	24	4	140	18,410
NSBH0200-40-ATH	●	2.0	40	90	44	4	135	25,590
NSBH0200-60-ATH	●	2.0	60	110	64	4	135	31,310
NSBH0210-10-ATH	●	2.1	10	60	14	4	140	14,480
NSBH0210-20-ATH	□	2.1	20	70	24	4	135	-
NSBH0210-40-ATH	□	2.1	40	90	44	4	135	-
NSBH0210-60-ATH	□	2.1	60	110	64	4	135	-
NSBH0220-10-ATH	●	2.2	10	60	14	4	140	14,480
NSBH0220-20-ATH	□	2.2	20	70	24	4	135	-
NSBH0220-40-ATH	□	2.2	40	90	44	4	135	-
NSBH0220-60-ATH	□	2.2	60	110	64	4	135	-
NSBH0230-10-ATH	●	2.3	10	60	14	4	140	14,480
NSBH0230-20-ATH	□	2.3	20	70	24	4	135	-
NSBH0230-40-ATH	□	2.3	40	90	44	4	135	-
NSBH0230-60-ATH	□	2.3	60	110	64	4	135	-
NSBH0240-10-ATH	●	2.4	10	60	14	4	140	14,480
NSBH0240-20-ATH	□	2.4	20	70	24	4	135	-
NSBH0240-40-ATH	□	2.4	40	90	44	4	135	-
NSBH0240-60-ATH	□	2.4	60	110	64	4	135	-
NSBH0250-10-ATH	●	2.5	10	60	14	4	140	14,480
NSBH0250-20-ATH	●	2.5	20	70	24	4	135	18,410
NSBH0250-40-ATH	□	2.5	40	90	44	4	135	-
NSBH0250-60-ATH	□	2.5	60	110	64	4	135	-
NSBH0260-10-ATH	●	2.6	10	60	14	4	140	14,480
NSBH0260-20-ATH	●	2.6	20	70	24	4	135	18,410
NSBH0260-40-ATH	□	2.6	40	90	44	4	135	-
NSBH0260-60-ATH	□	2.6	60	110	64	4	135	-
NSBH0270-10-ATH	●	2.7	10	60	14	4	140	14,480
NSBH0270-20-ATH	□	2.7	20	70	24	4	135	-
NSBH0270-40-ATH	□	2.7	40	90	44	4	135	-
NSBH0270-60-ATH	□	2.7	60	110	64	4	135	-
NSBH0280-10-ATH	●	2.8	10	60	14	4	140	14,480
NSBH0280-20-ATH	□	2.8	20	70	24	4	135	-
NSBH0280-40-ATH	□	2.8	40	90	44	4	135	-
NSBH0280-60-ATH	□	2.8	60	110	64	4	135	-
NSBH0290-10-ATH	●	2.9	10	60	14	4	140	14,480
NSBH0290-20-ATH	□	2.9	20	70	24	4	135	-
NSBH0290-40-ATH	□	2.9	40	90	44	4	135	-
NSBH0290-60-ATH	□	2.9	60	110	64	4	135	-
NSBH0300-20-ATH	●	3.0	20	70	23	4	140	18,410
NSBH0300-40-ATH	●	3.0	40	90	43	4	135	25,590
NSBH0300-60-ATH	●	3.0	60	110	63	4	135	31,310
NSBH0300-90-ATH	●	3.0	90	140	93	4	135	38,710
NSBH0310-20-ATH	□	3.1	20	70	23	4	140	-
NSBH0310-40-ATH	□	3.1	40	90	43	4	135	-
NSBH0310-60-ATH	□	3.1	60	110	63	4	135	-
NSBH0310-90-ATH	□	3.1	90	140	93	4	135	-
NSBH0320-20-ATH	●	3.2	20	70	23	4	140	16,960
NSBH0320-40-ATH	●	3.2	40	90	43	4	135	24,130
NSBH0320-60-ATH	□	3.2	60	110	63	4	135	-
NSBH0320-90-ATH	□	3.2	90	140	93	4	135	-
NSBH0330-20-ATH	●	3.3	20	70	23	4	140	16,960
NSBH0330-40-ATH	●	3.3	40	90	43	4	135	24,130
NSBH0330-60-ATH	□	3.3	60	110	63	4	135	-
NSBH0330-90-ATH	□	3.3	90	140	93	4	135	-
NSBH0340-20-ATH	●	3.4	20	70	23	4	140	16,960
NSBH0340-40-ATH	●	3.4	40	90	43	4	135	24,130
NSBH0340-60-ATH	□	3.4	60	110	63	4	135	-
NSBH0340-90-ATH	□	3.4	90	140	93	4	135	-

商品コード Item code	在庫 Stock	寸法 Size (mm)					先端角 α Point angle	希望小売 価格(円) Suggested retail price (¥)
		直径 Tool dia. DC	溝長 Flute length ℓ	全長 Overall length LF	首下長 Under neck length ℓ ₂	シャンク径 Shank dia. DCONMS		
NSBH0350-20-ATH	□	3.5	20	70	23	4	140	-
NSBH0350-40-ATH	□	3.5	40	90	43	4	135	-
NSBH0350-60-ATH	□	3.5	60	110	63	4	135	-
NSBH0350-90-ATH	□	3.5	90	140	93	4	135	-
NSBH0360-20-ATH	□	3.6	20	70	23	4	140	-
NSBH0360-40-ATH	□	3.6	40	90	43	4	135	-
NSBH0360-60-ATH	□	3.6	60	110	63	4	135	-
NSBH0360-90-ATH	□	3.6	90	140	93	4	135	-
NSBH0360-120-ATH	□	3.6	120	170	123	4	135	-
NSBH0370-20-ATH	□	3.7	20	70	23	4	140	-
NSBH0370-40-ATH	□	3.7	40	90	43	4	135	-
NSBH0370-60-ATH	□	3.7	60	110	63	4	135	-
NSBH0370-90-ATH	□	3.7	90	140	93	4	135	-
NSBH0370-120-ATH	□	3.7	120	170	123	4	135	-
NSBH0380-20-ATH	□	3.8	20	70	23	4	140	-
NSBH0380-40-ATH	□	3.8	40	90	43	4	135	-
NSBH0380-60-ATH	□	3.8	60	110	63	4	135	-
NSBH0380-90-ATH	□	3.8	90	140	93	4	135	-
NSBH0380-120-ATH	□	3.8	120	170	123	4	135	-
NSBH0390-20-ATH	□	3.9	20	70	23	4	140	-
NSBH0390-40-ATH	□	3.9	40	90	43	4	135	-
NSBH0390-60-ATH	□	3.9	60	110	63	4	135	-
NSBH0390-90-ATH	□	3.9	90	140	93	4	135	-
NSBH0390-120-ATH	□	3.9	120	170	123	4	135	-
NSBH0400-20-ATH	●	4.0	20	70	23	6	140	17,400
NSBH0400-40-ATH	●	4.0	40	90	43	6	135	22,570
NSBH0400-60-ATH	●	4.0	60	110	63	6	135	27,270
NSBH0400-90-ATH	●	4.0	90	140	93	6	135	34,910
NSBH0400-120-ATH	●	4.0	120	170	123	6	135	39,840
NSBH0410-20-ATH	●	4.1	20	70	23	6	140	17,960
NSBH0410-40-ATH	□	4.1	40	90	43	6	135	-
NSBH0410-60-ATH	□	4.1	60	110	63	6	135	-
NSBH0410-90-ATH	□	4.1	90	140	93	6	135	-
NSBH0410-120-ATH	□	4.1	120	170	123	6	135	-
NSBH0420-20-ATH	●	4.2	20	70	23	6	140	17,960
NSBH0420-40-ATH	●	4.2	40	90	43	6	135	21,880
NSBH0420-60-ATH	□	4.2	60	110	63	6	135	-
NSBH0420-90-ATH	□	4.2	90	140	93	6	135	-
NSBH0420-120-ATH	□	4.2	120	170	123	6	135	-
NSBH0430-20-ATH	●	4.3	20	70	23	6	140	17,960
NSBH0430-40-ATH	●	4.3	40	90	43	6	135	21,880
NSBH0430-60-ATH	□	4.3	60	110	63	6	135	-
NSBH0430-90-ATH	□	4.3	90	140	93	6	135	-
NSBH0430-120-ATH	□	4.3	120	170	123	6	135	-
NSBH0440-20-ATH	□	4.4	20	70	23	6	140	-
NSBH0440-40-ATH	□	4.4	40	90	43	6	135	-
NSBH0440-60-ATH	□	4.4	60	110	63	6	135	-
NSBH0440-90-ATH	□	4.4	90	140	93	6	135	-
NSBH0440-120-ATH	□	4.4	120	170	123	6	135	-
NSBH0450-20-ATH	□	4.5	20	70	23	6	140	-
NSBH0450-40-ATH	□	4.5	40	90	43	6	135	-
NSBH0450-60-ATH	□	4.5	60	110	63	6	135	-
NSBH0450-90-ATH	□	4.5	90	140	93	6	135	-
NSBH0450-120-ATH	□	4.5	120	170	123	6	135	-
NSBH0460-20-ATH	□	4.6	20	70	23	6	140	-
NSBH0460-40-ATH	□	4.6	40	90	43	6	135	-
NSBH0460-60-ATH	□	4.6	60	110	63	6	135	-
NSBH0460-90-ATH	□	4.6	90	140	93	6	135	-
NSBH0460-120-ATH	□	4.6	120	170	123	6	135	-
NSBH0460-150-ATH	□	4.6	150	205	153	6	135	-

●印：標準在庫品です。 □印：特定代理店在庫です。弊社営業へお問合わせください。
●：Stocked items. □：Stocked by specified distributor. Contact with our sales department.

Boring Tools

Non Step Borer

高硬度用超硬OHノンステップボーラーH

NSBH○○○○-○○○○-ATH

商品コード Item code	在庫 Stock	寸法 Size (mm)					先端角 α Point angle	希望小売 価格(円) Suggested retail price (¥)
		直径 Tool dia.	溝長 Flute length	全長 Overall length	首下長 Under neck length	シャンク径 Shank dia.		
		DC	ℓ	LF	ℓ ₂	DCONMS		
NSBH0470-20-ATH	<input type="checkbox"/>	20	70	23	6	140	-	
NSBH0470-40-ATH	<input type="checkbox"/>	40	90	43	6	135	-	
NSBH0470-60-ATH	<input type="checkbox"/>	60	110	63	6	135	-	
NSBH0470-90-ATH	<input type="checkbox"/>	90	140	93	6	135	-	
NSBH0470-120-ATH	<input type="checkbox"/>	120	170	123	6	135	-	
NSBH0470-150-ATH	<input type="checkbox"/>	150	205	153	6	135	-	
NSBH0480-20-ATH	<input type="checkbox"/>	20	70	23	6	140	-	
NSBH0480-40-ATH	<input type="checkbox"/>	40	90	43	6	135	-	
NSBH0480-60-ATH	<input type="checkbox"/>	60	110	63	6	135	-	
NSBH0480-90-ATH	<input type="checkbox"/>	90	140	93	6	135	-	
NSBH0480-120-ATH	<input type="checkbox"/>	120	170	123	6	135	-	
NSBH0480-150-ATH	<input type="checkbox"/>	150	205	153	6	135	-	
NSBH0490-20-ATH	<input type="checkbox"/>	20	70	23	6	140	-	
NSBH0490-40-ATH	<input type="checkbox"/>	40	90	43	6	135	-	
NSBH0490-60-ATH	<input type="checkbox"/>	60	110	63	6	135	-	
NSBH0490-90-ATH	<input type="checkbox"/>	90	140	93	6	135	-	
NSBH0490-120-ATH	<input type="checkbox"/>	120	170	123	6	135	-	
NSBH0490-150-ATH	<input type="checkbox"/>	150	205	153	6	135	-	
NSBH0500-25-ATH	<input checked="" type="checkbox"/>	25	80	28	6	140	18,860	
NSBH0500-40-ATH	<input checked="" type="checkbox"/>	40	95	43	6	135	21,210	
NSBH0500-60-ATH	<input checked="" type="checkbox"/>	60	115	63	6	135	25,700	
NSBH0500-90-ATH	<input checked="" type="checkbox"/>	90	145	93	6	135	31,760	
NSBH0500-120-ATH	<input checked="" type="checkbox"/>	120	175	123	6	135	37,150	
NSBH0500-150-ATH	<input checked="" type="checkbox"/>	150	205	153	6	135	41,520	
NSBH0510-30-ATH	<input checked="" type="checkbox"/>	30	85	33	6	140	19,980	
NSBH0510-60-ATH	<input checked="" type="checkbox"/>	60	115	63	6	135	26,150	
NSBH0510-90-ATH	<input type="checkbox"/>	90	145	93	6	135	-	
NSBH0510-120-ATH	<input type="checkbox"/>	120	175	123	6	135	-	
NSBH0510-150-ATH	<input type="checkbox"/>	150	205	153	6	135	-	
NSBH0520-30-ATH	<input type="checkbox"/>	30	85	33	6	140	-	
NSBH0520-60-ATH	<input type="checkbox"/>	60	115	63	6	135	-	
NSBH0520-90-ATH	<input type="checkbox"/>	90	145	93	6	135	-	
NSBH0520-120-ATH	<input type="checkbox"/>	120	175	123	6	135	-	
NSBH0520-150-ATH	<input type="checkbox"/>	150	205	153	6	135	-	
NSBH0530-30-ATH	<input type="checkbox"/>	30	85	33	6	140	-	
NSBH0530-60-ATH	<input type="checkbox"/>	60	115	63	6	135	-	
NSBH0530-90-ATH	<input type="checkbox"/>	90	145	93	6	135	-	
NSBH0530-120-ATH	<input type="checkbox"/>	120	175	123	6	135	-	
NSBH0530-150-ATH	<input type="checkbox"/>	150	205	153	6	135	-	
NSBH0540-30-ATH	<input type="checkbox"/>	30	85	33	6	140	-	
NSBH0540-60-ATH	<input type="checkbox"/>	60	115	63	6	135	-	
NSBH0540-90-ATH	<input type="checkbox"/>	90	145	93	6	135	-	
NSBH0540-120-ATH	<input type="checkbox"/>	120	175	123	6	135	-	
NSBH0540-150-ATH	<input type="checkbox"/>	150	205	153	6	135	-	
NSBH0550-30-ATH	<input type="checkbox"/>	30	85	33	6	140	-	
NSBH0550-60-ATH	<input type="checkbox"/>	60	115	63	6	135	-	
NSBH0550-90-ATH	<input type="checkbox"/>	90	145	93	6	135	-	
NSBH0550-120-ATH	<input type="checkbox"/>	120	175	123	6	135	-	
NSBH0550-150-ATH	<input type="checkbox"/>	150	205	153	6	135	-	
NSBH0560-30-ATH	<input type="checkbox"/>	30	85	33	6	140	-	
NSBH0560-60-ATH	<input type="checkbox"/>	60	115	63	6	135	-	
NSBH0560-90-ATH	<input type="checkbox"/>	90	145	93	6	135	-	
NSBH0560-120-ATH	<input type="checkbox"/>	120	175	123	6	135	-	
NSBH0560-150-ATH	<input type="checkbox"/>	150	205	153	6	135	-	
NSBH0570-30-ATH	<input type="checkbox"/>	30	85	33	6	140	-	
NSBH0570-60-ATH	<input type="checkbox"/>	60	115	63	6	135	-	
NSBH0570-90-ATH	<input type="checkbox"/>	90	145	93	6	135	-	
NSBH0570-120-ATH	<input type="checkbox"/>	120	175	123	6	135	-	
NSBH0570-150-ATH	<input type="checkbox"/>	150	205	153	6	135	-	

商品コード Item code	在庫 Stock	寸法 Size (mm)					先端角 α Point angle	希望小売 価格(円) Suggested retail price (¥)
		直径 Tool dia.	溝長 Flute length	全長 Overall length	首下長 Under neck length	シャンク径 Shank dia.		
		DC	ℓ	LF	ℓ ₂	DCONMS		
NSBH0580-30-ATH	<input type="checkbox"/>	30	85	33	6	140	-	
NSBH0580-60-ATH	<input type="checkbox"/>	60	115	63	6	135	-	
NSBH0580-90-ATH	<input type="checkbox"/>	90	145	93	6	135	-	
NSBH0580-120-ATH	<input type="checkbox"/>	120	175	123	6	135	-	
NSBH0580-150-ATH	<input type="checkbox"/>	150	205	153	6	135	-	
NSBH0590-30-ATH	<input type="checkbox"/>	30	85	33	6	140	-	
NSBH0590-60-ATH	<input type="checkbox"/>	60	115	63	6	135	-	
NSBH0590-90-ATH	<input type="checkbox"/>	90	145	93	6	135	-	
NSBH0590-120-ATH	<input type="checkbox"/>	120	175	123	6	135	-	
NSBH0590-150-ATH	<input type="checkbox"/>	150	205	153	6	135	-	
NSBH0600-30-ATH	<input checked="" type="checkbox"/>	30	85	33	8	140	21,100	
NSBH0600-60-ATH	<input checked="" type="checkbox"/>	60	115	63	8	135	25,700	
NSBH0600-90-ATH	<input checked="" type="checkbox"/>	90	145	93	8	135	32,320	
NSBH0600-120-ATH	<input checked="" type="checkbox"/>	120	175	123	8	135	38,040	
NSBH0600-150-ATH	<input checked="" type="checkbox"/>	150	205	153	8	135	42,980	
NSBH0610-30-ATH	<input type="checkbox"/>	30	85	33	8	140	-	
NSBH0610-60-ATH	<input type="checkbox"/>	60	115	63	8	135	-	
NSBH0610-90-ATH	<input type="checkbox"/>	90	145	93	8	135	-	
NSBH0610-120-ATH	<input type="checkbox"/>	120	175	123	8	135	-	
NSBH0610-150-ATH	<input type="checkbox"/>	150	205	153	8	135	-	
NSBH0620-30-ATH	<input type="checkbox"/>	30	85	33	8	140	-	
NSBH0620-60-ATH	<input type="checkbox"/>	60	115	63	8	135	-	
NSBH0620-90-ATH	<input type="checkbox"/>	90	145	93	8	135	-	
NSBH0620-120-ATH	<input type="checkbox"/>	120	175	123	8	135	-	
NSBH0620-150-ATH	<input type="checkbox"/>	150	205	153	8	135	-	
NSBH0630-30-ATH	<input type="checkbox"/>	30	85	33	8	140	-	
NSBH0630-60-ATH	<input type="checkbox"/>	60	115	63	8	135	-	
NSBH0630-90-ATH	<input type="checkbox"/>	90	145	93	8	135	-	
NSBH0630-120-ATH	<input type="checkbox"/>	120	175	123	8	135	-	
NSBH0630-150-ATH	<input type="checkbox"/>	150	205	153	8	135	-	
NSBH0640-30-ATH	<input type="checkbox"/>	30	85	33	8	140	-	
NSBH0640-60-ATH	<input type="checkbox"/>	60	115	63	8	135	-	
NSBH0640-90-ATH	<input type="checkbox"/>	90	145	93	8	135	-	
NSBH0640-120-ATH	<input type="checkbox"/>	120	175	123	8	135	-	
NSBH0640-150-ATH	<input type="checkbox"/>	150	205	153	8	135	-	
NSBH0650-30-ATH	<input type="checkbox"/>	30	85	33	8	140	-	
NSBH0650-60-ATH	<input type="checkbox"/>	60	115	63	8	135	-	
NSBH0650-90-ATH	<input type="checkbox"/>	90	145	93	8	135	-	
NSBH0650-120-ATH	<input type="checkbox"/>	120	175	123	8	135	-	
NSBH0650-150-ATH	<input type="checkbox"/>	150	205	153	8	135	-	
NSBH0660-30-ATH	<input type="checkbox"/>	30	85	33	8	140	-	
NSBH0660-60-ATH	<input type="checkbox"/>	60	115	63	8	135	-	
NSBH0660-90-ATH	<input type="checkbox"/>	90	145	93	8	135	-	
NSBH0660-120-ATH	<input type="checkbox"/>	120	175	123	8	135	-	
NSBH0660-150-ATH	<input type="checkbox"/>	150	205	153	8	135	-	
NSBH0660-200-ATH	<input type="checkbox"/>	200	255	203	8	135	-	
NSBH0670-30-ATH	<input type="checkbox"/>	30	85	33	8	140	-	
NSBH0670-60-ATH	<input type="checkbox"/>	60	115	63	8	135	-	
NSBH0670-90-ATH	<input type="checkbox"/>	90	145	93	8	135	-	
NSBH0670-120-ATH	<input type="checkbox"/>	120	175	123	8	135	-	
NSBH0670-150-ATH	<input type="checkbox"/>	150	205	153	8	135	-	
NSBH0670-200-ATH	<input type="checkbox"/>	200	255	203	8	135	-	
NSBH0680-30-ATH	<input checked="" type="checkbox"/>	30	85	33	8	140	23,350	
NSBH0680-60-ATH	<input checked="" type="checkbox"/>	60	115	63	8	135	27,490	
NSBH0680-90-ATH	<input type="checkbox"/>	90	145	93	8	135	-	
NSBH0680-120-ATH	<input type="checkbox"/>	120	175	123	8	135	-	
NSBH0680-150-ATH	<input type="checkbox"/>	150	205	153	8	135	-	
NSBH0680-200-ATH	<input type="checkbox"/>	200	255	203	8	135	-	

●印：標準在庫品です。 □印：特定代理店在庫です。弊社営業へお問合わせください。
●：Stocked items. □：Stocked by specified distributor. Contact with our sales department.

穴あけ工具
ノンステップボーラー

NSBH○○○○-○○○○-ATH

商品コード Item code	在庫 Stock	寸法 Size (mm)					先端角 α Point angle	希望小売 価格(円) Suggested retail price (¥)
		直径 Tool dia.	溝長 Flute length	全長 Overall length	首下長 Under neck length	シャンク径 Shank dia.		
		DC	ℓ	LF	ℓ ₂	DCONMS		
NSBH0690-30-ATH	●		30	85	33	8	140	23,350
NSBH0690-60-ATH	●		60	115	63	8	135	27,490
NSBH0690-90-ATH	□		90	145	93	8	135	-
NSBH0690-120-ATH	□	6.9	120	175	123	8	135	-
NSBH0690-150-ATH	□		150	205	153	8	135	-
NSBH0690-200-ATH	□		200	255	203	8	135	-
NSBH0700-35-ATH	●		35	90	38	8	140	23,350
NSBH0700-60-ATH	●		60	115	63	8	135	27,490
NSBH0700-90-ATH	●	7.0	90	145	93	8	135	32,990
NSBH0700-120-ATH	●		120	175	123	8	135	39,620
NSBH0700-150-ATH	●		150	205	153	8	135	44,210
NSBH0700-200-ATH	●		200	255	203	8	135	50,840
NSBH0710-35-ATH	□		35	90	38	8	140	-
NSBH0710-60-ATH	□		60	115	63	8	135	-
NSBH0710-90-ATH	□	7.1	90	145	93	8	135	-
NSBH0710-120-ATH	□		120	175	123	8	135	-
NSBH0710-150-ATH	□		150	205	153	8	135	-
NSBH0710-200-ATH	□		200	255	203	8	135	-
NSBH0720-35-ATH	□		35	90	38	8	140	-
NSBH0720-60-ATH	□		60	115	63	8	135	-
NSBH0720-90-ATH	□	7.2	90	145	93	8	135	-
NSBH0720-120-ATH	□		120	175	123	8	135	-
NSBH0720-150-ATH	□		150	205	153	8	135	-
NSBH0720-200-ATH	□		200	255	203	8	135	-
NSBH0730-35-ATH	□		35	90	38	8	140	-
NSBH0730-60-ATH	□		60	115	63	8	135	-
NSBH0730-90-ATH	□	7.3	90	145	93	8	135	-
NSBH0730-120-ATH	□		120	175	123	8	135	-
NSBH0730-150-ATH	□		150	205	153	8	135	-
NSBH0730-200-ATH	□		200	255	203	8	135	-
NSBH0740-35-ATH	□		35	90	38	8	140	-
NSBH0740-60-ATH	□		60	115	63	8	135	-
NSBH0740-90-ATH	□	7.4	90	145	93	8	135	-
NSBH0740-120-ATH	□		120	175	123	8	135	-
NSBH0740-150-ATH	□		150	205	153	8	135	-
NSBH0740-200-ATH	□		200	255	203	8	135	-
NSBH0750-35-ATH	□		35	90	38	8	140	-
NSBH0750-60-ATH	□		60	115	63	8	135	-
NSBH0750-90-ATH	□	7.5	90	145	93	8	135	-
NSBH0750-120-ATH	□		120	175	123	8	135	-
NSBH0750-150-ATH	□		150	205	153	8	135	-
NSBH0750-200-ATH	□		200	255	203	8	135	-
NSBH0760-35-ATH	□		35	90	38	8	140	-
NSBH0760-60-ATH	□		60	115	63	8	135	-
NSBH0760-90-ATH	□	7.6	90	145	93	8	135	-
NSBH0760-120-ATH	□		120	175	123	8	135	-
NSBH0760-150-ATH	□		150	205	153	8	135	-
NSBH0760-200-ATH	□		200	255	203	8	135	-
NSBH0760-250-ATH	□		250	305	253	8	135	-
NSBH0770-35-ATH	□		35	90	38	8	140	-
NSBH0770-60-ATH	□		60	115	63	8	135	-
NSBH0770-90-ATH	□	7.7	90	145	93	8	135	-
NSBH0770-120-ATH	□		120	175	123	8	135	-
NSBH0770-150-ATH	□		150	205	153	8	135	-
NSBH0770-200-ATH	□		200	255	203	8	135	-
NSBH0770-250-ATH	□		250	305	253	8	135	-
NSBH0780-35-ATH	□		35	90	38	8	140	-
NSBH0780-60-ATH	□	7.8	60	115	63	8	135	-
NSBH0780-90-ATH	□		90	145	93	8	135	-
NSBH0780-120-ATH	□		120	175	123	8	135	-

商品コード Item code	在庫 Stock	寸法 Size (mm)					先端角 α Point angle	希望小売 価格(円) Suggested retail price (¥)
		直径 Tool dia.	溝長 Flute length	全長 Overall length	首下長 Under neck length	シャンク径 Shank dia.		
		DC	ℓ	LF	ℓ ₂	DCONMS		
NSBH0780-150-ATH	□		150	205	153	8	135	-
NSBH0780-200-ATH	□	7.8	200	255	203	8	135	-
NSBH0780-250-ATH	□		250	305	253	8	135	-
NSBH0790-35-ATH	□		35	90	38	8	140	-
NSBH0790-60-ATH	□		60	115	63	8	135	-
NSBH0790-90-ATH	□	7.9	90	145	93	8	135	-
NSBH0790-120-ATH	□		120	175	123	8	135	-
NSBH0790-150-ATH	□		150	205	153	8	135	-
NSBH0790-200-ATH	□		200	255	203	8	135	-
NSBH0790-250-ATH	□		250	305	253	8	135	-
NSBH0800-40-ATH	●		40	95	43	10	140	25,810
NSBH0800-60-ATH	●	8.0	60	115	63	10	135	29,180
NSBH0800-90-ATH	●		90	145	93	10	135	34,570
NSBH0800-120-ATH	●		120	175	123	10	135	39,400
NSBH0800-150-ATH	●		150	205	153	10	135	45,010
NSBH0800-200-ATH	●		200	255	203	10	135	52,300
NSBH0800-250-ATH	●		250	305	253	10	135	59,470
NSBH0810-45-ATH	□		45	105	48	10	140	-
NSBH0810-90-ATH	□	8.1	90	150	93	10	135	-
NSBH0810-120-ATH	□		120	180	123	10	135	-
NSBH0810-150-ATH	□		150	210	153	10	135	-
NSBH0810-200-ATH	□		200	260	203	10	135	-
NSBH0810-250-ATH	□		250	310	253	10	135	-
NSBH0820-45-ATH	□		45	105	48	10	140	-
NSBH0820-90-ATH	□	8.2	90	150	93	10	135	-
NSBH0820-120-ATH	□		120	180	123	10	135	-
NSBH0820-150-ATH	□		150	210	153	10	135	-
NSBH0820-200-ATH	□		200	260	203	10	135	-
NSBH0820-250-ATH	□		250	310	253	10	135	-
NSBH0830-45-ATH	□		45	105	48	10	140	-
NSBH0830-90-ATH	□	8.3	90	150	93	10	135	-
NSBH0830-120-ATH	□		120	180	123	10	135	-
NSBH0830-150-ATH	□		150	210	153	10	135	-
NSBH0830-200-ATH	□		200	260	203	10	135	-
NSBH0830-250-ATH	□		250	310	253	10	135	-
NSBH0840-45-ATH	□		45	105	48	10	140	-
NSBH0840-90-ATH	□	8.4	90	150	93	10	135	-
NSBH0840-120-ATH	□		120	180	123	10	135	-
NSBH0840-150-ATH	□		150	210	153	10	135	-
NSBH0840-200-ATH	□		200	260	203	10	135	-
NSBH0840-250-ATH	□		250	310	253	10	135	-
NSBH0850-45-ATH	●		45	105	48	10	140	27,270
NSBH0850-90-ATH	●	8.5	90	150	93	10	135	35,130
NSBH0850-120-ATH	●		120	180	123	10	135	41,300
NSBH0850-150-ATH	●		150	210	153	10	135	45,900
NSBH0850-200-ATH	●		200	260	203	10	135	53,860
NSBH0850-250-ATH	●		250	310	253	10	135	60,150
NSBH0860-45-ATH	●		45	105	48	10	140	28,740
NSBH0860-90-ATH	□	8.6	90	150	93	10	135	-
NSBH0860-120-ATH	□		120	180	123	10	135	-
NSBH0860-150-ATH	□		150	210	153	10	135	-
NSBH0860-200-ATH	□		200	260	203	10	135	-
NSBH0860-250-ATH	□		250	310	253	10	135	-
NSBH0870-45-ATH	●		45	105	48	10	140	28,740
NSBH0870-90-ATH	□	8.7	90	150	93	10	135	-
NSBH0870-120-ATH	□		120	180	123	10	135	-
NSBH0870-150-ATH	□		150	210	153	10	135	-
NSBH0870-200-ATH	□		200	260	203	10	135	-
NSBH0870-250-ATH	□		250	310	253	10	135	-

Boring Tools
Non Step Borer

高硬度用超硬OHノンステップボーラーH

NSBH○○○○-○○○-ATH

商品コード Item code	在庫 Stock	寸法 Size (mm)					先端角 α Point angle	希望小売 価格 (円) Suggested retail price (¥)
		直径 Tool dia.	溝長 Flute length	全長 Overall length	首下長 Under neck length	シャンク径 Shank dia.		
		DC	ℓ	LF	ℓ ₂	DCONMS		
NSBH0880-45-ATH	●	8.8	45	105	48	10	140	28,740
NSBH0880-90-ATH	□	8.8	90	150	93	10	135	-
NSBH0880-120-ATH	□	8.8	120	180	123	10	135	-
NSBH0880-150-ATH	□	8.8	150	210	153	10	135	-
NSBH0880-200-ATH	□	8.8	200	260	203	10	135	-
NSBH0880-250-ATH	□	8.8	250	310	253	10	135	-
NSBH0890-45-ATH	●	8.9	45	105	48	10	140	28,740
NSBH0890-90-ATH	□	8.9	90	150	93	10	135	-
NSBH0890-120-ATH	□	8.9	120	180	123	10	135	-
NSBH0890-150-ATH	□	8.9	150	210	153	10	135	-
NSBH0890-200-ATH	□	8.9	200	260	203	10	135	-
NSBH0890-250-ATH	□	8.9	250	310	253	10	135	-
NSBH0900-45-ATH	●	9.0	45	105	48	10	140	28,740
NSBH0900-90-ATH	●	9.0	90	150	93	10	135	34,680
NSBH0900-120-ATH	●	9.0	120	180	123	10	135	41,970
NSBH0900-150-ATH	●	9.0	150	210	153	10	135	47,020
NSBH0900-200-ATH	●	9.0	200	260	203	10	135	55,880
NSBH0900-250-ATH	●	9.0	250	310	253	10	135	61,490
NSBH0910-50-ATH	□	9.1	50	110	53	10	140	-
NSBH0910-90-ATH	□	9.1	90	150	93	10	135	-
NSBH0910-120-ATH	□	9.1	120	180	123	10	135	-
NSBH0910-150-ATH	□	9.1	150	210	153	10	135	-
NSBH0910-200-ATH	□	9.1	200	260	203	10	135	-
NSBH0910-250-ATH	□	9.1	250	310	253	10	135	-
NSBH0910-300-ATH	□	9.1	300	360	303	10	135	-
NSBH0920-50-ATH	□	9.2	50	110	53	10	140	-
NSBH0920-90-ATH	□	9.2	90	150	93	10	135	-
NSBH0920-120-ATH	□	9.2	120	180	123	10	135	-
NSBH0920-150-ATH	□	9.2	150	210	153	10	135	-
NSBH0920-200-ATH	□	9.2	200	260	203	10	135	-
NSBH0920-250-ATH	□	9.2	250	310	253	10	135	-
NSBH0920-300-ATH	□	9.2	300	360	303	10	135	-
NSBH0930-50-ATH	□	9.3	50	110	53	10	140	-
NSBH0930-90-ATH	□	9.3	90	150	93	10	135	-
NSBH0930-120-ATH	□	9.3	120	180	123	10	135	-
NSBH0930-150-ATH	□	9.3	150	210	153	10	135	-
NSBH0930-200-ATH	□	9.3	200	260	203	10	135	-
NSBH0930-250-ATH	□	9.3	250	310	253	10	135	-
NSBH0930-300-ATH	□	9.3	300	360	303	10	135	-
NSBH0940-50-ATH	□	9.4	50	110	53	10	140	-
NSBH0940-90-ATH	□	9.4	90	150	93	10	135	-
NSBH0940-120-ATH	□	9.4	120	180	123	10	135	-
NSBH0940-150-ATH	□	9.4	150	210	153	10	135	-
NSBH0940-200-ATH	□	9.4	200	260	203	10	135	-
NSBH0940-250-ATH	□	9.4	250	310	253	10	135	-
NSBH0940-300-ATH	□	9.4	300	360	303	10	135	-
NSBH0950-50-ATH	□	9.5	50	110	53	10	140	-
NSBH0950-90-ATH	□	9.5	90	150	93	10	135	-
NSBH0950-120-ATH	□	9.5	120	180	123	10	135	-
NSBH0950-150-ATH	□	9.5	150	210	153	10	135	-
NSBH0950-200-ATH	□	9.5	200	260	203	10	135	-
NSBH0950-250-ATH	□	9.5	250	310	253	10	135	-
NSBH0950-300-ATH	□	9.5	300	360	303	10	135	-
NSBH0960-50-ATH	□	9.6	50	110	53	10	140	-
NSBH0960-90-ATH	□	9.6	90	150	93	10	135	-
NSBH0960-120-ATH	□	9.6	120	180	123	10	135	-
NSBH0960-150-ATH	□	9.6	150	210	153	10	135	-
NSBH0960-200-ATH	□	9.6	200	260	203	10	135	-
NSBH0960-250-ATH	□	9.6	250	310	253	10	135	-
NSBH0960-300-ATH	□	9.6	300	360	303	10	135	-

商品コード Item code	在庫 Stock	寸法 Size (mm)					先端角 α Point angle	希望小売 価格 (円) Suggested retail price (¥)
		直径 Tool dia.	溝長 Flute length	全長 Overall length	首下長 Under neck length	シャンク径 Shank dia.		
		DC	ℓ	LF	ℓ ₂	DCONMS		
NSBH0970-50-ATH	□	9.7	50	110	53	10	140	-
NSBH0970-90-ATH	□	9.7	90	150	93	10	135	-
NSBH0970-120-ATH	□	9.7	120	180	123	10	135	-
NSBH0970-150-ATH	□	9.7	150	210	153	10	135	-
NSBH0970-200-ATH	□	9.7	200	260	203	10	135	-
NSBH0970-250-ATH	□	9.7	250	310	253	10	135	-
NSBH0970-300-ATH	□	9.7	300	360	303	10	135	-
NSBH0980-50-ATH	□	9.8	50	110	53	10	140	-
NSBH0980-90-ATH	□	9.8	90	150	93	10	135	-
NSBH0980-120-ATH	□	9.8	120	180	123	10	135	-
NSBH0980-150-ATH	□	9.8	150	210	153	10	135	-
NSBH0980-200-ATH	□	9.8	200	260	203	10	135	-
NSBH0980-250-ATH	□	9.8	250	310	253	10	135	-
NSBH0980-300-ATH	□	9.8	300	360	303	10	135	-
NSBH0990-50-ATH	□	9.9	50	110	53	10	140	-
NSBH0990-90-ATH	□	9.9	90	150	93	10	135	-
NSBH0990-120-ATH	□	9.9	120	180	123	10	135	-
NSBH0990-150-ATH	□	9.9	150	210	153	10	135	-
NSBH0990-200-ATH	□	9.9	200	260	203	10	135	-
NSBH0990-250-ATH	□	9.9	250	310	253	10	135	-
NSBH0990-300-ATH	□	9.9	300	360	303	10	135	-
NSBH1000-50-ATH	●	10.0	50	110	53	12	140	31,200
NSBH1000-90-ATH	●	10.0	90	150	93	12	135	36,590
NSBH1000-120-ATH	●	10.0	120	180	123	12	135	41,970
NSBH1000-150-ATH	●	10.0	150	210	153	12	135	47,470
NSBH1000-200-ATH	●	10.0	200	260	203	12	135	55,990
NSBH1000-250-ATH	●	10.0	250	310	253	12	135	63,290
NSBH1000-300-ATH	●	10.0	300	360	303	12	135	69,460
NSBH1010-50-ATH	□	10.1	50	110	53	12	140	-
NSBH1010-90-ATH	□	10.1	90	150	93	12	135	-
NSBH1010-120-ATH	□	10.1	120	180	123	12	135	-
NSBH1010-150-ATH	□	10.1	150	210	153	12	135	-
NSBH1010-200-ATH	□	10.1	200	260	203	12	135	-
NSBH1010-250-ATH	□	10.1	250	310	253	12	135	-
NSBH1010-300-ATH	□	10.1	300	360	303	12	135	-
NSBH1020-50-ATH	□	10.2	50	110	53	12	140	-
NSBH1020-90-ATH	□	10.2	90	150	93	12	135	-
NSBH1020-120-ATH	□	10.2	120	180	123	12	135	-
NSBH1020-150-ATH	□	10.2	150	210	153	12	135	-
NSBH1020-200-ATH	□	10.2	200	260	203	12	135	-
NSBH1020-250-ATH	□	10.2	250	310	253	12	135	-
NSBH1020-300-ATH	□	10.2	300	360	303	12	135	-
NSBH1030-50-ATH	●	10.3	50	110	53	12	140	32,540
NSBH1030-90-ATH	□	10.3	90	150	93	12	135	-
NSBH1030-120-ATH	□	10.3	120	180	123	12	135	-
NSBH1030-150-ATH	□	10.3	150	210	153	12	135	-
NSBH1030-200-ATH	□	10.3	200	260	203	12	135	-
NSBH1030-250-ATH	□	10.3	250	310	253	12	135	-
NSBH1030-300-ATH	□	10.3	300	360	303	12	135	-
NSBH1040-50-ATH	●	10.4	50	110	53	12	140	32,540
NSBH1040-90-ATH	□	10.4	90	150	93	12	135	-
NSBH1040-120-ATH	□	10.4	120	180	123	12	135	-
NSBH1040-150-ATH	□	10.4	150	210	153	12	135	-
NSBH1040-200-ATH	□	10.4	200	260	203	12	135	-
NSBH1040-250-ATH	□	10.4	250	310	253	12	135	-
NSBH1040-300-ATH	□	10.4	300	360	303	12	135	-
NSBH1050-50-ATH	●	10.5	50	110	53	12	140	32,540
NSBH1050-90-ATH	□	10.5	90	150	93	12	135	-
NSBH1050-120-ATH	□	10.5	120	180	123	12	135	-
NSBH1050-150-ATH	□	10.5	150	210	153	12	135	-

●印：標準在庫品です。●：Stocked items。□印：特定代理店在庫です。弊社営業へお問い合わせください。□：Stocked by specified distributor. Contact with our sales department.

NSBH○○○○-○○○○-ATH

商品コード Item code	在庫 Stock	寸法 Size (mm)					先端角 α Point angle	希望小売 価格 (円) Suggested retail price (¥)
		直径 Tool dia.	溝長 Flute length	全長 Overall length	首下長 Under neck length	シャンク径 Shank dia.		
		DC	ℓ	LF	ℓ ₂	DCONMS		
NSBH1050-200-ATH	<input type="checkbox"/>	10.5	200	260	203	12	135	-
NSBH1050-250-ATH	<input type="checkbox"/>		250	310	253	12	135	-
NSBH1050-300-ATH	<input type="checkbox"/>		300	360	303	12	135	-
NSBH1060-50-ATH	<input checked="" type="checkbox"/>		50	110	53	12	140	33,660
NSBH1060-90-ATH	<input type="checkbox"/>	10.6	90	150	93	12	135	-
NSBH1060-120-ATH	<input type="checkbox"/>		120	180	123	12	135	-
NSBH1060-150-ATH	<input type="checkbox"/>		150	210	153	12	135	-
NSBH1060-200-ATH	<input type="checkbox"/>		200	260	203	12	135	-
NSBH1060-250-ATH	<input type="checkbox"/>	10.7	250	310	253	12	135	-
NSBH1060-300-ATH	<input type="checkbox"/>		300	360	303	12	135	-
NSBH1070-50-ATH	<input type="checkbox"/>		50	110	53	12	140	-
NSBH1070-90-ATH	<input type="checkbox"/>		90	150	93	12	135	-
NSBH1070-120-ATH	<input type="checkbox"/>	10.8	120	180	123	12	135	-
NSBH1070-150-ATH	<input type="checkbox"/>		150	210	153	12	135	-
NSBH1070-200-ATH	<input type="checkbox"/>		200	260	203	12	135	-
NSBH1070-250-ATH	<input type="checkbox"/>		250	310	253	12	135	-
NSBH1070-300-ATH	<input type="checkbox"/>	10.9	300	360	303	12	135	-
NSBH1080-50-ATH	<input checked="" type="checkbox"/>		50	110	53	12	140	33,660
NSBH1080-90-ATH	<input type="checkbox"/>		90	150	93	12	135	-
NSBH1080-120-ATH	<input type="checkbox"/>		120	180	123	12	135	-
NSBH1080-150-ATH	<input type="checkbox"/>	11.0	150	210	153	12	135	-
NSBH1080-200-ATH	<input type="checkbox"/>		200	260	203	12	135	-
NSBH1080-250-ATH	<input type="checkbox"/>		250	310	253	12	135	-
NSBH1080-300-ATH	<input type="checkbox"/>		300	360	303	12	135	-
NSBH1090-50-ATH	<input checked="" type="checkbox"/>	11.1	50	110	53	12	140	33,660
NSBH1090-90-ATH	<input type="checkbox"/>		90	150	93	12	135	-
NSBH1090-120-ATH	<input type="checkbox"/>		120	180	123	12	135	-
NSBH1090-150-ATH	<input type="checkbox"/>		150	210	153	12	135	-
NSBH1090-200-ATH	<input type="checkbox"/>	11.2	200	260	203	12	135	-
NSBH1090-250-ATH	<input type="checkbox"/>		250	310	253	12	135	-
NSBH1090-300-ATH	<input type="checkbox"/>		300	360	303	12	135	-
NSBH1100-55-ATH	<input checked="" type="checkbox"/>		11.3	55	120	58	12	140
NSBH1100-90-ATH	<input checked="" type="checkbox"/>	90		155	93	12	135	40,740
NSBH1100-120-ATH	<input checked="" type="checkbox"/>	120		185	123	12	135	45,230
NSBH1100-150-ATH	<input checked="" type="checkbox"/>	150		215	153	12	135	50,050
NSBH1100-200-ATH	<input checked="" type="checkbox"/>	11.4	200	265	203	12	135	59,360
NSBH1100-250-ATH	<input checked="" type="checkbox"/>		250	315	253	12	135	66,320
NSBH1100-300-ATH	<input checked="" type="checkbox"/>		300	365	303	12	135	72,930
NSBH1110-55-ATH	<input type="checkbox"/>		11.5	55	120	58	12	140
NSBH1110-90-ATH	<input type="checkbox"/>	90		155	93	12	135	-
NSBH1110-120-ATH	<input type="checkbox"/>	120		185	123	12	135	-
NSBH1110-150-ATH	<input type="checkbox"/>	150		215	153	12	135	-
NSBH1110-200-ATH	<input type="checkbox"/>	11.6	200	265	203	12	135	-
NSBH1110-250-ATH	<input type="checkbox"/>		250	315	253	12	135	-
NSBH1110-300-ATH	<input type="checkbox"/>		300	365	303	12	135	-
NSBH1120-55-ATH	<input type="checkbox"/>		11.7	55	120	58	12	140
NSBH1120-90-ATH	<input type="checkbox"/>	90		155	93	12	135	-
NSBH1120-120-ATH	<input type="checkbox"/>	120		185	123	12	135	-
NSBH1120-150-ATH	<input type="checkbox"/>	150		215	153	12	135	-
NSBH1120-200-ATH	<input type="checkbox"/>	11.8	200	265	203	12	135	-
NSBH1120-250-ATH	<input type="checkbox"/>		250	315	253	12	135	-
NSBH1120-300-ATH	<input type="checkbox"/>		300	365	303	12	135	-
NSBH1130-55-ATH	<input type="checkbox"/>		11.9	55	120	58	12	140
NSBH1130-90-ATH	<input type="checkbox"/>	90		155	93	12	135	-
NSBH1130-120-ATH	<input type="checkbox"/>	120		185	123	12	135	-
NSBH1130-150-ATH	<input type="checkbox"/>	150		215	153	12	135	-
NSBH1130-200-ATH	<input type="checkbox"/>	12.0	200	265	203	12	135	-
NSBH1130-250-ATH	<input type="checkbox"/>		250	315	253	12	135	-
NSBH1130-300-ATH	<input type="checkbox"/>		300	365	303	12	135	-

商品コード Item code	在庫 Stock	寸法 Size (mm)					先端角 α Point angle	希望小売 価格 (円) Suggested retail price (¥)
		直径 Tool dia.	溝長 Flute length	全長 Overall length	首下長 Under neck length	シャンク径 Shank dia.		
		DC	ℓ	LF	ℓ ₂	DCONMS		
NSBH1140-55-ATH	<input type="checkbox"/>	11.4	55	120	58	12	140	-
NSBH1140-90-ATH	<input type="checkbox"/>		90	155	93	12	135	-
NSBH1140-120-ATH	<input type="checkbox"/>		120	185	123	12	135	-
NSBH1140-150-ATH	<input type="checkbox"/>		150	215	153	12	135	-
NSBH1140-200-ATH	<input type="checkbox"/>	11.5	200	265	203	12	135	-
NSBH1140-250-ATH	<input type="checkbox"/>		250	315	253	12	135	-
NSBH1140-300-ATH	<input type="checkbox"/>		300	365	303	12	135	-
NSBH1150-60-ATH	<input checked="" type="checkbox"/>		11.6	60	125	63	12	140
NSBH1150-90-ATH	<input checked="" type="checkbox"/>	90		155	93	12	135	39,960
NSBH1150-120-ATH	<input checked="" type="checkbox"/>	120		185	123	12	135	50,050
NSBH1150-150-ATH	<input checked="" type="checkbox"/>	150		215	153	12	135	51,960
NSBH1150-200-ATH	<input checked="" type="checkbox"/>	11.7	200	265	203	12	135	60,030
NSBH1150-250-ATH	<input checked="" type="checkbox"/>		250	315	253	12	135	67,320
NSBH1150-300-ATH	<input checked="" type="checkbox"/>		300	365	303	12	135	74,510
NSBH1160-60-ATH	<input type="checkbox"/>		11.8	60	125	63	12	140
NSBH1160-90-ATH	<input type="checkbox"/>	90		155	93	12	135	-
NSBH1160-120-ATH	<input type="checkbox"/>	120		185	123	12	135	-
NSBH1160-150-ATH	<input type="checkbox"/>	150		215	153	12	135	-
NSBH1160-200-ATH	<input type="checkbox"/>	11.9	200	265	203	12	135	-
NSBH1160-250-ATH	<input type="checkbox"/>		250	315	253	12	135	-
NSBH1160-300-ATH	<input type="checkbox"/>		300	365	303	12	135	-
NSBH1170-60-ATH	<input type="checkbox"/>		12.0	60	125	63	12	140
NSBH1170-90-ATH	<input type="checkbox"/>	90		155	93	12	135	-
NSBH1170-120-ATH	<input type="checkbox"/>	120		185	123	12	135	-
NSBH1170-150-ATH	<input type="checkbox"/>	150		215	153	12	135	-
NSBH1170-200-ATH	<input type="checkbox"/>	12.1	200	265	203	12	135	-
NSBH1170-250-ATH	<input type="checkbox"/>		250	315	253	12	135	-
NSBH1170-300-ATH	<input type="checkbox"/>		300	365	303	12	135	-
NSBH1180-60-ATH	<input type="checkbox"/>		12.2	60	125	63	12	140
NSBH1180-90-ATH	<input type="checkbox"/>	90		155	93	12	135	-
NSBH1180-120-ATH	<input type="checkbox"/>	120		185	123	12	135	-
NSBH1180-150-ATH	<input type="checkbox"/>	150		215	153	12	135	-
NSBH1180-200-ATH	<input type="checkbox"/>	12.3	200	265	203	12	135	-
NSBH1180-250-ATH	<input type="checkbox"/>		250	315	253	12	135	-
NSBH1180-300-ATH	<input type="checkbox"/>		300	365	303	12	135	-
NSBH1190-60-ATH	<input type="checkbox"/>		12.4	60	125	63	12	140
NSBH1190-90-ATH	<input type="checkbox"/>	90		155	93	12	135	-
NSBH1190-120-ATH	<input type="checkbox"/>	120		185	123	12	135	-
NSBH1190-150-ATH	<input type="checkbox"/>	150		215	153	12	135	-
NSBH1190-200-ATH	<input type="checkbox"/>	12.5	200	265	203	12	135	-
NSBH1190-250-ATH	<input type="checkbox"/>		250	315	253	12	135	-
NSBH1190-300-ATH	<input type="checkbox"/>		300	365	303	12	135	-
NSBH1200-60-ATH	<input checked="" type="checkbox"/>		12.6	60	125	63	12	140
NSBH1200-90-ATH	<input checked="" type="checkbox"/>	90		155	93	12	135	41,520
NSBH1200-120-ATH	<input checked="" type="checkbox"/>	120		185	123	12	135	47,690
NSBH1200-150-ATH	<input checked="" type="checkbox"/>	150		215	153	12	135	51,960
NSBH1200-200-ATH	<input checked="" type="checkbox"/>	12.7	200	265	203	12	135	60,370
NSBH1200-250-ATH	<input checked="" type="checkbox"/>		250	315	253	12	135	68,010
NSBH1200-300-ATH	<input checked="" type="checkbox"/>		300	365	303	12	135	74,620

○ 対応被削材 Applicable work materia

軟鋼 Mild steel	炭素鋼 Carbon steel	合金鋼 Alloy steel	調質鋼 Heat-treated steel	工具鋼 Tool steel	焼入れ鋼 Hardened steel	ステン レス鋼 Stainless steel	耐熱鋼 Ti合金 Heat-resistant steel, Ti alloy Inconel	鋳鉄 Cast iron	ダクタイル 鋳鉄 Ductile cast iron FCD	アルミ 合金 Aluminum alloy Al	銅合金 Copper alloy Cu
SS	SOCC	SCM, SCr	SKD SKS	~40HRC	~45HRC 45HRC~	SUS		FC			
					○ ◎						

○ 再研磨対応外径範囲 Re-grinding compatibility range

商品コード Item code	エンド End (mm)
NSBH-ATH	2 ~ 12

Boring Tools

Non Step Borer

Carbide Oil Hole Non Step Borer H for High Hardness Material 高硬度用超硬OHノンステップボーラーH

標準切削条件表 Recommended cutting conditions **NSBH-ATH**

水溶性内部クーラント切削条件 Cutting Conditions (Water base internal coolant)

被削材 Work material	プリハードン鋼 (40~45HRC) Pre-hardened steels		焼入れ鋼 (45~55HRC) Hardened steels		焼入れ鋼 (55~60HRC) Hardened steels	
	切削速度 v_c (m/min)	送り量 f (mm/rev)	切削速度 v_c (m/min)	送り量 f (mm/rev)	切削速度 v_c (m/min)	送り量 f (mm/rev)
直径 Tool dia.						
φ2	20~60~80	0.01~0.05	20~40~60	0.01~0.03	10~20	0.01~0.02
φ4		0.02~0.08		0.01~0.06		0.01~0.04
φ6		0.08~0.15		0.05~0.09		0.03~0.06
φ8		0.1~0.2		0.06~0.12		0.04~0.08
φ10		0.12~0.25		0.08~0.15		0.06~0.1
φ12		0.13~0.25		0.1~0.15		0.06~0.1

【切削条件の選定について】 Setting of Cutting Conditions

- この標準切削条件は切削条件の目安を表すものです。実際の加工では、加工形状、目的、使用機械などにより切削条件を調整ください。
- 本工具の直径公差はプラス公差です。したがって、ガイド用ドリルとロングドリルをご使用の際は、同じNSBH-ATHのシリーズで使用ください。仮に通常のWHNSB-THを使用されますと、マイナス公差になりますので、加工が加工精度が悪化することがあります。
- 工具装着の際は傷や汚れの無いコレットを用い、工具の振れは0.02mm以下に抑えてください。
- 被削材は変形、たわみ、振動が起こらないようしっかりと保持してください。
- 穴加工を実施する際、穴の最終深さの点にて、ドリルを入れてください。そのことで切りくず排出性を向上させることができます。
- 切りくずが排出されにくい場合は、工具径程度の深さでステップ加工を実施ください。
- 加工中、切りくずが排出にて問題が生じる場合は、対策として以下を参照してください。
①回転数そのままで送り速度だけを下げる。(切りくずを薄くして排出性を高める。)
②送り速度をそのまま回転数だけを上げる(回転数を高めて切りくず排出性を高める。)
- 貫通穴の抜け際においては、送り量 f を半分程度に下げて調整ください。
- 切削液は水溶性の内部給油を推奨いたします。
- この内部クーラント切削条件基準は希釈倍率20倍以下の水溶性切削油剤を使用する場合のものです。20倍を超える場合は切削速度範囲の下限を目安に使用してください。また、工具径がφ5.0以下の場合はクーラント圧は2.0MPa以上を、φ5.0を超える場合は1.5MPa以上を推奨いたします。
- MQL(ミスト)加工の場合は工具からのミスト吐出量や吐出の状態により切削速度を下げないと加工できない場合があります。
- 油性の切削油剤を使用する場合は切削速度範囲の下限より低速の条件でご使用ください。また、切りくずおよび工具の発熱による発煙・引火にご注意ください。
- オイルホール詰まりの原因となるため、クーラントのメンテナンスは充分に行ってください。

※下記の加工方法を必ず参照ください。

Be sure to refer to the drilling process as follows when selecting a tool.

- These standard cutting conditions are intended as approximate values for cutting conditions. For actual drilling, cutting conditions should be adjusted according to the drilling shape, purpose, machine used, etc.
- NSBH-ATH series have positive tolerance on the diameter. Please select guide and long-hole drills out of NSBH-ATH series. Mixed use of conventional WHNSB-TH series harms drilling stability due to negative tolerance of WHNSB-TH series.
- When changing the tool, use collet free from flaws and stains and attach the tool firmly so that its runout is 0.02mm or less.
- Works should be gripped firmly to prevent deformation, deflection and vibration.
- Upon drilling hole, dwell time at the final depth helps chip removal.
- If cutting chips are not smoothly removed, perform step drilling at depth around the tool diameter.
- Upon matters in chip removal during drilling, please refer to following countermeasures:
①Keep v_c and lower feed. (The thinner chip for better removal)
②Keep f and higher v_c . (Higher rotation for better removal)
- At the time of through-hole reduce feed rate f to one-half or less.
- Internal supply of water based coolant is recommended.
- The above cutting conditions are based on the use of a water base coolant diluted to a maximum of 20 times. When coolant dilution exceeds 20 times, decrease the cutting speed to the lowest in the specified range. When the tool diameter is φ5.0 or less, the coolant pressure should be 2.0 MPa or higher, and when the diameter is over φ5.0, the pressure should be 1.5 MPa or higher.
- When performing MQL (mist) machining, depending on the amount or conditions of spray from the tool, it may be necessary to reduce the cutting speed in order to drilling.
- When oil base coolant is used, reduce the cutting speed to a speed lower than the lowest speed in the specified range. Take the greatest care to avoid smoke or ignition due to heating of chips and the tool.
- Perform sufficient maintenance of coolant systems to prevent clogging of the oil hole.

穴あけ工具
ノンステップボーラー

切削加工方法 Drilling Method

1 下穴(ガイド穴)加工 Drilling of pilot hole (guide hole)

※次頁の使用上の注意を参照ください。Please refer to next page for attention for use

- 推奨工具 Recommended tools :
同一刃径の溝長が最も短い製品(先端角140°のNSBH-ATH)をご使用ください
Use the product with the shortest flute length for each size of product. (Point angle 140-degree NSBH-ATH)
- 穴深さ Hole depth : 工具径×3.0倍 tool diameter ×3.0 times
※溝長がL/D=8以上の製品を使用される場合、ガイド穴をあけてご使用ください
When using a product for which the flute length is more than L/D=8, bore a pilot hole first.

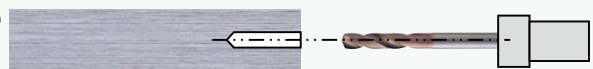

2 低速回転、クーラントON Supplying coolant during low-speed revolution

- 低速回転でガイド穴へ入れてください ($n=0\sim500\text{min}^{-1}$)
Leading to the pilot hole at low speed ($n=0\sim500\text{min}^{-1}$)
- ガイド穴加工終了面より2.0~5.0mm手前で送りをストップしてください
Stop feed 2.0~5.0 mm before the end of the pilot hole.
※工具刃長が200mm以上の場合は、回転数 $n=200\text{min}^{-1}$ 以下でガイド穴へ入れてください
When a long tool (200mm or longer) is used, position the tool to the pilot hole at low revolution speed ($n=200\text{min}^{-1}$ or less).



3 切削回転、切削送り (NSBH-ATH) High-speed revolution for drilling feed (NSBH-ATH)

- 回転数が正規に上がるのを確認し切削を開始してください
After confirming that the revolution speed is increasing at the specified rate, start cutting.



4 加工終了 Finish drilling

- 低速回転にて工具を抜いてください ($n=0\sim500\text{min}^{-1}$)
Withdraw the tool at low speed. ($n=0\sim500\text{min}^{-1}$)
※工具刃長が200mm以上の場合は、回転数 $n=200\text{min}^{-1}$ 以下で抜いてください
When a long tool (200mm or longer) is used, withdraw the tool at low revolution speed ($n=200\text{min}^{-1}$ or less).



○ NSBH-ATHのガイド穴の加工について Regarding pilot hole drilling for NSBH-ATH

各工具径において首下長が最小のNSBH-ATHの先端角は140°です。
 また、その他のNSBH-ATHは先端角が135°です。
 深穴加工を行う場合、まず先端角140°のNSBH-ATHによるガイド穴加工を推奨します。
 先端角の5°の差により食いつき性が向上します。
 The shortest NSBH-ATH among each diameter length series has point angle of 140°, though others have that of 135°.
 It is recommended first to drill a guide hole with NSBH-ATH of point angle 140° before deep boring.
 +5° gives better tool edge allocation onto work material.

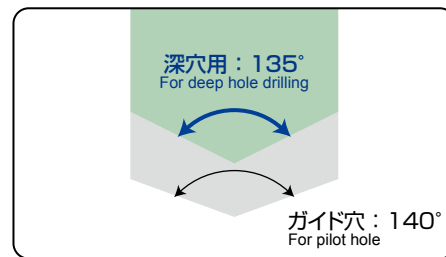

例 Example 加工穴形状 hole size : $\phi 6 \times 100\text{mm}$

- ① ガイド穴 pilot hole → NSBH0600-30-ATH
- ② 深穴加工 deep hole drilling → NSBH0600-120-ATH

○ NSBH-ATHの直径公差について Regarding tolerance of diameter for NSBH-ATH

高硬度鋼の穴あけの際に収縮すること、金型エジェクターピン穴における、クリアランスの確保を考慮し、NSBH-ATHの直径公差はプラス公差で設計しています。
 現状のWHNSB、WNSB両シリーズは、直径公差をマイナス公差で設計しています。
 ガイド穴の加工にWHNSBもしくはWNSBを使用し、その後同サイズのNSBH-ATHを使用すると、ガイド穴挿入時に外周側が干渉する可能性があります。
 Diameter of NSBH-ATH has a positive tolerance in order to (1) compensate hole shrink after boring, and (2) keep clearance for ejector pin of die mold.
 WHNSB and WNSB have negative tolerance of diameter.
 Use of WHNSB or WNSB for pilot hole may cause diameter interference with NSBH-ATH.

【直径公差】 Diameter tolerance

DC ≤ 6	0	~+0.012
6 < DC ≤ 10	0	~+0.015
10 < DC	-0.003	~+0.015

○ ねじ切り工具の下穴に使用するNSBH-ATHについて NSBH-ATH used for pilot hole before threading

タップの下穴加工に適合したサイズのNSBH-ATHを追加いたしました。以下に示すねじ切り工具と組み合わせて、焼入れ鋼のねじ切り加工が短時間でできます。
 Expanded lineup! For pilot hole of tapping products added. Tapping is possible by NSBH-ATH and carbide threading cutters combination easily.

対応するねじサイズ Screw size		商品コード Item code	在庫 Stocks	直径 Tool dia.	溝長 Flute length	全長 Overall length	首下長 Under neck length	対応するねじ切り工具 Adapted carbide threading cutters	
呼び径 Nominal dia.	ピッチ Pitch							商品コード Item code	掲載ページ Item code
M3	0.5	NSBH0240-10-ATH	●	2.4	10	60	14	ET-0.5-6-PN, ET0.5-7.5-PN	F4
		NSBH0250-10-ATH	●	2.5					
		NSBH0260-10-ATH	●	2.6					
M4	0.7	NSBH0320-20-ATH	●	3.2	20	70	23	ET-0.7-8-PN, ET-0.7-10-PN	
		NSBH0330-20-ATH	●	3.3					
		NSBH0340-20-ATH	●	3.4					
M5	0.8	NSBH0410-20-ATH	●	4.1	20	70	23	ET-0.8-10-PN, ET-0.8-12.5-PN	
		NSBH0420-20-ATH	●	4.2					
		NSBH0430-20-ATH	●	4.3					
M6	1	NSBH0490-20-ATH	□	4.9	20	70	23	ET-1.0-12-PN, ET-1.0-15-PN	
		NSBH0500-25-ATH	●	5.0					
		NSBH0510-30-ATH	●	5.1					
M8	1.25	NSBH0670-30-ATH	□	6.7	30	85	33	ET-1.25-16-PN, ET-1.25-20-PN	
		NSBH0680-30-ATH	●	6.8					
		NSBH0690-30-ATH	●	6.9					
M10	1.5	NSBH0850-45-ATH	●	8.5	45	105	48	ET-1.5-20-PN, ET-1.5-25-PN	
		NSBH0860-45-ATH	●	8.6					
		NSBH0870-45-ATH	●	8.7					
		NSBH0880-45-ATH	●	8.8					
M12	1.75	NSBH1030-50-ATH	●	10.3	50	110	53	ET-1.75-24-PN, ET-1.75-30-PN	
		NSBH1040-50-ATH	●	10.4					
		NSBH1050-50-ATH	●	10.5					
M14	2	NSBH1190-60-ATH	□	11.9	60	125	63	該当なし Not applicable	
		NSBH1200-60-ATH	●	12.0					

- 印:標準在庫品です。 □印:特定代理店在庫です。弊社営業へお問い合わせください。
- :Stocked items. □:Stocked by specified distributor. Contact to sales office.

○ トラブルシューティング Trouble shooting

現象 Phenomenons	原因 Factors	対策 Actions
工具寿命がばらついて しまう。 Not stable tool life.	ガイド穴用のドリルを使わなかったため、 深穴加工時のドリルの食いつきが悪くなった。 Performance fell because the drill for pilot holes was not used.	ガイド穴加工には、先端角の広い首下長最小のドリルを使用してください。 Please use drill of wide point angle one for pilot hole drilling.
	ガイド穴加工にWHNSB、WNSBを使った ため外径が干渉してしまいました。 Hit to pilot hole, because WHNSB or WNSB was used pilot hole drilling.	ガイド穴加工と深穴加工は同じシリーズのドリルを使用してください。 Please use same series drills for pilot hole drilling and normal drilling.
折損してしまう。 It will break.	工具の振れが発生している。 Drill has runout.	チャッキング時の工具のフレ精度を0.02mm以下に抑えてください。 また、傷や汚れの無いホルダー、コレットを用い、工具のフレ精度を向上させてください。 Please set drill runout less than 0.02mm. Please change to collet of free from dent or dirt for increase accuracy.
	切りくずの排出性が悪い。 Less chip removal.	ステップ加工を行い切りくずが分断しやすい加工を行ってください。 またステップ加工の際には1秒程度のドウェルを入れて加工してください。 Please use step drilling. Please use dwell process about a second on step drilling.
	クーラントの油量が少なく切りくずがたまる。 Less coolant clogged chip in the hole.	内部給油が確実に供給されているかを確認してください。 Please check coolant system. Please use coolant steadily.

Boring Tools
Non Step Borer

Carbide Drill for SR machining

SR加工用超硬ドリル



(mm)

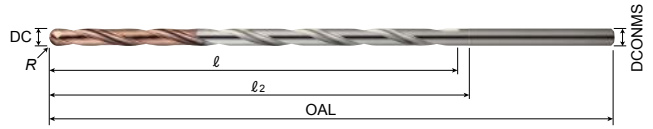

WHSR-ATH



	商品コード Item code	在庫 Stock	寸法 Size (mm)						希望小売価格 (円) Suggested retail price(¥)
			半径 Radius	直径 Tool dia.	溝長 Flute length	首下長 Under neck length	全長 Overall length	シャンク径 Shank dia.	
			R	DC	ℓ	ℓ ₂	OAL	DCONMS	
L/D=8	08WHSR0300-ATH	●	1.5	3	37	40	85	4	23,010
	08WHSR0400-ATH	●	2	4	48	51	97	4	23,800
	08WHSR0500-ATH	●	2.5	5	62	65	114	6	24,920
	08WHSR0600-ATH	●	3	6	70	73	123	6	26,710
	08WHSR0700-ATH	●	3.5	7	81	84	133	8	28,510
	08WHSR0800-ATH	●	4	8	92	95	145	8	31,200
	08WHSR0850-ATH	●	4.25	8.5	99	102	154	10	33,660
	08WHSR0900-ATH	●	4.5	9	104	107	158	10	34,460
	08WHSR0950-ATH	●	4.75	9.5	110	113	165	10	37,590
	08WHSR1000-ATH	●	5	10	115	118	170	10	38,380
	08WHSR1050-ATH	●	5.25	10.5	122	125	181	12	42,530
	08WHSR1100-ATH	●	5.5	11	127	130	185	12	43,320
	08WHSR1150-ATH	●	5.75	11.5	133	136	192	12	48,030
08WHSR1200-ATH	●	6	12	138	141	197	12	48,700	
L/D=20	20WHSR0300-ATH	●	1.5	3	71	74	119	4	35,580
	20WHSR0400-ATH	●	2	4	94	97	143	4	36,470
	20WHSR0500-ATH	●	2.5	5	119	122	171	6	38,150
	20WHSR0600-ATH	●	3	6	142	145	195	6	43,090
	20WHSR0700-ATH	●	3.5	7	166	169	218	8	49,150
	20WHSR0800-ATH	●	4	8	189	192	242	8	54,650
	20WHSR0850-ATH	●	4.25	8.5	201	204	256	10	63,400
	20WHSR0900-ATH	●	4.5	9	213	216	267	10	66,650
	20WHSR0950-ATH	●	4.75	9.5	224	227	279	10	69,570
	20WHSR1000-ATH	●	5	10	236	239	291	10	72,600
	20WHSR1050-ATH	●	5.25	10.5	249	252	308	12	88,080
	20WHSR1100-ATH	●	5.5	11	260	263	318	12	90,110
	20WHSR1150-ATH	●	5.75	11.5	272	275	331	12	94,370
20WHSR1200-ATH	●	6	12	283	286	342	12	98,740	
L/D=30	30WHSR0300-ATH	●	1.5	3	101	104	149	4	38,940
	30WHSR0400-ATH	●	2	4	134	137	183	4	48,370
	30WHSR0500-ATH	●	2.5	5	169	172	221	6	51,510
	30WHSR0600-ATH	●	3	6	202	205	255	6	58,130
	30WHSR0700-ATH	●	3.5	7	236	239	288	8	66,320
	30WHSR0800-ATH	●	4	8	269	272	322	8	73,730
	30WHSR0850-ATH	●	4.25	8.5	286	289	341	10	85,620
	30WHSR0900-ATH	●	4.5	9	303	306	357	10	90,000
	30WHSR0950-ATH	●	4.75	9.5	320	323	374	10	92,460
	30WHSR1000-ATH	●	5	10	336	339	391	10	95,830
	30WHSR1050-ATH	●	5.25	10.5	353	356	412	12	117,810
	30WHSR1100-ATH	●	5.5	11	370	373	429	12	121,180
	30WHSR1150-ATH	●	5.75	11.5	387	390	445	12	134,640
30WHSR1200-ATH	●	6	12	404	407	460	12	138,010	

穴あけ工具
その他のドリル

対応被削材 Applicable work materia

軟鋼 Mild steel SS	炭素鋼 Carbon steel S〇〇C	合金鋼 Alloy steel SCM, SCr	調質鋼 Heat-treated steel SKD SKS	工具鋼 Tool steel ~40HRC	焼入れ鋼 Hardened steel ~45HRC 45HRC~	ステン レス鋼 Stainless steel SUS	耐熱鋼 Ti合金 Heat-resistant steel, Ti alloy Inconel	鑄鉄 Cast iron FC	ダクタイル 鑄鉄 Ductile cast iron FCD	アルミ 合金 Aluminum alloy Al	銅合金 Copper alloy Cu
○	○	○	○	○	○	○	○	○	○	○	○

再研磨対応外径範囲 Re-grinding compatibility range

商品コード Item code	エンド End (mm)
WHSR-ATH	3 ~ 12

●印：標準在庫品です。●：Stocked items.

■ 穴底のみを仕上げる場合 When finishing only the hole bottom

1 03~05WHNSB (NSBH) でガイド穴を加工
 ※ガイド穴加工時の工具径はSR加工で使用する工具径の0~+0.1mmをご使用ください。同径を使用すると、ガイド性が上がり穴壁のうねりが抑えられます。
 Machine a pilot hole using 03 to 05WHNSB (or NSBH).
 ※For the tool diameter when drilling guide holes, use the tool diameter of 0 to +0.1 mm used for SR machining. If the same diameter is used, the guiding property improves and the undulation of the hole wall could be suppressed.

2 WHNSB (またはNSBH) でロング穴加工
 Machine the long hole using WHNSB (or NSBH).

3 WHSRで穴底加工
 Machine the hole bottom using WHSR.

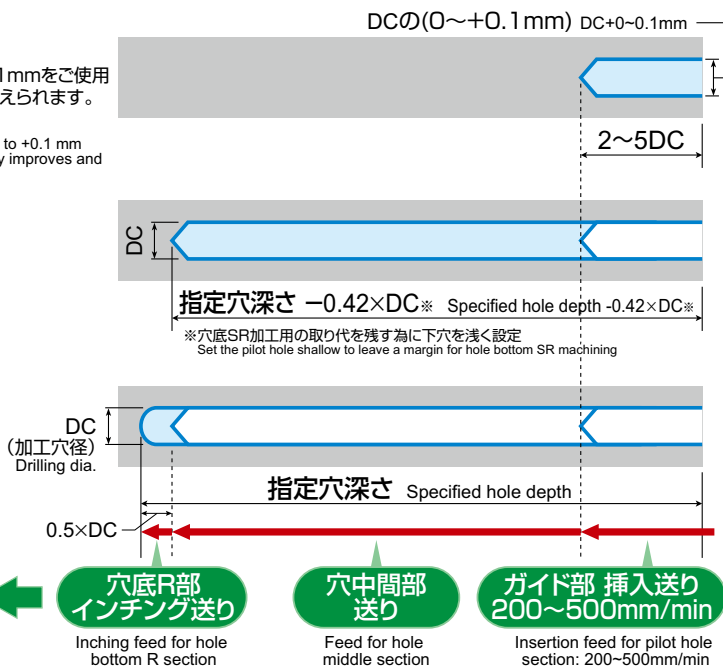
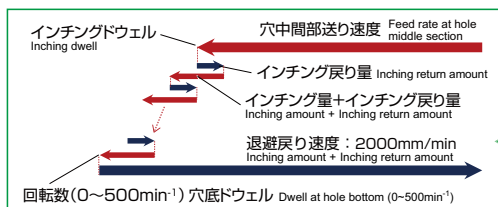

■ 穴壁と穴底を仕上げる場合 When finishing the hole walls and hole bottom

穴壁を仕上げることで、さらに応力腐食割れを低減します。 Finishing the hole walls further reduces stress corrosion cracking.

1 03~05WHNSB (またはNSBH) でWHSRのガイド穴を加工
 ※ガイド穴加工時の工具径はSR加工で使用する工具径の0~+0.1mmをご使用ください。同径を使用すると、ガイド性が上がり穴壁のうねりが抑えられます。
 Machine a pilot hole using 03 to 05WHNSB (or NSBH).
 ※For the tool diameter when drilling guide holes, use the tool diameter of 0 to +0.1 mm used for SR machining. If the same diameter is used, the guiding property improves and the undulation of the hole wall could be suppressed.

2 05~08WHNSB (またはNSBH) でWHNSB (またはNSBH) のガイド穴を加工
 Machine a guide hole for WHNSB (or NSBH) using 05 to 08 WHNSB (or NSBH).

3 WHNSB (またはNSBH) でロング穴加工
 Machine the long hole using WHNSB (or NSBH).

4 WHSRで加工
 Machine using WHSR.

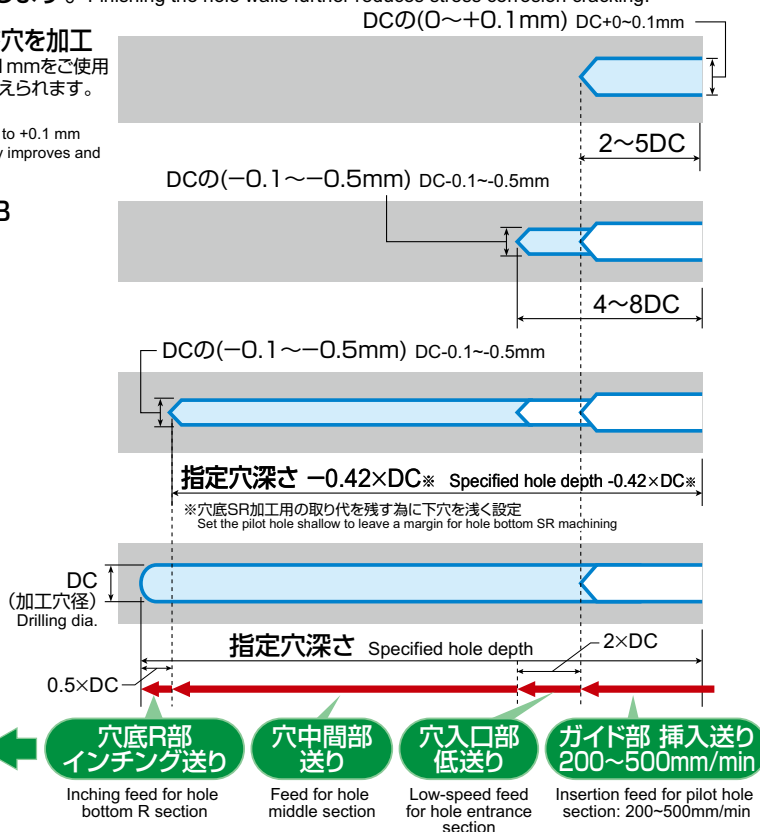
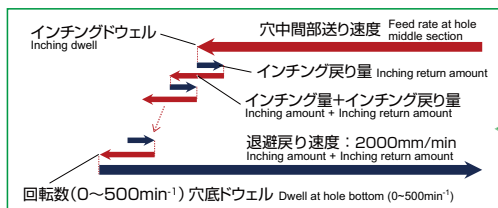

WHSRでのガイド部への挿入時は折損防止のため0~500min⁻¹にしてください。
 WHSRとガイド穴が同径でガイド部の穴壁がうねる場合は回転数を500min⁻¹とし、送り速度を200mm/minとすると改善する場合があります。
 When inserting into the pilot hole with WHSR, please set rpm as 0 ~ 500 min⁻¹ to prevent breakage.
 If the WHSR and the pilot hole have the same diameter and the wall of pilot hole has gurgle, it might be improved by setting the rotation speed as 500 min⁻¹ and the feed rate as 200 mm/min.

Carbide Drill for SR machining

SR加工用超硬ドリル

○ 工具選定例 Tool selection example

※注意事項 Cautions

- ・最大穴深さの目安は「溝長-2DC」で設定してください。
- ・同径サイズでもそれぞれの工具はシャンク径が異なる場合があります。使用するコレットのサイズも異なりますのでよくご確認ください。（該当工具のシャンク径を赤字で表記しています。）
- ・公差の関係上、ガイド穴およびロング穴用の工具直径がWHSR-ATHよりわずかに小さくなる場合がありますが、SR加工自体に影響はありません。

~45HRC 穴底のみ仕上げる場合

When finishing only the hole bottom

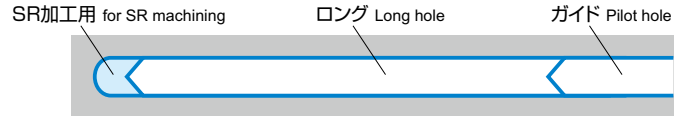

加工 穴径 Tool dia. (mm)	最大 穴深さ Max. hole depth (mm)	ガイド Pilot hole				ロング Long hole				SR加工用 for SR machining			
		商品コード Item code	在庫 Stock	シャンク径 Shank dia. (mm)	溝長 Flute length (mm)	商品コード Item code	在庫 Stock	シャンク径 Shank dia. (mm)	溝長 Flute length (mm)	商品コード Item code	在庫 Stock	シャンク径 Shank dia. (mm)	溝長 Flute length (mm)
3	31	ガイドドリルは不要です。 ただし、穴精度を求める場合は ガイド03WHNSBの使用を推奨します。 Pilot hole is not required. However, when hole accuracy is necessary, using 03WHNSB is recommended.	●	3	29	08WHNSB0300-TH	●	3	35	08WHSR0300-ATH	●	4	37
4	40					08WHNSB0400-TH	●	4	46	08WHSR0400-ATH	●	4	48
5	52					08WHNSB0500-TH	●	5	59	08WHSR0500-ATH	●	6	62
6	58					08WHNSB0600-TH	●	6	67	08WHSR0600-ATH	●	6	70
7	67					08WHNSB0700-TH	●	7	77	08WHSR0700-ATH	●	8	81
8	76					08WHNSB0800-TH	●	8	88	08WHSR0800-ATH	●	8	92
8.5	82					08WHNSB0850-TH	●	9	94	08WHSR0850-ATH	●	10	99
9	86					08WHNSB0900-TH	●	9	99	08WHSR0900-ATH	●	10	104
9.5	91					08WHNSB0950-TH	●	10	105	08WHSR0950-ATH	●	10	110
10	95					08WHNSB1000-TH	●	10	110	08WHSR1000-ATH	●	10	115
10.5	101					08WHNSB1050-TH	●	11	116	08WHSR1050-ATH	●	12	122
11	105					08WHNSB1100-TH	●	11	121	08WHSR1100-ATH	●	12	127
11.5	110	08WHNSB1150-TH	●	12	127	08WHSR1150-ATH	●	12	133				
12	114	08WHNSB1200-TH	●	12	132	08WHSR1200-ATH	●	12	138				
3	65	05WHNSB0300-TH	●	3	29	20WHNSB0300-TH	●	3	69	20WHSR0300-ATH	●	4	71
4	86	05WHNSB0400-TH	●	4	37	20WHNSB0400-TH	●	4	92	20WHSR0400-ATH	●	4	94
5	109	05WHNSB0500-TH	●	5	47	20WHNSB0500-TH	●	5	116	20WHSR0500-ATH	●	6	119
6	130	05WHNSB0600-TH	●	6	47	20WHNSB0600-TH	●	6	139	20WHSR0600-ATH	●	6	142
7	152	05WHNSB0700-TH	●	7	55	20WHNSB0700-TH	●	7	162	20WHSR0700-ATH	●	8	166
8	173	05WHNSB0800-TH	●	8	63	20WHNSB0800-TH	●	8	185	20WHSR0800-ATH	●	8	189
8.5	184	05WHNSB0850-TH	●	9	71	20WHNSB0850-TH	●	9	196	20WHSR0850-ATH	●	10	201
9	195	05WHNSB0900-TH	●	9	71	20WHNSB0900-TH	●	9	208	20WHSR0900-ATH	●	10	213
9.5	205	05WHNSB0950-TH	●	10	79	20WHNSB0950-TH	●	10	219	20WHSR0950-ATH	●	10	224
10	216	05WHNSB1000-TH	●	10	79	20WHNSB1000-TH	●	10	231	20WHSR1000-ATH	●	10	236
10.5	228	05WHNSB1050-TH	●	11	87	20WHNSB1050-TH	●	11	243	20WHSR1050-ATH	●	12	249
11	238	05WHNSB1100-TH	●	11	87	20WHNSB1100-TH	●	11	254	20WHSR1100-ATH	●	12	260
11.5	249	05WHNSB1150-TH	●	12	93	20WHNSB1150-TH	●	12	266	20WHSR1150-ATH	●	12	272
12	259	05WHNSB1200-TH	●	12	93	20WHNSB1200-TH	●	12	277	20WHSR1200-ATH	●	12	283
3	95	05WHNSB0300-TH	●	3	29	30WHNSB0300-TH	●	3	99	30WHSR0300-ATH	●	4	101
4	126	05WHNSB0400-TH	●	4	37	30WHNSB0400-TH	●	4	132	30WHSR0400-ATH	●	4	134
5	159	05WHNSB0500-TH	●	5	47	30WHNSB0500-TH	●	5	166	30WHSR0500-ATH	●	6	169
6	190	05WHNSB0600-TH	●	6	47	30WHNSB0600-TH	●	6	199	30WHSR0600-ATH	●	6	202
7	222	05WHNSB0700-TH	●	7	55	30WHNSB0700-TH	●	7	232	30WHSR0700-ATH	●	8	236
8	253	05WHNSB0800-TH	●	8	63	30WHNSB0800-TH	●	8	265	30WHSR0800-ATH	●	8	269
8.5	269	05WHNSB0850-TH	●	9	71	30WHNSB0850-TH	●	9	281	30WHSR0850-ATH	●	10	286
9	285	05WHNSB0900-TH	●	9	71	30WHNSB0900-TH	●	9	298	30WHSR0900-ATH	●	10	303
9.5	301	05WHNSB0950-TH	●	10	79	30WHNSB0950-TH	●	10	314	30WHSR0950-ATH	●	10	320
10	316	05WHNSB1000-TH	●	10	79	30WHNSB1000-TH	●	10	331	30WHSR1000-ATH	●	10	336
10.5	332	05WHNSB1050-TH	●	11	87	30WHNSB1050-TH	●	11	348	30WHSR1050-ATH	●	12	353
11	348	05WHNSB1100-TH	●	11	87	30WHNSB1100-TH	●	11	364	30WHSR1100-ATH	●	12	370
11.5	364	05WHNSB1150-TH	●	12	93	30WHNSB1150-TH	●	12	381	30WHSR1150-ATH	●	12	387
12	380	05WHNSB1200-TH	●	12	93	30WHNSB1200-TH	●	12	397	30WHSR1200-ATH	●	12	404

●印：標準在庫品です。 □印：特定代理店在庫です。弊社営業へお問合せください。
●： Stocked items. □： Stocked by specified distributor. Contact with our sales department.

詳細はE56ページに記載
Details are mentioned on Page E56

※Cautions

- As a guide of the maximum hole depth, please set with groove length minus 2xDC.
- Even with the same tool diameter, shank diameter may be different for each tool. The size of the collet to use also varies, so please check carefully. (The shank diameter of the corresponding tool is indicated by red number.)
- Due to tolerance, the tool diameter for the guide hole and the long hole may be slightly smaller than WHSR-ATH. but the SR machining itself is not affected.

45HRC~ 穴底のみ仕上げる場合
When finishing only the hole bottom

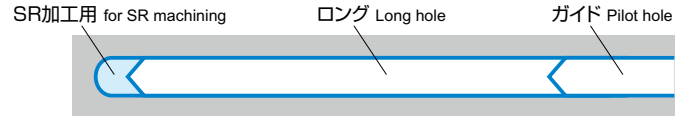

加工 穴径 Tool dia. (mm)	最大 穴深さ Max. hole depth (mm)	ガイド Pilot hole				ロング Long hole				SR加工用 for SR machining			
		商品コード Item code	在庫 Stock	シャンク径 Shank dia. (mm)	溝長 Flute length (mm)	商品コード Item code	在庫 Stock	シャンク径 Shank dia. (mm)	溝長 Flute length (mm)	商品コード Item code	在庫 Stock	シャンク径 Shank dia. (mm)	溝長 Flute length (mm)
3	31	NSBH0300-20-ATH	●	4	20	NSBH0300-40-ATH	●	4	40	08WHSR0300-ATH	●	4	37
4	40	NSBH0400-20-ATH	●	6	20	NSBH0400-60-ATH	●	6	60	08WHSR0400-ATH	●	4	48
5	52	NSBH0500-25-ATH	●	6	25	NSBH0500-90-ATH	●	6	90	08WHSR0500-ATH	●	6	62
6	58	NSBH0600-30-ATH	●	8	30	NSBH0600-90-ATH	●	8	90	08WHSR0600-ATH	●	6	70
7	67	NSBH0700-35-ATH	●	8	35	NSBH0700-90-ATH	●	8	90	08WHSR0700-ATH	●	8	81
8	76	NSBH0800-40-ATH	●	10	40	NSBH0800-120-ATH	●	10	120	08WHSR0800-ATH	●	8	92
8.5	82	NSBH0850-45-ATH	●	10	45	NSBH0850-120-ATH	●	10	120	08WHSR0850-ATH	●	10	99
9	86	NSBH0900-45-ATH	●	10	45	NSBH0900-120-ATH	●	10	120	08WHSR0900-ATH	●	10	104
9.5	91	NSBH0950-50-ATH	□	10	50	NSBH0950-120-ATH	□	10	120	08WHSR0950-ATH	●	10	110
10	95	NSBH1000-50-ATH	●	12	50	NSBH1000-120-ATH	●	12	120	08WHSR1000-ATH	●	10	115
10.5	101	NSBH1050-50-ATH	●	12	50	NSBH1050-150-ATH	□	12	150	08WHSR1050-ATH	●	12	122
11	105	NSBH1100-55-ATH	●	12	55	NSBH1100-150-ATH	●	12	150	08WHSR1100-ATH	●	12	127
11.5	110	NSBH1150-60-ATH	●	12	60	NSBH1150-150-ATH	●	12	150	08WHSR1150-ATH	●	12	133
12	114	NSBH1200-60-ATH	●	12	60	NSBH1200-150-ATH	●	12	150	08WHSR1200-ATH	●	12	138
3	65	NSBH0300-20-ATH	●	4	20	NSBH0300-90-ATH	●	4	90	20WHSR0300-ATH	●	4	71
4	86	NSBH0400-20-ATH	●	6	20	NSBH0400-120-ATH	●	6	120	20WHSR0400-ATH	●	4	94
5	109	NSBH0500-25-ATH	●	6	25	NSBH0500-150-ATH	●	6	150	20WHSR0500-ATH	●	6	119
6	130	NSBH0600-30-ATH	●	8	30	NSBH0600-150-ATH	●	8	150	20WHSR0600-ATH	●	6	142
7	152	NSBH0700-35-ATH	●	8	35	NSBH0700-200-ATH	●	8	200	20WHSR0700-ATH	●	8	166
8	173	NSBH0800-40-ATH	●	10	40	NSBH0800-200-ATH	●	10	200	20WHSR0800-ATH	●	8	189
8.5	184	NSBH0850-45-ATH	●	10	45	NSBH0850-250-ATH	●	10	250	20WHSR0850-ATH	●	10	201
9	195	NSBH0900-45-ATH	●	10	45	NSBH0900-250-ATH	●	10	250	20WHSR0900-ATH	●	10	213
9.5	205	NSBH0950-50-ATH	□	10	50	NSBH0950-250-ATH	□	10	250	20WHSR0950-ATH	●	10	224
10	216	NSBH1000-50-ATH	●	12	50	NSBH1000-250-ATH	●	12	250	20WHSR1000-ATH	●	10	236
10.5	228	NSBH1050-50-ATH	●	12	50	NSBH1050-250-ATH	□	12	250	20WHSR1050-ATH	●	12	249
11	238	NSBH1100-55-ATH	●	12	55	NSBH1100-300-ATH	●	12	300	20WHSR1100-ATH	●	12	260
11.5	249	NSBH1150-60-ATH	●	12	60	NSBH1150-300-ATH	●	12	300	20WHSR1150-ATH	●	12	272
12	259	NSBH1200-60-ATH	●	12	60	NSBH1200-300-ATH	●	12	300	20WHSR1200-ATH	●	12	283
3	95	NSBH0300-20-ATH	●	4	20	NSBH0300-100-ATH	受注生産 BTO			30WHSR0300-ATH	●	4	101
4	126	NSBH0400-20-ATH	●	6	20	NSBH0400-130-ATH	受注生産 BTO			30WHSR0400-ATH	●	4	134
5	159	NSBH0500-25-ATH	●	6	25	NSBH0500-165-ATH	受注生産 BTO			30WHSR0500-ATH	●	6	169
6	190	NSBH0600-30-ATH	●	8	30	NSBH0600-200-ATH	受注生産 BTO			30WHSR0600-ATH	●	6	202
7	222	NSBH0700-35-ATH	●	8	35	NSBH0700-235-ATH	受注生産 BTO			30WHSR0700-ATH	●	8	236
8	253	NSBH0800-40-ATH	●	10	40	NSBH0800-265-ATH	受注生産 BTO			30WHSR0800-ATH	●	8	269
8.5	269	NSBH0850-45-ATH	●	10	45	NSBH0850-285-ATH	受注生産 BTO			30WHSR0850-ATH	●	10	286
9	285	NSBH0900-45-ATH	●	10	45	NSBH0900-300-ATH	受注生産 BTO			30WHSR0900-ATH	●	10	303
9.5	301	NSBH0950-50-ATH	□	10	50	NSBH0950-320-ATH	受注生産 BTO			30WHSR0950-ATH	●	10	320
10	316	NSBH1000-50-ATH	●	12	50	NSBH1000-335-ATH	受注生産 BTO			30WHSR1000-ATH	●	10	336
10.5	332	NSBH1050-50-ATH	●	12	50	NSBH1050-350-ATH	受注生産 BTO			30WHSR1050-ATH	●	12	353
11	348	NSBH1100-55-ATH	●	12	55	NSBH1100-370-ATH	受注生産 BTO			30WHSR1100-ATH	●	12	370
11.5	364	NSBH1150-60-ATH	●	12	60	NSBH1150-385-ATH	受注生産 BTO			30WHSR1150-ATH	●	12	387
12	380	NSBH1200-60-ATH	●	12	60	NSBH1200-400-ATH	受注生産 BTO			30WHSR1200-ATH	●	12	404

BTO: Build-to-order product

詳細はE56ページに記載
Details are mentioned on Page E56

Carbide Drill for SR machining

SR加工用超硬ドリル

○ 工具選定例 Tool selection example

※注意事項 Cautions

- ・最大穴深さの目安は「溝長-2DC」で設定してください。
- ・同径サイズでもそれぞれの工具はシャンク径が異なる場合があります。使用するコレットのサイズも異なりますのでよくご確認ください。（該当工具のシャンク径を赤字で表記しています。）
- ・公差の関係上、ガイド穴およびロング穴用の工具直径がWHSR-ATHよりわずかに小さくなる場合がありますが、SR加工自体に影響はありません。

~45HRC 穴壁と穴底を仕上げる場合 When finishing the hole walls and hole bottom

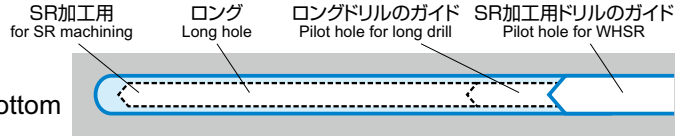

加工 穴径 Tool dia. (mm)	最大 穴深さ Max. hole depth (mm)	SR加工用ドリルのガイド Pilot hole for WHSR				ロングドリルのガイド Pilot hole for long drill				ロング Long hole				SR加工用 For SR machining			
		商品コード Item code	在庫 Stock	シャンク径 Shank dia. (mm)	溝長 Flute length (mm)	商品コード Item code	在庫 Stock	シャンク径 Shank dia. (mm)	溝長 Flute length (mm)	商品コード Item code	在庫 Stock	シャンク径 Shank dia. (mm)	溝長 Flute length (mm)	商品コード Item code	在庫 Stock	シャンク径 Shank dia. (mm)	溝長 Flute length (mm)
3	31	03WHNSB0300-TH	●	3	19	ロングドリルのガイドは不要 です。 Pilot hole for long drill is not required.				08WHNSB0290-TH	●	3	35	08WHSR0300-ATH	●	4	37
4	40	03WHNSB0400-TH	●	4	23					08WHNSB0390-TH	●	4	46	08WHSR0400-ATH	●	4	48
5	52	03WHNSB0500-TH	●	5	29					08WHNSB0490-TH	●	5	59	08WHSR0500-ATH	●	6	62
6	58	03WHNSB0600-TH	●	6	29					08WHNSB0590-TH	●	6	67	08WHSR0600-ATH	●	6	70
7	67	03WHNSB0700-TH	●	7	34					08WHNSB0690-TH	●	7	77	08WHSR0700-ATH	●	8	81
8	76	03WHNSB0800-TH	●	8	39					08WHNSB0790-TH	●	8	88	08WHSR0800-ATH	●	8	92
8.5	82	03WHNSB0850-TH	●	9	44					08WHNSB0840-TH	●	9	94	08WHSR0850-ATH	●	10	99
9	86	03WHNSB0900-TH	●	9	44					08WHNSB0890-TH	●	9	99	08WHSR0900-ATH	●	10	104
9.5	91	03WHNSB0950-TH	●	10	49					08WHNSB0940-TH	●	10	105	08WHSR0950-ATH	●	10	110
10	95	03WHNSB1000-TH	●	10	49					08WHNSB0990-TH	●	10	110	08WHSR1000-ATH	●	10	115
10.5	101	03WHNSB1050-TH	●	11	54					08WHNSB1040-TH	●	11	116	08WHSR1050-ATH	●	12	122
11	105	03WHNSB1100-TH	●	11	54					08WHNSB1090-TH	●	11	121	08WHSR1100-ATH	●	12	127
11.5	110	03WHNSB1150-TH	●	12	59	08WHNSB1140-TH	●	12	127	08WHSR1150-ATH	●	12	133				
12	114	03WHNSB1200-TH	●	12	59	08WHNSB1190-TH	●	12	132	08WHSR1200-ATH	●	12	138				
3	65	05WHNSB0300-TH	●	3	29	08WHNSB0290-TH	●	3	35	20WHNSB0290-TH	●	3	69	20WHSR0300-ATH	●	4	71
4	86	05WHNSB0400-TH	●	4	37	08WHNSB0390-TH	●	4	46	20WHNSB0390-TH	●	4	92	20WHSR0400-ATH	●	4	94
5	109	05WHNSB0500-TH	●	5	47	08WHNSB0490-TH	●	5	59	20WHNSB0490-TH	●	5	116	20WHSR0500-ATH	●	6	119
6	130	05WHNSB0600-TH	●	6	47	08WHNSB0590-TH	●	6	67	20WHNSB0590-TH	●	6	139	20WHSR0600-ATH	●	6	142
7	152	05WHNSB0700-TH	●	7	55	08WHNSB0690-TH	●	7	77	20WHNSB0690-TH	●	7	162	20WHSR0700-ATH	●	8	166
8	173	05WHNSB0800-TH	●	8	63	08WHNSB0790-TH	●	8	88	20WHNSB0790-TH	●	8	185	20WHSR0800-ATH	●	8	189
8.5	184	05WHNSB0850-TH	●	9	71	08WHNSB0840-TH	●	9	94	20WHNSB0840-TH	●	9	196	20WHSR0850-ATH	●	10	201
9	195	05WHNSB0900-TH	●	9	71	08WHNSB0890-TH	●	9	99	20WHNSB0890-TH	●	9	208	20WHSR0900-ATH	●	10	213
9.5	205	05WHNSB0950-TH	●	10	79	08WHNSB0940-TH	●	10	105	20WHNSB0940-TH	●	10	219	20WHSR0950-ATH	●	10	224
10	216	05WHNSB1000-TH	●	10	79	08WHNSB0990-TH	●	10	110	20WHNSB0990-TH	●	10	231	20WHSR1000-ATH	●	10	236
10.5	228	05WHNSB1050-TH	●	11	87	08WHNSB1040-TH	●	11	116	20WHNSB1040-TH	●	11	243	20WHSR1050-ATH	●	12	249
11	238	05WHNSB1100-TH	●	11	87	08WHNSB1090-TH	●	11	121	20WHNSB1090-TH	●	11	254	20WHSR1100-ATH	●	12	260
11.5	249	05WHNSB1150-TH	●	12	93	08WHNSB1140-TH	●	12	127	20WHNSB1140-TH	●	12	266	20WHSR1150-ATH	●	12	272
12	259	05WHNSB1200-TH	●	12	93	08WHNSB1190-TH	●	12	132	20WHNSB1190-TH	●	12	277	20WHSR1200-ATH	●	12	283
3	95	05WHNSB0300-TH	●	3	29	08WHNSB0290-TH	●	3	35	30WHNSB0290-TH	●	3	99	30WHSR0300-ATH	●	4	101
4	126	05WHNSB0400-TH	●	4	37	08WHNSB0390-TH	●	4	46	30WHNSB0390-TH	●	4	132	30WHSR0400-ATH	●	4	134
5	159	05WHNSB0500-TH	●	5	47	08WHNSB0490-TH	●	5	59	30WHNSB0490-TH	●	5	166	30WHSR0500-ATH	●	6	169
6	190	05WHNSB0600-TH	●	6	47	08WHNSB0590-TH	●	6	67	30WHNSB0590-TH	●	6	199	30WHSR0600-ATH	●	6	202
7	222	05WHNSB0700-TH	●	7	55	08WHNSB0690-TH	●	7	77	30WHNSB0690-TH	●	7	232	30WHSR0700-ATH	●	8	236
8	253	05WHNSB0800-TH	●	8	63	08WHNSB0790-TH	●	8	88	30WHNSB0790-TH	●	8	265	30WHSR0800-ATH	●	8	269
8.5	269	05WHNSB0850-TH	●	9	71	08WHNSB0840-TH	●	9	94	30WHNSB0840-TH	●	9	281	30WHSR0850-ATH	●	10	286
9	285	05WHNSB0900-TH	●	9	71	08WHNSB0890-TH	●	9	99	30WHNSB0890-TH	●	9	298	30WHSR0900-ATH	●	10	303
9.5	301	05WHNSB0950-TH	●	10	79	08WHNSB0940-TH	●	10	105	30WHNSB0940-TH	●	10	314	30WHSR0950-ATH	●	10	320
10	316	05WHNSB1000-TH	●	10	79	08WHNSB0990-TH	●	10	110	30WHNSB0990-TH	●	10	331	30WHSR1000-ATH	●	10	336
10.5	332	05WHNSB1050-TH	●	11	87	08WHNSB1040-TH	●	11	116	30WHNSB1040-TH	●	11	348	30WHSR1050-ATH	●	12	353
11	348	05WHNSB1100-TH	●	11	87	08WHNSB1090-TH	●	11	121	30WHNSB1090-TH	●	11	364	30WHSR1100-ATH	●	12	370
11.5	364	05WHNSB1150-TH	●	12	93	08WHNSB1140-TH	●	12	127	30WHNSB1140-TH	●	12	381	30WHSR1150-ATH	●	12	387
12	380	05WHNSB1200-TH	●	12	93	08WHNSB1190-TH	●	12	132	30WHNSB1190-TH	●	12	397	30WHSR1200-ATH	●	12	404

●印：標準在庫品です。 □印：特定代理店在庫です。弊社営業へお問合せください。
●： Stocked items. □： Stocked by specified distributor. Contact with our sales department.

※Cautions

- As a guide of the maximum hole depth, please set with groove length minus 2xDC.
- Even with the same tool diameter, shank diameter may be different for each tool. The size of the collet to use also varies, so please check carefully. (The shank diameter of the corresponding tool is indicated by red number.)
- Due to tolerance, the tool diameter for the guide hole and the long hole may be slightly smaller than WHSR-ATH. but the SR machining itself is not affected.

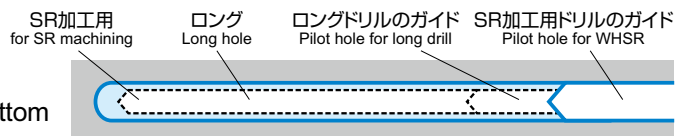

45HRC~ 穴壁と穴底を仕上げる場合
When finishing the hole walls and hole bottom

加工 穴径 Tool dia. (mm)	最大 穴深さ Max. hole depth (mm)	SR加工用ドリルのガイド Pilot hole for WHSR				ロングドリルのガイド Pilot hole for long drill				ロング Long hole				SR加工用 For SR machining			
		商品コード Item code	在庫 Stock	シャンク径 Shank dia. (mm)	溝長 Flute length (mm)	商品コード Item code	在庫 Stock	シャンク径 Shank dia. (mm)	溝長 Flute length (mm)	商品コード Item code	在庫 Stock	シャンク径 Shank dia. (mm)	溝長 Flute length (mm)	商品コード Item code	在庫 Stock	シャンク径 Shank dia. (mm)	溝長 Flute length (mm)
3	31	NSBH0300-20-ATH	●	4	20	NSBH0290-20-ATH	□	4	20	NSBH0290-40-ATH	□	4	40	08WHSR0300-ATH	●	4	37
4	40	NSBH0400-20-ATH	●	6	20	NSBH0390-20-ATH	□	4	20	NSBH0390-60-ATH	□	4	60	08WHSR0400-ATH	●	4	48
5	52	NSBH0500-25-ATH	●	6	25	NSBH0490-20-ATH	□	6	20	NSBH0490-90-ATH	□	6	90	08WHSR0500-ATH	●	6	62
6	58	NSBH0600-30-ATH	●	8	30	NSBH0590-30-ATH	□	6	30	NSBH0590-90-ATH	□	6	90	08WHSR0600-ATH	●	6	70
7	67	NSBH0700-35-ATH	●	8	35	NSBH0690-30-ATH	●	8	30	NSBH0690-90-ATH	□	8	90	08WHSR0700-ATH	●	8	81
8	76	NSBH0800-40-ATH	●	10	40	NSBH0790-35-ATH	□	8	35	NSBH0790-120-ATH	□	8	120	08WHSR0800-ATH	●	8	92
8.5	82	NSBH0850-45-ATH	●	10	45	NSBH0840-45-ATH	□	10	45	NSBH0840-120-ATH	□	10	120	08WHSR0850-ATH	●	10	99
9	86	NSBH0900-45-ATH	●	10	45	NSBH0890-45-ATH	●	10	45	NSBH0890-120-ATH	□	10	120	08WHSR0900-ATH	●	10	104
9.5	91	NSBH0950-50-ATH	□	10	50	NSBH0940-50-ATH	□	10	50	NSBH0940-120-ATH	□	10	120	08WHSR0950-ATH	●	10	110
10	95	NSBH1000-50-ATH	●	12	50	NSBH0990-50-ATH	□	10	50	NSBH0990-120-ATH	□	10	120	08WHSR1000-ATH	●	10	115
10.5	101	NSBH1050-50-ATH	●	12	50	NSBH1040-50-ATH	●	12	50	NSBH1040-150-ATH	□	12	150	08WHSR1050-ATH	●	12	122
11	105	NSBH1100-55-ATH	●	12	55	NSBH1090-50-ATH	●	12	50	NSBH1090-150-ATH	□	12	150	08WHSR1100-ATH	●	12	127
11.5	110	NSBH1150-60-ATH	●	12	60	NSBH1140-55-ATH	□	12	55	NSBH1140-150-ATH	□	12	150	08WHSR1150-ATH	●	12	133
12	114	NSBH1200-60-ATH	●	12	60	NSBH1190-60-ATH	□	12	60	NSBH1190-150-ATH	□	12	150	08WHSR1200-ATH	●	12	138
3	65	NSBH0300-20-ATH	●	4	20	NSBH0290-20-ATH	□	4	20	NSBH0290-70-ATH	受注生産 BTO			20WHSR0300-ATH	●	4	71
4	86	NSBH0400-20-ATH	●	6	20	NSBH0390-20-ATH	□	4	20	NSBH0390-120-ATH	□	4	120	20WHSR0400-ATH	●	4	94
5	109	NSBH0500-25-ATH	●	6	25	NSBH0490-20-ATH	□	6	20	NSBH0490-150-ATH	□	6	150	20WHSR0500-ATH	●	6	119
6	130	NSBH0600-30-ATH	●	8	30	NSBH0590-30-ATH	□	6	30	NSBH0590-150-ATH	□	6	150	20WHSR0600-ATH	●	6	142
7	152	NSBH0700-35-ATH	●	8	35	NSBH0690-30-ATH	●	8	30	NSBH0690-200-ATH	□	8	200	20WHSR0700-ATH	●	8	166
8	173	NSBH0800-40-ATH	●	10	40	NSBH0790-35-ATH	□	8	35	NSBH0790-200-ATH	□	8	200	20WHSR0800-ATH	●	8	189
8.5	184	NSBH0850-45-ATH	●	10	45	NSBH0840-45-ATH	□	10	45	NSBH0840-250-ATH	□	10	250	20WHSR0850-ATH	●	10	201
9	195	NSBH0900-45-ATH	●	10	45	NSBH0890-45-ATH	●	10	45	NSBH0890-250-ATH	□	10	250	20WHSR0900-ATH	●	10	213
9.5	205	NSBH0950-50-ATH	□	10	50	NSBH0940-50-ATH	□	10	50	NSBH0940-250-ATH	□	10	250	20WHSR0950-ATH	●	10	224
10	216	NSBH1000-50-ATH	●	12	50	NSBH0990-50-ATH	□	10	50	NSBH0990-250-ATH	□	10	250	20WHSR1000-ATH	●	10	236
10.5	228	NSBH1050-50-ATH	●	12	50	NSBH1040-50-ATH	●	12	50	NSBH1040-250-ATH	□	12	250	20WHSR1050-ATH	●	12	249
11	238	NSBH1100-55-ATH	●	12	55	NSBH1090-50-ATH	●	12	50	NSBH1090-300-ATH	□	12	300	20WHSR1100-ATH	●	12	260
11.5	249	NSBH1150-60-ATH	●	12	60	NSBH1140-55-ATH	□	12	55	NSBH1140-300-ATH	□	12	300	20WHSR1150-ATH	●	12	272
12	259	NSBH1200-60-ATH	●	12	60	NSBH1190-60-ATH	□	12	60	NSBH1190-300-ATH	□	12	300	20WHSR1200-ATH	●	12	283
3	95	NSBH0300-20-ATH	●	4	20	NSBH0290-20-ATH	□	4	20	NSBH0290-100-ATH	受注生産 BTO			30WHSR0300-ATH	●	4	101
4	126	NSBH0400-20-ATH	●	6	20	NSBH0390-20-ATH	□	4	20	NSBH0390-130-ATH	受注生産 BTO			30WHSR0400-ATH	●	4	134
5	159	NSBH0500-25-ATH	●	6	25	NSBH0490-20-ATH	□	6	20	NSBH0490-165-ATH	受注生産 BTO			30WHSR0500-ATH	●	6	169
6	190	NSBH0600-30-ATH	●	8	30	NSBH0590-30-ATH	□	6	30	NSBH0590-200-ATH	受注生産 BTO			30WHSR0600-ATH	●	6	202
7	222	NSBH0700-35-ATH	●	8	35	NSBH0690-30-ATH	●	8	30	NSBH0690-235-ATH	受注生産 BTO			30WHSR0700-ATH	●	8	236
8	253	NSBH0800-40-ATH	●	10	40	NSBH0790-35-ATH	□	8	35	NSBH0790-265-ATH	受注生産 BTO			30WHSR0800-ATH	●	8	269
8.5	269	NSBH0850-45-ATH	●	10	45	NSBH0840-45-ATH	□	10	45	NSBH0840-285-ATH	受注生産 BTO			30WHSR0850-ATH	●	10	286
9	285	NSBH0900-45-ATH	●	10	45	NSBH0890-45-ATH	●	10	45	NSBH0890-300-ATH	受注生産 BTO			30WHSR0900-ATH	●	10	303
9.5	301	NSBH0950-50-ATH	□	10	50	NSBH0940-50-ATH	□	10	50	NSBH0940-320-ATH	受注生産 BTO			30WHSR0950-ATH	●	10	320
10	316	NSBH1000-50-ATH	●	12	50	NSBH0990-50-ATH	□	10	50	NSBH0990-335-ATH	受注生産 BTO			30WHSR1000-ATH	●	10	336
10.5	332	NSBH1050-50-ATH	●	12	50	NSBH1040-50-ATH	●	12	50	NSBH1040-350-ATH	受注生産 BTO			30WHSR1050-ATH	●	12	353
11	348	NSBH1100-55-ATH	●	12	55	NSBH1090-50-ATH	●	12	50	NSBH1090-370-ATH	受注生産 BTO			30WHSR1100-ATH	●	12	370
11.5	364	NSBH1150-60-ATH	●	12	60	NSBH1140-55-ATH	□	12	55	NSBH1140-385-ATH	受注生産 BTO			30WHSR1150-ATH	●	12	387
12	380	NSBH1200-60-ATH	●	12	60	NSBH1190-60-ATH	□	12	60	NSBH1190-400-ATH	受注生産 BTO			30WHSR1200-ATH	●	12	404

BTO: Build-to-order product

詳細はE56ページに記載
Details are mentioned on Page E56

Carbide Drill for SR machining

SR加工用超硬ドリル

標準切削条件表 Recommended cutting conditions

穴底のみ仕上げる場合

When finishing only the hole bottom

被削材 Work material	切削速度 Cutting speed m/min	加工部 Machined area	切削条件 Cutting condition	目安 General criteria	直径 Tool dia (mm)							
					3.0	4.0	6.0	8.0	8.5	10.0	11.5	12.0
プリハードン鋼 焼入れ鋼 (焼入れ前~50HRC) Pre-hardened steels Hardened steels (From before hardening to 50HRC) ステンレス鋼 Stainless steels SUS	内部 クーラント Internal coolant 40~ 70 ~100	穴中間部 Middle section of hole	回転数 Revolution min ⁻¹		7431	5573	3715	2787	2623	2229	1939	1858
			送り量 Feed per rev mm/rev	DC×(1~2~3)%	0.060	0.080	0.120	0.160	0.170	0.200	0.230	0.240
		送り速度 Feed rate mm/min		446	446	446	446	446	446	446	446	446
		イン칭送り量 mm/rev Inching feed per rev	DC×(0.2~0.3~0.5)%	0.012	0.016	0.024	0.024	0.026	0.020	0.023	0.024	
		イン칭送り速度 mm/min Inching feed rate		89	89	89	67	67	45	45	45	
		イン칭量 mm Inching amount	DC×1%	0.030	0.040	0.060	0.080	0.085	0.100	0.115	0.120	
イン칭戻り量 mm Inching return amount	0.2	イン칭戻り速度 mm/min Inching return rate	100	イン칭ドウェル sec Inching dwell time	0.1	穴底ドウェル sec Hole bottom dwell time	0.3					

穴壁と穴底を仕上げる場合

When finishing the hole walls and hole bottom

被削材 Work material	切削速度 Cutting speed m/min	加工部 Machined area	切削条件 Cutting condition	目安 General criteria	直径 Tool dia (mm)							
					3.0	4.0	6.0	8.0	8.5	10.0	11.5	12.0
プリハードン鋼 焼入れ鋼 (焼入れ前~45HRC) Pre-hardened steels Hardened steels (From before hardening to 45HRC)	内部 クーラント Internal coolant 40~ 70 ~100	穴入口部 Hole entrance section	回転数 Revolution min ⁻¹		7431	5573	3715	2787	2623	2229	1939	1858
			送り量 Feed per rev mm/rev	DC×(0.5~1~1.5)%	0.030	0.040	0.060	0.080	0.085	0.100	0.115	0.120
		送り速度 Feed rate mm/min		223	223	223	223	223	223	223	223	223
		穴中間部 Middle section of hole	送り量 Feed per rev mm/rev	DC×(0.5~1.2~2)%	0.036	0.048	0.072	0.096	0.102	0.120	0.138	0.144
		送り速度 Feed rate mm/min		268	268	268	268	268	268	268	268	268
		穴底R部 R section of hole bottom	イン칭送り量 mm/rev Inching feed per rev	DC×(0.2~0.3~0.5)%	0.012	0.016	0.024	0.024	0.026	0.020	0.023	0.024
イン칭送り速度 mm/min Inching feed rate			89	89	89	67	67	45	45	45		
イン칭量 mm Inching amount	DC×1%		0.030	0.040	0.060	0.080	0.085	0.100	0.115	0.120		
イン칭戻り量 mm Inching return amount	0.2	イン칭戻り速度 mm/min Inching return rate	100	イン칭ドウェル sec Inching dwell time	0.1	穴底ドウェル sec Hole bottom dwell time	0.3					

被削材 Work material	切削速度 Cutting speed m/min	加工部 Machined area	切削条件 Cutting condition	目安 General criteria	直径 Tool dia (mm)							
					3.0	4.0	6.0	8.0	8.5	10.0	11.5	12.0
プリハードン鋼 焼入れ鋼 (45~50HRC) Pre-hardened steels Hardened steels (40~50HRC)	内部 クーラント Internal coolant 30~ 70 ~100	穴入口部 Hole entrance section	回転数 Revolution min ⁻¹		7431	5573	3715	2787	2623	2229	1939	1858
			送り量 Feed per rev mm/rev	DC×(0.25~0.5~1)%	0.015	0.020	0.030	0.040	0.043	0.050	0.058	0.060
		送り速度 Feed rate mm/min		111	111	111	111	111	111	111	111	111
		穴中間部 Middle section of hole	送り量 Feed per rev mm/rev	DC×(0.5~1~1.5)%	0.030	0.040	0.060	0.080	0.085	0.100	0.115	0.120
		送り速度 Feed rate mm/min		223	223	223	223	223	223	223	223	223
		穴底R部 R section of hole bottom	イン칭送り量 mm/rev Inching feed per rev	DC×(0.2~0.3~0.5)%	0.012	0.016	0.024	0.024	0.026	0.020	0.023	0.024
イン칭送り速度 mm/min Inching feed rate			89	89	89	67	67	45	45	45		
イン칭量 mm Inching amount	DC×1%		0.030	0.040	0.060	0.080	0.085	0.100	0.115	0.120		
イン칭戻り量 mm Inching return amount	0.2	イン칭戻り速度 mm/min Inching return rate	100	イン칭ドウェル sec Inching dwell time	0.1	穴底ドウェル sec Hole bottom dwell time	0.3					

切削条件の選定について Setting of cutting conditions

- この標準切削条件表は目安を示すものです。実際の加工では加工形状、目的、使用機械などにより切削条件を調整してください。
- 工具装着の際は傷や汚れの無いコレットを用い、工具の振れは0.02mm以下に抑えてください。
- 被削材は変形、たわみ、振動が起こらないようにしっかりと保持してください。
- 内部クーラントは希釈倍率20倍以下の水溶性切削油剤を使用するものです。20倍を超える場合は切削速度範囲の加減を目安に使用してください。また、工具径がφ5.0以下の場合はクーラント圧は2.0MPa以上を、φ5.0を超える場合は1.5MPa以上を推奨いたします。特に立型MCの場合、切りくずが排出されにくいことがあります。クーラント圧は高いほど切りくず排出が良好です。3MPa以上推奨いたします。
- 油性の切削油剤を使用する場合は切削速度範囲の下限より低速の条件でご使用ください。また、切りくずおよび工具の発熱による発煙・引火にご注意ください。
- オイルホール詰まりの原因となるため、クーラントのメンテナンスは充分に行ってください。
- 明記されていない被削材は弊社にお問い合わせください。
- This standard cutting condition table is for general guidance regarding cutting conditions. The conditions should be adjusted according to the machining shape, application, machine used, etc. for the actual machining.
- When installing the tool, use a collet without scratches or dirt, and keep the tool runout to within 0.02 mm.
- Secure the work material firmly so that deformation, deflection, or vibration does not occur.
- Internal coolant is for when a water-soluble cutting fluid diluted up to 20 times is used. For dilutions of greater than 20 times, the cutting speed range should be used as a guide for adjustment. In addition, it is recommended that the coolant pressure be set to 2.0 MPa or higher if the tool diameter is Ø5.0 or less and to 1.5 MPa or higher if the tool diameter is greater than Ø5.0. Particularly in case of a vertical MC, chips tend not to be discharged easily. Better chip discharge is expected with higher coolant pressures- 3MPa or more is recommended.
- When using an oil-based cutting fluid, use conditions with speeds lower than the lower limit of the cutting speed range. Also, please be careful of smoke or fire caused by the hot cutting chips and tool.
- Be sure to sufficiently maintain the oil hole to prevent clogging.
- Please contact us about work materials not listed.

超硬 OH ミニステップボーラー



(mm)



平面二段
S-X形シンニング
Plane, S-X thinning

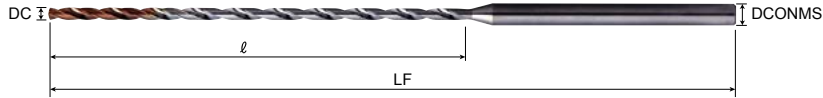

切削条件表 E66

Cutting Conditions

WHMB-TH

商品コード Item code	在庫 Stock	寸法 Size (mm)				希望小売 価格(円) Suggested retail price(¥)
		直径 Tool dia. DC	溝長 Flute length ℓ	全長 Overall length LF	シャンク径 Shank dia. DCONMS	
03WHMB0100-TH	●	6	55	3	11,570	
05WHMB0100-TH	●	10	55	3	15,710	
10WHMB0100-TH	●	15	55	3	20,200	
15WHMB0100-TH	●	20	60	3	23,570	
20WHMB0100-TH	●	24	65	3	27,160	
25WHMB0100-TH	●	28	65	3	29,860	
30WHMB0100-TH	●	33	70	3	32,540	
03WHMB0101-TH	□	6	55	3	-	
05WHMB0101-TH	□	10	55	3	-	
10WHMB0101-TH	□	16	55	3	-	
20WHMB0101-TH	□	25	65	3	-	
30WHMB0101-TH	□	35	75	3	-	
03WHMB0102-TH	□	6	55	3	-	
05WHMB0102-TH	□	10	55	3	-	
10WHMB0102-TH	□	16	55	3	-	
20WHMB0102-TH	□	25	65	3	-	
30WHMB0102-TH	□	35	75	3	-	
03WHMB0103-TH	□	6	55	3	-	
05WHMB0103-TH	□	10	55	3	-	
10WHMB0103-TH	□	16	55	3	-	
20WHMB0103-TH	□	25	65	3	-	
30WHMB0103-TH	□	35	75	3	-	
03WHMB0105-TH	●	6	55	3	11,570	
05WHMB0105-TH	●	10	55	3	15,710	
10WHMB0105-TH	●	16	55	3	20,200	
15WHMB0105-TH	●	20	60	3	23,570	
20WHMB0105-TH	●	25	65	3	27,160	
25WHMB0105-TH	●	30	70	3	29,860	
30WHMB0105-TH	●	35	75	3	32,540	
03WHMB0110-TH	●	6	55	3	11,570	
05WHMB0110-TH	●	11	55	3	15,710	
10WHMB0110-TH	●	17	55	3	20,200	
15WHMB0110-TH	●	22	60	3	23,570	
20WHMB0110-TH	●	26	65	3	27,160	
25WHMB0110-TH	●	32	70	3	29,860	
30WHMB0110-TH	●	37	75	3	32,540	
03WHMB0111-TH	□	6	55	3	-	
05WHMB0111-TH	□	11	55	3	-	
10WHMB0111-TH	□	18	60	3	-	
20WHMB0111-TH	□	28	70	3	-	
30WHMB0111-TH	□	38	75	3	-	

商品コード Item code	在庫 Stock	寸法 Size (mm)				希望小売 価格(円) Suggested retail price(¥)
		直径 Tool dia. DC	溝長 Flute length ℓ	全長 Overall length LF	シャンク径 Shank dia. DCONMS	
03WHMB0112-TH	□	6	55	3	-	
05WHMB0112-TH	□	11	55	3	-	
10WHMB0112-TH	□	1.12	18	60	3	-
20WHMB0112-TH	□	28	70	3	-	
30WHMB0112-TH	□	38	75	3	-	
03WHMB0113-TH	□	6	55	3	-	
05WHMB0113-TH	□	11	55	3	-	
10WHMB0113-TH	□	1.13	18	60	3	-
20WHMB0113-TH	□	28	70	3	-	
30WHMB0113-TH	□	38	75	3	-	
03WHMB0115-TH	●	6	55	3	11,570	
05WHMB0115-TH	●	11	55	3	15,710	
10WHMB0115-TH	●	1.15	18	60	3	20,200
15WHMB0115-TH	●	23	60	3	23,570	
20WHMB0115-TH	●	28	70	3	27,160	
25WHMB0115-TH	●	33	70	3	29,860	
30WHMB0115-TH	●	38	75	3	32,540	
03WHMB0120-TH	●	6	55	3	11,570	
05WHMB0120-TH	●	12	55	3	15,710	
10WHMB0120-TH	●	1.2	18	60	3	20,200
15WHMB0120-TH	●	23	60	3	23,570	
20WHMB0120-TH	●	29	70	3	27,160	
25WHMB0120-TH	●	35	75	3	29,860	
30WHMB0120-TH	●	40	80	3	32,540	
03WHMB0121-TH	□	7	55	3	-	
05WHMB0121-TH	□	13	55	3	-	
10WHMB0121-TH	□	1.21	20	60	3	-
20WHMB0121-TH	□	31	70	3	-	
30WHMB0121-TH	□	42	80	3	-	
03WHMB0122-TH	□	7	55	3	-	
05WHMB0122-TH	□	13	55	3	-	
10WHMB0122-TH	□	1.22	20	60	3	-
20WHMB0122-TH	□	31	70	3	-	
30WHMB0122-TH	□	42	80	3	-	
03WHMB0123-TH	□	7	55	3	-	
05WHMB0123-TH	□	13	55	3	-	
10WHMB0123-TH	□	1.23	20	60	3	-
20WHMB0123-TH	□	31	70	3	-	
30WHMB0123-TH	□	42	80	3	-	

商品コード Item code	在庫 Stock	寸法 Size (mm)				希望小売 価格(円) Suggested retail price(¥)
		直径 Tool dia. DC	溝長 Flute length ℓ	全長 Overall length LF	シャンク径 Shank dia. DCONMS	
03WHMB0125-TH	●	7	55	3	11,570	
05WHMB0125-TH	●	13	55	3	15,710	
10WHMB0125-TH	●	1.25	20	60	3	20,200
15WHMB0125-TH	●	24	60	3	23,570	
20WHMB0125-TH	●	31	70	3	27,160	
25WHMB0125-TH	●	36	75	3	29,860	
30WHMB0125-TH	●	42	80	3	32,540	
03WHMB0130-TH	●	7	55	3	11,570	
05WHMB0130-TH	●	14	55	3	15,710	
10WHMB0130-TH	●	1.3	21	60	3	20,200
15WHMB0130-TH	●	25	70	3	23,570	
20WHMB0130-TH	●	32	70	3	27,160	
25WHMB0130-TH	●	37	75	3	29,860	
30WHMB0130-TH	●	43	80	3	32,540	
03WHMB0131-TH	□	7	55	3	-	
05WHMB0131-TH	□	14	55	3	-	
10WHMB0131-TH	□	1.31	21	60	3	-
20WHMB0131-TH	□	33	70	3	-	
30WHMB0131-TH	□	45	85	3	-	
03WHMB0132-TH	□	7	55	3	-	
05WHMB0132-TH	□	14	55	3	-	
10WHMB0132-TH	□	1.32	21	60	3	-
20WHMB0132-TH	□	33	70	3	-	
30WHMB0132-TH	□	45	85	3	-	
03WHMB0133-TH	□	7	55	3	-	
05WHMB0133-TH	□	14	55	3	-	
10WHMB0133-TH	□	1.33	21	60	3	-
20WHMB0133-TH	□	33	70	3	-	
30WHMB0133-TH	□	45	85	3	-	
03WHMB0135-TH	●	7	55	3	11,570	
05WHMB0135-TH	●	14	55	3	15,710	
10WHMB0135-TH	●	1.35	21	60	3	20,200
15WHMB0135-TH	●	26	70	3	23,570	
20WHMB0135-TH	●	33	70	3	27,160	
25WHMB0135-TH	●	37	75	3	29,860	
30WHMB0135-TH	●	45	85	3	32,540	

メーカー再研磨、再コーティングは行っておりません。
Manufacturer regrinding/recoating is not possible.

●印：標準在庫品です。 □印：特定代理店在庫です。弊社営業へお問合せください。
● : Stocked items. □ : Stocked by specified distributor. Contact with our sales department.

超硬 OH ミニステップボーラー

○○WHMB○○○○-TH

商品コード Item code	在庫 Stock	寸法 Size (mm)				希望小売 価格(円) Suggested retail price(¥)
		直径 Tool dia. DC	溝長 Flute length ℓ	全長 Overall length LF	シャンク 径 Shank dia. DCONMS	
03WHMB0140-TH	●		7	55	3	11,570
05WHMB0140-TH	●		15	55	3	15,710
10WHMB0140-TH	●		22	60	3	20,200
15WHMB0140-TH	●	1.4	27	70	3	23,570
20WHMB0140-TH	●		33	70	3	27,160
25WHMB0140-TH	●		38	75	3	29,860
30WHMB0140-TH	●		47	85	3	32,540
03WHMB0141-TH	□		7	55	3	-
05WHMB0141-TH	□		15	55	3	-
10WHMB0141-TH	□	1.41	23	60	3	-
20WHMB0141-TH	□		35	75	3	-
30WHMB0141-TH	□		49	85	3	-
03WHMB0142-TH	□		7	55	3	-
05WHMB0142-TH	□		15	55	3	-
10WHMB0142-TH	□	1.42	23	60	3	-
20WHMB0142-TH	□		35	75	3	-
30WHMB0142-TH	□		49	85	3	-
03WHMB0143-TH	□		7	55	3	-
05WHMB0143-TH	□		15	55	3	-
10WHMB0143-TH	□	1.43	23	60	3	-
20WHMB0143-TH	□		35	75	3	-
30WHMB0143-TH	□		49	85	3	-
03WHMB0145-TH	●		7	55	3	11,570
05WHMB0145-TH	●		15	55	3	15,710
10WHMB0145-TH	●		23	60	3	20,200
15WHMB0145-TH	●	1.45	30	70	3	23,570
20WHMB0145-TH	●		35	75	3	27,160
25WHMB0145-TH	●		42	80	3	29,860
30WHMB0145-TH	●		49	85	3	32,540
03WHMB0150-TH	●		8	55	3	11,570
05WHMB0150-TH	●		16	55	3	15,710
10WHMB0150-TH	●		24	60	3	20,200
15WHMB0150-TH	●	1.5	30	70	3	23,570
20WHMB0150-TH	●		37	75	3	27,160
25WHMB0150-TH	●		42	80	3	29,860
30WHMB0150-TH	●		50	90	3	32,540
03WHMB0151-TH	□		8	55	3	-
05WHMB0151-TH	□		16	55	3	-
10WHMB0151-TH	□	1.51	22	60	3	-
20WHMB0151-TH	□		37	75	3	-
30WHMB0151-TH	□		52	90	3	-

商品コード Item code	在庫 Stock	寸法 Size (mm)				希望小売 価格(円) Suggested retail price(¥)
		直径 Tool dia. DC	溝長 Flute length ℓ	全長 Overall length LF	シャンク 径 Shank dia. DCONMS	
03WHMB0152-TH	□		8	55	3	-
05WHMB0152-TH	□		16	55	3	-
10WHMB0152-TH	□	1.52	22	60	3	-
20WHMB0152-TH	□		37	75	3	-
30WHMB0152-TH	□		52	90	3	-
03WHMB0153-TH	□		8	55	3	-
05WHMB0153-TH	□		16	55	3	-
10WHMB0153-TH	□	1.53	22	60	3	-
20WHMB0153-TH	□		37	75	3	-
30WHMB0153-TH	□		52	90	3	-
03WHMB0155-TH	●		8	55	3	11,570
05WHMB0155-TH	●		16	55	3	15,710
10WHMB0155-TH	●		22	60	3	20,200
15WHMB0155-TH	●	1.55	32	70	3	23,570
20WHMB0155-TH	●		37	75	3	27,160
25WHMB0155-TH	●		44	85	3	29,860
30WHMB0155-TH	●		52	90	3	32,540
03WHMB0160-TH	●		8	55	3	11,570
05WHMB0160-TH	●		17	55	3	15,710
10WHMB0160-TH	●		26	65	3	20,200
15WHMB0160-TH	●	1.6	33	70	3	23,570
20WHMB0160-TH	●		37	75	3	27,160
25WHMB0160-TH	●		45	85	3	29,860
30WHMB0160-TH	●		53	90	3	32,540
03WHMB0161-TH	□		8	55	3	-
05WHMB0161-TH	□		17	55	3	-
10WHMB0161-TH	□	1.61	26	65	3	-
20WHMB0161-TH	□		38	75	3	-
30WHMB0161-TH	□		55	95	3	-
03WHMB0162-TH	□		8	55	3	-
05WHMB0162-TH	□		17	55	3	-
10WHMB0162-TH	□	1.62	26	65	3	-
20WHMB0162-TH	□		38	75	3	-
30WHMB0162-TH	□		55	95	3	-
03WHMB0163-TH	□		8	55	3	-
05WHMB0163-TH	□		17	55	3	-
10WHMB0163-TH	□	1.63	26	65	3	-
20WHMB0163-TH	□		38	75	3	-
30WHMB0163-TH	□		55	95	3	-

商品コード Item code	在庫 Stock	寸法 Size (mm)				希望小売 価格(円) Suggested retail price(¥)
		直径 Tool dia. DC	溝長 Flute length ℓ	全長 Overall length LF	シャンク 径 Shank dia. DCONMS	
03WHMB0165-TH	●		8	55	3	11,570
05WHMB0165-TH	●		17	55	3	15,710
10WHMB0165-TH	●		26	65	3	20,200
15WHMB0165-TH	●	1.65	33	70	3	23,570
20WHMB0165-TH	●		38	75	3	27,160
25WHMB0165-TH	●		46	90	3	29,860
30WHMB0165-TH	●		55	95	3	32,540
03WHMB0170-TH	●		8	55	3	11,570
05WHMB0170-TH	●		18	55	3	15,710
10WHMB0170-TH	●		27	65	3	20,200
15WHMB0170-TH	●	1.7	34	70	3	23,570
20WHMB0170-TH	●		40	80	3	27,160
25WHMB0170-TH	●		48	85	3	29,860
30WHMB0170-TH	●		57	95	3	32,540
03WHMB0171-TH	□		8	55	3	-
05WHMB0171-TH	□		19	60	3	-
10WHMB0171-TH	□	1.71	27	65	3	-
20WHMB0171-TH	□		41	80	3	-
30WHMB0171-TH	□		58	95	3	-
03WHMB0172-TH	□		8	55	3	-
05WHMB0172-TH	□		19	60	3	-
10WHMB0172-TH	□	1.72	27	65	3	-
20WHMB0172-TH	□		41	80	3	-
30WHMB0172-TH	□		58	95	3	-
03WHMB0173-TH	□		8	55	3	-
05WHMB0173-TH	□		19	60	3	-
10WHMB0173-TH	□	1.73	27	65	3	-
20WHMB0173-TH	□		41	80	3	-
30WHMB0173-TH	□		58	95	3	-
03WHMB0175-TH	●		8	55	3	11,570
05WHMB0175-TH	●		19	60	3	15,710
10WHMB0175-TH	●		27	65	3	20,200
15WHMB0175-TH	●	1.75	34	75	3	23,570
20WHMB0175-TH	●		41	80	3	27,160
25WHMB0175-TH	●		50	90	3	29,860
30WHMB0175-TH	●		58	95	3	32,540

メーカー再研磨、再コーティングは行っておりません。●印：標準在庫品です。□印：特定代理店在庫です。弊社営業へお問い合わせください。
 Manufacturer regrinding/recoating is not possible. ● : Stocked Items. □ : Stocked by specified distributor. Contact with our sales department.

穴あけ工具
ミニステップボーラー

WHMB-TH

商品コード Item code	在庫 Stock	寸法 Size (mm)				希望小売 価格(円) Suggested retail price(¥)
		直径 Tool dia.	溝長 Flute length	全長 Overall length	シャンク 径 Shank dia.	
		DC	ℓ	LF	DCONMS	
03WHMB0180-TH	●	10	55	3	11,570	
05WHMB0180-TH	●	19	60	3	15,710	
10WHMB0180-TH	●	28	65	3	20,200	
15WHMB0180-TH	●	36	75	3	23,570	
20WHMB0180-TH	●	43	80	3	27,160	
25WHMB0180-TH	●	51	90	3	29,860	
30WHMB0180-TH	●	60	100	3	32,540	
03WHMB0181-TH	□	10	55	3	-	
05WHMB0181-TH	□	20	60	3	-	
10WHMB0181-TH	□	29	70	3	-	
20WHMB0181-TH	□	45	85	3	-	
30WHMB0181-TH	□	61	100	3	-	
03WHMB0182-TH	□	10	55	3	-	
05WHMB0182-TH	□	20	60	3	-	
10WHMB0182-TH	□	29	70	3	-	
20WHMB0182-TH	□	45	85	3	-	
30WHMB0182-TH	□	61	100	3	-	
03WHMB0183-TH	□	10	55	3	-	
05WHMB0183-TH	□	20	60	3	-	
10WHMB0183-TH	□	29	70	3	-	
20WHMB0183-TH	□	45	85	3	-	
30WHMB0183-TH	□	61	100	3	-	
03WHMB0185-TH	●	10	55	3	11,570	
05WHMB0185-TH	●	20	60	3	15,710	
10WHMB0185-TH	●	29	70	3	20,200	
15WHMB0185-TH	●	38	75	3	23,570	
20WHMB0185-TH	●	45	85	3	27,160	
25WHMB0185-TH	●	53	90	3	29,860	
30WHMB0185-TH	●	61	100	3	32,540	
03WHMB0190-TH	●	10	55	3	11,570	
05WHMB0190-TH	●	20	60	3	15,710	
10WHMB0190-TH	●	29	70	3	20,200	
15WHMB0190-TH	●	39	75	3	23,570	
20WHMB0190-TH	●	45	85	3	27,160	
25WHMB0190-TH	●	55	95	3	29,860	
30WHMB0190-TH	●	63	100	3	32,540	
03WHMB0191-TH	□	10	55	3	-	
05WHMB0191-TH	□	20	60	3	-	
10WHMB0191-TH	□	30	70	3	-	
20WHMB0191-TH	□	47	85	3	-	
30WHMB0191-TH	□	65	105	3	-	

商品コード Item code	在庫 Stock	寸法 Size (mm)				希望小売 価格(円) Suggested retail price(¥)
		直径 Tool dia.	溝長 Flute length	全長 Overall length	シャンク 径 Shank dia.	
		DC	ℓ	LF	DCONMS	
03WHMB0192-TH	□	10	55	3	-	
05WHMB0192-TH	□	20	60	3	-	
10WHMB0192-TH	□	30	70	3	-	
20WHMB0192-TH	□	47	85	3	-	
30WHMB0192-TH	□	65	105	3	-	
03WHMB0193-TH	□	10	55	3	-	
05WHMB0193-TH	□	20	60	3	-	
10WHMB0193-TH	□	30	70	3	-	
20WHMB0193-TH	□	47	85	3	-	
30WHMB0193-TH	□	65	105	3	-	
03WHMB0195-TH	●	10	55	3	11,570	
05WHMB0195-TH	●	20	60	3	15,710	
10WHMB0195-TH	●	30	70	3	20,200	
15WHMB0195-TH	●	41	80	3	23,570	
20WHMB0195-TH	●	47	85	3	27,160	
25WHMB0195-TH	●	56	95	3	29,860	
30WHMB0195-TH	●	65	105	3	32,540	
03WHMB0200-TH	●	10	55	3	11,570	
05WHMB0200-TH	●	20	60	3	15,710	
10WHMB0200-TH	●	30	70	3	20,200	
15WHMB0200-TH	●	41	80	3	23,570	
20WHMB0200-TH	●	47	85	3	27,160	
25WHMB0200-TH	●	57	95	3	29,860	
30WHMB0200-TH	●	67	105	3	32,540	
03WHMB0201-TH	□	10	55	3	-	
05WHMB0201-TH	□	21	60	3	-	
10WHMB0201-TH	□	31	70	3	-	
20WHMB0201-TH	□	49	90	3	-	
30WHMB0201-TH	□	69	110	3	-	
03WHMB0202-TH	□	10	55	3	-	
05WHMB0202-TH	□	21	60	3	-	
10WHMB0202-TH	□	31	70	3	-	
20WHMB0202-TH	□	49	90	3	-	
30WHMB0202-TH	□	69	110	3	-	
03WHMB0203-TH	□	10	55	3	-	
05WHMB0203-TH	□	21	60	3	-	
10WHMB0203-TH	□	31	70	3	-	
20WHMB0203-TH	□	49	90	3	-	
30WHMB0203-TH	□	69	110	3	-	

○ 対応被削材 Applicable work materia

軟鋼 Mild steel	炭素鋼 Carbon steel	合金鋼 Alloy steel	調質鋼 Heat-treated steel	工具鋼 Tool steel	焼入れ鋼 Hardened steel	ステン レス鋼 Stainless steel	耐熱鋼 Ti合金 Heat-resistant steel, Ti alloy Inconel	鋳鉄 Cast iron	ダクタイル 鋳鉄 Ductile cast iron FCD	アルミ 合金 Aluminum alloy Al	銅合金 Copper alloy Cu
SS	S〇〇C	SCM, SCr	SKD SKS	~40HRC	~45HRC 45HRC~	SUS		FC		○	○

○ 再研磨対応外径範囲 Re-grinding compatibility range

商品コード Item code	エンド End (mm)
WHMB-TH	× (N/A)

標準切削条件表 Recommended cutting conditions

5Dまで Up to 5D **03WHMB-TH** **05WHMB-TH**

直径 Tool dia. (mm)	切削条件 Cutting conditions	炭素鋼 Carbon steels SC材	合金鋼 Alloy steels SCM	ステンレス鋼 Stainless steels SUS304	ステンレス鋼 Stainless steels SUS630	アルミニウム合金 Aluminium alloys
1	切削速度 Cutting speed (vc) m/min	30~40~50	30~40~50	20~30~40	20~30~40	40~60~80
	回転数 Revolution (n) min ⁻¹	12,732	12,732	9,549	9,549	19,099
	送り量 Feed per rev (f) mm/rev	0.01~0.04	0.01~0.04	0.01~0.04	0.01~0.03	0.01~0.05
1.5	切削速度 Cutting speed (vc) m/min	30~40~50	30~40~50	20~30~40	20~30~40	40~60~80
	回転数 Revolution (n) min ⁻¹	8,488	8,488	6,366	6,366	12,732
	送り量 Feed per rev (f) mm/rev	0.015~0.06	0.015~0.06	0.015~0.06	0.015~0.045	0.015~0.075
2	切削速度 Cutting speed (vc) m/min	30~40~50	30~40~50	20~30~40	20~30~40	40~60~80
	回転数 Revolution (n) min ⁻¹	6,366	6,366	4,775	4,775	9,549
	送り量 Feed per rev (f) mm/rev	0.02~0.08	0.02~0.08	0.02~0.08	0.02~0.06	0.02~0.1

10D以上 10D or more **10WHMB-TH** **15WHMB-TH** **20WHMB-TH** **25WHMB-TH** **30WHMB-TH**

直径 Tool dia. (mm)	切削条件 Cutting conditions	炭素鋼 Carbon steels SC材	合金鋼 Alloy steels SCM	ステンレス鋼 Stainless steels SUS304	ステンレス鋼 Stainless steels SUS630	アルミニウム合金 Aluminium alloys
1	切削速度 Cutting speed (vc) m/min	30~40~50	30~40~50	20~30~40	20~30~40	30~40~60
	回転数 Revolution (n) min ⁻¹	12,732	12,732	9,549	9,549	12,732
	送り量 Feed per rev (f) mm/rev	0.01~0.03	0.01~0.03	0.01~0.03	0.01~0.015	0.01~0.04
1.5	切削速度 Cutting speed (vc) m/min	30~40~50	30~40~50	20~30~40	20~30~40	30~40~60
	回転数 Revolution (n) min ⁻¹	8,488	8,488	6,366	6,366	8,488
	送り量 Feed per rev (f) mm/rev	0.015~0.045	0.015~0.045	0.015~0.045	0.015~0.023	0.015~0.06
2	切削速度 Cutting speed (vc) m/min	30~40~50	30~40~50	20~30~40	20~30~40	30~40~60
	回転数 Revolution (n) min ⁻¹	6,366	6,366	4,775	4,775	6,366
	送り量 Feed per rev (f) mm/rev	0.02~0.06	0.02~0.06	0.02~0.06	0.02~0.03	0.02~0.08

切削条件の選定について Setting of cutting conditions

- ・この標準切削条件表は切削条件の目安を示すものです。実際の加工では加工形状、目的、使用機械などにより条件を調整してください。
- ・切削液は水溶性切削液を推奨致します。
- ・内部クーラント圧力は1.5MPa以上を推奨致します。(1.5MPa以下の場合ステップ加工を推奨)
- ・クーラントの穴詰まりを防止するために、メッシュフィルタ(3μm~5μm)をご使用ください。
- ・加工サイクルはG81を推奨致します。
- ・切りくずが排出されにくい場合は、工具径程度の長さでステップ加工ください。(G73,G83サイクル)
- ・工具装着の際は傷や汚れの無いコレットを用い、工具の振れは0.02mm以下を推奨致します。
- ・10Dタイプ以上の工具を使用する際は、下穴に3Dタイプを推奨致します。
- ・ロングドリル(10D以上)で加工する際は、vc=80m/min以下で加工ください。高速で工具を回転させると遠心力で折損する場合がございます。
- ・記載以外の被削材を加工される際はご相談ください。
- ・ This standard cutting condition table is for general guidance regarding cutting conditions. The conditions should be adjusted according to the machining shape, application, machine used, etc. for the actual machining.
- ・ For the cutting fluid, water-based cutting fluids are recommended.
- ・ Internal coolant pressure of 1.5MPa or higher is recommended. (When pressure is less than 1.5MPa, performing step machining is recommended.)
- ・ Use a mesh filter (3 μm to 5 μm) to prevent clogging of coolant hole.
- ・ G81 is recommended as the machining cycle.
- ・ When removal of chips is difficult, perform step machining of about the tool diameter. (G73, G83 cycle)
- ・ When mounting the tool, use of a collet without scratches or dirt and tool deflection of 0.02 mm or less is recommended.
- ・ When using 10D type or larger tools, it is recommended that a 3D type tool is used to create a pilot hole.
- ・ When performing machining using a long drill (10D or more), perform machining at vc=80 m/min. or less. If the tool is rotated at high speed, it may be broken by centrifugal force.

穴あけ工具
その後のドリル

○ ロングドリル(10Dタイプ以上)の加工方法 Machining method when using a long drill (10D type or longer)

1 O3WHMB-THで、工具径の3倍の深さを加工

Use O3WHMB-TH to machine a hole with a depth of 3 times the tool diameter.

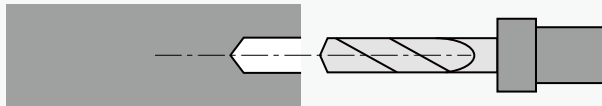

2 ロングドリルにて加工

※横型のM/C使用時は、進入時は低速回転 ($n=0\sim 500\text{min}^{-1}$)推奨

Machining using a long drill.

※When using a horizontal machine, low-speed rotation ($n=0$ to 500 min^{-1}) while advancing is recommended

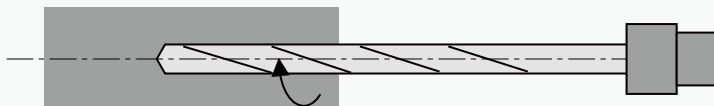

3 穴底で0.3秒のドゥエルを推奨

Dwelling at the bottom of the hole for 0.3 s is recommended.

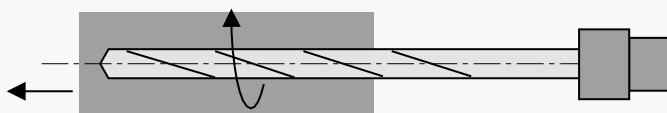

○ 切削事例 Field data

01 ステンレス鋼 (SUS304) の加工事例 【 $\phi 1.0\text{mm}$ 20D タイプ】

Stainless steel (SUS304) machining example [$\phi 1.0\text{mm}$, 20D type]

切削条件 Cutting condition

$v_c=30\text{m/min}$, $n=9,549\text{min}^{-1}$, $f=0.02\text{mm/rev}$, $v_f=190\text{mm/min}$,
穴深さ Hole depth = 18mm, 下穴深さ Pilot hole depth = 1mm,
ノンステップ加工 Non step machining, 水溶性切削液 Water base coolant,
内部クーラント圧 Internal coolant pressure 3MPa

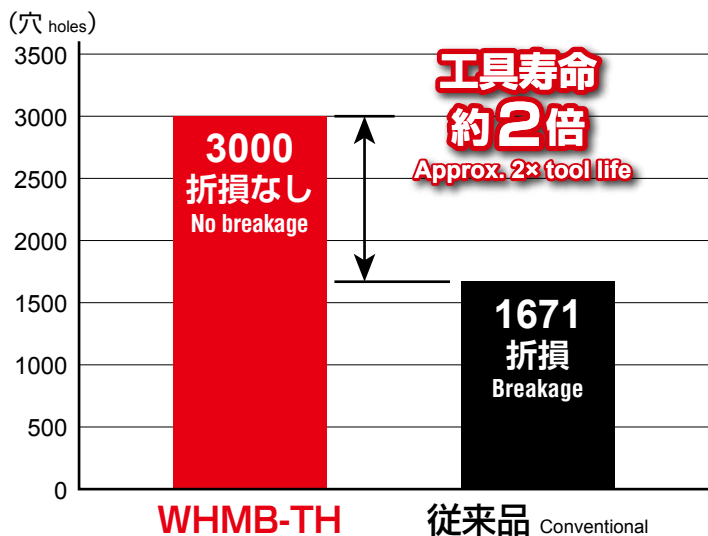

300穴加工後

After machining 300 holes



従来品 Conventional



1500穴加工後

After machining 1500 holes



従来品 Conventional



1500穴加工後もWHMBは刃先形状を維持

WHMB maintains the flute edge condition even after machining 1,500 holes.

エポックマイクロステップボーラーS



直径公差 0~-0.005 (mm)



鋼材用 非鉄用
MICRO TH SD

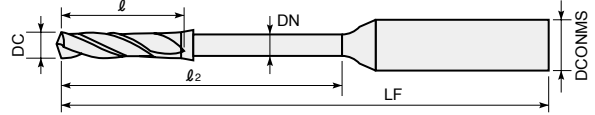

EMSBS○○○○-○○.○-TH/SD

商品コードの末尾にSDコーティング品は"-SD"を、THコーティング品は"-TH"を付けてください。
Indicate the desired coating type by adding "-SD" for SD coating or "-TH" for TH coating at the end of the item code.

切削条件表 E71
Cutting Conditions

商品コード Item code	THコーティング TH Coating	SDコーティング SD Coating	寸法 Size(mm)							希望小売価格(円) Suggested retail price(¥)
	在庫 Stock	在庫 Stock	直径 Tool dia.	溝長 Flute length	首下長 Under neck length	L/D	首径 Neck dia.	全長 Overall length	シャンク径 Shank dia.	
			DC	ℓ	ℓ ₂		DN	LF	DCONMS	
EMSBS0004-0.4-○○	●	□	0.04	0.2	0.4	10	0.033	40	3	14,480
EMSBS0004-0.8-○○	□	□	0.04	0.2	0.8	20	0.033	40	3	—
EMSBS0004-1.2-○○	●	□	0.04	0.2	1.2	30	0.033	40	3	60,710
EMSBS0005-0.5-○○	●	□	0.05	0.25	0.5	10	0.04	40	3	12,240
EMSBS0005-1-○○	●	□	0.05	0.25	1	20	0.04	40	3	22,440
EMSBS0005-1.5-○○	●	□	0.05	0.25	1.5	30	0.04	40	3	51,290
EMSBS0005-2-○○	□	□	0.05	0.25	2	40	0.04	40	3	—
EMSBS0005-2.5-○○	□	□	0.05	0.25	2.5	50	0.04	40	3	—
EMSBS0006-0.6-○○	●	□	0.06	0.3	0.6	10	0.05	40	3	11,170
EMSBS0006-1.2-○○	□	□	0.06	0.3	1.2	20	0.05	40	3	—
EMSBS0006-1.8-○○	●	□	0.06	0.3	1.8	30	0.05	40	3	47,360
EMSBS0006-2.4-○○	□	□	0.06	0.3	2.4	40	0.05	40	3	—
EMSBS0006-3-○○	□	□	0.06	0.3	3	50	0.05	40	3	—
EMSBS0007-0.7-○○	●	□	0.07	0.35	0.7	10	0.06	40	3	10,150
EMSBS0007-1.4-○○	□	□	0.07	0.35	1.4	20	0.06	40	3	—
EMSBS0007-2.1-○○	●	□	0.07	0.35	2.1	30	0.06	40	3	43,430
EMSBS0007-2.8-○○	□	□	0.07	0.35	2.8	40	0.06	40	3	—
EMSBS0007-3.5-○○	□	□	0.07	0.35	3.5	50	0.06	40	3	—
EMSBS0008-0.8-○○	●	□	0.08	0.4	0.8	10	0.07	40	3	8,570
EMSBS0008-1.6-○○	□	□	0.08	0.4	1.6	20	0.07	40	3	—
EMSBS0008-2.4-○○	●	□	0.08	0.4	2.4	30	0.07	40	3	35,580
EMSBS0008-3.2-○○	□	□	0.08	0.4	3.2	40	0.07	40	3	—
EMSBS0008-4-○○	□	□	0.08	0.4	4	50	0.07	40	3	—
EMSBS0009-0.9-○○	●	□	0.09	0.45	0.9	10	0.08	40	3	7,560
EMSBS0009-1.8-○○	□	□	0.09	0.45	1.8	20	0.08	40	3	—
EMSBS0009-2.7-○○	●	□	0.09	0.45	2.7	30	0.08	40	3	31,540
EMSBS0009-3.6-○○	□	□	0.09	0.45	3.6	40	0.08	40	3	—
EMSBS0009-4.5-○○	□	□	0.09	0.45	4.5	50	0.08	40	3	—
EMSBS0010-1-○○	●	□	0.1	0.5	1	10	0.09	45	3	5,880
EMSBS0010-2-○○	□	□	0.1	0.5	2	20	0.09	45	3	—
EMSBS0010-3-○○	●	□	0.1	0.5	3	30	0.09	45	3	25,700
EMSBS0010-5-○○	●	□	0.1	0.5	5	50	0.09	45	3	30,750
EMSBS0010-7.5-○○	□	□	0.1	0.5	7.5	75	0.09	45	3	—
EMSBS0010-10-○○	□	□	0.1	0.5	10	100	0.09	45	3	—
EMSBS0015-1.5-○○	●	□	0.15	0.75	1.5	10	0.14	50	3	5,880
EMSBS0015-3-○○	□	□	0.15	0.75	3	20	0.14	50	3	—
EMSBS0015-4.5-○○	●	□	0.15	0.75	4.5	30	0.14	50	3	23,690
EMSBS0015-7.5-○○	●	□	0.15	0.75	7.5	50	0.14	50	3	28,400
EMSBS0015-11.25-○○	□	□	0.15	0.75	11.25	75	0.14	50	3	—
EMSBS0015-15-○○	□	□	0.15	0.75	15	100	0.14	50	3	—
EMSBS0020-2-○○	●	□	0.2	1	2	10	0.19	45	3	5,880
EMSBS0020-4-○○	□	□	0.2	1	4	20	0.19	45	3	—
EMSBS0020-6-○○	●	□	0.2	1	6	30	0.19	45	3	21,660
EMSBS0020-10-○○	●	□	0.2	1	10	50	0.19	45	3	26,040
EMSBS0020-15-○○	□	□	0.2	1	15	75	0.19	55	3	—
EMSBS0020-20-○○	□	□	0.2	1	20	100	0.19	55	3	—
EMSBS0030-3-○○	●	□	0.3	1.5	3	10	0.28	45	3	5,880

首下長(ℓ₂)は貫通の加工穴深さに対応しています。Under-neck length (ℓ₂) conforms to through-hole drilling depth.

●印：標準在庫品です。□印：特定代理店在庫品です。弊社営業へお問い合わせください。
●：Stocked Items. □：Stocked by specified distributor. Contact with our sales department.

穴あけ工具
その他のドリル

EMSBS○○○○○-○○○-TH/SD

商品コードの末尾にSDコーティング品は“-SD”を、THコーティング品は“-TH”を付けてください。
Indicate the desired coating type by adding “-SD” for SD coating or “-TH” for TH coating at the end of the item code.

商品コード Item code	THコーティング TH Coating	SDコーティング SD Coating	寸法 Size(mm)							希望小売価格(円) Suggested retail price(¥)
	在庫 Stock	在庫 Stock	直径 Tool dia.	溝長 Flute length	首下長 Under neck length	L/D	首径 Neck dia.	全長 Overall length	シャンク径 Shank dia.	
			DC	ℓ	ℓ ₂		DN	LF	DCONMS	
EMSBS0030-6-○○○	□	□	0.3	1.5	6	20	0.28	45	3	—
EMSBS0030-9-○○○	●	□	0.3	1.5	9	30	0.28	45	3	21,660
EMSBS0030-15-○○○	●	□	0.3	1.5	15	50	0.28	55	3	26,040
EMSBS0030-22.5-○○○	□	□	0.3	1.5	22.5	75	0.28	65	3	—
EMSBS0030-30-○○○	□	□	0.3	1.5	30	100	0.28	65	3	—
EMSBS0040-4-○○○	●	□	0.4	2	4	10	0.38	50	3	5,030
EMSBS0040-8-○○○	□	□	0.4	2	8	20	0.38	50	3	—
EMSBS0040-12-○○○	●	□	0.4	2	12	30	0.38	50	3	21,660
EMSBS0040-20-○○○	●	□	0.4	2	20	50	0.38	60	3	26,040
EMSBS0040-30-○○○	□	□	0.4	2	30	75	0.38	75	3	—
EMSBS0040-40-○○○	□	□	0.4	2	40	100	0.38	75	3	—
EMSBS0050-5-○○○	●	□	0.5	2.5	5	10	0.48	50	3	5,030
EMSBS0050-10-○○○	□	□	0.5	2.5	10	20	0.48	50	3	—
EMSBS0050-15-○○○	●	□	0.5	2.5	15	30	0.48	50	3	19,760
EMSBS0050-25-○○○	●	□	0.5	2.5	25	50	0.48	65	3	23,690
EMSBS0050-37.5-○○○	□	□	0.5	2.5	37.5	75	0.48	85	3	—
EMSBS0050-50-○○○	□	□	0.5	2.5	50	100	0.48	85	3	—
EMSBS0060-6-○○○	●	□	0.6	3	6	10	0.57	55	3	5,030
EMSBS0060-12-○○○	□	□	0.6	3	12	20	0.57	55	3	—
EMSBS0060-18-○○○	●	□	0.6	3	18	30	0.57	55	3	19,760
EMSBS0060-30-○○○	●	□	0.6	3	30	50	0.57	75	3	23,690
EMSBS0060-45-○○○	□	□	0.6	3	45	75	0.57	95	3	—
EMSBS0060-60-○○○	□	□	0.6	3	60	100	0.57	95	3	—
EMSBS0070-7-○○○	●	□	0.7	3.5	7	10	0.67	60	4	5,030
EMSBS0070-14-○○○	□	□	0.7	3.5	14	20	0.67	60	4	—
EMSBS0070-21-○○○	●	□	0.7	3.5	21	30	0.67	60	4	19,760
EMSBS0070-35-○○○	●	□	0.7	3.5	35	50	0.67	80	4	23,690
EMSBS0070-52.5-○○○	□	□	0.7	3.5	52.5	75	0.67	105	4	—
EMSBS0070-70-○○○	□	□	0.7	3.5	70	100	0.67	105	4	—
EMSBS0080-8-○○○	●	□	0.8	4	8	10	0.76	60	4	4,320
EMSBS0080-16-○○○	□	□	0.8	4	16	20	0.76	60	4	—
EMSBS0080-24-○○○	●	□	0.8	4	24	30	0.76	60	4	19,760
EMSBS0080-40-○○○	●	□	0.8	4	40	50	0.76	85	4	23,690
EMSBS0080-60-○○○	□	□	0.8	4	60	75	0.76	115	4	—
EMSBS0080-80-○○○	□	□	0.8	4	80	100	0.76	115	4	—
EMSBS0090-9-○○○	●	□	0.9	4.5	9	10	0.85	65	4	4,320
EMSBS0090-18-○○○	□	□	0.9	4.5	18	20	0.85	65	4	—
EMSBS0090-27-○○○	●	□	0.9	4.5	27	30	0.85	65	4	19,760
EMSBS0090-45-○○○	●	□	0.9	4.5	45	50	0.85	90	4	23,690
EMSBS0090-67.5-○○○	□	□	0.9	4.5	67.5	75	0.85	125	4	—
EMSBS0090-90-○○○	□	□	0.9	4.5	90	100	0.85	125	4	—
EMSBS0100-10-○○○	●	□	1	5	10	10	0.95	70	4	4,320
EMSBS0100-20-○○○	□	□	1	5	20	20	0.95	70	4	—
EMSBS0100-30-○○○	●	□	1	5	30	30	0.95	70	4	19,760
EMSBS0100-50-○○○	●	□	1	5	50	50	0.95	100	4	23,690
EMSBS0100-75-○○○	□	□	1	5	75	75	0.95	135	4	—
EMSBS0100-100-○○○	□	□	1	5	100	100	0.95	135	4	—

首下長(ℓ₂)は貫通の加工穴深さに対応しています。Under-neck length(ℓ₂) conforms to through-hole drilling depth.

○ EMSBS-TH、EMSBS-SDの対応被削材

Applicable work material of EMSBS-TH, EMSBS-SD

コーティング Coating	軟鋼 Mild steel	炭素鋼 Carbon steel	合金鋼 Alloy steel	調質鋼 Heat-treated steel	工具鋼 Tool steel	焼入れ鋼 Hardened steel		ステンレス鋼 Stainless steel	耐熱鋼 Heat-resistant steel	鋳鉄 Cast iron	ダクタイル 鋳鉄 Ductile cast iron	アルミ 合金 Aluminum alloy	銅合金 Copper alloy
						SKD SKS	~40HRC						
TH	◎	○	◎	◎	◎	◎	○	◎	○	○	○	○	○
SD	○	○	○	○	○	○	○	○	○	○	○	◎	◎

○ 再研磨対応外径範囲

Re-grinding compatibility range

商品コード Item code	エンド End (mm)
EMSBS-TH	× (N/A)
EMSBS-SD	× (N/A)

エポックマイクロステップボーラーS

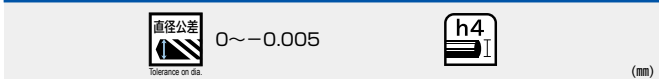

受注生産品

お客様に合った寸法をお届けできます。
 Manufactured upon request only.
 We can deliver the size to match customer needs.

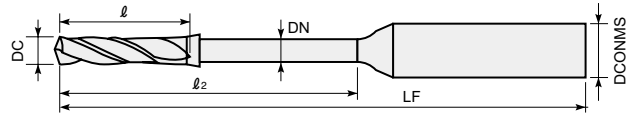

EMSBS ○○○○-○○-□□ ℓ_2 : 首下長さの指定 (B): コーティングの指定
 ℓ_2 : Designation of under neck length; (B) Designation of coating

切削条件表 **E71**
 Cutting Conditions

ご注文コード Order code	コーティングの種類 Kind of coating (B)	寸法 Size(mm)								
		ℓ_2 /DC	直径 Tool dia. DC	溝長 Flute length ℓ	首径 Neck dia. DN	首下長 Under neck length ℓ_2	全長 Overall length LF			シャンク径 Shank dia. DCONMS
							ℓ_2 /DC35未満 ℓ_2 /DC<35	ℓ_2 /DC65未満 ℓ_2 /DC<65	ℓ_2 /DC65以上 ℓ_2 /DC \geq 65	
EMSBS0004-(A)-(B)	TH/SD	30倍以下 Value of 30 or less	0.04	0.2	0.033	ご自由にご指定ください Value can be specified freely.	40			3
EMSBS0005-(A)-(B)	TH/SD	50倍以下 でご指定ください Value of 50 or less can be specified.	0.05	0.25	0.04		40			3
EMSBS0006-(A)-(B)	TH/SD		0.06	0.3	0.05		40			3
EMSBS0007-(A)-(B)	TH/SD		0.07	0.35	0.06		40			3
EMSBS0008-(A)-(B)	TH/SD		0.08	0.4	0.07		40			3
EMSBS0009-(A)-(B)	TH/SD		0.09	0.45	0.08		40			3
EMSBS0010-(A)-(B)	TH/SD	100倍以下 でご指定ください Value of 100 or less can be specified.	0.1	0.5	0.09		45			3
EMSBS0015-(A)-(B)	TH/SD		0.15	0.75	0.14		50			3
EMSBS0020-(A)-(B)	TH/SD		0.2	1	0.19		45	55	65	3
EMSBS0030-(A)-(B)	TH/SD		0.3	1.5	0.28		50	60	75	3
EMSBS0040-(A)-(B)	TH/SD		0.4	2	0.38	50	65	85	3	
EMSBS0050-(A)-(B)	TH/SD		0.5	2.5	0.48	55	75	95	3	
EMSBS0060-(A)-(B)	TH/SD		0.6	3	0.57	60	80	105	4	
EMSBS0070-(A)-(B)	TH/SD		0.7	3.5	0.67	60	85	115	4	
EMSBS0080-(A)-(B)	TH/SD		0.8	4	0.76	65	90	125	4	
EMSBS0090-(A)-(B)	TH/SD		0.9	4.5	0.85	70	100	135	4	
EMSBS0100-(A)-(B)	TH/SD	1	5	0.95						

L/Dの違いによる切削条件比率 Ratio to cutting conditions for different L/D
 次頁に記載しているL/D=10の切削条件を基準として、下記比率に従って切削条件を調整してください (比率にて記載)
 Adjust cutting conditions according to the following ratios based on the cutting conditions for L/D=10 on next page.

L/D	回転数 Revolution	送り速度 Feed rate	ステップ量 Step
20倍以下	100%	100%	100%
30倍以下	100%	100%	100%
40倍以下	90%	90%	100%
50倍以下	80%	80%	100%
60倍以下	65%	65%	100%

L/D	回転数 Revolution	送り速度 Feed rate	ステップ量 Step
70倍以下	55%	55%	100%
80倍以下	40%	40%	100%
90倍以下	35%	35%	100%
100倍以下	30%	30%	100%

ご注文方法 Ordering method

首下長さ及びコーティングは用途に合わせて自由に選んで頂けます。
 The under neck length and coating can be freely selected according to the application.

首下長さの選択方法
 Selecting under neck length

(穴深さ+工具径)を目安にして首下長さをご指定ください。
 Please specify the below-neck length using (hole depth + tool diameter) as criteria.

コーティングの選択方法
 Selecting coating

基本的に非鉄系にはSDを、その他の材料にはTHを推奨します。
 In general, SD should be selected for non-ferrous materials, and TH should be selected for other materials.

【例1】 例えば、穴径が ϕ 0.3、穴深さが15でSUS304に穴あけを行う場合、工具直径は ϕ 0.3、首下長さは15.3
 Example 1 (穴深さ+工具径)の工具をご指定ください。
 For example, when drilling a hole in SUS304 that is ϕ 0.3mm in diameter with a depth of 15mm, specify a tool with a diameter of ϕ 0.3mm and a below-neck length of 15.3mm (hole depth + tool diameter).

ご注文コード Order code : **EMSBS0030-15.3-TH**

(注) 上記以外の工具寸法品に関しては、別途ご相談に応じます。弊社営業にお問い合わせ下さい。
 (Note) For products with tool dimensions other than those listed above, separate consultation is needed. Please contact our sales office.

標準切削条件表 Recommended cutting conditions **EMSBS-TH** **EMSBS-SD**

商品コード Item Code	直径 Tool dia. (mm)	首下長 Under neck length (mm)	L/D	1			2			3			4			5		
				アルミ・樹脂 アクリル Aluminium, Resin, Acrylic			炭素鋼 Carbon steels (180~250HB)			ステンレス鋼 Stainless steels (25~35HRC)			プリハードン鋼 Pre-hardened steels (35~45HRC)			焼入れ鋼 Hardened steels (45~55HRC)		
				回転数 n min ⁻¹	送り速度 Vf mm/min	ステップ 量(mm) Step feed	回転数 n min ⁻¹	送り速度 Vf mm/min	ステップ 量(mm) Step feed	回転数 n min ⁻¹	送り速度 Vf mm/min	ステップ 量(mm) Step feed	回転数 n min ⁻¹	送り速度 Vf mm/min	ステップ 量(mm) Step feed	回転数 n min ⁻¹	送り速度 Vf mm/min	ステップ 量(mm) Step feed
EMSBS0004-0.4-000	0.04	0.4	10	39,789	80	0.004	35,810	72	0.004	31,831	64	0.004	27,852	56	0.0028	23,873	24	0.002
EMSBS0004-1.2-000	0.04	1.2	30	39,789	80	0.004	35,810	72	0.004	31,831	64	0.004	27,852	56	0.0028	23,873	24	0.002
EMSBS0005-0.5-000	0.05	0.5	10	38,197	76	0.005	31,831	64	0.005	28,648	57	0.005	25,465	51	0.0035	22,282	22	0.0025
EMSBS0005-1-000	0.05	1	20	38,197	76	0.005	31,831	64	0.005	28,648	57	0.005	25,465	51	0.0035	22,282	22	0.0025
EMSBS0005-1.5-000	0.05	1.5	30	38,197	76	0.005	25,465	51	0.005	22,918	46	0.005	20,372	41	0.0035	17,825	18	0.0025
EMSBS0006-0.6-000	0.06	0.6	10	37,136	74	0.006	29,178	58	0.006	26,526	53	0.006	23,873	48	0.0042	21,221	21	0.003
EMSBS0006-1.8-000	0.06	1.8	30	37,136	74	0.006	29,178	58	0.006	26,526	53	0.006	23,873	48	0.0042	21,221	21	0.003
EMSBS0007-0.7-000	0.07	0.7	10	36,378	73	0.007	27,284	55	0.007	25,010	50	0.007	22,736	45	0.0049	20,463	20	0.0035
EMSBS0007-2.1-000	0.07	2.1	30	36,378	73	0.007	27,284	55	0.007	25,010	50	0.007	22,736	45	0.0049	20,463	20	0.0035
EMSBS0008-0.8-000	0.08	0.8	10	35,810	72	0.008	27,852	56	0.008	25,863	52	0.008	23,873	48	0.0056	21,884	22	0.004
EMSBS0008-2.4-000	0.08	2.4	30	35,810	72	0.008	27,852	56	0.008	25,863	52	0.008	23,873	48	0.0056	21,884	22	0.004
EMSBS0009-0.9-000	0.09	0.9	10	35,368	71	0.009	26,526	53	0.009	24,757	50	0.009	22,989	46	0.0063	21,221	21	0.0045
EMSBS0009-2.7-000	0.09	2.7	30	35,368	71	0.009	26,526	53	0.009	24,757	50	0.009	22,989	46	0.0063	21,221	21	0.0045
EMSBS0010-1-000	0.1	1	10	35,014	105	0.01	25,465	76	0.01	23,873	72	0.01	22,282	67	0.007	20,690	41	0.005
EMSBS0010-3-000	0.1	3	30	35,014	105	0.01	25,465	76	0.01	23,873	72	0.01	22,282	67	0.007	20,690	41	0.005
EMSBS0010-5-000	0.1	5	50	28,011	84	0.01	20,372	61	0.01	19,099	57	0.01	17,825	53	0.007	16,552	33	0.005
EMSBS0015-1.5-000	0.15	1.5	10	25,465	76	0.015	23,343	70	0.015	21,221	64	0.015	20,160	60	0.0105	19,099	38	0.0075
EMSBS0015-4.5-000	0.15	4.5	30	25,465	76	0.015	23,343	70	0.015	21,221	64	0.015	20,160	60	0.0105	19,099	38	0.0075
EMSBS0015-7.5-000	0.15	7.5	50	20,372	61	0.015	18,674	56	0.015	16,977	51	0.015	16,128	48	0.0105	15,279	31	0.0075
EMSBS0020-2-000	0.2	2	10	23,873	95	0.02	20,690	83	0.02	19,099	76	0.02	17,507	70	0.014	16,711	50	0.01
EMSBS0020-6-000	0.2	6	30	23,873	95	0.02	20,690	83	0.02	19,099	76	0.02	17,507	70	0.014	16,711	50	0.01
EMSBS0020-10-000	0.2	10	50	19,099	76	0.02	16,552	66	0.02	15,279	61	0.02	14,006	56	0.014	13,369	40	0.01
EMSBS0030-3-000	0.3	3	10	15,915	64	0.03	14,854	59	0.03	13,793	55	0.03	12,732	51	0.021	12,202	37	0.015
EMSBS0030-9-000	0.3	9	30	15,915	64	0.03	14,854	59	0.03	13,793	55	0.03	12,732	51	0.021	12,202	37	0.015
EMSBS0030-15-000	0.3	15	50	12,732	51	0.03	11,884	48	0.03	11,035	44	0.03	10,186	41	0.021	9,762	29	0.015
EMSBS0040-4-000	0.4	4	10	13,528	54	0.04	12,335	49	0.04	11,937	48	0.04	11,539	46	0.028	10,743	43	0.02
EMSBS0040-12-000	0.4	12	30	13,528	54	0.04	12,335	49	0.04	11,937	48	0.04	11,539	46	0.028	10,743	43	0.02
EMSBS0040-20-000	0.4	20	50	10,823	43	0.04	9,868	39	0.04	9,549	38	0.04	9,231	37	0.028	8,594	34	0.02
EMSBS0050-5-000	0.5	5	10	10,823	54	0.05	9,868	49	0.05	9,549	48	0.05	9,231	46	0.035	8,594	43	0.025
EMSBS0050-15-000	0.5	15	30	10,823	54	0.05	9,868	49	0.05	9,549	48	0.05	9,231	46	0.035	8,594	43	0.025
EMSBS0050-25-000	0.5	25	50	8,658	43	0.05	7,894	39	0.05	7,639	38	0.05	7,385	37	0.035	6,875	34	0.025
EMSBS0060-6-000	0.6	6	10	9,019	54	0.06	8,223	49	0.06	7,958	48	0.06	7,692	46	0.042	7,162	43	0.03
EMSBS0060-18-000	0.6	18	30	9,019	54	0.06	8,223	49	0.06	7,958	48	0.06	7,692	46	0.042	7,162	43	0.03
EMSBS0060-30-000	0.6	30	50	7,215	43	0.06	6,578	39	0.06	6,366	38	0.06	6,154	37	0.042	5,730	34	0.03
EMSBS0070-7-000	0.7	7	10	7,730	54	0.07	7,048	49	0.07	6,821	48	0.07	6,594	46	0.049	6,139	43	0.035
EMSBS0070-21-000	0.7	21	30	7,730	54	0.07	7,048	49	0.07	6,821	48	0.07	6,594	46	0.049	6,139	43	0.035
EMSBS0070-35-000	0.7	35	50	6,184	43	0.07	5,639	39	0.07	5,457	38	0.07	5,275	37	0.049	4,911	34	0.035
EMSBS0080-8-000	0.8	8	10	6,764	54	0.08	6,167	49	0.08	5,968	48	0.08	5,769	46	0.056	5,371	43	0.04
EMSBS0080-24-000	0.8	24	30	6,764	54	0.08	6,167	49	0.08	5,968	48	0.08	5,769	46	0.056	5,371	43	0.04
EMSBS0080-40-000	0.8	40	50	5,411	43	0.08	4,934	39	0.08	4,775	38	0.08	4,615	37	0.056	4,297	34	0.04
EMSBS0090-9-000	0.9	9	10	6,013	54	0.09	5,482	49	0.09	5,305	48	0.09	5,128	46	0.063	4,775	43	0.045
EMSBS0090-27-000	0.9	27	30	6,013	54	0.09	5,482	49	0.09	5,305	48	0.09	5,128	46	0.063	4,775	43	0.045
EMSBS0090-45-000	0.9	45	50	4,810	43	0.09	4,386	39	0.09	4,244	38	0.09	4,103	37	0.063	3,820	34	0.045
EMSBS0100-10-000	1	10	10	5,411	54	0.1	4,934	49	0.1	4,775	48	0.1	4,615	46	0.07	4,297	43	0.05
EMSBS0100-30-000	1	30	30	5,411	54	0.1	4,934	49	0.1	4,775	48	0.1	4,615	46	0.07	4,297	43	0.05
EMSBS0100-50-000	1	50	50	4,329	43	0.1	3,947	39	0.1	3,820	38	0.1	3,692	37	0.07	3,438	34	0.05

- この標準切削条件表は切削条件の目安を示すものです。実際の加工では加工形状、目的、使用機械等により条件を調整してください。
 - 切りくず排出のため、基本的には水溶性または油性クーラントをご使用ください。
 - 必ずG83(ペックドリリングサイクル)にてご使用ください。
 - 首下長(L₂)は貫通の加工穴深さに対応しています。
 - 貫通穴を加工する場合、工具先端から直径の20%以上~30%以下の深さまで貫通してください。
- 【例】ワーク板厚：T=4mm 工具：φ0.5x首下長5mmの場合
加工深さ：4.14mm(工具先端より)

- This standard cutting condition table is intended as reference cutting conditions. The conditions should be adjusted as necessary according to the actual conditions of machined shape, purpose, machine used, etc.
- In general, water-soluble or oil-based coolant should be used to ensure chip removal.
- Always use with a G83 program (Peck drilling cycle).
- Under-neck length (L₂) conforms to through-hole drilling depth.
- When drilling through holes, drill the through hole to a depth of between 20% and 30% of the diameter from the tip of the tool.
Ex.: For work thickness T=4mm and tool= Ø0.5x under neck length 5mm, drilling depth should be 4.14mm (from tip of tool).

エポックマイクロスター



直径公差 : DC<0.2 : -0.005~-0.01mm シャンク径公差 : φ3 : 0~-0.003mm
Tolerance on dia. DC≥0.2 : -0.005~-0.015mm Tolerance on shank φ4 : 0~-0.005mm

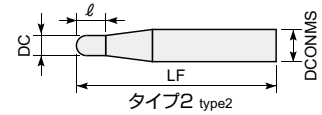
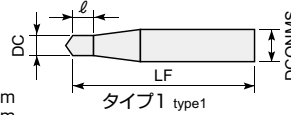

EMST-TH



商品コード Item code	在庫 Stock	寸法 Size(mm)				形状 Shape	希望小売 価格(円) Suggested retail price (¥)
		直径 Tool dia.	溝長 Flute length	全長 Overall length	シャンク径 Shank dia.		
		DC	ℓ	LF	DCONMS		
EMST0004-TH	●	0.04	0.04	45	3	タイプ1	23,570
EMST0005-TH	●	0.05	0.05	45	3	タイプ1	20,990
EMST0006-TH	●	0.06	0.06	45	3	タイプ1	18,300
EMST0007-TH	●	0.07	0.07	45	3	タイプ1	14,030
EMST0008-TH	●	0.08	0.08	45	3	タイプ1	12,800
EMST0009-TH	●	0.09	0.09	45	3	タイプ1	11,220
EMST0010-TH	●	0.1	0.1	45	3	タイプ1	10,660
EMST0011-TH	●	0.11	0.11	45	3	タイプ1	11,570
EMST0012-TH	●	0.12	0.12	45	3	タイプ1	11,570
EMST0013-TH	●	0.13	0.13	45	3	タイプ1	11,570
EMST0014-TH	●	0.14	0.14	45	3	タイプ1	11,570
EMST0015-TH	●	0.15	0.15	45	3	タイプ1	10,660
EMST0016-TH	●	0.16	0.16	45	3	タイプ1	11,570
EMST0017-TH	●	0.17	0.17	45	3	タイプ2	11,570
EMST0018-TH	●	0.18	0.18	45	3	タイプ2	11,570
EMST0019-TH	●	0.19	0.19	45	3	タイプ2	11,570
EMST0020-TH	●	0.2	0.2	45	3	タイプ2	9,770
EMST0021-TH	□	0.21	0.21	45	3	タイプ2	-
EMST0029-TH	□	0.29	0.29	45	3	タイプ2	-
EMST0030-TH	●	0.3	0.3	45	3	タイプ2	8,560
EMST0031-TH	□	0.31	0.31	45	3	タイプ2	-

商品コード Item code	在庫 Stock	寸法 Size(mm)				形状 Shape	希望小売 価格(円) Suggested retail price (¥)
		直径 Tool dia.	溝長 Flute length	全長 Overall length	シャンク径 Shank dia.		
		DC	ℓ	LF	DCONMS		
EMST0039-TH	□	0.39	0.39	45	3	タイプ2	-
EMST0040-TH	●	0.4	0.4	45	3	タイプ2	8,560
EMST0041-TH	□	0.41	0.41	45	3	タイプ2	-
EMST0049-TH	□	0.49	0.49	45	3	タイプ2	-
EMST0050-TH	●	0.5	0.5	45	3	タイプ2	8,560
EMST0051-TH	□	0.51	0.51	45	3	タイプ2	-
EMST0059-TH	□	0.59	0.59	45	3	タイプ2	-
EMST0060-TH	●	0.6	0.6	45	3	タイプ2	8,560
EMST0061-TH	□	0.61	0.61	45	3	タイプ2	-
EMST0069-TH	□	0.69	0.69	45	4	タイプ2	-
EMST0070-TH	●	0.7	0.7	45	4	タイプ2	8,560
EMST0071-TH	□	0.71	0.71	45	4	タイプ2	-
EMST0079-TH	□	0.79	0.79	45	4	タイプ2	-
EMST0080-TH	●	0.8	0.8	45	4	タイプ2	8,560
EMST0081-TH	□	0.81	0.81	45	4	タイプ2	-
EMST0089-TH	□	0.89	0.89	45	4	タイプ2	-
EMST0090-TH	●	0.9	0.9	45	4	タイプ2	8,560
EMST0091-TH	□	0.91	0.91	45	4	タイプ2	-
EMST0099-TH	□	0.99	0.99	45	4	タイプ2	-
EMST0100-TH	●	1	1	45	4	タイプ2	8,560
EMST0101-TH	□	1.01	1.01	45	4	タイプ2	-

標準切削条件表 Recommended cutting conditions

EMST-TH

商品コード Item Code	直径 Tool dia. (mm)	加工穴 深さ Drilling hole depth (mm)	アルミ・樹脂 Aluminium, Resin			炭素鋼 Carbon steels (180~250HB)			ステンレス鋼 Stainless steels (25~35HRC)			プリハードン鋼 Pre-hardened steels (35~45HRC)			焼入れ鋼 Hardened steels (45~55HRC)		
			回転数 n min ⁻¹	送り速度 vf mm/min	ステップ 量(mm) Step feed	回転数 n min ⁻¹	送り速度 vf mm/min	ステップ 量(mm) Step feed	回転数 n min ⁻¹	送り速度 vf mm/min	ステップ 量(mm) Step feed	回転数 n min ⁻¹	送り速度 vf mm/min	ステップ 量(mm) Step feed	回転数 n min ⁻¹	送り速度 vf mm/min	ステップ 量(mm) Step feed
EMST0004-TH	0.04	0.024	39,789	20	0.001	35,810	18	0.001	31,831	16	0.001	27,852	14	0.001	23,873	6	0.001
EMST0005-TH	0.05	0.03	38,197	19	0.001	31,831	16	0.001	28,648	14	0.001	25,465	13	0.001	22,282	6	0.001
EMST0006-TH	0.06	0.036	37,136	19	0.002	29,178	15	0.002	26,526	13	0.002	23,873	12	0.001	21,221	5	0.001
EMST0007-TH	0.07	0.042	36,378	18	0.002	27,284	14	0.002	25,010	13	0.002	22,736	11	0.001	20,463	5	0.001
EMST0008-TH	0.08	0.048	35,810	18	0.002	27,852	14	0.002	25,863	13	0.002	23,873	12	0.001	21,884	5	0.001
EMST0009-TH	0.09	0.054	35,368	18	0.002	26,526	13	0.002	24,757	12	0.002	22,989	11	0.002	21,221	5	0.001
EMST0010-TH	0.1	0.06	35,014	26	0.003	25,465	19	0.003	23,873	18	0.003	22,282	17	0.002	20,690	10	0.001
EMST0015-TH	0.15	0.09	25,465	19	0.004	23,343	18	0.004	21,221	16	0.004	20,160	15	0.003	19,099	10	0.002
EMST0020-TH	0.2	0.12	23,873	24	0.005	20,690	21	0.005	19,099	19	0.005	17,507	18	0.004	16,711	13	0.003
EMST0030-TH	0.3	0.18	15,915	16	0.008	14,854	15	0.008	13,793	14	0.008	12,732	13	0.005	12,202	9	0.004
EMST0040-TH	0.4	0.24	13,528	14	0.010	12,335	12	0.010	11,937	12	0.010	11,539	12	0.007	10,743	11	0.005
EMST0050-TH	0.5	0.3	10,823	14	0.013	9,868	12	0.013	9,549	12	0.013	9,231	12	0.009	8,594	11	0.006
EMST0060-TH	0.6	0.36	9,019	14	0.015	8,223	12	0.015	7,958	12	0.015	7,692	12	0.011	7,162	11	0.008
EMST0070-TH	0.7	0.42	7,730	14	0.018	7,048	12	0.018	6,821	12	0.018	6,594	12	0.012	6,139	11	0.009
EMST0080-TH	0.8	0.48	6,764	14	0.020	6,167	12	0.020	5,968	12	0.020	5,769	12	0.014	5,371	11	0.010
EMST0090-TH	0.9	0.54	6,013	14	0.023	5,482	12	0.023	5,305	12	0.023	5,128	12	0.016	4,775	11	0.011
EMST0100-TH	1	0.6	5,411	14	0.025	4,934	12	0.025	4,775	12	0.025	4,615	12	0.018	4,297	11	0.013

- この標準切削条件表は切削条件の目安を示すものです。実際の加工では加工形状、目的、使用機械等により条件を調整してください。
- 切りくず排出のため、基本的には水溶性または油性クーラントをご使用ください。
- 必ずG83(ペックドリリングサイクル)にてご使用ください。
- 加工深さ：直径の60%深さまで必ず入れてください。(例：φ0.1の時、0.06mm)

- These Recommended Cutting Conditions indicate only the rule of a thumb for the cutting conditions. In actual machining, the condition should be adjusted according to the machining shape, purpose and the machine type.
- In general, water-soluble or oil-based coolant should be used to ensure chip removal.
- Always use with a G83 program (Peck drilling cycle).
- Hole depth: Be sure to drill to a depth of 60% of the diameter. (Ex.: For φ0.1, depth=0.06mm)

対応被削材 Applicable work materia

軟鋼 Mild steel SS	炭素鋼 Carbon steel S〇〇C	合金鋼 Alloy steel SCM, SCr	調質鋼 Heat-treated steel SKD SKS	工具鋼 Tool steel ~40HRC	焼入れ鋼 Hardened steel ~45HRC 45HRC~	ステン レス鋼 Stainless steel SUS	耐熱鋼 Ti合金 Heat-resistant steel, Ti alloy Inconel	鋳鉄 Cast iron FC	ダクタイル 鋳鉄 Ductile cast iron FCD	アルミ 合金 Aluminum alloy Al	銅合金 Copper alloy Cu
------------------------	--------------------------------	-----------------------------------	--	-----------------------------	---	---	---	-----------------------	--	--------------------------------------	------------------------------

再研磨対応外径範囲 Re-grinding compatibility range

商品コード Item code	エンド End (mm)
EMST	× (N/A)

●印：標準在庫品です。●：Stocked items。□印：特定代理店在庫です。弊社営業へお問い合わせください。□：Stocked by specified distributor. Contact with our sales department.

○ エポックマイクロステップボーラーの使用法

How to use Epoch Micro Step Borer

● 加工時の注意点

Caution points when machining

< 下穴ドリルについて >

About pilot holes

専用スターターのご使用をお奨めします。

※特に高精度な穴あけを行う場合は専用スターターをご使用ください。

必ず G83 プログラムによるステップ加工を行ってください。

穴深さ：直径の60%深さまで必ず入れてください（例：φ0.1の時は、0.06mm）

Use of the special starter is recommended. * Particularly when drilling high-accuracy holes, please use the special starter. Always perform step drilling using a G83 program. Hole depth: Be sure to drill to a depth of 60% of the diameter. (Ex.: For $\phi 0.1$, depth=0.06mm)

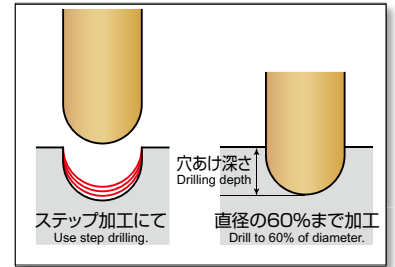

< クーラントについて >

About coolants

基本的には油性 or 水溶性クーラントを推奨します。

この時、クーラントが刃先に当たるように設定してください。

In general, oil-based or water-soluble coolants are recommended. When using, set it up so that the coolant hits the flute tips.

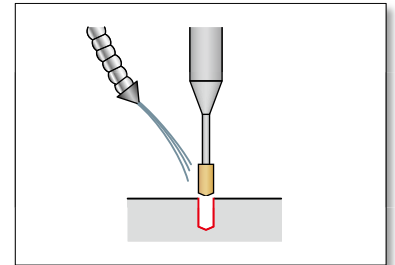

< 加工プログラムについて >

About machining programs

必ず G83 (ペックドリリングサイクル) にて加工を行ってください。

推奨リファレンス位置：0.05~0.1 mm

尚、50Dを超える場合は、ワーク上面より直径の30%分下の位置に設定してください。

（例：φ1×首下長 100mm のリファレンス位置 = -0.3mm）

推奨アプローチ距離：0.05mm

※機械のパラメータ設定画面にて変更ください。この数値が大きいと加工時間が長くなる可能性があります。

Always perform drilling using a G83 program (Peck drilling cycle).

Recommended reference position: 0.05 to 0.1 mm

However, for aspect ratios of greater than 50D, the position should be set as 30% of the tool diameter below the surface of the work. (Ex.: For $\phi 1 \times 100$ mm below-neck length, reference position = -0.3mm)

Recommended approach distance: 0.05mm

*Change according to the machine parameter setting screen. If these values are large, machining time may become longer.

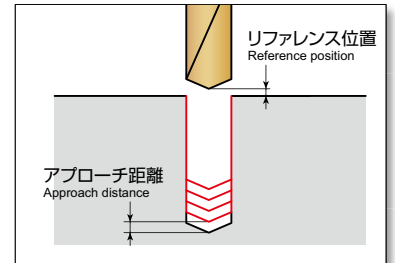

< 早送り速度について >

About fast feed rates

首下長が長い場合、早送り速度が速すぎると折損する場合があります。

推奨：20m/min 以下（30D 以上：5m/min 以下）

When the below-neck length is long, if the fast feed rate is too fast, bit may be broken.

Recommended: 20m/min. or less (for greater than 30D, 5m/min. or less)

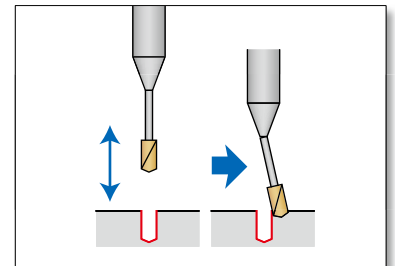

< 30D 以上の深さで精度を重視する場合 >

When focusing on accuracy for hole depths of 30D or greater

スターターの加工の後に 10D を入れてから加工すると、更に加工精度が向上します。

50D を超える場合は、必ず 10D を入れてから加工してください。

Drilling accuracy can be further improved by inserting 10D before drilling after drilling with a starter.

For aspect ratios of greater than 50D, always insert 10D before starting drilling.

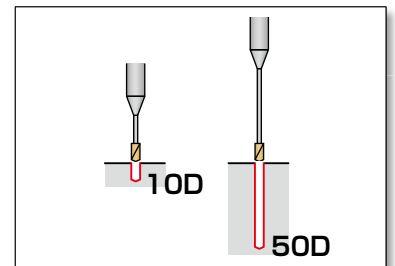

エポックマイクロステップボーラーH



+0.006~+0.001



(mm)

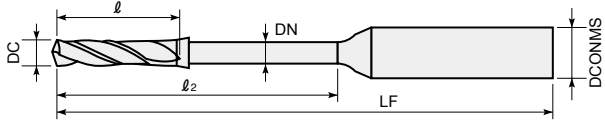

EMS BH ○○○○-ATH

切削条件表 E76

商品コード Item code	在庫 Stock	寸法 Size(mm)					希望小売 価格(円) Suggested retail price (¥)	
		直径 Tool dia. DC	溝長 Flute length l	首下長 Under neck length l ₂	首径 Neck dia. DN	全長 Overall length LF		シャンク径 Shank dia. DCONMS
EMS BH0010-1-ATH	●			1.0			5,880	
EMS BH0010-2-ATH	●	0.1	0.50	2.0	0.09	45	3.0	11,210
EMS BH0010-3-ATH	●			3.0				25,700
EMS BH0011-1-ATH	□			1.0				-
EMS BH0011-2-ATH	□	0.11	0.55	2.0	0.1	45	3.0	-
EMS BH0011-3-ATH	□			3.0				-
EMS BH0012-1-ATH	□			1.0				-
EMS BH0012-2-ATH	□	0.12	0.60	2.0	0.11	45	3.0	-
EMS BH0012-3-ATH	□			3.0				-
EMS BH0015-1.5-ATH	□			1.5				-
EMS BH0015-3-ATH	□	0.15	0.75	3.0	0.14	45	3.0	-
EMS BH0015-4.5-ATH	□			4.5				-
EMS BH0020-2-ATH	●			2.0				5,880
EMS BH0020-4-ATH	●	0.2	1.00	4.0	0.19	45	3.0	9,490
EMS BH0020-6-ATH	●			6.0				21,660
EMS BH0021-2-ATH	□			2.0				-
EMS BH0021-4-ATH	□	0.21	1.05	4.0	0.19	45	3.0	-
EMS BH0021-6-ATH	□			6.0				-
EMS BH0022-2-ATH	□			2.0				-
EMS BH0022-4-ATH	□	0.22	1.10	4.0	0.2	45	3.0	-
EMS BH0022-6-ATH	□			6.0				-
EMS BH0030-3-ATH	●			3.0				5,880
EMS BH0030-6-ATH	●	0.3	1.5	6.0	0.28	45	3.0	9,490
EMS BH0030-9-ATH	●			9.0				21,660
EMS BH0031-3-ATH	□			3.0				-
EMS BH0031-6-ATH	□	0.31	1.5	6.0	0.29	45	3.0	-
EMS BH0031-9-ATH	□			9.0				-
EMS BH0032-3-ATH	□			3.0				-
EMS BH0032-6-ATH	□	0.32	1.5	6.0	0.3	45	3.0	-
EMS BH0032-9-ATH	□			9.0				-
EMS BH0040-4-ATH	●			4.0				5,030
EMS BH0040-8-ATH	●	0.4	2.0	8.0	0.38	50	3.0	9,490
EMS BH0040-12-ATH	●			12.0				21,660

商品コード Item code	在庫 Stock	寸法 Size(mm)					希望小売 価格(円) Suggested retail price (¥)	
		直径 Tool dia. DC	溝長 Flute length l	首下長 Under neck length l ₂	首径 Neck dia. DN	全長 Overall length LF		シャンク径 Shank dia. DCONMS
EMS BH0041-4-ATH	□			4.0				-
EMS BH0041-8-ATH	□	0.41	2.0	8.0	0.39	50	3.0	-
EMS BH0041-12-ATH	□			12.0				-
EMS BH0042-4-ATH	□			4.0				-
EMS BH0042-8-ATH	□	0.42	2.0	8.0	0.4	50	3.0	-
EMS BH0042-12-ATH	□			12.0				-
EMS BH0050-5-ATH	●			5.0				5,030
EMS BH0050-10-ATH	●	0.5	2.5	10.0	0.48	50	3.0	8,640
EMS BH0050-15-ATH	●			15.0				19,760
EMS BH0051-5-ATH	□			5.0				-
EMS BH0051-10-ATH	□	0.51	2.5	10.0	0.48	50	3.0	-
EMS BH0051-15-ATH	□			15.0				-
EMS BH0052-5-ATH	□			5.0				-
EMS BH0052-10-ATH	□	0.52	2.5	10.0	0.49	50	3.0	-
EMS BH0052-15-ATH	□			15.0				-
EMS BH0060-6-ATH	●			6.0				5,030
EMS BH0060-12-ATH	●	0.6	3.0	12.0	0.57	55	3.0	8,640
EMS BH0060-18-ATH	●			18.0				19,760
EMS BH0061-6-ATH	□			6.0				-
EMS BH0061-12-ATH	□	0.61	3.0	12.0	0.58	55	3.0	-
EMS BH0061-18-ATH	□			18.0				-
EMS BH0062-6-ATH	□			6.0				-
EMS BH0062-12-ATH	□	0.62	3.0	12.0	0.59	55	3.0	-
EMS BH0062-18-ATH	□			18.0				-
EMS BH0070-7-ATH	●			7.0				5,030
EMS BH0070-14-ATH	●	0.7	3.5	14.0	0.67	60	4.0	8,640
EMS BH0070-21-ATH	●			21.0				19,760
EMS BH0071-7-ATH	□			7.0				-
EMS BH0071-14-ATH	□	0.71	3.5	14.0	0.67	60	4.0	-
EMS BH0071-21-ATH	□			21.0				-
EMS BH0072-7-ATH	□			7.0				-
EMS BH0072-14-ATH	□	0.72	3.5	14.0	0.68	60	4.0	-
EMS BH0072-21-ATH	□			21.0				-

(注) 上記以外の工具寸法品に関しては、別途ご相談に応じます。弊社営業にお問い合わせ下さい。
 (Note) For products with tool dimensions other than those listed above, separate consultation is needed. Please contact to sales office.

●印：標準在庫品です。 □印：特定代理店在庫です。弊社営業へお問い合わせください。
 ●：Stocked items. □：Stocked by specified distributor. Contact to sales office.

穴あけ工具

その後のメンテナンス

EMSBH○○○○-○○-ATH

商品コード Item code	在庫 Stock	寸法 Size(mm)						希望小売 価格(円) Suggested retail price (¥)
		直径 Tool dia.	溝長 Flute length	首下長 Under neck length	首径 Neck dia.	全長 Overall length	シャンク径 Shank dia.	
		DC	ℓ	ℓ ₂	DN	LF	DCONMS	
EMSBH0080-8-ATH	●			8.0				4,320
EMSBH0080-16-ATH	●	0.8	4.0	16.0	0.76	60	4.0	8,640
EMSBH0080-24-ATH	●			24.0				19,760
EMSBH0081-8-ATH	□			8.0				-
EMSBH0081-16-ATH	□	0.81	4.0	16.0	0.76	60	4.0	-
EMSBH0081-24-ATH	□			24.0				-
EMSBH0082-8-ATH	□			8.0				-
EMSBH0082-16-ATH	□	0.82	4.0	16.0	0.77	60	4.0	-
EMSBH0082-24-ATH	□			24.0				-
EMSBH0090-9-ATH	●			9.0				4,320
EMSBH0090-18-ATH	●	0.9	4.5	18.0	0.85	65	4.0	8,640
EMSBH0090-27-ATH	●			27.0				19,760
EMSBH0091-9-ATH	□			9.0				-
EMSBH0091-18-ATH	□	0.91	4.5	18.0	0.86	65	4.0	-
EMSBH0091-27-ATH	□			27.0				-
EMSBH0092-9-ATH	□			9.0				-
EMSBH0092-18-ATH	□	0.92	4.5	18.0	0.87	65	4.0	-
EMSBH0092-27-ATH	□			27.0				-
EMSBH0100-10-ATH	●			10.0				4,320
EMSBH0100-20-ATH	●	1.0	5.0	20.0	0.95	70	4.0	8,640
EMSBH0100-30-ATH	●			30.0				19,760
EMSBH0101-10-ATH	□			10.0				-
EMSBH0101-20-ATH	□	1.01	5.0	20.0	0.97	70	4.0	-
EMSBH0101-30-ATH	□			30.0				-
EMSBH0102-10-ATH	□			10.0				-
EMSBH0102-20-ATH	□	1.02	5.0	20.0	0.98	70	4.0	-
EMSBH0102-30-ATH	□			30.0				-

商品コード Item code	在庫 Stock	寸法 Size(mm)						希望小売 価格(円) Suggested retail price (¥)
		直径 Tool dia.	溝長 Flute length	首下長 Under neck length	首径 Neck dia.	全長 Overall length	シャンク径 Shank dia.	
		DC	ℓ	ℓ ₂	DN	LF	DCONMS	
EMSBH0150-15-ATH	●			15.0	-	70		4,320
EMSBH0150-30-ATH	●	1.5	15.0	30.0	1.44	70	4.0	8,640
EMSBH0150-45-ATH	●			45.0		100		19,760
EMSBH0151-15-ATH	□			15.0	-	70		-
EMSBH0151-30-ATH	□	1.51	15.0	30.0	1.45	70	4.0	-
EMSBH0151-45-ATH	□			45.0		100		-
EMSBH0152-15-ATH	□			15.0	-	70		-
EMSBH0152-30-ATH	□	1.52	15.0	30.0	1.46	70	4.0	-
EMSBH0152-45-ATH	□			45.0		100		-
EMSBH0200-20-ATH	●			20.0	-	70		4,320
EMSBH0200-40-ATH	●	2.0	20.0	40.0	1.92	100	4.0	8,640
EMSBH0200-60-ATH	●			60.0		100		19,760
EMSBH0201-20-ATH	□			20.0	-	70		-
EMSBH0201-40-ATH	□	2.01	20.0	40.0	1.93	100	4.0	-
EMSBH0201-60-ATH	□			60.0		100		-
EMSBH0202-20-ATH	□			20.0	-	70		-
EMSBH0202-40-ATH	□	2.02	20.0	40.0	1.94	100	4.0	-
EMSBH0202-60-ATH	□			60.0		100		-

Boring Tools

Other Drills

(注) 上記以外の工具寸法品に関しては、別途ご相談に応じます。弊社営業にお問い合わせ下さい。
 (Note) For products with tool dimensions other than those listed above, separate consultation is needed. Please contact to sales office.

○ 対応被削材 Applicable work materia

軟鋼 Mild steel SS	炭素鋼 Carbon steel S○○○	合金鋼 Alloy steel SCM, SCr	調質鋼 Heat-treated steel SKD SKS	工具鋼 Tool steel ~40HRC	焼入れ鋼 Hardened steel ~45HRC 45HRC~	ステン レス鋼 Stainless steel SUS	耐熱鋼 Ti合金 Heat-resistant steel, Ti alloy Inconel	鋳鉄 Cast iron FC	ダクタイル 鋳鉄 Ductile cast iron FCD	アルミ 合金 Aluminum alloy Al	銅合金 Copper alloy Cu
					○ ◎						

○ 再研磨対応外径範囲 Re-grinding compatibility range

商品コード Item code	エンド End (mm)
EMSBH-ATH	× (N/A)

標準切削条件表 Recommended cutting conditions **EMS-BH-ATH**

商品コード Item code	直径 Tool dia. (mm)	首下長 Under neck length (mm)	ステップ量 Step feed (mm)	プリハードン鋼 Pre-hardened steels (35~45HRC)		焼入れ鋼 Hardened steels (45~60HRC)	
				回転数 n min ⁻¹	送り速度 V_f mm/min	回転数 n min ⁻¹	送り速度 V_f mm/min
EMS-BH0010-1-ATH	0.1	1.0	0.01	22,300	67	12,420	41
EMS-BH0010-2-ATH		2.0					
EMS-BH0010-3-ATH		3.0					
EMS-BH0011-1-ATH	0.11	1.0	0.011	22,300	67	12,420	41
EMS-BH0011-2-ATH		2.0					
EMS-BH0011-3-ATH		3.0					
EMS-BH0012-1-ATH	0.12	1.0	0.012	22,300	67	12,420	41
EMS-BH0012-2-ATH		2.0					
EMS-BH0012-3-ATH		3.0					
EMS-BH0015-1.5-ATH	0.15	1.5	0.015	22,300	65	12,420	45
EMS-BH0015-3-ATH		3.0					
EMS-BH0015-4.5-ATH		4.5					
EMS-BH0020-2-ATH	0.2	2.0	0.02	15,800	63	11,150	50
EMS-BH0020-4-ATH		4.0					
EMS-BH0020-6-ATH		6.0					
EMS-BH0021-2-ATH	0.21	2.0	0.021	15,800	63	11,150	50
EMS-BH0021-4-ATH		4.0					
EMS-BH0021-6-ATH		6.0					
EMS-BH0022-2-ATH	0.22	2.0	0.022	15,800	63	11,150	50
EMS-BH0022-4-ATH		4.0					
EMS-BH0022-6-ATH		6.0					
EMS-BH0030-3-ATH	0.3	3.0	0.03	13,000	51	11,150	43
EMS-BH0030-6-ATH		6.0					
EMS-BH0030-9-ATH		9.0					
EMS-BH0031-3-ATH	0.31	3.0	0.031	13,000	51	11,150	43
EMS-BH0031-6-ATH		6.0					
EMS-BH0031-9-ATH		9.0					
EMS-BH0032-3-ATH	0.32	3.0	0.032	13,000	51	11,150	43
EMS-BH0032-6-ATH		6.0					
EMS-BH0032-9-ATH		9.0					
EMS-BH0040-4-ATH	0.4	4.0	0.04	11,200	55	10,350	52
EMS-BH0040-8-ATH		8.0					
EMS-BH0040-12-ATH		12.0					
EMS-BH0041-4-ATH	0.41	4.0	0.041	11,200	55	10,350	52
EMS-BH0041-8-ATH		8.0					
EMS-BH0041-12-ATH		12.0					
EMS-BH0042-4-ATH	0.42	4.0	0.042	11,200	55	10,350	52
EMS-BH0042-8-ATH		8.0					
EMS-BH0042-12-ATH		12.0					
EMS-BH0050-5-ATH	0.5	5.0	0.05	10,500	52	10,000	50
EMS-BH0050-10-ATH		10.0					
EMS-BH0050-15-ATH		15.0					
EMS-BH0051-5-ATH	0.51	5.0	0.051	10,500	52	10,000	50
EMS-BH0051-10-ATH		10.0					
EMS-BH0051-15-ATH		15.0					
EMS-BH0052-5-ATH	0.52	5.0	0.052	10,500	52	10,000	50
EMS-BH0052-10-ATH		10.0					
EMS-BH0052-15-ATH		15.0					
EMS-BH0060-6-ATH	0.6	6.0	0.06	10,060	56	9,560	55
EMS-BH0060-12-ATH		12.0					
EMS-BH0060-18-ATH		18.0					
EMS-BH0061-6-ATH	0.61	6.0	0.061	10,060	56	9,560	55
EMS-BH0061-12-ATH		12.0					
EMS-BH0061-18-ATH		18.0					
EMS-BH0062-6-ATH	0.62	6.0	0.062	10,060	56	9,560	55
EMS-BH0062-12-ATH		12.0					
EMS-BH0062-18-ATH		18.0					

商品コード Item code	直径 Tool dia. (mm)	首下長 Under neck length (mm)	ステップ量 Step feed (mm)	プリハードン鋼 Pre-hardened steels (35~45HRC)		焼入れ鋼 Hardened steels (45~60HRC)	
				回転数 n min ⁻¹	送り速度 V_f mm/min	回転数 n min ⁻¹	送り速度 V_f mm/min
EMS-BH0070-7-ATH	0.7	7.0	0.07	9,600	59	9,100	54
EMS-BH0070-14-ATH		14.0					
EMS-BH0070-21-ATH		21.0					
EMS-BH0071-7-ATH	0.71	7.0	0.071	9,600	59	9,100	54
EMS-BH0071-14-ATH		14.0					
EMS-BH0071-21-ATH		21.0					
EMS-BH0072-7-ATH	0.72	7.0	0.072	9,600	59	9,100	54
EMS-BH0072-14-ATH		14.0					
EMS-BH0072-21-ATH		21.0					
EMS-BH0080-8-ATH	0.8	8.0	0.08	9,260	57	8,760	55
EMS-BH0080-16-ATH		16.0					
EMS-BH0080-24-ATH		24.0					
EMS-BH0081-8-ATH	0.81	8.0	0.081	9,260	57	8,760	55
EMS-BH0081-16-ATH		16.0					
EMS-BH0081-24-ATH		24.0					
EMS-BH0082-8-ATH	0.82	8.0	0.082	9,260	57	8,760	55
EMS-BH0082-16-ATH		16.0					
EMS-BH0082-24-ATH		24.0					
EMS-BH0090-9-ATH	0.9	9.0	0.09	9,000	60	8,500	56
EMS-BH0090-18-ATH		18.0					
EMS-BH0090-27-ATH		27.0					
EMS-BH0091-9-ATH	0.91	9.0	0.091	9,000	60	8,500	56
EMS-BH0091-18-ATH		18.0					
EMS-BH0091-27-ATH		27.0					
EMS-BH0092-9-ATH	0.92	9.0	0.092	9,000	60	8,500	56
EMS-BH0092-18-ATH		18.0					
EMS-BH0092-27-ATH		27.0					
EMS-BH0100-10-ATH	1.0	10.0	0.1	8,500	63	8,000	56
EMS-BH0100-20-ATH		20.0					
EMS-BH0100-30-ATH		30.0					
EMS-BH0101-10-ATH	1.01	10.0	0.101	8,500	63	8,000	56
EMS-BH0101-20-ATH		20.0					
EMS-BH0101-30-ATH		30.0					
EMS-BH0102-10-ATH	1.02	10.0	0.102	8,500	63	8,000	56
EMS-BH0102-20-ATH		20.0					
EMS-BH0102-30-ATH		30.0					
EMS-BH0150-15-ATH	1.5	15.0	0.15	5,750	60	4,250	43
EMS-BH0150-30-ATH		30.0					
EMS-BH0150-45-ATH		45.0					
EMS-BH0151-15-ATH	1.51	15.0	0.151	5,750	60	4,250	43
EMS-BH0151-30-ATH		30.0					
EMS-BH0151-45-ATH		45.0					
EMS-BH0152-15-ATH	1.52	15.0	0.152	5,750	60	4,250	43
EMS-BH0152-30-ATH		30.0					
EMS-BH0152-45-ATH		45.0					
EMS-BH0200-20-ATH	2.0	20.0	0.2	5,000	60	3,190	43
EMS-BH0200-40-ATH		40.0					
EMS-BH0200-60-ATH		60.0					
EMS-BH0201-20-ATH	2.01	20.0	0.201	5,000	60	3,190	43
EMS-BH0201-40-ATH		40.0					
EMS-BH0201-60-ATH		60.0					
EMS-BH0202-20-ATH	2.02	20.0	0.202	5,000	60	3,190	43
EMS-BH0202-40-ATH		40.0					
EMS-BH0202-60-ATH		60.0					

【注意】 Note

次頁の「加工方法及び注意点」を参照の上、ご使用をお願いします。
Please understand "Drilling method and attentions" next page, and use EMS-BH-ATH.

穴あけ工具の世界的リーダー

<切削条件の選定について> Setting of cutting conditions

- この標準切削条件表は切削条件の目安を示すものです。実際の加工では加工形状、目的、使用機械等により条件を調整してください。
- 揉み付け用のドリル(スターター)にはEPDBEH-ATHをご使用ください。**
- 必ずG83(ベックドリリングサイクル)にてご使用ください。**
- 焼入れ鋼の穴あけ加工において、L/D30Dをご使用される場合は、10Dの工具での前工程を追加することを推奨いたします。さらに直径がφ0.5未満においては、10Dに加え、20Dの工具での前工程も追加することを推奨します。**
【例】SKD11(60HRC)のφ0.1×30Dの穴あけなど
- 首下長(ℓ₂)は貫通の加工穴深さに対応しています。**
- 貫通穴を加工する場合、工具先端から直径の20%以上~30%以下の深さまで貫通してください。**
【例】ワーク板厚:T=4mm 工具:φ0.5x首下長5mmの場合 加工深さ:4.14mm(工具先端より)
- 切りくず排出のため、水溶性または油性クーラントをご使用ください。**
- 別途記載の加工方法及び加工時の注意点をよくご確認いただき、ご使用ください。**

- This standard cutting condition table is intended as reference cutting conditions. The conditions should be adjusted as necessary according to the actual conditions of machined shape, purpose, machine used, etc.
- **Please use EPDBEH-ATH as a starter.**
- **Please always use G83 mode (peck drilling cycle).**
- **For drilling hardened steel, when drilling holes with an L/D of 30D, it is recommended to use a 10D tool for pre-drilling. In addition, when the diameter is less than φ0.5, in addition to pre-drilling with a 10D tool, further pre-drilling with a 20D tool is also recommended.**
Example: When drilling a φ0.1 × 30D hole in SKD11 (60HRC), etc.
- Under-neck length (ℓ₂) conforms to through-hole drilling depth.
- When drilling through holes, drill the through hole to a depth of between 20% and 30% of the diameter from the tip of the tool.
Ex.: For work thickness T=4mm and tool= φ0.5×under neck length 5mm, drilling depth should be 4.14mm (from tip of tool).
- Water-soluble or oil-based coolant should be used to ensure chip removal.
- Please pay attention on the below "Drilling process and attentions on drilling".

<スターターについて>

About starter

※**専用スターター(弊社エポックディープボールエボリューションハードEPDBEH-ATH)をご使用ください。必ずG83プログラムによるステップ加工を行ってください。**
穴深さ:直径の60%深さまで必ず入れてください
(例:φ0.1の時は、0.06mm)

Use of a special starter (Epoch Deep Ball Evolution Hard EPDBEH-ATH) is recommended. Be sure to perform step drilling using a G83 program. Hole depth: Be sure to perform drilling to a depth of 60% of the tool diameter. (For example, 0.06mm deep for a tool diameter of φ0.1mm)

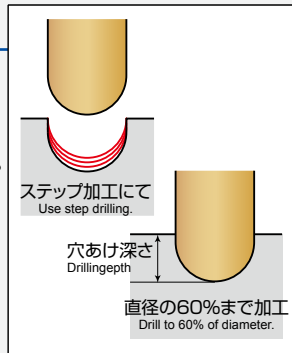

<加工プログラムについて>

About machining programs

必ずG83(ベックドリリングサイクル)にて加工を行ってください。
推奨リファレンス位置:0.05~0.1mm
尚、50Dを超える場合は、ワーク上面より直径の30%分下の位置に設定してください。
(例:φ1×首下長100mmのリファレンス位置=-0.3mm)
推奨アプローチ距離:0.05mm

※機械のパラメータ設定画面にて変更ください。この数値が大きいと加工時間が長くなる可能性があります。
Always perform drilling using a G83 program (Peck drilling cycle).
Recommended reference position: 0.05 to 0.1mm
However, for aspect ratios of greater than 50D, the position should be set as 30% of the tool dia. below the surface of the work. (Ex.: For φ1 × 100mm below-neck length, reference position = -0.3mm)
Recommended approach distance: 0.05mm *Change according to the machine parameter setting screen. If these values are large, machining time may become longer.

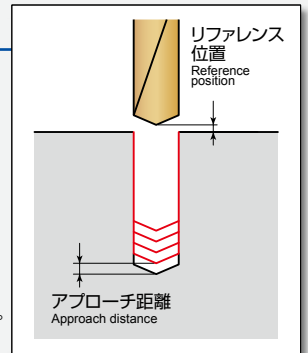

<クーラントについて>

About coolants

油性または水溶性のクーラントの使用を推奨します。
この時、クーラントが刃先に当たるように設定してください。

Oil-based or water-soluble coolants are recommended.
When using, set it up so that the coolant hits the flute tips.

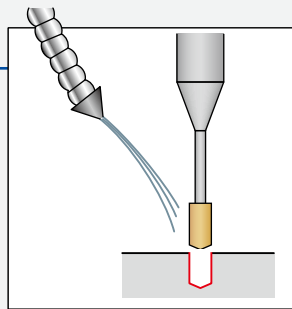

<早送り速度について>

About fast feed rates

首下長が長い場合、早送り速度が速すぎると折損する場合があります。
推奨:20m/min以下
(30D:5m/min以下)

When the below-neck length is long, if the fast feed rate is too fast, bit may be broken.
Recommended: 20m/min. or less
(for greater than 30D, 5m/min. or less)

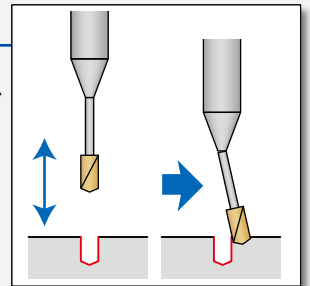

<EMSBS-ATHの直径公差について> Regarding tolerance of diameter for EMSBS-ATH

高硬度鋼の穴あけの際に、穴あけした穴が収縮する事と、金型エジェクターピンにおけるクリアランスの確保を考慮し、EMSBS-ATHの直径公差はプラス公差で設計しています。
現状のEMSBSシリーズは、マイナス公差で設計しています。

Diameter of EMSBS-ATH has a positive tolerance in order to
(1) compensate hole shrink after boring, and
(2) keep clearance for ejector pin of die mold.
Conventional EMSBS has negative tolerance of diameter.

【直径公差】 Diameter tolerance

+0.006
+0.001

エポックマイクロステップボーラーH

専用スターター Special Starter



RE公差 RE tolerance	RE ≤ 0.25 : ±0.003 0.25 < RE : ±0.005	h5 I	(mm)
----------------------	--	---------	------



スターターには弊社エポックディープボールエボリューションハード (EPDBEH-ATH) をご使用ください
Use of Epoch Deep Ball Evolution Hard (EPDBEH-ATH) is recommended for starter.

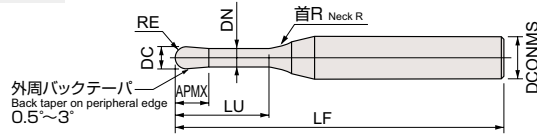

EPDBEH2-ATH

切削条件表 E79
Cutting Conditions

商品コード Item code	在庫 Stock	寸法 Size(mm)								希望小売価格 (円) Suggested retail price (¥)
		外径 Tool dia. DC	ボール半径 Ball radius RE	首下長 Under neck length LU	刃長 Flute length APMX	首径 Neck dia. DN	全長 Overall length LF	シャック径 Shank dia. DCONMS	首R Neck R	
EPDBEH2001-0.2-ATH	●	0.1	0.05	0.2	0.08	0.08	45	4	1	16,290
EPDBEH20011-0.2-ATH	□	0.11	0.055	0.2	0.09	0.09	45	4	1	-
EPDBEH20012-0.2-ATH	□	0.12	0.06	0.2	0.1	0.1	45	4	1	-
EPDBEH20015-0.2-ATH	□	0.15	0.075	0.2	0.13	0.13	45	4	1	-
EPDBEH2002-0.5-ATH	●	0.2	0.1	0.5	0.15	0.17	50	4	1	11,680
EPDBEH20021-0.5-ATH	□	0.21	0.105	0.5	0.16	0.18	50	4	1	-
EPDBEH20022-0.5-ATH	□	0.22	0.11	0.5	0.17	0.19	50	4	1	-
EPDBEH2003-0.5-ATH	●	0.3	0.15	0.5	0.25	0.27	50	4	2	11,470
EPDBEH20031-0.5-ATH	□	0.31	0.155	0.5	0.26	0.28	50	4	2	-
EPDBEH20032-0.5-ATH	□	0.32	0.16	0.5	0.27	0.29	50	4	2	-
EPDBEH2004-0.75-ATH	●	0.4	0.2	0.75	0.3	0.37	50	4	2	7,810
EPDBEH20041-0.75-ATH	□	0.41	0.205	0.75	0.31	0.38	50	4	2	-
EPDBEH20042-0.75-ATH	□	0.42	0.21	0.75	0.32	0.39	50	4	2	-
EPDBEH2005-1-ATH	●	0.5	0.25	1	0.35	0.47	50	4	2	7,810
EPDBEH20051-1-ATH	□	0.51	0.255	1	0.36	0.48	50	4	2	-
EPDBEH20052-1-ATH	□	0.52	0.26	1	0.37	0.49	50	4	2	-
EPDBEH2006-1-ATH	●	0.6	0.3	1	0.4	0.57	50	4	4	6,740
EPDBEH20061-1-ATH	□	0.61	0.305	1	0.41	0.58	50	4	4	-
EPDBEH20062-1-ATH	□	0.62	0.31	1	0.42	0.59	50	4	4	-
EPDBEH2007-2-ATH	●	0.7	0.35	2	0.45	0.67	50	4	4	6,000
EPDBEH20071-2-ATH	□	0.71	0.355	2	0.46	0.68	50	4	4	-
EPDBEH20072-2-ATH	□	0.72	0.36	2	0.47	0.69	50	4	4	-
EPDBEH2008-2-ATH	●	0.8	0.4	2	0.5	0.77	50	4	4	6,000
EPDBEH20081-2-ATH	□	0.81	0.405	2	0.51	0.78	50	4	4	-
EPDBEH20082-2-ATH	□	0.82	0.41	2	0.52	0.79	50	4	4	-
EPDBEH2009-2-ATH	●	0.9	0.45	2	0.6	0.87	50	4	4	6,000
EPDBEH20091-2-ATH	□	0.91	0.455	2	0.61	0.88	50	4	4	-
EPDBEH20092-2-ATH	□	0.92	0.46	2	0.62	0.89	50	4	4	-
EPDBEH2010-2-ATH	●	1	0.5	2	0.8	0.96	50	4	4	5,020
EPDBEH20101-2-ATH	□	1.01	0.505	2	0.81	0.97	50	4	4	-
EPDBEH20102-2-ATH	□	1.02	0.51	2	0.82	0.98	50	4	4	-
EPDBEH2015-2-ATH	●	1.5	0.75	2	1.35	1.44	50	4	4	5,850
EPDBEH20151-2-ATH	□	1.51	0.755	2	1.36	1.45	50	4	4	-
EPDBEH20152-2-ATH	□	1.52	0.76	2	1.37	1.46	50	4	4	-
EPDBEH2020-3-ATH	●	2	1	3	1.7	1.92	50	4	4	5,020
EPDBEH20201-3-ATH	□	2.01	1.005	3	1.71	1.93	50	4	4	-
EPDBEH20202-3-ATH	□	2.02	1.01	3	1.72	1.94	50	4	4	-

穴あけ工具
そのほかのドリル

対応被削材 Applicable work materia

軟鋼 Mild steel SS	炭素鋼 Carbon steel S00C	合金鋼 Alloy steel SCM, SCr	調質鋼 Heat-treated steel SKD SKS	工具鋼 Tool steel ~40HRC	焼入れ鋼 Hardened steel ~45HRC 45HRC~	ステンレス鋼 Stainless steel SUS	耐熱鋼 Ti合金 Heat-resistant steel, Ti alloy Inconel	鋳鉄 Cast iron FC	ダクタイル鋳鉄 Ductile cast iron FCD	アルミ合金 Aluminum alloy Al	銅合金 Copper alloy Cu
------------------------	-----------------------------	--------------------------------	--------------------------------------	-----------------------------	---	----------------------------------	--	-----------------------	-------------------------------------	-------------------------------	---------------------------

再研磨対応外径範囲 Re-grinding compatibility range

商品コード Item code	エンド End (mm)
EPDBEH-ATH	× (N/A)

●印：標準在庫品です。●：Stocked items。□印：特定代理店在庫です。弊社営業へお問い合わせください。□：Stocked by specified distributor. Contact with our sales department.

○ スターター用工具 (EPDBEH-ATH) の切削条件

Cutting condition for starter (EPDBEH-ATH)

外径 DC Tool dia. (mm)	加工穴 深さ Drilling hole depth (mm)	プリハードン鋼 Pre-hardened steels (35~45HRC)			焼入れ鋼 Hardened steels (45~55HRC)			焼入れ鋼 Hardened steels (55~60HRC)		
		回転数 <i>n</i> min ⁻¹	送り速度 <i>Vf</i> mm/min	ステップ量 (mm) Step feed	回転数 <i>n</i> min ⁻¹	送り速度 <i>Vf</i> mm/min	ステップ量 (mm) Step feed	回転数 <i>n</i> min ⁻¹	送り速度 <i>Vf</i> mm/min	ステップ量 (mm) Step feed
0.1	0.06									
0.11	0.066	13,369	33	0.003	12,414	21	0.003	12,414	21	0.003
0.12	0.072									
0.15	0.09	13,369	34	0.0045	12,414	23	0.0045	12,414	23	0.0045
0.2	0.12									
0.21	0.126	10,504	35	0.006	10,027	25	0.006	10,027	25	0.006
0.22	0.132									
0.3	0.18									
0.31	0.186	8,913	25	0.009	8,541	21	0.009	8,541	21	0.009
0.32	0.192									
0.4	0.24									
0.41	0.246	8,077	23	0.012	7,520	21	0.012	7,520	21	0.012
0.42	0.252									
0.5	0.3									
0.51	0.306	6,462	23	0.015	6,016	21	0.015	6,016	21	0.015
0.52	0.312									
0.6	0.36									
0.61	0.366	5,385	23	0.018	5,013	21	0.018	5,013	21	0.018
0.62	0.372									

外径 DC Tool dia. (mm)	加工穴 深さ Drilling hole depth (mm)	プリハードン鋼 Pre-hardened steels (35~45HRC)			焼入れ鋼 Hardened steels (45~55HRC)			焼入れ鋼 Hardened steels (55~60HRC)		
		回転数 <i>n</i> min ⁻¹	送り速度 <i>Vf</i> mm/min	ステップ量 (mm) Step feed	回転数 <i>n</i> min ⁻¹	送り速度 <i>Vf</i> mm/min	ステップ量 (mm) Step feed	回転数 <i>n</i> min ⁻¹	送り速度 <i>Vf</i> mm/min	ステップ量 (mm) Step feed
0.7	0.42									
0.71	0.426	4,615	23	0.021	4,297	21	0.021	4,297	21	0.021
0.72	0.432									
0.8	0.48									
0.81	0.486	4,039	23	0.024	3,760	21	0.024	3,760	21	0.024
0.82	0.492									
0.9	0.54									
0.91	0.546	3,590	23	0.027	3,342	21	0.027	3,342	21	0.027
0.92	0.552									
1	0.6									
1.01	0.606	3,231	23	0.045	3,008	21	0.03	3,008	21	0.03
1.02	0.612									
1.5	0.9									
1.51	0.906	2,154	23	0.045	2,005	21	0.045	2,005	21	0.045
1.52	0.912									
2	1.2									
2.01	1.206	1,615	23	0.06	1,504	21	0.06	1,504	21	0.06
2.02	1.212									

- この標準切削条件表は切削条件の目安を示すものです。実際の加工では加工形状、目的、使用機械等により条件を調整してください。
- 切りくず排出のため、水溶性または油性のクーラントをご使用ください。
- 必ずG83(ペックドリリングサイクル)にてご使用ください。
- 加工深さ：直径の60%深さまで必ず入れてください(例：φ0.1の時は、0.06mm)

- These recommended cutting conditions indicate only the rule of a thumb for the cutting conditions. In actual machining, the condition should be adjusted according to the machining shape, purpose and the machine type.
- Water-soluble or oil-based coolant should be used to ensure chip removal.
- Always use with a G83 program (Peck drilling cycle).
- Hole depth: Be sure to drill to a depth of 60% of the diameter. (Ex.: For φ0.1, depth=0.06mm)

○ 切削事例 Field data

01 φ0.8 SUS420J2相当材(52HRC)の加工穴径精度 Result of drilling for φ0.8 equivalent to SUS420J2 (52HRC)

被削材 Work material : SUS420J2相当材 Equivalent to SUS420J2 (52HRC) 使用工具 Tool : 特殊 Special EMSBH0080-24-ATH (L/D=30D)
 公差 Tolerance : +0.001 +0.006mm クーラント Coolant : 水溶性切削液 外部給油 External water base coolant
 $n=5,370\text{min}^{-1}$ $v_c=13.5\text{m/min}$ $v_f=43\text{mm/min}$ $f=0.008\text{mm/rev}$ Step=0.04mm T=24mm



エジェクターピンのピン径 : 0.790mm
Diameter of ejector pin

穴径 (入口) Dia.way-in	穴径 (出口) Dia.way-out
● A : 0.803mm	● A : 0.806mm
● B : 0.803mm	● B : 0.803mm
● C : 0.805mm	● C : 0.806mm
● D : 0.804mm	● D : 0.804mm

穴径は工具直径とほぼ同径で加工でき、出口と入口の差異が少ない。
 Hole diameters are quite similar to diameter of tool, with less discrepancy between way-in and way-out.

エポックハードドリル

THコーティング

TH Coating



0~0.01

(mm)

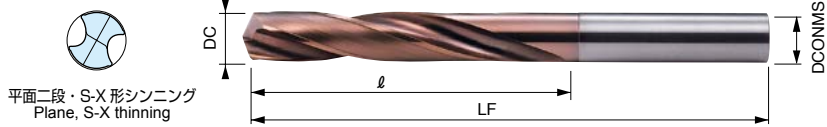

EHSE $\circ\circ\circ$ -TH

切削条件表 E81
Cutting Conditions

商品コード Item code	在庫 Stock	寸法 Size (mm)			シヤンク径 Shank dia. DCONMS	希望小売 価格(円) Suggested retail price(¥)
		直径 Tool dia. DC	溝長 Flute length ℓ	全長 Overall length LF		
EHSE2.0-TH	●	2.0	15	50	3	10,090
EHSE2.1-TH	●	2.1	15	50	3	10,090
EHSE2.2-TH	●	2.2	16	50	3	10,090
EHSE2.3-TH	●	2.3	16	50	3	10,090
EHSE2.4-TH	●	2.4	17	50	3	10,090
EHSE2.5-TH	●	2.5	17	55	3	10,090
EHSE2.6-TH	●	2.6	17	55	3	10,090
EHSE2.7-TH	●	2.7	19	55	3	10,090
EHSE2.8-TH	●	2.8	19	55	3	10,090
EHSE2.9-TH	●	2.9	19	55	3	10,090
EHSE3.0-TH	●	3.0	21	60	3	9,370
EHSE3.1-TH	●	3.1	24	60	4	10,090
EHSE3.2-TH	●	3.2	24	60	4	10,090
EHSE3.3-TH	●	3.3	24	60	4	10,090
EHSE3.4-TH	●	3.4	24	60	4	10,090
EHSE3.5-TH	●	3.5	24	60	4	10,090
EHSE3.6-TH	●	3.6	27	60	4	10,610
EHSE3.7-TH	●	3.7	27	60	4	10,610
EHSE3.8-TH	●	3.8	27	60	4	10,610
EHSE3.9-TH	●	3.9	27	60	4	10,610
EHSE4.0-TH	●	4.0	27	60	4	10,610
EHSE4.1-TH	●	4.1	29	63	5	11,460
EHSE4.2-TH	●	4.2	29	63	5	11,460
EHSE4.3-TH	●	4.3	29	63	5	11,460
EHSE4.4-TH	●	4.4	29	63	5	11,460
EHSE4.5-TH	●	4.5	29	63	5	11,460
EHSE4.6-TH	●	4.6	32	68	5	12,130
EHSE4.7-TH	●	4.7	32	68	5	12,130
EHSE4.8-TH	●	4.8	32	68	5	12,130
EHSE4.9-TH	●	4.9	32	68	5	12,130
EHSE5.0-TH	●	5.0	32	68	5	12,130
EHSE5.1-TH	●	5.1	34	72	6	12,800
EHSE5.2-TH	●	5.2	34	72	6	12,800
EHSE5.3-TH	●	5.3	34	72	6	12,800
EHSE5.4-TH	●	5.4	34	72	6	12,800
EHSE5.5-TH	●	5.5	34	72	6	12,800
EHSE5.6-TH	●	5.6	36	74	6	13,470
EHSE5.7-TH	●	5.7	36	74	6	13,470
EHSE5.8-TH	●	5.8	36	74	6	13,470
EHSE5.9-TH	●	5.9	36	74	6	13,470

商品コード Item code	在庫 Stock	寸法 Size (mm)			シヤンク径 Shank dia. DCONMS	希望小売 価格(円) Suggested retail price(¥)
		直径 Tool dia. DC	溝長 Flute length ℓ	全長 Overall length LF		
EHSE6.0-TH	●	6.0	41	81	6	13,470
EHSE6.5-TH	●	6.5	41	81	7	13,470
EHSE6.8-TH	●	6.8	43	83	7	14,370
EHSE6.9-TH	●	6.9	43	83	7	14,370
EHSE7.0-TH	●	7.0	43	83	7	14,370
EHSE7.5-TH	●	7.5	45	87	8	18,190
EHSE7.8-TH	●	7.8	48	90	8	19,310
EHSE8.0-TH	●	8.0	48	90	8	19,310
EHSE8.5-TH	●	8.5	53	96	9	20,320
EHSE8.6-TH	●	8.6	55	98	9	21,100
EHSE8.7-TH	●	8.7	55	98	9	21,100
EHSE8.8-TH	●	8.8	55	98	9	21,100
EHSE9.0-TH	●	9.0	55	98	9	21,100
EHSE9.5-TH	●	9.5	58	102	10	22,220
EHSE9.8-TH	●	9.8	60	105	10	23,130
EHSE10.0-TH	●	10.0	60	105	10	23,130
EHSE10.3-TH	●	10.3	66	112	11	24,130
EHSE10.4-TH	●	10.4	66	112	11	24,130
EHSE10.5-TH	●	10.5	66	112	11	24,130
EHSE10.8-TH	●	10.8	68	114	11	25,140
EHSE11.0-TH	●	11.0	68	114	11	25,140
EHSE11.5-TH	●	11.5	71	118	12	25,930
EHSE11.8-TH	●	11.8	73	121	12	27,160
EHSE12.0-TH	●	12.0	73	121	12	27,160
EHSE12.1-TH	●	12.1	76	135	13	27,940
EHSE12.2-TH	●	12.2	76	135	13	27,940
EHSE12.5-TH	●	12.5	76	135	13	27,940
EHSE12.6-TH	●	12.6	78	137	13	28,850
EHSE13.0-TH	●	13.0	78	137	13	33,330
EHSE13.5-TH		13.5	84	144	14	-
EHSE14.0-TH		14.0	86	147	14	-
EHSE14.1-TH	●	14.1	89	151	15	39,400
EHSE14.2-TH		14.2	89	151	15	-
EHSE14.5-TH		14.5	89	151	15	-
EHSE14.6-TH	●	14.6	91	153	15	41,640
EHSE15.0-TH		15.0	91	153	15	-
EHSE15.5-TH		15.5	94	157	16	-
EHSE15.6-TH	●	15.6	96	160	16	45,120
EHSE16.0-TH		16.0	96	160	16	-
EHSE16.1-TH	●	16.1	102	167	17	46,910

○ 対応被削材 Applicable work materia

軟鋼 Mild steel SS	炭素鋼 Carbon steel S $\circ\circ$ C	合金鋼 Alloy steel SCM, ScR	調質鋼 Heat-treated steel SKD SKS	工具鋼 Tool steel ~40HRC	焼入れ鋼 Hardened steel ~45HRC 45HRC~	ステン レス鋼 Stainless steel SUS	耐熱鋼 Ti合金 Heat-resistant steel, Ti alloy Inconel	鋳鉄 Cast iron FC	ダクタイル 鋳鉄 Ductile cast iron FCD	アルミ 合金 Aluminum alloy Al	銅合金 Copper alloy Cu
------------------------	--	-----------------------------------	--	-----------------------------	---	---	---	-----------------------	--	--------------------------------------	------------------------------

○ 再研磨対応外径範囲 Re-grinding compatibility range

商品コード Item code	エンド End (mm)
EHSE-TH	2 ~ 16.1

●印：標準在庫品です。●：Stocked items. 無印：受注生産品です。No Mark：Manufactured upon request only.

標準切削条件表 Recommended cutting conditions

EHSE-TH

ウェット(水溶性：希釈率20倍以下)加工標準切削条件表

Recommended Cutting Conditions for Wet (Dilution of less than 20times)

被削材 Work material	熱間工具鋼 Hot working tool steels SKD61, SKT (50~55HRC)			冷間工具鋼 Cold working tool steels SKD11, SKT (55~60HRC)			高速度工具鋼 High speed steels SKH (60~65HRC)		
	15~20~30			10~15~20			8~10~12		
切削速度 v_c Cutting speed (m/min)									
直径 Tool dia.	回転数 n (min^{-1})	送り速度 v_f (mm/min)	送り量 f (mm/rev)	回転数 n (min^{-1})	送り速度 v_f (mm/min)	送り量 f (mm/rev)	回転数 n (min^{-1})	送り速度 v_f (mm/min)	送り量 f (mm/rev)
$\phi 2$	3,180	64	0.02	2,390	48	0.02	1,590	20	0.012
$\phi 4$	1,600	64	0.04	1,200	48	0.04	800	20	0.025
$\phi 6$	1,050	64	0.06	800	48	0.06	530	20	0.04
$\phi 8$	800	64	0.08	600	48	0.08	400	20	0.05
$\phi 10$	640	64	0.1	480	43	0.09	320	20	0.06
$\phi 12$	530	64	0.12	400	40	0.1	270	20	0.07
$\phi 14$	450	64	0.14	340	37	0.11	230	20	0.08
$\phi 16$	400	64	0.16	300	36	0.12	200	20	0.1

切削条件の選定について Selection of cutting conditions

- ・ 被削材、加工形状に合わせて、適切なクーラントを使用してください。
- ・ この標準切削条件表は切削条件の目安を示すものです。実際の加工では加工形状、目的、使用機械等により条件を調整してください。
- ・ 上記の切削条件表は、穴の深さが直径の3倍までに適用してください。
- ・ 被削材の材質や硬さにより、切削性が変化する場合があります。
- ・ ドリルを装着するときは、キズや汚れのないコレットを使用し、ドリルの振れは0.02mm以下におさえてください。
- ・ 剛性のある機械でご使用ください。
- ・ 切削油(水溶性:希釈率20倍以下)は加工ポイントに十分に供給してください。
- ・ 旋盤等で横方向から加工される場合は、切削油が十分に供給されません。この切削条件表の切削速度及び送り速度を×0.7以下でご使用ください。
- ・ 喰い付き性に優れていますので、センタドリルやスターティングドリルによる位置決め加工は不要です。位置決め加工をしますとチッピングが発生する恐れがあります。位置決め加工をした場合は、喰い付き時の送り量をこの切削条件表の1/3にしてください。
- ・ 45HRC未満のワーク加工も可能ですが、加工能率からノンステップボーラーをご使用ください。
- ・ 油性の切削油剤を使用する場合は切削速度範囲の下限より低速の条件でご使用ください。また、切りくずおよび工具の発熱による発煙・引火にご注意ください。
- ・ Use the appropriate coolant for the work material and machining shape.
- ・ These Recommended Cutting Conditions indicate only the rule of a thumb for the cutting conditions. In actual machining, the condition should be adjusted according to the machining shape, purpose and the machine type.
- ・ The above conditions apply to a hole-depth of 3 times the diameter or less.
- ・ Cutting performance may vary according to the material being cut and its hardness.
- ・ Mount the drill on a collet without any flaws. Adjust the drill run out to 0.02mm or less.
- ・ Use a machine with high rigidity.
- ・ Supply a sufficient amount of cutting fluid (Water-soluble, dilution of 20 times or less) to machining points.
- ・ Sufficient cutting fluid is not supplied in the case of a turning machine or other machine used in a longitudinal direction. Use values of 70% or less of those in the above chart.
- ・ The drill can start drilling with high performance and accuracy. It is not recommended to conduct positioning using a center drill or a starting drill because it may cause chipping.
- ・ When conducting positioning, set the feeding length to one third of the value above.
- ・ Non Step Borer is recommended for machining works of a hardness less than 45 HRC.
- ・ When using oil-based cutting agent, use conditions below the lower limit of the cutting speed range. In addition, be careful of smoke or fire due to cutting chips or heating of tool.

Step Borer

段付きボーラー

内部給油タイプ (オイルホール有) Internal coolant type (with oil holes)



(mm)

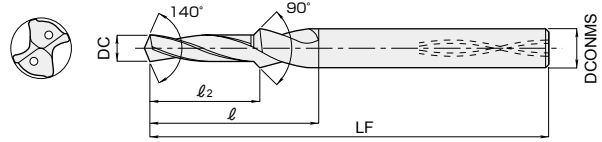

切削条件表 E84
Cutting Conditions

STBH-ATH

商品コード Item code	在庫 Stock	L/D	寸法 Size (mm)						適応ねじ サイズ Corresponding tap size	希望小売価格 (円) Suggested retail price(¥)
			小径 Small dia. DC	ステップ長さ Step length l ₂	溝長 Flute length l	全長 Overall length LF	シャンク径(大径) Shank dia. (Large dia.) DCONMS			
STBH034S-ATH	●	2	3.4	8	25	80	6.0	M4	16,500	
STBH034M-ATH	●	3		12	30	80	6.0		19,420	
STBH043S-ATH	●	2	4.3	10	30	85	7.0	M5	17,960	
STBH043M-ATH	●	3		15	35	85	7.0		21,210	
STBH051S-ATH	●	2	5.1	12	35	90	8.0	M6	20,650	
STBH051M-ATH	●	3		18	40	90	8.0		23,570	
STBH068S-ATH	●	2	6.8	16	45	100	10.0	M8	25,140	
STBH068M-ATH	●	3		24	50	105	10.0		29,410	
STBH085S-ATH	●	2	8.5	20	50	115	12.0	M10	32,320	
STBH085M-ATH	●	3		30	60	125	12.0		38,040	
STBH103S-ATH	●	2	10.3	24	60	125	14.0	M12	43,880	
STBH103M-ATH	●	3		36	70	135	14.0		51,180	

- ・面取り幅は、適応ねじサイズ中 M4~M6用はC1.0、M8~M12用はC1.5まで加工可能です。
- ・適応ねじサイズはメートル並目ねじです。
- ・Chamfer width: for corresponding screw sizes of M4 to M6, processing to C1.0 is possible; for M8 to M12, processing to C1.5 is possible.
- ・Corresponding screw sizes are for metric coarse threads.

特殊サイズにつきましても対応いたします。詳しくは弊社営業までお問い合わせください。
Special sizes can also be served. For details, please contact our sales office.

対応被削材 Applicable work materia

軟鋼 Mild steel SS	炭素鋼 Carbon steel S〇〇C	合金鋼 Alloy steel SCM, SCr	調質鋼 Heat-treated steel SKD SKS	工具鋼 Tool steel ~40HRC	焼入れ鋼 Hardened steel ~45HRC 45HRC~	ステン レス鋼 Stainless steel SUS	耐熱鋼 Ti合金 Heat-resistant steel, Ti alloy Inconel	鋳鉄 Cast iron FC	ダクタイル 鋳鉄 Ductile cast iron FCD	アルミ 合金 Aluminum alloy Al	銅合金 Copper alloy Cu
○	○	○	○	○	○	○	○	○	○	○	○

再研磨対応外径範囲 Re-grinding compatibility range

商品コード Item code	エンド End (mm)
STBH-ATH	3.4 ~ 10.3

○印：標準在庫品です。 ●：Stocked items.

外部給油タイプ (オイルホール無し) External coolant type (without oil hole)



(mm)

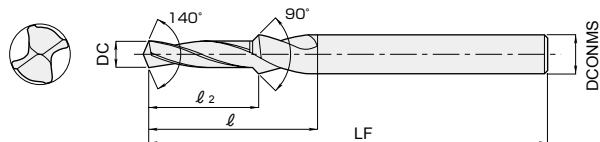

切削条件表 E84
Cutting Conditions

STB-ATH

商品コード Item code	在庫 Stock	L/D	寸法 Size (mm)						希望小売価格 (円) Suggested retail price(¥)
			小径 Small dia.	ステップ長さ Step length	溝長 Flute length	全長 Overall length	シャンク径(大径) Shank dia. (Large dia.)	適応ねじ サイズ Corresponding tap size	
			DC	ℓ_2	ℓ	LF	DCONMS		
STB034S-ATH	●	2	3.4	8	25	80	6.0	M4	13,810
STB034M-ATH	●	3		12	30	80	6.0		16,050
STB043S-ATH	●	2	4.3	10	30	85	7.0	M5	14,930
STB043M-ATH	●	3		15	35	85	7.0		17,740
STB051S-ATH	●	2	5.1	12	35	90	8.0	M6	17,070
STB051M-ATH	●	3		18	40	90	8.0		19,640
STB068S-ATH	●	2	6.8	16	45	100	10.0	M8	20,880
STB068M-ATH	●	3		24	50	105	10.0		24,580
STB085S-ATH	●	2	8.5	20	50	115	12.0	M10	27,050
STB085M-ATH	●	3		30	60	125	12.0		31,650
STB103S-ATH	●	2	10.3	24	60	125	14.0	M12	36,590
STB103M-ATH	●	3		36	70	135	14.0		42,760

- ・面取り幅は、適用ねじサイズ中 M4~M6用はC1.0、M8~M12用はC1.5まで加工可能です。
- ・適用ねじサイズはメートル並目ねじです。
- ・Chamfer width: for corresponding screw sizes of M4 to M6, processing to C1.0 is possible; for M8 to M12, processing to C1.5 is possible.
- ・Corresponding screw sizes are for metric coarse threads.

特殊サイズにつきましても対応いたします。詳しくは弊社営業までお問い合わせください。
Special sizes can also be served. For details, please contact our sales office.

Boring Tools Other Drills

○ 対応被削材 Applicable work materia

軟鋼 Mild steel	炭素鋼 Carbon steel	合金鋼 Alloy steel	調質鋼 Heat-treated steel	工具鋼 Tool steel	焼入れ鋼 Hardened steel	ステン レス鋼 Stainless steel	耐熱鋼 Ti合金 Heat-resistant steel, Ti alloy Inconel	鋳鉄 Cast iron	ダクタイル 鋳鉄 Ductile cast iron FCD	アルミ 合金 Aluminum alloy Al	銅合金 Copper alloy Cu
SS	S〇〇C	SCM, SCr	SKD SKS	~40HRC	~45HRC 45HRC~	SUS		FC			
○	◎	◎	◎	○	○	○		○	○	○	

○ 再研磨対応外径範囲 Re-grinding compatibility range

商品コード Item code	エンド End (mm)
STB-ATH	3.4 ~ 10.3

標準切削条件表 Recommended cutting conditions

STBH-ATH 内部給油タイプ (オイルホール有) Internal coolant type (with oil holes)

小径 Small dia.		構造用鋼 Structural steels ~180HB	炭素鋼 Carbon steels ~200HB	合金鋼 Alloy steels ~30HRC	プリハードン鋼 Pre-hardened steels ~45HRC	ねずみ鋳鉄 Gray cast irons FC	ダクタイル 鋳鉄 Ductile cast irons FCD	アルミニウム 合金 Aluminium alloys	ステンレス鋼 Stainless steels SUS300系	耐熱鋼 Heat-resistant alloys インコネル718 Inconel 718
φ3.0 } φ6.0 (mm)	切削速度 (m/min)	80 (40~120)	80 (40~120)	80 (40~120)	40 (20~60)	80 (40~120)	60 (30~90)	100 (80~120)	40 (20~60)	20 (10~25)
	送り量(mm/rev.)	0.07~0.2	0.07~0.2	0.07~0.2	0.05~0.12	0.07~0.2	0.07~0.2	0.07~0.2	0.05~0.2	0.05~0.15
φ6.1 } φ10.0 (mm)	切削速度 (m/min)	80 (40~120)	80 (40~120)	80 (40~120)	40 (20~60)	80 (40~120)	60 (30~90)	100 (80~120)	40 (20~60)	25 (15~30)
	送り量(mm/rev.)	0.12~0.3	0.12~0.3	0.12~0.3	0.06~0.2	0.12~0.3	0.12~0.3	0.12~0.3	0.09~0.2	0.05~0.15
φ10.1 } φ13.0 (mm)	切削速度 (m/min)	80 (40~120)	80 (40~120)	80 (40~120)	40 (20~60)	80 (40~120)	60 (30~90)	100 (80~120)	40 (20~60)	25 (15~30)
	送り量(mm/rev.)	0.2~0.4	0.2~0.4	0.2~0.4	0.1~0.25	0.2~0.4	0.2~0.4	0.2~0.4	0.15~0.35	0.1~0.2

STB-ATH 外部給油タイプ (オイルホール無し) External coolant type (without oil hole)

小径 Small dia.		構造用鋼 Structural steels ~180HB	炭素鋼 Carbon steels ~200HB	合金鋼 Alloy steels ~30HRC	プリハードン鋼 Pre-hardened steels ~45HRC	ねずみ鋳鉄 Gray cast irons FC	ダクタイル 鋳鉄 Ductile cast irons FCD	アルミニウム 合金 Aluminium alloys
φ3.0 } φ6.0 (mm)	切削速度 (m/min)	60 (40~80)	60 (40~80)	60 (40~80)	40 (20~60)	70 (40~100)	50 (30~70)	70 (50~90)
	送り量(mm/rev.)	0.07~0.2	0.07~0.2	0.07~0.2	0.05~0.12	0.07~0.2	0.07~0.2	0.07~0.2
φ6.1 } φ10.0 (mm)	切削速度 (m/min)	60 (40~80)	60 (40~80)	60 (40~80)	40 (20~60)	70 (40~100)	50 (30~70)	70 (50~90)
	送り量(mm/rev.)	0.12~0.3	0.12~0.3	0.12~0.3	0.06~0.2	0.12~0.3	0.12~0.3	0.12~0.3
φ10.1 } φ13.0 (mm)	切削速度 (m/min)	60 (40~80)	60 (40~80)	60 (40~80)	40 (20~60)	70 (40~100)	50 (30~70)	70 (50~90)
	送り量(mm/rev.)	0.2~0.4	0.2~0.4	0.2~0.4	0.1~0.25	0.2~0.4	0.2~0.4	0.2~0.4

【使用上の注意】

- ① 本工具は穴あけと穴の入口に面取りを一度に行う工具です。大径部まで使用した穴あけ(段穴加工など)はできません。
- ② 面取り加工時に切りくずが長くなり加工に支障をきたす場合がありますので、その際はイン칭加工などで切りくずを分断させることを推奨いたします。(面取り部以外で切りくずが長くなる場合はステップ加工またはイン칭加工を行ってください。)
- ③ 面取り加工時は送り速度を30~70%に下げた事を推奨いたします。
- ④ ステンレス鋼および耐熱鋼の加工では内部給油タイプ(オイルホール)を選定してください。(外部給油タイプは推奨できません。)
- ⑤ 内部給油タイプの切削条件は希釈倍率20倍以下の水溶性切削油剤またはMQL(ミスト)を使用した場合のものであります。
- ⑥ 外部給油タイプの切削条件は希釈倍率20倍以下の水溶性切削油剤を使用した場合のものであります。
- ⑦ 水溶性切削油剤の希釈倍率20倍を超える場合は切削速度範囲の下限を目安にしてください。
- ⑧ MQL(ミスト)加工の場合はミスト装置や工具からの吐出量により切削条件を下げないと加工できない場合があります。
- ⑨ 油性の切削油剤を使用する場合は切削速度の下限値の70%を目安にご使用してください。
- ⑩ 機械剛性やワーククランプ状態、加工部形状などの状況により切削条件を調整してください。

【Attentions on use】

- ① This tool is a tool for boring holes and chamfering the hole opening in a single process. It cannot be used for boring holes with a large-diameter portion (stepped boring, etc.)
- ② Since during chamfering chips may become long and interfere with drilling, it is recommended that chips be cut by performing inching processing, etc. (If chips become long during processing when chamfering is not being performed, perform pecking or inching processing.)
- ③ It is recommended that the feed rate be reduced to 30 to 70% during chamfering.
- ④ For drilling of stainless steel or heat-resistant steel, select the internal coolant type (with oil holes). Use of external coolant type in such cases is not recommended.
- ⑤ The cutting conditions stated for the internal coolant type are when using water-based coolants at dilutions of up to 20:1 maximum or when using MQL (mist).
- ⑥ The cutting conditions stated for the external coolant type are when using water-based coolants at dilutions of up to 20:1 maximum.
- ⑦ If water-based coolant at dilutions greater than 20:1 is used, the lower limit of the cutting speed range should be used as a general criteria.
- ⑧ When performing MQL (mist) drilling, it may be necessary in some cases to reduce the cutting conditions depending on the mist equipment or amounts discharged by the tool.
- ⑨ When using an oil-based coolant, 70% of the lower limit for cutting speed should be used as a general criteria.
- ⑩ Cutting conditions should be adjusted according to machine rigidity or work clamp conditions, shape of cutting area, etc.

Z Plunging Borer ザグリボーラー

レギュラー

Regular



0~-0.01

(mm)

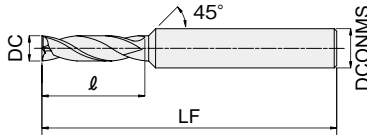

Aタイプ Type A

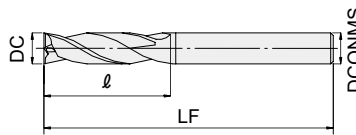

Bタイプ Type B

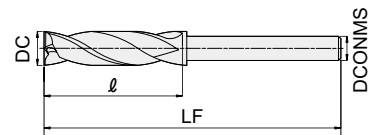

Cタイプ Type C

ZPB-TH



商品コード Item code	在庫 Stock	寸法 Size (mm)				形状 Shape	希望小売 価格(円) Suggested retail price(¥)
		直径 Tool dia.	溝長 Flute length	全長 Overall length	シャンク径 Shank dia.		
		DC	ℓ	LF	DCONMS		
ZPB0200-TH	□	2.0	8	50	4	A	-
ZPB0210-TH	□	2.1	8	50	4	A	-
ZPB0220-TH	□	2.2	8	50	4	A	-
ZPB0230-TH	□	2.3	8	50	4	A	-
ZPB0240-TH	□	2.4	8	50	4	A	-
ZPB0250-TH	□	2.5	10	50	4	A	-
ZPB0260-TH	□	2.6	10	50	4	A	-
ZPB0270-TH	□	2.7	10	50	4	A	-
ZPB0280-TH	□	2.8	10	50	4	A	-
ZPB0290-TH	□	2.9	10	50	4	A	-
ZPB0300-TH	●	3.0	12	50	4	A	7,100
ZPB0310-TH	□	3.1	12	50	4	A	-
ZPB0320-TH	□	3.2	12	50	4	A	-
ZPB0330-TH	□	3.3	14	50	4	A	-
ZPB0340-TH	□	3.4	14	50	4	A	-
ZPB0350-TH	□	3.5	14	50	4	A	-
ZPB0360-TH	□	3.6	14	50	4	A	-
ZPB0370-TH	□	3.7	14	50	4	A	-
ZPB0380-TH	□	3.8	16	50	4	A	-
ZPB0390-TH	□	3.9	16	50	4	A	-
ZPB0400-TH	●	4.0	16	50	4	B	7,430
ZPB0410-TH	□	4.1	16	50	6	A	-
ZPB0420-TH	□	4.2	16	50	6	A	-
ZPB0430-TH	□	4.3	18	50	6	A	-
ZPB0440-TH	□	4.4	18	50	6	A	-
ZPB0450-TH	●	4.5	18	50	6	A	7,430
ZPB0460-TH	□	4.6	18	50	6	A	-
ZPB0470-TH	□	4.7	18	50	6	A	-
ZPB0480-TH	□	4.8	20	60	6	A	-
ZPB0490-TH	□	4.9	20	60	6	A	-

商品コード Item code	在庫 Stock	寸法 Size (mm)				形状 Shape	希望小売 価格(円) Suggested retail price(¥)
		直径 Tool dia.	溝長 Flute length	全長 Overall length	シャンク径 Shank dia.		
		DC	ℓ	LF	DCONMS		
ZPB0500-TH	●	5.0	20	60	6	A	8,000
ZPB0510-TH	□	5.1	20	60	6	A	-
ZPB0520-TH	□	5.2	20	60	6	A	-
ZPB0530-TH	□	5.3	20	60	6	A	-
ZPB0540-TH	□	5.4	20	60	6	A	-
ZPB0550-TH	●	5.5	22	60	6	A	8,300
ZPB0560-TH	□	5.6	22	60	6	A	-
ZPB0570-TH	□	5.7	22	60	6	A	-
ZPB0580-TH	□	5.8	22	60	6	A	-
ZPB0590-TH	□	5.9	22	60	6	A	-
ZPB0600-TH	●	6.0	22	60	6	B	8,300
ZPB0610-TH	□	6.1	24	70	8	A	-
ZPB0620-TH	□	6.2	24	70	8	A	-
ZPB0630-TH	□	6.3	24	70	8	A	-
ZPB0640-TH	□	6.4	24	70	8	A	-
ZPB0650-TH	□	6.5	26	70	8	A	-
ZPB0660-TH	□	6.6	26	70	8	A	-
ZPB0670-TH	□	6.7	26	70	8	A	-
ZPB0680-TH	□	6.8	26	70	8	A	-
ZPB0690-TH	□	6.9	26	70	8	A	-
ZPB0700-TH	●	7.0	26	70	8	A	10,880
ZPB0710-TH	□	7.1	26	70	8	A	-
ZPB0720-TH	□	7.2	26	70	8	A	-
ZPB0730-TH	□	7.3	26	70	8	A	-
ZPB0740-TH	□	7.4	26	70	8	A	-
ZPB0750-TH	□	7.5	26	70	8	A	-
ZPB0760-TH	□	7.6	28	70	8	A	-
ZPB0770-TH	□	7.7	28	70	8	A	-
ZPB0780-TH	□	7.8	28	70	8	A	-
ZPB0790-TH	□	7.9	28	70	8	A	-

●印：標準在庫品です。 □印：特定代理店在庫です。弊社営業へお問合せください。
●：Stocked items. □：Stocked by specified distributor. Contact with our sales department.

Boring Tools

Other Drills

ザグリボーラー

ZPB○○○○-TH

商品コード Item code	在庫 Stock	寸法 Size (mm)				形状 Shape	希望小売 価格(円) Suggested retail price(¥)
		直径 Tool dia.	溝長 Flute length	全長 Overall length	シャンク径 Shank dia.		
		DC	ℓ	LF	D CONMS		
ZPB0800-TH	●	8.0	28	70	8	B	12,350
ZPB0810-TH	□	8.1	28	80	10	A	—
ZPB0820-TH	□	8.2	28	80	10	A	—
ZPB0830-TH	□	8.3	28	80	10	A	—
ZPB0840-TH	□	8.4	28	80	10	A	—
ZPB0850-TH	□	8.5	28	80	10	A	—
ZPB0860-TH	□	8.6	28	80	10	A	—
ZPB0870-TH	□	8.7	28	80	10	A	—
ZPB0880-TH	□	8.8	28	80	10	A	—
ZPB0890-TH	□	8.9	28	80	10	A	—
ZPB0900-TH	●	9.0	28	80	10	A	14,370
ZPB0910-TH	□	9.1	30	80	10	A	—
ZPB0920-TH	□	9.2	30	80	10	A	—
ZPB0930-TH	□	9.3	30	80	10	A	—
ZPB0940-TH	□	9.4	30	80	10	A	—
ZPB0950-TH	●	9.5	30	80	10	A	14,820
ZPB0960-TH	□	9.6	32	80	10	A	—
ZPB0970-TH	□	9.7	32	80	10	A	—
ZPB0980-TH	□	9.8	32	80	10	A	—
ZPB0990-TH	□	9.9	32	80	10	A	—
ZPB1000-TH	●	10.0	32	80	10	B	14,370
ZPB1010-TH	□	10.1	33	90	12	A	—
ZPB1020-TH	□	10.2	33	90	12	A	—
ZPB1030-TH	□	10.3	33	90	12	A	—
ZPB1040-TH	□	10.4	33	90	12	A	—
ZPB1050-TH	□	10.5	33	90	12	A	—
ZPB1060-TH	□	10.6	33	90	12	A	—
ZPB1070-TH	□	10.7	33	90	12	A	—
ZPB1080-TH	□	10.8	33	90	12	A	—
ZPB1090-TH	□	10.9	33	90	12	A	—

商品コード Item code	在庫 Stock	寸法 Size (mm)				形状 Shape	希望小売 価格(円) Suggested retail price(¥)
		直径 Tool dia.	溝長 Flute length	全長 Overall length	シャンク径 Shank dia.		
		DC	ℓ	LF	D CONMS		
ZPB1100-TH	●	11.0	33	90	12	A	17,850
ZPB1110-TH	□	11.1	34	90	12	A	—
ZPB1120-TH	□	11.2	34	90	12	A	—
ZPB1130-TH	□	11.3	34	90	12	A	—
ZPB1140-TH	□	11.4	34	90	12	A	—
ZPB1150-TH	□	11.5	34	90	12	A	—
ZPB1160-TH	□	11.6	38	90	12	A	—
ZPB1170-TH	□	11.7	38	90	12	A	—
ZPB1180-TH	□	11.8	38	90	12	A	—
ZPB1190-TH	□	11.9	38	90	12	A	—
ZPB1200-TH	●	12.0	38	90	12	B	20,880
ZPB1250-TH	□	12.5	40	100	12	C	—
ZPB1300-TH	□	13.0	40	100	12	C	—
ZPB1350-TH	□	13.5	40	100	12	C	—
ZPB1400-TH	□	14.0	40	100	12	C	—
ZPB1450-TH	□	14.5	40	105	12	C	—
ZPB1500-TH	□	15.0	40	105	12	C	—
ZPB1550-TH	□	15.5	42	110	12	C	—
ZPB1600-TH	□	16.0	42	110	16	B	—

穴あけ工具
Zシリーズ

○ 対応被削材 Applicable work materia

軟鋼 Mild steel SS	炭素鋼 Carbon steel S〇〇C	合金鋼 Alloy steel SCM, SCr	調質鋼 Heat-treated steel SKD SKS	工具鋼 Tool steel ~40HRC	焼入れ鋼 Hardened steel ~45HRC 45HRC~	ステン レス 鋼 Stainless steel SUS	耐熱鋼 Ti合金 Heat-resistant steel, Ti alloy Inconel	鋳鉄 Cast iron FC	ダクタイル 鋳鉄 Ductile cast iron FCD	アルミ 合金 Aluminum alloy Al	銅合金 Copper alloy Cu
○	○	○	○	○	○	○	○	○	○	○	○

○ 再研磨対応外径範囲 Re-grinding compatibility range

商品コード Item code	エンド End (mm)
ZPB-TH	2 ~ 16

●印：標準在庫品です。□印：特定代理店在庫です。弊社営業へお問い合わせください。
 ● : Stocked items. □ : Stocked by specified distributor. Contact with our sales department.

ロングシャンク

Long Shank



0~0.01

(mm)

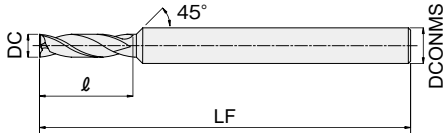

Aタイプ Type A

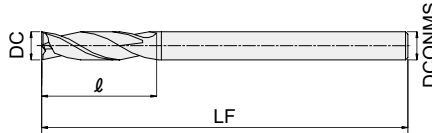

Bタイプ Type B

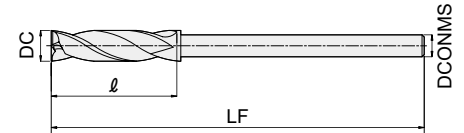

Cタイプ Type C



ZPBL5-TH

商品コード Item code	在庫 Stock	寸法 Size (mm)				形状 Shape	希望小売 価格(円) Suggested retail price(¥)
		直径 Tool dia.	溝長 Flute length	全長 Overall length	シャンク径 Shank dia.		
		DC	ℓ	LF	DCONMS		
ZPBL50200-TH	<input type="checkbox"/>	2.0	8	80	4	A	-
ZPBL50210-TH	<input type="checkbox"/>	2.1	8	80	4	A	-
ZPBL50220-TH	<input type="checkbox"/>	2.2	8	80	4	A	-
ZPBL50230-TH	<input type="checkbox"/>	2.3	8	80	4	A	-
ZPBL50240-TH	<input type="checkbox"/>	2.4	8	80	4	A	-
ZPBL50250-TH	<input type="checkbox"/>	2.5	10	80	4	A	-
ZPBL50260-TH	<input type="checkbox"/>	2.6	10	80	4	A	-
ZPBL50270-TH	<input type="checkbox"/>	2.7	10	80	4	A	-
ZPBL50280-TH	<input type="checkbox"/>	2.8	10	80	4	A	-
ZPBL50290-TH	<input type="checkbox"/>	2.9	10	80	4	A	-
ZPBL50300-TH	<input type="checkbox"/>	3.0	12	100	6	A	-
ZPBL50310-TH	<input type="checkbox"/>	3.1	12	100	6	A	-
ZPBL50320-TH	<input type="checkbox"/>	3.2	12	100	6	A	-
ZPBL50330-TH	<input type="checkbox"/>	3.3	14	100	6	A	-
ZPBL50340-TH	<input type="checkbox"/>	3.4	14	100	6	A	-
ZPBL50350-TH	<input type="checkbox"/>	3.5	14	100	6	A	-
ZPBL50360-TH	<input type="checkbox"/>	3.6	14	100	6	A	-
ZPBL50370-TH	<input type="checkbox"/>	3.7	14	100	6	A	-
ZPBL50380-TH	<input type="checkbox"/>	3.8	16	100	6	A	-
ZPBL50390-TH	<input type="checkbox"/>	3.9	16	100	6	A	-
ZPBL50400-TH	<input type="checkbox"/>	4.0	16	100	6	A	-
ZPBL50410-TH	<input type="checkbox"/>	4.1	16	100	6	A	-
ZPBL50420-TH	<input type="checkbox"/>	4.2	16	100	6	A	-
ZPBL50430-TH	<input type="checkbox"/>	4.3	18	100	6	A	-
ZPBL50440-TH	<input type="checkbox"/>	4.4	18	100	6	A	-
ZPBL50450-TH	<input type="checkbox"/>	4.5	18	100	6	A	-
ZPBL50460-TH	<input type="checkbox"/>	4.6	18	100	6	A	-
ZPBL50470-TH	<input type="checkbox"/>	4.7	18	100	6	A	-
ZPBL50480-TH	<input type="checkbox"/>	4.8	20	110	6	A	-
ZPBL50490-TH	<input type="checkbox"/>	4.9	20	110	6	A	-

商品コード Item code	在庫 Stock	寸法 Size (mm)				形状 Shape	希望小売 価格(円) Suggested retail price(¥)
		直径 Tool dia.	溝長 Flute length	全長 Overall length	シャンク径 Shank dia.		
		DC	ℓ	LF	DCONMS		
ZPBL50500-TH	<input type="checkbox"/>	5.0	20	110	6	A	-
ZPBL50510-TH	<input type="checkbox"/>	5.1	20	110	6	A	-
ZPBL50520-TH	<input type="checkbox"/>	5.2	20	110	6	A	-
ZPBL50530-TH	<input type="checkbox"/>	5.3	20	110	6	A	-
ZPBL50540-TH	<input type="checkbox"/>	5.4	20	110	6	A	-
ZPBL50550-TH	<input type="checkbox"/>	5.5	22	110	6	A	-
ZPBL50560-TH	<input type="checkbox"/>	5.6	22	110	6	A	-
ZPBL50570-TH	<input type="checkbox"/>	5.7	22	110	6	A	-
ZPBL50580-TH	<input type="checkbox"/>	5.8	22	110	6	A	-
ZPBL50590-TH	<input type="checkbox"/>	5.9	22	110	6	A	-
ZPBL50600-TH	<input type="checkbox"/>	6.0	22	120	6	B	-
ZPBL50610-TH	<input type="checkbox"/>	6.1	24	120	6	C	-
ZPBL50620-TH	<input type="checkbox"/>	6.2	24	120	6	C	-
ZPBL50630-TH	<input type="checkbox"/>	6.3	24	120	6	C	-
ZPBL50640-TH	<input type="checkbox"/>	6.4	24	120	6	C	-
ZPBL50650-TH	<input type="checkbox"/>	6.5	26	120	6	C	-
ZPBL50660-TH	<input type="checkbox"/>	6.6	26	120	6	C	-
ZPBL50670-TH	<input type="checkbox"/>	6.7	26	120	6	C	-
ZPBL50680-TH	<input type="checkbox"/>	6.8	26	120	6	C	-
ZPBL50690-TH	<input type="checkbox"/>	6.9	26	120	6	C	-
ZPBL50700-TH	<input type="checkbox"/>	7.0	26	120	6	C	-
ZPBL50710-TH	<input type="checkbox"/>	7.1	26	120	6	C	-
ZPBL50720-TH	<input type="checkbox"/>	7.2	26	120	6	C	-
ZPBL50730-TH	<input type="checkbox"/>	7.3	26	120	6	C	-
ZPBL50740-TH	<input type="checkbox"/>	7.4	26	120	6	C	-
ZPBL50750-TH	<input type="checkbox"/>	7.5	26	120	6	C	-
ZPBL50760-TH	<input type="checkbox"/>	7.6	28	120	6	C	-
ZPBL50770-TH	<input type="checkbox"/>	7.7	28	120	6	C	-
ZPBL50780-TH	<input type="checkbox"/>	7.8	28	120	6	C	-
ZPBL50790-TH	<input type="checkbox"/>	7.9	28	120	6	C	-

ZPBL5○○○○-TH

商品コード Item code	在庫 Stock	寸法 Size (mm)				形状 Shape	希望小売 価格(円) Suggested retail price(¥)
		直径 Tool dia.	溝長 Flute length	全長 Overall length	シャンク径 Shank dia.		
		DC	ℓ	LF	DCONMS		
ZPBL50800-TH	<input type="checkbox"/>	8.0	28	130	8	B	—
ZPBL50810-TH	<input type="checkbox"/>	8.1	28	130	8	C	—
ZPBL50820-TH	<input type="checkbox"/>	8.2	28	130	8	C	—
ZPBL50830-TH	<input type="checkbox"/>	8.3	28	130	8	C	—
ZPBL50840-TH	<input type="checkbox"/>	8.4	28	130	8	C	—
ZPBL50850-TH	<input type="checkbox"/>	8.5	28	130	8	C	—
ZPBL50860-TH	<input type="checkbox"/>	8.6	28	130	8	C	—
ZPBL50870-TH	<input type="checkbox"/>	8.7	28	130	8	C	—
ZPBL50880-TH	<input type="checkbox"/>	8.8	28	130	8	C	—
ZPBL50890-TH	<input type="checkbox"/>	8.9	28	130	8	C	—
ZPBL50900-TH	<input type="checkbox"/>	9.0	28	130	8	C	—
ZPBL50910-TH	<input type="checkbox"/>	9.1	30	130	8	C	—
ZPBL50920-TH	<input type="checkbox"/>	9.2	30	130	8	C	—
ZPBL50930-TH	<input type="checkbox"/>	9.3	30	130	8	C	—
ZPBL50940-TH	<input type="checkbox"/>	9.4	30	130	8	C	—
ZPBL50950-TH	<input type="checkbox"/>	9.5	30	130	8	C	—
ZPBL50960-TH	<input type="checkbox"/>	9.6	32	130	8	C	—
ZPBL50970-TH	<input type="checkbox"/>	9.7	32	130	8	C	—
ZPBL50980-TH	<input type="checkbox"/>	9.8	32	130	8	C	—
ZPBL50990-TH	<input type="checkbox"/>	9.9	32	130	8	C	—
ZPBL51000-TH	<input type="checkbox"/>	10.0	32	150	10	B	—
ZPBL51010-TH	<input type="checkbox"/>	10.1	33	150	10	C	—
ZPBL51020-TH	<input type="checkbox"/>	10.2	33	150	10	C	—
ZPBL51030-TH	<input type="checkbox"/>	10.3	33	150	10	C	—
ZPBL51040-TH	<input type="checkbox"/>	10.4	33	150	10	C	—
ZPBL51050-TH	<input type="checkbox"/>	10.5	33	150	10	C	—
ZPBL51060-TH	<input type="checkbox"/>	10.6	33	150	10	C	—
ZPBL51070-TH	<input type="checkbox"/>	10.7	33	150	10	C	—
ZPBL51080-TH	<input type="checkbox"/>	10.8	33	150	10	C	—
ZPBL51090-TH	<input type="checkbox"/>	10.9	33	150	10	C	—

商品コード Item code	在庫 Stock	寸法 Size (mm)				形状 Shape	希望小売 価格(円) Suggested retail price(¥)
		直径 Tool dia.	溝長 Flute length	全長 Overall length	シャンク径 Shank dia.		
		DC	ℓ	LF	DCONMS		
ZPBL51100-TH	<input type="checkbox"/>	11.0	33	150	10	C	—
ZPBL51110-TH	<input type="checkbox"/>	11.1	34	150	10	C	—
ZPBL51120-TH	<input type="checkbox"/>	11.2	34	150	10	C	—
ZPBL51130-TH	<input type="checkbox"/>	11.3	34	150	10	C	—
ZPBL51140-TH	<input type="checkbox"/>	11.4	34	150	10	C	—
ZPBL51150-TH	<input type="checkbox"/>	11.5	34	150	10	C	—
ZPBL51160-TH	<input type="checkbox"/>	11.6	38	150	10	C	—
ZPBL51170-TH	<input type="checkbox"/>	11.7	38	150	10	C	—
ZPBL51180-TH	<input type="checkbox"/>	11.8	38	150	10	C	—
ZPBL51190-TH	<input type="checkbox"/>	11.9	38	150	10	C	—
ZPBL51200-TH	<input type="checkbox"/>	12.0	38	150	12	B	—
ZPBL51250-TH	<input type="checkbox"/>	12.5	40	150	12	C	—
ZPBL51300-TH	<input type="checkbox"/>	13.0	40	150	12	C	—
ZPBL51350-TH	<input type="checkbox"/>	13.5	40	150	12	C	—
ZPBL51400-TH	<input type="checkbox"/>	14.0	40	150	12	C	—
ZPBL51450-TH	<input type="checkbox"/>	14.5	40	150	12	C	—
ZPBL51500-TH	<input type="checkbox"/>	15.0	40	150	12	C	—
ZPBL51550-TH	<input type="checkbox"/>	15.5	42	150	12	C	—
ZPBL51600-TH	<input type="checkbox"/>	16.0	42	150	16	B	—

穴あけ工具
ZPBL5シリーズ

○ 対応被削材 Applicable work materia

軟鋼 Mild steel SS	炭素鋼 Carbon steel S〇〇C	合金鋼 Alloy steel SCM, SCr	調質鋼 Heat-treated steel SKD SKS	工具鋼 Tool steel ~40HRC	焼入れ鋼 Hardened steel ~45HRC 45HRC~	ステン レス鋼 Stainless steel SUS	耐熱鋼 Ti合金 Heat-resistant steel, Ti alloy Inconel	鋳鉄 Cast iron FC	ダクタイル 鋳鉄 Ductile cast iron FCD	アルミ 合金 Aluminum alloy Al	銅合金 Copper alloy Cu
○	◎	◎	◎	○	○	◎	◎	○	◎	○	◎

○ 再研磨対応外径範囲 Re-grinding compatibility range

商品コード Item code	エンド End (mm)
ZPBL5-TH	2 ~ 16

○印：特定代理店在庫です。弊社営業へお問合せください。 □：Stocked by specified distributor. Contact with our sales department.

標準切削条件表 Recommended cutting conditions

レギュラー Regular ZPB-TH

被削材(硬さ) Work material (Hardness)	構造用鋼 Structural steels (~180HB) SS		炭素鋼 Carbon steels (~200HB) S○○C		合金鋼 Alloy steels (~30HRC) SCM		プリハードン鋼 Pre-hardened steels (~45HRC)		ねずみ鋳鉄 Casting FC	
	切削速度(v_c)m/min	40~80m/min	40~80m/min	40~80m/min	30~70m/min	30~70m/min	10~50m/min	10~50m/min	40~80m/min	40~80m/min
工具径 Tool dia. (mm)	回転数 (n)min ⁻¹	送り量 (f)mm/rev.	回転数 (n)min ⁻¹	送り量 (f)mm/rev.	回転数 (n)min ⁻¹	送り量 (f)mm/rev.	回転数 (n)min ⁻¹	送り量 (f)mm/rev.	回転数 (n)min ⁻¹	送り量 (f)mm/rev.
	φ2	10,000	0.02~0.05	10,000	0.02~0.05	9,000	0.02~0.05	6,000	0.01~0.04	10,000
φ3	7,950	0.05~0.08	7,950	0.05~0.08	6,900	0.05~0.08	4,250	0.03~0.06	7,950	0.05~0.08
φ4	6,000	0.06~0.1	6,000	0.06~0.1	5,200	0.06~0.1	3,200	0.04~0.08	6,000	0.06~0.1
φ5	4,800	0.08~0.13	4,800	0.08~0.13	4,150	0.08~0.13	2,550	0.05~0.1	4,800	0.08~0.13
φ6	4,000	0.09~0.15	4,000	0.09~0.15	3,450	0.09~0.15	2,100	0.06~0.12	4,000	0.09~0.15
φ7	3,400	0.11~0.18	3,400	0.11~0.18	3,000	0.11~0.18	1,800	0.07~0.14	3,400	0.11~0.18
φ8	3,000	0.12~0.2	3,000	0.12~0.2	2,600	0.12~0.2	1,600	0.08~0.16	3,000	0.12~0.2
φ9	2,650	0.14~0.23	2,650	0.14~0.23	2,300	0.14~0.23	1,400	0.09~0.18	2,650	0.14~0.23
φ10	2,400	0.15~0.25	2,400	0.15~0.25	2,100	0.15~0.25	1,300	0.1~0.2	2,400	0.15~0.25
φ11	2,200	0.17~0.28	2,200	0.17~0.28	1,900	0.17~0.28	1,150	0.11~0.22	2,200	0.17~0.28
φ12	2,000	0.18~0.3	2,000	0.18~0.3	1,750	0.18~0.3	1,050	0.12~0.24	2,000	0.18~0.3
φ13	1,700	0.13~0.26	1,700	0.13~0.26	1,400	0.13~0.26	1,000	0.09~0.22	1,500	0.17~0.26
φ14	1,500	0.13~0.27	1,500	0.13~0.27	1,250	0.13~0.27	800	0.08~0.23	1,250	0.16~0.27
φ15	1,300	0.12~0.27	1,300	0.12~0.27	1,100	0.12~0.27	650	0.07~0.23	1,050	0.15~0.27
φ16	1,200	0.16~0.32	1,200	0.16~0.32	1,200	0.16~0.32	700	0.13~0.24	1,200	0.16~0.32

被削材(硬さ) Work material (Hardness)	アルミニウム合金 Aluminum alloys A7075		アルミニウム合金鋳物 Aluminum alloy casting AC, ADC	
	切削速度(v_c)m/min	60~200m/min	30~150m/min	30~150m/min
工具径 Tool dia. (mm)	回転数 (n)min ⁻¹	送り量 (f)mm/rev.	回転数 (n)min ⁻¹	送り量 (f)mm/rev.
	φ2	20,000	0.02~0.05	19,000
φ3	17,000	0.05~0.08	12,700	0.05~0.07
φ4	12,500	0.06~0.1	9,550	0.06~0.09
φ5	10,000	0.08~0.13	7,650	0.08~0.12
φ6	8,500	0.09~0.15	6,350	0.09~0.14
φ7	7,300	0.11~0.18	5,450	0.11~0.16
φ8	6,500	0.12~0.2	4,800	0.12~0.18
φ9	5,650	0.14~0.23	4,250	0.14~0.21
φ10	5,100	0.15~0.25	3,800	0.15~0.23
φ11	4,650	0.17~0.28	3,500	0.17~0.25
φ12	4,250	0.18~0.3	3,200	0.18~0.28
φ13	3,000	0.18~0.28	2,700	0.19~0.26
φ14	2,500	0.17~0.29	2,300	0.18~0.27
φ15	2,000	0.15~0.29	1,900	0.15~0.27
φ16	2,300	0.16~0.32	2,000	0.16~0.32

ロングシャンク 切削条件目安 ZPBL5-TH

Long shank: General rules for cutting conditions

工具突出し比率(L/D) Tool overhang ratio	切削条件比率 Cutting condition ratio
3以下 3 or less	70~90%
4以下 4 or less	10~70% ステップ量 0.5D以下 Step feed 0.5D or less
5以下 5 or less	10%以下 10% or less ステップ量 0.05mm以下 Step feed 0.05mm or less

(例) ZPBL5 1100-THの工具で突出し量 55mm(L/D=5)でS50Cを加工する場合、
回転数は $2200 \times 0.1 = 220 \text{min}^{-1}$ 、送り量は $0.17 \times 0.1 = 0.017 \text{mm/rev}$ 。
ステップ量は 0.05mm
Example: When using the ZPBL51100-TH to machine S50C with a tool overhang of 55mm (L/D=5), the rotation speed should be set to $2200 \times 0.1 = 220 \text{min}^{-1}$, feed rate should be set to $0.17 \times 0.1 = 0.017 \text{mm/rev}$, and step amount should be set to 0.05mm

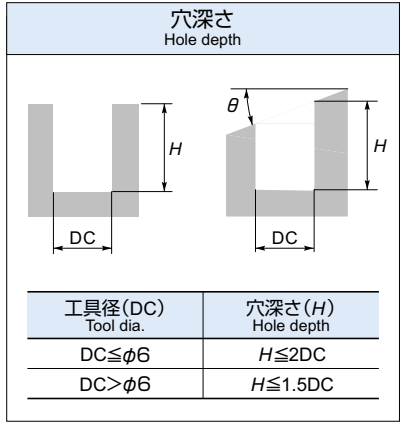

- 【注意】**
- 被削材、加工形状に合わせて、適切なクーラントを使用してください。
 - この標準切削条件表は切削条件の目安を示すものです。実際の加工では加工形状、目的、使用機械等により切削条件を調整してください。
 - 本工具は穴あけ工具なので横送りは出来ません。
 - ステンレス鋼(SUS304, 316など)の加工には向きません。
 - 切りくずが分断できない場合はステップ加工を実施して下さい。
 - この切削条件表はワークの加工面が平面で穴深さが2DC以下の場合のもです。
 - 傾斜面等の平面以外の加工には、加工面の傾き(θ)によって調整してください。
・加工傾き角(θ)が30°以下の場合では、送り速度を70~80%程度を目安に下げてください。
・加工傾き角(θ)が30°を超える場合には、回転数を70%以下、送り速度を50%以下を目安に下げてください。
 - 工具取付時の刃先の振れは極力小さく抑えてください。(目安として10μm以下)

- 【Note】**
- Use the appropriate coolant for the work material and machining shape.
 - These Recommended Cutting Conditions indicate only the rule of a thumb for the cutting conditions. In actual machining, the condition should be adjusted according to the machining shape, purpose and the machine type.
 - This tool is for drilling holes and horizontal feeding cannot be performed.
 - This tool is not suitable for machining stainless steel (SUS304, 316, etc.)
 - If cutting chips cannot be broken up, step machining should be performed.
 - These cutting conditions are for when the machining surface is flat and the cutting depth is 2DC or less.
 - For machining of sloped surfaces or other non-flat surfaces, cutting conditions should be adjusted according to the machining surface slope (θ).
If the machining surface slope (θ) is 30° or less, reduce the feed rate to about 70 to 80% as a general rule.
If the machining surface slope (θ) is 50° or less, reduce the feed rate to less than 50% as a general rule.
 - When attaching the tool, suppress flute tip runout as much as possible (to 10μm or less as a general rule).

注意 Attention 横送り加工には使用しないでください。 This tool can't be used for milling process. Please apply only for drilling process.

再研削&再コーティングも承っております。詳しくは弊社営業所までお問い合わせください。 Regrinding/recoating orders accepted. Please contact our sales department.

Boring Tools Other Drills

エポックワンダードリル

スタブ形

Stub

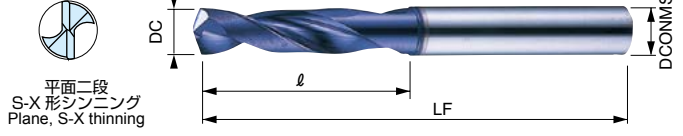

EWSS

切削条件表 E92 Cutting Conditions

商品コード Item code	在庫 Stock	寸法 Size (mm)			
		直径 Tool dia. DC	溝長 Flute length ℓ	全長 Overall length LF	シャンク径 Shank dia. DCONMS
EWSS3.0	<input type="checkbox"/>	3.0	16	46	3
EWSS3.1	<input type="checkbox"/>	3.1	18	49	4
EWSS3.2	<input type="checkbox"/>	3.2	18	49	4
EWSS3.3	<input type="checkbox"/>	3.3	18	49	4
EWSS3.4	<input type="checkbox"/>	3.4	20	52	4
EWSS3.5	<input type="checkbox"/>	3.5	20	52	4
EWSS3.6	<input type="checkbox"/>	3.6	20	52	4
EWSS3.7	<input type="checkbox"/>	3.7	20	52	4
EWSS3.8	<input type="checkbox"/>	3.8	22	55	4
EWSS3.9	<input type="checkbox"/>	3.9	22	55	4
EWSS4.0	<input type="checkbox"/>	4.0	22	55	4
EWSS4.1	<input type="checkbox"/>	4.1	22	55	5
EWSS4.2	<input type="checkbox"/>	4.2	22	55	5
EWSS4.3	<input type="checkbox"/>	4.3	24	58	5
EWSS4.4	<input type="checkbox"/>	4.4	24	58	5
EWSS4.5	<input type="checkbox"/>	4.5	24	58	5
EWSS4.6	<input type="checkbox"/>	4.6	24	58	5
EWSS4.7	<input type="checkbox"/>	4.7	24	58	5
EWSS4.8	<input type="checkbox"/>	4.8	26	62	5
EWSS4.9	<input type="checkbox"/>	4.9	26	62	5
EWSS5.0	<input type="checkbox"/>	5.0	26	62	5
EWSS5.1	<input type="checkbox"/>	5.1	26	62	6
EWSS5.2	<input type="checkbox"/>	5.2	26	62	6
EWSS5.3	<input type="checkbox"/>	5.3	26	62	6
EWSS5.4	<input type="checkbox"/>	5.4	28	66	6
EWSS5.5	<input type="checkbox"/>	5.5	28	66	6
EWSS5.6	<input type="checkbox"/>	5.6	28	66	6
EWSS5.7	<input type="checkbox"/>	5.7	28	66	6
EWSS5.8	<input type="checkbox"/>	5.8	28	66	6
EWSS5.9	<input type="checkbox"/>	5.9	28	66	6
EWSS6.0	<input type="checkbox"/>	6.0	28	66	6
EWSS6.1	<input type="checkbox"/>	6.1	31	70	7
EWSS6.2	<input type="checkbox"/>	6.2	31	70	7
EWSS6.3	<input type="checkbox"/>	6.3	31	70	7
EWSS6.4	<input type="checkbox"/>	6.4	31	70	7
EWSS6.5	<input type="checkbox"/>	6.5	31	70	7
EWSS6.6	<input type="checkbox"/>	6.6	31	70	7
EWSS6.7	<input type="checkbox"/>	6.7	31	70	7
EWSS6.8	<input type="checkbox"/>	6.8	34	74	7
EWSS6.9	<input type="checkbox"/>	6.9	34	74	7
EWSS7.0	<input type="checkbox"/>	7.0	34	74	7
EWSS7.1	<input type="checkbox"/>	7.1	34	74	8
EWSS7.2	<input type="checkbox"/>	7.2	34	74	8
EWSS7.3	<input type="checkbox"/>	7.3	34	74	8

商品コード Item code	在庫 Stock	寸法 Size (mm)			
		直径 Tool dia. DC	溝長 Flute length ℓ	全長 Overall length LF	シャンク径 Shank dia. DCONMS
EWSS7.4	<input type="checkbox"/>	7.4	34	74	8
EWSS7.5	<input type="checkbox"/>	7.5	34	74	8
EWSS7.6	<input type="checkbox"/>	7.6	37	79	8
EWSS7.7	<input type="checkbox"/>	7.7	37	79	8
EWSS7.8	<input type="checkbox"/>	7.8	37	79	8
EWSS7.9	<input type="checkbox"/>	7.9	37	79	8
EWSS8.0	<input type="checkbox"/>	8.0	37	79	8
EWSS8.1	<input type="checkbox"/>	8.1	37	79	9
EWSS8.2	<input type="checkbox"/>	8.2	37	79	9
EWSS8.3	<input type="checkbox"/>	8.3	37	79	9
EWSS8.4	<input type="checkbox"/>	8.4	37	79	9
EWSS8.5	<input type="checkbox"/>	8.5	37	79	9
EWSS8.6	<input type="checkbox"/>	8.6	40	84	9
EWSS8.7	<input type="checkbox"/>	8.7	40	84	9
EWSS8.8	<input type="checkbox"/>	8.8	40	84	9
EWSS8.9	<input type="checkbox"/>	8.9	40	84	9
EWSS9.0	<input type="checkbox"/>	9.0	40	84	9
EWSS9.1	<input type="checkbox"/>	9.1	40	84	10
EWSS9.2	<input type="checkbox"/>	9.2	40	84	10
EWSS9.3	<input type="checkbox"/>	9.3	40	84	10
EWSS9.4	<input type="checkbox"/>	9.4	40	84	10
EWSS9.5	<input type="checkbox"/>	9.5	40	84	10
EWSS9.6	<input type="checkbox"/>	9.6	43	89	10
EWSS9.7	<input type="checkbox"/>	9.7	43	89	10
EWSS9.8	<input type="checkbox"/>	9.8	43	89	10
EWSS9.9	<input type="checkbox"/>	9.9	43	89	10
EWSS10.0	<input type="checkbox"/>	10.0	43	89	10
EWSS10.1	<input type="checkbox"/>	10.1	43	89	11
EWSS10.2	<input type="checkbox"/>	10.2	43	89	11
EWSS10.3	<input type="checkbox"/>	10.3	43	89	11
EWSS10.4	<input type="checkbox"/>	10.4	43	89	11
EWSS10.5	<input type="checkbox"/>	10.5	43	89	11
EWSS10.6	<input type="checkbox"/>	10.6	43	89	11
EWSS10.7	<input type="checkbox"/>	10.7	47	95	11
EWSS10.8	<input type="checkbox"/>	10.8	47	95	11
EWSS10.9	<input type="checkbox"/>	10.9	47	95	11
EWSS11.0	<input type="checkbox"/>	11.0	47	95	11
EWSS11.1	<input type="checkbox"/>	11.1	47	95	12
EWSS11.2	<input type="checkbox"/>	11.2	47	95	12
EWSS11.3	<input type="checkbox"/>	11.3	47	95	12
EWSS11.4	<input type="checkbox"/>	11.4	47	95	12
EWSS11.5	<input type="checkbox"/>	11.5	47	95	12
EWSS11.6	<input type="checkbox"/>	11.6	47	95	12
EWSS11.7	<input type="checkbox"/>	11.7	47	95	12

商品コード Item code	在庫 Stock	寸法 Size (mm)			
		直径 Tool dia. DC	溝長 Flute length ℓ	全長 Overall length LF	シャンク径 Shank dia. DCONMS
EWSS11.8	<input type="checkbox"/>	11.8	47	95	12
EWSS11.9	<input type="checkbox"/>	11.9	51	102	12
EWSS12.0	<input type="checkbox"/>	12.0	51	102	12
EWSS12.1	<input type="checkbox"/>	12.1	51	102	13
EWSS12.2	<input type="checkbox"/>	12.2	51	102	13
EWSS12.3	<input type="checkbox"/>	12.3	51	102	13
EWSS12.4	<input type="checkbox"/>	12.4	51	102	13
EWSS12.5	<input type="checkbox"/>	12.5	51	102	13
EWSS12.6	<input type="checkbox"/>	12.6	51	102	13
EWSS12.7	<input type="checkbox"/>	12.7	51	102	13
EWSS12.8	<input type="checkbox"/>	12.8	51	102	13
EWSS12.9	<input type="checkbox"/>	12.9	51	102	13
EWSS13.0	<input type="checkbox"/>	13.0	51	102	13
EWSS13.1	<input type="checkbox"/>	13.1	51	102	14
EWSS13.2	<input type="checkbox"/>	13.2	51	102	14
EWSS13.3	<input type="checkbox"/>	13.3	54	107	14
EWSS13.4	<input type="checkbox"/>	13.4	54	107	14
EWSS13.5	<input type="checkbox"/>	13.5	54	107	14
EWSS13.6	<input type="checkbox"/>	13.6	54	107	14
EWSS13.7	<input type="checkbox"/>	13.7	54	107	14
EWSS13.8	<input type="checkbox"/>	13.8	54	107	14
EWSS13.9	<input type="checkbox"/>	13.9	54	107	14
EWSS14.0	<input type="checkbox"/>	14.0	54	107	14
EWSS14.1	<input type="checkbox"/>	14.1	56	111	15
EWSS14.2	<input type="checkbox"/>	14.2	56	111	15
EWSS14.3	<input type="checkbox"/>	14.3	56	111	15
EWSS14.4	<input type="checkbox"/>	14.4	56	111	15
EWSS14.5	<input type="checkbox"/>	14.5	56	111	15
EWSS14.6	<input type="checkbox"/>	14.6	56	111	15
EWSS14.7	<input type="checkbox"/>	14.7	56	111	15
EWSS14.8	<input type="checkbox"/>	14.8	56	111	15
EWSS14.9	<input type="checkbox"/>	14.9	56	111	15
EWSS15.0	<input type="checkbox"/>	15.0	56	111	15
EWSS15.5	<input type="checkbox"/>	15.5	58	115	16
EWSS16.0	<input type="checkbox"/>	16.0	58	115	16
EWSS16.5	<input type="checkbox"/>	16.5	60	119	17
EWSS17.0	<input type="checkbox"/>	17.0	60	119	17
EWSS17.5	<input type="checkbox"/>	17.5	62	123	18
EWSS18.0	<input type="checkbox"/>	18.0	62	123	18
EWSS18.5	<input type="checkbox"/>	18.5	64	127	19
EWSS19.0	<input type="checkbox"/>	19.0	64	127	19
EWSS19.5	<input type="checkbox"/>	19.5	66	131	20
EWSS20.0	<input type="checkbox"/>	20.0	66	131	20

対応被削材 Applicable work materia

軟鋼 Mild steel SS	炭素鋼 Carbon steel S00C	合金鋼 Alloy steel SCM, SCr	調質鋼 Heat-treated steel SKD SKS	工具鋼 Tool steel ~40HRC	焼入れ鋼 Hardened steel ~45HRC 45HRC~	ステンレス鋼 Stainless steel SUS	耐熱鋼 Ti合金 Heat-resistant steel, Ti alloy Inconel	鋳鉄 Cast iron FC	ダクタイル鋳鉄 Ductile cast iron FCD	アルミ合金 Aluminium alloy Al	銅合金 Copper alloy Cu
<input type="checkbox"/>	<input type="checkbox"/>	<input type="checkbox"/>	<input type="checkbox"/>	<input type="checkbox"/>	<input type="checkbox"/>	<input type="checkbox"/>	<input type="checkbox"/>	<input type="checkbox"/>	<input type="checkbox"/>	<input type="checkbox"/>	<input type="checkbox"/>

再研磨対応外径範囲 Re-grinding compatibility range

商品コード Item code	エンド End (mm)
EWSS	3 ~ 20

□印：特定代理店在庫です。弊社営業へお問い合わせください。 ○印：Stocked by specified distributor. Contact with our sales department.

穴あけ工具 特定代理店在庫

Epoch Wonder Drills エポックワンダードリル

レギュラー形

Regular

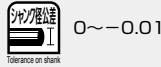

(mm)



平面二段・S-X形シンニング
Plane, S-X thinning

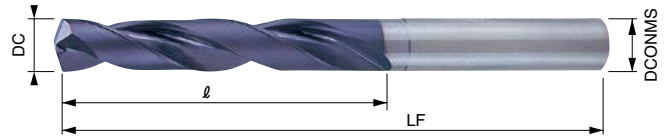

切削条件表 E92
Cutting Conditions

EWSR

商品コード Item code	在庫 Stock	寸法 Size (mm)			
		直径 Tool dia. DC	溝長 Flute length ℓ	全長 Overall length LF	シャンク径 Shank dia. DCONMS
EWSR3.0	<input type="checkbox"/>	3.0	21	60	3.0
EWSR3.1	<input type="checkbox"/>	3.1	24	60	3.1
EWSR3.2	<input type="checkbox"/>	3.2	24	60	3.2
EWSR3.3	<input type="checkbox"/>	3.3	24	60	3.3
EWSR3.4	<input type="checkbox"/>	3.4	24	60	3.4
EWSR3.5	<input type="checkbox"/>	3.5	24	60	3.5
EWSR3.6	<input type="checkbox"/>	3.6	27	60	3.6
EWSR3.7	<input type="checkbox"/>	3.7	27	60	3.7
EWSR3.8	<input type="checkbox"/>	3.8	27	60	3.8
EWSR3.9	<input type="checkbox"/>	3.9	27	60	3.9
EWSR4.0	<input type="checkbox"/>	4.0	27	60	4.0
EWSR4.1	<input type="checkbox"/>	4.1	29	63	4.1
EWSR4.2	<input type="checkbox"/>	4.2	29	63	4.2
EWSR4.3	<input type="checkbox"/>	4.3	29	63	4.3
EWSR4.4	<input type="checkbox"/>	4.4	29	63	4.4
EWSR4.5	<input type="checkbox"/>	4.5	29	63	4.5
EWSR4.6	<input type="checkbox"/>	4.6	32	68	4.6
EWSR4.7	<input type="checkbox"/>	4.7	32	68	4.7
EWSR4.8	<input type="checkbox"/>	4.8	32	68	4.8
EWSR4.9	<input type="checkbox"/>	4.9	32	68	4.9
EWSR5.0	<input type="checkbox"/>	5.0	32	68	5.0
EWSR5.1	<input type="checkbox"/>	5.1	34	72	5.1
EWSR5.2	<input type="checkbox"/>	5.2	34	72	5.2
EWSR5.3	<input type="checkbox"/>	5.3	34	72	5.3
EWSR5.4	<input type="checkbox"/>	5.4	34	72	5.4
EWSR5.5	<input type="checkbox"/>	5.5	34	72	5.5
EWSR5.6	<input type="checkbox"/>	5.6	36	74	5.6
EWSR5.7	<input type="checkbox"/>	5.7	36	74	5.7
EWSR5.8	<input type="checkbox"/>	5.8	36	74	5.8
EWSR5.9	<input type="checkbox"/>	5.9	36	74	5.9
EWSR6.0	<input type="checkbox"/>	6.0	41	81	6.0
EWSR6.1	<input type="checkbox"/>	6.1	41	81	6.1
EWSR6.2	<input type="checkbox"/>	6.2	41	81	6.2
EWSR6.3	<input type="checkbox"/>	6.3	41	81	6.3
EWSR6.4	<input type="checkbox"/>	6.4	41	81	6.4
EWSR6.5	<input type="checkbox"/>	6.5	41	81	6.5
EWSR6.6	<input type="checkbox"/>	6.6	43	83	6.6
EWSR6.7	<input type="checkbox"/>	6.7	43	83	6.7
EWSR6.8	<input type="checkbox"/>	6.8	43	83	6.8
EWSR6.9	<input type="checkbox"/>	6.9	43	83	6.9
EWSR7.0	<input type="checkbox"/>	7.0	43	83	7.0
EWSR7.1	<input type="checkbox"/>	7.1	45	87	7.1
EWSR7.2	<input type="checkbox"/>	7.2	45	87	7.2
EWSR7.3	<input type="checkbox"/>	7.3	45	87	7.3

商品コード Item code	在庫 Stock	寸法 Size (mm)			
		直径 Tool dia. DC	溝長 Flute length ℓ	全長 Overall length LF	シャンク径 Shank dia. DCONMS
EWSR7.4	<input type="checkbox"/>	7.4	45	87	7.4
EWSR7.5	<input type="checkbox"/>	7.5	45	87	7.5
EWSR7.6	<input type="checkbox"/>	7.6	48	90	7.6
EWSR7.7	<input type="checkbox"/>	7.7	48	90	7.7
EWSR7.8	<input type="checkbox"/>	7.8	48	90	7.8
EWSR7.9	<input type="checkbox"/>	7.9	48	90	7.9
EWSR8.0	<input type="checkbox"/>	8.0	48	90	8.0
EWSR8.1	<input type="checkbox"/>	8.1	53	96	8.1
EWSR8.2	<input type="checkbox"/>	8.2	53	96	8.2
EWSR8.3	<input type="checkbox"/>	8.3	53	96	8.3
EWSR8.4	<input type="checkbox"/>	8.4	53	96	8.4
EWSR8.5	<input type="checkbox"/>	8.5	53	96	8.5
EWSR8.6	<input type="checkbox"/>	8.6	55	98	8.6
EWSR8.7	<input type="checkbox"/>	8.7	55	98	8.7
EWSR8.8	<input type="checkbox"/>	8.8	55	98	8.8
EWSR8.9	<input type="checkbox"/>	8.9	55	98	8.9
EWSR9.0	<input type="checkbox"/>	9.0	55	98	9.0
EWSR9.1	<input type="checkbox"/>	9.1	58	102	9.1
EWSR9.2	<input type="checkbox"/>	9.2	58	102	9.2
EWSR9.3	<input type="checkbox"/>	9.3	58	102	9.3
EWSR9.4	<input type="checkbox"/>	9.4	58	102	9.4
EWSR9.5	<input type="checkbox"/>	9.5	58	102	9.5
EWSR9.6	<input type="checkbox"/>	9.6	60	105	9.6
EWSR9.7	<input type="checkbox"/>	9.7	60	105	9.7
EWSR9.8	<input type="checkbox"/>	9.8	60	105	9.8
EWSR9.9	<input type="checkbox"/>	9.9	60	105	9.9
EWSR10.0	<input type="checkbox"/>	10.0	60	105	10.0
EWSR10.1	<input type="checkbox"/>	10.1	66	112	10.1
EWSR10.2	<input type="checkbox"/>	10.2	66	112	10.2
EWSR10.3	<input type="checkbox"/>	10.3	66	112	10.3
EWSR10.4	<input type="checkbox"/>	10.4	66	112	10.4
EWSR10.5	<input type="checkbox"/>	10.5	66	112	10.5
EWSR10.6	<input type="checkbox"/>	10.6	68	114	10.6
EWSR10.7	<input type="checkbox"/>	10.7	68	114	10.7
EWSR10.8	<input type="checkbox"/>	10.8	68	114	10.8
EWSR10.9	<input type="checkbox"/>	10.9	68	114	10.9
EWSR11.0	<input type="checkbox"/>	11.0	68	114	11.0
EWSR11.1	<input type="checkbox"/>	11.1	71	118	11.1
EWSR11.2	<input type="checkbox"/>	11.2	71	118	11.2
EWSR11.3	<input type="checkbox"/>	11.3	71	118	11.3
EWSR11.4	<input type="checkbox"/>	11.4	71	118	11.4
EWSR11.5	<input type="checkbox"/>	11.5	71	118	11.5
EWSR11.6	<input type="checkbox"/>	11.6	73	121	11.6
EWSR11.7	<input type="checkbox"/>	11.7	73	121	11.7

商品コード Item code	在庫 Stock	寸法 Size (mm)			
		直径 Tool dia. DC	溝長 Flute length ℓ	全長 Overall length LF	シャンク径 Shank dia. DCONMS
EWSR11.8	<input type="checkbox"/>	11.8	73	121	11.8
EWSR11.9	<input type="checkbox"/>	11.9	73	121	11.9
EWSR12.0	<input type="checkbox"/>	12.0	73	121	12.0
EWSR12.1	<input type="checkbox"/>	12.1	76	135	12.1
EWSR12.2	<input type="checkbox"/>	12.2	76	135	12.2
EWSR12.3	<input type="checkbox"/>	12.3	76	135	12.3
EWSR12.4	<input type="checkbox"/>	12.4	76	135	12.4
EWSR12.5	<input type="checkbox"/>	12.5	76	135	12.5
EWSR12.6	<input type="checkbox"/>	12.6	78	137	12.6
EWSR12.7	<input type="checkbox"/>	12.7	78	137	12.7
EWSR12.8	<input type="checkbox"/>	12.8	78	137	12.8
EWSR12.9	<input type="checkbox"/>	12.9	78	137	12.9
EWSR13.0	<input type="checkbox"/>	13.0	78	137	13.0
EWSR13.1	<input type="checkbox"/>	13.1	84	144	13.1
EWSR13.2	<input type="checkbox"/>	13.2	84	144	13.2
EWSR13.3	<input type="checkbox"/>	13.3	84	144	13.3
EWSR13.4	<input type="checkbox"/>	13.4	84	144	13.4
EWSR13.5	<input type="checkbox"/>	13.5	84	144	13.5
EWSR13.6	<input type="checkbox"/>	13.6	86	147	13.6
EWSR13.7	<input type="checkbox"/>	13.7	86	147	13.7
EWSR13.8	<input type="checkbox"/>	13.8	86	147	13.8
EWSR13.9	<input type="checkbox"/>	13.9	86	147	13.9
EWSR14.0	<input type="checkbox"/>	14.0	86	147	14.0
EWSR14.1	<input type="checkbox"/>	14.1	89	151	14.1
EWSR14.2	<input type="checkbox"/>	14.2	89	151	14.2
EWSR14.3	<input type="checkbox"/>	14.3	89	151	14.3
EWSR14.4	<input type="checkbox"/>	14.4	89	151	14.4
EWSR14.5	<input type="checkbox"/>	14.5	89	151	14.5
EWSR14.6	<input type="checkbox"/>	14.6	91	153	14.6
EWSR14.7	<input type="checkbox"/>	14.7	91	153	14.7
EWSR14.8	<input type="checkbox"/>	14.8	91	153	14.8
EWSR14.9	<input type="checkbox"/>	14.9	91	153	14.9
EWSR15.0	<input type="checkbox"/>	15.0	91	153	15.0
EWSR15.5	<input type="checkbox"/>	15.5	94	157	15.5
EWSR16.0	<input type="checkbox"/>	16.0	96	160	16.0
EWSR16.5	<input type="checkbox"/>	16.5	102	167	16.5
EWSR17.0	<input type="checkbox"/>	17.0	102	167	17.0
EWSR17.5	<input type="checkbox"/>	17.5	102	167	17.5
EWSR18.0	<input type="checkbox"/>	18.0	102	167	18.0
EWSR18.5	<input type="checkbox"/>	18.5	114	179	18.5
EWSR19.0	<input type="checkbox"/>	19.0	114	179	19.0
EWSR19.5	<input type="checkbox"/>	19.5	114	179	19.5
EWSR20.0	<input type="checkbox"/>	20.0	114	179	20.0

Boring Tools

Stocked by Specified distributor

○ 対応被削材 Applicable work materia

軟鋼 Mild steel SS	炭素鋼 Carbon steel S	合金鋼 Alloy steel SCM, SCr	調質鋼 Heat-treated steel SKD, SKS	工具鋼 Tool steel ~40HRC	焼入れ鋼 Hardened steel ~45HRC, 45HRC~	ステンレス鋼 Stainless steel SUS	耐熱鋼 Ti合金 Heat-resistant steel, Ti alloy Inconel	鑄鉄 Cast iron FC	ダクタイル鑄鉄 Ductile cast iron FCD	アルミ合金 Aluminum alloy Al	銅合金 Copper alloy Cu
○	○	○	○	○	○	○	○	○	○	○	○

○ 再研磨対応外径範囲 Re-grinding compatibility range

商品コード Item code	エンド End (mm)
EWSR	3 ~ 20

標準切削条件表 Recommended cutting conditions

EWSS スタブ形 Stub	EWSR レギュラー形 Regular
-----------------------------	----------------------------------

ウェット加工標準切削条件表 Recommended Cutting Conditions for Wet

被削材 Work material	構造用鋼 Mild Steels SS			炭素鋼 Carbon steels (200HB) S〇〇C			合金鋼 Alloy steels (~30HRC) SCM			
	50~85~120			50~75~120			50~65~100			
切削速度 v_c Cutting speed (m/min)	直径 Tool dia.	回転数 n (min^{-1})	送り速度 v_f (mm/min)	送り量 f (mm/rev)	回転数 n (min^{-1})	送り速度 v_f (mm/min)	送り量 f (mm/rev)	回転数 n (min^{-1})	送り速度 v_f (mm/min)	送り量 f (mm/rev)
	$\phi 3$	9,000	900	0.08~0.12	7,950	600	0.06~0.09	6,900	520	0.06~0.09
	$\phi 4$	6,750	900	0.1~0.16	5,950	600	0.08~0.12	5,150	520	0.08~0.12
	$\phi 5$	5,400	900	0.13~0.2	4,800	600	0.1~0.15	4,150	520	0.1~0.15
	$\phi 6$	4,500	900	0.15~0.24	4,000	600	0.12~0.18	3,450	520	0.12~0.18
	$\phi 8$	3,400	900	0.2~0.32	3,000	600	0.16~0.24	2,600	520	0.16~0.24
	$\phi 10$	2,700	880	0.25~0.4	2,400	600	0.2~0.3	2,050	510	0.2~0.3
	$\phi 12$	2,250	870	0.3~0.47	2,000	590	0.24~0.35	1,750	510	0.24~0.35
	$\phi 14$	1,950	860	0.35~0.53	1,700	580	0.28~0.4	1,500	510	0.28~0.4
	$\phi 16$	1,700	830	0.4~0.58	1,500	570	0.32~0.44	1,300	490	0.32~0.44
	$\phi 20$	1,350	790	0.5~0.67	1,200	550	0.4~0.52	1,050	480	0.4~0.52

被削材 Work material	プリハードン鋼 Pre-hardened steels (~50HRC) SKD、HPM			ダクタイル鋳鉄 Ductile Cast Irons FCD			
	15~20~30			50~75~100			
切削速度 v_c Cutting speed (m/min)	直径 Tool dia.	回転数 n (min^{-1})	送り速度 v_f (mm/min)	送り量 f (mm/rev)	回転数 n (min^{-1})	送り速度 v_f (mm/min)	送り量 f (mm/rev)
	$\phi 3$	2,100	120	0.05~0.07	7,950	420	0.04~0.06
	$\phi 4$	1,600	120	0.06~0.09	5,950	420	0.06~0.08
	$\phi 5$	1,250	120	0.08~0.11	4,800	420	0.07~0.11
	$\phi 6$	1,050	120	0.09~0.14	4,000	420	0.08~0.12
	$\phi 8$	800	120	0.12~0.18	3,000	420	0.11~0.17
	$\phi 10$	640	120	0.17~0.21	2,400	420	0.14~0.21
	$\phi 12$	530	115	0.19~0.24	2,000	420	0.17~0.25
	$\phi 14$	450	115	0.23~0.28	1,700	410	0.2~0.28
	$\phi 16$	400	110	0.24~0.31	1,500	390	0.22~0.3
	$\phi 20$	320	110	0.3~0.4	1,200	380	0.28~0.36

- [注意]**
- 被削材、加工形状に合わせて、適切なクーラントを使用してください。
 - この標準切削条件表は切削条件の目安を示すものです。実際の加工では加工形状、目的、使用機械等により条件を調整してください。
 - この切削条件表は、穴の深さが直径の3倍までに適用してください。
 - 被削材の材質や硬さにより、切削性が変化することがあります。
 - ドリルを装着するときは、キズや汚れのないコレットを使用し、ドリルの振れは0.02mm以下におさえてください。
 - 高速加工をする場合は、キズや汚れのないコレットを使用し、ドリルの振れは0.01mm以下におさえてください。
 - 連続した切りくずが生成される場合は、この切削条件表の範囲で回転数を下げ、送り量を上げて分断された切りくずが生成されるように切削条件を選定してください。
 - 切削液（水溶性：希釈率20倍以下）は加工ポイントに十分に供給してください。
 - 食い付き性に優れていますので、センタドリルやスターティングドリルによる位置決め加工は不要です。位置決め加工をしますとチッピングが発生する恐れがあります。位置決め加工をした場合は、食い付き時の送り量をこの切削条件表の1/3にしてください。
 - チタン合金や耐熱鋼、オーステナイト系ステンレス鋼（SUS304等）の加工にはおすすめできません。
 - 機械剛性、ワーククランプその他の状況により切削条件を選定してください。
 - 油性の切削油剤を使用する場合は切削速度範囲の下限より低速の条件でご使用ください。また、切りくずおよび工具の発熱による発煙・引火にご注意ください。

- [Note]**
- Use the appropriate coolant for the work material and machining shape.
 - These Recommended Cutting Conditions indicate only the rule of a thumb for the cutting conditions. In actual machining, the condition should be adjusted according to the machining shape, purpose and the machine type.
 - This Cutting Condition Table only applies to the hole having a depth up to 3 times its diameter.
 - Machineability may vary depending on the material quality and hardness of a work.
 - When attaching a drill, use a clean and flawless collet. Keep the drill deflection within 0.02mm. In case of high speed drilling, use a clean and flawless collet. Keep the drill deflection within 0.01mm.
 - If continuous chips are produced, lower the rpm within this cutting condition and increase the feed rate. Select a suitable cutting condition so that very short cut chips are produced.
 - Supply sufficient amount of cutting fluid to a machining point (water soluble type: dilution ratio to be 20 times or less).
 - It bites the surface quickly. There is no need of a center hole drill or starting drill for positioning. A positioning drill may produce extra chipping. If, however, positioning drill must be used, set the feed rate (at the time of initial biting) to 1/3 the figures in the cutting condition column.
 - This drill is not applicable for titanium alloy, heat resistant steel or austenitic stainless steel (SUS 304 or the like).
 - Select cutting condition according to the rigidity of machine or work clamp state.
 - When using oil-based cutting agent, use conditions below the lower limit of the cutting speed range. In addition, be careful of smoke or fire due to cutting chips or heating of tool.

穴あけ工具

特定代理店在庫

EWSS

スタブ形
Stub

EWSR

レギュラー形
Regular

■ ドライ加工標準切削条件表 Recommended Cutting Conditions for Dry

被削材 Work material	構造用鋼 Mild Steels SS			炭素鋼 Carbon steels (200HB) S〇〇C			合金鋼 Alloy steels (~30HRC) SCM		
	50~70~90			50~65~80			50~65~80		
切削速度 v_c Cutting speed (m/min)									
直径 Tool dia.	回転数 n (min^{-1})	送り速度 v_f (mm/min)	送り量 f (mm/rev)	回転数 n (min^{-1})	送り速度 v_f (mm/min)	送り量 f (mm/rev)	回転数 n (min^{-1})	送り速度 v_f (mm/min)	送り量 f (mm/rev)
φ3	7,450	560	0.06~0.09	6,900	520	0.06~0.09	6,900	490	0.06~0.08
φ4	5,550	560	0.08~0.12	5,150	520	0.08~0.12	5,150	490	0.08~0.1
φ5	4,450	560	0.1~0.15	4,150	520	0.1~0.15	4,150	480	0.1~0.13
φ6	3,700	560	0.12~0.18	3,450	520	0.12~0.18	3,450	470	0.12~0.15
φ8	2,800	560	0.16~0.24	2,600	520	0.16~0.24	2,600	470	0.16~0.2
φ10	2,250	560	0.2~0.3	2,050	520	0.2~0.3	2,050	470	0.2~0.25
φ12	1,850	560	0.24~0.36	1,750	520	0.24~0.36	1,750	470	0.24~0.3
φ14	1,600	560	0.28~0.42	1,500	520	0.28~0.42	1,500	470	0.28~0.35
φ16	1,400	560	0.32~0.48	1,300	520	0.32~0.48	1,300	470	0.32~0.4
φ20	1,100	550	0.4~0.6	1,050	520	0.4~0.6	1,050	470	0.4~0.5

被削材 Work material	プリハードン鋼 Pre-hardened steels (~50HRC) SKD、HPM			ダクタイル鋳鉄 Ductile Cast Irons FCD		
	15~20~30			50~65~80		
切削速度 v_c Cutting speed (m/min)						
直径 Tool dia.	回転数 n (min^{-1})	送り速度 v_f (mm/min)	送り量 f (mm/rev)	回転数 n (min^{-1})	送り速度 v_f (mm/min)	送り量 f (mm/rev)
φ3	2,100	84	0.03~0.05	6,900	360	0.04~0.06
φ4	1,600	80	0.04~0.06	5,150	360	0.06~0.08
φ5	1,250	80	0.05~0.08	4,150	360	0.07~0.11
φ6	1,050	80	0.06~0.09	3,450	360	0.08~0.12
φ8	800	80	0.08~0.12	2,600	360	0.11~0.17
φ10	640	80	0.1~0.15	2,050	360	0.14~0.21
φ12	530	80	0.12~0.18	1,750	360	0.17~0.25
φ14	450	80	0.14~0.21	1,500	360	0.2~0.28
φ16	400	80	0.16~0.24	1,300	340	0.22~0.3
φ20	320	80	0.2~0.3	1,050	340	0.28~0.36

- [注意]**
- 被削材、加工形状に合わせて、適切なクーラントを使用してください。
 - この標準切削条件表は切削条件の目安を示すものです。実際の加工では加工形状、目的、使用機械等により条件を調整してください。
 - 切りくずの除去効果のため、エアブローを行ってください。
 - この切削条件表は、穴の深さが直径の3倍までに適用してください。
 - 被削材の材質や硬さにより、切削性が変化する場合があります。
 - ドリルを装着するときは、キズや汚れのないコレットを使用し、ドリルの振れは0.02mm以下におさえてください。
 - 高速加工する場合は、キズや汚れのないコレットを使用し、ドリルの振れは0.01mm以下におさえてください。
 - 連続した切りくずが生成される場合は、この切削条件表の範囲で回転数を下げ、送り量を上げて分断された切りくずが生成されるように切削条件を選定してください。
 - 切りくずが飛散しますので必ず安全カバーをしてください。
 - 食い付き性に優れていますので、センタドリルやスターティングドリルによる位置決め加工は不要です。位置決め加工をしますとチッピングが発生する恐れがあります。位置決め加工をした場合は、食い付き時の送り量をこの切削条件表の1/3にしてください。
 - チタン合金や耐熱鋼、オーステナイト系ステンレス鋼(SUS304等)の加工にはおすすりできません。
 - 機械剛性、ワーククランプその他の状況により切削条件を選定してください。

- [Note]**
- Use the appropriate coolant for the work material and machining shape.
 - These Recommended Cutting Conditions indicate only the rule of a thumb for the cutting conditions. In actual machining, the condition should be adjusted according to the machining shape, purpose and the machine type.
 - Perform air blowing to expedite chips removal.
 - This Cutting Condition Table only applies to the hole having a depth up to 3 times its diameter.
 - Machineability may vary depending on the material quality and hardness of a work.
 - When attaching a drill, use a clean and flawless collet. Keep the drill deflection within 0.02mm. In case of high speed drilling, use a clean and flawless collet. Keep the drill deflection within 0.01mm.
 - If continuous chips are produced, lower the rpm within this cutting condition and increase the feed rate. Select a suitable cutting condition so that very short cut chips are produced.
 - Be sure to put a safety cover to prevent chips from scattering.
 - It bites the surface quickly. There is no need of a center hole drill or starting drill for positioning. A positioning drill may produce extra chipping. If, however, positioning drill must be used, set the feed rate (at the time of initial biting) to 1/3 the figures in the cutting condition column.
 - This drill is not applicable for titanium alloy, heat resistant steel or austenitic stainless steel (SUS 304 or the like).
 - Select cutting condition according to the rigidity of machine or work clamp state.

ねじ切り・面取り工具

Threading / Chamfering Tools

超硬タップ

Carbide Taps

エポックスーパーハードタップ ESHT-THF2
Epoch Super Hard Tap

エポックハードタップ EHT-THF3
Epoch Hard Tap

超硬ねじ切りカッタ

Carbide Threading Cutters

エポックスレッドミル ET-PNF4
Epoch Thread Mill

エポックDスレッドミル EDT-THF6
Epoch D Thread Mill

エポックDスレッドミル PT・NPTねじ用 EDT-(□)PT-ATH...F10
Epoch D Thread Mill for PT, NPT Threads

面取り工具

Chamfering Tools

高硬度鋼加工用面取り工具 DN2HC-ATH...F15
Chamfering Tool for Hardened Steels

Epoch Super Hard Tap エポックスーパーハードタップ

50HRC以上の焼き入れ材を 安定して加工!

Stably machines tempered materials with hardnesses of 50HRC or more!



形状・寸法 Dimensions

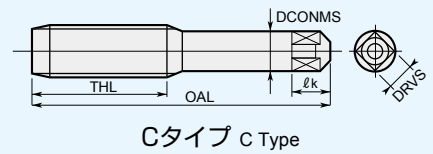
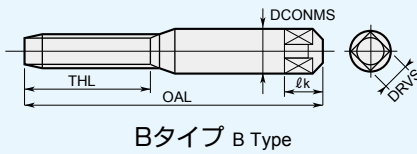
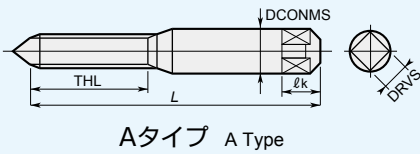

ESHT \circ -M $\circ\circ$ - \circ . $\circ\circ$ -TH

単位：mm Unit: mm

超硬 TH 切削条件表 F2
Carbide Cutting Conditions

商品コード Item code	在庫 Stock	呼び Size TDZ	ピッチ Pitch TP	ねじ部精度 Thread accuracy d ₂ 許容差域(+) Tolerance zone	食付き 山数 No. of threads	ねじ長 Thread length THL	全長 Overall length L OAL	シャンク径 Shank dia. DCONMS	溝数 Flutes	形状 Type	DRVS	ℓk	希望小売価格 (円) Suggested retail price (¥)
						ねじ長 Thread length THL	全長 Overall length L OAL	シャンク径 Shank dia. DCONMS					
ESHT5-M3-0.5-TH	●	M3	0.5	55~40	5	11	46	5	4	A	4	7	11,570
ESHT5-M4-0.7-TH	●	M4	0.7	60~40	5	13	52	5.5	4	A	4.5	7	12,020
ESHT5-M5-0.8-TH	●	M5	0.8	60~40	5	16	60	6	4	A	4.5	7	12,470
ESHT5-M6-1.0-TH	●	M6	1	60~40	5	19	62	6.2	5	B	5	8	13,700
ESHT5-M8-1.25-TH	●	M8	1.25	80~60	5	22	70	7	5	C	5.5	8	16,830
ESHT5-M10-1.5-TH	●	M10	1.5	80~60	5	24	75	8.5	5	C	6.5	9	22,680
ESHT5-M12-1.75-TH	●	M12	1.75	80~60	5	30	82	10.5	5	C	8	11	29,180

d₂許容差域：タップ有効径許容差域(上の許容差～下の許容差：単位μm)を示します。

d₂ tolerance zone : The pitch diameter tolerance to tap is shown from upper tolerance to lower tolerance by μm.

※タップの精度はめねじ精度を保証するものではありません。

Tap accuracy does not guarantee thread accuracy.

標準切削条件表 Recommended cutting conditions

被削材 Work material	切削速度の目安 General criteria for cutting speed
焼入れ鋼 Hardened steel (50~55HRC)	2~5m/min
焼入れ鋼 Hardened steel (55~60HRC)	1~3m/min

【注意】①被削材、加工形状に合わせて、適切なクーラントを使用してください。

②この標準切削条件表は切削条件の目安を示すものです。実際の加工では加工形状、目的、使用機械等により条件を調整してください。

【Note】①Use the appropriate coolant for the work material and machining shape.

②These Recommended Cutting Conditions indicate only the rule of a thumb for the cutting conditions. In actual machining, the condition should be adjusted according to the machining shape, purpose and the machine type.

●印：標準在庫品です。 ●：Stocked items.

Epoch Hard Tap エポックハードタップ

**35~50HRCの焼き入れ材の
安定加工が可能!**

Enables stable machining of tempered materials with hardnesses of 35 to 50HRC.



形状・寸法 Dimensions

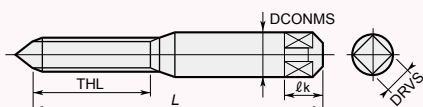

Aタイプ A Type

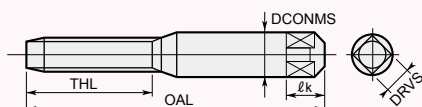

Bタイプ B Type

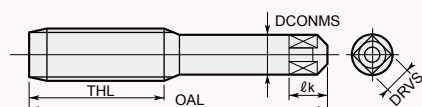

Cタイプ C Type

EHT-M- - -TH

単位：mm Unit: mm

超硬 TH Cutting Conditions F3

商品コード Item code	在庫 Stock	呼び Size TDZ	ピッチ Pitch TP	ねじ部精度 Thread accuracy d ₂ 許容差域(+) Tolerance zone	食付き 山数 No. of threads	ねじ長 Thread length THL	全長 Overall length L OAL	シャンク径 Shank dia. DCONMS	溝数 Flutes	形状 Type	希望小売価格 (円) Suggested retail price (¥)		
											DRVS	ℓk	
EHT3-M3-0.5-TH	●	M3	0.5	55~40	3	11	46	5	4	A	4	7	11,570
EHT5-M3-0.5-TH	●				5								11,570
EHT3-M4-0.7-TH	●	M4	0.7	60~40	3	13	52	5.5	4	A	4.5	7	12,020
EHT5-M4-0.7-TH	●				5								12,020
EHT3-M5-0.8-TH	●	M5	0.8	60~40	3	16	60	6	4	A	4.5	7	12,470
EHT5-M5-0.8-TH	●				5								12,470
EHT3-M6-1.0-TH	●	M6	1	60~40	3	19	62	6.2	4	B	5	8	13,700
EHT5-M6-1.0-TH	●				5								13,700
EHT3-M8-1.25-TH	●	M8	1.25	80~60	3	22	70	7	4	C	5.5	8	16,830
EHT5-M8-1.25-TH	●				5								16,830
EHT3-M10-1.5-TH	●	M10	1.5	80~60	3	24	75	8.5	4	C	6.5	9	22,680
EHT5-M10-1.5-TH	●				5								22,680
EHT3-M12-1.75-TH	●	M12	1.75	80~60	3	30	82	10.5	4	C	8	11	29,180
EHT5-M12-1.75-TH	●				5								29,180

d₂許容差域：タップ有効径許容差域(上の許容差~下の許容差：単位μm)を示します。

d₂ tolerance zone : The pitch diameter tolerance to tap is shown from upper tolerance to lower tolerance by μm.

※タップの精度はめねじ精度を保証するものではありません。 Tap accuracy does not guarantee thread accuracy.

標準切削条件表 Recommended cutting conditions

被削材 Work material	切削速度の目安 General criteria for cutting speed
プリハードン鋼 Pre-hardened steel (35~45HRC)	3~6m/min
焼入れ鋼 Hardened steel (45~50HRC)	2~4m/min

【注意】 ①被削材、加工形状に合わせて、適切なクーラントを使用してください。
②この標準切削条件表は切削条件の目安を示すものです。実際の加工では加工形状、目的、使用機械等により条件を調整してください。

【Note】 ①Use the appropriate coolant for the work material and machining shape.
②These Recommended Cutting Conditions indicate only the rule of a thumb for the cutting conditions. In actual machining, the condition should be adjusted according to the machining shape, purpose and the machine type.

Epoch Thread Mill エポックスレッドミル



弊社WebよりNCプログラムの作成ができます。

You can create NC programs on our website!
www.moldino.com/technical/nc-et/

左刃のため主轴逆転でご使用ください。

Left-hand cutting edge so reverse rotation of spindle should be used.

タップに比べて工具の折れ込みリスクを低減（下穴必要）
Reduces risk of breaking off inside compared to the tap (Under hole necessary)

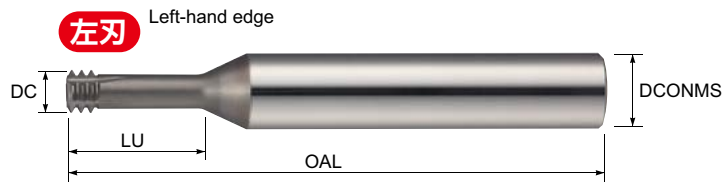
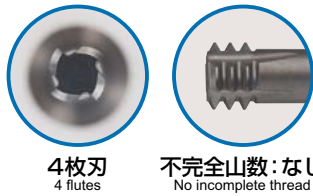

ET-○.○.○.○.○.○-PN

単位：mm Unit：mm



商品コード Item code	在庫 Stock	呼び径 Thread dia.	ピッチ Pitch	外径 Tool dia.	首下長 Under neck length	全長 Overall length	シャンク径 Shank dia.	オイル ホール Oil hole	希望小売価格 (円) Suggested retail price(¥)
		D1	TP	DC	LU	OAL	DCONMS		
メトルねじ用 2Dタイプ 首下長 D1×2倍 For Metric threads 2D type Under neck length: 2 × D1	<input type="checkbox"/>	M2	0.4	1.4	4	50	6	-	-
	<input type="checkbox"/>	M2.2	0.45	1.6	4.4	50	6	-	-
	<input type="checkbox"/>	M2.5	0.45	1.8	5	50	6	-	-
	<input checked="" type="checkbox"/>	M3	0.5	2.4	6	50	6	-	10,120
	<input checked="" type="checkbox"/>	M4	0.7	3.1	8	50	6	-	10,330
	<input checked="" type="checkbox"/>	M5	0.8	3.8	10	50	6	-	10,650
	<input checked="" type="checkbox"/>	M6	1	4.6	12	50	6	-	10,870
	<input checked="" type="checkbox"/>	M8	1.25	6.2	16	70	10	-	16,960
	<input checked="" type="checkbox"/>	M10	1.5	7.5	20	70	10	-	17,630
	<input checked="" type="checkbox"/>	M12	1.75	9	24	80	10	-	18,860
メトルねじ用 2.5Dタイプ 首下長 D1×2.5倍 For Metric threads 2.5D type Under neck length: 2.5 × D1	<input type="checkbox"/>	M2	0.4	1.4	5	50	6	-	-
	<input type="checkbox"/>	M2.2	0.45	1.6	5.5	50	6	-	-
	<input type="checkbox"/>	M2.5	0.45	1.8	6.25	50	6	-	-
	<input checked="" type="checkbox"/>	M3	0.5	2.4	7.5	50	6	-	10,120
	<input checked="" type="checkbox"/>	M4	0.7	3.1	10	50	6	-	10,330
	<input checked="" type="checkbox"/>	M5	0.8	3.8	12.5	50	6	-	10,650
	<input checked="" type="checkbox"/>	M6	1	4.6	15	50	6	-	10,870
	<input checked="" type="checkbox"/>	M8	1.25	6.2	20	70	10	-	16,960
	<input checked="" type="checkbox"/>	M10	1.5	7.5	25	70	10	-	17,630
	<input checked="" type="checkbox"/>	M12	1.75	9	30	80	10	-	18,860
メトルねじ用 3Dタイプ 首下長 D1×3倍 For Metric threads 3D type Under neck length: 3 × D1	<input type="checkbox"/>	M16	2	11.5	32	100	12	-	-
	<input type="checkbox"/>	M18	2.5	14	36	135	16	○	-
	<input type="checkbox"/>	M20	2.5	15	40	135	16	○	-
	<input checked="" type="checkbox"/>	M3	0.5	2.4	9	55	6	-	11,140
	<input checked="" type="checkbox"/>	M4	0.7	3.1	12	55	6	-	11,370
	<input checked="" type="checkbox"/>	M5	0.8	3.8	15	60	6	-	11,720
	<input checked="" type="checkbox"/>	M6	1	4.6	18	60	6	-	11,960
メトルねじ用 3.5Dタイプ 首下長 D1×3.5倍 For Metric threads 3.5D type Under neck length: 3.5 × D1	<input checked="" type="checkbox"/>	M8	1.25	6.2	24	80	10	-	18,650
	<input checked="" type="checkbox"/>	M10	1.5	7.5	30	80	10	-	19,390
	<input checked="" type="checkbox"/>	M12	1.75	9	36	95	10	-	20,740
	<input checked="" type="checkbox"/>	M16	2	11.5	48	120	12	-	25,290
	<input checked="" type="checkbox"/>	M3	0.5	2.4	10.5	55	6	-	11,140
	<input checked="" type="checkbox"/>	M4	0.7	3.1	14	55	6	-	11,370
	<input checked="" type="checkbox"/>	M5	0.8	3.8	17.5	60	6	-	11,720
<input checked="" type="checkbox"/>	M6	1	4.6	21	60	6	-	11,960	
<input checked="" type="checkbox"/>	M8	1.25	6.2	28	80	10	-	18,650	
<input checked="" type="checkbox"/>	M10	1.5	7.5	35	80	10	-	19,390	
<input checked="" type="checkbox"/>	M12	1.75	9	42	95	10	-	20,740	
<input checked="" type="checkbox"/>	M16	2	11.5	56	120	12	-	25,290	

※工具径補正についてはF12、F14頁を参照してください。

For information about tool diameter correction, refer to F12, F14.

●：標準在庫品です。 □印：特定代理店在庫です。弊社営業へお問合せください
●： Stocked items. □： Stocked by specified distributor. Contact with our sales department.

ET-U○○-○○.○-PN

単位 : mm Unit : mm

商品コード Item code	在庫 Stock	呼び径 Thread dia.		ピッチ Pitch	外径 Tool dia.	首下長 Under neck length	全長 Overall length	シャンク径 Shank dia.	オイル ホール Oil hole	希望小売価格 (円) Suggested retail price(¥)
		D1	TP	DC	LU	OAL	DCONMS			
ユニファイねじ用 2Dタイプ 首下長 D1×2倍 For Unified threads 2D type Under neck length: 2 × D1	<input type="checkbox"/>	No.1-64UNC	1.854	0.397	1.4	3.7	50	6	-	-
	<input type="checkbox"/>	No.2-56UNC	2.184	0.454	1.65	4.4	50	6	-	-
	<input type="checkbox"/>	No.3-48UNC	2.515	0.529	1.9	5	50	6	-	-
	<input type="checkbox"/>	No.4-40UNC	2.845	0.635	2.1	5.7	50	6	-	-
	<input type="checkbox"/>	No.6-32UNC	3.505	0.794	2.55	7	50	6	-	-
	<input type="checkbox"/>	No.8-36UNF	4.166	0.706	3.3	8.3	50	6	-	-
	<input type="checkbox"/>	No.10-24UNC	4.826	1.058	3.5	9.7	70	6	-	-
	<input type="checkbox"/>	1/4-20UNC	6.35	1.27	4.75	12.7	70	6	-	-
	<input type="checkbox"/>	1/4-28UNF	6.35	0.907	5	12.7	70	6	-	-
	<input type="checkbox"/>	5/16-18UNC	7.938	1.411	6	15.9	80	10	-	-
	<input type="checkbox"/>	3/8-16UNC	9.525	1.588	6.7	19.1	80	10	-	-
	<input type="checkbox"/>	7/16-14UNC	11.112	1.814	7.7	22.2	80	10	-	-
	<input type="checkbox"/>	1/2-13UNC	12.7	1.954	9.2	25.4	80	10	-	-
<input type="checkbox"/>	9/16-12UNC	14.288	2.117	10.5	28.6	100	12	-	-	
<input type="checkbox"/>	5/8-11UNC	15.875	2.309	11.4	31.8	100	12	-	-	
ユニファイねじ用 2.5Dタイプ 首下長 D1×2.5倍 For Unified threads 2.5D type Under neck length: 2.5 × D1	<input type="checkbox"/>	No.1-64UNC	1.854	0.397	1.4	4.6	50	6	-	-
	<input type="checkbox"/>	No.2-56UNC	2.184	0.454	1.65	5.5	50	6	-	-
	<input type="checkbox"/>	No.3-48UNC	2.515	0.529	1.9	6.3	50	6	-	-
	<input type="checkbox"/>	No.4-40UNC	2.845	0.635	2.1	7.1	50	6	-	-
	<input type="checkbox"/>	No.6-32UNC	3.505	0.794	2.55	8.8	50	6	-	-
	<input type="checkbox"/>	No.8-36UNF	4.166	0.706	3.3	10.4	50	6	-	-
	<input type="checkbox"/>	No.10-24UNC	4.826	1.058	3.5	12.1	70	6	-	-
	<input type="checkbox"/>	1/4-20UNC	6.35	1.27	4.75	15.9	70	6	-	-
	<input type="checkbox"/>	1/4-28UNF	6.35	0.907	5	15.9	70	6	-	-
	<input type="checkbox"/>	5/16-18UNC	7.938	1.411	6	19.8	80	10	-	-
	<input type="checkbox"/>	3/8-16UNC	9.525	1.588	6.7	23.8	80	10	-	-
	<input type="checkbox"/>	7/16-14UNC	11.112	1.814	7.7	27.8	80	10	-	-
	<input type="checkbox"/>	1/2-13UNC	12.7	1.954	9.2	31.8	80	10	-	-
<input type="checkbox"/>	9/16-12UNC	14.288	2.117	10.5	35.7	100	12	-	-	
<input type="checkbox"/>	5/8-11UNC	15.875	2.309	11.4	39.7	100	12	-	-	

Threading Tools

Epoch D Thread Mill エポックDスレッドミル



弊社WebよりNCプログラムの作成ができます。
You can create NC programs on our website!
www.moldino.com/technical/nc-et/
左刃のため主軸逆転でご使用ください。
Left-hand cutting edge so reverse rotation of spindle should be used.

1本の工具で下穴とねじ切り同時加工が可能
This single tool can perform both drilling and threading simultaneously.

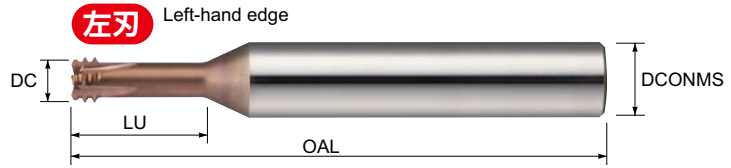

EDT-○○.○○.○○-○○.○○-TH

単位: mm Unit: mm



商品コード Item code	在庫 Stock	呼び径 Thread dia.	ピッチ Pitch	外径 Tool dia.	首下長 Under neck length	全長 Overall length	シャンク径 Shank dia.	オイル ホール Oil hole	希望小売価格 (円) Suggested retail price(¥)
		D1	TP	DC	LU	OAL	DCONMS		
メトルねじ用 2Dタイプ 首下長 D1×2倍 For Metric threads 2D type Under neck length: 2 × D1	<input type="checkbox"/>	M2	0.4	1.4	4	50	6	-	-
	<input type="checkbox"/>	M2.2	0.45	1.6	4.4	50	6	-	-
	<input type="checkbox"/>	M2.5	0.45	1.8	5	50	6	-	-
	<input checked="" type="checkbox"/>	M3	0.5	2.4	6	50	6	-	11,130
	<input checked="" type="checkbox"/>	M4	0.7	3.1	8	50	6	-	11,350
	<input checked="" type="checkbox"/>	M5	0.8	3.8	10	50	6	-	11,680
	<input checked="" type="checkbox"/>	M6	1	4.6	12	50	6	-	11,910
	<input checked="" type="checkbox"/>	M8	1.25	6.2	16	70	10	-	18,640
	<input checked="" type="checkbox"/>	M10	1.5	7.5	20	70	10	○	19,420
	<input checked="" type="checkbox"/>	M12	1.75	9	24	80	10	○	20,760
メトルねじ用 2.5Dタイプ 首下長 D1×2.5倍 For Metric threads 2.5D type Under neck length: 2.5 × D1	<input type="checkbox"/>	M2	0.4	1.4	5	50	6	-	-
	<input type="checkbox"/>	M2.2	0.45	1.6	5.5	50	6	-	-
	<input type="checkbox"/>	M2.5	0.45	1.8	6.25	50	6	-	-
	<input checked="" type="checkbox"/>	M3	0.5	2.4	7.5	50	6	-	11,130
	<input checked="" type="checkbox"/>	M4	0.7	3.1	10	50	6	-	11,350
	<input checked="" type="checkbox"/>	M5	0.8	3.8	12.5	50	6	-	11,680
	<input checked="" type="checkbox"/>	M6	1	4.6	15	50	6	-	11,910
	<input checked="" type="checkbox"/>	M8	1.25	6.2	20	70	10	-	18,640
	<input checked="" type="checkbox"/>	M10	1.5	7.5	25	70	10	○	19,420
	<input checked="" type="checkbox"/>	M12	1.75	9	30	80	10	○	20,760
メトルねじ用 3Dタイプ 首下長 D1×3倍 For Metric threads 3D type Under neck length: 3 × D1	<input checked="" type="checkbox"/>	M3	0.5	2.4	9	55	6	-	12,240
	<input checked="" type="checkbox"/>	M4	0.7	3.1	12	55	6	-	12,480
	<input checked="" type="checkbox"/>	M5	0.8	3.8	15	60	6	-	12,840
	<input checked="" type="checkbox"/>	M6	1	4.6	18	60	6	-	13,090
	<input checked="" type="checkbox"/>	M8	1.25	6.2	24	80	10	-	20,500
	<input checked="" type="checkbox"/>	M10	1.5	7.5	30	80	10	○	21,370
メトルねじ用 3.5Dタイプ 首下長 D1×3.5倍 For Metric threads 3.5D type Under neck length: 3.5 × D1	<input checked="" type="checkbox"/>	M12	1.75	9	36	95	10	○	22,840
	<input checked="" type="checkbox"/>	M16	2	11.5	48	120	12	○	27,750
	<input checked="" type="checkbox"/>	M3	0.5	2.4	10.5	55	6	-	12,240
	<input checked="" type="checkbox"/>	M4	0.7	3.1	14	55	6	-	12,480
	<input checked="" type="checkbox"/>	M5	0.8	3.8	17.5	60	6	-	12,840
	<input checked="" type="checkbox"/>	M6	1	4.6	21	60	6	-	13,090
	<input checked="" type="checkbox"/>	M8	1.25	6.2	28	80	10	-	20,500
	<input checked="" type="checkbox"/>	M10	1.5	7.5	35	80	10	○	21,370
<input checked="" type="checkbox"/>	M12	1.75	9	42	95	10	○	22,840	
<input checked="" type="checkbox"/>	M16	2	11.5	56	120	12	○	27,750	

* 工具径補正についてはF12、F14頁を参照してください。
For information about tool diameter correction, refer to F12, F14.

● : 標準在庫品です。 □印 : 特定代理店在庫です。弊社営業へお問合せください
● : Stocked items. □ : Stocked by specified distributor. Contact with our sales department.

EDT-U○○.○○-○○.○-TH

単位：mm Unit: mm



商品コード Item code	在庫 Stock	呼び径 Thread dia.	ピッチ Pitch	外径 Tool dia.	首下長 Under neck length	全長 Overall length	シャンク径 Shank dia.	オイル ホール Oil hole	希望小売価格 Suggested retail price(¥)	
		D ₁	TP	DC	LU	OAL	DCONMS			
ユニファイねじ用 2Dタイプ 首下長 D₁×2倍 For Unified threads 2D type Under neck length: 2 × D ₁	<input type="checkbox"/>	No.1-64UNC	1.854	0.397	1.4	3.7	50	6	-	-
	<input type="checkbox"/>	No.2-56UNC	2.184	0.454	1.65	4.4	50	6	-	-
	<input type="checkbox"/>	No.3-48UNC	2.515	0.529	1.9	5	50	6	-	-
	<input type="checkbox"/>	No.4-40UNC	2.845	0.635	2.1	5.7	50	6	-	-
	<input type="checkbox"/>	No.6-32UNC	3.505	0.794	2.55	7	50	6	-	-
	<input type="checkbox"/>	No.8-36UNF	4.166	0.706	3.3	8.3	50	6	-	-
	<input type="checkbox"/>	No.10-24UNC	4.826	1.058	3.5	9.7	70	6	-	-
	<input type="checkbox"/>	¼-20UNC	6.35	1.27	4.75	12.7	70	6	-	-
	<input type="checkbox"/>	¼-28UNF	6.35	0.907	5	12.7	70	6	-	-
	<input type="checkbox"/>	⅝-18UNC	7.938	1.411	6	15.9	80	10	-	-
	<input type="checkbox"/>	⅝-16UNC	9.525	1.588	6.7	19.1	80	10	-	-
	<input type="checkbox"/>	⅞-14UNC	11.112	1.814	7.7	22.2	80	10	○	-
	<input type="checkbox"/>	½-13UNC	12.7	1.954	9.2	25.4	80	10	○	-
	<input type="checkbox"/>	⅞-12UNC	14.288	2.117	10.5	28.6	100	12	○	-
<input type="checkbox"/>	⅝-11UNC	15.875	2.309	11.4	31.8	100	12	○	-	
ユニファイねじ用 2.5Dタイプ 首下長 D₁×2.5倍 For Unified threads 2.5D type Under neck length: 2.5 × D ₁	<input type="checkbox"/>	No.1-64UNC	1.854	0.397	1.4	4.6	50	6	-	-
	<input type="checkbox"/>	No.2-56UNC	2.184	0.454	1.65	5.5	50	6	-	-
	<input type="checkbox"/>	No.3-48UNC	2.515	0.529	1.9	6.3	50	6	-	-
	<input type="checkbox"/>	No.4-40UNC	2.845	0.635	2.1	7.1	50	6	-	-
	<input type="checkbox"/>	No.6-32UNC	3.505	0.794	2.55	8.8	50	6	-	-
	<input type="checkbox"/>	No.8-36UNF	4.166	0.706	3.3	10.4	50	6	-	-
	<input type="checkbox"/>	No.10-24UNC	4.826	1.058	3.5	12.1	70	6	-	-
	<input type="checkbox"/>	¼-20UNC	6.35	1.27	4.75	15.9	70	6	-	-
	<input type="checkbox"/>	¼-28UNF	6.35	0.907	5	15.9	70	6	-	-
	<input type="checkbox"/>	⅝-18UNC	7.938	1.411	6	19.8	80	10	-	-
	<input type="checkbox"/>	⅝-16UNC	9.525	1.588	6.7	23.8	80	10	-	-
	<input type="checkbox"/>	⅞-14UNC	11.112	1.814	7.7	27.8	80	10	○	-
	<input type="checkbox"/>	½-13UNC	12.7	1.954	9.2	31.8	80	10	○	-
	<input type="checkbox"/>	⅞-12UNC	14.288	2.117	10.5	35.7	100	12	○	-
<input type="checkbox"/>	⅝-11UNC	15.875	2.309	11.4	39.7	100	12	○	-	

Threading Tools

エポックスレッドミル / エポックDスレッドミル

標準切削条件表 Recommended cutting conditions **ET-PN**

被削材 Work material		鋳鉄・炭素鋼 Cast Irons, Carbon steels 150~200HB FC250,S50C			ステンレス鋼 Stainless steels SUS304			工具鋼 Tool steels 25~35HRC SCM440, HPM7			プリハードン鋼 Pre-hardened steels 35~45HRC HPM-MAGIC,CENA1		
切削速度 v_c (m/min)		80 ~ 85 ~ 90			70 ~ 75 ~ 80			60 ~ 65 ~ 70					
呼び径 D_1 Thread Dia.	工具径 DC (mm) Tool Dia. (mm)	回転数 n (min^{-1})	送り速度 v_f (mm/min)	1刃送り量 f_z (mm/t)	回転数 n (min^{-1})	送り速度 v_f (mm/min)	1刃送り量 f_z (mm/t)	回転数 n (min^{-1})	送り速度 v_f (mm/min)	1刃送り量 f_z (mm/t)			
M2	1.4	19,300	208	0.009	17,100	164	0.008	14,800	142	0.008			
M2.2	1.6	16,900	203	0.011	14,900	163	0.01	12,900	141	0.01			
M2.5	1.8	15,000	202	0.012	13,300	164	0.011	11,500	142	0.011			
M3	2.4	11,300	154	0.017	9,900	127	0.016	8,600	103	0.015			
M4	3.1	8,700	188	0.024	7,700	152	0.022	6,700	127	0.021			
M5	3.8	7,100	198	0.029	6,300	163	0.027	5,400	130	0.025			
M6	4.6	5,900	204	0.037	5,200	170	0.035	4,500	134	0.032			
M8	6.2	4,400	198	0.05	3,900	165	0.047	3,300	128	0.043			
M10	7.5	3,600	216	0.06	3,200	179	0.056	2,800	148	0.053			
M12	9	3,000	216	0.072	2,700	184	0.068	2,300	145	0.063			
M16	11.5	2,400	235	0.087	2,100	194	0.082	1,800	154	0.076			
M18	14	1,900	171	0.101	1,700	144	0.095	1,500	117	0.088			
M20	15	1,800	184	0.102	1,600	154	0.096	1,400	125	0.089			
No.1-64UNC	1.4	19,300	170	0.009	17,100	134	0.008	14,800	116	0.008			
No.2-56UNC	1.65	16,400	176	0.011	14,500	156	0.011	12,500	122	0.01			
No.3-48UNC	1.9	14,200	181	0.013	12,600	148	0.012	10,900	117	0.011			
No.4-40UNC	2.1	12,900	203	0.015	11,400	167	0.014	9,900	135	0.013			
No.6-32UNC	2.55	10,600	208	0.018	9,400	174	0.017	8,100	141	0.016			
No.8-36UNF	3.3	8,200	170	0.025	7,200	144	0.024	6,300	115	0.022			
No.10-24UNC	3.5	7,700	228	0.027	6,800	187	0.025	5,900	149	0.023			
1/4-20UNC	4.75	5,700	218	0.038	5,000	181	0.036	4,400	146	0.033			
1/4-28UNF	5	5,400	184	0.04	4,800	155	0.038	4,100	122	0.035			
5/16-18UNC	6	4,500	211	0.048	4,000	176	0.045	3,400	139	0.042			
3/8-16UNC	6.7	4,000	256	0.054	3,600	214	0.05	3,100	173	0.047			
7/16-14UNC	7.7	3,500	267	0.062	3,100	221	0.058	2,700	179	0.054			
1/2-13UNC	9.2	2,900	237	0.074	2,600	198	0.069	2,200	155	0.064			
9/16-12UNC	10.5	2,600	221	0.08	2,300	183	0.075	2,000	148	0.07			
5/8-11UNC	11.4	2,400	235	0.087	2,100	192	0.081	1,800	154	0.076			

被削材 Work material		焼入れ鋼 Hardened steels 45~55HRC SKD61,HPM38			焼入れ鋼 Hardened steels 55~62HRC SKD11,YXR3			焼入れ鋼 Hardened steels 62~66HRC SKH51,HAP40		
切削速度 v_c (m/min)		50 ~ 55 ~ 60			40 ~ 45 ~ 50			30 ~ 35 ~ 40		
呼び径 D_1 Thread Dia.	工具径 DC (mm) Tool Dia. (mm)	回転数 n (min^{-1})	送り速度 v_f (mm/min)	1刃送り量 f_z (mm/t)	回転数 n (min^{-1})	送り速度 v_f (mm/min)	1刃送り量 f_z (mm/t)	回転数 n (min^{-1})	送り速度 v_f (mm/min)	1刃送り量 f_z (mm/t)
M2	1.4	12,500	105	0.007	10,200	73	0.006	8,000	58	0.006
M2.2	1.6	10,900	107	0.009	9,000	69	0.007	7,000	53	0.007
M2.5	1.8	9,700	109	0.01	8,000	72	0.008	6,200	56	0.008
M3	2.4	7,300	82	0.014	6,000	53	0.011	4,600	40	0.011
M4	3.1	5,600	96	0.019	4,600	62	0.015	3,600	49	0.015
M5	3.8	4,600	102	0.023	3,800	66	0.018	2,900	50	0.018
M6	4.6	3,800	106	0.03	3,100	67	0.023	2,400	52	0.023
M8	6.2	2,800	101	0.04	2,300	64	0.031	1,800	50	0.031
M10	7.5	2,300	113	0.049	1,900	72	0.038	1,500	57	0.038
M12	9	1,900	112	0.059	1,600	72	0.045	1,200	54	0.045
M16	11.5	1,500	120	0.071	1,200	74	0.055	1,000	62	0.055
M18	14	1,300	95	0.082	1,000	56	0.063	800	45	0.063
M20	15	1,200	100	0.083	1,000	64	0.064	700	45	0.064
No.1-64UNC	1.4	12,500	86	0.007	10,200	60	0.006	8,000	47	0.006
No.2-56UNC	1.65	10,600	93	0.009	8,700	60	0.007	6,800	47	0.007
No.3-48UNC	1.9	9,200	90	0.01	7,500	59	0.008	5,900	46	0.008
No.4-40UNC	2.1	8,300	104	0.012	6,800	64	0.009	5,300	50	0.009
No.6-32UNC	2.55	6,900	113	0.015	5,600	67	0.011	4,400	53	0.011
No.8-36UNF	3.3	5,300	88	0.02	4,300	57	0.016	3,400	45	0.016
No.10-24UNC	3.5	5,000	121	0.022	4,100	77	0.017	3,200	60	0.017
1/4-20UNC	4.75	3,700	116	0.031	3,000	73	0.024	2,300	56	0.024
1/4-28UNF	5	3,500	98	0.033	2,900	62	0.025	2,200	47	0.025
5/16-18UNC	6	2,900	110	0.039	2,400	70	0.03	1,900	56	0.03
3/8-16UNC	6.7	2,600	136	0.044	2,100	85	0.034	1,700	69	0.034
7/16-14UNC	7.7	2,300	141	0.05	1,900	91	0.039	1,400	67	0.039
1/2-13UNC	9.2	1,900	126	0.06	1,600	81	0.046	1,200	61	0.046
9/16-12UNC	10.5	1,700	117	0.065	1,400	74	0.05	1,100	58	0.05
5/8-11UNC	11.4	1,500	118	0.07	1,300	79	0.054	1,000	61	0.054

55HRCを超える被削材の場合、首下長3D・3.5Dタイプの最大加工深さは2.5D以下を推奨いたします。

With cutting materials exceeding 55HRC, the maximum machining depth should not exceed 2.5D for under neck length 3D and 3.5D type tools.

- [注意]**
- ①エポックスレッドミルはめねじ加工専用工具です。
 - ②上記切削条件表は、表中の呼び径でのものです。その他の呼び径の切削条件に関しては、使用上の注意点の項目(F14頁)を参照して算出してください。
 - ③上記条件表において、送り速度は、めねじ加工時の工具中心の送り速度を表しています。また、1刃送り量は切削点での数値を表しています。
 - ④機械内部に切りくずが入り込む危険性があるため、オイルホール付きの工具は必ずオイルホールを使用して加工を行ってください。
 - ⑤被削材、加工形状に合わせて、適切なクーラントを使用してください。
 - ⑥この切削条件表は切削条件の目安を示すものです。実際の加工では使用機械等により条件を調整してください。

- [Note]**
1. Epoch Thread Mill is an only for threading the inside of holes.
 2. The above cutting conditions are for the thread diameters stated in the table. Cutting conditions for other thread diameters should be calculated taking into consideration the Cautions on use (F14).
 3. The feed rate stated in the above conditions table is the feed rate at the tool center during threading. In addition, the per-tooth feed rate is the numerical value at the cutting point.
 4. Since there is a risk of cutting chips getting inside the machine, when using tools equipped with oil holes, be sure to use the oil holes.
 5. Use the appropriate coolant for the work material and machining shape.
 6. These conditions are for general guidance; in actual machining conditions adjust the parameters according to your actual machine conditions.

標準切削条件表 Recommended cutting conditions

EDT-TH

被削材 Work material		鑄鉄・炭素鋼 Cast Irons, Carbon steels 150 ~ 200HB FC250,S50C			工具鋼 Tool steels 25 ~ 35HRC SCM440,HPM7			プリハードン鋼 Pre-hardened steels 35 ~ 45HRC HPM-MAGIC,CENA 1		
切削速度 v_c (m/min)		80 ~ 85 ~ 90			70 ~ 75 ~ 80			60 ~ 65 ~ 70		
呼び径 D_1 Thread Dia.	工具径 DC(mm) Tool Dia.(mm)	回転数 n (min^{-1})	送り速度 v_f (mm/min)	1刃送り量 f_z (mm/t)	回転数 n (min^{-1})	送り速度 v_f (mm/min)	1刃送り量 f_z (mm/t)	回転数 n (min^{-1})	送り速度 v_f (mm/min)	1刃送り量 f_z (mm/t)
M2	1.4	19,300	139	0.006	17,100	123	0.006	14,800	107	0.006
M2.2	1.6	16,900	129	0.007	14,900	114	0.007	12,900	99	0.007
M2.5	1.8	15,000	134	0.008	13,300	119	0.008	11,500	103	0.008
M3	2.4	11,300	99	0.011	9,900	87	0.011	8,600	76	0.011
M4	3.1	8,700	117	0.015	7,700	104	0.015	6,700	90	0.015
M5	3.8	7,100	123	0.018	6,300	109	0.018	5,400	93	0.018
M6	4.6	5,900	127	0.023	5,200	112	0.023	4,500	97	0.023
M8	6.2	4,400	123	0.031	3,900	109	0.031	3,300	92	0.031
M10	7.5	3,600	137	0.038	3,200	122	0.038	2,800	106	0.038
M12	9	3,000	135	0.045	2,700	122	0.045	2,300	104	0.045
M16	11.5	2,400	149	0.055	2,100	130	0.055	1,800	111	0.055
M18	14	1,900	106	0.063	1,700	95	0.063	1,500	84	0.063
M20	15	1,800	115	0.064	1,600	102	0.064	1,400	90	0.064
M24	15	1,800	115	0.043	1,600	102	0.043	1,400	90	0.043
No.1-64UNC	1.4	19,300	113	0.006	17,100	100	0.006	14,800	87	0.006
No.2-56UNC	1.65	16,400	112	0.007	14,500	99	0.007	12,500	86	0.007
No.3-48UNC	1.9	14,200	111	0.008	12,600	99	0.008	10,900	85	0.008
No.4-40UNC	2.1	12,900	122	0.009	11,400	107	0.009	9,900	93	0.009
No.6-32UNC	2.55	10,600	127	0.011	9,400	113	0.011	8,100	97	0.011
No.8-36UNF	3.3	8,200	109	0.016	7,200	96	0.016	6,300	84	0.016
No.10-24UNC	3.5	7,700	144	0.017	6,800	127	0.017	5,900	110	0.017
1/4-20UNC	4.75	5,700	138	0.024	5,000	121	0.024	4,400	106	0.024
1/4-28UNF	5	5,400	115	0.025	4,800	102	0.025	4,100	87	0.025
5/16-18UNC	6	4,500	132	0.03	4,000	117	0.03	3,400	100	0.03
3/8-16UNC	6.7	4,000	161	0.034	3,600	145	0.034	3,100	125	0.034
7/16-14UNC	7.7	3,500	168	0.039	3,100	148	0.039	2,700	129	0.039
1/2-13UNC	9.2	2,900	147	0.046	2,600	132	0.046	2,200	112	0.046
9/16-12UNC	10.5	2,600	138	0.05	2,300	122	0.05	2,000	106	0.05
5/8-11UNC	11.4	2,400	146	0.054	2,100	128	0.054	1,800	110	0.054

被削材 Work material		焼入れ鋼 Hardened steels 45 ~ 55HRC SKD61,HPM38			焼入れ鋼 Hardened steels 55 ~ 62HRC SKD11,YXR3			焼入れ鋼 Hardened steels 62 ~ 66HRC SKH51,HAP40			ステンレス鋼 Stainless steels SUS304
切削速度 v_c (m/min)		50 ~ 55 ~ 60			40 ~ 45 ~ 50			30 ~ 35 ~ 40			
呼び径 D_1 Thread Dia.	工具径 DC(mm) Tool Dia.(mm)	回転数 n (min^{-1})	送り速度 v_f (mm/min)	1刃送り量 f_z (mm/t)	回転数 n (min^{-1})	送り速度 v_f (mm/min)	1刃送り量 f_z (mm/t)	回転数 n (min^{-1})	送り速度 v_f (mm/min)	1刃送り量 f_z (mm/t)	
M2	1.4	12,500	90	0.006	10,200	73	0.006	8,000	58	0.006	
M2.2	1.6	10,900	83	0.007	9,000	69	0.007	7,000	53	0.007	
M2.5	1.8	9,700	87	0.008	8,000	72	0.008	6,200	56	0.008	
M3	2.4	7,300	64	0.011	6,000	53	0.011	4,600	40	0.011	
M4	3.1	5,600	76	0.015	4,600	62	0.015	3,600	49	0.015	
M5	3.8	4,600	79	0.018	3,800	66	0.018	2,900	50	0.018	
M6	4.6	3,800	82	0.023	3,100	67	0.023	2,400	52	0.023	
M8	6.2	2,800	78	0.031	2,300	64	0.031	1,800	50	0.031	
M10	7.5	2,300	87	0.038	1,900	72	0.038	1,500	57	0.038	
M12	9	1,900	86	0.045	1,600	72	0.045	1,200	54	0.045	
M16	11.5	1,500	93	0.055	1,200	74	0.055	1,000	62	0.055	
M18	14	1,300	73	0.063	1,000	56	0.063	800	45	0.063	
M20	15	1,200	77	0.064	1,000	64	0.064	700	45	0.064	
M24	15	1,200	77	0.043	1,000	64	0.043	700	45	0.043	
No.1-64UNC	1.4	12,500	73	0.006	10,200	60	0.006	8,000	47	0.006	
No.2-56UNC	1.65	10,600	73	0.007	8,700	60	0.007	6,800	47	0.007	
No.3-48UNC	1.9	9,200	72	0.008	7,500	59	0.008	5,900	46	0.008	
No.4-40UNC	2.1	8,300	78	0.009	6,800	64	0.009	5,300	50	0.009	
No.6-32UNC	2.55	6,900	83	0.011	5,600	67	0.011	4,400	53	0.011	
No.8-36UNF	3.3	5,300	71	0.016	4,300	57	0.016	3,400	45	0.016	
No.10-24UNC	3.5	5,000	93	0.017	4,100	77	0.017	3,200	60	0.017	
1/4-20UNC	4.75	3,700	89	0.024	3,000	73	0.024	2,300	56	0.024	
1/4-28UNF	5	3,500	74	0.025	2,900	62	0.025	2,200	47	0.025	
5/16-18UNC	6	2,900	85	0.03	2,400	70	0.03	1,900	56	0.03	
3/8-16UNC	6.7	2,600	105	0.034	2,100	85	0.034	1,700	69	0.034	
7/16-14UNC	7.7	2,300	110	0.039	1,900	91	0.039	1,400	67	0.039	
1/2-13UNC	9.2	1,900	96	0.046	1,600	81	0.046	1,200	61	0.046	
9/16-12UNC	10.5	1,700	90	0.05	1,400	74	0.05	1,100	58	0.05	
5/8-11UNC	11.4	1,500	91	0.054	1,300	79	0.054	1,000	61	0.054	

55HRCを超える被削材の場合、首下長3D・3.5Dタイプの最大加工深さは2.5D以下を推奨いたします。
With cutting materials exceeding 55HRC, the maximum machining depth should not exceed 2.5D for under neck length 3D and 3.5D type tools.

- [注意]**
- ① エポックDスレッドミルはめねじ加工専用工具です。
 - ② 上記切削条件表は、表中の呼び径でのものです。その他の呼び径の切削条件に関しては、使用上の注意点の項目(F14頁)を参照して算出してください。
 - ③ 上記条件表において、送り速度は、めねじ加工時の工具中心の送り速度を表しています。また、1刃送り量は切削点での数値を表しています。
 - ④ 機械内部に切りくずが入り込む危険性があるため、オイルホール付きの工具は必ずオイルホールを使用して加工を行ってください。
 - ⑤ 被削材、加工形状に合わせて、適切なクーラントを使用してください。
 - ⑥ この切削条件表は切削条件の目安を示すものです。実際の加工では使用機械等により条件を調整してください。

- [Note]**
1. Epoch D Thread Mill is capable of simultaneous boring and threading.
 2. The above cutting conditions are for the thread diameters stated in the table. Cutting conditions for other thread diameters should be calculated taking into consideration the Cautions on use (F14).
 3. The feed rate stated in the above conditions table is the feed rate at the tool center during threading. In addition, the per-tooth feed rate is the numerical value at the cutting point.
 4. Since there is a risk of cutting chips getting inside the machine, when using tools equipped with oil holes, be sure to use the oil holes.
 5. Use the appropriate coolant for the work material and machining shape.
 6. These conditions are for general guidance; in actual machining conditions adjust the parameters according to your actual machine conditions.



弊社WebよりNCプログラムの作成ができます。
You can create NC programs on our website!
www.moldino.com/technical/nc-et/

左刃のため主軸逆転でご使用ください。
Left-hand cutting edge so reverse rotation of spindle should be used.

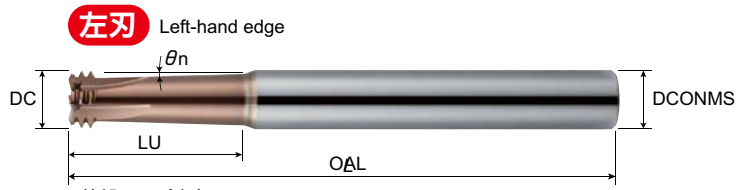

首部テーパ半角 Neck angle θ_n : 1.7°
※EDT-PT1(NPT1)-45-ATHの首はストレート($\theta_n=0^\circ$)です。
The neck angle (θ_n) of EDT-PT1(NPT1)-45-ATH is 0° (straight neck).



EDT-PT \circ \circ - \circ \circ -ATH

単位: mm Unit: mm

PT(Rc)ねじ用 for PT(Rc) threads	在庫 Stock	呼び径 Thread dia.		ピッチ Pitch	基準外径 Reference dia.	首下長 Under neck length	全長 Overall length	シャンク径 Shank dia.	オイルホール Oil Hole	呼び径補正量 Thread diameter compensation value	希望小売価格(円) Suggested retail price(¥)
		下穴不要 Pilot hole not required	下穴必要(下穴径) Pilot hole required (pilot hole diameter)								
		D_1	D_1								
商品コード Item code				TP	DC	LU	OAL	DCONMS		D_2	
EDT-PT1/16-18-ATH	●	PT $\frac{1}{16}$ -28 7.723	PT $\frac{1}{16}$ -28 ($\phi 4$ 以上) 9.728	0.9071	4.8	18	70	6	-	0.029	24,250
EDT-PT1/8-19-ATH	●	PT $\frac{1}{8}$ -28 9.728	-	0.9071	5.7	19	70	6	-	0.029	24,250
EDT-PT1/4-28-ATH	●	PT $\frac{1}{4}$ -19 13.157	PT $\frac{3}{8}$ -19 ($\phi 6$ 以上) 16.662	1.3368	7.9	28	80	10	-	0.043	35,470
EDT-PT3/8-28-ATH	●	PT $\frac{3}{8}$ -19 16.662	-	1.3368	9.6	28	80	10	-	0.043	35,470
EDT-PT1/2-35-ATH	●	PT $\frac{1}{2}$ -14 20.955	PT $\frac{3}{4}$ -14 ($\phi 8$ 以上) 26.441	1.8143	11.5	35	110	12	-	0.058	51,060
EDT-PT1-45-ATH	●	-	PT1-11 ($\phi 10$ 以上) 33.249	2.3091	15.4	45	135	16	-	0.074	98,520

EDT-NPT \circ \circ - \circ \circ -ATH

NPTねじ用 for NPT threads	在庫 Stock	呼び径 Thread dia.		ピッチ Pitch	基準外径 Reference dia.	首下長 Under neck length	全長 Overall length	シャンク径 Shank dia.	オイルホール Oil Hole	呼び径補正量 Thread diameter compensation value	希望小売価格(円) Suggested retail price(¥)
		下穴不要 Pilot hole not required	下穴必要(下穴径) Pilot hole required (pilot hole diameter)								
		D_1	D_1								
商品コード Item code				TP	DC	LU	OAL	DCONMS		D_2	
EDT-NPT1/16-18-ATH	●	NPT $\frac{1}{16}$ -27 7.895	NPT $\frac{1}{8}$ -27 ($\phi 4$ 以上) 10.242	0.9407	4.8	18	70	6	-	0.03	24,250
EDT-NPT1/8-19-ATH	●	NPT $\frac{1}{8}$ -27 10.242	-	0.9407	5.7	19	70	6	-	0.03	24,250
EDT-NPT1/4-28-ATH	●	NPT $\frac{1}{4}$ -18 13.616	NPT $\frac{3}{8}$ -18 ($\phi 6$ 以上) 17.055	1.4111	7.9	28	80	10	-	0.045	35,470
EDT-NPT3/8-28-ATH	●	NPT $\frac{3}{8}$ -18 17.055	-	1.4111	9.6	28	80	10	-	0.045	35,470
EDT-NPT1/2-35-ATH	●	NPT $\frac{1}{2}$ -14 21.224	NPT $\frac{3}{4}$ -14 ($\phi 8$ 以上) 26.569	1.8143	11.5	35	110	12	-	0.058	51,060
EDT-NPT1-45-ATH	●	-	NPT1-11.5 ($\phi 10$ 以上) 33.228	2.2087	15.4	45	135	16	-	0.071	98,520

●印: 標準在庫品です。 ●: Stocked Items.

下穴必要の呼び径は、記載値以上の大きさの下穴がなければ加工できません。
Thread diameter which requires pilot hole can not be used without larger pilot hole than the values shown in the table.

PT・NPTねじ用: NCプログラムを作成される際の注意点 Cautions when creating NC program for PT, NPT threads



基準外径DCと先端外径が異なるため、呼び径 D_1 を補正してプログラミングする必要があります。呼び径 D_1 はめねじの谷の基準径(タップの基準径)に相当します。

補正例 EDT-PT1/4-28-ATHでPT $\frac{1}{4}$ ねじ切り加工

呼び径 D_1 + 呼び径補正量 D_2 = 設定呼び径
 $13.157 + 0.043 = 13.2$

※弊社提供のNCプログラムは呼び径補正量 D_2 をあらかじめ加味しております。

Since the reference diameter DC and the tool tip diameter are different, it is necessary to correct the thread diameter D_1 and program. The thread diameter D_1 corresponds to the reference diameter of the groove of the internal thread (reference diameter of the tap).

Example PT $\frac{1}{4}$ thread milling with EDT-PT1/4-28-ATH

Thread diameter D_1 + compensation value D_2 = setup thread diameter
 $13.157 + 0.043 = 13.2$

* The NC program provided by MOLDINO already incorporates the D_2 thread diameter compensation value.

基準外径DC: 1山目の仮想頂点位置における外径
 先端外径: 工具先端位置における外径
 Reference Dia. DC: diameter at the virtual crest position of the first thread
 Tip Dia.: diameter at the tool tip position

被削材 Work material		鋳鉄・炭素鋼 Cast irons, Carbon steels 150 ~ 200HB FC250,S50C			工具鋼 Tool steels 25 ~ 35HRC SCM440,HPM7			プリハードン鋼 Pre-hardened steels 35 ~ 45HRC HPM-MAGIC,NAK80		
切削速度 v_c (m/min)		80 ~ 85 ~ 90			70 ~ 75 ~ 80			60 ~ 65 ~ 70		
呼び径 D_1 Thread dia.	基準外径 DC (mm) Reference dia. (mm)	回転数 n (min^{-1})	送り速度 v_f (mm/min)	1刃送り量 f_z (mm/t)	回転数 n (min^{-1})	送り速度 v_f (mm/min)	1刃送り量 f_z (mm/t)	回転数 n (min^{-1})	送り速度 v_f (mm/min)	1刃送り量 f_z (mm/t)
PT $\frac{1}{16}$ -28	4.8	5,600	146	0.024	5,000	131	0.024	4,300	112	0.024
PT $\frac{1}{8}$ -28	5.7	4,700	181	0.029	4,200	162	0.029	3,600	139	0.029
PT $\frac{1}{4}$ -19	7.9	3,400	167	0.04	3,000	148	0.04	2,600	128	0.04
PT $\frac{3}{8}$ -19	9.6	2,800	192	0.048	2,500	171	0.048	2,200	150	0.048
PT $\frac{1}{2}$ -14	11.5	2,400	204	0.055	2,100	179	0.055	1,800	153	0.055
PT $\frac{3}{4}$ -14	11.5	2,400	278	0.055	2,100	243	0.055	1,800	208	0.055
PT1-11	15.4	1,800	231	0.065	1,600	206	0.065	1,300	167	0.065
NPT $\frac{1}{16}$ -27	4.8	5,600	156	0.024	5,000	140	0.024	4,300	120	0.024
NPT $\frac{1}{8}$ -27	5.7	4,700	202	0.029	4,200	180	0.029	3,600	155	0.029
NPT $\frac{1}{4}$ -18	7.9	3,400	182	0.04	3,000	160	0.04	2,600	139	0.04
NPT $\frac{3}{8}$ -18	9.6	2,800	200	0.048	2,500	179	0.048	2,200	157	0.048
NPT $\frac{1}{2}$ -14	11.5	2,400	209	0.055	2,100	183	0.055	1,800	157	0.055
NPT $\frac{3}{4}$ -14	11.5	2,400	279	0.055	2,100	244	0.055	1,800	209	0.055
NPT1-11.5	15.4	1,800	231	0.065	1,600	205	0.065	1,300	167	0.065

被削材 Work material		焼入れ鋼 Hardened steels 45 ~ 55HRC SKD61,HPM38,STAVAX			焼入れ鋼 Hardened steels 55 ~ 62HRC SKD11,YXR3			焼入れ鋼 Hardened steels 62 ~ 66HRC SKH51,HAP40		ステンレス鋼 Stainless steels SUS304
切削速度 v_c (m/min)		50 ~ 55 ~ 60			40 ~ 45 ~ 50			30 ~ 35 ~ 40		
呼び径 D_1 Thread dia.	基準外径 DC (mm) Reference dia. (mm)	回転数 n (min^{-1})	送り速度 v_f (mm/min)	1刃送り量 f_z (mm/t)	回転数 n (min^{-1})	送り速度 v_f (mm/min)	1刃送り量 f_z (mm/t)	回転数 n (min^{-1})	送り速度 v_f (mm/min)	1刃送り量 f_z (mm/t)
PT $\frac{1}{16}$ -28	4.8	3,600	94	0.024	3,000	78	0.024	2,300	60	0.024
PT $\frac{1}{8}$ -28	5.7	3,100	120	0.029	2,500	96	0.029	2,000	77	0.029
PT $\frac{1}{4}$ -19	7.9	2,200	108	0.04	1,800	89	0.04	1,400	69	0.04
PT $\frac{3}{8}$ -19	9.6	1,800	123	0.048	1,500	103	0.048	1,200	82	0.048
PT $\frac{1}{2}$ -14	11.5	1,500	128	0.055	1,200	102	0.055	1,000	85	0.055
PT $\frac{3}{4}$ -14	11.5	1,500	174	0.055	1,200	139	0.055	1,000	116	0.055
PT1-11	15.4	1,100	141	0.065	900	116	0.065	700	90	0.065
NPT $\frac{1}{16}$ -27	4.8	3,600	101	0.024	3,000	84	0.024	2,300	64	0.024
NPT $\frac{1}{8}$ -27	5.7	3,100	133	0.029	2,500	107	0.029	2,000	86	0.029
NPT $\frac{1}{4}$ -18	7.9	2,200	118	0.04	1,800	96	0.04	1,400	75	0.04
NPT $\frac{3}{8}$ -18	9.6	1,800	129	0.048	1,500	107	0.048	1,200	86	0.048
NPT $\frac{1}{2}$ -14	11.5	1,500	131	0.055	1,200	105	0.055	1,000	87	0.055
NPT $\frac{3}{4}$ -14	11.5	1,500	174	0.055	1,200	139	0.055	1,000	116	0.055
NPT1-11.5	15.4	1,100	141	0.065	900	116	0.065	700	90	0.065

- [注意]** ① エポックDスレッドミルはめねじ加工専用工具です。
 ② 上記切削条件表は、表中の呼び径でのものです。その他の呼び径の切削条件に関しては、使用上の注意点の項目(F14頁)を参照して算出してください。
 ③ 上記条件表において、送り速度は、めねじ加工時の工具中心の送り速度を表しています。また、1刃送り量は切削点での数値を表しています。
 ④ 機械内部に切りくずが入り込む危険性があるため、オイルホール付きの工具は必ずオイルホールを使用して加工を行ってください。
 ⑤ 被削材、加工形状に合わせて、適切なクーラントを使用してください。
 ⑥ この切削条件表は切削条件の目安を示すものです。実際の加工では使用機械等により条件を調整してください。

- [Note]** 1. Epoch D Thread Mill is capable of simultaneous boring and threading.
 2. The above cutting conditions are for the thread diameters stated in the table. Cutting conditions for other thread diameters should be calculated taking into consideration the Cautions on use (F14).
 3. The feed rate stated in the above conditions table is the feed rate at the tool center during threading. In addition, the per-tooth feed rate is the numerical value at the cutting point.
 4. Since there is a risk of cutting chips getting inside the machine, when using tools equipped with oil holes, be sure to use the oil holes.
 5. Use the appropriate coolant for the work material and machining shape.
 6. These conditions are for general guidance; in actual machining conditions adjust the parameters according to your actual machine conditions.

PT・NPTねじ用: 基準径位置の調整方法 Reference diameter position adjustment procedure for PT, NPT threads

スレッドミルでテーパめねじを加工する場合には、通常のタップと異なり、工具径補正によりめねじ径を調整することで、基準径位置を調整します。例えば下図のような場合、工具径補正值は下記の計算式により算出されます。

For the machining of tapered internal threads using a thread mill, in contrast to conventional taps, the reference diameter position is adjusted by adjusting the internal thread diameter with tool diameter correction. In the example shown in the following diagram, the tool diameter correction value is calculated as follows:

補正例 EDT-PT1/4-28-ATHでPT $\frac{1}{4}$ ねじ切り加工

Example PT1/4 thread milling with EDT-PT1/4-28-ATH

(工具の基準外径 DC ± 基準径位置調整量 × $\frac{1}{16}$) ÷ 2 (半径に換算) (Reference Dia. DC ± reference diameter position adjustment amount × $\frac{1}{16}$) ÷ 2 (conversion to radius)

(7.9 - 2 × $\frac{1}{16}$) ÷ 2 = 3.8875 (7.9 - 2 × $\frac{1}{16}$) ÷ 2 = 3.8875

浅くする場合はプラス、深くする場合はマイナスで計算するため、この場合は2mm深くなります。※PT・NPTねじのテーパはすべて $\frac{1}{16}$ テーパと規格で定められています。A positive value indicates shallower cuts; a negative value indicates deeper cuts. In this case, the value will be 2 mm deeper.

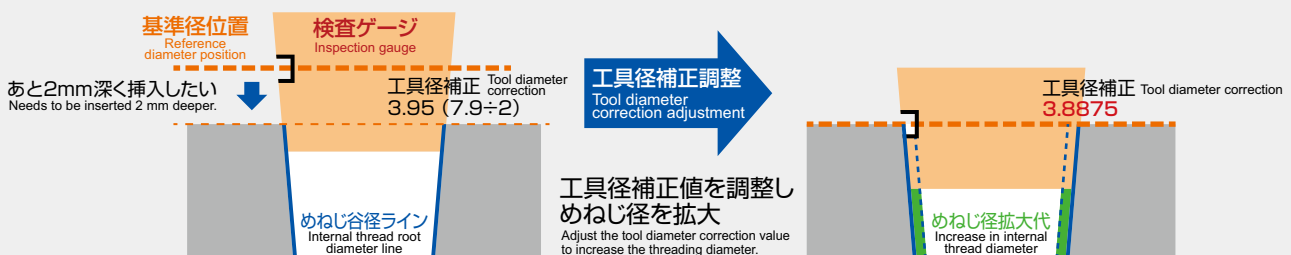

※以上の補正例は工具中心基準のNCプログラムの場合の補正例です。* The example above illustrates corrections made using an NC program with a tool center datum.

○ 下穴径について About pilot hole dia.

メートルねじ Metric threads

ねじの呼び Thread size	推奨下穴径 Recommended pilot hole dia. (mm)
M2×0.4	1.6
M2.2×0.45	1.75
M2.5×0.45	2.05
M3×0.5	2.5
M4×0.7	3.3
M5×0.8	4.2
M6×1	5
M8×1.25	6.75
M10×1.5	8.5
M12×1.75	10.25
M16×2	14
M18×2.5	15.5
M20×2.5	17.5

※推奨下穴径は旧JIS2級用、JIS2B級用です
* Recommended pilot hole diameters refer to former JIS Class 2 and JIS Class 2B.

ユニファイねじ Unified threads

ねじの呼び Thread size	推奨下穴径 Recommended pilot hole dia. (mm)
No.1-64UNC	1.51
No.2-56UNC	1.79
No.3-48UNC	2.05
No.4-40UNC	2.27
No.6-32UNC	2.77
No.8-36UNF	3.51
No.10-24UNC	3.83
1/4-20UNC	5.12
1/4-28UNF	5.47
5/16-18UNC	6.57
3/8-16UNC	7.98
7/16-14UNC	9.35
1/2-13UNC	10.81
9/16-12UNC	12.2
5/8-11UNC	13.6

下穴加工用ドリルは、下記の工具をご使用ください。
Please use these tools for pilot hole machining.

商品名 Product Name	商品コード Item code	掲載頁 Page
●超硬ノンステップボーラーシリーズ Carbide Non Step Borer series	WHNSB-TH WNSB-TH	E20ページ〜
●高硬度用超硬OHノンステップボーラーH Carbide Oil Hole Non Step Borer H for High Hardness Material	NSBH-ATH	E49ページ〜
●超硬OHミニステップボーラー Miniature Drill WHMB	WHMB-TH	E63ページ〜

エポックDスレッドミル

○ 工具径補正について About tool diameter correction

スレッドミルによるねじ切り加工では、切削抵抗により工具がたわみ、めねじ径が縮小するため補正が必要な場合があります。下記表はあくまで参考値となりますが工具径補正値を調整する際の目安としてご利用ください。
Corrections may be needed when threading with thread mill. The internal thread diameter is reduced due to the tool deflection induced by cutting resistance. The figures in the following tables are provided for reference purposes. Use them as a guide when adjusting tool diameter correction values.

メートルねじ Metric threads

ねじの呼び Thread size	調整量 Adjustment amounts (mm)
M2×0.4	0.026
M2.2×0.45	0.036
M2.5×0.45	0.036
M3×0.5	0.038
M4×0.7	0.044
M5×0.8	0.047
M6×1	0.045
M8×1.25	0.049
M10×1.5	0.053
M12×1.75	0.060
M16×2	0.064
M18×2.5	0.071
M20×2.5	0.071
M24×3.0	0.075

ユニファイねじ Unified threads

ねじの呼び Thread size	調整量 Adjustment amounts (mm)
No.1-64UNC	0.024
No.2-56UNC	0.026
No.3-48UNC	0.028
No.4-40UNC	0.031
No.6-32UNC	0.035
No.8-36UNF	0.034
No.10-24UNC	0.041
1/4-20UNC	0.046
1/4-28UNF	0.040
5/16-18UNC	0.050
3/8-16UNC	0.054
7/16-14UNC	0.058
1/2-13UNC	0.062
9/16-12UNC	0.065
5/8-11UNC	0.068

調整量は旧JIS2級めねじおよびJIS2B級めねじにおける、有効径許容差の75%を目安に設定しております。

例：M3×0.5 旧JIS2級有効径寸法許容差 0 ~ +0.100
0.100×75%÷2 (半径に換算) = 0.038

具体的な補正方法はF14ページをご参照ください

The adjustment amounts are set for an effective diameter tolerance of 75% with former JIS Class 2 and JIS Class 2B internal threads.

Example : M3×0.5 former JIS Class 2 effective diameter tolerance 0 ~ +0.100
0.100×75%÷2 (conversion to radius) = 0.038

Refer to F14 for the specific correction procedure.

トラブルシューティング Troubleshooting

ねじ径の拡大・収縮について

Regarding thread diameter expansion/contraction

被削材や工具摩耗状態に応じて、適切な工具径補正を行ってください。また機械への工具径補正値の入力忘れにご注意ください。

Suitable tool diameter correction should be performed according to the work material and tool wear condition. Also, please be careful not to forget to input the tool diameter correction value into the machine.

穴の底に進むにつれて寸法精度が悪い(倒れている)

Dimensional accuracy worsens when moving toward the bottom of the hole (deflection)

スレッドミルは加工方法の特質上、穴の底に進むにつれ工具の倒れが大きくなります。倒れの少ない高精度なねじを加工するには、ゼロカットが必要な場合があります。

A characteristic of the thread milling method is that tool deflection increases as the tool progresses toward the bottom of the hole. It may be necessary to perform zero cutting in order to perform high-accuracy thread milling with low deflection.

工具折損について

Regarding tool breakage

折損対策としては送り速度を下げ加工すると効果的です。また、伸びた状態や粗大な切りくずが発生する場合は、切りくず詰まりによる折損が考えられます。その場合は切削速度を上げて加工すると、切りくずが細かく分断され改善されることがあります。

As a countermeasure against tool breakage, performing processing with a reduced feed rate is effective. In addition, when processing with tool extended or when large rough cutting chips are produced, breakage due to chip clogging should be considered. In such cases, if processing is performed with a higher cutting speed, the cutting chips will be broken into smaller bits which may improve conditions.

切削速度の違いによる切りくず状態の変化 炭素鋼の穴あけ + ねじ切り同時加工 (M8×P1.25)

Changes in cutting chip conditions due to different cutting speeds; Simultaneous boring and thread milling (M8 × P 1.25) of carbon steel



Low **低**

切削速度
Cutting Speed

高 High

弊社NCプログラム作成ソフトより作成されるNCプログラムが正常に動作しない

The NC program created using MOLDINO's NC program creation software doesn't work properly.

ご使用される機械によってはプログラミングコードが異なる場合があります。お手数ですが機械メーカーに詳細をお問い合わせください。

There are differences in the programming code for the machine being used. Please contact the machine manufacturer for details.

加工可能な呼び径について

Regarding upper limit on machinable thread diameters

エポックDスレッドミルは穴あけ加工を同時に行うため、外径DCの1.68倍を超える径のねじ切り加工はできませんのでご注意ください。エポックスレッドミルは特に上限はありません。また、ラインナップ表に記載している呼び径よりも小さなサイズのねじを加工した場合、ねじ形状に不具合が発生する可能性があるためご注意ください。

例：ET-2-40-PN (M16×P2 用) で M14×P2 を加工

Please note that since the Epoch D Thread Mill performs boring simultaneously, it cannot perform thread milling for diameters of more than 1.68 times the tool diameter DC. There are no particular similar limitations on using the Epoch Thread Mill. Also, please be aware that if screws of a size smaller than the thread diameter described in the line-up table are processed, there is a possibility of malfunctioning the screw shape.
Example) Threading M14×P2 with ET-2-40-PN (designed for M16×P2)

エポックスレッドミル / エポックDスレッドミル 使用上の注意点 Cautions regarding use for Epoch Thread Mill/Epoch D Thread Mill

○ 工具の送り速度について About tool feed rate

ヘリカル補間によるねじ切り加工では、切削ポイントでの送り速度に係数をかけて工具中心の送り速度を求めます。右に、工具中心の送り速度の計算式を示します。

PT・NPT ねじ用の標準切削条件は、加工可能な最大深さ（首下長）における呼び径 D_1 を基準に算出しています。

例) EDT-PT1/8-19-ATH による PT $\frac{1}{8}$ ねじ切り加工
 $D_1 = 9.728(D_1) - 19$ (首下長) $\times \frac{1}{6}$ (ねじテーパ角) = 8.5405

When performing thread milling by helical interpolation, the cutting point feed rate should be multiplied by a coefficient to determine the tool center feed rate. The equation for calculating the tool center feed rate is shown at right.

The standard cutting conditions for PT and NPT threads are calculated based on the thread diameter D_1 at the machinable maximum depth (neck length).

Example) Thread milling PT $\frac{1}{8}$ with EDT-PT1/8-19-ATH
 $D_1 = 9.728(D_1) - 19$ (under neck length) $\times \frac{1}{6}$ (thread taper angle) = 8.5405

$$v_f = f_z \times z \times n \times \frac{D_1 - DC}{D_1}$$

v_f	: テーブル送り速度 Feed rate	(mm/min)
f_z	: 1 刃送り量 Feed per tooth	(mm/t)
z	: 刃数 No. of flutes	
n	: 回転数 Rotation	(min ⁻¹)
D_1	: 呼び径 Thread diameter	(mm)
DC	: 外径 Tool diameter	(mm)

○ 工具径補正について About tool diameter correction

スレッドミルで加工しためねじの加工径は、工具のたわみや工具摩耗により、縮小するため補正が必要な場合があります。その場合は、F12 頁に記載の調整量^{*1}を工具径補正值に加味し加工を行うことで、加工径を調整することが可能です。

The internal thread machining diameter with thread mill may need to be adjusted if reduced by wear and tool deflection. In such cases, the machining diameter can be adjusted by considering the adjustment amounts^{*1} described on Page F12 to the tool diameter correction value.

例 EDT-1.75-30-TH で M12×1.75の加工 工具中心基準のNCプログラムで半径指示の場合
 Example: Machining an M12 × 1.75 thread with EDT-1.75-30-TH when tool centerline datum NC program prompts a radius

外径 Tool Dia.: DC=9.0、工具径補正值 Tool diameter correction value: 4.5、工具径補正值の調整量 Adjustment amount of tool diameter correction value: 0.060

加工径縮小 ボルト、通りゲージ等通過不可
 Machined diameter contraction, Bolt or go gauge doesn't pass through

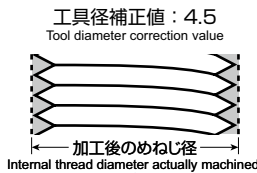

工具径補正值を調整^{*2}
 Adjust tool diameter correction value^{*2}



加工径拡大 ボルト、通りゲージ通過可能
 Increased machining diameter, Enables bolt and go gauge to pass through

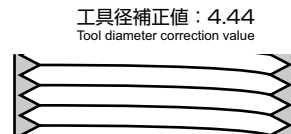

工具摩耗の進行・切削抵抗の増大
 Progress of tool wear and increase in cutting resistance

*1 調整量はあくまで参考値としてご利用ください。調整量は旧JIS2級めねじおよびJIS2B級めねじにおける、有効径許容差の75%を目安に設定しております。
 *2 工具径補正值を調整後、再びボルト、通りゲージ等が通過不可となった場合は、再度調整量を加味してください。
 *1: Use these adjustment amounts only as guidelines. The adjustment amounts are set for an effective diameter tolerance of 75% with former JIS Class 2 and JIS Class 2B internal threads.
 *2: Make further adjustments if the bolt or go gauge still doesn't pass through after adjusting the tool diameter correction value.

○ クーラントについて About coolant

- 表に示す第一推奨のクーラントが最も工具寿命が優れる傾向です。加工面品位を優先する場合は水溶性切削液が有効です。油性切削液は切りくず排出性が悪く適していません。
- ホルダーが穴を塞がないようにシャンク部分の突き出し量をシャンク径の1~2倍で把持し、クーラントが穴の底まで当たる位置にクーラントノズルを設定してください。またクーラント圧は切りくずが排出されるように調整してください。設定が悪い場合は切りくず詰りによる刃先損傷や工具折損を引き起こす可能性があります。
- 機械内部に切りくずが入り込む危険性があるため、オイルホール付きの工具は必ずオイルホールを使用して加工を行ってください。

- The first recommended coolant shown in the table tends to have the superior tool life. When priority is given to finished surface quality, water-soluble cutting fluids are effective. Oil-based cutting fluids are not suitable because they degrade chip removal characteristics.
- The holder should grip the tool shank so that the holder does not block the hole and the shank projection amount is 1 to 2 times the shank diameter. The coolant nozzle should then be positioned so that the coolant will reach the bottom of the hole. In addition, coolant pressure should be adjusted so that it removes cutting chips. If the setting is bad, cutting chip clogging may lead to flute tip damage or tool breakage.
- Since there is a risk of cutting chips getting inside the machine, when using tools equipped with oil holes, be sure to perform processing using the oil holes.

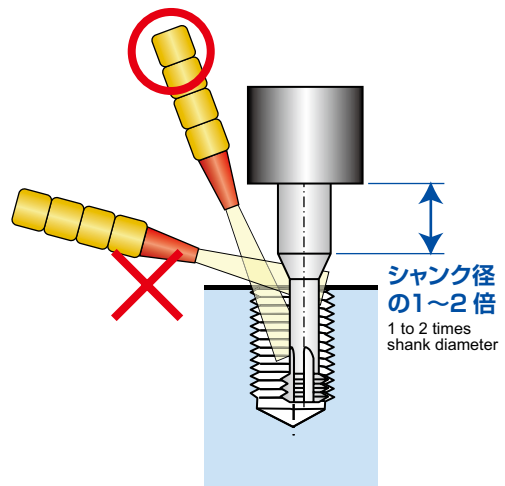

被削材 Work material	ET		EDT	
	エアブロー Air-blow	水溶性 Water-base	エアブロー Air-blow	水溶性 Water-base
焼入れ鋼・プリハードン鋼 工具鋼・铸铁・炭素鋼 Hardened steel, Pre-hardened steel Tool steel, Cast iron, Carbon steel	◎	○	◎	△
ステンレス鋼 Stainless steel	×	◎	×	◎
超耐熱合金・チタン合金 Super heat resistant alloy, Titanium alloy	×	◎	×	◎
アルミ合金・銅合金・樹脂 Aluminium alloy, Copper alloy, Resin	○	◎	×	◎

- ◎: 第一推奨 First recommended
- : 第二推奨 Second recommended
- △: 寿命低下傾向 Tendency to decrease tool life
- ×: 非推奨 Not recommended

Chamfering Tool for Hardened Steels 高硬度鋼加工用面取り工具

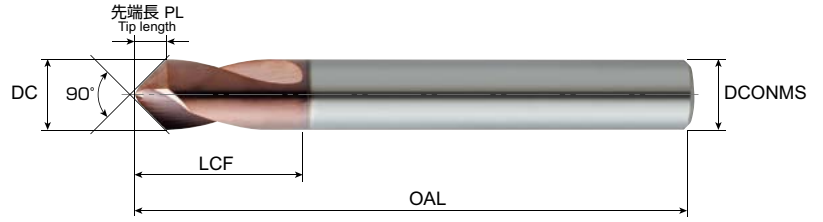
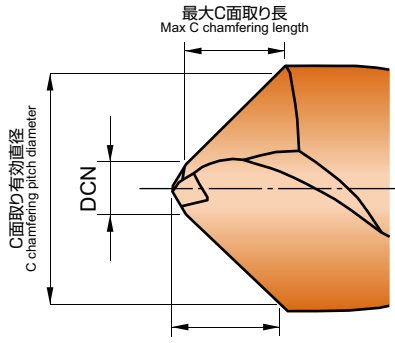

DCN=DC/4(先端角≠90°) 最大使用可能深さ LU
Tip angle Max available depth

DN2HC-ATH



商品コード Item code	在庫 Stock	寸法 Size (mm)						使用可能長さ Usable length (mm)			希望小売 価格(円) Suggested retail price (¥)
		直径 Tool dia. DC	先端径 Tip dia. DCN	先端長 Tip length PL	溝長 Flute length LCF	全長 Overall length OAL	シャンク径 Shank dia. DCONMS	最大使用 可能深さ Max available depth LU	最大C 面取り長 Max C chamfering length	C面取り 有効直径 C chamfering pitch diameter	
DN2HC0300-ATH	●	3	0.7	1.3	9	45	3	1.2	1.1	0.75 超え 3未満 More than 0.75 but less than 3	8,800
DN2HC0400-ATH	●	4	0.95	1.7	12	50	4	1.6	1.5	1 超え 4未満 More than 1 but less than 4	10,010
DN2HC0600-ATH	●	6	1.4	2.6	15	66	6	2.4	2.2	1.5 超え 6未満 More than 1.5 but less than 6	12,650
DN2HC0800-ATH	●	8	1.9	3.4	20	74	8	3.2	3.0	2 超え 8未満 More than 2 but less than 8	15,180
DN2HC1000-ATH	●	10	2.4	4.3	24	84	10	4.1	3.7	2.5 超え 10未満 More than 2.5 but less than 10	18,370
DN2HC1200-ATH	●	12	2.9	5.1	28	95	12	4.9	4.5	3 超え 12未満 More than 3 but less than 12	21,120
DN2HC1600-ATH	●	16	3.9	6.8	35	113	16	6.6	6.0	4 超え 16未満 More than 4 but less than 16	38,170

○ 工具先端部の参考寸法 Reference sizes of tool tip

必要に応じて加工プログラムの作成やCAMでの工具形状定義にご使用ください。
Use it for creating machining programs and defining tool shapes in CAM as needed.

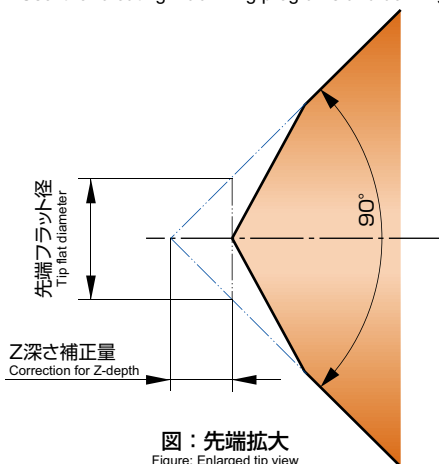

図：先端拡大
Figure: Enlarged tip view

商品コード Item code	直径DC Tool dia.	参考寸法 Reference size (mm)	
		先端フラット径 Tip flat diameter	Z深さ補正量 Correction for Z-depth
DN2HC0300-ATH	3	0.4	0.2
DN2HC0400-ATH	4	0.6	0.3
DN2HC0600-ATH	6	0.8	0.4
DN2HC0800-ATH	8	1.2	0.6
DN2HC1000-ATH	10	1.4	0.7
DN2HC1200-ATH	12	1.8	0.9
DN2HC1600-ATH	16	2.4	1.2

○ 再研磨対応外径範囲 Re-grinding compatibility range

商品コード Item code	直径 Tool dia. (mm)	エンド End (mm)
DN2HC-ATH	3 ~ 16	3 ~ 16

- : 標準在庫品です。
● : Stocked items.

Chamfering Tool for Hardened Steels

高硬度鋼加工用面取り工具

標準切削条件表 Recommended cutting conditions **DN2HC-ATH**

セナリング Centering		被削材 (硬さ) Work material (Hardness)	構造用鋼・炭素鋼・合金鋼 Structural steels, Carbon steels, Alloy steels (~30HRC) SS S○OC SCM			プリハードン鋼 Pre-hardened steel (30~40HRC) SKD61		
C面取り(穴) C Chamfering (Bore)			切削速度 v_c (m/min)			切削速度 v_c (m/min)		
直径 Tool dia. (mm)	回転数 n (min^{-1})	送り速度 v_f (mm/min)	送り量 f (mm/rev)	回転数 n (min^{-1})	送り速度 v_f (mm/min)	送り量 f (mm/rev)		
$\phi 3$	8500	510	0.06 0.04~0.08	6400	320	0.05 0.03~0.07		
$\phi 4$	6400	384	0.06 0.04~0.08	4800	240	0.05 0.03~0.07		
$\phi 6$	4200	294	0.07 0.05~0.09	3200	192	0.06 0.04~0.08		
$\phi 8$	3200	240	0.075 0.05~0.10	2400	144	0.06 0.04~0.08		
$\phi 10$	2500	200	0.08 0.05~0.11	1900	124	0.065 0.04~0.09		
$\phi 12$	2100	168	0.08 0.05~0.11	1600	104	0.065 0.04~0.09		
$\phi 16$	1600	192	0.12 0.10~0.14	1200	96	0.08 0.06~0.10		

C面取り(コーナ) C Chamfering (Corner)		被削材 (硬さ) Work material (Hardness)	構造用鋼・炭素鋼・合金鋼 Structural steels, Carbon steels, Alloy steels (~30HRC) SS S○OC SCM			プリハードン鋼 Pre-hardened steels (30~50HRC) SKD61		
C面取り(穴) C Chamfering (Bore)			切削速度 v_c (m/min)			切削速度 v_c (m/min)		
直径 Tool dia. (mm)	回転数 n (min^{-1})	送り速度 v_f (mm/min)	1刃当りの送り f_z (mm/t)	回転数 n (min^{-1})	送り速度 v_f (mm/min)	1刃当りの送り f_z (mm/t)		
$\phi 3$	24,000	1,440	0.03 0.020~0.040	17,500	875	0.025 0.015~0.035		
$\phi 4$	18,000	1,080	0.03 0.020~0.040	13,100	655	0.025 0.015~0.035		
$\phi 6$	12,000	840	0.035 0.025~0.045	8,800	528	0.03 0.020~0.040		
$\phi 8$	9,000	675	0.0375 0.025~0.050	6,600	396	0.03 0.020~0.040		
$\phi 10$	7,200	576	0.04 0.025~0.055	5,300	345	0.0325 0.020~0.045		
$\phi 12$	6,000	480	0.04 0.025~0.055	4,400	286	0.0325 0.020~0.045		
$\phi 16$	4,500	540	0.06 0.050~0.070	3,300	264	0.04 0.030~0.050		

●C=DC×20%の時が目安の切削条件です。
これを超える場合は回転数と送り速度を下げて調整ください。
・C = DC x 20% is used as a general guideline for cutting conditions.
Adjust by decreasing the rotation speed and feed rate if C > DC x 20%.

溝加工 Slotting		被削材 (硬さ) Work material (Hardness)	構造用鋼・炭素鋼・合金鋼 Structural steels, Carbon steels, Alloy steels (~30HRC) SS S○OC SCM			プリハードン鋼 Pre-hardened steels (30~40HRC) SKD61		
溝加工 Slotting			最大使用可能深さ比率 Max available depth ratio			最大使用可能深さ比率 Max available depth ratio		
直径 Tool dia. (mm)	回転数 n (min^{-1})	送り速度 v_f (mm/min)	1刃当りの送り f_z (mm/t)	回転数 n (min^{-1})	送り速度 v_f (mm/min)	1刃当りの送り f_z (mm/t)		
$\phi 3$	19100	1146	0.03 0.020~0.040	17500	875	0.025 0.015~0.035		
$\phi 4$	14300	858	0.03 0.020~0.040	13100	655	0.025 0.015~0.035		
$\phi 6$	9600	672	0.035 0.025~0.045	8800	528	0.03 0.020~0.040		
$\phi 8$	7200	540	0.0375 0.025~0.050	6600	396	0.03 0.020~0.040		
$\phi 10$	5700	456	0.04 0.025~0.055	5300	345	0.0325 0.020~0.045		
$\phi 12$	4800	384	0.04 0.025~0.055	4400	286	0.0325 0.020~0.045		
$\phi 16$	3600	432	0.06 0.050~0.070	3300	264	0.04 0.030~0.050		

●高硬度鋼においては、切削負荷が大きいため最大使用可能深さを1回で加工できないことがあります。最大使用可能深さ比率を参考に溝深さを2回に分けて加工するなど調整ください。
・For hardened steel, large cutting loads may prevent machining of max available depths in a single operation. Make adjustments: for example, machining the groove depth in two operations, referring to max available depth ratios.

【切削条件の選定について】

- 40HRC以上の焼入鋼、ステンレス鋼、アルミ合金の加工では、クーラントの使用を推奨します。
- この標準切削条件は目安を表すものです。実際の加工では、加工形状、目的、使用機械などにより切削条件を調整ください。
- 工具装着の際は傷や汚れの無いコレットを用い、工具の振れは0.02 mm以下に抑えてください。
- 被削材は変形、たわみ、振動が起こらないようにしっかりと保持してください。
- 切りくずおよび工具の発熱による発煙・引火にご注意ください。

	プリハードン鋼 Pre-hardened steels (40~50HRC) SKD61			冷間工具鋼 Cold working tool steels (50~60HRC) SKD11			高速度工具鋼 High-speed tool steels (60~65HRC) SKH			ステンレス鋼 Stainless steels SUS	鋳鉄・ダクタイル鋳鉄 Cast irons, Ductile cast irons FC FCD			アルミニウム・銅 Aluminium, Copper Al, Cu		
	30~40~50			20~30~40			10~20~30			40~60~100			50~100~150			
	回転数 <i>n</i> (min ⁻¹)	送り速度 <i>v_f</i> (mm/min)	送り量 <i>f</i> (mm/rev)	回転数 <i>n</i> (min ⁻¹)	送り速度 <i>v_f</i> (mm/min)	送り量 <i>f</i> (mm/rev)	回転数 <i>n</i> (min ⁻¹)	送り速度 <i>v_f</i> (mm/min)	送り量 <i>f</i> (mm/rev)	回転数 <i>n</i> (min ⁻¹)	送り速度 <i>v_f</i> (mm/min)	送り量 <i>f</i> (mm/rev)	回転数 <i>n</i> (min ⁻¹)	送り速度 <i>v_f</i> (mm/min)	送り量 <i>f</i> (mm/rev)	
	4200	168	0.04 0.02~0.06	3200	128	0.04 0.02~0.06	2100	84	0.04 0.02~0.06	6400	384	0.06 0.04~0.08	11000	660	0.06 0.04~0.08	
	3200	128	0.04 0.02~0.06	2400	96	0.04 0.02~0.06	1600	64	0.04 0.02~0.06	4800	288	0.06 0.04~0.08	8000	480	0.06 0.04~0.08	
	2100	126	0.06 0.04~0.08	1600	96	0.06 0.04~0.08	1100	66	0.06 0.04~0.08	3200	224	0.07 0.05~0.09	5300	371	0.07 0.05~0.09	
	1600	96	0.06 0.04~0.08	1200	72	0.06 0.04~0.08	800	48	0.06 0.04~0.08	2400	180	0.075 0.05~0.10	4000	300	0.075 0.05~0.10	
	1300	78	0.06 0.04~0.08	960	58	0.06 0.04~0.08	640	38	0.06 0.04~0.08	1900	152	0.08 0.05~0.11	3200	256	0.08 0.05~0.11	
	1100	66	0.06 0.04~0.08	800	48	0.06 0.04~0.08	530	32	0.06 0.04~0.08	1600	128	0.08 0.05~0.11	2700	216	0.08 0.05~0.11	
	800	64	0.08 0.06~0.10	600	48	0.08 0.06~0.10	400	32	0.08 0.06~0.10	1200	144	0.12 0.10~0.14	2000	240	0.12 0.10~0.14	

	冷間工具鋼 Cold working tool steels (50~60HRC) SKD11			高速度工具鋼 High-speed tool steels (60~65HRC) SKH			ステンレス鋼 Stainless steels SUS			鋳鉄・ダクタイル鋳鉄 Cast irons, Ductile cast irons FC FCD			アルミニウム・銅 Aluminium, Copper Al, Cu		
	50~110~180			40~75~120			50~90~160			100~180~260			200~300~400		
	回転数 <i>n</i> (min ⁻¹)	送り速度 <i>v_f</i> (mm/min)	1刃当りの送り量 <i>f_t</i> (mm/t)	回転数 <i>n</i> (min ⁻¹)	送り速度 <i>v_f</i> (mm/min)	1刃当りの送り量 <i>f_t</i> (mm/t)	回転数 <i>n</i> (min ⁻¹)	送り速度 <i>v_f</i> (mm/min)	1刃当りの送り量 <i>f_t</i> (mm/t)	回転数 <i>n</i> (min ⁻¹)	送り速度 <i>v_f</i> (mm/min)	1刃当りの送り量 <i>f_t</i> (mm/t)	回転数 <i>n</i> (min ⁻¹)	送り速度 <i>v_f</i> (mm/min)	1刃当りの送り量 <i>f_t</i> (mm/t)
	12,000	480	0.02 0.010~0.030	8,000	320	0.02 0.010~0.030	9,600	384	0.02 0.010~0.030	19,100	1,146	0.03 0.020~0.040	32,000	1,920	0.03 0.020~0.040
	8,800	352	0.02 0.010~0.030	6,000	240	0.02 0.010~0.030	7,200	288	0.02 0.010~0.030	14,300	858	0.03 0.020~0.040	24,000	1,440	0.03 0.020~0.040
	5,800	348	0.03 0.020~0.040	4,000	240	0.03 0.020~0.040	4,800	288	0.03 0.020~0.040	9,600	672	0.035 0.025~0.045	16,000	1,120	0.035 0.025~0.045
	4,400	264	0.03 0.020~0.040	3,000	180	0.03 0.020~0.040	3,600	216	0.03 0.020~0.040	7,200	540	0.0375 0.025~0.050	12,000	900	0.0375 0.025~0.050
	3,500	210	0.03 0.020~0.040	2,400	144	0.03 0.020~0.040	2,900	174	0.03 0.020~0.040	5,700	456	0.04 0.025~0.055	9,600	768	0.04 0.025~0.055
	2,900	174	0.03 0.020~0.040	2,000	120	0.03 0.020~0.040	2,400	144	0.03 0.020~0.040	4,800	384	0.04 0.025~0.055	8,000	640	0.04 0.025~0.055
	2,200	176	0.04 0.030~0.050	1,500	120	0.04 0.030~0.050	1,800	144	0.04 0.030~0.050	3,600	432	0.06 0.050~0.070	6,000	720	0.06 0.050~0.070

	プリハードン鋼 Pre-hardened steels (40~50HRC) SKD61			冷間工具鋼 Cold working tool steels (50~60HRC) SKD11			高速度工具鋼 High-speed tool steels (60~65HRC) SKH			ステンレス鋼 Stainless steels SUS	鋳鉄・ダクタイル鋳鉄 Cast irons Ductile cast irons FC FCD		アルミニウム Aluminium, Copper Al, Cu		
	90%			70%			50%			100%					
	回転数 <i>n</i> (min ⁻¹)	送り速度 <i>v_f</i> (mm/min)	1刃当りの送り量 <i>f_t</i> (mm/t)	回転数 <i>n</i> (min ⁻¹)	送り速度 <i>v_f</i> (mm/min)	1刃当りの送り量 <i>f_t</i> (mm/t)	回転数 <i>n</i> (min ⁻¹)	送り速度 <i>v_f</i> (mm/min)	1刃当りの送り量 <i>f_t</i> (mm/t)	回転数 <i>n</i> (min ⁻¹)	送り速度 <i>v_f</i> (mm/min)	1刃当りの送り量 <i>f_t</i> (mm/t)	回転数 <i>n</i> (min ⁻¹)	送り速度 <i>v_f</i> (mm/min)	1刃当りの送り量 <i>f_t</i> (mm/t)
	100~150~200			50~115~150			30~75~120			100~180~260					
	16000	640	0.02 0.010~0.030	12000	480	0.02 0.010~0.030	8000	320	0.02 0.010~0.030	19100	1146	0.03 0.020~0.040			
	12000	480	0.02 0.010~0.030	9200	368	0.02 0.010~0.030	6000	240	0.02 0.010~0.030	14300	858	0.03 0.020~0.040			
	8000	480	0.03 0.020~0.040	6100	366	0.03 0.020~0.040	4000	240	0.03 0.020~0.040	9600	672	0.035 0.025~0.045			
	6000	360	0.03 0.020~0.040	4600	276	0.03 0.020~0.040	3000	180	0.03 0.020~0.040	7200	540	0.0375 0.025~0.050			
	4800	288	0.03 0.020~0.040	3700	222	0.03 0.020~0.040	2400	144	0.03 0.020~0.040	5700	456	0.04 0.025~0.055			
	4000	240	0.03 0.020~0.040	3100	186	0.03 0.020~0.040	2000	120	0.03 0.020~0.040	4800	384	0.04 0.025~0.055			
	3000	240	0.04 0.030~0.050	2300	184	0.04 0.030~0.050	1500	120	0.04 0.030~0.050	3600	432	0.06 0.050~0.070			

[Setting of cutting conditions]

- Coolant is recommended for work materials of 40HRC or harder, stainless steel, and aluminium.
- These recommended cutting conditions are for general guidelines. Adjust cutting parameters for actual machining based on machining shape, purpose, machine used, and other factors.
- When attaching the tool, use a collet free of scratches or dirt. Keep tool runout to 0.02 mm or less.
- Secure the work material firmly to prevent deformation, deflection, and vibration.
- Watch for smoke and fire hazards posed by heated chips or tools.

旋削用インサート

Turning Inserts



インサートブレイカの紹介	G2
Introduction to insert chip-breakers	
インサートブレイカの選定方法	G3
How to select insert breakers	
旋削用コーティング材種	G4
Coating materials for turning inserts	
旋削用インサート材種選択基準	G4
Guide to grades for turning inserts	
旋削用インサート標準切削条件表	G5
Recommended cutting conditions of turning inserts	
各社旋削用コーティング材種	G7
Various types of coating materials for turning	
旋削用インサートの呼び方	G8
Designation of turning inserts	

 80°(C□□□)ひし形インサート	G10
80° Diamond Inserts	
 55°(D□□□)ひし形インサート	G12
55° Diamond Inserts	
 90°正方形(S□□□)インサート	G15
90° Square Inserts	
 60°三角形(T□□□)インサート	G17
60° Triangle Inserts	
 35°ひし形(V□□□)インサート	G21
35° Diamond Inserts	
 80°(W□□□)六角形インサート	G22
80° Hexagonal Inserts	
 円形(R□□□)インサート	G24
Round Inserts	

インサートブレーカの紹介

メインブレーカ Main Breaker

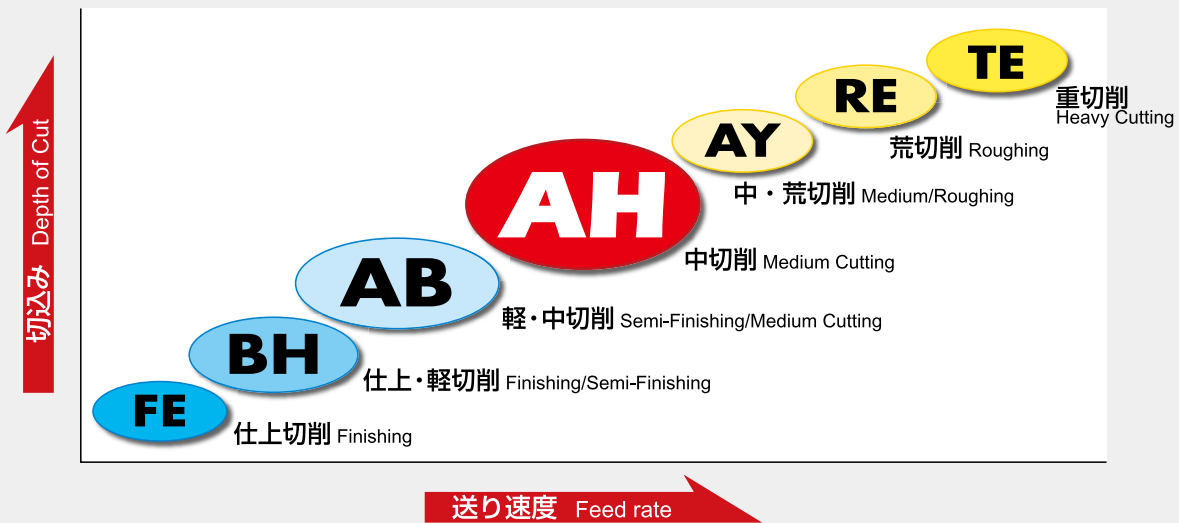

内径加工用ポジティブブレーカ

Positive-rake Insert for Internal Turning



重切削用ブレーカ(大型インサート)

Heavy Cutting Breaker (Large insert)

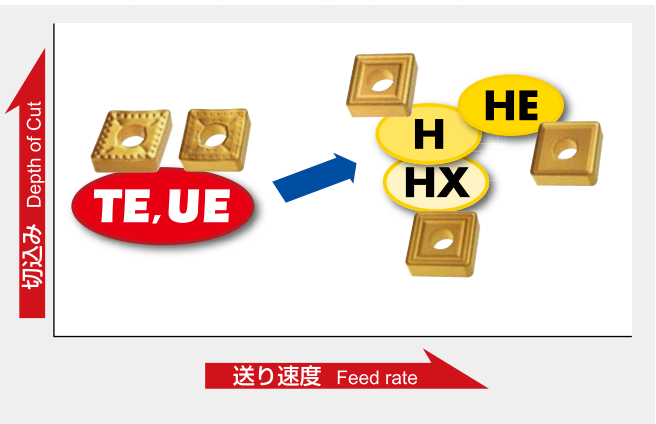

サブブレーカ Sub Breaker



旋削用インサート

インサートブレーカの紹介

インサートブレーカの選定方法

○ 切削条件からのブレーカ選定 Breaker selection by cutting conditions

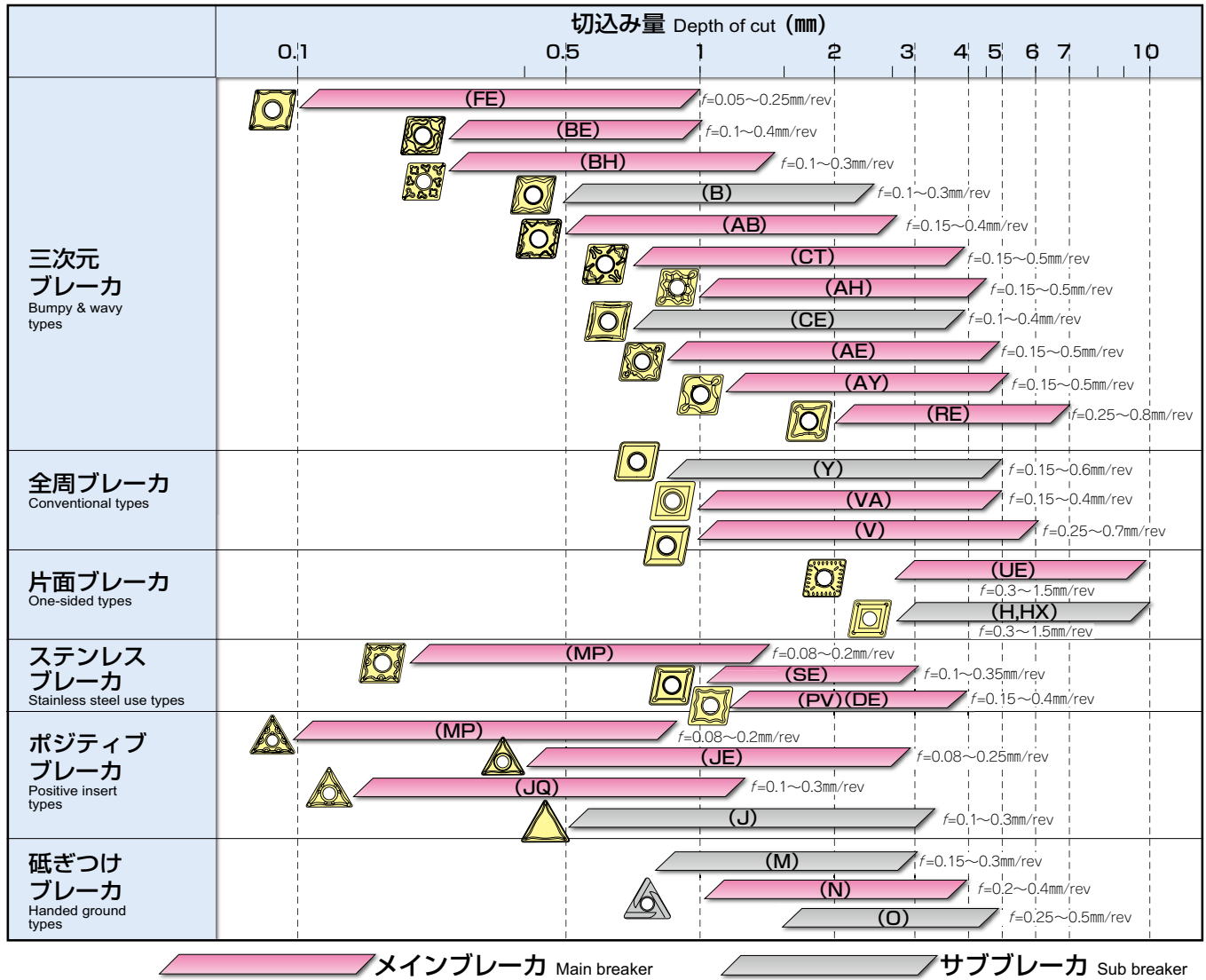

○ 用途からのブレーカ選定 Breaker selection by applications

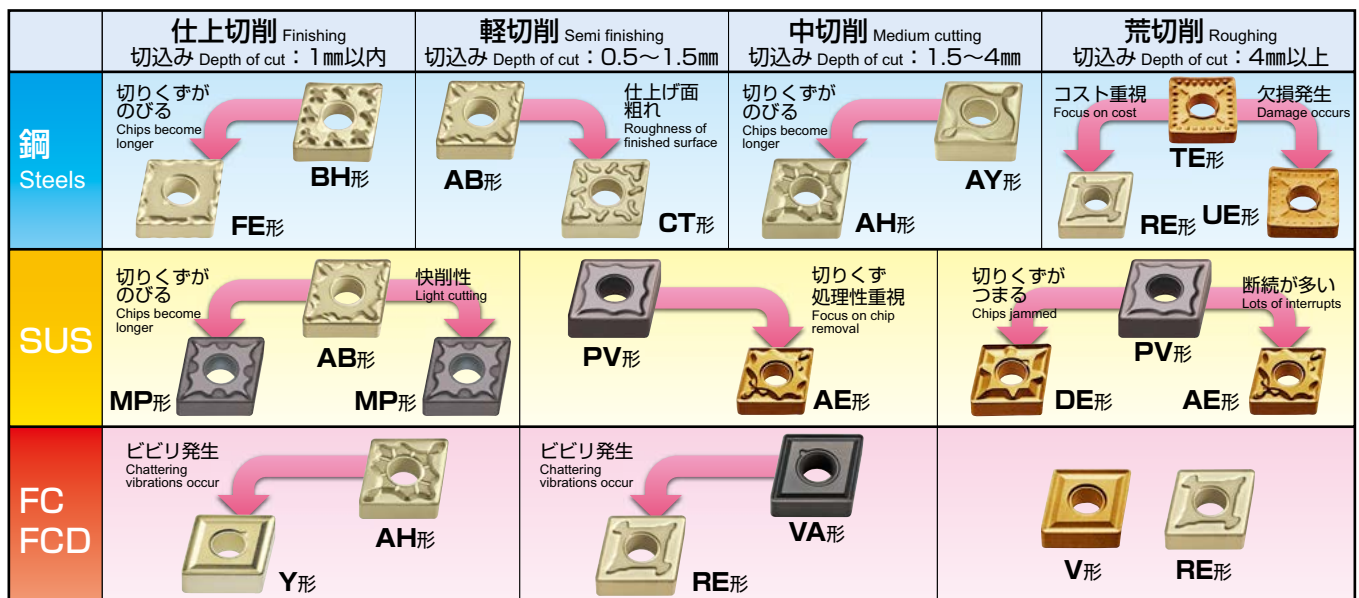

Coating materials for turning inserts 旋削用コーティング材種

材種名 Insert material name ISO分類 ISO classification	コーティング名 Coating name 皮膜の種類 Coating type	母材硬度 (HRA) [*] Base material hardness 母材抗折力 (GPa) Base material bending strength	用途 Application	特長 Features
HS9105	HSコーティング CVD	92.5 1.8	Ni基超耐熱合金の 仕上げ加工用 For finishing of Ni based alloy	耐摩耗性に優れた超硬合金と耐塑性変形性に優れたHSコーティングを採用。 Ni基超耐熱合金の加工に優れる。 Uses carbide alloy with excellent wear resistance and HS coating with excellent plastic deformation resistance. Excellent machining of Ni-based alloys.
JP9105	AJコーティング PVD	92.5 1.82	Ni基超耐熱合金の 仕上げ加工用 For finishing of Ni based alloy	耐摩耗性に優れた超硬合金と耐熱性に優れたAJコーティングを採用。 Ni基超耐熱合金の加工に優れる。 Uses cemented carbide with excellent wear resistance and AJ coating with excellent heat resistance. Excellent machining of Ni-based alloys.
HS9115	HSコーティング CVD	91.5 2.0	Ni基超耐熱合金加工用 For cutting of Ni based alloy	汎用性に優れた超硬合金と耐塑性変形性に優れたHSコーティングを採用。 Ni基超耐熱合金の加工に優れる。 Uses highly versatile cemented carbide and HS coating with excellent plastic deformation resistance. Excellent machining of Ni-based alloys.
JP9115	AJコーティング PVD	91.5 2.0	Ni基超耐熱合金加工用 For cutting of Ni based alloy	汎用性に優れた超硬合金と耐熱性に優れたAJコーティングを採用。 Ni基超耐熱合金の加工に優れる。 Uses highly versatile cemented carbide and AJ coating with excellent heat resistance. Excellent machining of Ni-based alloys.
HX3505 K05	HXコーティング CVD	92.5 3.0	鋳鉄用 For cast iron	厚膜のHXコーティングと高硬度のK種超硬母材により耐摩耗性に優れる。 Excellent wear resistance due to thick HX Coating membrane and high-hardness K type carbide base metal
HG8010 P10-15	HGコーティング CVD	91.8 1.6	鋼高速仕上げ用 For high-speed finishing of steel	厚膜のαアルミナを採用し、鋼の高速切削に優れる Uses thick coating of α alumina; Excellent for high-speed cutting of steel
HX3515 K10	HXコーティング CVD	91.5 2.0	鋳鉄一般用 Universal material of cast iron	耐着性に優れたHXコーティングと、靱性(耐欠損性)に優れたK種超硬母材により、連続切削から断続切削まで幅広い切削領域で安定した加工が可能。 By HX coat which is adhesion resistance, and K-type toughest substrate, cutting stabilized in the cutting domain broad from continuous cutting to interrupted cutting is possible.
IP100S M10	iPコーティング PVD	91.5 2.0	ステンレス用・耐熱鋼用 For stainless steel, For heat-resistant alloy	厚膜のPVD-iPコーティングと高硬度母材により、耐摩耗性に優れる Excellent wear resistance due to thick PVD-iP Coating membrane and high-hardness base metal
IP050S M10	iPコーティング PVD	91.5 3.0	ステンレス用・耐熱鋼用 For stainless steel, For heat-resistant alloy	厚膜のPVD-iPコーティングと高硬度母材により、耐摩耗性に優れる Excellent wear resistance due to thick PVD-iP Coating membrane and high-hardness base metal
GM8020 P20	GMコーティング CVD	91.0 1.8	鋼一般用 General purpose for steel	アンカー効果によるαアルミナを採用広範囲の切削領域を持つ Anchor effect for use of α alumina; Has expanded cutting region range
IP2000 P25	iPコーティング PVD	91.0 1.8	鋼一般用・鋼断続用 General purpose for steel For interrupted cutting of steel	超強靱iPコーティングを採用し、高い耐欠損性を実現 High chipping resistance achieved by utilizing ultra-tough iP Coating
HG8025 P25	HGコーティング CVD	90.3 1.7	鋼一般用 General purpose for steel	トリプルZr効果で、広範囲の切削領域を持つ The effect of triple Zr provides a wide cutting range.
IP3000 P30	iPコーティング PVD	90.3 1.7	鋼断続用 For interrupted cutting of steel	超強靱iPコーティングを採用し、高い耐欠損性を実現 High chipping resistance achieved by utilizing ultra-tough iP Coating
GM25 P25	GMコーティング CVD	90.3 1.8	鋼一般用 General purpose for steel	皮膜、母材ともにバランスがとれた設計で広範囲で使用可 Designed with balanced base material and coating to enable use over a wide range
GM8035 P30	GMコーティング CVD	89.5 1.8	鋼断続用 For interrupted cutting of steel	強靱性超硬母材を採用し、断続切削に適している Uses high-toughness base material; suitable for interrupted cutting
GX30 M30	GXコーティング CVD	89.0 2.2	ステンレス用・鋼一般用 For stainless steel, General purpose for steel	強靱性超硬母材を採用し、密着性を高めた皮膜を採用 Uses high-toughness base material; Uses high-adhesion coating
CZ25 P20	PCコーティング PVD	91.7 1.2	鋼の仕上げ用 Finishing for steel	母材はサーメットで、高速加工で仕上げ面が綺麗 Uses cermet base material for high-speed machining with a clean finish

※代表値であり規格ではありません。また予告なく変更することがあります。It is a representative value and not a standard, may change without prior notice.

Guide to grades for turning inserts 旋削用インサート材種選択基準

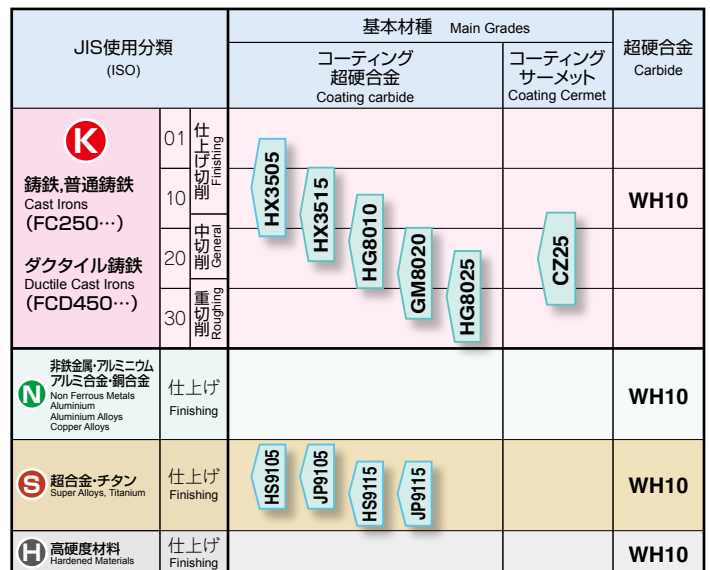
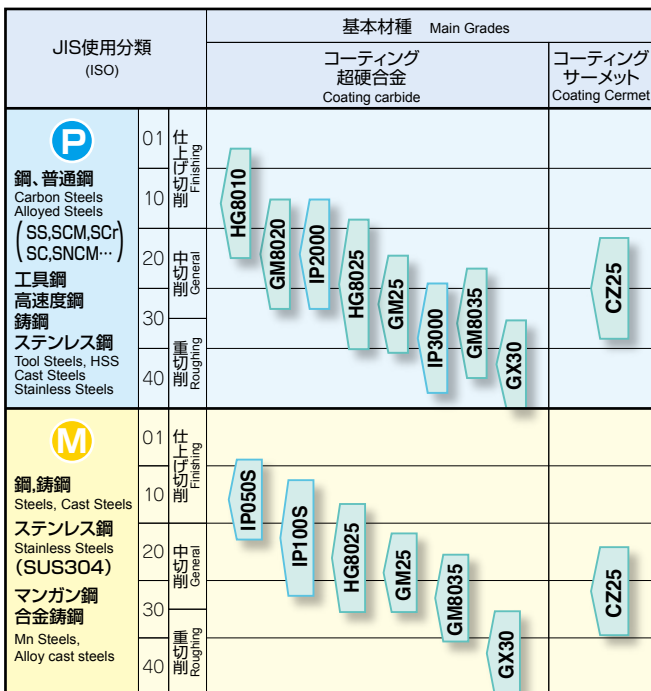









旋削用インサート標準切削条件表

鋼用インサート切削条件 Cutting condition for Steels



仕上げ切削 Finishing	外径 Outer Dia.	FE ブレーカ 	切込み Depth of cut (mm)	送り Feed Rate (mm/rev)	切削速度 Cutting Speed (m/min)				
			0.1~1.0	0.1~0.2	CZ25 150~300				
半仕上げ切削 Semi-Finishing	外径 Outer Dia.	BH ブレーカ 	切込み Depth of cut (mm)	送り Feed Rate (mm/rev)	切削速度 Cutting Speed (m/min)				
			0.1~1.5	0.1~0.3	HG8010	HG8025			
	内径 Inner Dia.	JQ ブレーカ 	切込み Depth of cut (mm)	送り Feed Rate (mm/rev)	切削速度 Cutting Speed (m/min)				
			0.3~1.2	0.1~0.25	HG8010	HG8025			
	軽切削 Light cutting	外径 Outer Dia.	AB ブレーカ 	切込み Depth of cut (mm)	送り Feed Rate (mm/rev)	HG8010	HG8025	GM8035	GM25
				0.5~3.0	0.15~0.5	150~300	150~300	150~250	150~200
内径 Inner Dia.		CT ブレーカ 	切込み Depth of cut (mm)	送り Feed Rate (mm/rev)	切削速度 Cutting Speed (m/min)				
			0.8~3.0	0.15~0.5	HG8010	HG8025			
中切削 Medium cutting	外径 Outer Dia.	CE ブレーカ 	切込み Depth of cut (mm)	送り Feed Rate (mm/rev)	切削速度 Cutting Speed (m/min)				
			1.0~4.0	0.15~0.4	GM25 100~200				
			内径 Inner Dia.	JE ブレーカ 	切込み Depth of cut (mm)	送り Feed Rate (mm/rev)	切削速度 Cutting Speed (m/min)		
1.0~3.0	0.15~0.3	HG8010			HG8025	CZ25		150~250	
中切削 Medium cutting	外径 Outer Dia.	AH ブレーカ 	切込み Depth of cut (mm)	送り Feed Rate (mm/rev)	切削速度 Cutting Speed (m/min)				
			1.0~4.0	0.15~0.5	HG8010	HG8025			
			内径 Inner Dia.	AE ブレーカ 	切込み Depth of cut (mm)	送り Feed Rate (mm/rev)	HG8010	HG8025	GM25
1.0~5.0	0.15~0.5	180~300			150~250	100~200			
中切削 Medium cutting	外径 Outer Dia.	AY ブレーカ 	切込み Depth of cut (mm)	送り Feed Rate (mm/rev)	切削速度 Cutting Speed (m/min)				
			1.5~5.0	0.15~0.5	HG8010	HG8025			
			内径 Inner Dia.	RE ブレーカ 	切込み Depth of cut (mm)	送り Feed Rate (mm/rev)	切削速度 Cutting Speed (m/min)		
2.0~7.0	0.25~0.8	HG8010			HG8025	GM25		100~200	

Recommended cutting conditons of turning inserts 旋削用インサート標準切削条件表

ステンレス用インサート切削条件 Cutting condition for Stainless Steels

仕上げ切削 Finishing	外径 Outer Dia.	MP ブレーカ		切込み Depth of cut (mm)	送り Feed Rate (mm/rev)	切削速度 Cutting Speed (m/min)	
				0.2~1.0	0.08~0.2	IP050S	80~250
中切削 Medium cutting	外径 Outer Dia.	BH ブレーカ		切込み Depth of cut (mm)	送り Feed Rate (mm/rev)	切削速度 Cutting Speed (m/min)	
		0.3~1.5	0.1~0.3	HG8025	160~250		
		AB ブレーカ		切込み Depth of cut (mm)	送り Feed Rate (mm/rev)	切削速度 Cutting Speed (m/min)	
0.5~1.5	0.1~0.35	GM25	100~250				
中切削 Medium cutting	外径 Outer Dia.	PV ブレーカ		切込み Depth of cut (mm)	送り Feed Rate (mm/rev)	切削速度 Cutting Speed (m/min)	
		1.0~4.0	0.15~0.4	IP100S	80~250		
		SE ブレーカ		切込み Depth of cut (mm)	送り Feed Rate (mm/rev)	切削速度 Cutting Speed (m/min)	
		1.0~3.0	0.1~0.35	GM25	100~250		
DE ブレーカ		切込み Depth of cut (mm)	送り Feed Rate (mm/rev)	切削速度 Cutting Speed (m/min)			
1.0~4.0	0.15~0.4	GX30	80~200				
AH ブレーカ		切込み Depth of cut (mm)	送り Feed Rate (mm/rev)	切削速度 Cutting Speed (m/min)			
1.0~3.0	0.15~0.4	HG8025	100~250				
荒切削 Roughing	外径 Outer Dia.	AE ブレーカ		切込み Depth of cut (mm)	送り Feed Rate (mm/rev)	切削速度 Cutting Speed (m/min)	
		1.0~5.0	0.15~0.5	GX30	80~150		

鋳鉄用インサート切削条件 Cutting condition for Cast Iron

仕上げ切削 Finishing	外径 Outer Dia.	VA ブレーカ		切込み Depth of cut (mm)	送り Feed Rate (mm/rev)	切削速度 Cutting Speed (m/min)	
				0.3~1.0	0.1~0.25	HX3515	150~300
中切削 Medium cutting	外径 Outer Dia.	V ブレーカ		切込み Depth of cut (mm)	送り Feed Rate (mm/rev)	HX3515	HG8010
		1.0~5.0	0.15~0.4	150~250	120~230		
荒切削 Roughing	外径 Outer Dia.	V ブレーカ		切込み Depth of cut (mm)	送り Feed Rate (mm/rev)	HX3515	HG8010
		2.0~7.0	0.3~0.8	150~250	120~230		

Ni基超耐熱合金用インサート切削条件 Cutting condition for Ni based alloy

仕上げ切削 Finishing, medium cutting	外径 Outer dia.	VI ブレーカ		切込み Depth of cut (mm)	送り Feed rate (mm/rev)	切削速度 Cutting speed (m/min)	
				0.2~4.0	0.1~0.4	HS9105	JP9105
						40~80	20~40

旋削用インサート
旋削用インサート標準切削条件表

Various types of coating materials for turning 各社旋削用コーティング材種

(各社より承認を得たものではありません。Data is not approved by each company.)

鋼用コーティングインサートの使用範囲 Application range of coating inserts for steel

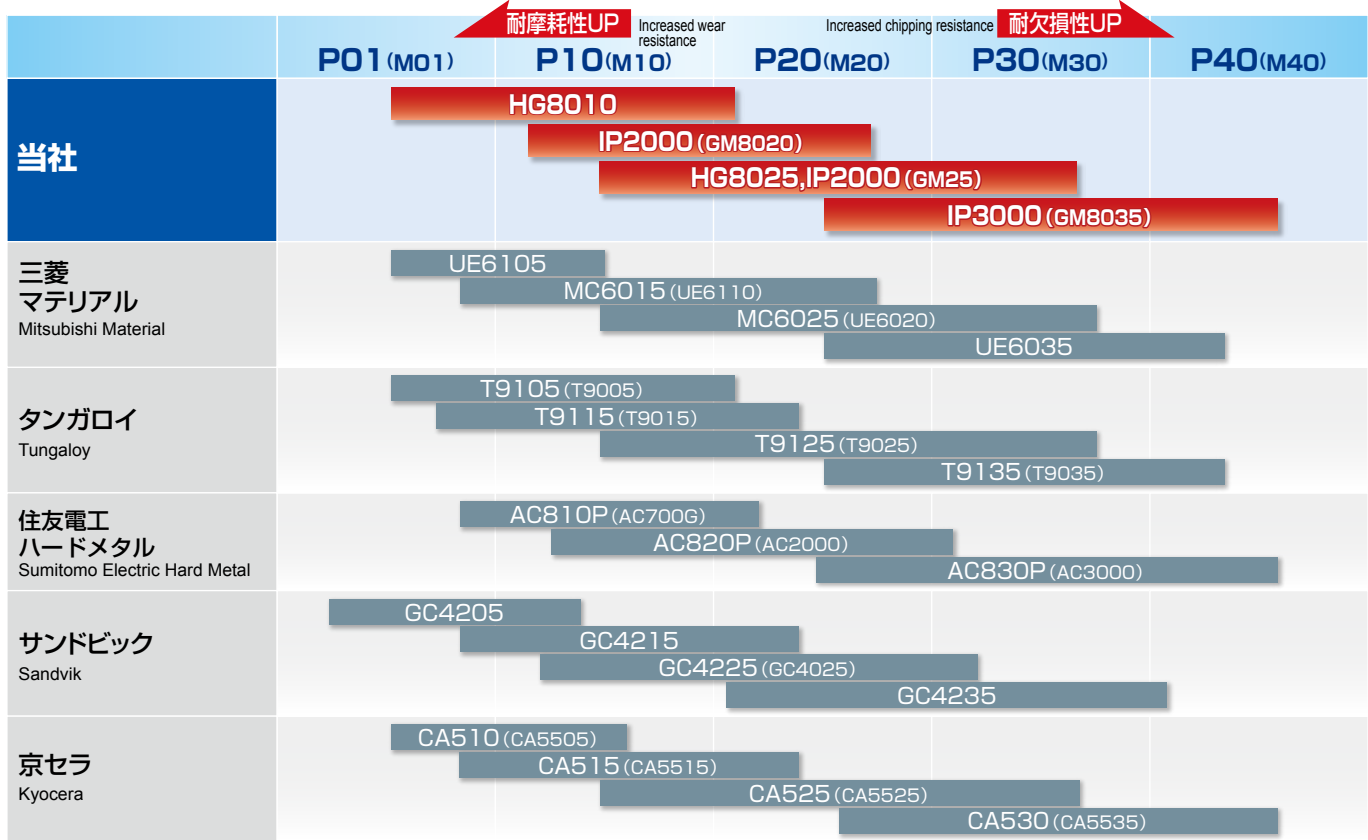

鋳物用コーティングインサートの使用範囲

Application range of coating inserts for cast objects

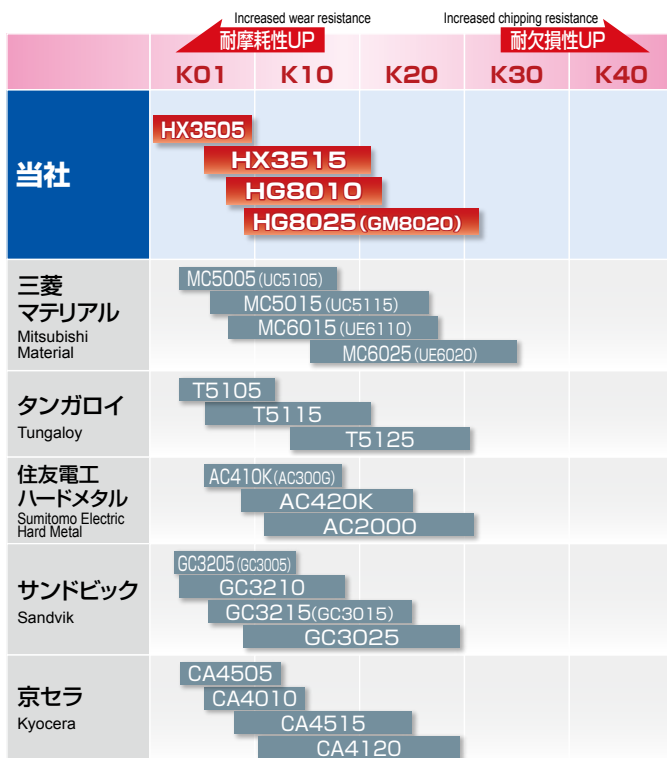

ステンレス用コーティングインサートの使用範囲

Application range of coating inserts for stainless steel

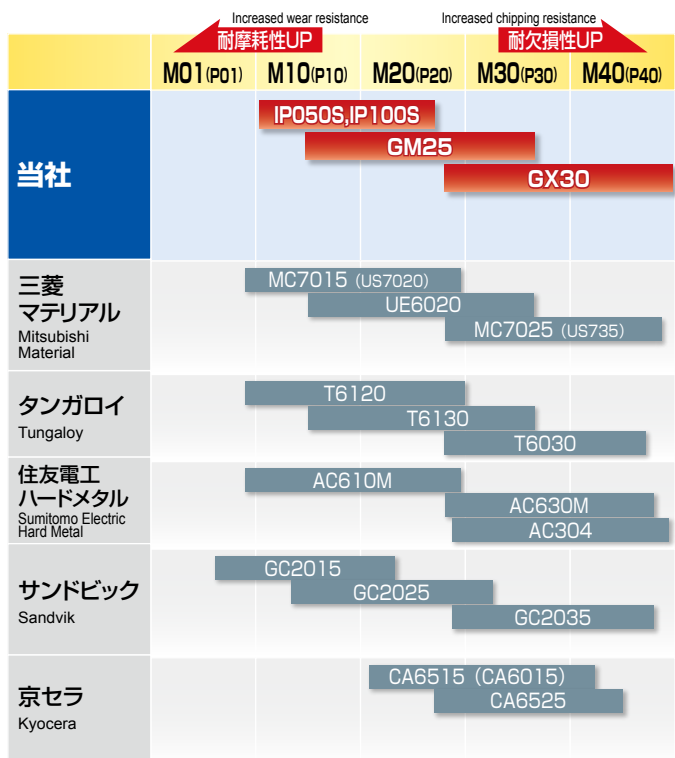

Turning Inserts

旋削用インサートの呼び方

①形状記号 Insert Shape		
記号 Symbol	形状 Insert Figure	頂角 Shape
H	正六角形 Hexagonal	120°
O	正八角形 Octagonal	135°
P	正五角形 Pentagonal	108°
S	正方形 Square	90°
T	正三角形 Triangle 60°	60°
C	ひし形 Diamond	80°
D		55°
E		75°
F		50°
M		86°
V	35°	
W	六角形 Hexagonal	80°
L	長方形 Rectangular	90°
A	平行四辺形 Parallelogram	85°
B		82°
K		55°
R		円形 Round

③精度記号 Tolerance Class			
記号 Symbol	コーナ 高さ m 許容差 Nose Height (mm)	内接円 φ d 許容差 Inscribed Circle (mm)	厚み S 許容差 Thickness (mm)
A	± 0.005	± 0.025	± 0.025
F	± 0.005	± 0.013	± 0.025
C	± 0.013	± 0.025	± 0.025
H	± 0.013	± 0.013	± 0.025
E	± 0.025	± 0.025	± 0.025
G	± 0.025	± 0.025	± 0.13
J	± 0.005	± 0.05 ~± 0.13	± 0.025
K*	± 0.013	± 0.05 ~± 0.13	± 0.025
L*	± 0.025	± 0.05 ~± 0.13	± 0.025
M*	± 0.08 ~± 0.18	± 0.05 ~± 0.13	± 0.13
N*	± 0.08 ~± 0.18	± 0.05 ~± 0.13	± 0.025
U*	± 0.13 ~± 0.38	± 0.08 ~± 0.25	± 0.13

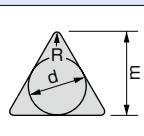
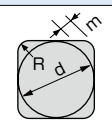
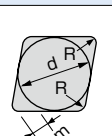
(注) J,K,L,M,N,U 級については、形状、内接円ごとに精度が異なります。
Symbols J and U for SNPR/L, SPP TNPR/L, TNP by CIS Standards May be considered that is G and U is M in the table

形状	内接円 直径	コーナ高さmの許容差		内接円dの許容差	
		J,K,L,M,N	U	J,K,L,M,N	U
頂角55°を超える インサートS	6.35 9.525	±0.08	±0.13	±0.05	±0.08
H ● T ▲	12.7	±0.13	±0.20	±0.08	±0.13
O ● W ●	15.875	±0.15	±0.27	±0.10	±0.18
P ● R ●	19.05	±0.15	±0.27	±0.10	±0.18
C,E,M	25.4	±0.18	±0.38	±0.13	±0.25
頂角55°以下のインサート	6.35 9.525	±0.11		±0.05	
D	12.7	±0.15		±0.08	
V	15.875 19.05	±0.18		±0.18	

※印のものは原則として焼結肌のインサートです。
Generally these marked items have unground faces

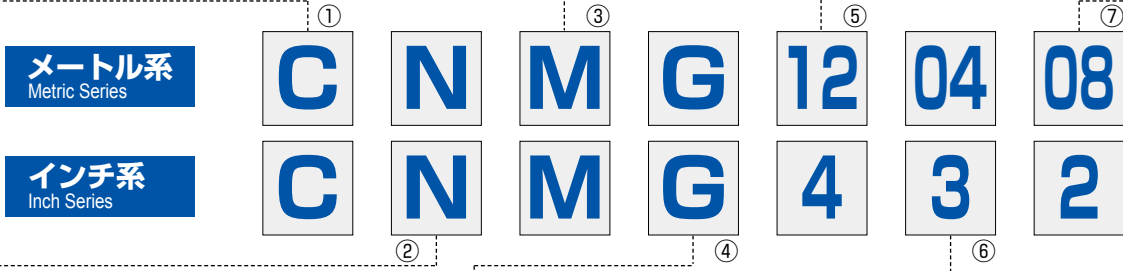

②逃げ角記号 Normal Clearance	
記号 Symbol	逃げ角(度) Clearance
A	3°
B	5°
C	7°
D	15°
E	20°
F	25°
G	30°
N	0°
P	11°
O	その他の逃げ角 Others

④溝・穴記号 Fixing and/or Chip Breaker					
メートル系 Metric Series	穴の有無 Hole	穴の形状 Fixing	ブレーカ の有無 Chip Breaker	形状 Figure	
				通常系列 Normal Series	小形系列 Small Size Series
N	なし Nil	—	なし Nil		N
R			片面 One Sided		R
F			両面 Both Sided		F
A	あり With Hole	円筒穴 Cylindrical hole	なし Nil		A
M			片面 One Sided		M
G			両面 Both Sided		G
W	あり With Hole	一部円筒穴 片面 40°~60° Cylindrical hole, 40-60° countersinks on one side	なし Nil		A
T			片面 One Sided		M
Q			両面 Both Sided		G
U	あり With Hole	一部円筒穴 両面 40°~60° Cylindrical hole, 40-60° countersinks on both sides	なし Nil		A
B			片面 One Sided		M
H			両面 Both Sided		G
C	あり With Hole	一部円筒穴 片面 70°~90° Cylindrical hole, 70-90° countersinks on one side	なし Nil		A
J			片面 One Sided		M
X			両面 Both Sided		G

⑥厚さ記号 Thickness			
メートル系 Metric Series	厚み Thickness (mm)	インチ系 Inch Series	
		通常系列 Normal Series	小形系列 Small Size Series
01	1.59	—	2
02	2.38	—	3
T2	2.78	—	—
03	3.18	2	4
T3	3.97	—	5
04	4.76	3	6
06	6.35	4	—
07	7.94	5	—
09	9.52	6	—

※厚みは底面と切れ刃最高部との厚さを示します。

⑤切れ刃長さ記号と内接円記号 Edge Length & Diameter of Inscribed Circle																
メートル系 (切れ刃長さ mm) Metric Series (Edge Length)												内接円直径 Diameter of Inscribed Circle (mm)	インチ系 (内接円記号) Inch Series (Inscribed Circle)			
R	S	C	W	T	D	V	K	通常系列 Nomal Series	小形系列 Small Size Series							
記号	切れ刃長さℓ	記号	切れ刃長さℓ	記号	切れ刃長さℓ	記号	切れ刃長さℓ	記号	切れ刃長さℓ	記号	切れ刃長さℓ	記号	切れ刃長さℓ			
		03	3.97	03	4.0			06	6.9	04	4.8			3.97		5
		04	4.76	04	4.8			08	8.2	05	5.8	08		4.76		6
05	5.0													5.0		
		05	5.56	05	5.6	03	3.8	09	9.6	06	6.8			5.56		7
06	6.0													6.0		
		06	6.35	06	6.5	04	4.3	11	11.0	07	7.8	11	11.1	6.35	2	(8)
		07	7.94	08	8.1	05	5.4	13	13.8	09	9.7			7.94		0
08	8.0													8.0		
09	9.525	09	9.525	09	9.7	06	6.5	16	16.5	11	11.6	16	16.6	9.525	3	
10	10.0													10.0		
12	12.0													12.0		
12	12.7	12	12.7	12	12.9	08	8.7	22	22.0	15	15.5	22	22.1	12.7	4	
15	15.875	15	15.875	16	16.1	10	10.9	27	27.5	19	19.4			15.875	5	
16	16.0													16.0		
19	19.05	19	19.05	19	19.3	13	13.0	33	33.0	23	23.3			19.05	6	
20	20.0													20.0		
		22	22.225	22	22.6			38	38.5	27	27.1			22.225	7	
25	25.0													25.0		
25	25.4	25	25.4	25	25.8			44	44.0	31	31.0			25.4	8	
31	31.75	31	31.75	32	32.2			55	55.0	38	38.8			31.75	0	
32	32.0													32.0		

⑦コーナ記号 Corner Configuration		
メートル系 Metric Series	コーナ半径(mm) Corner Radius	インチ系 Inch Series
00	シャープコーナ Not Rounded	V
02	0.2	0
04	0.4	1
08	0.8	2
12	1.2	3
16	1.6	4
20	2.0	5
24	2.4	6
28	2.8	7
32	3.2	8
00 (インチ系) または MO (メートル系)	円形インサート Round Inserts	—

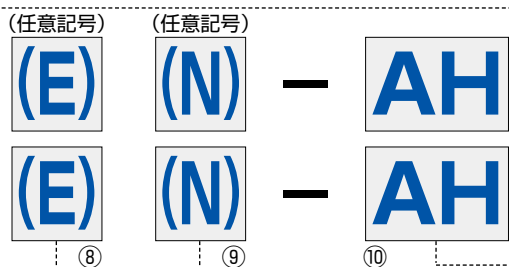

(JIS B 4120より)

⑧刃先処理記号 Cutting Edge Condition		
記号 Symbol	切れ刃の状態 Cutting Edge Condition	形状 Figure
F	シャープエッジ Sharp cutting edges	
E	丸ホーニング刃 Rounded cutting edges	
T	チャンファホーニング刃 Chamfered cutting edges	
S	コンビネーションホーニング刃 Chamfered and rounded cutting edges	
刃先処理記号は省略しております。 Cutting edge symbol is omitted.		











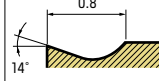

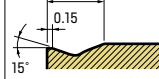
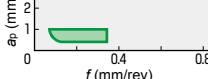

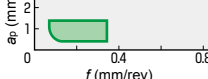

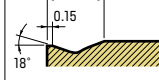
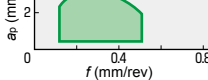

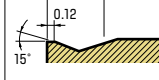
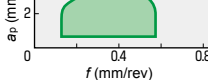

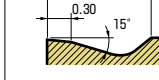
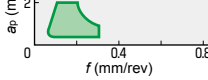
⑨勝手記号 Feed Direction	
記号 Symbol	勝手 Feed Direction Figure
R	右 Right hand
L	左 Left hand
N	なし Neutral
N	
R	
L	
勝手なしの場合、記号は省略しております。 Symbol is omitted for neutral feed direction.	

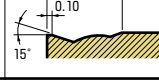
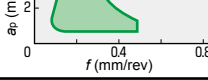
⑩ブレーカ記号 Chip Breaker			
AB	AE	AH	AR
AY	B	BE	BH
CE	CT	DE	FE
H	HE	HX	J
JQ	JE	PV	RE
RG	SE	TE	UE
V	VA	WE	Y

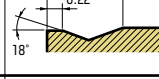
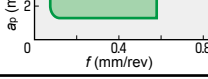
※各記号に対応するインサート現品寸法は、製品仕様により必ずしも一致するわけではありません。

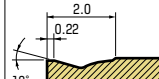
80° ひし形インサート

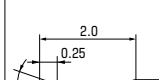
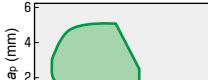
切削条件表 G5
Cutting Conditions

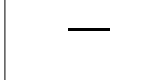
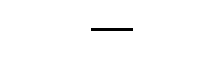
被削材 Work material	● : 一般切削・第一推奨 General cutting, First recommended		○ : 一般切削・第二推奨 General cutting, Second recommended		P	鋼	Carbon steels	●	●	●	●	●	●	○	○	○	○	○	○	○					
	M	SUS等	SUS, etc.	K	FC・FCD	Cast irons	○	○	○	○	○	○	○	○	○	○	○	○	○	○					
区分 Group	ブレーカ Breaker	ブレーカ断面形状 Breaker cross-section shape (mm)	切りくず処理領域 Chip removal region	商品コード (メートル系) Item code (metric)	コーナ半径 RE Nose radius (mm)	コーティング Coating							コーティングサーメット Coating cermet			希望小売価格(円) Suggested retail price (¥)									
						H	高硬度材	Hardened steels	HGコーティング	IPコーティング	GMコーティング	GXコーティング	PCコーティング	●	○		○								
						HG8010	HG8025	IP2000	IP3000	GM25	GM8020	GM8035	GX30	PC225											
仕上切削 For finishing	FE 			CNMG120404-FE	0.4	●	●													1,010					
				CNMG120408-FE	0.8	●										●						1,010			
	BE 			CNMG120404-BE	0.4					●	△										1,010				
				CNMG120408-BE	0.8					●	●											1,010			
	BH 			CNMG120404-BH	0.4	●	●	●														1,010			
				CNMG120408-BH	0.8	●	●	●															1,010		
CNMG120412-BH				1.2	●	●	●															1,010			
半切削 For semi finishing	AB 			CNMG120404-AB	0.4	●	●	●			●											1,010			
				CNMG120408-AB	0.8	●	●	●			●	●	●										1,010		
				CNMG120412-AB	1.2	●	●	●			●		●											1,010	
	CT 			CNMG120408-CT	0.8	●	●															1,010			
				CNMG120412-CT	1.2	●	●																1,010		
	B 			CNMG120404-B	0.4						●												1,010		
CNMG120408-B				0.8						●													1,010		
CE 			CNMG120404-CE	0.4						●				●								1,010			
			CNMG120408-CE	0.8						●					●								1,010		
			CNMG120412-CE	1.2						●													1,010		
中切削 For medium cutting	AH 			CNMG120404-AH	0.4	●	●	●														1,010			
				CNMG120408-AH	0.8	●	●	●															1,010		
				CNMG120412-AH	1.2	●	●	●																1,010	
				CNMG120416-AH	1.6	●	●	●																1,010	
	AE 			CNMG120404-AE	0.4	●	●	●			●	●	●	●									1,010		
				CNMG120408-AE	0.8	●	●	●			●	●	●	●	●	●								1,010	
				CNMG120412-AE	1.2	●	●	●			●	●	●	●	●	●									1,010
				CNMG120416-AE	1.6						●	△													1,010
				CNMG160608-AE	0.8	●	●	●					●												2,220
	AY 			CNMG120404-AY	0.4	●	●	●			●	●											1,010		
				CNMG120408-AY	0.8	●	●	●			●	●												1,010	
				CNMG120412-AY	1.2	●	●	●			●	●												1,010	
CNMG120416-AY				1.6	△	●	●			●	●													1,010	
AR 			CNMG120408-AR	0.8						●												1,010			

●印：標準在庫品です。 △印：在庫が無くなり次第販売終了です。
● : Stocked Items. △ : The sale ends when all the stock is out.

80° ひし形インサート

被削材 Work material		●: 一般切削・第一推奨 General cutting, First recommended ○: 一般切削・第二推奨 General cutting, Second recommended		P 鋼 Carbon steels		M SUS等 SUS, etc.		K FC・FCD Cast irons		N アルミニウム合金 Aluminum alloys		S チタン合金 Titanium alloys		H 高硬度材 Hardened steels			
				●	○	●	○	●	○	●	○	●	○	●	○		
区分 Group	ブレーカ Breaker	ブレーカ断面形状 Breaker cross-section shape (mm)	切りくず処理領域 Chip removal region	商品コード (メートル系) Item code (metric)	コーナ半径 RE Nose radius (mm)	コーティング Coating							コーティングサーメット Coating cermet	希望小売価格(円) Suggested retail price (¥)			
						HGコーティング HG8010	IPコーティング IP2000	GMコーティング GM25	IPコーティング IP0505	HXコーティング HX3505	HXコーティング HX3515	PCコーティング CZ25					
汎用切削 For general cutting	無し Non Breaker		—	CNMA120408	0.8	●										1,560	
				CNMA120412	1.2	●											1,560
				CNMA120416	1.6												
仕上切削 For finishing	MP			CCMT060202-MP	0.2	-	-	-	-	△	-	-	-			820	
				CCMT060204-MP	0.4	-	-	-	-	△	-	-	-			820	
				CCMT09T304-MP	0.4	-	-	-	-	●	-	-	-			1,140	
				CPMT080202-MP	0.2	-	-	-	-	△	-	-	-			820	
				CPMT080204-MP	0.4	-	-	-	-	●	-	-	-			820	
	JQ			CCMT09T304-JQ	0.4	●	●	△	●	-	-	-			1,140		
				CCMT09T308-JQ	0.8	●	●	△		-	-	-			1,140		
				CPMT080204-JQ	0.4	●	●	△		-	-	-			820		
				CPMT080208-JQ	0.8	●	●	●		-	-	-			820		
				CPMT090304-JQ	0.4	●	●	●		-	-	-			960		
中切削 For medium cutting	JE			CCMT060202-JE	0.2				●	-	-	-			820		
				CCMT060204-JE	0.4	●	●	●	●	-	-	-	●		820		
				CCMT09T302-JE	0.2					-	-	-	●		1,140		
				CCMT09T304-JE	0.4	●	●	●	△				●		1,140		
				CCMT09T308-JE	0.8	●	●	●	●				●		1,140		
				CPMT080204-JE	0.4	●	●	△	●				●		820		
				CPMT080208-JE	0.8	●	●	△	●				●		820		
				CPMT090304-JE	0.4	●	●	●	●				●		960		
CPMT090308-JE	0.8	●	●	●	●				●		960						

旋削用インサート

55° ひし形インサート

被削材 Work material		●: 一般切削・第一推奨 General cutting, First recommended ○: 一般切削・第二推奨 General cutting, Second recommended		P 鋼 Carbon steels		M SUS等 SUS, etc.		K FC・FCD Cast irons		N アルミニウム合金 Aluminum alloys		S チタン合金 Titanium alloys		H 高硬度材 Hardened steels		
				●	○	●	○	●	○	●	○	●	○	●	○	
区分 Group	ブレーカ Breaker	ブレーカ断面形状 Breaker cross-section shape (mm)	切りくず処理領域 Chip removal region	商品コード (メートル系) Item Code (metric)	コーナ半径 RE Nose radius (mm)	コーティング Coating							コーティングサーメット Coating Cermet	希望小売価格(円) Suggested retail price (¥)		
						HGコーティング HG8010	HGコーティング HG8025									PCコーティング CZ25
仕上切削 For Finishing	FE			DNMG150404-FE	0.4	●	●							●		1,400
				DNMG150408-FE	0.8	●	●									●

●印: 標準在庫品です。 △印: 在庫が無くなり次第販売終了です。
●: Stocked Items. △: The sale ends when all the stock is out.

55° ひし形インサート

切削条件表 **G5**
Cutting Conditions

被削材 Work material	●：一般切削・第一推奨 General cutting, First recommended		○：一般切削・第二推奨 General cutting, Second recommended		P	鋼	Carbon steels	●	●	●	●	○														
	M		K		N		S		H		コーティング Coating		希望小売価格(円) Suggested retail price (¥)													
区分 Group	ブレーカ Breaker	ブレーカ断面形状 Breaker cross-section shape (mm)	切りくず処理領域 Chip removal region	商品コード (メートル系) Item Code (metric)	コーナ半径 RE Nose radius (mm)	コーティング Coating														希望小売価格(円) Suggested retail price (¥)						
						HG8010	HG8025	IP2000	IP3000	GM25	IP050S	IP100S	GX30	HX3505	HX3515	HS9105	HS9115	JP9105	JP9115							
中切削 For medium cutting	PV			DNMG150404-PV	0.4							●									1,400					
				DNMG150408-PV	0.8								●										1,400			
	SE			DNMG150404-SE	0.4					●												1,400				
				DNMG150608-SE	0.8					△														1,720		
	DE			DNMG150408-DE	0.8								●										1,400			
				DNMG150608-DE	0.8									●										1,720		
仕上げ For Finishing	Y			DNMG150612-Y	1.2					●												1,720				
仕上げ 中切削 For Finishing, Medium cutting	VI			VI-DNMG150404	0.4											●	●	●	●			2,090				
				VI-DNMG150408	0.8													●	●	●	●			2,090		
				VI-DNMG150412	1.2														●	●	●	●			2,090	
				VI-DNMG150608	0.8														●	●	●	●			2,580	
				VI-DNMG150612	1.2														●	●	●	●			2,580	
中切削 For Medium cutting	V			DNMG150404-V	0.4	●					●				●	●						1,400				
				DNMG150408-V	0.8	●					●					●	●							1,400		
				DNMG150412-V	1.2	●											●	●							1,400	
				DNMG150608-V	0.8	●												●							1,720	
				DNMG150612-V	1.2	●																			1,720	
	VA			DNMG150404-VA	0.4	●										●							1,400			
				DNMG150408-VA	0.8	●												●						1,400		
				DNMG150412-VA	1.2	●												●							1,400	
DNMG150604-VA			DNMG150604-VA	0.4	●																	1,720				
			DNMG150608-VA	0.8	●																		1,720			
			DNMG150612-VA	1.2	●																			1,720		
汎用 For General cutting	無し Non Breaker			DNMA150408	0.8	●	●															1,800				
				DNMA150412	1.2	●	●																	1,800		
仕上げ For Finishing	MP			DCMT070202-MP	0.2								△										950			
				DCMT070204-MP	0.4									●											950	
				DCMT070208-MP	0.8										●											950
				DCMT11T302-MP	0.2										●											1,280
				DCMT11T304-MP	0.4										△											1,280
				DCMT11T308-MP	0.8										●											1,280
	JQ			DCMT070204-JQ	0.4	●	●	●	●															950		
				DCMT070208-JQ	0.8	△	●	●	●																950	
DCMT11T304-JQ			DCMT11T304-JQ	0.4	●	●	●	△															1,280			
			DCMT11T308-JQ	0.8	●	●	●	●																1,280		

●印：標準在庫品です。 △印：在庫が無くなり次第販売終了です。
●： Stocked Items. △： The sale ends when all the stock is out.

90° 正方形インサート

被削材 Work material	●: 一般切削・第一推奨 General cutting, First recommended		○: 一般切削・第二推奨 General cutting, Second recommended		P	鋼	Carbon steels	●	●	●	○													
	●: 一般切削・第一推奨 General cutting, First recommended		○: 一般切削・第二推奨 General cutting, Second recommended		M	SUS等	SUS, etc.		○		○	●	●	●										
				K	FC・FCD	Cast irons	○	○						●	●									
				N	アルミニウム合金	Aluminum alloys																		
				S	チタン合金	Titanium alloys										●	●	●	●					
				H	高硬度材	Hardened steels																		
区分 Group	ブレーカ Breaker	ブレーカ断面形状 Breaker cross-section shape (mm)	切りくず処理領域 Chip removal region	商品コード (メートル系) Item Code (metric)	コーナ半径 RE Nose radius (mm)	コーティング Coating										希望小売価格(円) Suggested retail price (¥)								
						HGコーティング	IPコーティング	GMコーティング	IPコーティング	GXコーティング	HXコーティング	HSコーティング	AJコーティング											
仕上切削 For finishing	MP			SNMG120408-MP	0.8																1,180			
				SNMG120412-MP	1.2																		1,180	
中切削 For medium cutting	PV			SNMG120408-PV	0.8																1,180			
				SNMG120412-PV	1.2																		1,180	
	DE			SNMG120408-DE	0.8																1,180			
				SNMG120412-DE	1.2																		1,180	
仕上切削 For finishing	Y			SNMG120408-Y	0.8																1,180			
仕上中切削 For finishing, medium cutting	VI			VI-SNMG120408	0.8																1,760			
				VI-SNMG120412	1.2																		1,760	
				VI-SNMG190616	1.6																			4,240
中切削 For medium cutting	V			SNMG120408-V	0.8	●															1,180			
				SNMG120412-V	1.2	●																	1,180	
				SNMG120416-V	1.6	●																		1,180
				SNMG120420-V	2	●																		1,180
				SNMG190612-V	1.2	●	●																	2,820
				SNMG190616-V	1.6	●	●																	2,820
				SNMG250724-V	2.4	●																		4,930
中切削 For medium cutting	VA			SNMG120404-VA	0.4	●															1,180			
				SNMG120408-VA	0.8	●																	1,180	
				SNMG120412-VA	1.2	●																		1,180
				SNMG120416-VA	1.6	●																		1,180
重切削 For heavy-duty cutting	HX			SNMM190612-HX	1.2			●													2,640			
				SNMM250716-HX	1.6			●															4,860	
				SNMM250724-HX	2.4			●																4,860
				SNMM310924-HX	2.4			●																8,760
	重切削 For heavy-duty cutting	H			SNMM190612-H	1.2			●	●												2,640		
SNMM190616-H					1.6			●	●														2,640	
SNMM250712-H					1.2			●																4,860
重切削 For heavy-duty cutting	HE			SNMM250724-HE	2.4			●													4,860			
				SNMM310924-HE	2.4			●															8,760	
汎用切削 For general cutting	無し Non Breaker			SNMA120408	0.8	●	●														1,560			
				SNMA120412	1.2	●	●																1,560	

●印: 標準在庫品です。 △印: 在庫が無くなり次第販売終了です。
●: Stocked Items. △: The sale ends when all the stock is out.

被削材 Work material		●: 一般切削・第一推奨 General cutting, First recommended ○: 一般切削・第二推奨 General cutting, Second recommended		P 鋼 Carbon steels	M SUS等 SUS, etc.	K FC・FCD Cast irons	N アルミニウム合金 Aluminum alloys	S チタン合金 Titanium alloys	H 高硬度材 Hardened steels	コーティング Coating						希望小売価格(円) Suggested retail price (¥)		
区分 Group	ブレーカ Breaker	ブレーカ断面形状 Breaker cross-section shape (mm)	切りくず処理領域 Chip removal region	商品コード (メートル系) Item Code (metric)	コーナ半径 RE Nose radius (mm)	コーティング Coating						希望小売価格(円) Suggested retail price (¥)						
						IPコーティング IP Coating	GMコーティング GM Coating	IPコーティング IP Coating	PCコーティング PC Coating	コーティングサーメット Coating cermet	非コーティング Non coating							
中切削 For medium cutting			汎用 General	SNMG120404L-N	0.4	●	●	●	●	●	●	●	●	●	●	1,070		
				SNMG120408L-N	0.8													1,070
汎用切削 For general cutting			—	SPMN120308	0.8											950		
仕上げ切削 For finishing				SPMT090304-MP	0.4	—	—	—	●	—	—	—	—	—	—	960		
				SPMT090308-MP	0.8	—	—	—	●	—	—	—	—	—	—	—	—	960
中切削 For medium cutting				SCMT09T304-JE	0.4	●	●	—	—	—	—	—	—	—	—	1,140		
				SCMT09T308-JE	0.8	●	●	—	—	—	—	—	—	—	—	—	—	1,140
				SPMT090308-JE	0.8	●	●	—	—	—	●	—	—	—	—	—	—	960

Triangle 60° Inserts 60° 三角形インサート

被削材 Work material		●: 一般切削・第一推奨 General cutting, First recommended ○: 一般切削・第二推奨 General cutting, Second recommended		P 鋼 Carbon steels	M SUS等 SUS, etc.	K FC・FCD Cast irons	N アルミニウム合金 Aluminum alloys	S チタン合金 Titanium alloys	H 高硬度材 Hardened steels	コーティング Coating						希望小売価格(円) Suggested retail price (¥)		
区分 Group	ブレーカ Breaker	ブレーカ断面形状 Breaker cross-section shape (mm)	切りくず処理領域 Chip removal region	商品コード (メートル系) Item Code (metric)	コーナ半径 RE Nose radius (mm)	コーティング Coating						希望小売価格(円) Suggested retail price (¥)						
						HGコーティング HG Coating	IPコーティング IP Coating	GMコーティング GM Coating	PCコーティング PC Coating	コーティングサーメット Coating cermet	非コーティング Non coating							
仕上げ切削 For finishing				TNMG160404-FE	0.4	●	●									1,010		
				TNMG160408-FE	0.8	●	●											1,010
				TNMG160404-BE	0.4													
仕上げ切削 For finishing				TNMG160408-BE	0.8											1,010		
				TNMG160404-BH	0.4	●	●											1,010
				TNMG160408-BH	0.8	●	●											1,010
仕上げ切削 For semi finishing				TNMG160412-BH	1.2	●	●									1,010		
				TNMG160404-AB	0.4	●	●											1,010
				TNMG160408-AB	0.8	●	●											1,010
仕上げ切削 For semi finishing				TNMG160412-AB	1.2	●	●									1,010		

無印: 弊社営業へお問合せください。 — 印: 製作致しません。
No mark: Contact with our sales department. —: Not manufactured.

Turning Inserts

被削材 Work material		●: 一般切削・第一推奨 General cutting, First recommended		○: 一般切削・第二推奨 General cutting, Second recommended		P 鋼 Carbon steels	M SUS等 SUS, etc.	K FC・FCD Cast irons	N アルミニウム合金 Aluminum alloys	S チタン合金 Titanium alloys	H 高硬度材 Hardened steels	コーティング Coating											希望小売価格(円) Suggested retail price(¥)	
区分 Group	ブレーカ Breaker	ブレーカ断面形状 Breaker cross-section shape (mm)	切りくず処理領域 Chip removal region	商品コード (メートル系) Item Code (metric)	コーナ 半径 RE Nose radius (mm)	HGコーティング HG8010	IPコーティング HG8025	GMコーティング IP2000	IPコーティング IP3000	GMコーティング GM25	IPコーティング IP050S	IPコーティング HX3505	IPコーティング HX3515	PCコーティング CZ25	コーティング CH550	コーティング EX35	コーティング WH10	希望小売価格(円) Coating	希望小売価格(円) Non coating					
中切削 For medium cutting	V			TNMG160404-V	0.4	●					●	●	●					1,010	—					
				TNMG160408-V	0.8	●						●	●	●					1,010	900				
				TNMG160412-V	1.2	●							●	●	●					1,010	—			
				TNMG160416-V	1.6	●							●	●	●					1,010	—			
				TNMG160420-V	2	●							●	●	●					1,010	—			
				TNMG220408-V	0.8	●						●	●	●	●						1,550	—		
中切削 For medium cutting	VA			TNMG160404-VA	0.4	●												1,010	—					
				TNMG160408-VA	0.8	●													1,010	—				
				TNMG160412-VA	1.2	●													1,010	—				
重切削 For heavy-duty cutting	HX			TNMM270616-HX	1.6				●	●								2,350	—					
中切削 For medium cutting	研ぎ付け Handed ground type		汎用 General	TNMG160404L-N	0.4													—	900					
				TNMG160404R-N	0.4														—	900				
				TNMG160408L-N	0.8															—	900			
				TNMG160408R-N	0.8															—	900			
				TNGG160404L-N	0.4															—	1,110			
				TNGG160404R-N	0.4												●			●	1,440	1,110		
汎用切削 For general cutting	無し Non Breaker		—	TNMA160408	0.8	●	●											1,270	—					
				TNMA160412	1.2	●	●												1,270	—				
仕上切削 For finishing	研ぎ付け Handed ground type			TPGH110202L	0.2													—	1,200					
汎用切削 For general cutting	無し Non Breaker		—	TPGB110202	0.2													●	—	1,010				
				TPGB110204	0.4															●	—	1,010		
仕上切削 For finishing	MP			TCMT16T308-MP	0.8													—	1,420					
				TPMT080204-MP	0.4							●							—	830				
				TPMT090204-MP	0.4							●								—	870			
				TPMT110302-MP	0.2							△								—	870			
	JQ			TPMT110304-MP	0.4						●								—	870				
				TPMT110308-MP	0.8							●							—	870				
				TPMT090204-JQ	0.4	●	●	△												—	870			
				TPMT110304-JQ	0.4	●	●	△												—	870			
仕上切削 For finishing	無し Non Breaker		—	TPMT110308-JQ	0.8	●	●	△										—	870					
				TPMT160304-JQ	0.4	●	●													—	1,200			
仕上切削 For finishing	無し Non Breaker		—	TPMT160308-JQ	0.8	●	●											—	1,200					

無印: 弊社営業へお問合せください。 一印: 製作致しません。
No mark: Contact with our sales department. - : Not manufactured.

60° 三角形インサート

被削材 Work material		●: 一般切削・第一推奨 General cutting, First recommended		◎: 一般切削・第二推奨 General cutting, Second recommended		P 鋼 Carbon steels	M SUS等 SUS, etc.	K FC・FCD Cast irons	N アルミニウム合金 Aluminum alloys	S チタン合金 Titanium alloys	H 高硬度材 Hardened steels	コーティング Coating										希望小売価格(円) Suggested retail price(¥)			
区分 Group	ブレーカ Breaker	ブレーカ断面形状 Breaker cross-section shape (mm)	切りくず処理領域 Chip removal region	商品コード (メートル系) Item Code (metric)	コーナ 半径 RE Nose radius (mm)	コーティング Coating										希望小売価格(円) Suggested retail price(¥)									
						HGコーティング	IPコーティング	GMコーティング	CYコーティング	PCコーティング	CH550	EX35	WH10	コーティング Coating	非コーティング Non coating										
中 切 削 For medium cutting				TCMT110204-JE	0.4	●	●	△	●			●								870	—				
				TCMT110208-JE	0.8	△	●	△	●													870	—		
				TCMT16T304-JE	0.4	△	●	●	●						●								1,420	—	
				TCMT16T308-JE	0.8	●	●	●	●														1,420	—	
				TPMT090204-JE	0.4	△	●	△	●						△								870	—	
				TPMT110302-JE	0.2										●								870	—	
				TPMT110304-JE	0.4	●	●	△	●						●								870	—	
				TPMT110308-JE	0.8	●	●	△	●														870	—	
				TPMT160304-JE	0.4	●	●	△	●						●								1,200	—	
				TPMT160308-JE	0.8	●	●	●	●							△							1,200	—	
汎 用 切 削 For general cutting				TPMR110308-JE	0.8				●											750	—				
				TPMR160304-JE	0.4				●				●									1,050	—		
				TPMR160308-JE	0.8				●				●									1,050	—		
仕 上 切 削 For finishing			—	TPGR110304L	0.4													●	—	1,510	—				
				TPGR160304L	0.4															●	—	1,840	—		
汎 用 切 削 For general cutting			—	*TPMN160304	0.4													●	●	●	—	820			
				*TPMN160308	0.8															●	●	●	1,040	820	
				*TPMN220404	0.4																●	●	—	1,380	—
				*TPMN220408	0.8										●						●	●	●	1,790	1,380
				*TPMN220412	1.2										●						●	●	●	1,790	1,380
			—	*TPGN160308	0.8													●	—	—	1,630	—			

※: フライス用は C250 ページを参照ください。
For milling inserts, please refer p.C250.

●印: 標準在庫品です。 △印: 在庫が無くなり次第販売終了です。
●: Stocked Items. △: The sale ends when all the stock is out.

35° ひし形インサート

切削条件表 **G5**
Cutting Conditions

被削材 Work material		● : 一般切削・第一推奨 General cutting, First recommended		◎ : 一般切削・第二推奨 General cutting, Second recommended		P 鋼 Carbon steels		M SUS等 SUS, etc.		K FC・FCD Cast irons		N アルミニウム合金 Aluminum alloys		S チタン合金 Titanium alloys		H 高硬度材 Hardened steels		コーティング Coating										希望小売価格 (円) Suggested retail price (¥)
区分 Group	ブレイカ Breaker	ブレイカ断面形状 Breaker cross-section shape (mm)	切りくず処理領域 Chip removal region	商品コード (メートル系) Item code (metric)	コーナ半径 RE Nose radius (mm)	コーティング Coating										PC セラミック Cermet	CH550 セラミック Cermet											
						HGコーティング IP GMコーティング GM25 GM8020 GM8035	IPコーティング IP2000 IP050S IP100S	GX GX30	HXコーティング HX3505 HX3515	HSコーティング HS9105 HS9115	AJコーティング JP9105 JP9115	PC セラミック Cermet	CH550 セラミック Cermet															
仕上切削 For finishing	FE 			VNMG160404-FE 0.4	●	●												●	●	1,530								
				VNMG160408-FE 0.8	●	●																1,530						
	BE 			VNMG160404-BE 0.4			●	●													1,530							
				VNMG160408-BE 0.8			●																1,530					
				VNMG160412-BE 1.2																			—					
	BH 			VNMG160404-BH 0.4	●	●	●														1,530							
VNMG160408-BH 0.8				●	●	●																1,530						
中切削 For semi finishing	AB 			VNMG160404-AB 0.4	●	●	●	●												1,530								
				VNMG160408-AB 0.8	●	●	●	●	●													1,530						
仕上切削 For finishing	CE 			VNMG160404-CE 0.4														●		1,530								
				VNMG160408-CE 0.8																●		1,530						
仕上切削 For finishing	MP 			VNMG160404-MP 0.4	—	—	—	—	—	●	—	—	—	—	—	—	—	—	—	1,530								
				VNMG160408-MP 0.8	—	—	—	—	—	△	—	—	—	—	—	—	—	—	—	—	—	1,530						
中切削 For medium cutting	PV 			VNMG160404-PV 0.4						—	●									1,530								
				VNMG160408-PV 0.8								—	●									1,530						
仕上中切削 For finishing, medium cutting	VI 			VI-VNMG160404 0.4						—				●	●	●	●			2,290								
				VI-VNMG160408 0.8								—				●	●	●	●			2,290						
中切削 For medium cutting	V 			VNMG160404-V 0.4	●		●			—	●									1,530								
				VNMG160408-V 0.8	●		●				—	●	●	●						●		1,530						
				VNMG160412-V 1.2	●		●					—	●	●								1,530						
仕上中切削 For finishing, medium cutting	VA 			VNMG160404-VA 0.4	●					—				●						1,530								
				VNMG160408-VA 0.8	●							—				●						1,530						
				VNMG160412-VA 1.2	●								—										1,530					
仕上切削 For finishing	MP 			VBMT110304-MP 0.4	—	—	—	—	—	●	—	—	—	—	—	—	—	—	—	1,890								
				VBMT160404-MP 0.4	—	—	—	—	—	●	—	—	—	—	—	—	—	—	—	—	—	2,720						
				VBMT160408-MP 0.8	—	—	—	—	—	●	—	—	—	—	—	—	—	—	—	—	—	2,720						
				VCMT110302-MP 0.2	—	—	—	—	—	●	—	—	—	—	—	—	—	—	—	—	—	1,890						
				VCMT110308-MP 0.8	—	—	—	—	—	△	—	—	—	—	—	—	—	—	—	—	—	—	1,890					

無印：弊社営業へお問合せください。 一印：製作致しません。
No mark : Contact with our sales department. — : Not manufactured.

Turning Inserts

35° ひし形インサート

被削材 Work material	●: 一般切削・第一推奨 General cutting, First recommended ◎: 一般切削・第二推奨 General cutting, Second recommended	P	鋼	Carbon steels	●	●	●	●	●	●	●	●	●	●	●	●	●	●	●	●				
		M	SUS等	SUS, etc.	○	○	○	○	○	○	○	○	○	○	○	○	○	○	○	○				
		K	FC・FCD	Cast irons	○	○	○	○	○	○	○	○	○	○	○	○	○	○	○	○				
		N	アルミニウム合金	Aluminum alloys																				
		S	チタン合金	Titanium alloys																				
		H	高硬度材	Hardened steels																				
区分 Group	ブレーカ Breaker	ブレーカ断面形状 Breaker cross-section shape (mm)	切りくず処理領域 Chip removal region	商品コード (メートル系) Item code (metric)	コーナ半径 RE Nose radius (mm)	コーティング Coating						希望小売価格(円) Suggested retail price (¥)												
						HGコーティング	IPコーティング	GMコーティング	PCコーティング	コーティングサーメット Coating cermet														
仕上切削 For finishing	JQ			VBMT110304-JQ	0.4	●	●	△	●													1,890		
				VBMT110308-JQ	0.8	●	●																	1,890
				VBMT160404-JQ	0.4	●	●	●	●															2,720
				VBMT160408-JQ	0.8	●	●	●	●															2,720
				VCMT160404-JE	0.4	●	●		●				●											
中切削 For medium cutting	JE			VCMT160408-JE	0.8	●	●		●													2,720		
				VBMT110304-JE	0.4	●	●	△	●														1,890	
				VBMT160404-JE	0.4	●	●	●	●															2,720
				VBMT160408-JE	0.8	●	●	△	●															2,720
										●	●													

Trigon 80° Inserts

80° 六角形インサート

被削材 Work material	●: 一般切削・第一推奨 General cutting, First recommended ◎: 一般切削・第二推奨 General cutting, Second recommended	P	鋼	Carbon steels	●	●	●	●	●	●	●	●	●	●	●	●	●	●	●	●						
		M	SUS等	SUS, etc.	○	○	○	○	○	○	○	○	○	○	○	○	○	○	○	○						
		K	FC・FCD	Cast irons	○	○	○	○	○	○	○	○	○	○	○	○	○	○	○	○						
		N	アルミニウム合金	Aluminum alloys																						
		S	チタン合金	Titanium alloys																						
		H	高硬度材	Hardened steels																						
区分 Group	ブレーカ Breaker	ブレーカ断面形状 Breaker cross-section shape (mm)	切りくず処理領域 Chip removal region	商品コード (メートル系) Item Code (metric)	コーナ半径 RE Nose radius (mm)	コーティング Coating						希望小売価格(円) Suggested retail price (¥)														
						HGコーティング	IPコーティング	GMコーティング	GM8020	GM8035																
仕上切削 For finishing	FE			WNMG080404-FE	0.4	●	●															1,010				
				WNMG080408-FE	0.8	●	●																	1,010		
				WNMG080408-BE	0.8					●	●														1,010	
				WNMG080404-BH	0.4	●	●	●																	1,010	
				WNMG080408-BH	0.8	●	●	●																	1,010	
				WNMG080412-BH	1.2	●	●	●																		1,010
軽切削 For semi finishing	AB			WNMG080404-AB	0.4	●	●	●														1,010				
				WNMG080408-AB	0.8	●	●	●	●		●													1,010		
				WNMG080412-AB	1.2	●	●	●	●		●														1,010	
				WNMG080408-CT	0.8	●	●																		1,010	
				WNMG080412-CT	1.2	●	●																			1,010

●印: 標準在庫品です。 ◎印: 在庫が無くなり次第販売終了です。
●: Stocked Items. ◎: The sale ends when all the stock is out.

80° 六角形インサート

区分 Group	ブレイカ Breaker	ブレイカ断面形状 Breaker cross-section shape (mm)	切りくず処理領域 Chip removal region	商品コード (メートル系) Item Code (metric)	コーナ半径 RE Nose radius (mm)	コーティング Coating						希望小売価格(円) Suggested retail price (¥)				
						HGコーティング	IPコーティング	GMコーティング	HXコーティング	IP2000	GM25		GM8020	HX3505	HX3515	
中切削 For medium cutting	V			WNMG080404-V	0.4	●	●	●	●					1,010		
				WNMG080408-V	0.8	●		●	●						1,010	
				WNMG080412-V	1.2	●			●	●					1,010	
	VA			WNMG080404-VA	0.4	●						●		1,010		
				WNMG080408-VA	0.8	●							●		1,010	
				WNMG080412-VA	1.2	●								●		1,010
中切削 For medium cutting	JQ			WPMT040202-JQ	0.2	●	△							960		
				WPMT040204-JQ	0.4	●	△								960	
				WPMT060304-JQ	0.4	●	△									1,180
				WPMT060308-JQ	0.8	●				●						1,180

Round Inserts

円形インサート

区分 Group	ブレイカ Breaker	ブレイカ断面形状 Breaker cross-section shape (mm)	切りくず処理領域 Chip removal region	商品コード (メートル系) Item Code (metric)	コーナ半径 RE Nose radius (mm)	コーティング Coating				ノンコーティング Non coating		希望小売価格(円) Suggested retail price (¥)			
						HGコーティング	GMコーティング	HSコーティング	サーメット Cermet	CH550					
汎用切削 For general cutting				RNMG120400	-			●					1,650		
仕上げ切削 For finishing, medium cutting	VI		-	VI-RCMM1204M0	-			●	●				1,880		
				VI-RCMM1606M0	-			●	●					3,240	
高送り切削 For high-feed cutting	RG			RCMM1204M0-RG	-					●			960		
				RPMT1203M0-RG	-						●			820	
				RPMT1604M0-RG	-								●		1,440
				RPMT2004M0-RG	-									●	
	全周 Conventional			RCMM1003M0	-	●	●	●						890	
				RCMM1204M0	-	●	●	●							1,260
				RCMM1606M0	-		●								
AN			RCMM2006M0	-			●						2,890		
			RCMM1003M0-AN	-	●	●								890	
			RCMM1204M0-AN	-	△	●									1,260
				RCMM1606M0-AN	-	△							2,160		

●印：標準在庫品です。 △印：在庫が無くなり次第販売終了です。 無印：弊社営業へお問合せください。 -印：製作致しません。
 ● : Stocked Items. △ : The sale ends when all the stock is out. No mark : Contact with our sales department. - : Not manufactured.

ハイスエンドミル

HSS End Mills



ハイスエンドミル選定目安表H2
Selection criteria table for HSS end mills

外径別寸法早見表
Quick dimension reference table by mill diameter

ボール.....H6
Ball
面取り.....H6
Chamfering
スクエア.....H7
Square

種類別(カタログ掲載順) By type (catalog listing order)

ボールエンドミル Ball End Mills

2ESMBC.....H18
2ESMB.....H18

スクエアエンドミル Square End Mills

2NE□-AT.....H21
2ESM□C.....H23
2ESMSUSC.....H25
2ESM□.....H26
2ESMSUS.....H28
2NK□.....H30
1AL.....H37
2AL.....H37
4NER-AT.....H40
4ESM□C.....H41
4ESM□.....H42
4NKRC.....H43
4NKLC.....H45
HK□-AT.....H46
ESMHK□.....H48

ESMHN.....H50
RQ□-AT.....H52
ESMQ□□.....H55
FQ□-AT.....H58
RFR-AT.....H60
RF□.....H62
HQ□□.....H63

その他のエンドミル Other End Mills

CM.....H66
CE.....H66

特定代理店在庫品 Stocked by specified distributor

ESMLB.....H68
ESMDB.....H68
NB.....H68
GNB.....H68
4ESMB.....H68
ALB.....H68
2GNK□.....H69
2NKX.....H69
4GNKR.....H70
3NKR.....H70
4NKRE.....H70
4NKLE.....H70
4NKX.....H71
LS.....H71
GFQ□.....H71
FQL-AT.....H72
GRFR.....H72
GCQS.....H72
GRQR.....H73
GQR.....H73

Q□.....H73
LQ.....H73
QL.....H74
DSQ.....H74
QB.....H74
QRT.....H74
SRQ.....H75
ESMK□□.....H75
DSH.....H75
HN.....H75
2ESMT□.....H76
4ESMT□.....H77
2ESMTB□.....H79
DSP.....H80
SRP.....H80
SRH.....H80
HE.....H80

商品コード別(アルファベット順) By item code (alphabetical order)

1AL.....H37
2AL.....H37
2ESM□.....H26
2ESM□C.....H23
2ESMB.....H18
2ESMBC.....H18
2ESMSUS.....H28
2ESMSUSC.....H25
2ESMT□.....H76
2ESMTB□.....H79
2GNK□.....H69
2NE□-AT.....H21
2NK□.....H30
2NKX.....H69
3NKR.....H70
4ESM□.....H42
4ESM□C.....H41

4ESMB.....H68
4ESMT□.....H77
4GNKR.....H70
4NER-AT.....H40
4NKLC.....H45
4NKLE.....H70
4NKRC.....H43
4NKRE.....H70
4NKX.....H71
ALB.....H68
CE.....H66
CM.....H66
DSH.....H75
DSP.....H80
DSQ.....H74
ESMDB.....H68
ESMHK□.....H48

ESMHN.....H50
ESMK□□.....H75
ESMLB.....H68
ESMQ□□.....H55
FQ□-AT.....H58
FQL-AT.....H72
GCQS.....H72
GFQ□.....H71
GNB.....H68
GQR.....H73
GRFR.....H72
GRQR.....H73
HE.....H80
HK□-AT.....H46
HN.....H75
HQ□□.....H63
LQ.....H73





















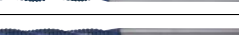





LS.....H71
NB.....H68
Q□.....H73
QB.....H74
QL.....H74
QRT.....H74
RF□.....H62
RFR-AT.....H60
RQ□-AT.....H52
SRH.....H80
SRP.....H80
SRQ.....H75

Selection criteria table for HSS end mills

ハイスエンドミル選定目安表





















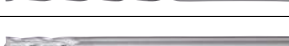

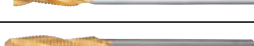

名称 Name	商品コード Item Code	外径 Tool Dia.	形状 Shape	コーティング Coating	被削材 Work material										掲載頁 Page	
					炭素鋼・合金鋼 Carbon steels, Alloy steels	プリハードン鋼 Pre-hardened Steels	高硬度45HRC以下 High-hardened over 45HRC to under 55HRC	高硬度55HRC以下 High-hardened over 55HRC to under 65HRC	高硬度65HRC以上 High-hardened over 65HRC	ステンレス鋼 Stainless steels	チタン合金・耐熱合金 Titanium alloy, Heat-resistant alloy	銅合金 Copper alloy	アルミ合金 Aluminum alloy	寸法表 Size list	切削条件 Cutting conditions	
ハイス エンドミル 「ボール」 HSS end mill (Ball)	2ESMBC	1.0~30		C	○	○					○	○		○	H18	H19
	2ESMB	1.0~30		AT	○						○	○		○	H18	H20
ハイスエンドミル 「スクエア」 HSS end mill (Square)	2NES-AT	1.0~20			○	○					○	○		○	H21	H22
	2NER-AT	1.0~50		AT	○	○					○	○		○	H21	H22
	2ESMSC	1.0~30		C	○	○					○	○		○	H23	H24
	2ESMRC	1.0~30		C	○	○					○	○		○	H23	H24
	2ESMLC	3.0~30		C	○	○					○	○		○	H23	H24
	2ESMSUSC	3.0~20		C	○	○					○	○		○	H25	H25
	2ESMS	0.8~30			○						○	○		○	H26	H29
	2ESMR	1.0~40			○						○	○		○	H27	H29
	2ESML	30~40			○						○	○		○	H28	H29
	2ESMSUS	1.5~30			○						○	○		○	H28	
	2NKS	0.8~20			○						○	○		○	H30	H35
	2NKR	2.0~60			○						○	○		○	H32	H35
	2NKL	1.0~51			○						○	○		○	H33	H36
	1AL	4.0~10											○	○	H37	
	2AL	3.0~30											○	○	H37	H39
	4NER-AT	2.5~30		AT	○	○					○	○		○	H40	H22
	4ESMRC	2.5~30		C	○	○					○	○		○	H41	H24
	4ESMLC	3.0~30		C	○	○					○	○		○	H41	H24
	4ESMR	2.5~40			○						○	○		○	H42	H29
	4ESML	3.0~40			○						○	○		○	H42	H29
	4NKRC	2.0~40			○						○	○		○	H43	
	4NKLC	2.5~40			○						○	○		○	H45	
	HKR-AT	6.0~30		AT	○	○					○	○		○	H46	H47
HKM-AT	12.~30		AT	○	○					○	○		○	H46	H47	
HKL-AT	12.~30		AT	○	○					○	○		○	H46	H47	

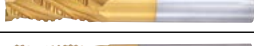
ハイスエンドミル選定目安表

名称 Name	商品コード Item Code	外径 Tool Dia.	形状 Shape	コーティング Coating	被削材 Work material										掲載頁 Page				
					炭素鋼・合金鋼 Carbon steels, Alloy steels	プリハードン鋼 45以下 Pre-hardened Steels under 45 HRC	高硬度45HRC以上55HRC以下 High-hardened over 45HRC to under 55HRC	高硬度55HRC以上65HRC以下 High-hardened over 55HRC to under 65HRC	高硬度65HRC以上 High-hardened over 65HRC	ステンレス鋼 Stainless steels	チタン合金・耐熱合金 Titanium alloy, Heat-resistant alloy	銅合金 Copper alloy	アルミニウム合金 Aluminum alloy	寸法表 Size list	切削条件 Cutting conditions				
ハイスエンドミル 【スクエア】 HSS end mill (Square)	HKN-AT	6.0~30		AT	○	○					○	○						H46	H47
	ESMHKR	6.0~30		C	○	○					○	○						H48	H49
	ESMHKM	12.~30		C	○	○					○	○						H48	H49
	ESMHKL	12.~30		C	○	○					○	○						H48	H49
	ESMHN	6.0~30			○						○	○						H50	H51
	RQS-AT	6.0~50		AT	◎	◎					◎	◎						H52	H53
	RQR-AT	6.0~50		AT	◎	◎					◎	◎						H52	H53
	RQL-AT	10.~50		AT	◎	◎					◎	◎						H52	H53
	ESMQS	6.0~50		C	○	○					○	○						H55	H57
	ESMQR	6.0~30		C	○	○					○	○						H55	H57
	ESMQL	10.~50		C	○	○					○	○						H56	H57
	ESMQLS	12.~50		C	○	○					○	○						H56	H57
	FQS-AT	6.0~35		AT	○	○					○	○						H58	H59
	FQR-AT	6.0~35		AT	○	○					○	○						H58	H59
	RFR-AT	6.0~30		AT	○	○					○	○						H60	H61
	RFR	6.0~50			○						○	○						H62	
	RFL	6.0~50			○						○	○						H62	
	HQS	6.0~50			○						○	○						H63	H65
	HQR	6.0~50			○						○	○						H63	H65
	HQL	10.~50			○						○	○						H64	H65
	HQXL	20.~50			○						○	○						H64	H65
	HQLS	12.~50			○						○	○						H64	H65
	CM	4.0~50			○						○	○						H66	H67
	CE	4.0~60			○						○	○						H66	
ハイス エンドミル 【特定代理店在庫品】 HSS end mill (Stocked by Specified distributor)	ESMLB	1.0~10			○					○	○						H68		
	ESMDB	3.0~40			○					○	○						H68		
	NB	2.0~30			○						○	○					H68		

















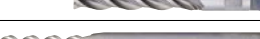

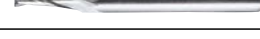
Selection criteria table for HSS end mills

ハイスエンドミル選定目安表

名称 Name	商品コード Item Code	外径 Tool Dia.	形状 Shape	コーティング Coating	被削材 Work material										掲載頁 Page	
					炭素鋼・合金鋼 Carbon steels, Alloy steels	プリハードン鋼 Pre-hardened Steels under 45HRC	高硬度鋼 High-hardened over 45HRC to under 55HRC	高硬度鋼 High-hardened over 55HRC to under 65HRC	高硬度鋼 High-hardened over 65HRC	ステンレス鋼 Stainless steels	チタン合金・熱 resistant 合金 Titanium alloy, Heat-resistant alloy	銅合金 Copper alloy	アルミ合金 Aluminum alloy	寸法表 Size list	切削条件 Cutting conditions	
GNB	2.0~30		G	○						○	○		○	H68		
4ESMB	6.0~50			○						○	○		○	H68		
ALB	4.0~30												◎	H68	H81	
2GNKS	1.0~20		G	○						○	○		○	H69	H82	
2GNKR	2.0~50		G	○						○	○		○	H69	H82	
2NKX	3.0~60			○						○	○		○	H69		
4GNKR	2.5~50		G	○						○	○		○	H70		
3NKR	3.0~30			○						○	○		○	H70		
4NKRE	31.~50			○						○	○		○	H70		
4NKLE	3.0~50			○						○	○		○	H70		
4NKX	3.0~60			○						○	○		○	H71		
LS	6.0~50			○						○	○		○	H71		
GFQS	6.0~50		G	○						○	○		○	H71	H83	
GFQR	6.0~50		G	○						○	○		○	H72		
GFQL	10.~50		G	○						○	○		○	H72		
FQL-AT	10.~35		AT	○	○					○	○		○	H72	H59	
GRFR	6.0~50		G	○						○	○		○	H72	H84	
GCQS	6.0~50		G	○						○	○		○	H72	H85	
GRQR	6.0~50		G	○						○	○		○	H73	H85	
GQR	6.0~50		G	○						○	○		○	H73	H85	
QS	20.~50			○						○	○		○	H73		
QR	6.0~60			○						○	○		○	H73		
LQ	6.0~50			○						○	○		○	H73		
QL	6.0~60			○						○	○		○	H74		
DSQ	30.~100			○						○	○		○	H74		
QB	6.0~50			○						○	○		○	H74		

HSS end mill (Stocked by Specified distributor)
 【特定代理店在庫品】
 ハイスエンドミル

ハイスエンドミル
 ハイスエンドミル選定目安表

名称 Name	商品コード Item Code	外径 Tool Dia.	形状 Shape	コーティング Coating	被削材 Work material										掲載頁 Page	
					炭素鋼・合金鋼 Carbon steels, Alloy steels	プリハートン鋼 Pre-harden Steels under 45 HRC	高硬度45HRC超え High-hardened over 45HRC	高硬度55HRC超え High-hardened over 55HRC	高硬度65HRC超え High-hardened over 65HRC	高硬度75HRC超え High-hardened over 75HRC	ステンレス鋼 Stainless steels	チタン合金・熱 resistant alloy Titanium alloy, Heat-resistant alloy	銅合金 Copper alloy	アルミ合金 Aluminum alloy	寸法表 Size list	切削条件 Cutting conditions
HSS end mill (Stocked by Specified distributor) ハイスエンドミル [特定代理店在庫品]	QRT	20.~50			○						○	○		○	H74	
	SRQ	20.~30			○						○	○		○	H75	
	ESMKH	3.0~20			○						○	○		○	H75	
	ESMKN	3.0~20			○						○	○		○	H75	
	ESMKNN	3.0~20			○						○	○		○	H75	
	DSH	30~100			○						○	○		○	H75	
	HN	6.0~30			○						○	○		○	H75	
	2ESMTT	1.0~04			○						○	○		○	H76	
	2ESMTS	2.0~10			○						○	○		○	H76	H86
	4ESMTS	2.0~10			○						○	○		○	H77	H86
	2ESMTR	2.0~20			○						○	○		○	H78	H86
	4ESMTR	2.0~20			○						○	○		○	H78	H86
	2ESMTBS	2.0~10			○						○	○		○	H79	
	2ESMTBR	6.0~20			○						○	○		○	H80	
	DSP	30~100			○						○	○		○	H80	
	SRP	20.~30			○						○	○		○	H80	
	SRH	20.~30			○						○	○		○	H80	
	HE	20.~50			○						○	○		○	H80	

外径別寸法早見表

ハイスエンドミル・ボール

HSS End Mills -Ball

商品コード Item code	在庫 Stock	ボール 半径 R	外径 Tool dia.	刃長 Flute length	全長 Overall length	シャンク径 Shank dia.	ページ Page
ESMLB0.5R	□	0.5	1	1	60	6	H68
2ESMB0.5R	●	0.5	1	2.5	60	6	H18
2ESMBC0.5R	●	0.5	1	2.5	60	6	H18
ESMLB1R	□	1	2	2	70	6	H68
2ESMB1R	●	1	2	5	60	6	H18
2ESMBC1R	●	1	2	5	60	6	H18
GNB1R	□	1	2	5	73	6	H68
NB1R	●	1	2	5	73	6	H68
ESMLB1.5R	□	1.5	3	3	80	6	H68
ESMDB1.5R	□	1.5	3	6	100	8	H68
2ESMB1.5R	●	1.5	3	8	70	6	H18
2ESMBC1.5R	●	1.5	3	8	70	6	H18
GNB1.5R	□	1.5	3	8	75	6	H68
NB1.5R	●	1.5	3	8	75	6	H68
ESMLB2R	□	2	4	4	90	6	H68
ALB2R	□	2	4	8	70	6	H68
2ESMB2R	●	2	4	8	80	6	H18
2ESMBC2R	●	2	4	8	80	6	H18
ESMDB2R	□	2	4	8	120	10	H68
GNB2R	□	2	4	11	80	6	H68
NB2R	●	2	4	11	80	6	H68
ESMLB2.5R	□	2.5	5	5	100	6	H68
ALB2.5R	□	2.5	5	10	80	6	H68
2ESMB2.5R	●	2.5	5	10	90	6	H18
2ESMBC2.5R	●	2.5	5	10	90	6	H18
ESMDB2.5R	□	2.5	5	10	120	10	H68
GNB2.5R	□	2.5	5	13	80	6	H68
NB2.5R	●	2.5	5	13	80	6	H68
ESMLB3R	□	3	6	6	110	6	H68
ALB3R	□	3	6	12	85	6	H68
2ESMB3R	●	3	6	12	100	6	H18
2ESMBC3R	●	3	6	12	100	6	H18
ESMDB3R	□	3	6	12	130	12	H68
GNB3R	□	3	6	13	80	6	H68
NB3R	●	3	6	13	80	6	H68
QB3R	□	3	6	15	100	6	H74
4ESMB3R	□	3	6	15	100	6	H68
ESMLB3.5R	□	3.5	7	7	110	6	H68
ALB3.5R	□	3.5	7	14	85	6	H68
2ESMB3.5R	□	3.5	7	14	100	6	H18
2ESMBC3.5R	□	3.5	7	14	100	6	H18
ESMDB3.5R	□	3.5	7	14	150	12	H68
GNB3.5R	□	3.5	7	16	95	8	H68
NB3.5R	●	3.5	7	16	95	8	H68
4ESMB3.5R	□	3.5	7	20	100	6	H68
ESMLB4R	□	4	8	8	120	8	H68
ALB4R	□	4	8	14	95	8	H68
2ESMB4R	●	4	8	14	110	8	H18
2ESMBC4R	●	4	8	14	110	8	H18
ESMDB4R	□	4	8	16	150	12	H68
GNB4R	□	4	8	19	95	8	H68
NB4R	●	4	8	19	95	8	H68
QB4R	□	4	8	20	110	8	H74
4ESMB4R	□	4	8	20	110	8	H68
ESMLB4.5R	□	4.5	9	9	120	8	H68
ALB4.5R	□	4.5	9	18	100	8	H68
2ESMB4.5R	□	4.5	9	18	120	8	H18
2ESMBC4.5R	□	4.5	9	18	120	8	H18
GNB4.5R	□	4.5	9	19	105	10	H68
NB4.5R	●	4.5	9	19	105	10	H68
4ESMB4.5R	□	4.5	9	25	120	8	H68
ESMLB5R	□	5	10	10	140	10	H68
ALB5R	□	5	10	18	110	10	H68
2ESMB5R	●	5	10	18	125	10	H18
2ESMBC5R	●	5	10	18	125	10	H18
ESMDB5R	□	5	10	20	160	16	H68

商品コード Item code	在庫 Stock	ボール 半径 R	外径 Tool dia.	刃長 Flute length	全長 Overall length	シャンク径 Shank dia.	ページ Page
GNB5R	□	5	10	22	110	10	H68
NB5R	●	5	10	22	110	10	H68
QB5R	□	5	10	25	125	10	H74
4ESMB5R	□	5	10	25	125	10	H68
ALB5.5R	□	5.5	11	18	110	10	H68
2ESMB5.5R	□	5.5	11	18	125	10	H18
2ESMBC5.5R	□	5.5	11	18	125	10	H18
GNB5.5R	□	5.5	11	22	120	12	H68
NB5.5R	□	5.5	11	22	120	12	H68
4ESMB5.5R	□	5.5	11	30	125	10	H68
ALB6R	□	6	12	22	120	12	H68
2ESMB6R	●	6	12	22	140	12	H18
2ESMBC6R	●	6	12	22	140	12	H18
ESMDB6R	□	6	12	24	180	16	H68
GNB6R	□	6	12	26	120	12	H68
NB6R	●	6	12	26	120	12	H68
QB6R	□	6	12	30	140	12	H74
4ESMB6R	□	6	12	30	140	12	H68
ALB6.5R	□	6.5	13	22	120	12	H68
2ESMB6.5R	□	6.5	13	22	140	12	H18
2ESMBC6.5R	□	6.5	13	22	140	12	H18
GNB6.5R	□	6.5	13	26	135	16	H68
NB6.5R	●	6.5	13	26	135	16	H68
4ESMB6.5R	□	6.5	13	35	140	12	H68
ALB7R	□	7	14	26	120	12	H68
GNB7R	□	7	14	26	135	16	H68
NB7R	●	7	14	26	135	16	H68
2ESMB7R	□	7	14	26	140	12	H18
2ESMBC7R	□	7	14	26	140	12	H18
QB7R	□	7	14	35	140	12	H74
4ESMB7R	□	7	14	35	140	12	H68
ALB7.5R	□	7.5	15	26	120	12	H68
GNB7.5R	□	7.5	15	26	135	16	H68
NB7.5R	●	7.5	15	26	135	16	H68
2ESMB7.5R	□	7.5	15	26	140	12	H18
2ESMBC7.5R	□	7.5	15	26	140	12	H18
4ESMB7.5R	□	7.5	15	40	140	12	H68
QB7.5R	□	7.5	15	40	140	16	H74
ALB8R	□	8	16	30	150	16	H68
2ESMB8R	●	8	16	30	160	16	H18
2ESMBC8R	●	8	16	30	160	16	H18
ESMDB8R	□	8	16	30	220	20	H68
GNB8R	□	8	16	32	140	16	H68
NB8R	●	8	16	32	140	16	H68
QB8R	□	8	16	40	160	16	H74
4ESMB8R	□	8	16	40	160	16	H68
GNB9R	□	9	18	32	150	20	H68
NB9R	●	9	18	32	150	20	H68
ALB9R	□	9	18	34	150	16	H68
2ESMB9R	□	9	18	34	160	16	H18
2ESMBC9R	□	9	18	34	160	16	H18
QB9R	□	9	18	40	160	16	H74
4ESMB9R	□	9	18	40	160	16	H68
ESMDB10R	□	10	20	30	250	25	H68
GNB10R	□	10	20	38	160	20	H68
NB10R	●	10	20	38	160	20	H68
ALB10R	□	10	20	38	160	20	H68
2ESMB10R	●	10	20	38	180	20	H18
2ESMBC10R	●	10	20	38	180	20	H18
QB10R	□	10	20	45	180	20	H74
4ESMB10R	□	10	20	45	180	20	H68
4ESMB11R	□	11	22	45	180	20	H68
4ESMB12R	□	12	24	50	180	20	H68
ESMDB12.5R	□	12.5	25	35	300	32	H68
GNB12.5R	□	12.5	25	45	180	25	H68
NB12.5R	●	12.5	25	45	180	25	H68

商品コード Item code	在庫 Stock	ボール 半径 R	外径 Tool dia.	刃長 Flute length	全長 Overall length	シャンク径 Shank dia.	ページ Page
ALB12.5R	□	12.5	25	50	180	25	H68
QB12.5R	□	12.5	25	50	200	25	H74
2ESMB12.5R	□	12.5	25	50	200	25	H18
2ESMBC12.5R	□	12.5	25	50	200	25	H18
4ESMB12.5R	□	12.5	25	50	200	25	H68
4ESMB13R	□	13	26	50	200	25	H68
4ESMB14R	□	14	28	55	200	25	H68
ESMDB15R	□	15	30	40	300	32	H68
GNB15R	□	15	30	45	180	25	H68
NB15R	●	15	30	45	180	25	H68
ALB15R	□	15	30	55	180	25	H68
QB15R	□	15	30	55	200	25	H74
2ESMB15R	□	15	30	55	200	25	H18
2ESMBC15R	□	15	30	55	200	25	H18
4ESMB15R	□	15	30	55	200	25	H68
ESMDB16R	□	16	32	40	350	32	H68
QB16R	□	16	32	60	200	32	H74
4ESMB16R	□	16	32	60	200	32	H68
QB17.5R	□	17.5	35	60	200	32	H74
4ESMB18R	□	18	36	60	220	32	H68
4ESMB19R	□	19	38	65	220	32	H68
ESMDB20R	□	20	40	45	400	42	H68
QB20R	□	20	40	65	220	32	H74
4ESMB20R	□	20	40	65	220	32	H68
QB22.5R	□	22.5	45	70	220	42	H74
4ESMB22.5R	□	22.5	45	70	220	42	H68
QB25R	□	25	50	70	240	42	H74
4ESMB25R	□	25	50	70	240	42	H68

ハイスエンドミル・面取り

HSS End Mills -Chamfering

商品コード Item code	在庫 Stock	外径 Tool dia.	加工径 Chamfer dia.	刃長 Flute length	全長 Overall length	シャンク径 Shank dia.	ページ Page
CM4	●	4	-	11	75	8	H66
CE4	●	4	2~3	-	50	4	H66
CM6	●	6	-	13	85	10	H66
CE6	●	6	3~5	-	50	6	H66
CM8	●	8	-	19	105	12	H66
CM10	●	10	-	22	120	16	H66
CE10	●	10	5~9	-	55	8	H66
CM12	●	12	-	26	125	16	H66
CE15	●	15	7~14	-	70	10	H66
CM16	●	16	-	32	145	20	H66
CM20	●	20	-	38	165	25	H66
CE20	●	20	10~19	-	100	12	H66
CM25	●	25	-	45	170	32	H66
CM30	□	30	-	50	180	32	H66
CE30	●	30	15~29	-	120	12	H66
CM35	□	35	-	55	180	32	H66
CM40	□	40	-	60	200	42	H66
CE40	●	40	20~39	-	170	MT3	H66
CM45	□	45	-	65	200	42	H66
CM50	□	50	-	65	200	42	H66
CE50	●	50	22~49	-	180	MT3	H66
CE60	●	60	25~59	-	195	MT3	H66

ハイスエンドミル・スクエア

HSS End Mills -Square

商品コード Item code	在庫 Stock	外径 Tool da.	刃長 Flute length	全長 Overall length	シャンク径 Shank dia.	ページ Page
2NKS0.8	●	0.8	1.6	55	6	H30
2ESMS0.8	□	0.8	2	50	6	H26
2NKS0.9	●	0.9	2	55	6	H30
2ESMS0.9	□	0.9	2.2	50	6	H26
2ESMSC1	●	1	2.5	50	6	H23
2ESMS1	●	1	2.5	50	6	H26
2NES1-AT	●	1	2.5	55	6	H21
2GNKS1	□	1	2.5	55	6	H69
2NKS1	●	1	2.5	55	6	H30
2NER1-AT	●	1	3.5	55	6	H21
2ESMRC1	●	1	3.5	55	6	H23
2ESMR1	●	1	3.5	55	6	H27
2NKL1X5	□	1	5	50	6	H33
2NKL1X6	□	1	6	50	6	H33
2NKL1X7.5	□	1	7.5	50	6	H33
2NKS1.05	□	1.05	3	55	6	H30
2ESMS1.1	□	1.1	2.5	50	6	H26
2NKS1.1	●	1.1	2.5	55	6	H30
2NKL1.1	□	1.1	7.5	50	6	H33
2NKS1.15	□	1.15	3	55	6	H30
2ESMS1.2	□	1.2	3	50	6	H26
2NKS1.2	●	1.2	3	55	6	H30
2NKL1.2	□	1.2	7.5	50	6	H33
2NKS1.25	□	1.25	3	55	6	H30
2ESMS1.3	□	1.3	3	50	6	H26
2NKS1.3	●	1.3	3	55	6	H30
2NKL1.3	□	1.3	7.5	50	6	H33
2NKS1.35	□	1.35	3	55	6	H30
2ESMS1.4	□	1.4	3	50	6	H26
2NKS1.4	●	1.4	3	55	6	H30
2NKL1.4	□	1.4	7.5	50	6	H33
2NKS1.45	□	1.45	3	55	6	H30
2ESMSC1.5	●	1.5	3.5	50	6	H23
2ESMS1.5	●	1.5	3.5	50	6	H26
2NES1.5-AT	●	1.5	3.5	55	6	H21
2GNKS1.5	□	1.5	3.5	55	6	H69
2NKS1.5	●	1.5	3.5	55	6	H30
2ESMSUS1.5	●	1.5	4	50	6	H28
2NER1.5-AT	●	1.5	5	55	6	H21
2ESMRC1.5	●	1.5	5	55	6	H23
2ESMR1.5	●	1.5	5	55	6	H27
2NKL1.5	□	1.5	7.5	50	6	H33
2NKL1.5X10	□	1.5	10	60	6	H33
2NKS1.55	□	1.55	4	55	6	H30
2ESMS1.6	□	1.6	3.5	50	6	H26
2NKS1.6	●	1.6	3.5	55	6	H30
2NKL1.6	□	1.6	10	60	6	H33
2NKS1.65	□	1.65	4	55	6	H30
2ESMS1.7	□	1.7	3.5	50	6	H26
2NKS1.7	●	1.7	3.5	55	6	H30
2NKL1.7	□	1.7	10	60	6	H33
2NKS1.75	□	1.75	4	55	6	H30
2ESMS1.8	□	1.8	3.5	50	6	H26
2NKS1.8	●	1.8	3.5	55	6	H30
2NKL1.8	□	1.8	10	60	6	H33
2NKS1.85	□	1.85	4	55	6	H30
2NKS1.9	●	1.9	3.5	55	6	H30
2ESMS1.9	□	1.9	4	50	6	H26
2NKL1.9	□	1.9	10	60	6	H33
2NKS1.95	□	1.95	4	55	6	H30
2ESMSC2	●	2	4	50	6	H23
2ESMS2	●	2	4	50	6	H26
2ESMSUS2	●	2	4	50	6	H28
2NES2-AT	●	2	4	55	6	H21
2GNKS2	□	2	4	55	6	H69
2NKS2	●	2	4	55	6	H30
2NER2-AT	●	2	5	55	6	H21
2ESMRC2	●	2	5	55	6	H23
2ESMR2	●	2	5	55	6	H27
2GNKR2	□	2	5	55	6	H69
2NKR2	●	2	5	55	6	H32
4NKRC2	□	2	7	55	6	H43

商品コード Item code	在庫 Stock	外径 Tool da.	刃長 Flute length	全長 Overall length	シャンク径 Shank dia.	ページ Page
2NKL2X10	□	2	10	60	6	H33
2NKL2X12	□	2	12	60	6	H33
2NKL2X15	□	2	15	60	6	H33
2NKS2.05	□	2.05	6	60	6	H30
2ESMS2.1	□	2.1	5	50	6	H26
2NKS2.1	●	2.1	5	55	6	H30
4NKRC2.1	□	2.1	7	55	6	H43
2NKL2.1	□	2.1	15	60	6	H33
2NKS2.15	□	2.15	6	60	6	H30
2ESMS2.2	□	2.2	5	50	6	H26
2NKS2.2	□	2.2	5	55	6	H30
4NKRC2.2	□	2.2	7	55	6	H43
2NKL2.2	□	2.2	15	60	6	H33
2NKS2.25	□	2.25	6	60	6	H30
2ESMS2.3	□	2.3	5	50	6	H26
2NKS2.3	●	2.3	5	55	6	H30
4NKRC2.3	□	2.3	7	55	6	H43
2NKL2.3	□	2.3	15	60	6	H33
2NKS2.35	□	2.35	6	60	6	H30
2ESMS2.4	□	2.4	5	50	6	H26
2NKS2.4	●	2.4	5	55	6	H30
4NKRC2.4	□	2.4	7	55	6	H43
2NKL2.4	□	2.4	15	60	6	H33
2NKS2.45	□	2.45	6	60	6	H30
2ESMSC2.5	●	2.5	5	50	6	H23
2ESMS2.5	●	2.5	5	50	6	H26
2ESMSUS2.5	●	2.5	5	50	6	H28
2NES2.5-AT	●	2.5	5	55	6	H21
2GNKS2.5	□	2.5	5	55	6	H69
2NKS2.5	●	2.5	5	55	6	H30
2NER2.5-AT	●	2.5	7	55	6	H21
2ESMRC2.5	●	2.5	7	55	6	H23
2ESMR2.5	●	2.5	7	55	6	H27
2GNKR2.5	□	2.5	7	55	6	H69
4NER2.5-AT	●	2.5	7	55	6	H40
4GNKR2.5	□	2.5	7	55	6	H70
2NKR2.5	●	2.5	7	55	6	H32
4NKRC2.5	□	2.5	7	55	6	H43
4ESMRC2.5	□	2.5	10	55	6	H41
4ESMR2.5	□	2.5	10	55	6	H42
2NKL2.5X12	□	2.5	12	60	6	H33
2NKL2.5	□	2.5	15	60	6	H33
4NKLC2.5	□	2.5	15	60	6	H45
2NKL2.5X20	□	2.5	20	60	6	H33
2NKS2.55	□	2.55	8	60	6	H30
2ESMS2.6	□	2.6	7	50	6	H26
2NKS2.6	□	2.6	7	55	6	H30
4NKRC2.6	□	2.6	10	55	6	H43
2NKL2.6	□	2.6	15	60	6	H33
2NKS2.65	□	2.65	8	60	6	H30
2ESMS2.7	□	2.7	7	50	6	H26
2NKS2.7	●	2.7	7	55	6	H30
4NKRC2.7	□	2.7	10	55	6	H43
2NKL2.7	□	2.7	15	60	6	H33
2NKS2.75	□	2.75	8	60	6	H30
2ESMS2.8	□	2.8	7	50	6	H26
2NKS2.8	●	2.8	7	55	6	H30
4NKRC2.8	□	2.8	10	55	6	H43
2NKL2.8	□	2.8	15	60	6	H33
2NKS2.85	□	2.85	8	60	6	H30
2ESMS2.9	□	2.9	7	50	6	H26
2NKS2.9	●	2.9	7	55	6	H30
4NKRC2.9	□	2.9	10	55	6	H43
2NKL2.9	□	2.9	15	60	6	H33
2NKS2.95	□	2.95	8	60	6	H30
ESMKH3	□	3	5	55	10	H75
ESMKN3	□	3	5	55	10	H75
ESMKNN3	□	3	5	55	10	H75
2ESMSC3	●	3	7	50	6	H23
2ESMSUS3	●	3	7	50	6	H28
2ESMS3	●	3	7	50	6	H26
2ESMSUS3	●	3	7	50	6	H28

商品コード Item code	在庫 Stock	外径 Tool da.	刃長 Flute length	全長 Overall length	シャンク径 Shank dia.	ページ Page
2NES3-AT	●	3	7	55	6	H21
2GNKS3	□	3	7	55	6	H69
2NKS3	●	3	7	55	6	H30
2NER3-AT	●	3	10	55	6	H21
2ESMRC3	●	3	10	55	6	H23
2ESMR3	●	3	10	55	6	H27
2GNKR3	□	3	10	55	6	H69
4NER3-AT	●	3	10	55	6	H40
4ESMRC3	●	3	10	55	6	H41
4ESMR3	●	3	10	55	6	H42
4GNKR3	□	3	10	55	6	H70
3NKR3	□	3	10	55	6	H70
2NKR3	●	3	10	55	6	H32
2AL3	●	3	10	55	6	H37
4NKRC3	●	3	10	55	6	H43
2ESMLC3	□	3	15	60	6	H23
2ESML3	●	3	15	60	6	H28
4ESMLC3	□	3	15	60	6	H41
4ESML3	●	3	15	60	6	H42
2NKL3	●	3	15	60	6	H33
4NKLC3	●	3	15	60	6	H45
4NKLE3	□	3	15	60	6	H70
2NKL3X20	□	3	20	65	6	H33
2NKL3X25	□	3	25	65	6	H33
2NKL3X30	□	3	30	65	6	H69
4NKX3X30	□	3	30	65	6	H71
2NKL3X40	□	3	40	70	6	H69
4NKX3X40	□	3	40	85	6	H71
2NKS3.05	□	3.05	12	60	6	H30
2ESMS3.1	□	3.1	8	60	8	H26
2NKS3.1	●	3.1	8	65	8	H30
2AL3.1	□	3.1	12	60	6	H37
4NKRC3.1	□	3.1	12	60	6	H43
2NKL3.1	□	3.1	20	65	6	H33
2NKS3.15	□	3.15	12	60	6	H30
2ESMS3.2	□	3.2	8	60	8	H26
2NKS3.2	●	3.2	8	65	8	H30
2AL3.2	□	3.2	12	60	6	H37
4NKRC3.2	□	3.2	12	60	6	H43
2NKL3.2	□	3.2	20	65	6	H33
2NKS3.25	□	3.25	12	60	6	H30
2ESMS3.3	□	3.3	8	60	8	H26
2NKS3.3	●	3.3	8	65	8	H30
2AL3.3	□	3.3	12	60	6	H37
4NKRC3.3	□	3.3	12	60	6	H43
2NKL3.3	□	3.3	20	65	6	H33
2NKS3.35	□	3.35	14	65	8	H30
2ESMS3.4	□	3.4	8	60	8	H26
2NKS3.4	●	3.4	8	65	8	H30
2AL3.4	□	3.4	12	60	6	H37
4NKRC3.4	□	3.4	12	60	6	H43
2NKL3.4	□	3.4	20	65	6	H33
2NKS3.45	□	3.45	14	65	8	H30
2ESMSC3.5	●	3.5	8	60	8	H23
2ESMS3.5	□	3.5	8	60	8	H26
2ESMSUS3.5	●	3.5	8	60	8	H28
2NES3.5-AT	●	3.5	8	65	8	H21
2GNKS3.5	□	3.5	8	65	8	H69
2NKS3.5	●	3.5	8	65	8	H30
2NER3.5-AT	●	3.5	12	60	6	H21
2GNKR3.5	□	3.5	12	60	6	H69
4NER3.5-AT	●	3.5	12	60	6	H40
4GNKR3.5	□	3.5	12	60	6	H70
2NKR3.5	●	3.5	12	60	6	H32
2AL3.5	□	3.5	12	60	6	H37
4NKRC3.5	●	3.5	12	60	6	H43
2ESMRC3.5	●	3.5	12	60	8	H23
2ESMR3.5	●	3.5	12	60		

外径別寸法早見表

ハイスエンドミル・スクエア

HSS End Mills -Square

商品コード Item code	在庫 Stock	外径 Tool da.	刃長 Flute length	全長 Overall length	シャンク径 Shank dia.	ページ Page
2ESMS4.3	□	4.3	10	60	8	H26
2NKS4.3	●	4.3	10	65	8	H30
2AL4.3	□	4.3	15	60	6	H37
4NKRC4.3	□	4.3	15	60	6	H43
2NKL4.3	□	4.3	25	70	6	H33
2NKS4.35	□	4.35	14	65	8	H30
2ESMS4.4	□	4.4	10	60	8	H26
2NKS4.4	●	4.4	10	65	8	H30
2AL4.4	□	4.4	15	60	6	H37
4NKRC4.4	□	4.4	15	60	6	H43
2NKL4.4	□	4.4	25	70	6	H33
2NKS4.45	□	4.45	14	65	8	H30
2ESMSC4.5	●	4.5	10	60	8	H23
2ESMS4.5	●	4.5	10	60	8	H26
2ESMS4.5	●	4.5	10	60	8	H28
2NES4.5-AT	●	4.5	10	65	8	H21
2GNKS4.5	□	4.5	10	65	8	H69
2NKS4.5	●	4.5	10	65	8	H30
2NER4.5-AT	●	4.5	15	60	6	H21
2GNKR4.5	□	4.5	15	60	6	H69
4NER4.5-AT	●	4.5	15	60	6	H40
4GNKR4.5	□	4.5	15	60	6	H70
2NKR4.5	●	4.5	15	60	6	H32
2AL4.5	□	4.5	15	60	6	H37
4NKRC4.5	□	4.5	15	60	6	H43
2ESMRC4.5	●	4.5	15	60	8	H23
2ESMR4.5	●	4.5	15	60	8	H27
4ESMRC4.5	□	4.5	15	60	8	H41
4ESMR4.5	□	4.5	15	60	8	H42
2NKL4.5	□	4.5	25	70	6	H33
4NKLC4.5	□	4.5	25	70	6	H45
2NKS4.55	□	4.55	16	65	8	H30
2ESMS4.6	□	4.6	10	60	8	H26
2NKS4.6	●	4.6	10	65	8	H30
2AL4.6	□	4.6	15	60	6	H37
4NKRC4.6	□	4.6	15	60	6	H43
2NKL4.6	□	4.6	25	70	6	H33
2NKS4.65	□	4.65	16	65	8	H30
2ESMS4.7	□	4.7	10	60	8	H26
2NKS4.7	●	4.7	10	65	8	H30
2AL4.7	□	4.7	15	60	6	H37
4NKRC4.7	□	4.7	15	60	6	H43
2NKL4.7	□	4.7	25	70	6	H33
2NKS4.75	□	4.75	16	65	8	H30
2ESMS4.8	□	4.8	10	60	8	H26
2NKS4.8	●	4.8	10	65	8	H30
2AL4.8	□	4.8	15	60	6	H37
4NKRC4.8	□	4.8	15	60	6	H43
2NKL4.8	□	4.8	25	70	6	H33
2NKS4.85	□	4.85	16	65	8	H30
2ESMS4.9	□	4.9	10	60	8	H26
2NKS4.9	●	4.9	10	65	8	H30
2AL4.9	□	4.9	15	60	6	H37
4NKRC4.9	□	4.9	15	60	6	H43
2NKL4.9	□	4.9	25	70	6	H33
2NKS4.95	□	4.95	16	65	8	H30
ESMKH5	□	5	8	55	10	H75
ESMKN5	□	5	8	55	10	H75
ESMKNN5	□	5	8	55	10	H75
2ESMSC5	●	5	10	60	8	H23
2ESMSUSC5	●	5	10	60	8	H25
2ESMS5	●	5	10	60	8	H26
2ESMSUS5	●	5	10	60	8	H28
2NES5-AT	●	5	10	65	8	H21
2GNKS5	□	5	10	65	8	H69
2NKS5	●	5	10	65	8	H30
2NER5-AT	●	5	15	60	6	H21
2GNKR5	□	5	15	60	6	H69
4NER5-AT	●	5	15	60	6	H40
4GNKR5.5	□	5.5	15	60	6	H70
2NKR5.5	●	5.5	15	60	6	H32
2AL5.5	□	5.5	15	60	6	H37
4NKRC5.5	□	5.5	15	60	6	H43
2ESMRC5.5	●	5.5	15	60	8	H23
2ESMR5.5	●	5.5	15	60	8	H27
4ESMRC5.5	□	5.5	15	65	8	H41
4ESMR5.5	□	5.5	15	65	8	H42
2NKL5.5	□	5.5	25	70	6	H33
4NKLC5.5	□	5.5	25	70	6	H45
2NKS5.55	□	5.55	16	65	8	H30
2ESMS5.6	□	5.6	12	60	8	H26
2NKS5.6	●	5.6	12	65	8	H30
2AL5.6	□	5.6	15	60	6	H37
4NKRC5.6	□	5.6	15	60	6	H43
2NKL5.6	□	5.6	25	70	6	H33
2NKS5.65	□	5.65	16	65	8	H30
2ESMS5.7	□	5.7	12	60	8	H26
2NKS5.7	●	5.7	12	65	8	H30
2AL5.7	□	5.7	15	60	6	H37

商品コード Item code	在庫 Stock	外径 Tool da.	刃長 Flute length	全長 Overall length	シャンク径 Shank dia.	ページ Page
2AL5	●	5	15	60	6	H37
4NKRC5	●	5	15	60	6	H43
2ESMRC5	●	5	15	60	8	H23
2ESMR5	●	5	15	60	8	H27
1AL5	●	5	15	60	8	H37
4ESMRC5	●	5	15	65	8	H41
4ESMR5	●	5	15	65	8	H42
2ESMLC5	□	5	25	70	6	H23
2ESML5	●	5	25	70	6	H28
4ESMLC5	□	5	25	70	6	H41
4ESML5	●	5	25	70	6	H42
2NKL5	●	5	25	70	6	H33
4NKLC5	●	5	25	70	6	H45
4NKLE5	□	5	25	70	6	H70
2NKX5X40	□	5	40	75	6	H69
4NKX5X40	□	5	40	75	6	H71
2NKX5X50	□	5	50	85	6	H69
4NKX5X50	□	5	50	95	6	H71
2NKS5.05	□	5.05	16	65	8	H30
2ESMS5.1	□	5.1	12	60	8	H26
2NKS5.1	●	5.1	12	65	8	H30
2AL5.1	□	5.1	15	60	6	H37
4NKRC5.1	□	5.1	15	60	6	H43
2NKL5.1	□	5.1	25	70	6	H33
2NKS5.15	□	5.15	16	65	8	H30
2ESMS5.2	□	5.2	12	60	8	H26
2NKS5.2	●	5.2	12	65	8	H30
2AL5.2	□	5.2	15	60	6	H37
4NKRC5.2	□	5.2	15	60	6	H43
2NKL5.2	□	5.2	25	70	6	H33
2NKS5.25	□	5.25	16	65	8	H30
2ESMS5.3	□	5.3	12	60	8	H26
2NKS5.3	●	5.3	12	65	8	H30
2AL5.3	□	5.3	15	60	6	H37
4NKRC5.3	□	5.3	15	60	6	H43
2NKL5.3	□	5.3	25	70	6	H33
2NKS5.35	□	5.35	16	65	8	H30
2ESMS5.4	□	5.4	12	60	8	H26
2NKS5.4	●	5.4	12	65	8	H30
2AL5.4	□	5.4	15	60	6	H37
4NKRC5.4	□	5.4	15	60	6	H43
2NKL5.4	□	5.4	25	70	6	H33
2NKS5.45	□	5.45	16	65	8	H30
2ESMSC5.5	●	5.5	12	60	8	H23
2ESMS5.5	●	5.5	12	60	8	H26
2ESMSUS5.5	●	5.5	12	60	8	H28
2NES5.5-AT	●	5.5	12	65	8	H21
2GNKS5.5	□	5.5	12	65	8	H69
2NKS5.5	●	5.5	12	65	8	H30
2NER5.5-AT	●	5.5	15	60	6	H21
2GNKR5.5	□	5.5	15	60	6	H69
4NER5.5-AT	●	5.5	15	60	6	H40
4GNKR5.5	□	5.5	15	60	6	H70
2NKR5.5	●	5.5	15	60	6	H32
2AL5.5	□	5.5	15	60	6	H37
4NKRC5.5	□	5.5	15	60	6	H43
2ESMRC5.5	●	5.5	15	60	8	H23
2ESMR5.5	●	5.5	15	60	8	H27
4ESMRC5.5	□	5.5	15	65	8	H41
4ESMR5.5	□	5.5	15	65	8	H42
2NKL5.5	□	5.5	25	70	6	H33
4NKLC5.5	□	5.5	25	70	6	H45
2NKS5.55	□	5.55	16	65	8	H30
2ESMS5.6	□	5.6	12	60	8	H26
2NKS5.6	●	5.6	12	65	8	H30
2AL5.6	□	5.6	15	60	6	H37
4NKRC5.6	□	5.6	15	60	6	H43
2NKL5.6	□	5.6	25	70	6	H33
2NKS5.65	□	5.65	16	65	8	H30
2ESMS5.7	□	5.7	12	60	8	H26
2NKS5.7	●	5.7	12	65	8	H30
2AL5.7	□	5.7	15	60	6	H37

商品コード Item code	在庫 Stock	外径 Tool da.	刃長 Flute length	全長 Overall length	シャンク径 Shank dia.	ページ Page
4NKRC5.7	□	5.7	15	60	6	H43
2NKL5.7	□	5.7	25	70	6	H33
2NKS5.75	□	5.75	16	65	8	H30
2ESMS5.8	□	5.8	12	60	8	H26
2NKS5.8	●	5.8	12	65	8	H30
2AL5.8	□	5.8	15	60	6	H37
4NKRC5.8	□	5.8	15	60	6	H43
2NKL5.8	□	5.8	25	70	6	H33
2NKS5.85	□	5.85	16	65	8	H30
2ESMS5.9	□	5.9	12	60	8	H26
2NKS5.9	●	5.9	12	65	8	H30
2AL5.9	□	5.9	15	60	6	H37
4NKRC5.9	□	5.9	15	60	6	H43
2NKL5.9	□	5.9	25	70	6	H33
2NKS5.95	□	5.95	16	65	8	H30
ESMKH6	□	6	10	55	10	H75
ESMKN6	□	6	10	55	10	H75
ESMKNN6	□	6	10	55	10	H75
2ESMSC6	●	6	12	60	8	H23
2ESMSUSC6	●	6	12	60	8	H25
2ESMS6	●	6	12	60	8	H26
2ESMSUS6	●	6	12	60	8	H28
2NES6-AT	●	6	12	65	8	H21
2GNKS6	□	6	12	65	8	H69
2NKS6	●	6	12	65	8	H30
GCQS6	□	6	13	60	6	H72
GQR6	□	6	13	60	6	H73
QR6	□	6	13	60	6	H73
2NER6-AT	●	6	15	60	6	H21
2GNKR6	□	6	15	60	6	H69
4NER6-AT	●	6	15	60	6	H40
4GNKR6	□	6	15	60	6	H70
3NKR6	□	6	15	60	6	H70
GRFR6	□	6	15	60	6	H72
RFR6-AT	●	6	15	60	6	H60
RFR6	●	6	15	60	6	H62
2NKR6	●	6	15	60	6	H32
2AL6	□	6	15	60	6	H37
4NKRC6	●	6	15	60	6	H43
2ESMRC6	●	6	15	60	8	H23
2ESMR6	●	6	15	60	8	H27
1AL6	●	6	15	60	8	H37
4ESMRC6	●	6	15	65	8	H41
4ESMR6	●	6	15	65	8	H42
HKR6-AT	●	6	15	70	6	H46
HKR6	●	6	15	70	6	H46
ESMHKR6	●	6	15	70	6	H48
ESMHN6	●	6	15	70	6	H50
HN6	□	6	15	70	8	H75
RQS6-AT	●	6				

商品コード Item code	在庫 Stock	外径 Tool da.	刃長 Flute length	全長 Overall length	シャンク径 Shank dia.	ページ Page
2NKL6.9	□	6.9	35	85	8	H33
2NKS6.95	□	6.95	21	75	10	H30
ESMKH7	□	7	10	55	10	H75
ESMKN7	□	7	10	55	10	H75
ESMKNN7	□	7	10	55	10	H75
2ESMSC7	●	7	14	65	10	H23
2ESMS7	●	7	14	65	10	H26
2ESMSUS7	●	7	14	65	10	H28
2NES7-AT	●	7	14	70	10	H21
2GNKS7	□	7	14	70	10	H69
2NKS7	●	7	14	70	10	H30
GCQS7	□	7	16	65	8	H72
2NER7-AT	●	7	20	70	8	H21
2GNKR7	□	7	20	70	8	H69
4NER7-AT	●	7	20	70	8	H40
4GNKR7	□	7	20	70	8	H70
3NKR7	□	7	20	70	8	H70
GRFR7	□	7	20	70	8	H72
RFR7-AT	●	7	20	70	8	H60
RFR7	●	7	20	70	8	H62
2NKR7	●	7	20	70	8	H32
2AL7	●	7	20	70	8	H37
4NKRC7	●	7	20	70	8	H43
2ESMRC7	●	7	20	70	10	H23
2ESMR7	●	7	20	70	10	H27
ESMHN7	□	7	20	75	8	H50
GRQR7	□	7	20	75	8	H73
4ESMRC7	●	7	20	75	10	H41
4ESMR7	●	7	20	75	10	H42
FQS7-AT	●	7	20	90	8	H58
GFQS7	□	7	20	90	8	H71
HQS7	●	7	20	90	8	H63
FQR7-AT	●	7	25	90	8	H58
GFQR7	□	7	25	90	8	H72
HQR7	●	7	25	90	8	H63
2ESML7	□	7	35	85	8	H28
4ESML7	□	7	35	85	8	H42
RFL7	□	7	35	85	8	H62
2NKL7	●	7	35	85	8	H33
4NKLC7	●	7	35	85	8	H45
4NKLE7	□	7	35	85	8	H70
QL7X40	□	7	40	90	8	H74
2NKX7X50	□	7	50	90	8	H69
4NKX7X50	□	7	50	90	8	H71
2NKX7X60	□	7	60	100	8	H69
4NKX7X60	□	7	60	100	8	H71
2NKS7.05	□	7.05	21	75	10	H30
2ESMS7.1	□	7.1	14	65	10	H26
2NKS7.1	●	7.1	14	70	10	H30
2AL7.1	□	7.1	20	70	8	H37
4NKRC7.1	□	7.1	20	70	8	H43
2NKL7.1	□	7.1	35	85	8	H33
2NKS7.15	□	7.15	21	75	10	H30
2ESMS7.2	□	7.2	14	65	10	H26
2NKS7.2	●	7.2	14	70	10	H30
2AL7.2	□	7.2	20	70	8	H37
4NKRC7.2	□	7.2	20	70	8	H43
2NKL7.2	□	7.2	35	85	8	H33
2NKS7.25	□	7.25	21	75	10	H30
2ESMS7.3	□	7.3	14	65	10	H26
2NKS7.3	●	7.3	14	70	10	H30
2AL7.3	□	7.3	20	70	8	H37
4NKRC7.3	□	7.3	20	70	8	H43
2NKL7.3	□	7.3	35	85	8	H33
2NKS7.35	□	7.35	21	75	10	H30
2ESMS7.4	□	7.4	14	65	10	H26
2NKS7.4	●	7.4	14	70	10	H30
2AL7.4	□	7.4	20	70	8	H37
4NKRC7.4	□	7.4	20	70	8	H43
2NKL7.4	□	7.4	35	85	8	H33
2NKS7.45	□	7.45	21	75	10	H30
2ESMSC7.5	●	7.5	14	65	10	H23

商品コード Item code	在庫 Stock	外径 Tool da.	刃長 Flute length	全長 Overall length	シャンク径 Shank dia.	ページ Page
2ESMS7.5	●	7.5	14	65	10	H26
2ESMSUS7.5	●	7.5	14	65	10	H28
2NES7.5-AT	●	7.5	14	70	10	H21
2GNKS7.5	□	7.5	14	70	10	H69
2NKS7.5	●	7.5	14	70	10	H30
2NER7.5-AT	●	7.5	20	70	8	H21
2GNKR7.5	□	7.5	20	70	8	H69
4NER7.5-AT	●	7.5	20	70	8	H40
4GNKR7.5	□	7.5	20	70	8	H70
2NKR7.5	●	7.5	20	70	8	H32
2AL7.5	□	7.5	20	70	8	H38
4NKRC7.5	●	7.5	20	70	8	H43
2ESMRC7.5	●	7.5	20	70	10	H23
2ESMR7.5	●	7.5	20	70	10	H27
4ESMRC7.5	□	7.5	20	75	10	H41
4ESMR7.5	□	7.5	20	75	10	H42
2NKL7.5	□	7.5	35	85	8	H33
4NKLC7.5	□	7.5	35	85	8	H45
2NKS7.55	□	7.55	21	75	10	H30
2ESMS7.6	□	7.6	14	65	10	H26
2NKS7.6	●	7.6	14	70	10	H30
2AL7.6	□	7.6	20	70	8	H38
4NKRC7.6	□	7.6	20	70	8	H43
2NKL7.6	□	7.6	35	85	8	H33
2NKS7.65	□	7.65	21	75	10	H30
2ESMS7.7	□	7.7	14	65	10	H26
2NKS7.7	●	7.7	14	70	10	H30
2AL7.7	□	7.7	20	70	8	H38
4NKRC7.7	□	7.7	20	70	8	H43
2NKL7.7	□	7.7	35	85	8	H33
2NKS7.75	□	7.75	21	75	10	H30
2ESMS7.8	□	7.8	14	65	10	H26
2NKS7.8	●	7.8	14	70	10	H30
2AL7.8	□	7.8	20	70	8	H38
4NKRC7.8	□	7.8	20	70	8	H43
2NKL7.8	□	7.8	35	85	8	H33
2NKS7.85	□	7.85	21	75	10	H30
2ESMS7.9	□	7.9	14	65	10	H26
2NKS7.9	●	7.9	14	70	10	H30
2AL7.9	□	7.9	20	70	8	H38
4NKRC7.9	□	7.9	20	70	8	H43
2NKL7.9	□	7.9	35	85	8	H33
2NKS7.95	□	7.95	21	75	10	H30
ESMKH8	□	8	12	55	10	H75
ESMKN8	□	8	12	55	10	H75
ESMKNN8	□	8	12	55	10	H75
2ESMSC8	●	8	14	65	10	H23
2ESMSUSC8	●	8	14	65	10	H25
2ESMS8	●	8	14	65	10	H26
2ESMSUS8	●	8	14	65	10	H28
2NES8-AT	●	8	14	70	10	H21
2GNKS8	□	8	14	70	10	H69
2NKS8	●	8	14	70	10	H30
GCQS8	□	8	19	70	8	H72
GQR8	□	8	19	70	8	H73
QR8	□	8	19	70	8	H73
2NER8-AT	●	8	20	70	8	H21
2GNKR8	□	8	20	70	8	H69
4NER8-AT	●	8	20	70	8	H40
4GNKR8	□	8	20	70	8	H70
3NKR8	□	8	20	70	8	H70
GRFR8	□	8	20	70	8	H72
RFR8-AT	●	8	20	70	8	H60
RFR8	●	8	20	70	8	H62
2NKR8	●	8	20	70	8	H32
2AL8	●	8	20	70	8	H38
4NKRC8	●	8	20	70	8	H43
2ESMRC8	●	8	20	70	10	H23
2ESMR8	●	8	20	70	10	H27
1AL8	●	8	20	75	8	H38
HKN8-AT	●	8	20	75	8	H46
HKR8-AT	●	8	20	75	8	H46

商品コード Item code	在庫 Stock	外径 Tool da.	刃長 Flute length	全長 Overall length	シャンク径 Shank dia.	ページ Page
ESMHKR8	●	8	20	75	8	H48
ESMHN8	●	8	20	75	8	H50
4ESMRC8	●	8	20	75	10	H41
4ESMR8	●	8	20	75	10	H42
HN8	□	8	20	75	10	H75
RQS8-AT	●	8	20	90	8	H52
ESMQS8	●	8	20	90	8	H55
FQS8-AT	●	8	20	90	8	H58
GFQS8	□	8	20	90	8	H71
HQS8	●	8	20	90	8	H63
LGS8	□	8	20	100	8	H71
LQ8	□	8	20	100	8	H73
GRQR8	□	8	25	80	8	H73
RQR8-AT	●	8	25	90	8	H52
ESMQR8	●	8	25	90	8	H55
FQR8-AT	●	8	25	90	8	H58
GFQR8	□	8	25	90	8	H72
HQR8	●	8	25	90	8	H63
2ESMLC8	□	8	35	85	8	H23
2ESML8	●	8	35	85	8	H28
4ESMLC8	□	8	35	85	8	H41
4ESML8	●	8	35	85	8	H42
RFL8	●	8	35	85	8	H62
2NKL8	●	8	35	85	8	H33
4NKLC8	●	8	35	85	8	H45
4NKLE8	□	8	35	85	8	H70
2NKX8X50	□	8	50	90	8	H69
4NKX8X50	□	8	50	90	8	H71
2NKX8X60	□	8	60	100	8	H69
4NKX8X60	□	8	60	100	8	H71
QL8X60	□	8	60	110	8	H74
QL8X80	□	8	80	130	8	H74
2NKS8.05	□	8.05	21	75	10	H30
2ESMS8.1	□	8.1	18	70	10	H26
2NKS8.1	●	8.1	18	75	10	H30
2AL8.1	□	8.1	20	70	10	H38
4NKRC8.1	□	8.1	25	80	10	H43
2NKL8.1	□	8.1	45	100	10	H33
2NKS8.15	□	8.15	21	75	10	H30
2ESMS8.2	□	8.2	18	70	10	H26
2NKS8.2	●	8.2	18	75	10	H30
2AL8.2	□	8.2	20	70	10	H38
4NKRC8.2	□	8.2	25	80	10	H43
2NKL8.2	□	8.2	45	100	10	H33
2NKS8.25	□	8.25	21	75	10	H30
2ESMS8.3	□	8.3	18	70	10	H26
2NKS8.3	●	8.3	18	75	10	H30
2AL8.3	□	8.3	20	70	10	H38
4NKRC8.3	□	8.3	25	80	10	H43
2NKL8.3	□	8.3	45	100	10	H33
2NKS8.35	□	8.35	21	75	10	H30
2ESMS8.4	□	8.4	18	70	10	H26
2NKS8.4	●	8.4	18	75	10	H30
2AL8.4	□	8.4	20	70	10	H38
4NKRC8.4	□	8.4	25	80	10	H43
2NKL8.4	□	8.4	45	100	10	H33
2NKS8.45	□	8.45	21	75	10	H30
2ESMSC8.5	●	8.5	18	70	10	H23
2ESMS8.5	●	8.5	18	70	10	H26
2ESMSUS8.5	●	8.5	18	70	10	H28
2NES8.5-AT	●	8.5	18	75	10	H21
2GNKS8.5	□	8.5	18	75	10	H69
2NKS8.5	●	8.5	18	75	10	H30
2AL8.5	□	8.5	20	70	10	H38
2NER8.5-AT	●	8.5	25	80	10	H21
2ESMRC8.5	●	8.5	25	80	10	H23
2ESMR8.5	●	8.5	25	80	10	H27
2GNKR8.5	□	8.5	25	80	10	H69
4NER8.5-AT	●	8.5	25	80	10	H40
4ESMRC8.5	□	8.5	25	80	10	H41
4ESMR8.5	□	8.5	25			

外径別寸法早見表

ハイスエンドミル・スクエア

HSS End Mills -Square

商品コード Item code	在庫 Stock	外径 Tool da.	刃長 Flute length	全長 Overall length	シャンク径 Shank dia.	ページ Page
2ESMS9.1	□	9.1	18	75	10	H26
2NKS9.1	●	9.1	18	75	10	H31
2AL9.1	□	9.1	25	80	10	H38
4NKRC9.1	□	9.1	25	80	10	H43
2NKL9.1	□	9.1	45	100	10	H33
2NKS9.15	□	9.15	26	85	10	H31
2ESMS9.2	□	9.2	18	75	10	H26
2NKS9.2	●	9.2	18	75	10	H31
2AL9.2	□	9.2	25	80	10	H38
4NKRC9.2	□	9.2	25	80	10	H43
2NKL9.2	□	9.2	45	100	10	H33
2NKS9.25	□	9.25	26	85	10	H31
2ESMS9.3	□	9.3	18	75	10	H26
2NKS9.3	●	9.3	18	75	10	H31
2AL9.3	□	9.3	25	80	10	H38
4NKRC9.3	□	9.3	25	80	10	H43
2NKL9.3	□	9.3	45	100	10	H33
2NKS9.35	□	9.35	26	85	10	H31
2ESMS9.4	□	9.4	18	75	10	H26
2NKS9.4	●	9.4	18	75	10	H31
2AL9.4	□	9.4	25	80	10	H38
4NKRC9.4	□	9.4	25	80	10	H43
2NKL9.4	□	9.4	45	100	10	H33
2NKS9.45	□	9.45	26	85	10	H31
2NES9.5-AT	●	9.5	18	75	10	H21
2ESMSC9.5	●	9.5	18	75	10	H23
2ESMS9.5	●	9.5	18	75	10	H26
2ESMS9.5	●	9.5	18	75	10	H28
2GNKS9.5	□	9.5	18	75	10	H69
2NKS9.5	●	9.5	18	75	10	H31
2NER9.5-AT	●	9.5	25	80	10	H21
2ESMRC9.5	●	9.5	25	80	10	H23
2ESMR9.5	●	9.5	25	80	10	H27
2GNKR9.5	□	9.5	25	80	10	H69
4NER9.5-AT	●	9.5	25	80	10	H40
4GNKR9.5	□	9.5	25	80	10	H70
2NKR9.5	●	9.5	25	80	10	H32
2AL9.5	□	9.5	25	80	10	H38
4NKRC9.5	●	9.5	25	80	10	H43
4ESMRC9.5	□	9.5	25	90	10	H41
4ESMR9.5	□	9.5	25	90	10	H42
2NKL9.5	□	9.5	45	100	10	H33
4NKL9.5	□	9.5	45	100	10	H45
2NKS9.55	□	9.55	26	85	10	H31
2ESMS9.6	□	9.6	18	75	10	H26
2NKS9.6	●	9.6	18	75	10	H31
2AL9.6	□	9.6	25	80	10	H38
4NKRC9.6	□	9.6	25	80	10	H43
2NKL9.6	□	9.6	45	100	10	H33
2NKS9.65	□	9.65	26	85	10	H31
2ESMS9.7	□	9.7	18	75	10	H26
2NKS9.7	●	9.7	18	75	10	H31
2AL9.7	□	9.7	25	80	10	H38
4NKRC9.7	□	9.7	25	80	10	H43
2NKL9.7	□	9.7	45	100	10	H33
2NKS9.75	□	9.75	26	85	10	H31
2ESMS9.8	□	9.8	18	75	10	H26
2NKS9.8	●	9.8	18	75	10	H31
2AL9.8	□	9.8	25	80	10	H38
4NKRC9.8	□	9.8	25	80	10	H43
2NKL9.8	□	9.8	45	100	10	H33
2NKS9.85	□	9.85	26	85	10	H31
2ESMS9.9	□	9.9	18	75	10	H26
2NKS9.9	●	9.9	18	75	10	H31
2AL9.9	□	9.9	25	80	10	H38
4NKRC9.9	□	9.9	25	80	10	H43
2NKL9.9	□	9.9	45	100	10	H33
2NKS9.95	□	9.95	26	85	10	H31
ESMKH10	□	10	15	65	12	H75
ESMKNN10	□	10	15	65	12	H75
2NES10-AT	●	10	18	75	10	H21

商品コード Item code	在庫 Stock	外径 Tool da.	刃長 Flute length	全長 Overall length	シャンク径 Shank dia.	ページ Page
2ESMSC10	●	10	18	75	10	H23
2ESMSUSC10	□	10	18	75	10	H25
2ESMS10	●	10	18	75	10	H26
2ESMSUS10	●	10	18	75	10	H28
2GNKS10	□	10	18	75	10	H69
2NKS10	●	10	18	75	10	H31
GCQS10	□	10	22	80	10	H72
GQR10	□	10	22	80	10	H73
QR10	□	10	22	80	10	H73
2NER10-AT	●	10	25	80	10	H21
2ESMRC10	●	10	25	80	10	H23
2ESMR10	●	10	25	80	10	H27
2GNKR10	□	10	25	80	10	H69
4NER10-AT	●	10	25	80	10	H40
4GNKR10	□	10	25	80	10	H70
3NKR10	□	10	25	80	10	H70
GRFR10	□	10	25	80	10	H72
RFR10-AT	●	10	25	80	10	H60
RFR10	●	10	25	80	10	H62
2NKR10	●	10	25	80	10	H32
2AL10	●	10	25	80	10	H38
4NKRC10	●	10	25	80	10	H43
1AL10	●	10	25	90	10	H38
4ESMRC10	●	10	25	90	10	H41
4ESMR10	●	10	25	90	10	H42
HKN10-AT	●	10	25	90	10	H46
HKR10-AT	●	10	25	90	10	H46
ESMHKR10	●	10	25	90	10	H48
ESMHN10	●	10	25	90	10	H50
HN10	□	10	25	90	12	H75
RQS10-AT	●	10	25	100	10	H52
ESMQS10	●	10	25	100	10	H55
FQS10-AT	●	10	25	100	10	H58
GFQS10	□	10	25	100	10	H71
HQS10	●	10	25	100	10	H63
LS10	□	10	25	125	10	H71
LQ10	□	10	25	125	10	H73
GRQR10	□	10	30	90	10	H73
RQR10-AT	●	10	35	100	10	H52
ESMQR10	●	10	35	100	10	H55
FQR10-AT	●	10	35	100	10	H58
GFQR10	□	10	35	100	10	H72
HQR10	●	10	35	100	10	H63
2ESMLC10	□	10	45	100	10	H23
2ESML10	●	10	45	100	10	H28
4ESMLC10	□	10	45	100	10	H41
4ESML10	●	10	45	100	10	H42
RQL10-AT	●	10	45	100	10	H52
ESMQL10	●	10	45	100	10	H56
FQL10-AT	□	10	45	100	10	H72
RFQL10	□	10	45	100	10	H72
GFQL10	●	10	45	100	10	H62
HQL10	●	10	45	100	10	H64
2NKL10	●	10	45	100	10	H33
4NKLC10	●	10	45	100	10	H45
4NKLE10	□	10	45	100	10	H70
2NKX10X60	□	10	60	105	10	H69
4NKX10X60	□	10	60	105	10	H71
QL10X60	□	10	60	120	10	H74
2NKX10X80	□	10	80	125	10	H69
4NKX10X80	□	10	80	125	10	H71
QL10X80	□	10	80	140	10	H74
2NKX10X100	□	10	100	155	10	H69
QL10X100	□	10	100	160	10	H74
2NKX10X120	□	10	120	175	10	H69
2NKX10X150	□	10	150	205	10	H69
2NKS10.05	□	10.05	26	85	10	H31
2NKS10.1	□	10.1	22	85	12	H31
4NKRC10.1	□	10.1	30	95	12	H43
2NKL10.1	□	10.1	55	120	12	H34
2NKS10.15	□	10.15	26	85	10	H31
2NKS10.2	□	10.2	22	85	12	H31

商品コード Item code	在庫 Stock	外径 Tool da.	刃長 Flute length	全長 Overall length	シャンク径 Shank dia.	ページ Page
4NKRC10.2	□	10.2	30	95	12	H43
2NKL10.2	□	10.2	55	120	12	H34
2NKS10.25	□	10.25	26	85	10	H31
2NKS10.3	□	10.3	22	85	12	H31
4NKRC10.3	□	10.3	30	95	12	H43
2NKL10.3	□	10.3	55	120	12	H34
2NKS10.35	□	10.35	26	85	10	H31
2NKS10.4	□	10.4	22	85	12	H31
4NKRC10.4	□	10.4	30	95	12	H43
2NKL10.4	□	10.4	55	120	12	H34
2NKS10.45	□	10.45	26	85	10	H31
2ESMS10.5	□	10.5	22	80	12	H26
2NKS10.5	●	10.5	22	85	12	H31
2ESMR10.5	□	10.5	30	95	12	H27
2NKR10.5	●	10.5	30	95	12	H32
2AL10.5	□	10.5	30	95	12	H38
4NKRC10.5	□	10.5	30	95	12	H43
2NKL10.5	□	10.5	55	120	12	H34
4NKLC10.5	□	10.5	55	120	12	H45
2NKS10.55	□	10.55	31	95	12	H31
2NKS10.6	□	10.6	22	85	12	H31
4NKRC10.6	□	10.6	30	95	12	H43
2NKL10.6	□	10.6	55	120	12	H34
2NKS10.65	□	10.65	31	95	12	H31
2NKS10.7	□	10.7	22	85	12	H31
4NKRC10.7	□	10.7	30	95	12	H43
2NKL10.7	□	10.7	55	120	12	H34
2NKS10.75	□	10.75	31	95	12	H31
2NKS10.8	□	10.8	22	85	12	H31
4NKRC10.8	□	10.8	30	95	12	H43
2NKL10.8	□	10.8	55	120	12	H34
2NKS10.85	□	10.85	31	95	12	H31
2NKS10.9	□	10.9	22	85	12	H31
4NKRC10.9	□	10.9	30	95	12	H43
2NKL10.9	□	10.9	55	120	12	H34
2NKS10.95	□	10.95	31	95	12	H31
2ESMSC11	●	11	22	80	12	H23
2ESMS11	●	11	22	80	12	H26
2ESMSUS11	●	11	22	80	12	H28
2NES11-AT	●	11	22	85	12	H21
2GNKS11	□	11	22	85	12	H69
GCQS11	□	11	22	85	12	H72
2NKS11	●	11	22	85	12	H31
2NER11-AT	●	11	30	95	12	H21
2ESMRC11	●	11	30	95	12	H23
2ESMR11	●	11	30	95	12	H27
2GNKR11	□	11	30	95	12	H69
4NER11-AT	●	11	30	95	12	H40
4ESMRC11	●	11	30	95	12	H41
4ESMR11	●	11	30	95	12	H42
4GNKR11	□	11	30	95	12	H70
3NKR11	□	11	30	95	12	H70
HKN11-AT	●	11	30	95	12	H46
ESMHN11	●	11	30	95	12	H50
GRFR11	□	11	30	95	12	H72
RFR11-AT	●	11	30	95	12	H60
RFR11	●	11	30	95	12	H62
GRQR11	□	11	30	95	12	H73
2NKR11	●	11	30	95	12	H32
2AL11	□	11	30	95	12	H38
4NKRC11</						

商品コード Item code	在庫 Stock	外径 Tool da.	刃長 Flute length	全長 Overall length	シャンク径 Shank dia.	ページ Page
ESMHKR12	●	12	30	95	12	H48
ESMHN12	●	12	30	95	12	H50
HN12	□	12	30	95	12	H75
GRFR12	□	12	30	95	12	H72
RFR12-AT	●	12	30	95	12	H60
RFR12	●	12	30	95	12	H62
2NKR12	●	12	30	95	12	H32
2AL12	●	12	30	95	12	H38
4NKRC12	●	12	30	95	12	H43
RQS12-AT	●	12	30	110	12	H52
ESMQS12	●	12	30	110	12	H55
FQS12-AT	●	12	30	110	12	H58
GFQS12	□	12	30	110	12	H71
HQS12	●	12	30	110	12	H63
LS12	□	12	30	150	10	H71
ESMQS12	●	12	30	150	10	H56
HQS12	●	12	30	150	10	H64
LQ12	□	12	30	150	10	H73
GRQR12	□	12	40	105	12	H73
RQR12-AT	●	12	40	110	12	H52
ESMQR12	●	12	40	110	12	H55
FQR12-AT	●	12	40	110	12	H58
GFQR12	□	12	40	110	12	H72
HQR12	●	12	40	110	12	H63
HKM12-AT	●	12	45	120	12	H46
ESMHKM12	●	12	45	120	12	H48
RQL12-AT	●	12	55	110	12	H52
ESMQL12	●	12	55	110	12	H56
FQL12-AT	●	12	55	110	12	H72
GFQL12	□	12	55	110	12	H72
HQL12	●	12	55	110	12	H64
2ESMLC12	□	12	55	120	12	H23
2ESML12	●	12	55	120	12	H28
4ESMLC12	□	12	55	120	12	H41
4ESML12	●	12	55	120	12	H42
HKL12-AT	●	12	55	120	12	H46
ESMHKL12	●	12	55	120	12	H48
RFL12	●	12	55	120	12	H62
2NKL12	●	12	55	120	12	H34
4NKLC12	●	12	55	120	12	H45
4NKLE12	□	12	55	120	12	H70
QL12X60	□	12	60	125	12	H74
2NKX12X80	□	12	80	130	12	H69
4NKX12X80	□	12	80	130	12	H71
QL12X80	□	12	80	145	12	H74
2NKX12X100	□	12	100	150	12	H69
4NKX12X100	□	12	100	150	12	H71
QL12X100	□	12	100	165	12	H74
2NKX12X120	□	12	120	185	12	H69
QL12X120	□	12	120	185	12	H74
2NKX12X150	□	12	150	215	12	H69
2NKS12.05	□	12.05	31	95	12	H31
2NKS12.1	□	12.1	25	95	16	H31
4NKRC12.1	□	12.1	35	105	16	H43
2NKL12.1X12	□	12.1	55	120	12	H34
2NKL12.1X16	□	12.1	55	120	16	H34
2NKS12.15	□	12.15	31	95	12	H31
2NKS12.2	□	12.2	25	95	16	H31
4NKRC12.2	□	12.2	35	105	16	H43
2NKL12.2X12	□	12.2	55	120	12	H34
2NKL12.2X16	□	12.2	55	120	16	H34
2NKS12.25	□	12.25	31	95	12	H31
2NKS12.3	□	12.3	25	95	16	H31
4NKRC12.3	□	12.3	35	105	16	H43
2NKL12.3X12	□	12.3	55	120	12	H34
2NKL12.3X16	□	12.3	55	120	16	H34
2NKS12.35	□	12.35	31	95	12	H31
2NKS12.4	□	12.4	25	95	16	H31
4NKRC12.4	□	12.4	35	105	16	H43
2NKL12.4X12	□	12.4	55	120	12	H34
2NKL12.4X16	□	12.4	55	120	16	H34
2NKS12.45	□	12.45	31	95	12	H31

商品コード Item code	在庫 Stock	外径 Tool da.	刃長 Flute length	全長 Overall length	シャンク径 Shank dia.	ページ Page
2ESMS12.5	□	12.5	25	95	16	H26
2NKS12.5	●	12.5	25	95	16	H31
2AL12.5	□	12.5	30	95	12	H38
2ESMR12.5	□	12.5	35	105	16	H27
2NKR12.5	●	12.5	35	105	16	H32
4NKRC12.5	□	12.5	35	105	16	H43
2NKL12.5X12	□	12.5	55	120	12	H34
2NKL12.5X16	□	12.5	55	120	16	H34
4NKLC12.5	□	12.5	55	125	16	H45
2NKS12.55	□	12.55	31	95	12	H31
2NKS12.6	□	12.6	25	95	16	H31
4NKRC12.6	□	12.6	35	105	16	H43
2NKL12.6X12	□	12.6	55	120	12	H34
2NKL12.6X16	□	12.6	55	120	16	H34
2NKS12.65	□	12.65	31	95	12	H31
2NKS12.7	□	12.7	25	95	16	H31
4NKRC12.7	□	12.7	35	105	16	H43
2NKL12.7X12	□	12.7	55	120	12	H34
2NKL12.7X16	□	12.7	55	120	16	H34
2NKS12.75	□	12.75	31	95	12	H31
2NKS12.8	□	12.8	25	95	16	H31
4NKRC12.8	□	12.8	35	105	16	H44
2NKL12.8X12	□	12.8	55	120	12	H34
2NKL12.8X16	□	12.8	55	120	16	H34
2NKS12.85	□	12.85	31	95	12	H31
2NKS12.9	□	12.9	25	95	16	H31
4NKRC12.9	□	12.9	35	105	16	H44
2NKL12.9X12	□	12.9	55	120	12	H34
2NKL12.9X16	□	12.9	55	120	16	H34
2NKS12.95	□	12.95	31	95	12	H31
2NES13-AT	●	13	25	90	12	H21
2ESMSC13	●	13	25	90	12	H23
2ESMS13	●	13	25	90	12	H26
2GNKS13	□	13	25	90	12	H69
2NKS13	●	13	25	90	12	H31
2ESMSUS13	●	13	25	95	16	H28
GCQS13	□	13	26	90	12	H72
HKN13-AT	●	13	30	95	12	H46
ESMHN13	●	13	30	95	12	H50
2AL13	□	13	30	95	12	H38
FQS13-AT	●	13	30	110	12	H58
GFQS13	□	13	30	110	12	H71
HQS13	●	13	30	110	12	H63
2NER13-AT	●	13	35	100	12	H21
2ESMRC13	●	13	35	100	12	H23
2ESMR13	●	13	35	100	12	H27
2GNKR13	□	13	35	100	12	H69
4NER13-AT	●	13	35	100	12	H40
4ESMRC13	●	13	35	100	12	H41
4ESMR13	●	13	35	100	12	H42
4GNKR13	□	13	35	100	12	H70
2NKR13	●	13	35	100	12	H32
4NKRC13	●	13	35	100	12	H44
3NKR13	□	13	35	105	16	H70
GRFR13	□	13	35	105	16	H72
RFR13-AT	●	13	35	105	16	H60
RFR13	●	13	35	105	16	H62
GRQR13	□	13	40	105	12	H73
FQR13-AT	●	13	40	110	12	H58
GFQR13	□	13	40	110	12	H72
HQR13	●	13	40	110	12	H63
2ESML13	□	13	55	120	12	H28
4ESML13	□	13	55	120	12	H42
2NKL13	●	13	55	120	12	H34
4NKLC13	●	13	55	120	12	H45
4NKLE13	□	13	55	120	12	H70
RFL13	□	13	55	125	16	H62
4NKLC13X16	□	13	55	125	16	H45
QL13X60	□	13	60	130	16	H74
2NKX13X80	□	13	80	150	16	H69
4NKX13X80	□	13	80	150	16	H71
QL13X80	□	13	80	150	16	H74

商品コード Item code	在庫 Stock	外径 Tool da.	刃長 Flute length	全長 Overall length	シャンク径 Shank dia.	ページ Page
2NKX13X100	□	13	100	150	16	H69
4NKX13X100	□	13	100	150	16	H71
QL13X100	□	13	100	170	16	H74
2NKX13X120	□	13	120	190	16	H69
2NKS13.1	□	13.1	25	95	16	H31
4NKRC13.1	□	13.1	35	105	16	H44
2NKS13.2	□	13.2	25	95	16	H31
4NKRC13.2	□	13.2	35	105	16	H44
2NKS13.3	□	13.3	25	95	16	H31
4NKRC13.3	□	13.3	35	105	16	H44
2NKS13.4	□	13.4	25	95	16	H31
4NKRC13.4	□	13.4	35	105	16	H44
2ESMS13.5	□	13.5	25	95	16	H26
2NKS13.5	●	13.5	25	95	16	H31
2AL13.5	□	13.5	30	95	12	H38
2ESMR13.5	□	13.5	35	105	16	H27
2NKR13.5	●	13.5	35	105	16	H32
4NKRC13.5	□	13.5	35	105	16	H44
2NKL13.5	□	13.5	55	125	16	H34
4NKLC13.5	□	13.5	55	125	16	H45
2NKS13.6	□	13.6	25	95	16	H31
4NKRC13.6	□	13.6	35	105	16	H44
2NKS13.7	□	13.7	25	95	16	H31
4NKRC13.7	□	13.7	35	105	16	H44
2NKS13.8	□	13.8	25	95	16	H31
4NKRC13.8	□	13.8	35	105	16	H44
2NKS13.9	□	13.9	25	95	16	H31
4NKRC13.9	□	13.9	35	105	16	H44
ESMKH14	□	14	15	75	16	H75
ESMKN14	□	14	15	75	16	H75
ESMKN14	□	14	15	75	16	H75
2NES14-AT	●	14	25	95	16	H21
2ESMSC14	●	14	25	95	16	H23
2ESMS14	●	14	25	95	16	H26
2ESMSUS14	●	14	25	95	16	H28
2GNKS14	□	14	25	95	16	H69
2NKS14	●	14	25	95	16	H31
GCQS14	□	14	26	90	12	H72
GQR14	□	14	26	95	16	H73
QR14	□	14	26	95	16	H73
RQS14-AT	●	14	30	110	12	H52
ESMQS14	●	14	30	110	12	H55
FQS14-AT	●	14	30	110	12	H58
GFQS14	□	14	30	110	12	H71
HQS14	●	14	30	110	12	H63
HQL14	●	14	30	150	12	H64
HKN14-AT	●	14	35	105	12	H46
ESMHN14	●	14	35	105	12	H50
2NER14-AT	●	14	35	105	16	H21
2ESMRC14	●	14	35	105	16	H23
2ESMR14	●	14	35	105	16	H27
2GNKR14	□	14	35	105	16	H69
4NER14-AT	●	14	35	105	16	H40
4ESMRC14	●	14	35	105	16	H41
4ESMR14	●	14	35	105	16	H42
4GNKR14	□	14	35	105	16	H70
3NKR14	□	14	35	105	16	H70
HN14	□	14	35	105	16	H75
GRFR14	□	14	35	105	16	H72
RFR14-AT	●	14	35	105	16	H60

外径別寸法早見表

ハイスエンドミル・スクエア

HSS End Mills -Square

商品コード Item code	在庫 Stock	外径 Tool da.	刃長 Flute length	全長 Overall length	シャンク径 Shank dia.	ページ Page
4ESMRC15	●	15	40	110	16	H41
4ESMR15	●	15	40	110	16	H42
4GNKR15	□	15	40	110	16	H70
3NKR15	□	15	40	110	16	H70
GRFR15	□	15	40	110	16	H72
RFR15-AT	□	15	40	110	16	H60
RFR15	●	15	40	110	16	H62
2NKR15	●	15	40	110	16	H32
2AL15	●	15	40	110	16	H38
4NKRC15	●	15	40	110	16	H44
HKN15-AT	●	15	40	115	16	H46
ESMHN15	●	15	40	115	16	H50
HN15	□	15	40	115	16	H75
LS15	□	15	40	155	12	H71
LQ15	□	15	40	155	12	H73
HQL15	●	15	55	110	12	H64
ESMQL15	●	15	55	110	16	H56
FQL15-AT	□	15	55	110	16	H72
GFQL15	□	15	55	110	16	H72
QL15X60	□	15	60	130	16	H74
2ESMLC15	□	15	65	135	16	H23
2ESML15	●	15	65	135	16	H28
4ESMLC15	□	15	65	135	16	H41
4ESML15	●	15	65	135	16	H42
RFL15	□	15	65	135	16	H62
2NKL15	●	15	65	135	16	H34
4NKLC15	●	15	65	135	16	H45
4NKLE15	□	15	65	135	16	H70
2NKX15X80	□	15	80	135	16	H69
4NKX15X80	□	15	80	135	16	H71
QL15X80	□	15	80	150	16	H74
2NKX15X100	□	15	100	155	16	H69
4NKX15X100	□	15	100	155	16	H71
QL15X100	□	15	100	170	16	H74
2NKX15X120	□	15	120	190	16	H69
QL15X120	□	15	120	190	16	H74
2NKX15X150	□	15	150	220	16	H69
QL15X150	□	15	150	220	16	H74
2NKS15.1	□	15.1	30	100	16	H31
4NKRC15.1	□	15.1	40	110	16	H44
2NKS15.2	□	15.2	30	100	16	H31
4NKRC15.2	□	15.2	40	110	16	H44
2NKS15.3	□	15.3	30	100	16	H31
4NKRC15.3	□	15.3	40	110	16	H44
2NKS15.4	□	15.4	30	100	16	H31
4NKRC15.4	□	15.4	40	110	16	H44
2ESMS15.5	□	15.5	30	100	16	H26
2NKS15.5	●	15.5	30	100	16	H31
2ESMR15.5	□	15.5	40	110	16	H27
2NKR15.5	●	15.5	40	110	16	H32
2AL15.5	□	15.5	40	110	16	H38
4NKRC15.5	□	15.5	40	110	16	H44
2NKL15.5	□	15.5	65	135	16	H34
4NKLC15.5	□	15.5	65	135	16	H45
2NKS15.6	□	15.6	30	100	16	H31
4NKRC15.6	□	15.6	40	110	16	H44
2NKS15.7	□	15.7	30	100	16	H31
4NKRC15.7	□	15.7	40	110	16	H44
2NKS15.8	□	15.8	30	100	16	H31
4NKRC15.8	□	15.8	40	110	16	H44
2NKS15.9	□	15.9	30	100	16	H31
4NKRC15.9	□	15.9	40	110	16	H44
ESMKH16	□	16	18	80	16	H75
ESMKN16	□	16	18	80	16	H75
2NES16-AT	●	16	30	100	16	H21
2ESMSC16	●	16	30	100	16	H23
2ESMSUSC16	●	16	30	100	16	H25
2ESMS16	●	16	30	100	16	H26
2ESMSUS16	●	16	30	100	16	H28
2GNKS16	□	16	30	100	16	H69
2NKS16	●	16	30	100	16	H31

商品コード Item code	在庫 Stock	外径 Tool da.	刃長 Flute length	全長 Overall length	シャンク径 Shank dia.	ページ Page
HQLS16	●	16	30	150	12	H64
GCQS16	□	16	32	100	16	H72
GQR16	□	16	32	100	16	H73
QR16	□	16	32	100	16	H73
RQS16-AT	●	16	35	125	16	H52
ESMQS16	●	16	35	125	16	H55
FQS16-AT	●	16	35	125	16	H58
GFQS16	□	16	35	125	16	H71
HQS16	●	16	35	125	16	H63
2NER16-AT	●	16	40	110	16	H21
2ESMRC16	●	16	40	110	16	H23
2ESMR16	●	16	40	110	16	H27
2GNKR16	□	16	40	110	16	H69
4NER16-AT	●	16	40	110	16	H40
4ESMRC16	●	16	40	110	16	H41
4ESMR16	●	16	40	110	16	H42
4GNKR16	□	16	40	110	16	H70
3NKR16	□	16	40	110	16	H70
GRFR16	□	16	40	110	16	H72
RFR16-AT	●	16	40	110	16	H60
RFR16	●	16	40	110	16	H62
2NKR16	●	16	40	110	16	H32
2AL16	●	16	40	110	16	H38
4NKRC16	●	16	40	110	16	H44
HKN16-AT	●	16	40	115	16	H46
ESMHN16	●	16	40	115	16	H50
HN16	□	16	40	115	16	H75
ESMQLS16	●	16	40	150	12	H64
LS16	□	16	40	155	12	H71
LQ16	□	16	40	155	12	H73
HKR16-AT	●	16	42	110	16	H46
ESMHKR16	●	16	42	110	16	H48
GRQR16	□	16	50	120	16	H73
RQR16-AT	●	16	50	125	16	H52
ESMQR16	●	16	50	125	16	H55
FQR16-AT	●	16	50	125	16	H58
GFQR16	□	16	50	125	16	H72
HQR16	●	16	50	125	16	H63
HKM16-AT	●	16	55	140	16	H46
ESMHKM16	●	16	55	140	16	H48
QL16X60	□	16	60	130	16	H74
RQL16-AT	●	16	65	125	16	H52
ESMQL16	●	16	65	125	16	H56
FQL16-AT	□	16	65	125	16	H72
GFQL16	□	16	65	125	16	H72
HQL16	●	16	65	125	16	H64
2ESMLC16	□	16	65	135	16	H23
2ESML16	●	16	65	135	16	H28
4ESMLC16	□	16	65	135	16	H41
4ESML16	●	16	65	135	16	H42
RFL16	□	16	65	135	16	H62
2NKL16	●	16	65	135	16	H34
4NKLC16	●	16	65	135	16	H45
4NKLE16	□	16	65	135	16	H70
HKL16-AT	●	16	65	140	16	H46
ESMHKL16	●	16	65	140	16	H48
2NKX16X80	□	16	80	135	16	H69
4NKX16X80	□	16	80	135	16	H71
QL16X80	□	16	80	150	16	H74
2NKX16X100	□	16	100	155	16	H69
4NKX16X100	□	16	100	155	16	H71
QL16X100	□	16	100	170	16	H74
2NKX16X120	□	16	120	190	16	H69
QL16X120	□	16	120	190	16	H74
2NKX16X150	□	16	150	220	16	H69
QL16X150	□	16	150	220	16	H74
2NKS16.1	□	16.1	35	115	20	H31
4NKRC16.1	□	16.1	40	120	20	H44
2NKS16.2	□	16.2	35	115	20	H31
4NKRC16.2	□	16.2	40	120	20	H44
2NKS16.3	□	16.3	35	115	20	H31
4NKRC16.3	□	16.3	40	120	20	H44

商品コード Item code	在庫 Stock	外径 Tool da.	刃長 Flute length	全長 Overall length	シャンク径 Shank dia.	ページ Page
2NKS16.4	□	16.4	35	115	20	H31
4NKRC16.4	□	16.4	40	120	20	H44
2ESMS16.5	□	16.5	35	115	20	H26
2NKS16.5	●	16.5	35	115	20	H31
2AL16.5	□	16.5	40	110	16	H38
2ESMR16.5	□	16.5	40	120	20	H27
2NKR16.5	●	16.5	40	120	20	H32
4NKRC16.5	□	16.5	40	120	20	H44
2NKL16.5	□	16.5	65	145	20	H34
4NKLC16.5	□	16.5	65	145	20	H45
4NKRC16.6	□	16.6	35	115	20	H31
4NKRC16.6	□	16.6	40	120	20	H44
2NKS16.7	□	16.7	35	115	20	H31
4NKRC16.7	□	16.7	40	120	20	H44
2NKS16.8	□	16.8	35	115	20	H31
4NKRC16.8	□	16.8	40	120	20	H44
2NKS16.9	□	16.9	35	115	20	H31
4NKRC16.9	□	16.9	40	120	20	H44
GCQS17	□	17	32	100	16	H72
2NER17-AT	●	17	35	105	16	H21
2ESMSC17	□	17	35	105	16	H23
2ESMS17	□	17	35	105	16	H26
2GNKS17	□	17	35	105	16	H69
2NKS17	●	17	35	105	16	H31
2ESMSUS17	●	17	35	115	20	H28
FQS17-AT	●	17	35	125	16	H58
GFQS17	□	17	35	125	16	H71
HQS17	●	17	35	125	16	H63
2NER17-AT	●	17	40	110	16	H21
2ESMRC17	●	17	40	110	16	H23
2ESMR17	●	17	40	110	16	H27
2GNKR17	□	17	40	110	16	H69
4NER17-AT	●	17	40	110	16	H40
4ESMRC17	●	17	40	110	16	H41
4ESMR17	●	17	40	110	16	H42
4GNKR17	□	17	40	110	16	H70
2NKR17	●	17	40	110	16	H32
2AL17	□	17	40	110	16	H38
4NKRC17	●	17	40	110	16	H44
ESMHN17	□	17	40	115	16	H50
3NKR17	□	17	40	120	20	H70
GRFR17	□	17	40	120	20	H72
RFR17	□	17	40	120	20	H62
GRQR17	□	17	50	120	16	H73
GFQR17	□	17	50	125	16	H72
HQR17	●	17	50	125	16	H63
QL17X60	□	17	60	140	20	H74
2ESML17	□	17	65	135	16	H28
4ESML17	□	17	65	135	16	H42
2NKL17	●	17	65	135	16	H34
4NKLC17	●	17	65	135	16	H45
4NKLE17	□	17	65	135	16	H70
4NKLC17X20	□	17	65	135	20	H45
RFL17	□	17	65	145	20	H62
QL17X80	□	17	80	150	20	H74
QL17X100	□	17	100	170	20	H74
2NKX17X100	□	17	100	180	20	H69
4NKX17X100	□	17	100	180	20	H71
QL17X120	□	17	120	190	20	H74
2NKS17.1	□	17.				

商品コード Item code	在庫 Stock	外径 Tool da.	刃長 Flute length	全長 Overall length	シャンク径 Shank dia.	ページ Page
QL18X80	□	18	80	160	20	H74
2NKX18X100	□	18	100	155	20	H69
4NKX18X100	□	18	100	155	20	H71
QL18X100	□	18	100	180	20	H74
2NKX18X120	□	18	120	200	20	H69
QL18X120	□	18	120	200	20	H74
QL18X150	□	18	150	230	20	H74
2NKS18.1	□	18.1	40	120	20	H31
4NKRC18.1	□	18.1	45	125	20	H44
2NKS18.2	□	18.2	40	120	20	H31
4NKRC18.2	□	18.2	45	125	20	H44
2NKS18.3	□	18.3	40	120	20	H31
4NKRC18.3	□	18.3	45	125	20	H44
2NKS18.4	□	18.4	40	120	20	H31
4NKRC18.4	□	18.4	45	125	20	H44
2AL18.5	□	18.5	40	110	16	H38
2ESMS18.5	□	18.5	40	120	20	H26
2NKS18.5	●	18.5	40	120	20	H31
2ESMR18.5	□	18.5	45	125	20	H27
2NKR18.5	●	18.5	45	125	20	H32
4NKRC18.5	□	18.5	45	125	20	H44
2NKL18.5	□	18.5	75	155	20	H34
4NKLC18.5	□	18.5	75	155	20	H45
2NKS18.6	□	18.6	40	120	20	H31
4NKRC18.6	□	18.6	45	125	20	H44
2NKS18.7	□	18.7	40	120	20	H31
4NKRC18.7	□	18.7	45	125	20	H44
2NKS18.8	□	18.8	40	120	20	H31
4NKRC18.8	□	18.8	45	125	20	H44
2NKS18.9	□	18.9	40	120	20	H31
4NKRC18.9	□	18.9	45	125	20	H44
GCQS19	□	19	32	100	16	H72
2AL19	□	19	40	110	16	H38
2NES19-AT	●	19	40	120	20	H21
2ESMSC19	□	19	40	120	20	H23
2ESMS19	□	19	40	120	20	H26
2ESMSUS19	●	19	40	120	20	H28
2GNKS19	□	19	40	120	20	H69
2NKS19	●	19	40	120	20	H31
FQS19-AT	●	19	40	140	16	H58
GFQS19	□	19	40	140	16	H71
HQS19	●	19	40	140	16	H63
2NER19-AT	●	19	45	125	20	H21
2ESMR19	□	19	45	125	20	H27
2GNKR19	□	19	45	125	20	H69
4NER19-AT	●	19	45	125	20	H40
4ESMR19	●	19	45	125	20	H42
4GNKR19	□	19	45	125	20	H70
3NKR19	□	19	45	125	20	H70
GRFR19	□	19	45	125	20	H72
RFR19	□	19	45	125	20	H62
2NKR19	●	19	45	125	20	H32
4NKRC19	●	19	45	125	20	H44
ESMHN19	□	19	45	130	16	H50
GRQR19	□	19	50	120	16	H73
GFQR19	□	19	55	140	16	H72
HQR19	●	19	55	140	16	H63
QL19X60	□	19	60	140	20	H74
2ESML19	□	19	75	155	20	H28
4ESML19	□	19	75	155	20	H42
RFL19	□	19	75	155	20	H62
2NKL19	●	19	75	155	20	H34
4NKLC19	●	19	75	155	20	H45
4NKLE19	□	19	75	155	20	H70
QL19X80	□	19	80	160	20	H74
2NKX19X100	□	19	100	180	20	H69
4NKX19X100	□	19	100	180	20	H71
QL19X100	□	19	100	180	20	H74
QL19X120	□	19	120	200	20	H74
2NKS19.1	□	19.1	40	120	20	H31
4NKRC19.1	□	19.1	45	125	20	H44
2NKS19.2	□	19.2	40	120	20	H31

商品コード Item code	在庫 Stock	外径 Tool da.	刃長 Flute length	全長 Overall length	シャンク径 Shank dia.	ページ Page
4NKRC19.2	□	19.2	45	125	20	H44
2NKS19.3	□	19.3	40	120	20	H31
4NKRC19.3	□	19.3	45	125	20	H44
2NKS19.4	□	19.4	40	120	20	H31
4NKRC19.4	□	19.4	45	125	20	H44
2AL19.5	□	19.5	40	110	16	H38
2ESMS19.5	□	19.5	40	120	20	H26
2NKS19.5	●	19.5	40	120	20	H31
2ESMR19.5	□	19.5	45	125	20	H27
2NKR19.5	●	19.5	45	125	20	H32
4NKRC19.5	□	19.5	45	125	20	H44
2NKL19.5	□	19.5	75	155	20	H34
4NKLC19.5	□	19.5	75	155	20	H45
2NKS19.6	□	19.6	40	120	20	H31
4NKRC19.6	□	19.6	45	125	20	H44
2NKS19.7	□	19.7	40	120	20	H31
4NKRC19.7	□	19.7	45	125	20	H44
2NKS19.8	□	19.8	40	120	20	H31
4NKRC19.8	□	19.8	45	125	20	H44
2NKS19.9	□	19.9	40	120	20	H31
4NKRC19.9	□	19.9	45	125	20	H44
ESMKH20	□	20	20	85	20	H75
ESMKN20	□	20	20	85	20	H75
ESMKNN20	□	20	20	85	20	H75
2NES20-AT	●	20	40	120	20	H21
2ESMSC20	●	20	40	120	20	H23
2ESMSUSC20	●	20	40	120	20	H25
2ESMS20	●	20	40	120	20	H26
2ESMSUS20	●	20	40	120	20	H28
2GNKS20	□	20	40	120	20	H69
GCQS20	□	20	40	120	20	H72
QS20	□	20	40	120	20	H73
2NKS20	●	20	40	120	20	H31
RQS20-AT	●	20	40	140	20	H52
ESMQS20	●	20	40	140	20	H55
FQS20-AT	●	20	40	140	20	H58
GFQS20	□	20	40	140	20	H71
HQS20	●	20	40	140	20	H63
HQLS20	●	20	40	200	16	H64
SRQ20×45	□	20	45	110	25	H75
2NER20-AT	●	20	45	125	20	H21
2ESMRC20	●	20	45	125	20	H23
2ESMR20	●	20	45	125	20	H27
2GNKR20	□	20	45	125	20	H69
4NER20-AT	●	20	45	125	20	H40
4ESMRC20	●	20	45	125	20	H41
4ESMR20	●	20	45	125	20	H42
4GNKR20	□	20	45	125	20	H70
3NKR20	□	20	45	125	20	H70
HKR20-AT	●	20	45	125	20	H46
ESMHKR20	●	20	45	125	20	H48
GRFR20	□	20	45	125	20	H72
RFR20-AT	●	20	45	125	20	H60
RFR20	●	20	45	125	20	H62
2NKR20	●	20	45	125	20	H32
2AL20	●	20	45	125	20	H38
4NKRC20	●	20	45	125	20	H44
HKN20-AT	●	20	45	130	20	H46
ESMHN20	●	20	45	130	20	H50
HN20	□	20	45	130	20	H75
LS20	□	20	45	185	16	H71
LQ20	□	20	45	185	16	H73
ESMQLS20	●	20	45	200	16	H56
GRQR20	□	20	55	135	20	H73
GQR20	□	20	55	135	20	H73
QR20	□	20	55	135	20	H73
QRT20	□	20	55	135	MT2	H74
RQR20-AT	●	20	55	140	20	H52
ESMQR20	●	20	55	140	20	H55
FQR20-AT	●	20	55	140	20	H58
GFQR20	□	20	55	140	20	H72
HQR20	●	20	55	140	20	H63

商品コード Item code	在庫 Stock	外径 Tool da.	刃長 Flute length	全長 Overall length	シャンク径 Shank dia.	ページ Page
QL20X60	□	20	60	140	20	H74
HKM20-AT	●	20	65	165	20	H46
ESMHKM20	●	20	65	165	20	H48
RQL20-AT	●	20	75	140	20	H52
ESMQL20	●	20	75	140	20	H56
FQL20-AT	□	20	75	140	20	H72
GFQL20	□	20	75	140	20	H72
HQL20	●	20	75	140	20	H64
SRQ20×75	□	20	75	140	25	H75
2ESMLC20	□	20	75	155	20	H23
2ESML20	●	20	75	155	20	H28
4ESMLC20	□	20	75	155	20	H41
4ESML20	●	20	75	155	20	H42
RFL20	●	20	75	155	20	H62
2NKL20	●	20	75	155	20	H34
4NKLC20	●	20	75	155	20	H45
4NKLE20	□	20	75	155	20	H70
QL20X80	□	20	80	160	20	H74
QL20X100	□	20	85	165	20	H46
HKL20-AT	●	20	85	165	20	H48
ESMHKL20	●	20	85	165	20	H48
2NKX20X100	□	20	100	165	20	H69
4NKX20X100	□	20	100	165	20	H71
SRQ20×100	□	20	100	165	25	H75
HQL20	●	20	100	180	20	H64
QL20X100	□	20	100	180	20	H74
2NKX20X120	□	20	120	185	20	H69
4NKX20X120	□	20	120	185	20	H71
QL20X120	□	20	120	200	20	H74
2NKX20X150	□	20	150	230	20	H69
4NKX20X150	□	20	150	230	20	H71
QL20X150	□	20	150	230	20	H74
2NKR20.1	□	20.1	45	135	25	H32
2NKR20.2	□	20.2	45	135	25	H32
2NKR20.3	□	20.3	45	135	25	H32
2NKR20.4	□	20.4	45	135	25	H32
2AL20.5	□	20.5	45	125	20	H38
2NKR20.5	□	20.5	45	135	25	H32
4NKRC20.5	□	20.5	45	135	25	H44
2NKL20.5	□	20.5	75	165	20	H34
4NKLC20.5	□	20.5	75	165	25	H45
2NKR20.6	□	20.6	45	135	25	H32
2NKR20.7	□	20.7	45	135	25	H32
2NKR20.8	□	20.8	45	135	25	H32
2NKR20.9	□	20.9	45	135	25	H32
2ESMSC21	□	21	40	120	20	H23
2ESMS21	□	21	40	120	20	H26
2ESMSUS21	□	21	40	120	20	H28
GCQS21	□	21	40	120	20	H72
FQS21-AT	●	21	40	140	20	H58
GFQS21	□	21	40	140	20	H71
HQS21	●	21	40	140	20	H63
2NER21-AT	●	21	45	125	20	H21
2ESMR21	□	21	45	125	20	H27
2GNKR21	□	21	45	125	20	H69
4NER21-AT	●	21	45	125	20	H40
4ESMR21	□	21	45	125	20	H42
4GNKR21	□	21	45	125	20	H70
2NKR21	●	21	45	125	20	H32
2AL21	□	21	45	125	20	H38
4NKRC21	●	21	45			

外径別寸法早見表

ハイスエンドミル・スクエア

HSS End Mills - Square

商品コード Item code	在庫 Stock	外径 Tool da.	刃長 Flute length	全長 Overall length	シャンク径 Shank dia.	ページ Page
4NKLC22X25	□	22	75	155	25	H45
RFL22	□	22	75	165	25	H62
QL22X80	□	22	80	170	25	H74
SRQ22×100	□	22	100	165	25	H75
2NKX22X100	□	22	100	190	25	H69
4NKX22X100	□	22	100	190	25	H71
QL22X100	□	22	100	190	25	H74
2NKX22X120	□	22	120	185	25	H69
4NKX22X120	□	22	120	185	25	H71
QL22X120	□	22	120	210	25	H74
2NKX22X150	□	22	150	240	25	H69
4NKX22X150	□	22	150	240	25	H71
QL22X150	□	22	150	240	25	H74
2NKR22.1	□	22.1	50	140	25	H32
2NKR22.2	□	22.2	50	140	25	H32
2NKR22.3	□	22.3	50	140	25	H32
2NKR22.4	□	22.4	50	140	25	H32
2AL22.5	□	22.5	45	125	20	H38
2NKR22.5	□	22.5	50	140	25	H32
4NKRC22.5	□	22.5	50	140	25	H44
4NKLC22.5	□	22.5	90	180	25	H45
2NKR22.6	□	22.6	50	140	25	H32
2NKR22.7	□	22.7	50	140	25	H32
2NKR22.8	□	22.8	50	140	25	H32
2NKR22.9	□	22.9	50	140	25	H32
GCQS23	□	23	45	125	20	H72
2AL23	□	23	45	125	20	H38
FQS23-AT	●	23	45	160	20	H58
GFQS23	□	23	45	160	20	H71
HQS23	●	23	45	160	20	H63
2ESMSC23	□	23	50	120	25	H23
2ESMS23	□	23	50	120	25	H26
2ESMSUS23	□	23	50	120	25	H28
4ESMR23	□	23	50	125	25	H42
ESMHN23	□	23	50	140	20	H50
2NER23-AT	●	23	50	140	25	H21
2ESMR23	□	23	50	140	25	H27
2GNKR23	□	23	50	140	25	H69
4NER23-AT	●	23	50	140	25	H40
4GNKR23	□	23	50	140	25	H70
3NKR23	□	23	50	140	25	H70
GRFR23	□	23	50	140	25	H72
RFR23	□	23	50	140	25	H62
2NKR23	●	23	50	140	25	H32
4NKRC23	●	23	50	140	25	H44
QR23	□	23	55	145	25	H73
GRQR23	□	23	60	140	20	H73
GFQR23	□	23	70	160	20	H72
HQR23	●	23	70	160	20	H63
QL23X80	□	23	80	170	25	H74
2ESML23	□	23	90	180	25	H28
4ESML23	□	23	90	180	25	H42
RFL23	□	23	90	180	25	H62
2NKL23	□	23	90	180	25	H34
4NKLC23	□	23	90	180	25	H45
4NKLE23	□	23	90	180	25	H70
2NKX23X100	□	23	100	190	25	H69
4NKX23X100	□	23	100	190	25	H71
QL23X100	□	23	100	190	25	H74
2NKX23X120	□	23	120	210	25	H69
4NKX23X120	□	23	120	210	25	H71
QL23X120	□	23	120	210	25	H74
2NKX23X150	□	23	150	240	25	H69
4NKX23X150	□	23	150	240	25	H71
QL23X150	□	23	150	240	25	H74
2NKR23.1	□	23.1	50	140	25	H32
2NKR23.2	□	23.2	50	140	25	H32
2NKR23.3	□	23.3	50	140	25	H32
2NKR23.4	□	23.4	50	140	25	H32
2AL23.5	□	23.5	45	125	20	H38
2NKR23.5	□	23.5	50	140	25	H32
4NKRC23.5	□	23.5	50	140	25	H44

商品コード Item code	在庫 Stock	外径 Tool da.	刃長 Flute length	全長 Overall length	シャンク径 Shank dia.	ページ Page
4NKLC23.5	□	23.5	90	180	25	H45
2NKR23.6	□	23.6	50	140	25	H32
2NKR23.7	□	23.7	50	140	25	H32
2NKR23.8	□	23.8	50	140	25	H32
2NKR23.9	□	23.9	50	140	25	H32
GCQS24	□	24	45	125	20	H72
FQS24-AT	●	24	45	160	20	H58
GFQS24	□	24	45	160	20	H71
HQS24	●	24	45	160	25	H63
2ESMSC24	□	24	50	120	25	H23
2ESMS24	□	24	50	120	25	H26
2ESMSUS24	□	24	50	120	25	H28
4ESMRC24	●	24	50	125	25	H41
4ESMR24	●	24	50	125	25	H42
ESMHN24	□	24	50	140	20	H50
2NER24-AT	●	24	50	140	25	H21
2ESMRC24	●	24	50	140	25	H23
2ESMR24	●	24	50	140	25	H27
2GNKR24	□	24	50	140	25	H69
4NER24-AT	●	24	50	140	25	H40
4GNKR24	□	24	50	140	25	H70
3NKR24	□	24	50	140	25	H70
HN24	□	24	50	140	25	H75
GRFR24	□	24	50	140	25	H72
RFR24	□	24	50	140	25	H62
2NKR24	●	24	50	140	25	H32
2AL24	□	24	50	140	25	H38
4NKRC24	●	24	50	140	25	H44
LS24	□	24	50	190	20	H71
GRQR24	□	24	60	140	20	H73
FQR24-AT	●	24	70	160	20	H58
GFQR24	□	24	70	160	20	H72
HQR24	●	24	70	160	25	H63
QR24	□	24	70	160	25	H73
QL24X80	□	24	80	170	25	H74
2ESML24	□	24	90	180	25	H28
4ESML24	□	24	90	180	25	H42
RFL24	□	24	90	180	25	H62
2NKL24	●	24	90	180	25	H34
4NKLC24	●	24	90	180	25	H45
4NKLE24	□	24	90	180	25	H70
2NKX24X100	□	24	100	190	25	H69
4NKX24X100	□	24	100	190	25	H71
QL24X100	□	24	100	190	25	H74
2NKX24X120	□	24	120	190	25	H69
4NKX24X120	□	24	120	190	25	H71
QL24X120	□	24	120	210	25	H74
2NKX24X150	□	24	150	240	25	H69
4NKX24X150	□	24	150	240	25	H71
QL24X150	□	24	150	240	25	H74
2NKR24.1	□	24.1	50	140	25	H32
2NKR24.2	□	24.2	50	140	25	H32
2NKR24.3	□	24.3	50	140	25	H32
2NKR24.4	□	24.4	50	140	25	H32
2NKR24.5	□	24.5	50	140	25	H32
2AL24.5	□	24.5	50	140	25	H38
4NKRC24.5	□	24.5	50	140	25	H44
4NKLC24.5	□	24.5	90	180	25	H45
2NKR24.6	□	24.6	50	140	25	H32
2NKR24.7	□	24.7	50	140	25	H32
2NKR24.8	□	24.8	50	140	25	H32
2NKR24.9	□	24.9	50	140	25	H32
RQS25-AT	●	25	45	160	25	H52
5ESMQS25	□	25	45	160	25	H55
ESMQS25	●	25	45	160	25	H55
FQS25-AT	●	25	45	160	25	H58
GFQS25	□	25	45	160	25	H71
HQS25	●	25	45	160	25	H63
HQL25	●	25	45	225	20	H64
SRQ25×50	□	25	50	115	25	H75
2ESMSC25	□	25	50	120	25	H23
2ESMS25	□	25	50	120	25	H26

商品コード Item code	在庫 Stock	外径 Tool da.	刃長 Flute length	全長 Overall length	シャンク径 Shank dia.	ページ Page
2ESMSUS25	●	25	50	120	25	H28
4ESMRC25	●	25	50	125	25	H41
4ESMR25	●	25	50	125	25	H42
2NER25-AT	●	25	50	140	25	H21
2ESMRC25	●	25	50	140	25	H23
2ESMR25	●	25	50	140	25	H27
2GNKR25	□	25	50	140	25	H69
4NER25-AT	●	25	50	140	25	H40
4GNKR25	□	25	50	140	25	H70
3NKR25	□	25	50	140	25	H70
HKN25-AT	●	25	50	140	25	H46
HKR25-AT	●	25	50	140	25	H46
ESMHKR25	●	25	50	140	25	H48
ESMHN25	●	25	50	140	25	H50
HN25	□	25	50	140	25	H75
GRFR25	□	25	50	140	25	H72
RFR25-AT	●	25	50	140	25	H60
RFR25	●	25	50	140	25	H62
GCQS25	□	25	50	140	25	H72
QS25	□	25	50	140	25	H73
2NKR25	●	25	50	140	25	H32
2AL25	●	25	50	140	25	H38
4NKRC25	●	25	50	140	25	H44
LS25	□	25	50	220	20	H71
LQ25	□	25	50	220	20	H73
ESMQLS25	●	25	50	225	20	H56
RQR25-AT	●	25	70	160	25	H52
ESMQR25	●	25	70	160	25	H55
FQR25-AT	●	25	70	160	25	H58
GFQR25	□	25	70	160	25	H72
HQR25	●	25	70	160	25	H63
GRQR25	□	25	70	160	25	H73
QQR25	□	25	70	160	25	H73
QR25	□	25	70	160	25	H73
QRT25	□	25	70	170	MT3	H74
HKM25-AT	●	25	75	195	25	H46
ESMHKM25	●	25	75	195	25	H48
QL25X80	□	25	80	170	25	H74
SRQ25×90	□	25	90	155	25	H75
RQL25-AT	●	25	90	165	25	H52
ESMQL25	●	25	90	165	25	H56
FQL25-AT	●	25	90	165	25	H72
GFQL25	□	25	90	165	25	H72
HQL25	●	25	90	165	25	H64
2ESMLC25	□	25	90	180	25	H23
2ESML25	●	25	90	180	25	H28
4ESMLC25	□	25	90	180	25	H41
4ESML25	●	25	90	180	25	H42
RFL25	●	25	90	180	25	H62
2NKL25	●	25	90	180	25	H34
4NKLC25	●	25	90	180	25	H45
4NKLE25	□	25	90	180	25	H70
2NKX25X100	□	25	100	190	25	H69
4NKX25X100	□	25	100	190	25	H71
QL25X100	□	25	100	190	25	H74
HKL25-AT	●	25	100	195	25	H46
ESMHKL25	●	25	100	195	25	H48
SRQ25×120	□	25	120	185	25	H75
2NKX25X120	□	25				

商品コード Item code	在庫 Stock	外径 Tool da.	刃長 Flute length	全長 Overall length	シャンク径 Shank dia.	ページ Page
RFR27	□	27	55	145	25	H62
GCQS27	□	27	55	145	25	H72
2NKR27	●	27	55	145	25	H32
4NKRC27	●	27	55	145	25	H44
GRQR27	□	27	70	160	25	H73
QR27	□	27	70	170	32	H73
GFQR27	□	27	75	160	25	H72
QL27X80	□	27	80	170	25	H74
2ESML27	□	27	90	180	25	H28
4ESML27	□	27	90	180	25	H42
RFL27	□	27	90	180	25	H62
2NKL27	□	27	90	180	25	H34
4NKLC27	□	27	90	180	25	H45
4NKLE27	□	27	90	180	25	H70
QL27X100	□	27	100	190	25	H74
QL27X120	□	27	120	210	25	H74
QL27X150	□	27	150	240	25	H74
2NKR27.1	□	27.1	55	145	25	H32
2NKR27.2	□	27.2	55	145	25	H32
2NKR27.3	□	27.3	55	145	25	H32
2NKR27.4	□	27.4	55	145	25	H32
2AL27.5	□	27.5	50	140	25	H38
2NKR27.5	□	27.5	55	145	25	H32
4NKRC27.5	□	27.5	90	180	25	H45
2NKR27.6	□	27.6	55	145	25	H32
2NKR27.7	□	27.7	55	145	25	H32
2NKR27.8	□	27.8	55	145	25	H32
2NKR27.9	□	27.9	55	145	25	H32
RQS28-AT	●	28	45	160	25	H52
5ESMQS28	□	28	45	160	25	H55
ESMQS28	●	28	45	160	25	H55
FQS28-AT	●	28	45	160	25	H58
GFQS28	□	28	45	160	25	H71
HQS28	●	28	45	160	25	H63
HQLS28	●	28	45	250	25	H64
ESMQLS28	●	28	50	250	25	H56
SRQ28×55	□	28	55	120	25	H75
2ESMSC28	□	28	55	125	25	H23
2ESMS28	□	28	55	125	25	H26
2ESMSUS28	□	28	55	125	25	H28
4ESMRC28	●	28	55	125	25	H41
4ESMR28	●	28	55	125	25	H42
2NER28-AT	●	28	55	145	25	H21
2ESMRC28	●	28	55	145	25	H23
2ESMR28	□	28	55	145	25	H27
2GNKR28	□	28	55	145	25	H69
4NER28-AT	●	28	55	145	25	H40
4GNKR28	□	28	55	145	25	H70
3NKR28	□	28	55	145	25	H70
GRFR28	□	28	55	145	25	H72
RFR28	□	28	55	145	25	H62
GCQS28	□	28	55	145	25	H72
2NKR28	●	28	55	145	25	H32
2AL28	□	28	55	145	25	H38
4NKRC28	●	28	55	145	25	H44
ESMHN28	□	28	55	150	25	H50
HN28	□	28	55	150	32	H75
LS28	□	28	55	220	25	H71
QR28	□	28	70	170	32	H73
GFQR28	□	28	75	160	25	H72
HQR28	●	28	75	160	25	H63
GRQR28	□	28	80	170	25	H73
QL28X80	□	28	80	180	32	H74
SRQ28×90	□	28	90	155	25	H75
ESMQL28	●	28	90	165	25	H56
FQL28-AT	□	28	90	165	25	H72
GFQL28	□	28	90	165	25	H72
HQL28	●	28	90	165	25	H64
2ESML28	□	28	90	180	25	H28
4ESML28	□	28	90	180	25	H42
RFL28	□	28	90	180	25	H62

商品コード Item code	在庫 Stock	外径 Tool da.	刃長 Flute length	全長 Overall length	シャンク径 Shank dia.	ページ Page
2NKL28	●	28	90	180	25	H34
4NKLC28	●	28	90	180	25	H45
4NKLE28	□	28	90	180	25	H70
QL28X100	□	28	100	200	32	H74
SRQ28×120	□	28	120	185	25	H75
2NKX28X120	□	28	120	210	25	H69
4NKX28X120	□	28	120	210	25	H71
QL28X120	□	28	120	220	32	H74
2NKX28X150	□	28	150	220	25	H69
4NKX28X150	□	28	150	220	25	H71
QL28X150	□	28	150	250	32	H74
2NKR28.1	□	28.1	55	145	25	H32
2NKR28.2	□	28.2	55	145	25	H32
2NKR28.3	□	28.3	55	145	25	H32
2NKR28.4	□	28.4	55	145	25	H32
2NKR28.5	□	28.5	55	145	25	H32
2AL28.5	□	28.5	55	145	25	H38
4NKRC28.5	□	28.5	55	145	25	H44
4NKLC28.5	□	28.5	90	180	25	H45
2NKR28.6	□	28.6	55	145	25	H32
2NKR28.7	□	28.7	55	145	25	H32
2NKR28.8	□	28.8	55	145	25	H32
2NKR28.9	□	28.9	55	145	25	H32
GFQS29	□	29	45	160	25	H71
2ESMS29	□	29	55	125	25	H26
2ESMSUS29	□	29	55	125	25	H28
4ESMR29	□	29	55	125	25	H42
2NER29-AT	●	29	55	145	25	H21
2ESMR29	□	29	55	145	25	H27
2GNKR29	□	29	55	145	25	H69
4NER29-AT	●	29	55	145	25	H40
4GNKR29	□	29	55	145	25	H70
3NKR29	□	29	55	145	25	H70
GRFR29	□	29	55	145	25	H72
RFR29	□	29	55	145	25	H62
GCQS29	□	29	55	145	25	H72
2NKR29	●	29	55	145	25	H32
2AL29	□	29	55	145	25	H38
4NKRC29	●	29	55	145	25	H44
GFQR29	□	29	80	160	25	H72
GRQR29	□	29	80	170	25	H73
QR29	□	29	80	180	32	H73
2ESML29	□	29	90	180	25	H28
4ESML29	□	29	90	180	25	H42
RFL29	□	29	90	180	25	H62
2NKL29	□	29	90	180	25	H34
4NKLC29	□	29	90	180	25	H45
4NKLE29	□	29	90	180	25	H70
QL29X100	□	29	100	200	32	H74
QL29X120	□	29	120	220	32	H74
QL29X150	□	29	150	250	32	H74
2NKR29.1	□	29.1	55	145	25	H32
2NKR29.2	□	29.2	55	145	25	H32
2NKR29.3	□	29.3	55	145	25	H32
2NKR29.4	□	29.4	55	145	25	H32
2NKR29.5	□	29.5	55	145	25	H32
2AL29.5	□	29.5	55	145	25	H38
4NKRC29.5	□	29.5	55	145	25	H44
4NKLC29.5	□	29.5	90	180	25	H45
2NKR29.6	□	29.6	55	145	25	H32
2NKR29.7	□	29.7	55	145	25	H32
2NKR29.8	□	29.8	55	145	25	H32
2NKR29.9	□	29.9	55	145	25	H32
RQS30-AT	●	30	45	160	25	H52
6ESMQS30	□	30	45	160	25	H55
ESMQS30	●	30	45	160	25	H55
FQS30-AT	●	30	45	160	25	H58
GFQS30	□	30	45	160	25	H71
HQS30	●	30	45	160	25	H63
HQLS30	●	30	45	250	25	H64
SRQ30×55	□	30	55	120	25	H75
2ESMSC30	□	30	55	125	25	H23

商品コード Item code	在庫 Stock	外径 Tool da.	刃長 Flute length	全長 Overall length	シャンク径 Shank dia.	ページ Page
2ESMS30	□	30	55	125	25	H26
2ESMSUS30	●	30	55	125	25	H28
4ESMRC30	●	30	55	125	25	H41
4ESMR30	●	30	55	125	25	H42
DSH30×55	□	30	55	135	32	H75
DSQ30×55	□	30	55	135	32	H74
2NER30-AT	●	30	55	145	25	H21
2ESMRC30	●	30	55	145	25	H23
2ESMR30	●	30	55	145	25	H27
2GNKR30	□	30	55	145	25	H69
4NER30-AT	●	30	55	145	25	H40
4GNKR30	□	30	55	145	25	H70
3NKR30	□	30	55	145	25	H70
HKR30-AT	●	30	55	145	25	H46
ESMHKR30	●	30	55	145	25	H48
GRFR30	□	30	55	145	25	H72
RFR30-AT	●	30	55	145	25	H60
RFR30	●	30	55	145	25	H62
GCQS30	□	30	55	145	25	H72
2NKR30	●	30	55	145	25	H32
2AL30	●	30	55	145	25	H38
4NKRC30	●	30	55	145	25	H44
ESMHKR30X32	●	30	55	145	32	H48
HKN30-AT	●	30	55	150	25	H46
ESMHN30	●	30	55	150	25	H50
HN30	□	30	55	150	32	H75
QS30	□	30	55	155	32	H73
LS30	□	30	55	220	25	H71
LQ30	□	30	55	220	25	H73
ESMQLS30	●	30	55	250	25	H56
RQR30-AT	●	30	80	160	25	H52
ESMQR30	●	30	80	160	25	H55
FQR30-AT	●	30	80	160	25	H58
GFQR30	□	30	80	160	25	H72
HQR30	●	30	80	160	25	H63
GRQR30	□	30	80	170	25	H73
GQR30	□	30	80	180	32	H73
QR30	□	30	80	180	32	H73
HKM30-AT	●	30	80	200	25	H46
ESMHKM30	●	30	80	200	25	H48
ESMHKM30X32	●	30	80	200	32	H48
QRT30	□	30	80	205	MT4	H74
SRQ30×90	□	30	90	155	25	H75
RQL30-AT	●	30	90	165	25	H52
ESMQL30	●	30	90	165	25	H56
FQL30-AT	□	30	90	165	25	H72
GFQL30	□	30	90	165	25	H72
HQL30	●	30	90	165	25	H64
DSH30×90	□	30	90	170	32	H75
DSQ30×90	□	30	90	170	32	H74
2ESMLC30	□	30	90	180	25	H23
2ESML30	●	30	90	180	25	H28
4ESMLC30	□	30	90	180	25	H41
4ESML30	●	30	90	180	25	H42
RFL30	●	30	90	180	25	H62
2NKL30	●	30	90	180	25	H34
4NKLC30	●	30	90	180	25	H45
4NKLE30	□	30	90	180	25	H70
QL30X100	□	30	100	200	32	H74
HKL30-AT	●	30	105	200	25	H46
ESMHKL30	●	30	105	200	25	H48
ESMHKL30X32	●	30	105	200	32	H48
SRQ30×120	□	30	120	185	25	H75
DSQ30×120	□	30	120	200	32	

外径別寸法早見表

ハイスエンドミル・スクエア

HSS End Mills - Square

商品コード Item code	在庫 Stock	外径 Tool da.	刃長 Flute length	全長 Overall length	シャンク径 Shank dia.	ページ Page	商品コード Item code	在庫 Stock	外径 Tool da.	刃長 Flute length	全長 Overall length	シャンク径 Shank dia.	ページ Page	商品コード Item code	在庫 Stock	外径 Tool da.	刃長 Flute length	全長 Overall length	シャンク径 Shank dia.	ページ Page	商品コード Item code	在庫 Stock	外径 Tool da.	刃長 Flute length	全長 Overall length	シャンク径 Shank dia.	ページ Page
4ESMR33	□	33	60	160	32	H42	HQR35	●	35	90	180	32	H63	GRQR37	□	37	90	190	32	H73	2NKR40X32	●	40	65	165	32	H33
4GNKR33	□	33	60	160	32	H70	GRQR35	□	35	90	190	32	H73	2ESML37	□	37	100	200	32	H28	4NKR40	□	40	65	165	32	H70
GRFR33	□	33	60	160	32	H72	GQR35	□	35	90	190	32	H73	4ESML37	□	37	100	200	32	H42	4NKR40	●	40	65	165	32	H44
RFR33	□	33	60	160	32	H62	QR35X32	□	35	90	190	32	H73	RFL37	□	37	100	200	32	H62	RQS40-AT	●	40	65	200	32	H52
GCQS33	□	33	60	160	32	H72	QR35X42	□	35	90	200	42	H73	2NKL37	□	37	100	200	32	H34	ESMQS40	●	40	65	200	32	H55
2NKR33	●	33	60	160	32	H32	QRT35	□	35	90	215	MT4	H74	4NKL37	□	37	100	200	32	H45	GFQS40	□	40	65	200	32	H71
4NKRE33	□	33	60	160	32	H70	DSH35×100	□	35	100	180	32	H75	QR37	□	37	100	200	32	H73	HQS40	●	40	65	200	32	H63
4NKRC33	□	33	60	160	32	H44	DSQ35×100	□	35	100	180	32	H74	2NKR37.5	□	37.5	65	165	32	H33	LS40	□	40	65	285	32	H71
QR33X80	□	33	80	180	32	H73	2ESML35	□	35	100	200	32	H28	2NER38-AT	●	38	65	165	32	H21	LQ40	□	40	65	285	32	H73
GFQR33	□	33	90	180	32	H72	4ESML35	●	35	100	200	32	H42	2ESMR38	□	38	65	165	32	H27	ESMQLS40	●	40	65	300	32	H56
GRQR33	□	33	90	190	32	H73	RFL35	□	35	100	200	32	H62	2GNKR38	□	38	65	165	32	H69	HQLS40	●	40	65	300	32	H64
QR33X90	□	33	90	190	32	H73	2NKL35	●	35	100	200	32	H34	4ESMR38	□	38	65	165	32	H42	DSH40×75	□	40	75	155	32	H75
2ESML33	□	33	95	195	32	H28	4NKL35	●	35	100	200	32	H45	4GNKR38	□	38	65	165	32	H70	DSQ40×75	□	40	75	155	32	H74
4ESML33	□	33	95	195	32	H42	4NKLE35	□	35	100	200	32	H70	GRFR38	□	38	65	165	32	H72	DSH40×100	□	40	100	180	32	H75
RFL33	□	33	95	195	32	H62	QL35X100	□	35	100	200	42	H74	RFR38	□	38	65	165	32	H62	DSQ40×100	□	40	100	180	32	H74
2NKL33	□	33	95	195	32	H34	RQL35-AT	●	35	110	190	32	H52	GCQS38	□	38	65	165	32	H72	RQR40-AT	●	40	100	200	32	H52
4NKL33	□	33	95	195	32	H45	FQL35-AT	□	35	110	190	32	H72	2NKR38	●	38	65	165	32	H33	GFQR40	□	40	100	200	32	H72
4NKLE33	□	33	95	195	32	H70	GFQL35	□	35	110	190	32	H72	4NKR38	□	38	65	165	32	H70	HQR40	●	40	100	200	32	H63
QL33X100	□	33	100	200	32	H74	HQL35	●	35	110	190	32	H64	4NKR38	□	38	65	165	32	H70	GRQR40	□	40	100	200	32	H73
QL33X120	□	33	120	220	32	H74	QL35X120	□	35	120	230	42	H74	4NKR38	●	38	65	165	32	H44	GRQR40	□	40	100	200	32	H73
QL33X150	□	33	150	250	32	H74	DSQ35×125	□	35	125	205	32	H74	GFQS38	□	38	65	200	32	H71	QR40X32	□	40	100	200	32	H73
2NKR33.5	□	33.5	60	160	32	H32	HQXL35×125	●	35	125	225	32	H64	LS38	□	38	65	285	32	H71	QR40X42	□	40	100	210	42	H73
GFQS34	□	34	55	180	32	H71	2NKX35X150	□	35	150	235	32	H69	GFQR38	□	38	100	200	32	H72	QRT40	□	40	100	225	MT4	H74
2NER34-AT	●	34	60	160	32	H21	4NKX35X150	□	35	150	235	32	H71	GRQR38	□	38	100	200	32	H73	2ESML40	□	40	110	210	32	H28
2ESMR34	□	34	60	160	32	H27	HQXL35×150	●	35	150	250	32	H64	QR38	□	38	100	200	32	H73	4ESML40	●	40	110	210	32	H42
2GNKR34	□	34	60	160	32	H69	QL35X150	□	35	150	260	42	H74	2ESML38	□	38	105	205	32	H28	RFL40	□	40	110	210	32	H62
4ESMR34	□	34	60	160	32	H42	2NKX35X200	□	35	200	300	32	H69	4ESML38	□	38	105	205	32	H42	2NKL40X32	●	40	110	210	32	H34
4GNKR34	□	34	60	160	32	H70	4NKX35X200	□	35	200	300	32	H71	RFL38	□	38	105	205	32	H62	4NKL40X32	●	40	110	210	32	H45
GRFR34	□	34	60	160	32	H72	QL35X200	□	35	200	310	42	H74	2NKL38	□	38	105	205	32	H34	4NKL40X32	□	40	110	210	32	H70
RFR34	□	34	60	160	32	H62	2NKX35X250	□	35	250	350	32	H69	4NKL38	□	38	105	205	32	H45	QL40X120	□	40	120	230	42	H74
GCQS34	□	34	60	160	32	H72	4NKX35X250	□	35	250	350	32	H71	4NKL38	□	38	105	205	32	H70	RQL40-AT	●	40	125	205	32	H52
2NKR34	●	34	60	160	32	H32	2NKR35.5	□	35.5	60	160	32	H32	QL38X120	□	38	120	230	42	H74	ESML40	□	40	125	205	32	H56
4NKR34	□	34	60	160	32	H70	GFQS36	□	36	55	180	32	H71	2NKX38X150	□	38	150	235	32	H69	GFQL40	□	40	125	205	32	H72
4NKRC34	●	34	60	160	32	H44	2NER36-AT	●	36	60	160	32	H21	4NKX38X150	□	38	150	235	32	H71	HQL40	●	40	125	205	32	H64
LS34	□	34	60	235	32	H71	2ESMR36	□	36	60	160	32	H27	QL38X150	□	38	150	260	42	H74	DSQ40×125	□	40	125	205	32	H74
GFQR34	□	34	90	180	32	H72	2GNKR36	□	36	60	160	32	H69	2NKX38X200	□	38	200	300	32	H69	2NKX40X150X32	□	40	150	235	32	H69
GRQR34	□	34	90	190	32	H73	4ESMR36	□	36	60	160	32	H42	4NKX38X200	□	38	200	300	32	H71	4NKX40X150	□	40	150	235	32	H71
QR34	□	34	90	190	32	H73	4GNKR36	□	36	60	160	32	H70	QL38X200	□	38	200	310	42	H74	2NKX40X150	□	40	150	260	42	H69
2ESML34	□	34	95	195	32	H28	GRFR36	□	36	60	160	32	H72	2NKX38X250	□	38	250	350	32	H69	QL40X150	□	40	150	260	42	H74
4ESML34	□	34	95	195	32	H42	RFR36	□	36	60	160	32	H62	4NKX38X250	□	38	250	350	32	H71	HQXL40	●	40	180	280	32	H64
RFL34	□	34	95	195	32	H62	GCQS36	□	36	60	160	32	H72	2NKR38.5	□	38.5	65	165	32	H33	2NKX40X200X32	□	40	200	300	32	H69
2NKL34	□	34	95	195	32	H34	2NKR36	●	36	60	160	32	H32	2NER39-AT	●	39	65	165	32	H21	4NKX40X200X32	□	40	200	300	32	H71
4NKL34	□	34	95	195	32	H45	4NKR36	□	36	60	160	32	H70	2ESMR39	□	39	65	165	32	H27	2NKX40X200	□	40	200	310	42	H69
4NKLE34	□	34	95	195	32	H70	4NKRC36	●	36	60	160	32	H44	2GNKR39	□	39	65	165	32	H69	4NKX40X200	□	40	200	310	42	H71
QL34X100	□	34	100	200	32	H74	GFQR36	□	36	90	180	32	H72	4ESMR39	□	39	65	165	32	H42	QL40X200	□	40	200	310	42	H74
QL34X120	□	34	120	220	32	H74	GRQR36	□	36	90	190	32	H73	4GNKR39	□	39	65	165	32	H70	2NKX40X250X32	□	40	250	350	32	H69
QL34X150	□	34	150	250	32	H74	2ESML36	□	36	100	200	32	H28	RFR39	□	39	65	165	32	H72	4NKX40X250X32	□	40	250	350	32	H71
2NKR34.5	□	34.5	60	160	32	H32	4ESML36	□	36	100	200	32	H42	GCQS39	□	39	65	165	32	H72	2NKX40X250	□	40	250	360	42	H69
RQS35-AT	●	35	55	180	32	H52	RFL36	□	36	100	200	32	H62	2NKR39	●	39	65	165	32	H33	4NKX40X250	□	40	250	360	42	H71
ESMQS35	●	35	55	180	32	H55	2NKL36	□	36	100	200	32	H34	4NKR39	□	39	65	165	32	H70	QL40X250	□	40	250	360	42	H74
GFQS35-AT	●	35	55	180	32	H58	4NKL36	□	36	100	200	32	H45	4NKR39	□	39	65	165	32	H70	QL40X300	□	40	300	410	42	H74
GFQS35	□	35	55	180	32	H71	4NKLE36	□	36	100	200	32	H70	4NKR39	□	39	65	165	32	H44	2NKR40.5X32	□	40.5	65	165	32	H33
HQS35	●	35	55	180	32	H63	QR36	□	36	100	200	32	H73	GFQS39	□	39	65	200	32	H71	2NKR41X32	□	41	65	165	32	H33
2NER35-AT	●	35	60	160	32	H21	2NKX36X120	□	36	120	205	32	H69	GFQR39	□	39	100	200	32	H72	4NKRE41×32	□	41	65	165	32	H70
2ESMR35	□	35	60	160	32	H27	4NKX36X120	□	36																		

商品コード Item code	在庫 Stock	外径 Tool da.	刃長 Flute length	全長 Overall length	シャンク径 Shank dia.	ページ Page
2NKL42X32	□	42	110	210	32	H34
4NKL42X32	□	42	110	210	32	H70
RFL42	□	42	110	220	42	H62
QL42X150	□	42	150	260	42	H74
QL42X200	□	42	200	310	42	H74
QL42X250	□	42	250	360	42	H74
2NKR42.5X32	□	42.5	70	170	32	H33
2NKR43X32	□	43	70	170	32	H33
4NKRE43×32	□	43	70	170	32	H70
2NKR43	□	43	70	180	42	H33
2NKL43X32	□	43	110	210	32	H34
4NKL43X32	□	43	110	210	32	H70
2NKR43.5X32	□	43.5	70	170	32	H33
GFQS44	□	44	65	200	42	H71
2GNKR44	□	44	70	170	32	H69
4GNKR44	□	44	70	170	32	H70
GCQS44	□	44	70	170	32	H72
2NKR44X32	□	44	70	170	32	H33
4NKRE44×32	□	44	70	170	32	H70
GRFR44	□	44	70	180	42	H72
RFR44	□	44	70	180	42	H62
2NKR44	□	44	70	180	42	H33
4NKRE44	□	44	70	180	42	H70
GFQR44	□	44	110	200	42	H72
GRQR44	□	44	110	210	32	H73
2NKL44X32	□	44	115	215	32	H34
4NKL44X32	□	44	115	215	32	H70
RFL44	□	44	115	225	42	H62
2NKR44.5X32	□	44.5	70	170	32	H33
ESMQS45	●	45	65	200	42	H55
GFQS45	□	45	65	200	42	H71
2GNKR45	□	45	70	170	32	H69
4GNKR45	□	45	70	170	32	H70
GCQS45	□	45	70	170	32	H72
2NKR45X32	□	45	70	170	32	H33
4NKRE45×32	□	45	70	170	32	H70
GRFR45	□	45	70	180	42	H72
RFR45	□	45	70	180	42	H62
QS45	□	45	70	180	42	H73
2NKR45	□	45	70	180	42	H33
4NKRE45	□	45	70	180	42	H70
LS45	□	45	70	310	42	H71
LQ45	□	45	70	310	42	H73
DSH45×100	□	45	100	195	50.8	H75
DSQ45×100	□	45	100	195	50.8	H74
GFQR45	□	45	110	200	42	H72
HQR45	●	45	110	200	42	H63
GRQR45	□	45	110	210	32	H73
QR45X32	□	45	110	210	32	H73
GQR45	□	45	110	220	42	H73
QR45X42	□	45	110	220	42	H73
QRT45	□	45	110	265	MT5	H74
2NKL45X32	□	45	115	215	32	H34
4NKL45X32	□	45	115	215	32	H70
RFL45	□	45	115	225	42	H62
DSH45×125	□	45	125	220	50.8	H75
DSQ45×125	□	45	125	220	50.8	H74
GFQL45	□	45	125	230	42	H72
HQL45	●	45	125	230	42	H64
2NXX45X150	□	45	150	260	42	H69
4NKX45X150	□	45	150	260	42	H71
QL45X150	□	45	150	260	42	H74
DSQ45×150	□	45	155	245	50.8	H74
HQXL45	●	45	180	290	42	H64
2NXX45X200	□	45	200	310	42	H69
4NKX45X200	□	45	200	310	42	H71
QL45X200	□	45	200	310	42	H74
QL45X205	□	45	205	320	42	H74
2NXX45X250	□	45	250	360	42	H69
4NKX45X250	□	45	250	360	42	H71
QL45X250	□	45	250	360	42	H74
QL45X300	□	45	300	410	42	H74

商品コード Item code	在庫 Stock	外径 Tool da.	刃長 Flute length	全長 Overall length	シャンク径 Shank dia.	ページ Page
2NKR45.5X32	□	45.5	70	170	32	H33
GFQS46	□	46	65	200	42	H71
2GNKR46	□	46	70	170	32	H69
4GNKR46	□	46	70	170	32	H70
GCQS46	□	46	70	170	32	H72
2NKR46X32	□	46	70	170	32	H33
4NKRE46×32	□	46	70	170	32	H70
GRFR46	□	46	70	180	42	H72
RFR46	□	46	70	180	42	H62
2NKR46	□	46	70	180	42	H33
4NKRE46	□	46	70	180	42	H70
GFQR46	□	46	110	200	42	H72
GRQR46	□	46	110	210	32	H73
2NKL46X32	□	46	115	215	32	H34
4NKL46X32	□	46	115	215	32	H70
RFL46	□	46	115	225	42	H62
2NKR46.5X32	□	46.5	70	170	32	H33
2NKR47X32	□	47	70	170	32	H33
4NKRE47×32	□	47	70	170	32	H70
2NKR47	□	47	70	180	42	H33
2NKL47X32	□	47	115	215	32	H34
4NKL47X32	□	47	115	215	32	H70
2NKR47.5X32	□	47.5	70	170	32	H33
2GNKR48	□	48	70	170	32	H69
4GNKR48	□	48	70	170	32	H70
2NKR48X32	□	48	70	170	32	H33
4NKRE48×32	□	48	70	170	32	H70
GRFR48	□	48	70	180	42	H72
RFR48	□	48	70	180	42	H62
2NKR48	□	48	70	180	42	H33
4NKRE48	□	48	70	180	42	H70
GCQS48	□	48	75	175	32	H72
GFQS48	□	48	75	225	42	H71
GRQR48	□	48	120	220	32	H73
2NKL48X32	□	48	120	220	32	H34
4NKL48X32	□	48	120	220	32	H70
GFQR48	□	48	120	225	42	H72
RFL48	□	48	120	230	42	H62
2NKR48.5	□	48.5	70	170	42	H33
2NKR49X32	□	49	70	170	32	H33
4NKRE49×32	□	49	70	170	32	H70
2NKR49	□	49	70	180	42	H33
2NKL49X32	□	49	120	220	32	H34
4NKL49X32	□	49	120	220	32	H70
2NKR49.5X32	□	49.5	70	170	32	H33
2NER50-AT	●	50	70	170	32	H21
2GNKR50	□	50	70	170	32	H69
4GNKR50	□	50	70	170	32	H70
2NKR50X32	□	50	70	170	32	H33
4NKRE50×32	□	50	70	170	32	H70
GRFR50	□	50	70	180	42	H72
RFR50	□	50	70	180	42	H62
2NKR50	□	50	70	180	42	H33
4NKRE50	□	50	70	180	42	H70
LS50	□	50	70	310	42	H71
LQ50	□	50	70	310	42	H73
ESMQLS50	●	50	70	320	42	H56
DSH50×75	□	50	75	170	50.8	H75
DSQ50×75	□	50	75	170	50.8	H74
GCQS50	□	50	75	175	32	H72
QS50	□	50	75	185	42	H73
RQS50-AT	●	50	75	225	42	H52
ESMQS50	●	50	75	225	42	H55
GFQS50	□	50	75	225	42	H71
HQS50	●	50	75	225	42	H63
HQLS50	●	50	75	320	42	H64
DSH50×100	□	50	100	195	50.8	H75
DSQ50×100	□	50	100	195	50.8	H74
GRQR50	□	50	120	220	32	H73
2NKL50X32	□	50	120	220	32	H34
4NKL50X32	□	50	120	220	32	H70
QR50X32	□	50	120	220	32	H73

商品コード Item code	在庫 Stock	外径 Tool da.	刃長 Flute length	全長 Overall length	シャンク径 Shank dia.	ページ Page
RQR50-AT	●	50	120	225	42	H52
GFQR50	□	50	120	225	42	H72
HQR50	●	50	120	225	42	H63
RFL50	□	50	120	230	42	H62
GQR50	□	50	120	230	42	H73
4NKL50X42	□	50	120	230	42	H70
QR50X42	□	50	120	230	42	H73
QRT50	□	50	120	280	MT5	H74
DSH50×125	□	50	125	220	50.8	H75
DSQ50×125	□	50	125	220	50.8	H74
DSH50×150	□	50	150	245	50.8	H75
DSQ50×150	□	50	150	245	50.8	H74
RQL50-AT	●	50	150	255	42	H52
ESMQL50	●	50	150	255	42	H56
GFQL50	□	50	150	255	42	H72
HQL50	●	50	150	255	42	H64
2NXX50X150	□	50	150	260	42	H69
4NKX50X150	□	50	150	260	42	H71
QL50X150	□	50	150	260	42	H74
QL50X155	□	50	155	280	42	H74
DSH50×200	□	50	200	295	50.8	H75
DSQ50×200	□	50	200	295	50.8	H74
2NXX50X200	□	50	200	310	42	H69
4NKX50X200	□	50	200	310	42	H71
QL50X200	□	50	200	310	42	H74
HQXL50	●	50	205	315	42	H64
QL50X205	□	50	205	320	42	H74
2NXX50X250	□	50	250	360	42	H69
4NKX50X250	□	50	250	360	42	H71
QL50X250	□	50	250	360	42	H74
DSQ50×255	□	50	255	350	50.8	H74
4NKX50X300	□	50	300	410	42	H71
QL50X300	□	50	300	410	42	H74
DSQ50×305	□	50	305	400	50.8	H74
2NKR51	□	51	75	185	42	H33
2NKL51X42	□	51	120	220	42	H34
2NKR52	□	52	75	185	42	H33
2NKR53	□	53	75	185	42	H33
2NKR54	□	54	75	185	42	H33
2NKR55	□	55	75	185	42	H33
QR55	□	55	120	230	42	H73
2NKR56	□	56	75	185	42	H33
2NKR57	□	57	75	185	42	H33
2NKR58	□	58	75	185	42	H33
2NKR59	□	59	75	185	42	H33
2NKR60X32	□	60	75	175	32	H33
2NKR60	□	60	75	185	42	H33
DSH60×100	□	60	100	195	50.8	H75
DSQ60×100	□	60	100	195	50.8	H74
QR60	□	60	120	230	42	H73
DSH60×125	□	60	125	220	50.8	H75
DSQ60×125	□	60	125	220	50.8	H74
DSH60×150	□	60	150	245	50.8	H75
DSQ60×150	□	60	150	245	50.8	H74
2NXX60X150	□	60	150	260	42	H69
4NKX60X150	□	60	150	260	42	H71
QL60X150	□	60	150	270	42	H74
DSQ60×200	□	60	200	295	50.8	H74
2NXX60X200	□	60	200	310		

ESMボールエンドミル

Cコーティング

C Coating

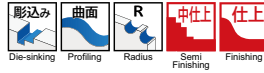
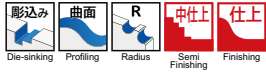

2ESMBC



2ESMB

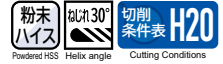

商品コード Item code	在庫 Stock	寸法 Size (mm)					希望小売 価格(円) Suggested retail price(¥)
		ボール半径 Ball Radius	外径 Tool dia.	刃長 Flute length	全長 Overall length	シャンク径 Shank dia.	
2ESMBC0.5R	●	0.5	1	2.5	60	6	11,620
2ESMBC1R	●	1	2	5	60	6	11,620
2ESMBC1.5R	●	1.5	3	8	70	6	11,620
2ESMBC2R	●	2	4	8	80	6	11,620
2ESMBC2.5R	●	2.5	5	10	90	6	11,620
2ESMBC3R	●	3	6	12	100	6	11,620
2ESMBC3.5R	□	3.5	7	14	100	6	—
2ESMBC4R	●	4	8	14	110	8	13,430
2ESMBC4.5R	□	4.5	9	18	120	8	—
2ESMBC5R	●	5	10	18	125	10	16,230
2ESMBC5.5R	□	5.5	11	18	125	10	—
2ESMBC6R	●	6	12	22	140	12	19,390
2ESMBC6.5R	□	6.5	13	22	140	12	—
2ESMBC7R	□	7	14	26	140	12	—
2ESMBC7.5R	□	7.5	15	26	140	12	—
2ESMBC8R	●	8	16	30	160	16	29,840
2ESMBC9R	□	9	18	34	160	16	—
2ESMBC10R	●	10	20	38	180	20	41,800
2ESMBC12.5R	□	12.5	25	50	200	25	—
2ESMBC15R	□	15	30	55	200	25	—

商品コード Item code	在庫 Stock	寸法 Size (mm)					希望小売 価格(円) Suggested retail price(¥)
		ボール半径 Ball Radius	外径 Tool dia.	刃長 Flute length	全長 Overall length	シャンク径 Shank dia.	
2ESMB0.5R	●	0.5	1	2.5	60	6	8,930
2ESMB1R	●	1	2	5	60	6	8,930
2ESMB1.5R	●	1.5	3	8	70	6	8,930
2ESMB2R	●	2	4	8	80	6	8,930
2ESMB2.5R	●	2.5	5	10	90	6	8,930
2ESMB3R	●	3	6	12	100	6	8,930
2ESMB3.5R	□	3.5	7	14	100	6	—
2ESMB4R	●	4	8	14	110	8	10,340
2ESMB4.5R	□	4.5	9	18	120	8	—
2ESMB5R	●	5	10	18	125	10	12,420
2ESMB5.5R	□	5.5	11	18	125	10	—
2ESMB6R	●	6	12	22	140	12	14,850
2ESMB6.5R	□	6.5	13	22	140	12	—
2ESMB7R	□	7	14	26	140	12	—
2ESMB7.5R	□	7.5	15	26	140	12	—
2ESMB8R	●	8	16	30	160	16	25,580
2ESMB9R	□	9	18	34	160	16	—
2ESMB10R	●	10	20	38	180	20	35,620
2ESMB12.5R	□	12.5	25	50	200	25	—
2ESMB15R	□	15	30	55	200	25	—

ハイスエンドミル
ボールエンドミル

2ESMBCの対応被削材

Applicable work material of 2ESMBC

炭素鋼 合金鋼 Carbon steel Alloy steel	炭素鋼 合金鋼 Pre-hardened steel ≤ 45HRC	高硬度 Hardened steel			ステン レス鋼 Stainless steel	チタン合金 耐熱合金 Titanium alloy Heat-resistant alloy	銅合金 Copper alloy	アルミ 合金 Aluminum alloy
		> 45HRC ≤ 55HRC	> 55HRC ≤ 65HRC	> 65HRC				
○	○				○	○	○	

2ESMBの対応被削材

Applicable work material of 2ESMB

炭素鋼 合金鋼 Carbon steel Alloy steel	炭素鋼 合金鋼 Pre-hardened steel ≤ 45HRC	高硬度 Hardened steel			ステン レス鋼 Stainless steel	チタン合金 耐熱合金 Titanium alloy Heat-resistant alloy	銅合金 Copper alloy	アルミ 合金 Aluminum alloy
		> 45HRC ≤ 55HRC	> 55HRC ≤ 65HRC	> 65HRC				
○					○	○	○	

再研磨対応外径範囲 Re-grinding compatibility range

商品コード Item code	外周 Outer dia. (mm)	エンド End (mm)
2ESMBC	× (N/A)	4 ~ 30

再研磨対応外径範囲 Re-grinding compatibility range

商品コード Item code	外周 Outer dia. (mm)	エンド End (mm)
2ESMB	× (N/A)	4 ~ 30

●印：標準在庫品です。 □印：特定代理店在庫です。弊社営業へお問合せください。
● : Stocked items. □ : Stocked by specified distributor. Contact with our sales department.

標準切削条件表 Recommended cutting conditions

2ESMBC

寸法表 Size list : H18

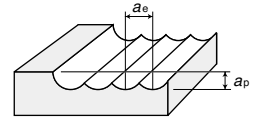

< 荒加工 > Roughing

被削材 (硬さ) Work material (Hardness)	条件域 Condition Range	切込み Depth of cut mm	切削条件 Cutting Conditions	ボール半径RE × 外径DC Tool dia. (mm)									
				RE1.5×3	RE2×4	RE3×6	RE4×8	RE5×10	RE6×12	RE8×16	RE10×20	RE12.5×25	RE15×30
鋳鉄・炭素鋼 Cast irons, Carbon steels (200HB 以下) FC200 SS400, S45C	汎用条件 General	ap=0.3DC ae=0.7DC	回転数 min ⁻¹	4,600	3,400	2,300	1,700	1,300	1,100	850	700	550	450
			送り速度 mm/min	130	130	160	160	150	150	160	160	160	130
合金鋼 Alloy steels (200~250HB) SCM, SNCM	汎用条件 General	ap=0.3DC ae=0.7DC	回転数 min ⁻¹	2,300	1,700	1,100	850	700	570	430	340	270	230
			送り速度 mm/min	65	65	80	80	80	80	80	80	80	70
工具鋼 ステンレス鋼 Tool steels, Stainless steels (25~35HRC) SKD, SKT, SUS304	汎用条件 General	ap=0.3DC ae=0.7DC	回転数 min ⁻¹	2,000	1,500	1,000	750	600	500	370	300	240	200
			送り速度 mm/min	55	55	70	70	70	70	70	70	70	60
焼入れ鋼 プリハードン鋼 Hardened steels, Pre-Harden steels (35~45HRC) SKD, SKT, HPM1, NAK55	汎用条件 General	ap=0.3DC ae=0.7DC	回転数 min ⁻¹	1,500	1,100	800	600	450	400	300	230	180	150
			送り速度 mm/min	40	40	60	60	55	60	55	55	50	45

- [注意]** ①被削材、加工形状に合わせて、適切なクーラントを使用してください。
 ②この標準切削条件表は切削条件の目安を示すものです。実際の加工では加工形状、目的、使用機械等により条件を調整してください。
- [Note]** ① Use the appropriate coolant for the work material and machining shape.
 ② These Recommended Cutting Conditions indicate only the rule of a thumb for the cutting conditions. In actual machining, the condition should be adjusted according to the machining shape, purpose and the machine type.

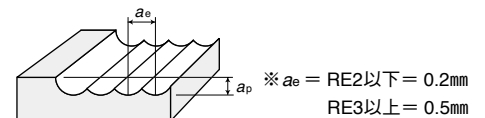

< 仕上げ加工 > Finishing

被削材 (硬さ) Work material (Hardness)	条件域 Condition Range	切込み Depth of cut mm	切削条件 Cutting Conditions	ボール半径RE × 外径DC Tool dia. (mm)									
				RE1.5×3	RE2×4	RE3×6	RE4×8	RE5×10	RE6×12	RE8×16	RE10×20	RE12.5×25	RE15×30
鋳鉄・炭素鋼 Cast irons, Carbon steels (200HB 以下) FC200 SS400, S45C	汎用条件 General	右上図 参照	回転数 min ⁻¹	8,300	7,200	3,800	3,300	2,900	2,600	2,300	2,000	1,800	1,600
			送り速度 mm/min	490	570	530	590	690	730	880	950	1,100	1,000
合金鋼 Alloy steels (200~250HB) SCM, SNCM	汎用条件 General	右上図 参照	回転数 min ⁻¹	4,200	3,600	2,000	1,600	1,400	1,300	1,100	1,000	900	800
			送り速度 mm/min	250	290	270	290	340	360	420	480	550	500
工具鋼 ステンレス鋼 Tool steels, Stainless steels (25~35HRC) SKD, SKT, SUS304	汎用条件 General	右上図 参照	回転数 min ⁻¹	3,600	3,100	1,700	1,400	1,200	1,100	1,000	900	800	700
			送り速度 mm/min	220	250	230	260	300	310	360	450	450	450
焼入れ鋼 プリハードン鋼 Hardened steels, Pre-Harden steels (35~45HRC) SKD, SKT, HPM1, NAK55	汎用条件 General	右上図 参照	回転数 min ⁻¹	2,700	2,300	1,300	1,100	1,000	900	800	700	600	550
			送り速度 mm/min	170	200	180	200	230	250	300	330	360	360

- [注意]** ①被削材、加工形状に合わせて、適切なクーラントを使用してください。
 ②この標準切削条件表は切削条件の目安を示すものです。実際の加工では加工形状、目的、使用機械等により条件を調整してください。
- [Note]** ① Use the appropriate coolant for the work material and machining shape.
 ② These Recommended Cutting Conditions indicate only the rule of a thumb for the cutting conditions. In actual machining, the condition should be adjusted according to the machining shape, purpose and the machine type.

標準切削条件表 Recommended cutting conditions

2ESMB 寸法表 Size list : H18

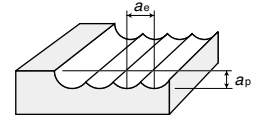

< 荒加工 > Roughing

被削材 (硬さ) Work material (Hardness)	条件域 Condition Range	切込み Depth of cut mm	切削条件 Cutting Conditions	ボール半径RE × 外径DC Tool dia. (mm)									
				RE1.5×3	RE2×4	RE3×6	RE4×8	RE5×10	RE6×12	RE8×16	RE10×20	RE12.5×25	RE15×30
鋳鉄・炭素鋼 Cast irons, Carbon steels (200HB 以下) FC200 SS400, S45C	汎用条件 General	ap=0.3DC ae=0.7DC	回転数 min ⁻¹	3,400	2,600	1,700	1,300	1,000	850	650	520	400	350
			送り速度 mm/min	100	100	120	120	120	120	120	120	120	100
合金鋼 Alloy steels (200~250HB) SCM, SNCM	汎用条件 General	ap=0.3DC ae=0.7DC	回転数 min ⁻¹	1,700	1,300	850	650	520	430	320	250	200	170
			送り速度 mm/min	45	50	60	60	60	60	60	60	60	50
工具鋼 ステンレス鋼 Tool steels, Stainless steels (25~35HRC) SKD, SKT, SUS340	汎用条件 General	ap=0.3DC ae=0.7DC	回転数 min ⁻¹	1,500	1,100	800	600	450	400	300	230	180	150
			送り速度 mm/min	40	40	60	55	55	55	55	55	50	50
焼入れ鋼 プリハードン鋼 Hardened steels, Pre-Harden steels (35~45HRC) SKD, SKT, HPM1, NAK55	汎用条件 General	ap=0.3DC ae=0.7DC	回転数 min ⁻¹	1,100	850	550	430	340	280	200	170	130	110
			送り速度 mm/min	30	30	40	40	40	40	40	40	35	30

- [注意]** ①被削材、加工形状に合わせて、適切なクーラントを使用してください。
 ②この標準切削条件表は切削条件の目安を示すものです。実際の加工では加工形状、目的、使用機械等により条件を調整してください。
- [Note]** ① Use the appropriate coolant for the work material and machining shape.
 ② These Recommended Cutting Conditions indicate only the rule of a thumb for the cutting conditions. In actual machining, the condition should be adjusted according to the machining shape, purpose and the machine type.

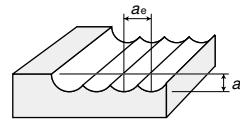

※ ap = RE2.5以下 = 0.2mm
 RE3以上 = 0.5mm
 ae = 0.1DC

< 仕上げ加工 > Finishing

被削材 (硬さ) Work material (Hardness)	条件域 Condition Range	切込み Depth of cut mm	切削条件 Cutting Conditions	ボール半径RE × 外径DC Tool dia. (mm)									
				RE1.5×3	RE2×4	RE3×6	RE4×8	RE5×10	RE6×12	RE8×16	RE10×20	RE12.5×25	RE15×30
鋳鉄・炭素鋼 Cast irons, Carbon steels (200HB 以下) FC200 SS400, S45C	汎用条件 General	右上図 参照	回転数 min ⁻¹	6,400	5,500	2,900	2,500	2,200	2,000	1,800	1,500	1,400	1,200
			送り速度 mm/min	380	440	410	450	530	560	680	720	840	770
合金鋼 Alloy steels (200~250HB) SCM, SNCM	汎用条件 General	右上図 参照	回転数 min ⁻¹	3,200	2,800	1,500	1,200	1,100	1,000	850	750	680	620
			送り速度 mm/min	190	220	210	220	260	280	320	370	420	400
工具鋼 ステンレス鋼 Tool steels, Stainless steels (25~35HRC) SKD, SKT, SUS340	汎用条件 General	右上図 参照	回転数 min ⁻¹	2,900	2,500	1,300	1,100	1,000	900	770	700	600	550
			送り速度 mm/min	170	190	180	200	230	240	280	320	350	350
焼入れ鋼 プリハードン鋼 Hardened steels, Pre-Harden steels (35~45HRC) SKD, SKT, HPM1, NAK55	汎用条件 General	右上図 参照	回転数 min ⁻¹	2,100	1,800	1,000	820	750	670	570	500	450	400
			送り速度 mm/min	130	150	140	150	180	190	230	250	280	280

- [注意]** ①被削材、加工形状に合わせて、適切なクーラントを使用してください。
 ②この標準切削条件表は切削条件の目安を示すものです。実際の加工では加工形状、目的、使用機械等により条件を調整してください。
- [Note]** ① Use the appropriate coolant for the work material and machining shape.
 ② These Recommended Cutting Conditions indicate only the rule of a thumb for the cutting conditions. In actual machining, the condition should be adjusted according to the machining shape, purpose and the machine type.

AT Coating NE End Mill

ATコートNEエンドミル

ショート刃長 Short



外径公差 Dia. tolerance 0~-0.03 (mm)



2NES-AT

コバルトハイス **AT** 切削条件表 **H22**
HSS-Co Helix angle Cutting Conditions

商品コード Item code	在庫 Stock	寸法 Size (mm)				希望小売 価格(円) Suggested retail price(¥)
		外径 Tool dia.	刃長 Flute length	全長 Overall length	シャンク径 Shank dia.	
2NES1-AT	●	1	2.5	55	6	5,940
2NES1.5-AT	●	1.5	3.5	55	6	5,440
2NES2-AT	●	2	4	55	6	4,980
2NES2.5-AT	●	2.5	5	55	6	4,880
2NES3-AT	●	3	7	55	6	4,350
2NES3.5-AT	●	3.5	8	65	8	4,450
2NES4-AT	●	4	8	65	8	4,450
2NES4.5-AT	●	4.5	10	65	8	4,450
2NES5-AT	●	5	10	65	8	4,450
2NES5.5-AT	●	5.5	12	65	8	4,450
2NES6-AT	●	6	12	65	8	4,450
2NES6.5-AT	●	6.5	14	70	10	4,820
2NES7-AT	●	7	14	70	10	4,820
2NES7.5-AT	●	7.5	14	70	10	4,820
2NES8-AT	●	8	14	70	10	4,820
2NES8.5-AT	●	8.5	18	75	10	5,850
2NES9-AT	●	9	18	75	10	5,850
2NES9.5-AT	●	9.5	18	75	10	5,850
2NES10-AT	●	10	18	75	10	5,850
2NES11-AT	●	11	22	85	12	7,270
2NES12-AT	●	12	22	85	12	7,270
2NES13-AT	●	13	25	90	12	9,020
2NES14-AT	●	14	25	95	16	9,020
2NES15-AT	●	15	30	100	16	9,800
2NES16-AT	●	16	30	100	16	10,380
2NES17-AT	●	17	35	105	16	12,900
2NES18-AT	●	18	35	105	16	13,640
2NES19-AT	●	19	40	120	20	14,850
2NES20-AT	●	20	40	120	20	15,680

2NES-AT、2NER-ATの対応被削材

Applicable work material of 2NES-AT, 2NER-AT

炭素鋼 合金鋼 Carbon steel Alloy steel	炭素鋼 合金鋼 Pre-hardened steel ≤ 45HRC	高硬度 Hardened steel > 45HRC ≤ 55HRC ≤ 65HRC	> 65HRC	ステン レス鋼 Stainless steel	チタン合金 耐熱合金 Titanium alloy Heat-resistant alloy	銅合金 Copper alloy	アルミ 合金 Aluminum alloy
○	○	○	○	○	○	○	○

再研磨対応外径範囲 Re-grinding compatibility range

商品コード Item code	外周 Outer dia. (mm)	エンド End (mm)
2NES-AT	6 ~ 20	4 ~ 20
2NER-AT	6 ~ 50	4 ~ 50

●印：標準在庫品です。 ●：Stoked items.

レギュラー刃長 Regular



外径公差 Dia. tolerance 0~-0.03 (mm)



2NER-AT

コバルトハイス **AT** 切削条件表 **H22**
HSS-Co Helix angle Cutting Conditions

商品コード Item code	在庫 Stock	寸法 Size (mm)				希望小売 価格(円) Suggested retail price(¥)
		外径 Tool dia.	刃長 Flute length	全長 Overall length	シャンク径 Shank dia.	
2NER1-AT	●	1	3.5	55	6	5,940
2NER1.5-AT	●	1.5	5	55	6	5,440
2NER2-AT	●	2	5	55	6	4,980
2NER2.5-AT	●	2.5	7	55	6	4,880
2NER3-AT	●	3	10	55	6	4,350
2NER3.5-AT	●	3.5	12	60	6	4,450
2NER4-AT	●	4	12	60	6	4,450
2NER4.5-AT	●	4.5	15	60	6	4,450
2NER5-AT	●	5	15	60	6	4,450
2NER5.5-AT	●	5.5	15	60	6	4,450
2NER6-AT	●	6	15	60	6	4,450
2NER6.5-AT	●	6.5	20	70	8	4,820
2NER7-AT	●	7	20	70	8	4,820
2NER7.5-AT	●	7.5	20	70	8	4,820
2NER8-AT	●	8	20	70	8	4,820
2NER8.5-AT	●	8.5	25	80	10	5,850
2NER9-AT	●	9	25	80	10	5,850
2NER9.5-AT	●	9.5	25	80	10	5,850
2NER10-AT	●	10	25	80	10	5,850
2NER11-AT	●	11	30	95	12	7,270
2NER12-AT	●	12	30	95	12	7,270
2NER13-AT	●	13	35	100	12	9,020
2NER14-AT	●	14	35	105	16	9,020
2NER15-AT	●	15	40	110	16	9,800
2NER16-AT	●	16	40	110	16	10,380
2NER17-AT	●	17	40	110	16	12,900
2NER18-AT	●	18	40	110	16	13,640
2NER19-AT	●	19	45	125	20	14,850
2NER20-AT	●	20	45	125	20	15,680
2NER21-AT	●	21	45	125	20	18,150
2NER22-AT	●	22	45	125	20	18,150
2NER23-AT	●	23	50	140	25	21,040
2NER24-AT	●	24	50	140	25	21,040
2NER25-AT	●	25	50	140	25	21,040
2NER26-AT	●	26	50	140	25	23,520
2NER27-AT	●	27	55	145	25	27,780
2NER28-AT	●	28	55	145	25	27,780
2NER29-AT	●	29	55	145	25	33,830
2NER30-AT	●	30	55	145	25	33,830
2NER31-AT	●	31	60	160	32	41,390
2NER32-AT	●	32	60	160	32	41,390
2NER33-AT	●	33	60	160	32	48,680
2NER34-AT	●	34	60	160	32	48,680
2NER35-AT	●	35	60	160	32	48,680
2NER36-AT	●	36	60	160	32	54,730
2NER37-AT	●	37	60	160	32	59,270
2NER38-AT	●	38	65	165	32	59,270
2NER39-AT	●	39	65	165	32	68,340
2NER40-AT	●	40	65	165	32	68,340
2NER50-AT	●	50	70	170	32	116,470

HSS End Mills
Square End Mills

ATコートNEエンドミル

標準切削条件表 Recommended cutting conditions

寸法表 Size list : H21 寸法表 Size list : H21 寸法表 Size list : H40

2NES-AT 2枚刃・ショート刃長 2ft, Short	2NER-AT 2枚刃・レギュラー刃長 2ft, Regular	4NER-AT 4枚刃・レギュラー刃長 4ft, Regular
--	---	---

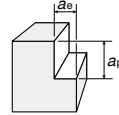

〈側面切削〉 Side Milling

被削材 (硬さ) Work material (Hardness)	切込み Depth of cut mm	切削条件 Cutting Conditions	外径DC Tool dia.(mm)									
			φ3	φ4	φ6	φ8	φ10	φ12	φ16	φ20	φ25	φ30
鋳鉄・炭素鋼 Cast irons, Carbon steels (200HB以下) FC200, SS400, S45C	ap=1.5DC	回転数 min ⁻¹	5,836	4,377	2,918	2,188	1,751	1,459	1,094	875	700	584
	ae=0.1DC以下	送り速度 mm/min	292	290	290	290	290	290	290	290	250	200
合金鋼 Alloy steels (200~250HB) SCM, SNCM	ap=1.5DC	回転数 min ⁻¹	4,775	3,581	2,387	1,790	1,432	1,194	895	716	573	477
	ae=0.1DC以下	送り速度 mm/min	191	190	190	190	190	190	190	190	160	140
工具鋼・ステンレス鋼 Tool steels, Stainless steels (25~35HRC) SKD, SKT, SUS304	ap=1.5DC	回転数 min ⁻¹	3,714	2,785	1,857	1,393	1,114	928	696	557	446	371
	ae=0.1DC以下	送り速度 mm/min	149	145	145	145	145	145	145	145	120	100
焼入れ鋼・プリハードン鋼 Hardened steels, Pre-hardened steels (35~45HRC) SKD, HPM1, NAK	ap=1.5DC	回転数 min ⁻¹	3,183	2,387	1,592	1,194	955	796	597	477	382	318
	ae=0.1DC以下	送り速度 mm/min	127	125	125	125	125	125	125	125	110	95
耐熱鋼・チタン合金 Heat resistant steels, Titanium alloys Inconel, Ti-6Al-4V	ap=1.5DC	回転数 min ⁻¹	1,910	1,432	955	716	573	477	358	286	229	191
	ae=0.1DC以下	送り速度 mm/min	57	55	55	55	55	55	55	55	50	45

- 【注意】**
- ①本工具のATコーティングはその性質上、通電性が微小です。従って、通電方式の工具長測定装置をご使用の際にはご注意ください。
 - ②被削材、加工形状に合わせて、適切なクーラントを使用してください。
 - ③この標準切削条件表は切削条件の目安を示すものです。実際の加工では加工形状、目的、使用機械等により条件を調整してください。
 - ④上記条件はショート刃長の場合を示します。レギュラー刃長の場合は上記条件の回転数・送りを80%、4枚刃の場合は回転数を1.3倍、送り2倍を目安にしてください。

- 【Note】**
- ①This product obtains less electric conductivity. Therefore, Please caution of using electric transmitted measuring systems.
 - ②Use the appropriate coolant for the work material and machining shape.
 - ③These Recommended Cutting Conditions indicate only the rule of a thumb for the cutting conditions. In actual machining, the condition should be adjusted according to the machining shape, purpose and the machine type.
 - ④The above conditions are for short flute lengths. For regular flute lengths, the rotation speed and feed rate should be set to 80% of the above conditions as a reference. When using 4 flutes, in general the rotation speed should be 1.3× and the feed rate should be 2× the above conditions as a reference.

寸法表 Size list : H21 寸法表 Size list : H21

2NES-AT 2枚刃・ショート刃長 2ft, Short	2NER-AT 2枚刃・レギュラー刃長 2ft, Regular
--	---

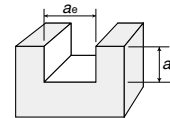

〈溝切削〉 Slotting

被削材 (硬さ) Work material (Hardness)	切込み Depth of cut mm	切削条件 Cutting Conditions	外径DC Tool dia.(mm)									
			φ3	φ4	φ6	φ8	φ10	φ12	φ16	φ20	φ25	φ30
鋳鉄・炭素鋼 Cast irons, Carbon steels (200HB以下) FC200, SS400, S45C	ap=0.5DC以下	回転数 min ⁻¹	3,926	2,944	1,963	1,472	1,178	981	736	589	471	393
	ae=1DC	送り速度 mm/min	196	190	190	190	190	190	190	190	150	100
合金鋼 Alloy steels (200~250HB) SCM, SNCM	ap=0.5DC以下	回転数 min ⁻¹	3,714	2,785	1,857	1,393	1,114	928	696	557	446	371
	ae=1DC	送り速度 mm/min	149	120	120	120	120	120	120	120	100	80
工具鋼・ステンレス鋼 Tool steels, Stainless steels (25~35HRC) SKD, SKT, SUS304	ap=0.5DC以下	回転数 min ⁻¹	3,183	2,387	1,592	1,194	955	796	597	477	382	318
	ae=1DC	送り速度 mm/min	80	90	90	90	90	90	90	90	80	65
焼入れ鋼・プリハードン鋼 Hardened steels, Pre-hardened steels (35~45HRC) SKD, HPM1, NAK	ap=0.5DC以下	回転数 min ⁻¹	2,653	1,989	1,326	995	796	663	497	398	318	265
	ae=1DC	送り速度 mm/min	53	60	60	60	60	60	60	60	45	35
耐熱鋼・チタン合金 Heat resistant steels, Titanium alloys Inconel, Ti-6Al-4V	ap=0.5DC以下	回転数 min ⁻¹				477	382	318	239	191	153	127
	ae=1DC	送り速度 mm/min				28	28	28	28	28	25	20

- 【注意】**
- ①本工具のATコーティングはその性質上、通電性が微小です。従って、通電方式の工具長測定装置をご使用の際にはご注意ください。
 - ②被削材、加工形状に合わせて、適切なクーラントを使用してください。
 - ③この標準切削条件表は切削条件の目安を示すものです。実際の加工では加工形状、目的、使用機械等により条件を調整してください。
 - ④上記条件はショート刃長の場合を示します。レギュラー刃長の場合は上記条件の回転数・送りを70%を目安にしてください。
 - ⑤4枚刃は溝切削には適しません。

- 【Note】**
- ①This product obtains less electric conductivity. Therefore, Please caution of using electric transmitted measuring systems.
 - ②Use the appropriate coolant for the work material and machining shape.
 - ③These Recommended Cutting Conditions indicate only the rule of a thumb for the cutting conditions. In actual machining, the condition should be adjusted according to the machining shape, purpose and the machine type.
 - ④The above conditions are for short flute lengths. For regular flute lengths, the rotation speed and feed rate should be set to 70% of the above conditions as a reference.
 - ⑤The 4flutes are not suitable for slotting.

C Coating ESM End Mills

ESM-Cコートエンドミル

ショート刃長 Short

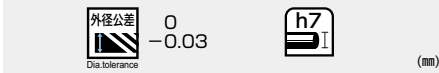

レギュラー刃長 Regular

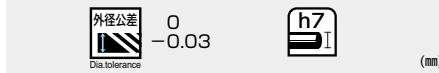

ロング刃長 Long

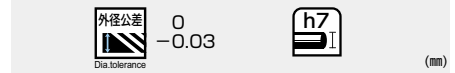

2ESMSC

商品コード Item code	在庫 Stock	寸法 Size (mm)				希望小 売価格 (円) Suggested retail price(¥)
		外径 Tool dia.	刃長 Flute length	全長 Overall length	シャンク径 Shank dia.	
2ESMSC1	●	1	2.5	50	6	8,280
2ESMSC1.5	●	1.5	3.5	50	6	7,540
2ESMSC2	●	2	4	50	6	7,090
2ESMSC2.5	●	2.5	5	50	6	6,990
2ESMSC3	●	3	7	50	6	6,000
2ESMSC3.5	●	3.5	8	60	8	6,000
2ESMSC4	●	4	8	60	8	6,000
2ESMSC4.5	●	4.5	10	60	8	6,000
2ESMSC5	●	5	10	60	8	6,000
2ESMSC5.5	●	5.5	12	60	8	6,000
2ESMSC6	●	6	12	60	8	6,000
2ESMSC6.5	●	6.5	14	65	10	6,600
2ESMSC7	●	7	14	65	10	6,600
2ESMSC7.5	●	7.5	14	65	10	6,600
2ESMSC8	●	8	14	65	10	6,600
2ESMSC8.5	●	8.5	18	70	10	7,620
2ESMSC9	●	9	18	70	10	7,620
2ESMSC9.5	●	9.5	18	75	10	7,620
2ESMSC10	●	10	18	75	10	7,620
2ESMSC11	●	11	22	80	12	9,720
2ESMSC12	●	12	22	80	12	9,720
2ESMSC13	●	13	25	90	12	12,820
2ESMSC14	●	14	25	95	16	12,820
2ESMSC15	●	15	30	100	16	14,170
2ESMSC16	●	16	30	100	16	15,400
2ESMSC17	□	17	35	105	16	-
2ESMSC18	●	18	35	105	16	18,430
2ESMSC19	□	19	40	120	20	-
2ESMSC20	●	20	40	120	20	22,280
2ESMSC21	□	21	40	120	20	-
2ESMSC22	□	22	40	120	20	-
2ESMSC23	□	23	50	120	25	-
2ESMSC24	□	24	50	120	25	-
2ESMSC25	□	25	50	120	25	-
2ESMSC26	□	26	50	120	25	-
2ESMSC28	□	28	55	125	25	-
2ESMSC30	□	30	55	125	25	-

2ESMRC

商品コード Item code	在庫 Stock	寸法 Size (mm)				希望小 売価格 (円) Suggested retail price(¥)
		外径 Tool dia.	刃長 Flute length	全長 Overall length	シャンク径 Shank dia.	
2ESMRC1	●	1	3.5	55	6	8,280
2ESMRC1.5	●	1.5	5	55	6	7,540
2ESMRC2	●	2	5	55	6	7,090
2ESMRC2.5	●	2.5	7	55	6	6,990
2ESMRC3	●	3	10	55	6	6,000
2ESMRC3.5	●	3.5	12	60	8	6,000
2ESMRC4	●	4	12	60	8	6,000
2ESMRC4.5	●	4.5	15	60	8	6,000
2ESMRC5	●	5	15	60	8	6,000
2ESMRC5.5	●	5.5	15	60	8	6,000
2ESMRC6	●	6	15	60	8	6,000
2ESMRC6.5	●	6.5	20	70	10	6,600
2ESMRC7	●	7	20	70	10	6,600
2ESMRC7.5	●	7.5	20	70	10	6,600
2ESMRC8	●	8	20	70	10	6,600
2ESMRC8.5	●	8.5	25	80	10	7,620
2ESMRC9	●	9	25	80	10	7,620
2ESMRC9.5	●	9.5	25	80	10	7,620
2ESMRC10	●	10	25	80	10	7,620
2ESMRC11	●	11	30	95	12	9,720
2ESMRC12	●	12	30	95	12	9,720
2ESMRC13	●	13	35	100	12	12,820
2ESMRC14	●	14	35	105	16	12,820
2ESMRC15	●	15	40	110	16	14,170
2ESMRC16	●	16	40	110	16	15,400
2ESMRC17	●	17	40	110	16	18,430
2ESMRC18	●	18	40	110	16	18,430
2ESMRC20	●	20	45	125	20	22,280
2ESMRC22	●	22	45	125	20	28,190
2ESMRC24	●	24	50	140	25	32,730
2ESMRC25	●	25	50	140	25	32,730
2ESMRC26	●	26	50	140	25	36,170
2ESMRC28	●	28	55	145	25	43,180
2ESMRC30	●	30	55	145	25	52,250

2ESMLC

商品コード Item code	在庫 Stock	寸法 Size (mm)			
		外径 Tool dia.	刃長 Flute length	全長 Overall length	シャンク径 Shank dia.
2ESMLC3	□	3	15	60	6
2ESMLC4	□	4	20	65	6
2ESMLC5	□	5	25	70	6
2ESMLC6	□	6	25	70	6
2ESMLC8	□	8	35	85	8
2ESMLC10	□	10	45	100	10
2ESMLC12	□	12	55	120	12
2ESMLC14	□	14	55	125	16
2ESMLC15	□	15	65	135	16
2ESMLC16	□	16	65	135	16
2ESMLC18	□	18	65	135	16
2ESMLC20	□	20	75	155	20
2ESMLC22	□	22	75	155	20
2ESMLC25	□	25	90	180	25
2ESMLC30	□	30	90	180	25

2ESMSC、2ESMRC、2ESMLCの対応被削材

Applicable work material of 2ESMSC, 2ESMRC, 2ESMLC

炭素鋼 合金鋼 Carbon steel Alloy steel	炭素鋼 合金鋼 Pre-hardened steel ≤ 45HRC	高硬度 Hardened steel		ステン レス鋼 Stainless steel	チタン合金 耐熱合金 Titanium alloy Heat-resistant alloy	銅合金 Copper alloy	アルミ 合金 Aluminum alloy
		> 45HRC ≤ 55HRC	> 65HRC ≤ 65HRC				
○	○			○	○		○

再研磨対応外径範囲

Re-grinding compatibility range

商品コード Item code	外周 Outer dia. (mm)	エンド End (mm)
2ESMSC	6 ~ 30	4 ~ 30
2ESMRC	6 ~ 30	4 ~ 30
2ESMLC	6 ~ 30	3 ~ 30

●印：標準在庫品です。 □印：特定代理店在庫です。弊社営業へお問い合わせください。
 ●：Stoked items. □：Stocked by specified distributor. Contact with our sales department.

標準切削条件表 Recommended cutting conditions

寸法表 Size list : H23	寸法表 Size list : H23	寸法表 Size list : H23	寸法表 Size list : H41	寸法表 Size list : H41
2ESMSC	2ESMRC (注②)	2ESMLC (注②)	4ESMRC (注①②)	4ESMLC (注①②)
2枚刃・ショート刃長 2ft, Short	2枚刃・レギュラー刃長 2ft, Regular	2枚刃・ロング刃長 2ft, Long	4枚刃・レギュラー刃長 4ft, Regular	4枚刃・ロング刃長 4ft, Long

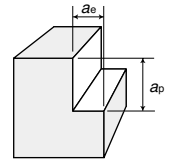

<側面切削> Side milling

被削材 (硬さ) Work material (Hardness)	条件域 Condition Range	切込み Depth of cut mm	切削条件 Cutting Conditions	外径 DC Tool dia. (mm)											
				φ3	φ4	φ6	φ8	φ10	φ12	φ16	φ20	φ25	φ30	φ35	φ40
鋳鉄・炭素鋼 Cast irons, Carbon steels (200HB 以下) FC200 SS400, S45C	汎用条件 General	ap=1.5DC ae=0.1DC	回転数 min ⁻¹	5,300	3,900	2,600	1,900	1,500	1,300	990	790	630	530	450	390
			送り速度 mm/min	190	200	200	200	200	200	200	200	160	130	110	100
合金鋼 Alloy steels (200~250HB) SCM, SNCM	汎用条件 General	ap=1.5DC ae=0.1DC	回転数 min ⁻¹	3,700	2,700	1,800	1,300	1,100	920	690	550	440	370	310	270
			送り速度 mm/min	130	140	140	140	140	140	140	140	110	90	80	70
工具鋼・ステンレス鋼 Tool steels, Stainless steels (25~35HRC) SKD, SKT, SUS304	汎用条件 General	ap=1.5DC ae=0.1DC	回転数 min ⁻¹	3,100	2,300	1,500	1,100	950	790	590	470	380	310	270	230
			送り速度 mm/min	110	120	120	120	120	120	120	120	95	80	70	60
焼入れ鋼・プリハードン鋼 Hardened steels, Pre-hardened steels (35~45HRC) SKD, SKT, HPM1, NAK55	汎用条件 General	ap=1.5DC ae=0.1DC	回転数 min ⁻¹	2,600	1,900	1,300	990	790	660	490	390	310	260	220	190
			送り速度 mm/min	95	95	100	100	100	100	100	100	80	65	55	50
耐熱鋼・チタン合金 Heat-resistant steels, Titanium alloys Inconel Ti-6Al-4V	汎用条件 General	ap=1.5DC ae=0.1DC	回転数 min ⁻¹	1,300	990	660	490	390	330	240	190	150	130	110	95
			送り速度 mm/min	40	40	40	40	40	40	40	40	30	25	20	20
アルミ合金・非鉄金属 Aluminum alloys Non Ferrous	汎用条件 General	ap=1.5DC ae=0.1DC	回転数 min ⁻¹	10,000	8,000	5,300	4,000	3,200	2,600	2,000	1,600	1,250	1,000	900	790
			送り速度 mm/min	450	480	480	480	480	480	480	480	380	200	270	240

- [注意]** ①被削材、加工形状に合わせて、適切なクーラントを使用してください。
 ②この標準切削条件表は切削条件の目安を示すものです。実際の加工では加工形状、目的、使用機械等により条件を調整してください。
 ③上表の切削条件は2枚刃の場合を示します。4枚刃は、送り速度を約2倍にしてください。
 ④レギュラー刃の場合は回転数と送り速度を約70%に、ロング刃の場合は約50%にしてください。

- [Note]** ① Use the appropriate coolant for the work material and machining shape.
 ② These Recommended Cutting Conditions indicate only the rule of a thumb for the cutting conditions. In actual machining, the condition should be adjusted according to the machining shape, purpose and the machine type.
 ③ The cutting conditions given above is applied to 2-flute type end mills. As for 4-flute type, increase the feed speed twice.
 ④ As for Regular type, decrease the revolution number and the feed speed to around 70% of the values given in the table. As for the long length type, decrease them to around 50% or less.

寸法表 Size list : H23	寸法表 Size list : H23
2ESMSC	2ESMRC
2枚刃・ショート刃長 2ft, Short	2枚刃・レギュラー刃長 2ft, Regular

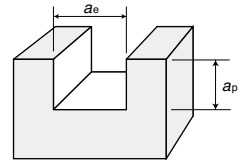

<溝切削> Slotting

被削材 (硬さ) Work material (Hardness)	条件域 Condition Range	切込み Depth of cut mm	切削条件 Cutting Conditions	外径 DC Tool dia. (mm)											
				φ3	φ4	φ6	φ8	φ10	φ12	φ16	φ20	φ25	φ30	φ35	φ40
鋳鉄・炭素鋼 Cast irons, Carbon steels (200HB 以下) FC200 SS400, S45C	汎用条件 General	ap=0.5DC ae=1DC	回転数 min ⁻¹	3,400	2,500	1,700	1,200	1,000	860	680	510	410	340	290	250
			送り速度 mm/min	120	130	130	130	130	130	140	130	100	85	75	65
合金鋼 Alloy steels (200~250HB) SCM, SNCM	汎用条件 General	ap=0.5DC ae=1DC	回転数 min ⁻¹	2,600	1,900	1,300	990	790	660	490	390	310	260	220	190
			送り速度 mm/min	75	75	80	80	80	80	80	80	60	50	45	40
工具鋼・ステンレス鋼 Tool steels, Stainless steels (25~35HRC) SKD, SKT, SUS304	汎用条件 General	ap=0.5DC ae=1DC	回転数 min ⁻¹	2,100	1,500	1,000	790	630	530	390	310	250	210	180	150
			送り速度 mm/min	60	60	60	65	65	65	60	60	50	40	35	30
焼入れ鋼・プリハードン鋼 Hardened steels, Pre-hardened steels (35~45HRC) SKD, SKT, HPM1, NAK55	汎用条件 General	ap=0.5DC ae=1DC	回転数 min ⁻¹	1,600	1,200	840	630	500	420	310	250	200	160	140	120
			送り速度 mm/min	35	35	35	40	40	40	40	40	30	25	20	20
耐熱鋼・チタン合金 Heat-resistant steels, Titanium alloys Inconel Ti-6Al-4V	汎用条件 General	ap=0.5DC ae=1DC	回転数 min ⁻¹				250	200	170	120	100	80	65	55	50
			送り速度 mm/min				15	15	15	15	15	15	12	10	8

- [注意]** ①被削材、加工形状に合わせて適切なクーラントを使用してください。
 ②この標準切削条件表は切削条件の目安を示すものです。実際の加工では加工形状、目的、使用機械等により条件を調整してください。
 ③ロング刃は溝切削に適しません。
- [Note]** ① Use the appropriate coolant for the work material and machining shape.
 ② These Recommended Cutting Conditions indicate only the rule of a thumb for the cutting conditions. In actual machining, the condition should be adjusted according to the machining shape, purpose and the machine type.
 ③ The long length type is not suited to slotting.

C Coating ESM End Mills for Stainless Steels

ESM-Cコートステンレス用エンドミル

ステンレス用

for Stainless Steel



外径公差 Dia.tolerance 0~-0.03



(mm)



2ESMSUSC



商品コード Item code	在庫 Stock	寸法 Size (mm)				希望小売 価格(円) Suggested retail price(¥)
		外径 Tool dia.	刃長 Flute length	全長 Overall length	シャンク径 Shank dia.	
2ESMSUSC3	●	3	7	50	6	5,630
2ESMSUSC4	●	4	8	60	8	5,630
2ESMSUSC5	●	5	10	60	8	5,630
2ESMSUSC6	●	6	12	60	8	5,630
2ESMSUSC8	●	8	14	65	10	6,140
2ESMSUSC10	●	10	18	75	10	7,130
2ESMSUSC12	●	12	22	80	12	9,100
2ESMSUSC16	●	16	30	100	16	13,590
2ESMSUSC20	●	20	40	120	20	19,530

標準切削条件表 Recommended cutting conditions 2ESMSUSC

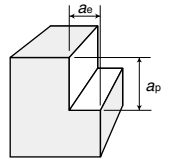

<側面切削> Side milling

被削材 (硬さ) Work material (Hardness)	条件域 Condition Range	切込み Depth of cut mm	切削条件 Cutting Conditions	外径 DC Tool dia. (mm)								
				φ3	φ4	φ5	φ6	φ8	φ10	φ12	φ16	φ20
ステンレス鋼 Stainless steels (25~35HRC) SUS304, SUS430	汎用条件 General	ap=1.6DC	回転数 min ⁻¹	3,400	2,500	2,000	1,700	1,200	980	780	610	480
		ae=0.1DC	送り速度 mm/min	130	130	130	130	130	140	140	130	130

- 【注意】** ①被削材、加工形状に合わせて、適切なクーラントを使用してください。
 ②この標準切削条件表は切削条件の目安を示すものです。実際の加工では加工形状、目的、使用機械等により条件を調整してください。
- 【Note】** ① Use the appropriate coolant for the work material and machining shape.
 ② These Recommended Cutting Conditions indicate only the rule of a thumb for the cutting conditions. In actual machining, the condition should be adjusted according to the machining shape, purpose and the machine type.

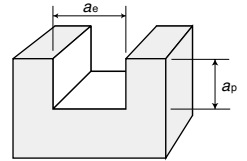

<溝切削> Slotting

被削材 (硬さ) Work material (Hardness)	条件域 Condition Range	切込み Depth of cut mm	切削条件 Cutting Conditions	外径 DC Tool dia. (mm)								
				φ3	φ4	φ5	φ6	φ8	φ10	φ12	φ16	φ20
ステンレス鋼 Stainless steels (25~35HRC) SUS304, SUS430	汎用条件 General	ap=0.5DC	回転数 min ⁻¹	2,200	1,700	1,300	1,100	830	660	550	410	340
		ae=1DC	送り速度 mm/min	45	45	45	50	65	65	65	65	65

- 【注意】** ①被削材、加工形状に合わせて、適切なクーラントを使用してください。
 ②この標準切削条件表は切削条件の目安を示すものです。実際の加工では加工形状、目的、使用機械等により条件を調整してください。
- 【Note】** ① Use the appropriate coolant for the work material and machining shape.
 ② These Recommended Cutting Conditions indicate only the rule of a thumb for the cutting conditions. In actual machining, the condition should be adjusted according to the machining shape, purpose and the machine type.

対応被削材 Applicable work material

炭素鋼 合金鋼 Carbon steel Alloy steel	炭素鋼 合金鋼 Pre-hardened steel	高硬度 Hardened steel			ステン レス 鋼 Stainless steel	チタン合金 耐熱合金 Titanium alloy Heat-resistant alloy	銅合金 Copper alloy	アルミ 合金 Aluminum alloy
○	○	> 45HRC ≤ 55HRC	> 55HRC ≤ 65HRC	> 65HRC	○	○	○	

再研磨対応外径範囲 Re-grinding compatibility range

商品コード Item code	外周 Outer dia. (mm)	エンド End (mm)
2ESMSUSC	6 ~ 20	3 ~ 20

●印：標準在庫品です。●：Stoked items.

ESMエンドミル

ショート刃長

Short



0~-0.03



(mm)



2ESMS

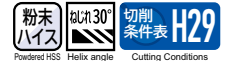

商品コード Item code	在庫 Stock	寸法 Size (mm)				希望小売価格 (円) Suggested retail price(¥)
		外径 Tool dia.	刃長 Flute length	全長 Overall length	シャンク径 Shank dia.	
2ESMS0.8	<input type="checkbox"/>	0.8	2	50	6	-
2ESMS0.9	<input type="checkbox"/>	0.9	2.2	50	6	-
2ESMS1	<input checked="" type="checkbox"/>	1	2.5	50	6	6,120
2ESMS1.1	<input type="checkbox"/>	1.1	2.5	50	6	-
2ESMS1.2	<input type="checkbox"/>	1.2	3	50	6	-
2ESMS1.3	<input type="checkbox"/>	1.3	3	50	6	-
2ESMS1.4	<input type="checkbox"/>	1.4	3	50	6	-
2ESMS1.5	<input checked="" type="checkbox"/>	1.5	3.5	50	6	5,590
2ESMS1.6	<input type="checkbox"/>	1.6	3.5	50	6	-
2ESMS1.7	<input type="checkbox"/>	1.7	3.5	50	6	-
2ESMS1.8	<input type="checkbox"/>	1.8	3.5	50	6	-
2ESMS1.9	<input type="checkbox"/>	1.9	4	50	6	-
2ESMS2	<input checked="" type="checkbox"/>	2	4	50	6	5,270
2ESMS2.1	<input type="checkbox"/>	2.1	5	50	6	-
2ESMS2.2	<input type="checkbox"/>	2.2	5	50	6	-
2ESMS2.3	<input type="checkbox"/>	2.3	5	50	6	-
2ESMS2.4	<input type="checkbox"/>	2.4	5	50	6	-
2ESMS2.5	<input checked="" type="checkbox"/>	2.5	5	50	6	5,180
2ESMS2.6	<input type="checkbox"/>	2.6	7	50	6	-
2ESMS2.7	<input type="checkbox"/>	2.7	7	50	6	-
2ESMS2.8	<input type="checkbox"/>	2.8	7	50	6	-
2ESMS2.9	<input type="checkbox"/>	2.9	7	50	6	-
2ESMS3	<input checked="" type="checkbox"/>	3	7	50	6	4,440
2ESMS3.1	<input type="checkbox"/>	3.1	8	60	8	-
2ESMS3.2	<input type="checkbox"/>	3.2	8	60	8	-
2ESMS3.3	<input type="checkbox"/>	3.3	8	60	8	-
2ESMS3.4	<input type="checkbox"/>	3.4	8	60	8	-
2ESMS3.5	<input checked="" type="checkbox"/>	3.5	8	60	8	4,440
2ESMS3.6	<input type="checkbox"/>	3.6	8	60	8	-
2ESMS3.7	<input type="checkbox"/>	3.7	8	60	8	-
2ESMS3.8	<input type="checkbox"/>	3.8	8	60	8	-
2ESMS3.9	<input type="checkbox"/>	3.9	8	60	8	-
2ESMS4	<input checked="" type="checkbox"/>	4	8	60	8	4,440
2ESMS4.1	<input type="checkbox"/>	4.1	10	60	8	-
2ESMS4.2	<input type="checkbox"/>	4.2	10	60	8	-
2ESMS4.3	<input type="checkbox"/>	4.3	10	60	8	-
2ESMS4.4	<input type="checkbox"/>	4.4	10	60	8	-
2ESMS4.5	<input checked="" type="checkbox"/>	4.5	10	60	8	4,440
2ESMS4.6	<input type="checkbox"/>	4.6	10	60	8	-
2ESMS4.7	<input type="checkbox"/>	4.7	10	60	8	-
2ESMS4.8	<input type="checkbox"/>	4.8	10	60	8	-
2ESMS4.9	<input type="checkbox"/>	4.9	10	60	8	-
2ESMS5	<input checked="" type="checkbox"/>	5	10	60	8	4,440
2ESMS5.1	<input type="checkbox"/>	5.1	12	60	8	-
2ESMS5.2	<input type="checkbox"/>	5.2	12	60	8	-
2ESMS5.3	<input type="checkbox"/>	5.3	12	60	8	-
2ESMS5.4	<input type="checkbox"/>	5.4	12	60	8	-

商品コード Item code	在庫 Stock	寸法 Size (mm)				希望小売価格 (円) Suggested retail price(¥)
		外径 Tool dia.	刃長 Flute length	全長 Overall length	シャンク径 Shank dia.	
2ESMS5.5	<input checked="" type="checkbox"/>	5.5	12	60	8	4,440
2ESMS5.6	<input type="checkbox"/>	5.6	12	60	8	-
2ESMS5.7	<input type="checkbox"/>	5.7	12	60	8	-
2ESMS5.8	<input type="checkbox"/>	5.8	12	60	8	-
2ESMS5.9	<input type="checkbox"/>	5.9	12	60	8	-
2ESMS6	<input checked="" type="checkbox"/>	6	12	60	8	4,440
2ESMS6.1	<input type="checkbox"/>	6.1	14	65	10	-
2ESMS6.2	<input type="checkbox"/>	6.2	14	65	10	-
2ESMS6.3	<input type="checkbox"/>	6.3	14	65	10	-
2ESMS6.4	<input type="checkbox"/>	6.4	14	65	10	-
2ESMS6.5	<input checked="" type="checkbox"/>	6.5	14	65	10	4,880
2ESMS6.6	<input type="checkbox"/>	6.6	14	65	10	-
2ESMS6.7	<input type="checkbox"/>	6.7	14	65	10	-
2ESMS6.8	<input type="checkbox"/>	6.8	14	65	10	-
2ESMS6.9	<input type="checkbox"/>	6.9	14	65	10	-
2ESMS7	<input checked="" type="checkbox"/>	7	14	65	10	4,880
2ESMS7.1	<input type="checkbox"/>	7.1	14	65	10	-
2ESMS7.2	<input type="checkbox"/>	7.2	14	65	10	-
2ESMS7.3	<input type="checkbox"/>	7.3	14	65	10	-
2ESMS7.4	<input type="checkbox"/>	7.4	14	65	10	-
2ESMS7.5	<input checked="" type="checkbox"/>	7.5	14	65	10	4,880
2ESMS7.6	<input type="checkbox"/>	7.6	14	65	10	-
2ESMS7.7	<input type="checkbox"/>	7.7	14	65	10	-
2ESMS7.8	<input type="checkbox"/>	7.8	14	65	10	-
2ESMS7.9	<input type="checkbox"/>	7.9	14	65	10	-
2ESMS8	<input checked="" type="checkbox"/>	8	14	65	10	4,880
2ESMS8.1	<input type="checkbox"/>	8.1	18	70	10	-
2ESMS8.2	<input type="checkbox"/>	8.2	18	70	10	-
2ESMS8.3	<input type="checkbox"/>	8.3	18	70	10	-
2ESMS8.4	<input type="checkbox"/>	8.4	18	70	10	-
2ESMS8.5	<input checked="" type="checkbox"/>	8.5	18	70	10	5,630
2ESMS8.6	<input type="checkbox"/>	8.6	18	70	10	-
2ESMS8.7	<input type="checkbox"/>	8.7	18	70	10	-
2ESMS8.8	<input type="checkbox"/>	8.8	18	70	10	-
2ESMS8.9	<input type="checkbox"/>	8.9	18	70	10	-
2ESMS9	<input checked="" type="checkbox"/>	9	18	70	10	5,630
2ESMS9.1	<input type="checkbox"/>	9.1	18	75	10	-
2ESMS9.2	<input type="checkbox"/>	9.2	18	75	10	-
2ESMS9.3	<input type="checkbox"/>	9.3	18	75	10	-
2ESMS9.4	<input type="checkbox"/>	9.4	18	75	10	-
2ESMS9.5	<input checked="" type="checkbox"/>	9.5	18	75	10	5,630
2ESMS9.6	<input type="checkbox"/>	9.6	18	75	10	-
2ESMS9.7	<input type="checkbox"/>	9.7	18	75	10	-
2ESMS9.8	<input type="checkbox"/>	9.8	18	75	10	-
2ESMS9.9	<input type="checkbox"/>	9.9	18	75	10	-
2ESMS10	<input checked="" type="checkbox"/>	10	18	75	10	5,630
2ESMS10.5	<input type="checkbox"/>	10.5	22	80	12	-

商品コード Item code	在庫 Stock	寸法 Size (mm)				希望小売価格 (円) Suggested retail price(¥)
		外径 Tool dia.	刃長 Flute length	全長 Overall length	シャンク径 Shank dia.	
2ESMS11	<input checked="" type="checkbox"/>	11	22	80	12	7,200
2ESMS11.5	<input type="checkbox"/>	11.5	22	80	12	-
2ESMS12	<input checked="" type="checkbox"/>	12	22	80	12	7,200
2ESMS12.5	<input type="checkbox"/>	12.5	25	95	16	-
2ESMS13	<input checked="" type="checkbox"/>	13	25	90	12	9,490
2ESMS13.5	<input type="checkbox"/>	13.5	25	95	16	-
2ESMS14	<input checked="" type="checkbox"/>	14	25	95	16	9,490
2ESMS14.5	<input type="checkbox"/>	14.5	30	100	16	-
2ESMS15	<input checked="" type="checkbox"/>	15	30	100	16	10,540
2ESMS15.5	<input type="checkbox"/>	15.5	30	100	16	-
2ESMS16	<input checked="" type="checkbox"/>	16	30	100	16	11,380
2ESMS16.5	<input type="checkbox"/>	16.5	35	115	20	-
2ESMS17	<input type="checkbox"/>	17	35	105	16	-
2ESMS17.5	<input type="checkbox"/>	17.5	35	115	20	-
2ESMS18	<input checked="" type="checkbox"/>	18	35	105	16	13,620
2ESMS18.5	<input type="checkbox"/>	18.5	40	120	20	-
2ESMS19	<input type="checkbox"/>	19	40	120	20	-
2ESMS19.5	<input type="checkbox"/>	19.5	40	120	20	-
2ESMS20	<input checked="" type="checkbox"/>	20	40	120	20	16,370
2ESMS21	<input type="checkbox"/>	21	40	120	20	-
2ESMS22	<input type="checkbox"/>	22	40	120	20	-
2ESMS23	<input type="checkbox"/>	23	50	120	25	-
2ESMS24	<input type="checkbox"/>	24	50	120	25	-
2ESMS25	<input type="checkbox"/>	25	50	120	25	-
2ESMS26	<input type="checkbox"/>	26	50	120	25	-
2ESMS27	<input type="checkbox"/>	27	55	125	25	-
2ESMS28	<input type="checkbox"/>	28	55	125	25	-
2ESMS29	<input type="checkbox"/>	29	55	125	25	-
2ESMS30	<input type="checkbox"/>	30	55	125	25	-

●印：標準在庫品です。 □印：特定代理店在庫です。弊社営業へお問合せください。
● : Stocked items. □ : Stocked by specified distributor. Contact with our sales department.

レギュラー刃長

Regular



外径公差 Dia.tolerance 0~-0.03



(mm)



2ESMR

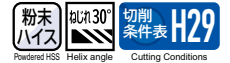

商品コード Item code	在庫 Stock	寸法 Size (mm)				希望小売 価格(円) Suggested retail price(¥)
		外径 Tool dia.	刃長 Flute length	全長 Overall length	シャンク径 Shank dia.	
2ESMR1	●	1	3.5	55	6	6,120
2ESMR1.5	●	1.5	5	55	6	5,590
2ESMR2	●	2	5	55	6	5,270
2ESMR2.5	●	2.5	7	55	6	5,180
2ESMR3	●	3	10	55	6	4,440
2ESMR3.5	●	3.5	12	60	8	4,440
2ESMR4	●	4	12	60	8	4,440
2ESMR4.5	●	4.5	15	60	8	4,440
2ESMR5	●	5	15	60	8	4,440
2ESMR5.5	●	5.5	15	60	8	4,440
2ESMR6	●	6	15	60	8	4,440
2ESMR6.5	●	6.5	20	70	10	4,880
2ESMR7	●	7	20	70	10	4,880
2ESMR7.5	●	7.5	20	70	10	4,880
2ESMR8	●	8	20	70	10	4,880
2ESMR8.5	●	8.5	25	80	10	5,630
2ESMR9	●	9	25	80	10	5,630
2ESMR9.5	●	9.5	25	80	10	5,630
2ESMR10	●	10	25	80	10	5,630
2ESMR10.5	□	10.5	30	95	12	-
2ESMR11	●	11	30	95	12	7,200
2ESMR11.5	□	11.5	30	95	12	-
2ESMR12	●	12	30	95	12	7,200
2ESMR12.5	□	12.5	35	105	16	-
2ESMR13	●	13	35	100	12	9,490
2ESMR13.5	□	13.5	35	105	16	-
2ESMR14	●	14	35	105	16	9,490
2ESMR14.5	□	14.5	40	110	16	-
2ESMR15	●	15	40	110	16	10,540
2ESMR15.5	□	15.5	40	110	16	-
2ESMR16	●	16	40	110	16	11,380
2ESMR16.5	□	16.5	40	120	20	-
2ESMR17	●	17	40	110	16	13,620
2ESMR17.5	□	17.5	40	120	20	-
2ESMR18	●	18	40	110	16	13,620

商品コード Item code	在庫 Stock	寸法 Size (mm)				希望小売 価格(円) Suggested retail price(¥)
		外径 Tool dia.	刃長 Flute length	全長 Overall length	シャンク径 Shank dia.	
2ESMR18.5	□	18.5	45	125	20	-
2ESMR19	□	19	45	125	20	-
2ESMR19.5	□	19.5	45	125	20	-
2ESMR20	●	20	45	125	20	16,370
2ESMR21	□	21	45	125	20	-
2ESMR22	●	22	45	125	20	20,900
2ESMR23	□	23	50	140	25	-
2ESMR24	●	24	50	140	25	24,200
2ESMR25	●	25	50	140	25	24,200
2ESMR26	●	26	50	140	25	26,820
2ESMR27	□	27	55	145	25	-
2ESMR28	□	28	55	145	25	-
2ESMR29	□	29	55	145	25	-
2ESMR30	●	30	55	145	25	38,640
2ESMR31	□	31	60	160	32	-
2ESMR32	□	32	60	160	32	-
2ESMR33	□	33	60	160	32	-
2ESMR34	□	34	60	160	32	-
2ESMR35	□	35	60	160	32	-
2ESMR36	□	36	60	160	32	-
2ESMR37	□	37	60	160	32	-
2ESMR38	□	38	65	165	32	-
2ESMR39	□	39	65	165	32	-
2ESMR40	□	40	65	165	32	-

2ESMS, 2ESMRの対応被削材

Applicable work material of 2ESMS, 2ESMR

炭素鋼 合金鋼 Carbon steel Alloy steel	炭素鋼 合金鋼 Pre-hardened steel ≤ 45HRC	高硬度 Hardened steel			ステン レス鋼 Stainless steel	チタン合金 耐熱合金 Titanium alloy Heat-resistant alloy	銅合金 Copper alloy	アルミ 合金 Aluminum alloy
		> 45HRC ≤ 55HRC	> 55HRC ≤ 65HRC	> 65HRC				
○					○	○	○	

再研磨対応外径範囲

Re-grinding compatibility range

商品コード Item code	外周 Outer dia. (mm)	エンド End (mm)
2ESMS	6 ~ 30	4 ~ 30
2ESMR	6 ~ 40	4 ~ 40

ESMエンドミル

ロング刃長

Long



0~-0.03



(mm)



ステンレス用

for Stainless Steel



0~-0.03



(mm)



2ESML

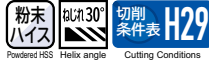

2ESMSUS



商品コード Item code	在庫 Stock	寸法 Size (mm)				希望小売 価格(円) Suggested retail price(¥)
		外径 Tool dia.	刃長 Flute length	全長 Overall length	シャンク径 Shank dia.	
2ESML3	●	3	15	60	6	5,270
2ESML4	●	4	20	65	6	5,270
2ESML5	●	5	25	70	6	5,270
2ESML6	●	6	25	70	6	5,270
2ESML7	□	7	35	85	8	-
2ESML8	●	8	35	85	8	6,120
2ESML9	□	9	45	100	10	-
2ESML10	●	10	45	100	10	6,840
2ESML11	□	11	55	120	12	-
2ESML12	●	12	55	120	12	8,380
2ESML13	□	13	55	120	12	-
2ESML14	●	14	55	125	16	11,490
2ESML15	●	15	65	135	16	12,730
2ESML16	●	16	65	135	16	14,170
2ESML17	□	17	65	135	16	-
2ESML18	●	18	65	135	16	17,190
2ESML19	□	19	75	155	20	-
2ESML20	●	20	75	155	20	19,800
2ESML21	□	21	75	155	20	-
2ESML22	□	22	75	155	20	-
2ESML23	□	23	90	180	25	-
2ESML24	□	24	90	180	25	-
2ESML25	●	25	90	180	25	32,870
2ESML26	□	26	90	180	25	-
2ESML27	□	27	90	180	25	-
2ESML28	□	28	90	180	25	-
2ESML29	□	29	90	180	25	-
2ESML30	●	30	90	180	25	51,840
2ESML31	□	31	95	195	32	-
2ESML32	□	32	95	195	32	-
2ESML33	□	33	95	195	32	-
2ESML34	□	34	95	195	32	-
2ESML35	□	35	100	200	32	-
2ESML36	□	36	100	200	32	-
2ESML37	□	37	100	200	32	-
2ESML38	□	38	105	205	32	-
2ESML39	□	39	110	210	32	-
2ESML40	□	40	110	210	32	-

商品コード Item code	在庫 Stock	寸法 Size (mm)				希望小売 価格(円) Suggested retail price(¥)
		外径 Tool dia.	刃長 Flute length	全長 Overall length	シャンク径 Shank dia.	
2ESMSUS1.5	●	1.5	3.5	50	6	4,890
2ESMSUS2	●	2	4	50	6	4,590
2ESMSUS2.5	●	2.5	5	50	6	4,530
2ESMSUS3	●	3	7	50	6	3,890
2ESMSUS3.5	●	3.5	8	60	8	3,890
2ESMSUS4	●	4	8	60	8	3,890
2ESMSUS4.5	●	4.5	10	60	8	3,890
2ESMSUS5	●	5	10	60	8	3,890
2ESMSUS5.5	●	5.5	12	60	8	3,890
2ESMSUS6	●	6	12	60	8	3,890
2ESMSUS6.5	●	6.5	14	65	10	4,230
2ESMSUS7	●	7	14	65	10	4,230
2ESMSUS7.5	●	7.5	14	65	10	4,230
2ESMSUS8	●	8	14	65	10	4,230
2ESMSUS8.5	●	8.5	18	70	10	4,890
2ESMSUS9	●	9	18	70	10	4,890
2ESMSUS9.5	●	9.5	18	75	10	4,890
2ESMSUS10	●	10	18	75	10	4,890
2ESMSUS11	●	11	22	80	12	6,290
2ESMSUS12	●	12	22	80	12	6,290
2ESMSUS13	●	13	25	95	16	7,830
2ESMSUS14	●	14	25	95	16	7,830
2ESMSUS15	●	15	30	100	16	8,730
2ESMSUS16	●	16	30	100	16	9,390
2ESMSUS17	●	17	35	115	20	11,190
2ESMSUS18	●	18	35	115	20	11,190
2ESMSUS19	●	19	40	120	20	13,450
2ESMSUS20	●	20	40	120	20	13,450
2ESMSUS21	□	21	40	120	20	-
2ESMSUS22	●	22	40	120	20	17,050
2ESMSUS23	□	23	50	120	25	-
2ESMSUS24	□	24	50	120	25	-
2ESMSUS25	●	25	50	120	25	19,800
2ESMSUS26	□	26	50	120	25	-
2ESMSUS27	□	27	55	125	25	-
2ESMSUS28	□	28	55	125	25	-
2ESMSUS29	□	29	55	125	25	-
2ESMSUS30	●	30	55	125	25	31,770

2ESML、2ESMSUSの対応被削材

Applicable work material of 2ESML, 2ESMSUS

炭素鋼 合金鋼 Carbon steel Alloy steel	炭素鋼 合金鋼 Pre-hardened steel ≤ 45HRC	高硬度 Hardened steel			ステン レス鋼 Stainless steel	チタン合金 耐熱合金 Titanium alloy Heat-resistant alloy	銅合金 Copper alloy	アルミ 合金 Aluminum alloy
		> 45HRC ≤ 55HRC	> 55HRC ≤ 65HRC	> 65HRC				
○	○	○	○	○	○	○	○	

●印：標準在庫品です。 □印：特定代理店在庫です。弊社営業へお問合せください。
●：Stoked items. □：Stocked by specified distributor. Contact with our sales department.

再研磨対応外径範囲

Re-grinding compatibility range

商品コード Item code	外周 Outer dia. (mm)	エンド End (mm)
2ESML	6 ~ 40	3 ~ 40
2ESMSUS	6 ~ 30	4 ~ 30

標準切削条件表 Recommended cutting conditions

寸法表 Size list : H26 寸法表 Size list : H27 寸法表 Size list : H28 寸法表 Size list : H42 寸法表 Size list : H42
2ESMS **2ESMR (注②)** **2ESML (注②)** **4ESMR (注①②)** **4ESML (注①②)**
 2枚刃・ショート刃長 2枚刃・レギュラー刃長 2枚刃・ロング刃長 4枚刃・レギュラー刃長 4枚刃・ロング刃長
 2ft, Short 2ft, Regular 2ft, Long 4ft, Regular 4ft, Long

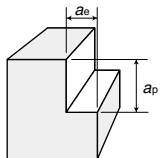

<側面切削> Side milling

被削材 (硬さ) Work material (Hardness)	条件域 Condition Range	切込み Depth of cut mm	切削条件 Cutting Conditions	外径 DC Tool dia. (mm)											
				φ3	φ4	φ6	φ8	φ10	φ12	φ16	φ20	φ25	φ30	φ35	φ40
鋳鉄・炭素鋼 Cast irons, Carbon steels (200HB以下) FC200 SS400, S45C	汎用条件 General	ap=1.5DC ae=0.1DC	回転数 min ⁻¹	4,200	3,200	2,100	1,600	1,280	1,060	800	640	510	420	360	320
			送り速度 mm/min	150	160	165	170	190	190	175	170	130	110	95	85
合金鋼 Alloy steels (200~250HB) SCM, SNCM	汎用条件 General	ap=1.5DC ae=0.1DC	回転数 min ⁻¹	3,200	2,400	1,600	1,200	950	800	600	480	380	320	270	240
			送り速度 mm/min	115	120	125	125	140	140	130	120	100	85	70	60
工具鋼・ステンレス鋼 Tool steels, Stainless steels (25~35HRC) SKD, SKT, SUS304	汎用条件 General	ap=1.5DC ae=0.1DC	回転数 min ⁻¹	2,600	1,900	1,300	950	750	600	500	380	300	270	220	190
			送り速度 mm/min	95	100	100	100	110	110	110	100	80	70	55	50
焼入れ鋼・プリハードン鋼 Hardened steels, Pre-Harden steels (35~45HRC) SKD, SKT, HPM1, NAK55	汎用条件 General	ap=1.5DC ae=0.1DC	回転数 min ⁻¹	2,100	1,500	1,100	790	630	530	400	350	280	240	180	
			送り速度 mm/min	60	60	80	80	80	80	80	80	75	60	45	
耐熱鋼・チタン合金 Heat-resistant steels, Titanium alloys Inconel Ti-6Al-4V	汎用条件 General	ap=1.5DC ae=0.1DC	回転数 min ⁻¹	1,000	800	800	400	310	260	200	160	120	100	90	
			送り速度 mm/min	30	30	30	30	30	30	30	30	25	20	20	
アルミ合金・非鉄金属 Aluminum alloys Non Ferrous	汎用条件 General	ap=1.5DC ae=0.1DC	回転数 min ⁻¹	10,000	8,000	5,300	4,000	3,200	2,600	2,000	1,600	1,250	1,000	900	
			送り速度 mm/min	350	400	400	450	450	450	450	400	400	300	250	

- [注意]** ①被削材、加工形状に合わせて、適切なクーラントを使用してください。
 ②この標準切削条件表は切削条件の目安を示すものです。実際の加工では加工形状、目的、使用機械等により条件を調整してください。
 ③上表の切削条件は2枚刃の場合を示します。4枚刃は、送り速度を約2倍にしてください。
 ④レギュラー刃の場合は回転数と送り速度を約70%に、ロング刃の場合は約50%にしてください。
- [Note]** ① Use the appropriate coolant for the work material and machining shape.
 ② These Recommended Cutting Conditions indicate only the rule of a thumb for the cutting conditions. In actual machining, the condition should be adjusted according to the machining shape, purpose and the machine type.
 ③ The cutting conditions given above is applied to 2-flute type end mills. As for 4-flute type, increase the feed speed twice.
 ④ As for Regular type, decrease the revolution number and the feed speed to around 70% of the values given in the table. As for the long length type, decrease them to around 50% or less.

寸法表 Size list : H26 寸法表 Size list : H27
2ESMS **2ESMR (注②)**
 2枚刃・ショート刃長 2枚刃・レギュラー刃長
 2ft, Short 2ft, Regular

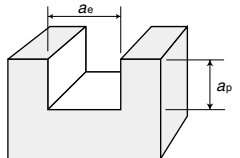

<溝切削> Slotting

被削材 (硬さ) Work material (Hardness)	条件域 Condition Range	切込み Depth of cut mm	切削条件 Cutting Conditions	外径 DC Tool dia. (mm)										
				φ3	φ4	φ6	φ8	φ10	φ12	φ16	φ20	φ25	φ30	φ35
鋳鉄・炭素鋼 Cast irons, Carbon steels (200HB以下) FC200 SS400, S45C	汎用条件 General	ap=0.5DC ae=1DC	回転数 min ⁻¹	2,600	2,000	1,300	1,000	800	660	500	400	320	260	230
			送り速度 mm/min	75	85	100	110	120	120	100	100	80	70	60
合金鋼 Alloy steels (200~250HB) SCM, SNCM	汎用条件 General	ap=0.5DC ae=1DC	回転数 min ⁻¹	2,100	1,600	1,000	800	640	530	400	320	260	210	180
			送り速度 mm/min	40	50	60	80	80	70	70	60	50	40	35
工具鋼・ステンレス鋼 Tool steels, Stainless steels (25~35HRC) SKD, SKT, SUS304	汎用条件 General	ap=0.5DC ae=1DC	回転数 min ⁻¹	1,700	1,200	850	640	510	420	320	260	200	160	145
			送り速度 mm/min	35	40	40	50	50	50	50	50	40	30	25
焼入れ鋼・プリハードン鋼 Hardened steels, Pre-Harden steels (35~45HRC) SKD, SKT, HPM1, NAK55	汎用条件 General	ap=0.5DC ae=1DC	回転数 min ⁻¹	1,300	960	640	480	380	320	240	190	150	130	110
			送り速度 mm/min	20	25	25	30	40	40	40	40	30	25	20
耐熱鋼・チタン合金 Heat-resistant steels, Titanium alloys Inconel Ti-6Al-4V	汎用条件 General	ap=0.5DC ae=1DC	回転数 min ⁻¹				200	160	130	100	80	60	50	45
			送り速度 mm/min				12	12	12	12	12	12	10	8

- [注意]** ①被削材、加工形状に合わせて適切なクーラントを使用してください。
 ②この標準切削条件表は切削条件の目安を示すものです。実際の加工では加工形状、目的、使用機械等により条件を調整してください。
 ③ロング刃は溝切削に適しません。
 ④レギュラー刃の場合は回転数と送り速度を約70%にしてください。
- [Note]** ① Use the appropriate coolant for the work material and machining shape.
 ② These Recommended Cutting Conditions indicate only the rule of a thumb for the cutting conditions. In actual machining, the condition should be adjusted according to the machining shape, purpose and the machine type.
 ③ The long length type is not suited to slotting.
 ④ As for Regular type, decrease the revolution number and the feed speed to around 70% of the values given in the table.



0~0.03



(mm)



2NKS

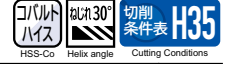

商品コード Item code	在庫 Stock	寸法 Size (mm)				希望小売価格 (円) Suggested retail price(¥)
		外径 Tool dia.	刃長 Flute length	全長 Overall length	シャンク径 Shank dia.	
2NKS0.8	●	0.8	1.6	55	6	5,000
2NKS0.9	●	0.9	2	55	6	5,000
2NKS1	●	1	2.5	55	6	3,830
2NKS1.05	□	1.05	3	55	6	-
2NKS1.1	●	1.1	2.5	55	6	5,000
2NKS1.15	□	1.15	3	55	6	-
2NKS1.2	●	1.2	3	55	6	5,000
2NKS1.25	□	1.25	3	55	6	-
2NKS1.3	●	1.3	3	55	6	5,000
2NKS1.35	□	1.35	3	55	6	-
2NKS1.4	●	1.4	3	55	6	5,000
2NKS1.45	□	1.45	3	55	6	-
2NKS1.5	●	1.5	3.5	55	6	3,490
2NKS1.55	□	1.55	4	55	6	-
2NKS1.6	●	1.6	3.5	55	6	4,530
2NKS1.65	□	1.65	4	55	6	-
2NKS1.7	●	1.7	3.5	55	6	4,530
2NKS1.75	□	1.75	4	55	6	-
2NKS1.8	●	1.8	3.5	55	6	4,530
2NKS1.85	□	1.85	4	55	6	-
2NKS1.9	●	1.9	3.5	55	6	4,530
2NKS1.95	□	1.95	4	55	6	-
2NKS2	●	2	4	55	6	3,290
2NKS2.05	□	2.05	6	60	6	-
2NKS2.1	●	2.1	5	55	6	4,300
2NKS2.15	□	2.15	6	60	6	-
2NKS2.2	●	2.2	5	55	6	4,300
2NKS2.25	□	2.25	6	60	6	-
2NKS2.3	●	2.3	5	55	6	4,300
2NKS2.35	□	2.35	6	60	6	-
2NKS2.4	●	2.4	5	55	6	4,300
2NKS2.45	□	2.45	6	60	6	-
2NKS2.5	●	2.5	5	55	6	3,240
2NKS2.55	□	2.55	8	60	6	-
2NKS2.6	●	2.6	7	55	6	4,200
2NKS2.65	□	2.65	8	60	6	-
2NKS2.7	●	2.7	7	55	6	4,200
2NKS2.75	□	2.75	8	60	6	-
2NKS2.8	●	2.8	7	55	6	4,200
2NKS2.85	□	2.85	8	60	6	-
2NKS2.9	●	2.9	7	55	6	4,200
2NKS2.95	□	2.95	8	60	6	-
2NKS3	●	3	7	55	6	2,850
2NKS3.05	□	3.05	12	60	6	-
2NKS3.1	●	3.1	8	65	8	3,740
2NKS3.15	□	3.15	12	60	6	-
2NKS3.2	●	3.2	8	65	8	3,740
2NKS3.25	□	3.25	12	60	6	-
2NKS3.3	●	3.3	8	65	8	3,740
2NKS3.35	□	3.35	14	65	8	-
2NKS3.4	●	3.4	8	65	8	3,740
2NKS3.45	□	3.45	14	65	8	-
2NKS3.5	●	3.5	8	65	8	2,850

商品コード Item code	在庫 Stock	寸法 Size (mm)				希望小売価格 (円) Suggested retail price(¥)
		外径 Tool dia.	刃長 Flute length	全長 Overall length	シャンク径 Shank dia.	
2NKS3.55	□	3.55	14	65	8	-
2NKS3.6	●	3.6	8	65	8	3,740
2NKS3.65	□	3.65	14	65	8	-
2NKS3.7	●	3.7	8	65	8	3,740
2NKS3.75	□	3.75	14	65	8	-
2NKS3.8	●	3.8	8	65	8	3,740
2NKS3.85	□	3.85	14	65	8	-
2NKS3.9	●	3.9	8	65	8	3,740
2NKS3.95	□	3.95	14	65	8	-
2NKS4	●	4	8	65	8	2,850
2NKS4.05	□	4.05	14	65	8	-
2NKS4.1	●	4.1	10	65	8	3,740
2NKS4.15	□	4.15	14	65	8	-
2NKS4.2	●	4.2	10	65	8	3,740
2NKS4.25	□	4.25	14	65	8	-
2NKS4.3	●	4.3	10	65	8	3,740
2NKS4.35	□	4.35	14	65	8	-
2NKS4.4	●	4.4	10	65	8	3,740
2NKS4.45	□	4.45	14	65	8	-
2NKS4.5	●	4.5	10	65	8	2,850
2NKS4.55	□	4.55	16	65	8	-
2NKS4.6	●	4.6	10	65	8	3,740
2NKS4.65	□	4.65	16	65	8	-
2NKS4.7	●	4.7	10	65	8	3,740
2NKS4.75	□	4.75	16	65	8	-
2NKS4.8	●	4.8	10	65	8	3,740
2NKS4.85	□	4.85	16	65	8	-
2NKS4.9	●	4.9	10	65	8	3,740
2NKS4.95	□	4.95	16	65	8	-
2NKS5	●	5	10	65	8	2,850
2NKS5.05	□	5.05	16	65	8	-
2NKS5.1	●	5.1	12	65	8	3,740
2NKS5.15	□	5.15	16	65	8	-
2NKS5.2	●	5.2	12	65	8	3,740
2NKS5.25	□	5.25	16	65	8	-
2NKS5.3	●	5.3	12	65	8	3,740
2NKS5.35	□	5.35	16	65	8	-
2NKS5.4	●	5.4	12	65	8	3,740
2NKS5.45	□	5.45	16	65	8	-
2NKS5.5	●	5.5	12	65	8	2,850
2NKS5.55	□	5.55	16	65	8	-
2NKS5.6	●	5.6	12	65	8	3,740
2NKS5.65	□	5.65	16	65	8	-
2NKS5.7	●	5.7	12	65	8	3,740
2NKS5.75	□	5.75	16	65	8	-
2NKS5.8	●	5.8	12	65	8	3,740
2NKS5.85	□	5.85	16	65	8	-
2NKS5.9	●	5.9	12	65	8	3,740
2NKS5.95	□	5.95	16	65	8	-
2NKS6	●	6	12	65	8	2,850
2NKS6.05	□	6.05	16	65	8	-
2NKS6.1	●	6.1	14	70	10	4,090
2NKS6.15	□	6.15	16	65	8	-

商品コード Item code	在庫 Stock	寸法 Size (mm)				希望小売価格 (円) Suggested retail price(¥)
		外径 Tool dia.	刃長 Flute length	全長 Overall length	シャンク径 Shank dia.	
2NKS6.2	●	6.2	14	70	10	4,090
2NKS6.25	□	6.25	16	65	8	-
2NKS6.3	●	6.3	14	70	10	4,090
2NKS6.35	□	6.35	16	65	8	-
2NKS6.4	●	6.4	14	70	10	4,090
2NKS6.45	□	6.45	16	65	8	-
2NKS6.5	●	6.5	14	70	10	3,140
2NKS6.55	□	6.55	21	75	10	-
2NKS6.6	●	6.6	14	70	10	4,090
2NKS6.65	□	6.65	21	75	10	-
2NKS6.7	●	6.7	14	70	10	4,090
2NKS6.75	□	6.75	21	75	10	-
2NKS6.8	●	6.8	14	70	10	4,090
2NKS6.85	□	6.85	21	75	10	-
2NKS6.9	●	6.9	14	70	10	4,090
2NKS6.95	□	6.95	21	75	10	-
2NKS7	●	7	14	70	10	3,140
2NKS7.05	□	7.05	21	75	10	-
2NKS7.1	●	7.1	14	70	10	4,090
2NKS7.15	□	7.15	21	75	10	-
2NKS7.2	●	7.2	14	70	10	4,090
2NKS7.25	□	7.25	21	75	10	-
2NKS7.3	●	7.3	14	70	10	4,090
2NKS7.35	□	7.35	21	75	10	-
2NKS7.4	●	7.4	14	70	10	4,090
2NKS7.45	□	7.45	21	75	10	-
2NKS7.5	●	7.5	14	70	10	3,140
2NKS7.55	□	7.55	21	75	10	-
2NKS7.6	●	7.6	14	70	10	4,090
2NKS7.65	□	7.65	21	75	10	-
2NKS7.7	●	7.7	14	70	10	4,090
2NKS7.75	□	7.75	21	75	10	-
2NKS7.8	●	7.8	14	70	10	4,090
2NKS7.85	□	7.85	21	75	10	-
2NKS7.9	●	7.9	14	70	10	4,090
2NKS7.95	□	7.95	21	75	10	-
2NKS8	●	8	14	70	10	3,140
2NKS8.05	□	8.05	21	75	10	-
2NKS8.1	●	8.1	18	75	10	4,740
2NKS8.15	□	8.15	21	75	10	-
2NKS8.2	●	8.2	18	75	10	4,740
2NKS8.25	□	8.25	21	75	10	-
2NKS8.3	●	8.3	18	75	10	4,740
2NKS8.35	□	8.35	21	75	10	-
2NKS8.4	●	8.4	18	75	10	4,740
2NKS8.45	□	8.45	21	75	10	-
2NKS8.5	●	8.5	18	75	10	3,640
2NKS8.55	□	8.55	26	85	10	-
2NKS8.6	●	8.6	18	75	10	4,740
2NKS8.65	□	8.65	26	85	10	-
2NKS8.7	●	8.7	18	75	10	4,740
2NKS8.75	□	8.75	26	85	10	-
2NKS8.8	●	8.8	18	75	10	4,740

●印：標準在庫品です。●：Stoked items。□印：特定代理店在庫です。弊社営業へお問い合わせください。□：Stocked by specified distributor. Contact with our sales department.

2NKS

商品コード Item code	在庫 Stock	寸法 Size (mm)				希望小売価格 (円) Suggested retail price(¥)
		外径 Tool dia.	刃長 Flute length	全長 Overall length	シャンク径 Shank dia.	
2NKS8.85	□	8.85	26	85	10	-
2NKS8.9	●	8.9	18	75	10	4,740
2NKS8.95	□	8.95	26	85	10	-
2NKS9	●	9	18	75	10	3,640
2NKS9.05	□	9.05	26	85	10	-
2NKS9.1	●	9.1	18	75	10	4,740
2NKS9.15	□	9.15	26	85	10	-
2NKS9.2	●	9.2	18	75	10	4,740
2NKS9.25	□	9.25	26	85	10	-
2NKS9.3	●	9.3	18	75	10	4,740
2NKS9.35	□	9.35	26	85	10	-
2NKS9.4	●	9.4	18	75	10	4,740
2NKS9.45	□	9.45	26	85	10	-
2NKS9.5	●	9.5	18	75	10	3,640
2NKS9.55	□	9.55	26	85	10	-
2NKS9.6	●	9.6	18	75	10	4,740
2NKS9.65	□	9.65	26	85	10	-
2NKS9.7	●	9.7	18	75	10	4,740
2NKS9.75	□	9.75	26	85	10	-
2NKS9.8	●	9.8	18	75	10	4,740
2NKS9.85	□	9.85	26	85	10	-
2NKS9.9	●	9.9	18	75	10	4,740
2NKS9.95	□	9.95	26	85	10	-
2NKS10	●	10	18	75	10	3,640
2NKS10.05	□	10.05	26	85	10	-
2NKS10.1	□	10.1	22	85	12	-
2NKS10.15	□	10.15	26	85	10	-
2NKS10.2	□	10.2	22	85	12	-
2NKS10.25	□	10.25	26	85	10	-
2NKS10.3	□	10.3	22	85	12	-
2NKS10.35	□	10.35	26	85	10	-
2NKS10.4	□	10.4	22	85	12	-
2NKS10.45	□	10.45	26	85	10	-
2NKS10.5	●	10.5	22	85	12	6,090
2NKS10.55	□	10.55	31	95	12	-
2NKS10.6	□	10.6	22	85	12	-
2NKS10.65	□	10.65	31	95	12	-
2NKS10.7	□	10.7	22	85	12	-
2NKS10.75	□	10.75	31	95	12	-
2NKS10.8	□	10.8	22	85	12	-
2NKS10.85	□	10.85	31	95	12	-
2NKS10.9	□	10.9	22	85	12	-
2NKS10.95	□	10.95	31	95	12	-
2NKS11	●	11	22	85	12	4,700
2NKS11.05	□	11.05	31	95	12	-
2NKS11.1	□	11.1	22	85	12	-
2NKS11.15	□	11.15	31	95	12	-
2NKS11.2	□	11.2	22	85	12	-
2NKS11.25	□	11.25	31	95	12	-
2NKS11.3	□	11.3	22	85	12	-
2NKS11.35	□	11.35	31	95	12	-
2NKS11.4	□	11.4	22	85	12	-
2NKS11.45	□	11.45	31	95	12	-

商品コード Item code	在庫 Stock	寸法 Size (mm)				希望小売価格 (円) Suggested retail price(¥)
		外径 Tool dia.	刃長 Flute length	全長 Overall length	シャンク径 Shank dia.	
2NKS11.5	●	11.5	22	85	12	6,090
2NKS11.55	□	11.55	31	95	12	-
2NKS11.6	□	11.6	22	85	12	-
2NKS11.65	□	11.65	31	95	12	-
2NKS11.7	□	11.7	22	85	12	-
2NKS11.75	□	11.75	31	95	12	-
2NKS11.8	□	11.8	22	85	12	-
2NKS11.85	□	11.85	31	95	12	-
2NKS11.9	□	11.9	22	85	12	-
2NKS11.95	□	11.95	31	95	12	-
2NKS12	●	12	22	85	12	4,700
2NKS12.05	□	12.05	31	95	12	-
2NKS12.1	□	12.1	25	95	16	-
2NKS12.15	□	12.15	31	95	12	-
2NKS12.2	□	12.2	25	95	16	-
2NKS12.25	□	12.25	31	95	12	-
2NKS12.3	□	12.3	25	95	16	-
2NKS12.35	□	12.35	31	95	12	-
2NKS12.4	□	12.4	25	95	16	-
2NKS12.45	□	12.45	31	95	12	-
2NKS12.5	●	12.5	25	95	16	7,570
2NKS12.55	□	12.55	31	95	12	-
2NKS12.6	□	12.6	25	95	16	-
2NKS12.65	□	12.65	31	95	12	-
2NKS12.7	□	12.7	25	95	16	-
2NKS12.75	□	12.75	31	95	12	-
2NKS12.8	□	12.8	25	95	16	-
2NKS12.85	□	12.85	31	95	12	-
2NKS12.9	□	12.9	25	95	16	-
2NKS12.95	□	12.95	31	95	12	-
2NKS13	●	13	25	90	12	5,780
2NKS13.1	□	13.1	25	95	16	-
2NKS13.2	□	13.2	25	95	16	-
2NKS13.3	□	13.3	25	95	16	-
2NKS13.4	□	13.4	25	95	16	-
2NKS13.5	●	13.5	25	95	16	7,570
2NKS13.6	□	13.6	25	95	16	-
2NKS13.7	□	13.7	25	95	16	-
2NKS13.8	□	13.8	25	95	16	-
2NKS13.9	□	13.9	25	95	16	-
2NKS14	●	14	25	95	16	5,780
2NKS14.1	□	14.1	30	100	16	-
2NKS14.2	□	14.2	30	100	16	-
2NKS14.3	□	14.3	30	100	16	-
2NKS14.4	□	14.4	30	100	16	-
2NKS14.5	●	14.5	30	100	16	8,380
2NKS14.6	□	14.6	30	100	16	-
2NKS14.7	□	14.7	30	100	16	-
2NKS14.8	□	14.8	30	100	16	-
2NKS14.9	□	14.9	30	100	16	-
2NKS15	●	15	30	100	16	6,470
2NKS15.1	□	15.1	30	100	16	-
2NKS15.2	□	15.2	30	100	16	-

商品コード Item code	在庫 Stock	寸法 Size (mm)				希望小売価格 (円) Suggested retail price(¥)
		外径 Tool dia.	刃長 Flute length	全長 Overall length	シャンク径 Shank dia.	
2NKS15.3	□	15.3	30	100	16	-
2NKS15.4	□	15.4	30	100	16	-
2NKS15.5	●	15.5	30	100	16	9,080
2NKS15.6	□	15.6	30	100	16	-
2NKS15.7	□	15.7	30	100	16	-
2NKS15.8	□	15.8	30	100	16	-
2NKS15.9	□	15.9	30	100	16	-
2NKS16	●	16	30	100	16	6,980
2NKS16.1	□	16.1	35	115	20	-
2NKS16.2	□	16.2	35	115	20	-
2NKS16.3	□	16.3	35	115	20	-
2NKS16.4	□	16.4	35	115	20	-
2NKS16.5	●	16.5	35	115	20	10,830
2NKS16.6	□	16.6	35	115	20	-
2NKS16.7	□	16.7	35	115	20	-
2NKS16.8	□	16.8	35	115	20	-
2NKS16.9	□	16.9	35	115	20	-
2NKS17	●	17	35	105	16	8,340
2NKS17.1	□	17.1	35	115	20	-
2NKS17.2	□	17.2	35	115	20	-
2NKS17.3	□	17.3	35	115	20	-
2NKS17.4	□	17.4	35	115	20	-
2NKS17.5	●	17.5	35	115	20	10,830
2NKS17.6	□	17.6	35	115	20	-
2NKS17.7	□	17.7	35	115	20	-
2NKS17.8	□	17.8	35	115	20	-
2NKS17.9	□	17.9	35	115	20	-
2NKS18	●	18	35	105	16	8,340
2NKS18.1	□	18.1	40	120	20	-
2NKS18.2	□	18.2	40	120	20	-
2NKS18.3	□	18.3	40	120	20	-
2NKS18.4	□	18.4	40	120	20	-
2NKS18.5	●	18.5	40	120	20	13,050
2NKS18.6	□	18.6	40	120	20	-
2NKS18.7	□	18.7	40	120	20	-
2NKS18.8	□	18.8	40	120	20	-
2NKS18.9	□	18.9	40	120	20	-
2NKS19	●	19	40	120	20	10,020
2NKS19.1	□	19.1	40	120	20	-
2NKS19.2	□	19.2	40	120	20	-
2NKS19.3	□	19.3	40	120	20	-
2NKS19.4	□	19.4	40	120	20	-
2NKS19.5	●	19.5	40	120	20	13,050
2NKS19.6	□	19.6	40	120	20	-
2NKS19.7	□	19.7	40	120	20	-
2NKS19.8	□	19.8	40	120	20	-
2NKS19.9	□	19.9	40	120	20	-
2NKS20	●	20	40	120	20	10,020

○ 対応被削材 Applicable work material

炭素鋼 合金鋼 Carbon steel Alloy steel	炭素鋼 合金鋼 Pre-hardened steel ≤ 45HRC	高硬度 Hardened steel			ステン レス鋼 Stainless steel	チタン合金 耐熱合金 Titanium alloy Heat-resistant alloy	銅合金 Copper alloy	アルミ 合金 Aluminum alloy
		> 45HRC ≤ 55HRC	> 55HRC ≤ 65HRC	> 65HRC				
○					○	○	○	

○ 再研磨対応外径範囲 Re-grinding compatibility range

商品コード Item code	外周 Outer dia. (mm)	エンド End (mm)
2NKS	6 ~ 20	4 ~ 20

NKエンドミル

レギュラー刃長

Regular



外径公差 Dia.tolerance 0~-0.03



(mm)



2NKR○○.○(×○○)

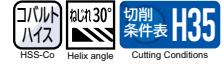

商品コード Item code	在庫 Stock	寸法 Size (mm)				希望小売価格 (円) Suggested retail price(¥)
		外径 Tool dia.	刃長 Flute length	全長 Overall length	シャンク径 Shank dia.	
2NKR2	●	2	5	55	6	3,290
2NKR2.5	●	2.5	7	55	6	3,240
2NKR3	●	3	10	55	6	2,850
2NKR3.5	●	3.5	12	60	6	2,850
2NKR4	●	4	12	60	6	2,850
2NKR4.5	●	4.5	15	60	6	2,850
2NKR5	●	5	15	60	6	2,850
2NKR5.5	●	5.5	15	60	6	2,850
2NKR6	●	6	15	60	6	2,850
2NKR6.5	●	6.5	20	70	8	3,140
2NKR7	●	7	20	70	8	3,140
2NKR7.5	●	7.5	20	70	8	3,140
2NKR8	●	8	20	70	8	3,140
2NKR8.5	●	8.5	25	80	10	3,640
2NKR9	●	9	25	80	10	3,640
2NKR9.5	●	9.5	25	80	10	3,640
2NKR10	●	10	25	80	10	3,640
2NKR10.5	●	10.5	30	95	12	6,090
2NKR11	●	11	30	95	12	4,700
2NKR11.5	●	11.5	30	95	12	6,090
2NKR12	●	12	30	95	12	4,700
2NKR12.5	●	12.5	35	105	16	7,570
2NKR13	●	13	35	100	12	5,780
2NKR13.5	●	13.5	35	105	16	7,570
2NKR14	●	14	35	105	16	5,780
2NKR14.5	●	14.5	40	110	16	8,380
2NKR15	●	15	40	110	16	6,470
2NKR15.5	●	15.5	40	110	16	9,080
2NKR16	●	16	40	110	16	6,980
2NKR16.5	●	16.5	40	120	20	10,830
2NKR17	●	17	40	110	16	8,340
2NKR17.5	●	17.5	40	120	20	10,830
2NKR18	●	18	40	110	16	8,340
2NKR18.5	●	18.5	45	125	20	13,050
2NKR19	●	19	45	125	20	10,020
2NKR19.5	●	19.5	45	125	20	13,050
2NKR20	●	20	45	125	20	10,020
2NKR20.1	□	20.1	45	135	25	-
2NKR20.2	□	20.2	45	135	25	-
2NKR20.3	□	20.3	45	135	25	-
2NKR20.4	□	20.4	45	135	25	-
2NKR20.5	□	20.5	45	135	25	-
2NKR20.6	□	20.6	45	135	25	-
2NKR20.7	□	20.7	45	135	25	-
2NKR20.8	□	20.8	45	135	25	-
2NKR20.9	□	20.9	45	135	25	-
2NKR21	●	21	45	125	20	12,690
2NKR21.1	□	21.1	45	135	25	-
2NKR21.2	□	21.2	45	135	25	-
2NKR21.3	□	21.3	45	135	25	-

商品コード Item code	在庫 Stock	寸法 Size (mm)				希望小売価格 (円) Suggested retail price(¥)
		外径 Tool dia.	刃長 Flute length	全長 Overall length	シャンク径 Shank dia.	
2NKR21.4	□	21.4	45	135	25	-
2NKR21.5	□	21.5	45	135	25	-
2NKR21.6	□	21.6	45	135	25	-
2NKR21.7	□	21.7	45	135	25	-
2NKR21.8	□	21.8	45	135	25	-
2NKR21.9	□	21.9	45	135	25	-
2NKR22	●	22	45	125	20	12,690
2NKR22.1	□	22.1	50	140	25	-
2NKR22.2	□	22.2	50	140	25	-
2NKR22.3	□	22.3	50	140	25	-
2NKR22.4	□	22.4	50	140	25	-
2NKR22.5	□	22.5	50	140	25	-
2NKR22.6	□	22.6	50	140	25	-
2NKR22.7	□	22.7	50	140	25	-
2NKR22.8	□	22.8	50	140	25	-
2NKR22.9	□	22.9	50	140	25	-
2NKR23	●	23	50	140	25	14,720
2NKR23.1	□	23.1	50	140	25	-
2NKR23.2	□	23.2	50	140	25	-
2NKR23.3	□	23.3	50	140	25	-
2NKR23.4	□	23.4	50	140	25	-
2NKR23.5	□	23.5	50	140	25	-
2NKR23.6	□	23.6	50	140	25	-
2NKR23.7	□	23.7	50	140	25	-
2NKR23.8	□	23.8	50	140	25	-
2NKR23.9	□	23.9	50	140	25	-
2NKR24	●	24	50	140	25	14,720
2NKR24.1	□	24.1	50	140	25	-
2NKR24.2	□	24.2	50	140	25	-
2NKR24.3	□	24.3	50	140	25	-
2NKR24.4	□	24.4	50	140	25	-
2NKR24.5	□	24.5	50	140	25	-
2NKR24.6	□	24.6	50	140	25	-
2NKR24.7	□	24.7	50	140	25	-
2NKR24.8	□	24.8	50	140	25	-
2NKR24.9	□	24.9	50	140	25	-
2NKR25	●	25	50	140	25	14,720
2NKR25.1	□	25.1	50	140	25	-
2NKR25.2	□	25.2	50	140	25	-
2NKR25.3	□	25.3	50	140	25	-
2NKR25.4	□	25.4	50	140	25	-
2NKR25.5	□	25.5	50	140	25	-
2NKR25.6	□	25.6	50	140	25	-
2NKR25.7	□	25.7	50	140	25	-
2NKR25.8	□	25.8	50	140	25	-
2NKR25.9	□	25.9	50	140	25	-
2NKR26	●	26	50	140	25	15,540
2NKR26.1	□	26.1	55	145	25	-
2NKR26.2	□	26.2	55	145	25	-
2NKR26.3	□	26.3	55	145	25	-

商品コード Item code	在庫 Stock	寸法 Size (mm)				希望小売価格 (円) Suggested retail price(¥)
		外径 Tool dia.	刃長 Flute length	全長 Overall length	シャンク径 Shank dia.	
2NKR26.4	□	26.4	55	145	25	-
2NKR26.5	□	26.5	55	145	25	-
2NKR26.6	□	26.6	55	145	25	-
2NKR26.7	□	26.7	55	145	25	-
2NKR26.8	□	26.8	55	145	25	-
2NKR26.9	□	26.9	55	145	25	-
2NKR27	●	27	55	145	25	18,570
2NKR27.1	□	27.1	55	145	25	-
2NKR27.2	□	27.2	55	145	25	-
2NKR27.3	□	27.3	55	145	25	-
2NKR27.4	□	27.4	55	145	25	-
2NKR27.5	□	27.5	55	145	25	-
2NKR27.6	□	27.6	55	145	25	-
2NKR27.7	□	27.7	55	145	25	-
2NKR27.8	□	27.8	55	145	25	-
2NKR27.9	□	27.9	55	145	25	-
2NKR28	●	28	55	145	25	18,570
2NKR28.1	□	28.1	55	145	25	-
2NKR28.2	□	28.2	55	145	25	-
2NKR28.3	□	28.3	55	145	25	-
2NKR28.4	□	28.4	55	145	25	-
2NKR28.5	□	28.5	55	145	25	-
2NKR28.6	□	28.6	55	145	25	-
2NKR28.7	□	28.7	55	145	25	-
2NKR28.8	□	28.8	55	145	25	-
2NKR28.9	□	28.9	55	145	25	-
2NKR29	●	29	55	145	25	22,690
2NKR29.1	□	29.1	55	145	25	-
2NKR29.2	□	29.2	55	145	25	-
2NKR29.3	□	29.3	55	145	25	-
2NKR29.4	□	29.4	55	145	25	-
2NKR29.5	□	29.5	55	145	25	-
2NKR29.6	□	29.6	55	145	25	-
2NKR29.7	□	29.7	55	145	25	-
2NKR29.8	□	29.8	55	145	25	-
2NKR29.9	□	29.9	55	145	25	-
2NKR30	●	30	55	145	25	22,690
2NKR30.5	□	30.5	60	160	32	-
2NKR31	●	31	60	160	32	27,780
2NKR31.5	□	31.5	60	160	32	-
2NKR32	●	32	60	160	32	27,780
2NKR32.5	□	32.5	60	160	32	-
2NKR33	●	33	60	160	32	32,870
2NKR33.5	□	33.5	60	160	32	-
2NKR34	●	34	60	160	32	32,870
2NKR34.5	□	34.5	60	160	32	-
2NKR35	●	35	60	160	32	32,870
2NKR35.5	□	35.5	60	160	32	-
2NKR36	●	36	60	160	32	36,850
2NKR36.5	□	36.5	60	160	32	-

●印：標準在庫品です。●：Stoked items。□印：特定代理店在庫です。弊社営業へお問い合わせください。□：Stocked by specified distributor. Contact with our sales department.

ロング刃長

Long



外径公差 Dia. tolerance 0~0.03



(mm)



2NKR (Symbol: circle with dot, circle with cross)

商品コード Item code	在庫 Stock	寸法 Size (mm)				希望小売価格 (円) Suggested retail price(¥)
		外径 Tool dia.	刃長 Flute length	全長 Overall length	シャンク径 Shank dia.	
2NKR37	●	37	60	160	32	39,740
2NKR37.5	□	37.5	65	165	32	-
2NKR38	●	38	65	165	32	39,740
2NKR38.5	□	38.5	65	165	32	-
2NKR39	●	39	65	165	32	46,340
2NKR39.5	□	39.5	65	165	32	-
2NKR40X32	●	40	65	165	32	46,340
2NKR40.5X32	□	40.5	65	165	32	-
2NKR41	□	41	65	175	42	-
2NKR41X32	□	41	65	165	32	-
2NKR41.5X32	□	41.5	65	165	32	-
2NKR42	□	42	65	175	42	-
2NKR42X32	□	42	65	165	32	-
2NKR42.5X32	□	42.5	70	170	32	-
2NKR43	□	43	70	180	42	-
2NKR43X32	□	43	70	170	32	-
2NKR43.5X32	□	43.5	70	170	32	-
2NKR44	□	44	70	180	42	-
2NKR44X32	□	44	70	170	32	-
2NKR44.5X32	□	44.5	70	170	32	-
2NKR45	□	45	70	180	42	-
2NKR45X32	□	45	70	170	32	-
2NKR45.5X32	□	45.5	70	170	32	-
2NKR46	□	46	70	180	42	-
2NKR46X32	□	46	70	170	32	-
2NKR46.5X32	□	46.5	70	170	32	-
2NKR47	□	47	70	180	42	-
2NKR47X32	□	47	70	170	32	-
2NKR47.5X32	□	47.5	70	170	32	-
2NKR48	□	48	70	180	42	-
2NKR48X32	□	48	70	170	32	-
2NKR48.5	□	48.5	70	170	42	-
2NKR49	□	49	70	180	42	-
2NKR49X32	□	49	70	170	32	-
2NKR49.5X32	□	49.5	70	170	32	-
2NKR50	□	50	70	180	42	-
2NKR50X32	□	50	70	170	32	-
2NKR51	□	51	75	185	42	-
2NKR52	□	52	75	185	42	-
2NKR53	□	53	75	185	42	-
2NKR54	□	54	75	185	42	-
2NKR55	□	55	75	185	42	-
2NKR56	□	56	75	185	42	-
2NKR57	□	57	75	185	42	-
2NKR58	□	58	75	185	42	-
2NKR59	□	59	75	185	42	-
2NKR60	□	60	75	185	42	-
2NKR60X32	□	60	75	175	32	-

2NKL (Symbol: circle with dot, circle with cross)

商品コード Item code	在庫 Stock	寸法 Size (mm)				希望小売価格 (円) Suggested retail price(¥)
		外径 Tool dia.	刃長 Flute length	全長 Overall length	シャンク径 Shank dia.	
2NKL1X5	□	1	5	50	6	-
2NKL1X6	□	1	6	50	6	-
2NKL1X7.5	□	1	7.5	50	6	-
2NKL1.1	□	1.1	7.5	50	6	-
2NKL1.2	□	1.2	7.5	50	6	-
2NKL1.3	□	1.3	7.5	50	6	-
2NKL1.4	□	1.4	7.5	50	6	-
2NKL1.5	□	1.5	7.5	50	6	-
2NKL1.5X10	□	1.5	10	60	6	-
2NKL1.6	□	1.6	10	60	6	-
2NKL1.7	□	1.7	10	60	6	-
2NKL1.8	□	1.8	10	60	6	-
2NKL1.9	□	1.9	10	60	6	-
2NKL2X10	□	2	10	60	6	-
2NKL2X12	□	2	12	60	6	-
2NKL2X15	□	2	15	60	6	-
2NKL2.1	□	2.1	15	60	6	-
2NKL2.2	□	2.2	15	60	6	-
2NKL2.3	□	2.3	15	60	6	-
2NKL2.4	□	2.4	15	60	6	-
2NKL2.5X12	□	2.5	12	60	6	-
2NKL2.5	□	2.5	15	60	6	-
2NKL2.5X20	□	2.5	20	60	6	-
2NKL2.6	□	2.6	15	60	6	-
2NKL2.7	□	2.7	15	60	6	-
2NKL2.8	□	2.8	15	60	6	-
2NKL2.9	□	2.9	15	60	6	-
2NKL3	●	3	15	60	6	3,470
2NKL3X20	□	3	20	65	6	-
2NKL3X25	□	3	25	65	6	-
2NKL3.1	□	3.1	20	65	6	-
2NKL3.2	□	3.2	20	65	6	-
2NKL3.3	□	3.3	20	65	6	-
2NKL3.4	□	3.4	20	65	6	-
2NKL3.5	□	3.5	20	65	6	-
2NKL3.6	□	3.6	20	65	6	-
2NKL3.7	□	3.7	20	65	6	-
2NKL3.8	□	3.8	20	65	6	-
2NKL3.9	□	3.9	20	65	6	-
2NKL4	●	4	20	65	6	3,470
2NKL4.1	□	4.1	25	70	6	-
2NKL4.2	□	4.2	25	70	6	-
2NKL4.3	□	4.3	25	70	6	-
2NKL4.4	□	4.4	25	70	6	-
2NKL4.5	□	4.5	25	70	6	-
2NKL4.6	□	4.6	25	70	6	-
2NKL4.7	□	4.7	25	70	6	-
2NKL4.8	□	4.8	25	70	6	-
2NKL4.9	□	4.9	25	70	6	-
2NKL5	●	5	25	70	6	3,470

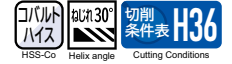

商品コード Item code	在庫 Stock	寸法 Size (mm)				希望小売価格 (円) Suggested retail price(¥)
		外径 Tool dia.	刃長 Flute length	全長 Overall length	シャンク径 Shank dia.	
2NKL5.1	□	5.1	25	70	6	-
2NKL5.2	□	5.2	25	70	6	-
2NKL5.3	□	5.3	25	70	6	-
2NKL5.4	□	5.4	25	70	6	-
2NKL5.5	□	5.5	25	70	6	-
2NKL5.6	□	5.6	25	70	6	-
2NKL5.7	□	5.7	25	70	6	-
2NKL5.8	□	5.8	25	70	6	-
2NKL5.9	□	5.9	25	70	6	-
2NKL6	●	6	25	70	6	3,470
2NKL6.1	□	6.1	35	85	8	-
2NKL6.2	□	6.2	35	85	8	-
2NKL6.3	□	6.3	35	85	8	-
2NKL6.4	□	6.4	35	85	8	-
2NKL6.5	□	6.5	35	85	8	-
2NKL6.6	□	6.6	35	85	8	-
2NKL6.7	□	6.7	35	85	8	-
2NKL6.8	□	6.8	35	85	8	-
2NKL6.9	□	6.9	35	85	8	-
2NKL7	●	7	35	85	8	3,990
2NKL7.1	□	7.1	35	85	8	-
2NKL7.2	□	7.2	35	85	8	-
2NKL7.3	□	7.3	35	85	8	-
2NKL7.4	□	7.4	35	85	8	-
2NKL7.5	□	7.5	35	85	8	-
2NKL7.6	□	7.6	35	85	8	-
2NKL7.7	□	7.7	35	85	8	-
2NKL7.8	□	7.8	35	85	8	-
2NKL7.9	□	7.9	35	85	8	-
2NKL8	●	8	35	85	8	3,990
2NKL8.1	□	8.1	45	100	10	-
2NKL8.2	□	8.2	45	100	10	-
2NKL8.3	□	8.3	45	100	10	-
2NKL8.4	□	8.4	45	100	10	-
2NKL8.5	□	8.5	45	100	10	-
2NKL8.6	□	8.6	45	100	10	-
2NKL8.7	□	8.7	45	100	10	-
2NKL8.8	□	8.8	45	100	10	-
2NKL8.9	□	8.9	45	100	10	-
2NKL9	●	9	45	100	10	4,490
2NKL9.1	□	9.1	45	100	10	-
2NKL9.2	□	9.2	45	100	10	-
2NKL9.3	□	9.3	45	100	10	-
2NKL9.4	□	9.4	45	100	10	-
2NKL9.5	□	9.5	45	100	10	-
2NKL9.6	□	9.6	45	100	10	-
2NKL9.7	□	9.7	45	100	10	-
2NKL9.8	□	9.8	45	100	10	-
2NKL9.9	□	9.9	45	100	10	-
2NKL10	●	10	45	100	10	4,490

HSS End Mills Square End Mills

2NKL○○(×○○)

商品コード Item code	在庫 Stock	寸法 Size (mm)					希望小売価格 (円) Suggested retail price(¥)
		外径 Tool dia.	刃長 Flute length	全長 Overall length	シャンク径 Shank dia.		
2NKL10.1	□	10.1	55	120	12	-	
2NKL10.2	□	10.2	55	120	12	-	
2NKL10.3	□	10.3	55	120	12	-	
2NKL10.4	□	10.4	55	120	12	-	
2NKL10.5	□	10.5	55	120	12	-	
2NKL10.6	□	10.6	55	120	12	-	
2NKL10.7	□	10.7	55	120	12	-	
2NKL10.8	□	10.8	55	120	12	-	
2NKL10.9	□	10.9	55	120	12	-	
2NKL11	●	11	55	120	12	5,540	
2NKL11.1	□	11.1	55	120	12	-	
2NKL11.2	□	11.2	55	120	12	-	
2NKL11.3	□	11.3	55	120	12	-	
2NKL11.4	□	11.4	55	120	12	-	
2NKL11.5	□	11.5	55	120	12	-	
2NKL11.6	□	11.6	55	120	12	-	
2NKL11.7	□	11.7	55	120	12	-	
2NKL11.8	□	11.8	55	120	12	-	
2NKL11.9	□	11.9	55	120	12	-	
2NKL12	●	12	55	120	12	5,540	
2NKL12.1X12	□	12.1	55	120	12	-	
2NKL12.1X16	□	12.1	55	120	16	-	
2NKL12.2X12	□	12.2	55	120	12	-	
2NKL12.2X16	□	12.2	55	120	16	-	
2NKL12.3X12	□	12.3	55	120	12	-	
2NKL12.3X16	□	12.3	55	120	16	-	
2NKL12.4X12	□	12.4	55	120	12	-	
2NKL12.4X16	□	12.4	55	120	16	-	
2NKL12.5X12	□	12.5	55	120	12	-	
2NKL12.5X16	□	12.5	55	120	16	-	
2NKL12.6X12	□	12.6	55	120	12	-	
2NKL12.6X16	□	12.6	55	120	16	-	
2NKL12.7X12	□	12.7	55	120	12	-	
2NKL12.7X16	□	12.7	55	120	16	-	
2NKL12.8X12	□	12.8	55	120	12	-	
2NKL12.8X16	□	12.8	55	120	16	-	
2NKL12.9X12	□	12.9	55	120	12	-	
2NKL12.9X16	□	12.9	55	120	16	-	
2NKL13	●	13	55	120	12	7,120	
2NKL13.5	□	13.5	55	125	16	-	
2NKL14	●	14	55	125	16	7,120	
2NKL14.5	□	14.5	65	135	16	-	
2NKL15	●	15	65	135	16	7,880	
2NKL15.5	□	15.5	65	135	16	-	
2NKL16	●	16	65	135	16	8,780	
2NKL16.5	□	16.5	65	145	20	-	
2NKL17	●	17	65	135	16	10,690	
2NKL17.5	□	17.5	65	145	20	-	
2NKL18	●	18	65	135	16	10,690	
2NKL18.5	□	18.5	75	155	20	-	

商品コード Item code	在庫 Stock	寸法 Size (mm)					希望小売価格 (円) Suggested retail price(¥)
		外径 Tool dia.	刃長 Flute length	全長 Overall length	シャンク径 Shank dia.		
2NKL19	●	19	75	155	20	12,290	
2NKL19.5	□	19.5	75	155	20	-	
2NKL20	●	20	75	155	20	12,290	
2NKL20.5	□	20.5	75	165	20	-	
2NKL21	□	21	75	155	20	-	
2NKL22	●	22	75	155	20	16,370	
2NKL23	□	23	90	180	25	-	
2NKL24	●	24	90	180	25	20,220	
2NKL25	●	25	90	180	25	20,220	
2NKL26	●	26	90	180	25	22,000	
2NKL27	□	27	90	180	25	-	
2NKL28	●	28	90	180	25	25,990	
2NKL29	□	29	90	180	25	-	
2NKL30	●	30	90	180	25	31,350	
2NKL31	□	31	95	195	32	-	
2NKL32	●	32	95	195	32	38,370	
2NKL33	□	33	95	195	32	-	
2NKL34	□	34	95	195	32	-	
2NKL35	●	35	100	200	32	47,720	
2NKL36	□	36	100	200	32	-	
2NKL37	□	37	100	200	32	-	
2NKL38	□	38	105	205	32	-	
2NKL39	□	39	110	210	32	-	
2NKL40X32	●	40	110	210	32	66,280	
2NKL41X32	□	41	110	210	32	-	
2NKL42X32	□	42	110	210	32	-	
2NKL43X32	□	43	110	210	32	-	
2NKL44X32	□	44	115	215	32	-	
2NKL45X32	□	45	115	215	32	-	
2NKL46X32	□	46	115	215	32	-	
2NKL47X32	□	47	115	215	32	-	
2NKL48X32	□	48	120	220	32	-	
2NKL49X32	□	49	120	220	32	-	
2NKL50X32	□	50	120	220	32	-	
2NKL51X42	□	51	120	220	42	-	

ハイスエンドミル
スクエアエンドミル

○ 2NKR、2NKL の対応被削材

Applicable work material of 2NKR, 2NKL

炭素鋼 合金鋼 Carbon steel Alloy steel	炭素鋼 合金鋼 Pre-hardened steel ≤ 45HRC	高硬度 Hardened steel			ステン レス鋼 Stainless steel	チタン合金 耐熱合金 Titanium alloy Heat-resistant alloy	銅合金 Copper alloy	アルミ 合金 Aluminum alloy
		> 45HRC ≤ 55HRC	> 55HRC ≤ 65HRC	> 65HRC				
○					○	○	○	

○ 再研磨対応外径範囲

Re-grinding compatibility range

商品コード Item code	外周 Outer dia. (mm)	エンド End (mm)
2NKR	6 ~ 60	4 ~ 60
2NKL	6 ~ 51	3 ~ 51

●印：標準在庫品です。●：Stoked items。□印：特定代理店在庫です。弊社営業へお問い合わせください。□：Stocked by specified distributor. Contact with our sales department.

標準切削条件表 Recommended cutting conditions

寸法表 Size list : H30 寸法表 Size list : H32

2NKS ショート刃長 Short	2NKR レギュラー刃長 Regular
--------------------------------	-----------------------------------

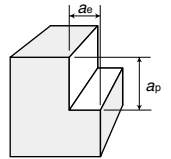

<側面切削> Side milling

被削材 (硬さ) Work material (Hardness)	条件域 Condition Range	切込み Depth of cut mm	切削条件 Cutting Conditions	外径 DC Tool dia. (mm)													
				φ3	φ4	φ6	φ8	φ10	φ12	φ16	φ20	φ25	φ30	φ35	φ40	φ45	φ50
鑄鉄・炭素鋼 Cast irons, Carbon steels (200HB 以下) FC200 SS400, S45C	汎用条件 General	ap=1.5DC ae=0.1DC	回転数 min ⁻¹	3,400	2,500	1,700	1,200	1,000	850	640	500	400	340	290	250	220	200
			送り速度 mm/min	100	100	120	120	120	110	110	95	95	85	70	60	55	50
合金鋼 Alloy steels (200~250HB) SCM, SNCM	汎用条件 General	ap=1.5DC ae=0.1DC	回転数 min ⁻¹	2,600	2,000	1,300	1,000	800	660	500	400	320	270	220	200	170	160
			送り速度 mm/min	80	80	80	80	80	80	75	60	60	50	45	40	35	30
工具鋼・ステンレス鋼 Tool steels, Stainless steels (25~35HRC) SKD, SKT, SUS304	汎用条件 General	ap=1.5DC ae=0.1DC	回転数 min ⁻¹	2,100	1,600	1,000	800	640	530	400	320	260	210	180	160	140	130
			送り速度 mm/min	50	60	60	60	60	60	65	50	40	40	35	30	25	25
焼入れ鋼・プリハードン鋼 Hardened steels, Pre-Hardened steels (35~45HRC) SKD, SKT, HPM1, NAK55	汎用条件 General	ap=1.5DC ae=0.1DC	回転数 min ⁻¹	1,500	1,100	740	560	450	370	280	220	180	150	125	110	100	90
			送り速度 mm/min	35	35	45	45	45	45	45	35	35	30	25	25	20	20
耐熱鋼・チタン合金 Heat-resistant steels, Titanium alloys Inconel Ti-6Al-4V	汎用条件 General	ap=1.5DC ae=0.1DC	回転数 min ⁻¹	850	640	420	320	250	210	160	130	100	85	70	60	55	50
			送り速度 mm/min	20	20	20	20	20	20	20	20	16	14	13	12	11	10
アルミ合金・非鉄金属 Aluminum alloys Non Ferrous	汎用条件 General	ap=1.5DC ae=0.1DC	回転数 min ⁻¹	8,000	6,000	4,000	3,000	2,400	2,000	1,500	1,200	950	800	680	600	530	450
			送り速度 mm/min	300	300	300	350	350	350	350	300	300	250	200	180	160	130

寸法表 Size list : H30 寸法表 Size list : H32

2NKS ショート刃長 Short	2NKR レギュラー刃長 Regular
--------------------------------	-----------------------------------

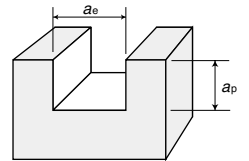

<溝切削> Slotting

被削材 (硬さ) Work material (Hardness)	条件域 Condition Range	切込み Depth of cut mm	切削条件 Cutting Conditions	外径 DC Tool dia. (mm)													
				φ3	φ4	φ6	φ8	φ10	φ12	φ16	φ20	φ25	φ30	φ35	φ40	φ45	φ50
鑄鉄・炭素鋼 Cast irons, Carbon steels (200HB 以下) FC200 SS400, S45C	汎用条件 General	ap=0.5DC ae=1DC	回転数 min ⁻¹	2,600	2,000	1,300	1,000	800	660	500	400	320	260	200	200	175	160
			送り速度 mm/min	75	85	90	100	100	100	80	80	60	50	45	40	40	35
合金鋼 Alloy steels (200~250HB) SCM, SNCM	汎用条件 General	ap=0.5DC ae=1DC	回転数 min ⁻¹	2,100	1,600	1,000	800	640	530	400	320	260	210	180	160	140	130
			送り速度 mm/min	40	50	60	50	50	50	50	50	40	35	30	25	25	25
工具鋼・ステンレス鋼 Tool steels, Stainless steels (25~35HRC) SKD, SKT, SUS304	汎用条件 General	ap=0.5DC ae=1DC	回転数 min ⁻¹	1,700	1,200	850	640	510	420	320	260	200	160	145	120	110	100
			送り速度 mm/min	35	40	40	40	40	40	40	40	30	25	20	20	20	20
アルミ合金・非鉄金属 Aluminum alloys Non Ferrous	汎用条件 General	ap=0.5DC ae=1DC	回転数 min ⁻¹	5,300	4,000	2,600	2,000	1,600	1,320	1,000	800	640	530	450	400	350	320
			送り速度 mm/min	150	170	180	200	200	240	200	160	120	100	85	80	80	70

- [注意]** ①被削材、加工形状に合わせて、適切なクーラントを使用してください。
②この標準切削条件表は切削条件の目安を示すものです。実際の加工では加工形状、目的、使用機械等により条件を調整してください。
- [Note]** ① Use the appropriate coolant for the work material and machining shape.
② These Recommended Cutting Conditions indicate only the rule of a thumb for the cutting conditions. In actual machining, the condition should be adjusted according to the machining shape, purpose and the machine type.

寸法表 Size list : H33

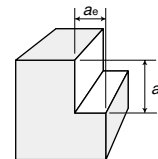

<側面切削> Side milling

被削材 (硬さ) Work material (Hardness)	条件域 Condition Range	切込み Depth of cut mm	切削条件 Cutting Conditions	外径 DC Tool dia. (mm)													
				φ3	φ4	φ6	φ8	φ10	φ12	φ16	φ20	φ25	φ30	φ35	φ40	φ45	φ50
鋳鉄・炭素鋼 Cast irons, Carbon steels (200HB 以下) FC200 SS400, S45C	汎用条件 General	ap=3DC ae=0.1DC	回転数 min ⁻¹	1,100	830	560	400	330	280	210	170	130	110	100	85	75	65
			送り速度 mm /min	30	30	40	40	40	40	40	35	35	30	25	20	20	20
合金鋼 Alloy steels (200~250HB) SCM, SNCM	汎用条件 General	ap=3DC ae=0.1DC	回転数 min ⁻¹	950	720	470	350	290	240	180	140	110	95	80	70	65	60
			送り速度 mm /min	25	25	30	35	35	35	35	30	30	25	20	15	15	15
工具鋼・ステンレス鋼 Tool steels, Stainless steels (25~35HRC) SKD, SKT, SUS304	汎用条件 General	ap=3DC ae=0.1DC	回転数 min ⁻¹	800	600	400	300	240	200	150	120	95	80	70	60	55	50
			送り速度 mm /min	22	22	28	30	30	28	28	25	25	22	18	12	12	12
焼入れ鋼・プリハードン鋼 Hardened steels, Pre-Harden steels (35~45HRC) SKD, SKT, HPM1, NAK55	汎用条件 General	ap=3DC ae=0.1DC	回転数 min ⁻¹	740	560	370	280	220	185	140	110	90	75	65	55	50	45
			送り速度 mm /min	20	20	25	28	28	26	26	23	23	20	16	11	11	11
耐熱鋼・チタン合金 Heat-resistant steels, Titanium alloys Inconel Ti-6Al-4V	汎用条件 General	ap=3DC ae=0.1DC	回転数 min ⁻¹	740	560	370	280	220	185	140	110	90	75	65	55	50	45
			送り速度 mm /min	20	20	25	28	28	26	26	23	23	20	16	11	11	11
アルミ合金・非鉄金属 Aluminum alloys Non Ferrous	汎用条件 General	ap=3DC ae=0.1DC	回転数 min ⁻¹	3,200	2,400	1,600	1,200	950	800	600	480	380	320	270	240	210	190
			送り速度 mm /min	85	85	100	120	120	110	110	100	100	85	65	60	60	60

- 【注意】** ①被削材、加工形状に合わせて、適切なクーラントを使用してください。
 ②この標準切削条件表は切削条件の目安を示すものです。実際の加工では加工形状、目的、使用機械等により条件を調整してください。
- 【Note】** ① Use the appropriate coolant for the work material and machining shape.
 ② These Recommended Cutting Conditions indicate only the rule of a thumb for the cutting conditions. In actual machining, the condition should be adjusted according to the machining shape, purpose and the machine type.

End Mills for Aluminium アルミ用エンドミル

1 枚刃 1 Flute

側面 Side Cutting, 中仕上げ Semi Finishing, 仕上げ Finishing

外径公差 Dia. tolerance 0 ~ -0.1

h7

(mm)

2 枚刃 2 Flutes

側面 Side Cutting, 溝 Slotting, 座ぐり Spot Facing, 荒 Roughing, 中仕上げ Semi Finishing, 仕上げ Finishing

外径公差 Dia. tolerance 0 ~ -0.03

h7

(mm)



1AL

コバルトハイス HSS-Co, ねじり30° Helix angle

商品コード Item code	在庫 Stock	寸法 Size (mm)				希望小売 価格(円) Suggested retail price(¥)
		外径 Tool dia.	刃長 Flute length	全長 Overall length	シャンク径 Shank dia.	
1AL4	●	4	12	60	8	4,850
1AL5	●	5	15	60	8	4,850
1AL6	●	6	15	60	8	4,850
1AL8	●	8	20	75	8	5,630
1AL10	●	10	25	90	10	6,090

2AL

コバルトハイス HSS-Co, ねじり45° Helix angle, 切削条件表 H39 Cutting Conditions

商品コード Item code	在庫 Stock	寸法 Size (mm)				希望小売 価格(円) Suggested retail price(¥)
		外径 Tool dia.	刃長 Flute length	全長 Overall length	シャンク径 Shank dia.	
2AL3	●	3	10	55	6	2,850
2AL3.1	□	3.1	12	60	6	—
2AL3.2	□	3.2	12	60	6	—
2AL3.3	□	3.3	12	60	6	—
2AL3.4	□	3.4	12	60	6	—
2AL3.5	□	3.5	12	60	6	—
2AL3.6	□	3.6	12	60	6	—
2AL3.7	□	3.7	12	60	6	—
2AL3.8	□	3.8	12	60	6	—
2AL3.9	□	3.9	12	60	6	—
2AL4	●	4	12	60	6	2,850
2AL4.1	□	4.1	15	60	6	—
2AL4.2	□	4.2	15	60	6	—
2AL4.3	□	4.3	15	60	6	—
2AL4.4	□	4.4	15	60	6	—
2AL4.5	□	4.5	15	60	6	—
2AL4.6	□	4.6	15	60	6	—
2AL4.7	□	4.7	15	60	6	—
2AL4.8	□	4.8	15	60	6	—
2AL4.9	□	4.9	15	60	6	—
2AL5	●	5	15	60	6	2,850
2AL5.1	□	5.1	15	60	6	—
2AL5.2	□	5.2	15	60	6	—
2AL5.3	□	5.3	15	60	6	—
2AL5.4	□	5.4	15	60	6	—
2AL5.5	□	5.5	15	60	6	—
2AL5.6	□	5.6	15	60	6	—
2AL5.7	□	5.7	15	60	6	—
2AL5.8	□	5.8	15	60	6	—
2AL5.9	□	5.9	15	60	6	—
2AL6	●	6	15	60	6	2,850
2AL6.1	□	6.1	16	60	8	—
2AL6.2	□	6.2	16	60	8	—
2AL6.3	□	6.3	16	60	8	—
2AL6.4	□	6.4	16	60	8	—
2AL6.5	□	6.5	16	60	8	—
2AL6.6	□	6.6	16	60	8	—
2AL6.7	□	6.7	16	60	8	—
2AL6.8	□	6.8	16	60	8	—
2AL6.9	□	6.9	16	60	8	—
2AL7	●	7	20	70	8	3,140
2AL7.1	□	7.1	20	70	8	—
2AL7.2	□	7.2	20	70	8	—
2AL7.3	□	7.3	20	70	8	—
2AL7.4	□	7.4	20	70	8	—

1ALの対応被削材 Applicable work material of 1AL

炭素鋼 合金鋼 Carbon steel Alloy steel	炭素鋼 合金鋼 Pre-hardened steel ≤ 45HRC	高硬度 Hardened steel			ステン レス鋼 Stainless steel	チタン合金 耐熱合金 Titanium alloy Heat-resistant alloy	銅合金 Copper alloy	アルミ 合金 Aluminum alloy
		> 45HRC ≤ 55HRC	> 55HRC ≤ 65HRC	> 65HRC				
							◎	

再研磨対応外径範囲 Re-grinding compatibility range

商品コード Item code	外周 Outer dia. (mm)	エンド End (mm)
1AL	6 ~ 10	4 ~ 10

●印：標準在庫品です。□印：特定代理店在庫です。弊社営業へお問い合わせください。
● : Stocked items. □ : Stocked by specified distributor. Contact with our sales department.

アルミ用エンドミル

2AL⁰⁰

商品コード Item code	在庫 Stock	寸法 Size (mm)				希望小売 価格(円) Suggested retail price(¥)
		外径 Tool dia.	刃長 Flute length	全長 Overall length	シャンク径 Shank dia.	
2AL7.5	<input type="checkbox"/>	7.5	20	70	8	-
2AL7.6	<input type="checkbox"/>	7.6	20	70	8	-
2AL7.7	<input type="checkbox"/>	7.7	20	70	8	-
2AL7.8	<input type="checkbox"/>	7.8	20	70	8	-
2AL7.9	<input type="checkbox"/>	7.9	20	70	8	-
2AL8	<input checked="" type="checkbox"/>	8	20	70	8	3,140
2AL8.1	<input type="checkbox"/>	8.1	20	70	10	-
2AL8.2	<input type="checkbox"/>	8.2	20	70	10	-
2AL8.3	<input type="checkbox"/>	8.3	20	70	10	-
2AL8.4	<input type="checkbox"/>	8.4	20	70	10	-
2AL8.5	<input type="checkbox"/>	8.5	20	70	10	-
2AL8.6	<input type="checkbox"/>	8.6	20	70	10	-
2AL8.7	<input type="checkbox"/>	8.7	20	70	10	-
2AL8.8	<input type="checkbox"/>	8.8	20	70	10	-
2AL8.9	<input type="checkbox"/>	8.9	20	70	10	-
2AL9	<input checked="" type="checkbox"/>	9	25	80	10	3,640
2AL9.1	<input type="checkbox"/>	9.1	25	80	10	-
2AL9.2	<input type="checkbox"/>	9.2	25	80	10	-
2AL9.3	<input type="checkbox"/>	9.3	25	80	10	-
2AL9.4	<input type="checkbox"/>	9.4	25	80	10	-
2AL9.5	<input type="checkbox"/>	9.5	25	80	10	-
2AL9.6	<input type="checkbox"/>	9.6	25	80	10	-
2AL9.7	<input type="checkbox"/>	9.7	25	80	10	-
2AL9.8	<input type="checkbox"/>	9.8	25	80	10	-
2AL9.9	<input type="checkbox"/>	9.9	25	80	10	-
2AL10	<input checked="" type="checkbox"/>	10	25	80	10	3,640
2AL10.5	<input type="checkbox"/>	10.5	30	95	12	-
2AL11	<input type="checkbox"/>	11	30	95	12	-
2AL11.5	<input type="checkbox"/>	11.5	30	95	12	-
2AL12	<input checked="" type="checkbox"/>	12	30	95	12	4,700
2AL12.5	<input type="checkbox"/>	12.5	30	95	12	-
2AL13	<input type="checkbox"/>	13	30	95	12	-
2AL13.5	<input type="checkbox"/>	13.5	30	95	12	-
2AL14	<input checked="" type="checkbox"/>	14	35	105	16	5,780
2AL14.5	<input type="checkbox"/>	14.5	40	110	16	-
2AL15	<input checked="" type="checkbox"/>	15	40	110	16	6,470
2AL15.5	<input type="checkbox"/>	15.5	40	110	16	-
2AL16	<input checked="" type="checkbox"/>	16	40	110	16	6,980
2AL16.5	<input type="checkbox"/>	16.5	40	110	16	-
2AL17	<input type="checkbox"/>	17	40	110	16	-
2AL17.5	<input type="checkbox"/>	17.5	40	110	16	-
2AL18	<input checked="" type="checkbox"/>	18	40	110	16	8,340
2AL18.5	<input type="checkbox"/>	18.5	40	110	16	-
2AL19	<input type="checkbox"/>	19	40	110	16	-
2AL19.5	<input type="checkbox"/>	19.5	40	110	16	-

商品コード Item code	在庫 Stock	寸法 Size (mm)				希望小売 価格(円) Suggested retail price(¥)
		外径 Tool dia.	刃長 Flute length	全長 Overall length	シャンク径 Shank dia.	
2AL20	<input checked="" type="checkbox"/>	20	45	125	20	10,020
2AL20.5	<input type="checkbox"/>	20.5	45	125	20	-
2AL21	<input type="checkbox"/>	21	45	125	20	-
2AL21.5	<input type="checkbox"/>	21.5	45	125	20	-
2AL22	<input checked="" type="checkbox"/>	22	45	125	20	12,690
2AL22.5	<input type="checkbox"/>	22.5	45	125	20	-
2AL23	<input type="checkbox"/>	23	45	125	20	-
2AL23.5	<input type="checkbox"/>	23.5	45	125	20	-
2AL24	<input type="checkbox"/>	24	50	140	25	-
2AL24.5	<input type="checkbox"/>	24.5	50	140	25	-
2AL25	<input checked="" type="checkbox"/>	25	50	140	25	14,720
2AL25.5	<input type="checkbox"/>	25.5	50	140	25	-
2AL26	<input type="checkbox"/>	26	50	140	25	-
2AL26.5	<input type="checkbox"/>	26.5	50	140	25	-
2AL27	<input type="checkbox"/>	27	50	140	25	-
2AL27.5	<input type="checkbox"/>	27.5	50	140	25	-
2AL28	<input type="checkbox"/>	28	55	145	25	-
2AL28.5	<input type="checkbox"/>	28.5	55	145	25	-
2AL29	<input type="checkbox"/>	29	55	145	25	-
2AL29.5	<input type="checkbox"/>	29.5	55	145	25	-
2AL30	<input checked="" type="checkbox"/>	30	55	145	25	23,650

ハイエンドミル
スクエアエンドミル

○ 対応被削材 Applicable work material

炭素鋼 合金鋼 Carbon steel Alloy steel	炭素鋼 合金鋼 Pre-hardened steel ≤ 45HRC	高硬度 Hardened steel			ステン レス鋼 Stainless steel	チタン合金 耐熱合金 Titanium alloy Heat-resistant alloy	銅合金 Copper alloy	アルミ 合金 Aluminum alloy
		> 45HRC ≤ 55HRC	> 55HRC ≤ 65HRC	> 65HRC				

●印：標準在庫品です。 □印：特定代理店在庫です。弊社営業へお問い合わせください。
●：Stoked items. □：Stocked by specified distributor. Contact with our sales department.

○ 再研磨対応外径範囲 Re-grinding compatibility range

商品コード Item code	外周 Outer dia. (mm)	エンド End (mm)
2AL	6 ~ 30	3 ~ 30

標準切削条件表 Recommended cutting conditions

寸法表 Size list : H37

2AL

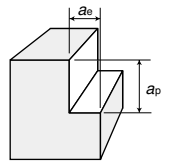

<側面切削> Side milling

被削材 (硬さ) Work material (Hardness)	条件域 Condition Range	切込み Depth of cut mm	切削条件 Cutting Conditions	外径 DC Tool dia. (mm)									
				φ3	φ4	φ6	φ8	φ10	φ12	φ16	φ20	φ25	φ30
純アルミニウム Pure Aluminum 1070	汎用条件 General	$a_p=1.5DC$ $a_e=0.4DC$	回転数 min^{-1}	32,000	24,000	16,000	12,000	9,600	8,000	6,400	4,800	3,800	3,200
			送り速度 mm/min	800	1,000	1,000	1,000	1,200	1,200	1,000	1,000	800	800
アルミ合金 Aluminum alloys Cu-Mg系 2014	汎用条件 General	$a_p=1.5DC$ $a_e=0.4DC$	回転数 min^{-1}	27,000	20,000	13,500	10,000	8,000	6,600	5,300	4,000	3,200	2,700
			送り速度 mm/min	800	1,000	1,000	1,000	1,200	1,200	1,000	1,000	800	600
アルミ合金 Aluminum alloys Si系 4032	汎用条件 General	$a_p=1.5DC$ $a_e=0.4DC$	回転数 min^{-1}	2,700	2,000	1,300	1,000	800	650	530	400	320	260
			送り速度 mm/min	150	200	200	300	300	250	150	150	120	100
アルミ合金 Aluminum alloys Mg系 5052	汎用条件 General	$a_p=1.5DC$ $a_e=0.4DC$	回転数 min^{-1}	13,000	10,000	6,500	5,000	4,000	3,300	2,700	2,000	1,600	1,300
			送り速度 mm/min	400	500	500	600	600	700	500	500	350	350
アルミ合金 Aluminum alloys Mg-Si系 6061	汎用条件 General	$a_p=1.5DC$ $a_e=0.4DC$	回転数 min^{-1}	3,700	2,800	1,900	1,400	1,100	930	740	560	440	370
			送り速度 mm/min	150	150	200	250	250	300	200	200	150	150
アルミ合金 Aluminum alloys Zn-Mg系 7075	汎用条件 General	$a_p=1.5DC$ $a_e=0.4DC$	回転数 min^{-1}	27,000	20,000	13,500	10,000	8,000	6,600	5,300	4,000	3,200	2,700
			送り速度 mm/min	400	500	500	600	600	700	600	600	500	400
鋳造アルミ Cast iron Aluminum AC8C	汎用条件 General	$a_p=1.5DC$ $a_e=0.4DC$	回転数 min^{-1}	16,000	12,000	8,000	6,000	4,800	4,000	3,200	2,400	1,900	1,600
			送り速度 mm/min	500	600	600	700	700	800	800	600	600	500

- 【注意】** ①被削材、加工形状に合わせて、適切なクーラントを使用してください。
 ②この標準切削条件表は切削条件の目安を示すものです。実際の加工では加工形状、目的、使用機械等により条件を調整してください。
- 【Note】** ① Use the appropriate coolant for the work material and machining shape.
 ② These Recommended Cutting Conditions indicate only the rule of a thumb for the cutting conditions. In actual machining, the condition should be adjusted according to the machining shape, purpose and the machine type.

ATコートNEエンドミル

レギュラー刃長

Regular



0~0.03



(mm)



4NER○○.○-AT



商品コード Item code	在庫 Stock	寸法 Size (mm)				希望小売 価格(円) Suggested retail price(¥)
		外径 Tool dia.	刃長 Flute length	全長 Overall length	シャンク径 Shank dia.	
4NER2.5-AT	●	2.5	7	55	6	5,350
4NER3-AT	●	3	10	55	6	4,790
4NER3.5-AT	●	3.5	12	60	6	4,900
4NER4-AT	●	4	12	60	6	4,900
4NER4.5-AT	●	4.5	15	60	6	4,900
4NER5-AT	●	5	15	60	6	4,900
4NER5.5-AT	●	5.5	15	60	6	4,900
4NER6-AT	●	6	15	60	6	4,900
4NER6.5-AT	●	6.5	20	70	8	5,290
4NER7-AT	●	7	20	70	8	5,290
4NER7.5-AT	●	7.5	20	70	8	5,290
4NER8-AT	●	8	20	70	8	5,290
4NER8.5-AT	●	8.5	25	80	10	6,440
4NER9-AT	●	9	25	80	10	6,440
4NER9.5-AT	●	9.5	25	80	10	6,440
4NER10-AT	●	10	25	80	10	6,440
4NER11-AT	●	11	30	95	12	8,000
4NER12-AT	●	12	30	95	12	8,000
4NER13-AT	●	13	35	100	12	9,890
4NER14-AT	●	14	35	105	16	9,890
4NER15-AT	●	15	40	110	16	10,780
4NER16-AT	●	16	40	110	16	11,400
4NER17-AT	●	17	40	110	16	14,170
4NER18-AT	●	18	40	110	16	14,990
4NER19-AT	●	19	45	125	20	16,370
4NER20-AT	●	20	45	125	20	17,190
4NER21-AT	●	21	45	125	20	19,940
4NER22-AT	●	22	45	125	20	19,940
4NER23-AT	●	23	50	140	25	23,240
4NER24-AT	●	24	50	140	25	23,240
4NER25-AT	●	25	50	140	25	23,240
4NER26-AT	●	26	50	140	25	25,580
4NER27-AT	●	27	55	145	25	30,530
4NER28-AT	●	28	55	145	25	30,530
4NER29-AT	●	29	55	145	25	37,270
4NER30-AT	●	30	55	145	25	37,270

ハイスエンドミル
スクエアエンドミル

○ 対応被削材 Applicable work material

炭素鋼 合金鋼 Carbon steel Alloy steel	炭素鋼 合金鋼 Pre-hardened steel ≤ 45HRC	高硬度 Hardened steel			ステン レス鋼 Stainless steel	チタン合金 耐熱合金 Titanium alloy Heat-resistant alloy	銅合金 Copper alloy	アルミ 合金 Aluminum alloy
		> 45HRC ≤ 55HRC	> 55HRC ≤ 65HRC	> 65HRC				
○	○				○	○	○	

○ 再研磨対応外径範囲 Re-grinding compatibility range

商品コード Item code	外周 Outer dia. (mm)	エンド End (mm)
4NER-AT	6 ~ 30	2.5 ~ 30

●印：標準在庫品です。□印：特定代理店在庫です。弊社営業へお問い合わせください。
●：Stoked items. □：Stocked by specified distributor. Contact with our sales department.

C Coating ESM End Mills

ESM-Cコートエンドミル

レギュラー刃長

Regular



外径公差
Dia. tolerance
+0.03~0



(mm)



ロング刃長

Long



外径公差
Dia. tolerance
+0.03~0



(mm)



4ESMRC



商品コード Item code	在庫 Stock	寸法 Size (mm)				希望小売 価格(円) Suggested retail price(¥)
		外径 Tool dia.	刃長 Flute length	全長 Overall length	シャンク径 Shank dia.	
4ESMRC2.5	□	2.5	10	55	6	—
4ESMRC3	●	3	10	55	6	6,630
4ESMRC3.5	□	3.5	12	60	8	—
4ESMRC4	●	4	12	60	8	6,630
4ESMRC4.5	□	4.5	15	60	8	—
4ESMRC5	●	5	15	65	8	6,630
4ESMRC5.5	□	5.5	15	65	8	—
4ESMRC6	●	6	15	65	8	6,630
4ESMRC6.5	□	6.5	20	75	10	—
4ESMRC7	●	7	20	75	10	7,240
4ESMRC7.5	□	7.5	20	75	10	—
4ESMRC8	●	8	20	75	10	7,240
4ESMRC8.5	□	8.5	25	80	10	—
4ESMRC9	●	9	25	80	10	8,350
4ESMRC9.5	□	9.5	25	90	10	—
4ESMRC10	●	10	25	90	10	8,350
4ESMRC11	●	11	30	95	12	10,700
4ESMRC12	●	12	30	95	12	10,700
4ESMRC13	●	13	35	100	12	14,030
4ESMRC14	●	14	35	105	16	14,030
4ESMRC15	●	15	40	110	16	15,540
4ESMRC16	●	16	40	110	16	16,780
4ESMRC17	●	17	40	110	16	20,220
4ESMRC18	●	18	40	110	16	20,220
4ESMRC20	●	20	45	125	20	24,480
4ESMRC22	●	22	45	125	20	31,080
4ESMRC24	●	24	50	125	25	36,030
4ESMRC25	●	25	50	125	25	36,030
4ESMRC26	●	26	50	125	25	39,600
4ESMRC28	●	28	55	125	25	47,170
4ESMRC30	●	30	55	125	25	57,750

4ESMLC



商品コード Item code	在庫 Stock	寸法 Size (mm)			
		外径 Tool dia.	刃長 Flute length	全長 Overall length	シャンク径 Shank dia.
4ESMLC3	□	3	15	60	6
4ESMLC4	□	4	20	65	6
4ESMLC5	□	5	25	70	6
4ESMLC6	□	6	25	70	6
4ESMLC8	□	8	35	85	8
4ESMLC10	□	10	45	100	10
4ESMLC12	□	12	55	120	12
4ESMLC14	□	14	55	125	16
4ESMLC15	□	15	65	135	16
4ESMLC16	□	16	65	135	16
4ESMLC18	□	18	65	135	16
4ESMLC20	□	20	75	155	20
4ESMLC22	□	22	75	155	20
4ESMLC25	□	25	90	180	25
4ESMLC30	□	30	90	180	25

4ESMRC、4ESMLCの対応被削材

Applicable work material of 4ESMRC, 4ESMLC

炭素鋼 合金鋼 Carbon steel Alloy steel	炭素鋼 合金鋼 Pre-hardened steel ≤ 45HRC	高硬度 Hardened steel			ステン レス鋼 Stainless steel	チタン合金 耐熱合金 Titanium alloy Heat-resistant alloy	銅合金 Copper alloy	アルミ 合金 Aluminum alloy
		> 45HRC ≤ 55HRC	> 55HRC ≤ 65HRC	> 65HRC				
○	○				○	○	○	

再研磨対応外径範囲

Re-grinding compatibility range

商品コード Item code	外周 Outer dia. (mm)	エンド End (mm)
4ESMRC	6 ~ 30	4 ~ 30
4ESMLC	6 ~ 30	3 ~ 30

ESMエンドミル

レギュラー刃長 Regular

Regular



+0.03~0



(mm)



4ESMR

粉末ハイス 傾斜30° 切削条件表 H29

商品コード Item code	在庫 Stock	寸法 Size (mm)				希望小売 価格(円) Suggested retail price(¥)
		外径 Tool dia.	刃長 Flute length	全長 Overall length	シャンク径 Shank dia.	
4ESMR2.5	□	2.5	10	55	6	—
4ESMR3	●	3	10	55	6	4,890
4ESMR3.5	□	3.5	12	60	8	—
4ESMR4	●	4	12	60	8	4,890
4ESMR4.5	□	4.5	15	60	8	—
4ESMR5	●	5	15	65	8	4,890
4ESMR5.5	□	5.5	15	65	8	—
4ESMR6	●	6	15	65	8	4,890
4ESMR6.5	□	6.5	20	75	10	—
4ESMR7	●	7	20	75	10	5,390
4ESMR7.5	□	7.5	20	75	10	—
4ESMR8	●	8	20	75	10	5,390
4ESMR8.5	□	8.5	25	80	10	—
4ESMR9	●	9	25	80	10	6,180
4ESMR9.5	□	9.5	25	90	10	—
4ESMR10	●	10	25	90	10	6,180
4ESMR11	●	11	30	95	12	7,920
4ESMR12	●	12	30	95	12	7,920
4ESMR13	●	13	35	100	12	10,440
4ESMR14	●	14	35	105	16	10,440
4ESMR15	●	15	40	110	16	11,590
4ESMR16	●	16	40	110	16	12,520
4ESMR17	●	17	40	110	16	14,990
4ESMR18	●	18	40	110	16	14,990
4ESMR19	●	19	45	125	20	18,150
4ESMR20	●	20	45	125	20	18,150
4ESMR21	□	21	45	125	20	—
4ESMR22	●	22	45	125	20	22,970
4ESMR23	□	23	50	125	25	—
4ESMR24	●	24	50	125	25	26,680
4ESMR25	●	25	50	125	25	26,680
4ESMR26	●	26	50	125	25	29,290
4ESMR27	□	27	55	125	25	—
4ESMR28	●	28	55	125	25	34,930
4ESMR29	□	29	55	125	25	—
4ESMR30	●	30	55	125	25	42,630
4ESMR31	□	31	60	160	32	—
4ESMR32	□	32	60	160	32	—
4ESMR33	□	33	60	160	32	—
4ESMR34	□	34	60	160	32	—
4ESMR35	□	35	60	160	32	—
4ESMR36	□	36	60	160	32	—
4ESMR37	□	37	60	160	32	—
4ESMR38	□	38	65	165	32	—
4ESMR39	□	39	65	165	32	—
4ESMR40	□	40	65	165	32	—

●印：標準在庫品です。

●：Stoked items.

□印：特定代理店在庫です。弊社営業へお問合せください。

□：Stocked by specified distributor. Contact with our sales department.

ロング刃長 Long

Long



+0.03~0



(mm)



4ESML

粉末ハイス 傾斜30° 切削条件表 H29

商品コード Item code	在庫 Stock	寸法 Size (mm)				希望小売 価格(円) Suggested retail price(¥)
		外径 Tool dia.	刃長 Flute length	全長 Overall length	シャンク径 Shank dia.	
4ESML3	●	3	15	60	6	5,780
4ESML4	●	4	20	65	6	5,780
4ESML5	●	5	25	70	6	5,780
4ESML6	●	6	25	70	6	5,780
4ESML7	□	7	35	85	8	—
4ESML8	●	8	35	85	8	6,740
4ESML9	□	9	45	100	10	—
4ESML10	●	10	45	100	10	7,530
4ESML11	□	11	55	120	12	—
4ESML12	●	12	55	120	12	9,240
4ESML13	□	13	55	120	12	—
4ESML14	●	14	55	125	16	12,640
4ESML15	●	15	65	135	16	14,030
4ESML16	●	16	65	135	16	15,540
4ESML17	□	17	65	135	16	—
4ESML18	●	18	65	135	16	19,120
4ESML19	□	19	75	155	20	—
4ESML20	●	20	75	155	20	22,140
4ESML21	□	21	75	155	20	—
4ESML22	□	22	75	155	20	—
4ESML23	□	23	90	180	25	—
4ESML24	□	24	90	180	25	—
4ESML25	●	25	90	180	25	36,170
4ESML26	□	26	90	180	25	—
4ESML27	□	27	90	180	25	—
4ESML28	□	28	90	180	25	—
4ESML29	□	29	90	180	25	—
4ESML30	●	30	90	180	25	56,930
4ESML31	□	31	95	195	32	—
4ESML32	□	32	95	195	32	—
4ESML33	□	33	95	195	32	—
4ESML34	□	34	95	195	32	—
4ESML35	●	35	100	200	32	86,220
4ESML36	□	36	100	200	32	—
4ESML37	□	37	100	200	32	—
4ESML38	□	38	105	205	32	—
4ESML39	□	39	110	210	32	—
4ESML40	●	40	110	210	32	120,320

4ESMR、4ESMLの対応被削材 Applicable work material of 4ESMR, 4ESML

炭素鋼 合金鋼 Carbon steel Alloy steel	炭素鋼 合金鋼 Pre-hardened steel	高硬度 Hardened steel			ステン レス鋼 Stainless steel	チタン合金 耐熱合金 Titanium alloy Heat-resistant alloy	銅合金 Copper alloy	アルミ 合金 Aluminum alloy
○	> 45HRC ≤ 55HRC	> 55HRC ≤ 65HRC	> 65HRC	○	○	○	○	

再研磨対応外径範囲 Re-grinding compatibility range

商品コード Item code	外周 Outer dia. (mm)	エンド End (mm)
4ESMR	6 ~ 40	4 ~ 40
4ESML	6 ~ 40	3 ~ 40

NKエンドミル

レギュラー刃長・センタカット Regular, Center-cut

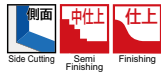

+0.03~0



(mm)



4NKRC

商品コード Item code	在庫 Stock	寸法 Size (mm)				希望小売 価格(円) Suggested retail price(¥)
		外径 Tool dia.	刃長 Flute length	全長 Overall length	シャンク径 Shank dia.	
4NKRC2	<input type="checkbox"/>	2	7	55	6	-
4NKRC2.1	<input type="checkbox"/>	2.1	7	55	6	-
4NKRC2.2	<input type="checkbox"/>	2.2	7	55	6	-
4NKRC2.3	<input type="checkbox"/>	2.3	7	55	6	-
4NKRC2.4	<input type="checkbox"/>	2.4	7	55	6	-
4NKRC2.5	<input checked="" type="checkbox"/>	2.5	7	55	6	3,540
4NKRC2.6	<input type="checkbox"/>	2.6	10	55	6	-
4NKRC2.7	<input type="checkbox"/>	2.7	10	55	6	-
4NKRC2.8	<input type="checkbox"/>	2.8	10	55	6	-
4NKRC2.9	<input type="checkbox"/>	2.9	10	55	6	-
4NKRC3	<input checked="" type="checkbox"/>	3	10	55	6	3,150
4NKRC3.1	<input type="checkbox"/>	3.1	12	60	6	-
4NKRC3.2	<input type="checkbox"/>	3.2	12	60	6	-
4NKRC3.3	<input type="checkbox"/>	3.3	12	60	6	-
4NKRC3.4	<input type="checkbox"/>	3.4	12	60	6	-
4NKRC3.5	<input checked="" type="checkbox"/>	3.5	12	60	6	3,150
4NKRC3.6	<input type="checkbox"/>	3.6	12	60	6	-
4NKRC3.7	<input type="checkbox"/>	3.7	12	60	6	-
4NKRC3.8	<input type="checkbox"/>	3.8	12	60	6	-
4NKRC3.9	<input type="checkbox"/>	3.9	12	60	6	-
4NKRC4	<input checked="" type="checkbox"/>	4	12	60	6	3,150
4NKRC4.1	<input type="checkbox"/>	4.1	15	60	6	-
4NKRC4.2	<input type="checkbox"/>	4.2	15	60	6	-
4NKRC4.3	<input type="checkbox"/>	4.3	15	60	6	-
4NKRC4.4	<input type="checkbox"/>	4.4	15	60	6	-
4NKRC4.5	<input checked="" type="checkbox"/>	4.5	15	60	6	3,150
4NKRC4.6	<input type="checkbox"/>	4.6	15	60	6	-
4NKRC4.7	<input type="checkbox"/>	4.7	15	60	6	-
4NKRC4.8	<input type="checkbox"/>	4.8	15	60	6	-
4NKRC4.9	<input type="checkbox"/>	4.9	15	60	6	-
4NKRC5	<input checked="" type="checkbox"/>	5	15	60	6	3,150
4NKRC5.1	<input type="checkbox"/>	5.1	15	60	6	-
4NKRC5.2	<input type="checkbox"/>	5.2	15	60	6	-
4NKRC5.3	<input type="checkbox"/>	5.3	15	60	6	-
4NKRC5.4	<input type="checkbox"/>	5.4	15	60	6	-
4NKRC5.5	<input checked="" type="checkbox"/>	5.5	15	60	6	3,150
4NKRC5.6	<input type="checkbox"/>	5.6	15	60	6	-
4NKRC5.7	<input type="checkbox"/>	5.7	15	60	6	-
4NKRC5.8	<input type="checkbox"/>	5.8	15	60	6	-
4NKRC5.9	<input type="checkbox"/>	5.9	15	60	6	-
4NKRC6	<input checked="" type="checkbox"/>	6	15	60	6	3,150
4NKRC6.1	<input type="checkbox"/>	6.1	20	70	8	-
4NKRC6.2	<input type="checkbox"/>	6.2	20	70	8	-
4NKRC6.3	<input type="checkbox"/>	6.3	20	70	8	-
4NKRC6.4	<input type="checkbox"/>	6.4	20	70	8	-
4NKRC6.5	<input checked="" type="checkbox"/>	6.5	20	70	8	3,470
4NKRC6.6	<input type="checkbox"/>	6.6	20	70	8	-
4NKRC6.7	<input type="checkbox"/>	6.7	20	70	8	-
4NKRC6.8	<input type="checkbox"/>	6.8	20	70	8	-
4NKRC6.9	<input type="checkbox"/>	6.9	20	70	8	-
4NKRC7	<input checked="" type="checkbox"/>	7	20	70	8	3,470
4NKRC7.1	<input type="checkbox"/>	7.1	20	70	8	-
4NKRC7.2	<input type="checkbox"/>	7.2	20	70	8	-
4NKRC7.3	<input type="checkbox"/>	7.3	20	70	8	-

商品コード Item code	在庫 Stock	寸法 Size (mm)				希望小売 価格(円) Suggested retail price(¥)
		外径 Tool dia.	刃長 Flute length	全長 Overall length	シャンク径 Shank dia.	
4NKRC7.4	<input type="checkbox"/>	7.4	20	70	8	-
4NKRC7.5	<input checked="" type="checkbox"/>	7.5	20	70	8	3,470
4NKRC7.6	<input type="checkbox"/>	7.6	20	70	8	-
4NKRC7.7	<input type="checkbox"/>	7.7	20	70	8	-
4NKRC7.8	<input type="checkbox"/>	7.8	20	70	8	-
4NKRC7.9	<input type="checkbox"/>	7.9	20	70	8	-
4NKRC8	<input checked="" type="checkbox"/>	8	20	70	8	3,470
4NKRC8.1	<input type="checkbox"/>	8.1	25	80	10	-
4NKRC8.2	<input type="checkbox"/>	8.2	25	80	10	-
4NKRC8.3	<input type="checkbox"/>	8.3	25	80	10	-
4NKRC8.4	<input type="checkbox"/>	8.4	25	80	10	-
4NKRC8.5	<input checked="" type="checkbox"/>	8.5	25	80	10	4,040
4NKRC8.6	<input type="checkbox"/>	8.6	25	80	10	-
4NKRC8.7	<input type="checkbox"/>	8.7	25	80	10	-
4NKRC8.8	<input type="checkbox"/>	8.8	25	80	10	-
4NKRC8.9	<input type="checkbox"/>	8.9	25	80	10	-
4NKRC9	<input checked="" type="checkbox"/>	9	25	80	10	4,040
4NKRC9.1	<input type="checkbox"/>	9.1	25	80	10	-
4NKRC9.2	<input type="checkbox"/>	9.2	25	80	10	-
4NKRC9.3	<input type="checkbox"/>	9.3	25	80	10	-
4NKRC9.4	<input type="checkbox"/>	9.4	25	80	10	-
4NKRC9.5	<input checked="" type="checkbox"/>	9.5	25	80	10	4,040
4NKRC9.6	<input type="checkbox"/>	9.6	25	80	10	-
4NKRC9.7	<input type="checkbox"/>	9.7	25	80	10	-
4NKRC9.8	<input type="checkbox"/>	9.8	25	80	10	-
4NKRC9.9	<input type="checkbox"/>	9.9	25	80	10	-
4NKRC10	<input checked="" type="checkbox"/>	10	25	80	10	4,040
4NKRC10.1	<input type="checkbox"/>	10.1	30	95	12	-
4NKRC10.2	<input type="checkbox"/>	10.2	30	95	12	-
4NKRC10.3	<input type="checkbox"/>	10.3	30	95	12	-
4NKRC10.4	<input type="checkbox"/>	10.4	30	95	12	-
4NKRC10.5	<input type="checkbox"/>	10.5	30	95	12	-
4NKRC10.6	<input type="checkbox"/>	10.6	30	95	12	-
4NKRC10.7	<input type="checkbox"/>	10.7	30	95	12	-
4NKRC10.8	<input type="checkbox"/>	10.8	30	95	12	-
4NKRC10.9	<input type="checkbox"/>	10.9	30	95	12	-
4NKRC11	<input checked="" type="checkbox"/>	11	30	95	12	5,140
4NKRC11.1	<input type="checkbox"/>	11.1	30	95	12	-
4NKRC11.2	<input type="checkbox"/>	11.2	30	95	12	-
4NKRC11.3	<input type="checkbox"/>	11.3	30	95	12	-
4NKRC11.4	<input type="checkbox"/>	11.4	30	95	12	-
4NKRC11.5	<input type="checkbox"/>	11.5	30	95	12	-
4NKRC11.6	<input type="checkbox"/>	11.6	30	95	12	-
4NKRC11.7	<input type="checkbox"/>	11.7	30	95	12	-
4NKRC11.8	<input type="checkbox"/>	11.8	30	95	12	-
4NKRC11.9	<input type="checkbox"/>	11.9	30	95	12	-
4NKRC12	<input checked="" type="checkbox"/>	12	30	95	12	5,140
4NKRC12.1	<input type="checkbox"/>	12.1	35	105	16	-
4NKRC12.2	<input type="checkbox"/>	12.2	35	105	16	-
4NKRC12.3	<input type="checkbox"/>	12.3	35	105	16	-
4NKRC12.4	<input type="checkbox"/>	12.4	35	105	16	-
4NKRC12.5	<input type="checkbox"/>	12.5	35	105	16	-
4NKRC12.6	<input type="checkbox"/>	12.6	35	105	16	-
4NKRC12.7	<input type="checkbox"/>	12.7	35	105	16	-

4NKRC○○.○

商品コード Item code	在庫 Stock	寸法 Size (mm)				希望小売 価格(円) Suggested retail price(¥)
		外径 Tool dia.	刃長 Flute length	全長 Overall length	シャンク径 Shank dia.	
4NKRC12.8	□	12.8	35	105	16	—
4NKRC12.9	□	12.9	35	105	16	—
4NKRC13	●	13	35	100	12	6,390
4NKRC13.1	□	13.1	35	105	16	—
4NKRC13.2	□	13.2	35	105	16	—
4NKRC13.3	□	13.3	35	105	16	—
4NKRC13.4	□	13.4	35	105	16	—
4NKRC13.5	□	13.5	35	105	16	—
4NKRC13.6	□	13.6	35	105	16	—
4NKRC13.7	□	13.7	35	105	16	—
4NKRC13.8	□	13.8	35	105	16	—
4NKRC13.9	□	13.9	35	105	16	—
4NKRC14	●	14	35	105	16	6,390
4NKRC14.1	□	14.1	40	110	16	—
4NKRC14.2	□	14.2	40	110	16	—
4NKRC14.3	□	14.3	40	110	16	—
4NKRC14.4	□	14.4	40	110	16	—
4NKRC14.5	□	14.5	40	110	16	—
4NKRC14.6	□	14.6	40	110	16	—
4NKRC14.7	□	14.7	40	110	16	—
4NKRC14.8	□	14.8	40	110	16	—
4NKRC14.9	□	14.9	40	110	16	—
4NKRC15	●	15	40	110	16	7,120
4NKRC15.1	□	15.1	40	110	16	—
4NKRC15.2	□	15.2	40	110	16	—
4NKRC15.3	□	15.3	40	110	16	—
4NKRC15.4	□	15.4	40	110	16	—
4NKRC15.5	□	15.5	40	110	16	—
4NKRC15.6	□	15.6	40	110	16	—
4NKRC15.7	□	15.7	40	110	16	—
4NKRC15.8	□	15.8	40	110	16	—
4NKRC15.9	□	15.9	40	110	16	—
4NKRC16	●	16	40	110	16	7,680
4NKRC16.1	□	16.1	40	120	20	—
4NKRC16.2	□	16.2	40	120	20	—
4NKRC16.3	□	16.3	40	120	20	—
4NKRC16.4	□	16.4	40	120	20	—
4NKRC16.5	□	16.5	40	120	20	—
4NKRC16.6	□	16.6	40	120	20	—
4NKRC16.7	□	16.7	40	120	20	—
4NKRC16.8	□	16.8	40	120	20	—
4NKRC16.9	□	16.9	40	120	20	—
4NKRC17	●	17	40	110	16	9,190
4NKRC17.1	□	17.1	40	120	20	—
4NKRC17.2	□	17.2	40	120	20	—
4NKRC17.3	□	17.3	40	120	20	—
4NKRC17.4	□	17.4	40	120	20	—
4NKRC17.5	□	17.5	40	120	20	—
4NKRC17.6	□	17.6	40	120	20	—
4NKRC17.7	□	17.7	40	120	20	—
4NKRC17.8	□	17.8	40	120	20	—
4NKRC17.9	□	17.9	40	120	20	—

商品コード Item code	在庫 Stock	寸法 Size (mm)				希望小売 価格(円) Suggested retail price(¥)
		外径 Tool dia.	刃長 Flute length	全長 Overall length	シャンク径 Shank dia.	
4NKRC18	●	18	40	110	16	9,190
4NKRC18.1	□	18.1	45	125	20	—
4NKRC18.2	□	18.2	45	125	20	—
4NKRC18.3	□	18.3	45	125	20	—
4NKRC18.4	□	18.4	45	125	20	—
4NKRC18.5	□	18.5	45	125	20	—
4NKRC18.6	□	18.6	45	125	20	—
4NKRC18.7	□	18.7	45	125	20	—
4NKRC18.8	□	18.8	45	125	20	—
4NKRC18.9	□	18.9	45	125	20	—
4NKRC19	●	19	45	125	20	11,030
4NKRC19.1	□	19.1	45	125	20	—
4NKRC19.2	□	19.2	45	125	20	—
4NKRC19.3	□	19.3	45	125	20	—
4NKRC19.4	□	19.4	45	125	20	—
4NKRC19.5	□	19.5	45	125	20	—
4NKRC19.6	□	19.6	45	125	20	—
4NKRC19.7	□	19.7	45	125	20	—
4NKRC19.8	□	19.8	45	125	20	—
4NKRC19.9	□	19.9	45	125	20	—
4NKRC20	●	20	45	125	20	11,030
4NKRC20.5	□	20.5	45	135	25	—
4NKRC21	●	21	45	125	20	13,890
4NKRC21.5	□	21.5	45	135	25	—
4NKRC22	●	22	45	125	20	13,890
4NKRC22.5	□	22.5	50	140	25	—
4NKRC23	●	23	50	140	25	16,230
4NKRC23.5	□	23.5	50	140	25	—
4NKRC24	●	24	50	140	25	16,230
4NKRC24.5	□	24.5	50	140	25	—
4NKRC25	●	25	50	140	25	16,230
4NKRC25.5	□	25.5	50	140	25	—
4NKRC26	●	26	50	140	25	17,050
4NKRC26.5	□	26.5	55	145	25	—
4NKRC27	●	27	55	145	25	20,490
4NKRC27.5	□	27.5	55	145	25	—
4NKRC28	●	28	55	145	25	20,490
4NKRC28.5	□	28.5	55	145	25	—
4NKRC29	●	29	55	145	25	25,030
4NKRC29.5	□	29.5	55	145	25	—
4NKRC30	●	30	55	145	25	25,030
4NKRC30.5	□	30.5	60	160	32	—
4NKRC31	□	31	60	160	32	—
4NKRC32	●	32	60	160	32	30,530
4NKRC33	□	33	60	160	32	—
4NKRC34	●	34	60	160	32	36,170
4NKRC35	●	35	60	160	32	36,170
4NKRC36	●	36	60	160	32	40,570
4NKRC37	□	37	60	160	32	—
4NKRC38	●	38	65	165	32	43,730
4NKRC39	□	39	65	165	32	—
4NKRC40	●	40	65	165	32	50,880

ハイエンドミル
スクエアエンドミル

○ 対応被削材 Applicable work material

炭素鋼 合金鋼 Carbon steel Alloy steel	炭素鋼 合金鋼 Pre-hardened steel ≤ 45HRC	高硬度 Hardened steel			ステン レス鋼 Stainless steel	チタン合金 耐熱合金 Titanium alloy Heat-resistant alloy	銅合金 Copper alloy	アルミ 合金 Aluminum alloy
		> 45HRC ≤ 55HRC	> 55HRC ≤ 65HRC	> 65HRC				
○	○			○	○		○	

○ 再研磨対応外径範囲 Re-grinding compatibility range

商品コード Item code	外周 Outer dia. (mm)	エンド End (mm)
4NKRC	6 ~ 40	2 ~ 40

●印：標準在庫品です。●：Stoked items。□印：特定代理店在庫です。弊社営業へお問い合わせください。□：Stocked by specified distributor. Contact with our sales department.

NKエンドミル

ロング刃長・センタカット

Long, Center-cut



+0.03~0



(mm)



4NKLC (×)

商品コード Item code	在庫 Stock	寸法 Size (mm)				希望小売 価格(円) Suggested retail price(¥)
		外径 Tool dia.	刃長 Flute length	全長 Overall length	シャンク径 Shank dia.	
4NKLC2.5	□	2.5	15	60	6	—
4NKLC3	●	3	15	60	6	3,800
4NKLC3.5	□	3.5	20	65	6	—
4NKLC4	●	4	20	65	6	3,800
4NKLC4.5	□	4.5	25	70	6	—
4NKLC5	●	5	25	70	6	3,800
4NKLC5.5	□	5.5	25	70	6	—
4NKLC6	●	6	25	70	6	3,800
4NKLC6.5	□	6.5	35	85	8	—
4NKLC7	●	7	35	85	8	4,390
4NKLC7.5	□	7.5	35	85	8	—
4NKLC8	●	8	35	85	8	4,390
4NKLC8.5	□	8.5	45	100	10	—
4NKLC9	●	9	45	100	10	4,940
4NKLC9.5	□	9.5	45	100	10	—
4NKLC10	●	10	45	100	10	4,940
4NKLC10.5	□	10.5	55	120	12	—
4NKLC11	●	11	55	120	12	6,090
4NKLC11.5	□	11.5	55	120	12	—
4NKLC12	●	12	55	120	12	6,090
4NKLC12.5	□	12.5	55	125	16	—
4NKLC13	●	13	55	120	12	7,830
4NKLC13X16	□	13	55	125	16	—
4NKLC13.5	□	13.5	55	125	16	—
4NKLC14	●	14	55	125	16	7,830
4NKLC14.5	□	14.5	65	135	16	—
4NKLC15	●	15	65	135	16	8,630
4NKLC15.5	□	15.5	65	135	16	—
4NKLC16	●	16	65	135	16	9,670
4NKLC16.5	□	16.5	65	145	20	—
4NKLC17	●	17	65	135	16	11,770
4NKLC17X20	□	17	65	135	20	—
4NKLC17.5	□	17.5	65	145	20	—
4NKLC18	●	18	65	135	16	11,770
4NKLC18X20	□	18	65	135	20	—
4NKLC18.5	□	18.5	75	155	20	—

商品コード Item code	在庫 Stock	寸法 Size (mm)				希望小売 価格(円) Suggested retail price(¥)
		外径 Tool dia.	刃長 Flute length	全長 Overall length	シャンク径 Shank dia.	
4NKLC19	●	19	75	155	20	13,530
4NKLC19.5	□	19.5	75	155	20	—
4NKLC20	●	20	75	155	20	13,530
4NKLC20.5	□	20.5	75	165	25	—
4NKLC21	□	21	75	155	20	—
4NKLC21X25	□	21	75	155	25	—
4NKLC21.5	□	21.5	75	165	25	—
4NKLC22	●	22	75	155	20	18,020
4NKLC22X25	□	22	75	155	25	—
4NKLC22.5	□	22.5	90	180	25	—
4NKLC23	□	23	90	180	25	—
4NKLC23.5	□	23.5	90	180	25	—
4NKLC24	●	24	90	180	25	22,280
4NKLC24.5	□	24.5	90	180	25	—
4NKLC25	●	25	90	180	25	22,280
4NKLC25.5	□	25.5	90	180	25	—
4NKLC26	●	26	90	180	25	24,200
4NKLC26.5	□	26.5	90	180	25	—
4NKLC27	□	27	90	180	25	—
4NKLC27.5	□	27.5	90	180	25	—
4NKLC28	●	28	90	180	25	28,600
4NKLC28.5	□	28.5	90	180	25	—
4NKLC29	□	29	90	180	25	—
4NKLC29.5	□	29.5	90	180	25	—
4NKLC30	●	30	90	180	25	34,520
4NKLC31	□	31	95	195	32	—
4NKLC32	●	32	95	195	32	42,220
4NKLC33	□	33	95	195	32	—
4NKLC34	□	34	95	195	32	—
4NKLC35	●	35	100	200	32	52,670
4NKLC36	□	36	100	200	32	—
4NKLC37	□	37	100	200	32	—
4NKLC38	□	38	105	205	32	—
4NKLC39	□	39	110	210	32	—
4NKLC40X32	●	40	110	210	32	73,020

対応被削材 Applicable work material

炭素鋼 合金鋼 Carbon steel Alloy steel	炭素鋼 合金鋼 Pre-hardened steel ≤ 45HRC	高硬度 Hardened steel			ステン レス鋼 Stainless steel	チタン合金 耐熱合金 Titanium alloy Heat-resistant alloy	銅合金 Copper alloy	アルミ 合金 Aluminum alloy
		> 45HRC ≤ 55HRC	> 55HRC ≤ 65HRC	> 65HRC				
○					○	○	○	

再研磨対応外径範囲 Re-grinding compatibility range

商品コード Item code	外周 Outer dia. (mm)	エンド End (mm)
4NKLC	6 ~ 40	2.5 ~ 40

AT Coating Power Helical End Mill series

ATパワーヘリカルシリーズ

レギュラー刃長 Regular



外径公差 Dia. tolerance 0~-0.03

h6

(mm)



HKR $\bigcirc\bigcirc$ -AT

コバルトハイス **AT** ねじり43° 切削条件表 **H47**
HSS-Co Helix angle Cutting Conditions

商品コード Item code	在庫 Stock	寸法 Size (mm)				希望小売 価格(円) Suggested retail price(¥)
		外径 Tool dia.	刃長 Flute length	全長 Overall length	シャンク径 Shank dia.	
HKR6-AT	●	6	15	70	6	5,470
HKR8-AT	●	8	20	75	8	5,870
HKR10-AT	●	10	25	90	10	6,940
HKR12-AT	●	12	30	95	12	9,190
HKR16-AT	●	16	42	110	16	13,570
HKR20-AT	●	20	45	125	20	20,900
HKR25-AT	●	25	50	140	25	30,390
HKR30-AT	●	30	55	145	25	48,820

ロング刃長 Long



外径公差 Dia. tolerance 0~-0.03

h6

(mm)



HKL $\bigcirc\bigcirc$ -AT

コバルトハイス **AT** ねじり43° 切削条件表 **H47**
HSS-Co Helix angle Cutting Conditions

商品コード Item code	在庫 Stock	寸法 Size (mm)				希望小売 価格(円) Suggested retail price(¥)
		外径 Tool dia.	刃長 Flute length	全長 Overall length	シャンク径 Shank dia.	
HKL12-AT	●	12	55	120	12	11,940
HKL16-AT	●	16	65	140	16	17,600
HKL20-AT	●	20	85	165	20	26,950
HKL25-AT	●	25	100	195	25	39,470
HKL30-AT	●	30	105	200	25	63,390

ミディアム刃長 Medium



外径公差 Dia. tolerance 0~-0.03

h6

(mm)



HKM $\bigcirc\bigcirc$ -AT

コバルトハイス **AT** ねじり43° 切削条件表 **H47**
HSS-Co Helix angle Cutting Conditions

商品コード Item code	在庫 Stock	寸法 Size (mm)				希望小売 価格(円) Suggested retail price(¥)
		外径 Tool dia.	刃長 Flute length	全長 Overall length	シャンク径 Shank dia.	
HKM12-AT	●	12	45	120	12	10,570
HKM16-AT	●	16	55	140	16	15,540
HKM20-AT	●	20	65	165	20	23,930
HKM25-AT	●	25	75	195	25	34,790
HKM30-AT	●	30	80	200	25	56,100

ハイヘリカル High Helix

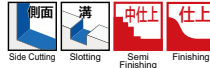

外径公差 Dia. tolerance 0~-0.04

h6

(mm)



HKN $\bigcirc\bigcirc$ -AT

コバルトハイス **AT** ねじり50° 切削条件表 **H47**
HSS-Co Helix angle Cutting Conditions

商品コード Item code	在庫 Stock	寸法 Size (mm)				希望小売 価格(円) Suggested retail price(¥)
		外径 Tool dia.	刃長 Flute length	全長 Overall length	シャンク径 Shank dia.	
HKN6-AT	●	6	15	70	6	5,490
HKN8-AT	●	8	20	75	8	5,890
HKN10-AT	●	10	25	90	10	6,970
HKN11-AT	●	11	30	95	12	9,030
HKN12-AT	●	12	30	95	12	9,030
HKN13-AT	●	13	30	95	12	11,300
HKN14-AT	●	14	35	105	12	11,300
HKN15-AT	●	15	40	115	16	13,020
HKN16-AT	●	16	40	115	16	13,020
HKN18-AT	●	18	40	120	16	16,640
HKN20-AT	●	20	45	130	20	20,080
HKN25-AT	●	25	50	140	25	29,290
HKN30-AT	●	30	55	150	25	47,030

ハイスエンドミル スクエアエンドミル

HK-ATの対応被削材 Applicable work material of HK-AT

炭素鋼 合金鋼 Carbon steel Alloy steel	炭素鋼 合金鋼 Pre-hardened steel ≤ 45HRC	高硬度 Hardened steel			ステン レス鋼 Stainless steel	チタン合金 耐熱合金 Titanium alloy Heat-resistant alloy	銅合金 Copper alloy	アルミ 合金 Aluminum alloy
		> 45HRC ≤ 55HRC	> 55HRC ≤ 65HRC	> 65HRC				
○	○				○	○	○	

再研磨対応外径範囲 Re-grinding compatibility range

商品コード Item code	外周 Outer dia. (mm)	エンド End (mm)
HKR-AT	6 ~ 30	6 ~ 30
HKM-AT	12 ~ 30	12 ~ 30
HKL-AT	12 ~ 30	12 ~ 30
HKN-AT	6 ~ 30	6 ~ 30

標準切削条件表 Recommended cutting conditions

寸法表 Size list : H46

寸法表 Size list : H46

寸法表 Size list : H46

寸法表 Size list : H46

HKR-AT

HKM-AT

HKL-AT

HKN-AT

AT パワーヘリカル・レギュラー刃長
AT Power Helical, Regular

AT パワーヘリカル・ミディアム刃長
AT Power Helical, Medium

AT パワーヘリカル・ロング刃長
AT Power Helical, Long

AT ハイヘリカル・レギュラー刃長
AT High Helical, Regular

被削材 (硬さ) Work material (Hardness)	側面切込み (mm) Side cutting depth DC:外径mill dia.	溝切込み (mm) Slotting depth DC:外径mill dia.	切削条件 Cutting conditions	外径DC Tool dia. (mm)															
				ATパワーヘリカル AT Coating Power Helical								ATハイヘリカル AT Coating High Helical							
				φ6	φ8	φ10	φ12	φ16	φ20	φ25	φ30	φ6	φ8	φ10	φ12	φ16	φ20	φ25	φ30
炭素鋼・合金鋼 Carbon steels, Alloy steels (~250HB) SS, S50C, SCM, SNCM	$a_p < 1.5DC$ $a_e < 0.1DC$	$a_p < 0.5DC$	回転数 Revolution	1,800	1,600	1,500	1,400	1,100	850	700	520	2,500	1,800	1,650	1,300	1,050	850	650	500
			送り速度 Feed rate	500	480	460	450	440	410	370	350	205	205	205	200	200	200	180	160
工具鋼・ステンレス鋼 Tool steels, Stainless steels (25~35HRC) SKD, SKT, HPM1, NAK55, SUS304	$a_p < 1.5DC$ $a_e < 0.1DC$	$a_p < 0.5DC$	回転数 Revolution	1,470	1,380	1,300	1,200	840	680	505	420	1,800	1,500	1,450	1,200	800	700	500	400
			送り速度 Feed rate	415	405	390	380	340	300	250	190	150	155	155	155	150	150	140	130
調質鋼・プリハードン鋼 Hardened steels, Pre-hardened steels (35~45HRC) CEN A1, NAK80, SKD, SKT	$a_p < 1.0DC$ $a_e < 0.1DC$	$a_p < 0.5DC$	回転数 Revolution	1,180	1,060	950	860	720	550	415	310	1,200	950	750	600	500	450	400	300
			送り速度 Feed rate	270	265	255	244	230	220	195	140	110	110	120	100	100	90	90	70
耐熱鋼・チタン合金 Heat-resistant steels, Titanium alloys Inconel, Hasteloy, Ti-6Al-4V	$a_p < 1.0DC$ $a_e < 0.1DC$	$a_p < 0.5DC$	回転数 Revolution	720	640	570	480	360	280	230	150	950	700	600	550	450	400	320	220
			送り速度 Feed rate	130	140	130	130	120	100	90	60	85	85	85	75	75	70	70	65

- 【注意】**
- ① 本工具のATコーティングはその性質上、通電性が微小です。従って、通電方式の工具長測定装置をご使用の際にはご注意ください。
 - ② 被削材、加工形状に合わせて、適切なクーラントを使用してください。
 - ③ この標準切削条件表は切削条件の目安を示すものです。実際の加工では加工形状、目的、使用機械等により条件を調整してください。
 - ④ 上記の数値は、レギュラー刃長の場合の条件です。ロング刃長の場合は回転・送りともに70%にしてください。
 - ⑤ 溝切削加工時は、回転数・送り速度共に70%まで下げた加工を推奨致します。

- 【Note】**
- ① This product obtains less electric conductivity. Therefore, Please caution of using electric transmitted measuring systems.
 - ② Use the appropriate coolant for the work material and machining shape.
 - ③ These Recommended Cutting Conditions indicate only the rule of a thumb for the cutting conditions. In actual machining, the condition should be adjusted according to the machining shape, purpose and the machine type.
 - ④ The values shown above are conditions for regular flute length. For long flute lengths, set both rotation speed and feed rate to 70% of the above values.
 - ⑤ For slotting, it is recommended that both rotation speed and feed rate be reduced to 70% of the above values.

C Coating ESM Power Helical End Mill

ESM-Cコートパワーヘリカル

レギュラー刃長 Regular



外径公差 Dia. tolerance 0~0.03 (mm)



ロング刃長 Long



外径公差 Dia. tolerance 0~0.03 (mm)



ESMHKR (×32)



商品コード Item code	在庫 Stock	寸法 Size (mm)				希望小売 価格(円) Suggested retail price(¥)
		外径 Tool dia.	刃長 Flute length	全長 Overall length	シャンク径 Shank dia.	
ESMHKR6	●	6	15	70	6	7,180
ESMHKR8	●	8	20	75	8	7,690
ESMHKR10	●	10	25	90	10	9,100
ESMHKR12	●	12	30	95	12	12,070
ESMHKR16	●	16	42	110	16	17,880
ESMHKR20	●	20	45	125	20	27,370
ESMHKR25	●	25	50	140	25	41,800
ESMHKR30	●	30	55	145	25	67,100
ESMHKR30X32	●	30	55	145	32	67,100

ESMHKL (×32)



商品コード Item code	在庫 Stock	寸法 Size (mm)				希望小売 価格(円) Suggested retail price(¥)
		外径 Tool dia.	刃長 Flute length	全長 Overall length	シャンク径 Shank dia.	
ESMHKL12	●	12	55	120	12	15,680
ESMHKL16	●	16	65	140	16	22,970
ESMHKL20	●	20	85	165	20	35,200
ESMHKL25	●	25	100	195	25	54,320
ESMHKL30	●	30	105	200	25	87,180
ESMHKL30X32	●	30	105	200	32	87,180

ミディアム刃長 Medium

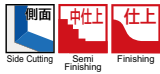

外径公差 Dia. tolerance 0~0.03 (mm)



ESMHKM (×32)



商品コード Item code	在庫 Stock	寸法 Size (mm)				希望小売 価格(円) Suggested retail price(¥)
		外径 Tool dia.	刃長 Flute length	全長 Overall length	シャンク径 Shank dia.	
ESMHKM12	●	12	45	120	12	13,890
ESMHKM16	●	16	55	140	16	20,490
ESMHKM20	●	20	65	165	20	31,350
ESMHKM25	●	25	75	195	25	47,990
ESMHKM30	●	30	80	200	25	77,140
ESMHKM30X32	●	30	80	200	32	77,140

ESNHKの対応被削材 Applicable work material of ESMHK

炭素鋼 合金鋼 Carbon steel Alloy steel	炭素鋼 合金鋼 Pre-hardened steel ≤ 45HRC	高硬度 Hardened steel			ステン レス鋼 Stainless steel	チタン合金 耐熱合金 Titanium alloy Heat-resistant alloy	銅合金 Copper alloy	アルミ 合金 Aluminum alloy
		> 45HRC ≤ 55HRC	> 55HRC ≤ 65HRC	> 65HRC				
○	○	○	○	○	○	○	○	

●印：標準在庫品です。 ●：Stoked items.

再研磨対応外径範囲 Re-grinding compatibility range

商品コード Item code	外周 Outer dia. (mm)	エンド End (mm)
ESMHKR	6 ~ 30	6 ~ 30
ESMHKM	12 ~ 30	12 ~ 30
ESMHKL	12 ~ 30	12 ~ 30

標準切削条件表 Recommended cutting conditions

寸法表 Size list : H48 寸法表 Size list : H48 寸法表 Size list : H48

ESMHKR レギュラー刃長 Regular	ESMHKM (注①) ミディアム刃長 Medium	ESMHKL (注①) ロング刃長 Long
-------------------------------------	---	-------------------------------------

<側面切削> Side milling

被削材 (硬さ) Work material (Hardness)	条件域 Condition Range	切込み Depth of cut mm	切削条件 Cutting Conditions	外径 DC Tool dia. (mm)				
				φ12	φ16	φ20	φ25	φ30
炭素鋼・合金鋼 Carbon steels, Alloy steels (~250HB) SS, S50C, SCM, SNCM	汎用条件 General	ap=1.5DC ae=0.1DC	回転数 min ⁻¹	1,190	895	720	570	420
			送り速度 mm/min	380	360	350	300	280
工具鋼・ステンレス鋼・プリハードン鋼 Tool steels, Stainless steels, Pre-Hardened steels (25~35HRC) SKD, SKT, HPM1, NAK55, SUS304	汎用条件 General	ap=1.5DC ae=0.1DC	回転数 min ⁻¹	930	700	560	445	330
			送り速度 mm/min	298	280	250	220	150
調質鋼・プリハードン鋼 Hardened steels, Pre-Harden steels (35~45HRC) CENA1, NAK80, SKD, SKT	汎用条件 General	ap=1.5DC ae=0.1DC	回転数 min ⁻¹	740	560	450	360	265
			送り速度 mm/min	210	180	180	170	120
耐熱鋼・チタン合金 Heat-resistant steels, Titanium alloys Inconel, Hasteloy Ti-6Al-4V	汎用条件 General	ap=1.5DC ae=0.1DC	回転数 min ⁻¹	400	300	240	190	130
			送り速度 mm/min	110	100	85	75	50

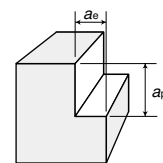

<溝切削> Slotting

被削材 (硬さ) Work material (Hardness)	条件域 Condition Range	切込み Depth of cut mm	切削条件 Cutting Conditions	外径 DC Tool dia. (mm)				
				φ12	φ16	φ20	φ25	φ30
炭素鋼・合金鋼 Carbon steels, Alloy steels (~250HB) SS, S50C, SCM, SNCM	汎用条件 General	ap=0.5DC ae=1DC	回転数 min ⁻¹	750	550	450	350	265
			送り速度 mm/min	120	130	125	100	75
工具鋼・ステンレス鋼・プリハードン鋼 Tool steels, Stainless steels, Pre-Hardened steels (25~35HRC) SKD, SKT, HPM1, NAK55, SUS304	汎用条件 General	ap=0.5DC ae=1DC	回転数 min ⁻¹	590	440	350	280	220
			送り速度 mm/min	95	105	100	80	60
調質鋼・プリハードン鋼 Hardened steels, Pre-Harden steels (35~45HRC) CENA1, NAK80, SKD, SKT	汎用条件 General	ap=0.5DC ae=1DC	回転数 min ⁻¹	425	320	255	205	160
			送り速度 mm/min	65	75	70	60	45
耐熱鋼・チタン合金 Heat-resistant steels, Titanium alloys Inconel, Hasteloy Ti-6Al-4V	汎用条件 General	ap=0.5DC ae=1DC	回転数 min ⁻¹	265	200	160	130	110
			送り速度 mm/min	40	45	45	35	30

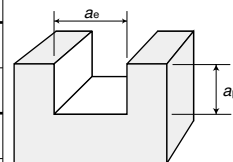

- [注意]**
- ① この標準切削条件表は切削条件の目安を示すものです。実際の加工では加工形状、目的、使用機械等により条件を調整してください。
 - ② 上記条件はレギュラー刃長の場合を示します。ミディアム刃の場合は回転数と送り速度を1/2に、ロング刃は1/3に下げてください。ミディアム刃とロング刃は溝切削に適しません。
 - ③ 切削油剤は鋼の場合は不水溶性切削油を、非鉄金属の場合は水溶性切削油をご使用ください。乾式の場合はエアブローを推奨します。
 - ④ 切削条件表は機械主軸がBT50の場合を想定しています。BT40以下の場合、回転数と切込みを1/2に下げてください。
 - ⑤ 仕上時の切込み例: W1=0.1mm → W2=0.05mm → W3=ゼロカット(ダウンカット)
 - ⑥ ミーリングチャックは把握力が強く、高精度のものをご使用ください。

- [Note]**
- ① These Recommended Cutting Conditions indicate only the rule of a thumb for the cutting conditions. In actual machining, the condition should be adjusted according to the machining shape, purpose and the machine type.
 - ② In using the medium flute length type, decrease the revolution number and the feed speed one half, and in using the long length type, decrease them one third as a guide. The long length type and medium length type aren't suited to slotting.
 - ③ Oily cutting fluid should be used for steel cutting, and water-soluble cutting fluid should be used for cutting of non-ferrous metals. It is recommended to adopt air blow method when using dry cutting.
 - ④ The table of cutting conditions is made assuming that the spindle of a machine is BT50. In the case of BT40 of the spindle or smaller, decrease the revolution number and the depth of cut one half.
 - ⑤ Example of depth of cut in finishing :W1= 0.1 mm W2= 0.05 mm W3= Zero-cut (Down cut)
 - ⑥ Use a mealing chuck with high grasping force and high precision.

High Helix End Mills

強ねじれエンドミル

ハイヘリカル

High helical



0 ~ -0.04



(mm)



ESMHN

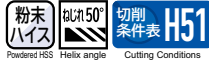

商品コード Item code	在庫 Stock	寸法 Size (mm)				希望小売 価格(円) Suggested retail price(¥)
		外径 Tool dia.	刃長 Flute length	全長 Overall length	シャンク径 Shank dia.	
ESMHN6	●	6	15	70	6	5,340
ESMHN7	□	7	20	75	8	-
ESMHN8	●	8	20	75	8	5,730
ESMHN9	□	9	25	90	10	-
ESMHN10	●	10	25	90	10	6,780
ESMHN11	●	11	30	95	12	8,780
ESMHN12	●	12	30	95	12	8,780
ESMHN13	●	13	30	95	12	10,990
ESMHN14	●	14	35	105	12	10,990
ESMHN15	●	15	40	115	16	12,650
ESMHN16	●	16	40	115	16	12,650
ESMHN17	□	17	40	115	16	-
ESMHN18	●	18	40	120	16	16,230
ESMHN19	□	19	45	130	16	-
ESMHN20	●	20	45	130	20	19,530
ESMHN21	□	21	45	130	20	-
ESMHN22	□	22	45	130	20	-
ESMHN23	□	23	50	140	20	-
ESMHN24	□	24	50	140	20	-
ESMHN25	●	25	50	140	25	29,980
ESMHN26	□	26	50	140	25	-
ESMHN28	□	28	55	150	25	-
ESMHN30	●	30	55	150	25	47,990

ハイスエンドミル
スクエアエンドミル

○ 対応被削材 Applicable work material

炭素鋼 合金鋼 Carbon steel Alloy steel	炭素鋼 合金鋼 Pre-hardened steel ≤ 45HRC	高硬度 Hardened steel			ステン レス鋼 Stainless steel	チタン合金 耐熱合金 Titanium alloy Heat-resistant alloy	銅合金 Copper alloy	アルミ 合金 Aluminum alloy
		> 45HRC ≤ 55HRC	> 55HRC ≤ 65HRC	> 65HRC				
○					○	○	○	

●印：標準在庫品です。□印：特定代理店在庫です。弊社営業へお問い合わせください。
●：Stoked items. □：Stocked by specified distributor. Contact with our sales department.

○ 再研磨対応外径範囲 Re-grinding compatibility range

商品コード Item code	外周 Outer dia. (mm)	エンド End (mm)
ESMHN	6 ~ 30	6 ~ 30

H50

標準切削条件表 Recommended cutting conditions

寸法表 Size list : H50

ESMHN

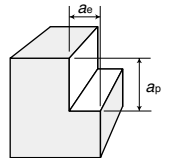

<側面切削> Side milling

被削材 (硬さ) Work material (Hardness)	条件域 Condition Range	切込み Depth of cut mm	切削条件 Cutting Conditions	外径 DC Tool dia. (mm)							
				φ6	φ8	φ10	φ12	φ16	φ20	φ25	φ30
鋳鉄・炭素鋼 Cast irons, Carbon steels (200HB 以下) FC200 SS400, S45C	汎用条件 General	ap=1.5DC ae=0.1DC	回転数 min ⁻¹	2,000	1,500	1,200	1,000	750	600	500	400
			送り速度 mm/min	170	170	170	170	170	170	160	140
合金鋼 Alloy steels (200~250HB) SCM, SNCM	汎用条件 General	ap=1.5DC ae=0.1DC	回転数 min ⁻¹	1,400	1,000	850	700	550	450	350	300
			送り速度 mm/min	120	120	130	130	120	120	120	110
工具鋼・ステンレス鋼 Tool steels, Stainless steels (25~35HRC) SKD, SKT, SUS304	汎用条件 General	ap=1.5DC ae=0.1DC	回転数 min ⁻¹	1,100	900	700	600	450	350	300	250
			送り速度 mm/min	100	100	110	110	100	100	100	90
焼入れ鋼・プリハードン鋼 Hardened steels, Pre-Hardened steels (35~45HRC) SKD, SKT HPM1, NAK55	汎用条件 General	ap=1.5DC ae=0.1DC	回転数 min ⁻¹	850	650	500	450	300	250	200	160
			送り速度 mm/min	75	75	75	75	70	70	60	60
耐熱鋼・チタン合金 Heat-resistant steels, Titanium alloys Inconel Ti-6Al-4V	汎用条件 General	ap=1.5DC ae=0.1DC	回転数 min ⁻¹	650	500	400	350	250	200	150	130
			送り速度 mm/min	60	60	60	60	55	55	55	50

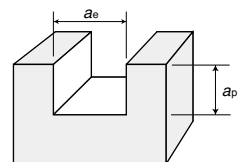

<溝切削> Slotting

被削材 (硬さ) Work material (Hardness)	条件域 Condition Range	切込み Depth of cut mm	切削条件 Cutting Conditions	外径 DC Tool dia. (mm)							
				φ6	φ8	φ10	φ12	φ16	φ20	φ25	φ30
鋳鉄・炭素鋼 Cast irons, Carbon steels (200HB 以下) FC200 SS400, S45C	汎用条件 General	ap=0.5DC ae=1DC	回転数 min ⁻¹	1,800	1,300	1,000	900	650	500	400	350
			送り速度 mm/min	110	110	120	120	120	120	120	120
合金鋼 Alloy steels (200~250HB) SCM, SNCM	汎用条件 General	ap=0.5DC ae=1DC	回転数 min ⁻¹	1,300	1,000	800	700	500	400	320	260
			送り速度 mm/min	90	100	100	100	90	90	90	90
工具鋼・ステンレス鋼 Tool steels, Stainless steels (25~35HRC) SKD, SKT, SUS304	汎用条件 General	ap=0.5DC ae=1DC	回転数 min ⁻¹	1,100	900	700	600	450	350	300	250
			送り速度 mm/min	80	90	90	80	80	80	80	70
焼入れ鋼・プリハードン鋼 Hardened steels, Pre-Hardened steels (35~45HRC) SKD, SKT HPM1, NAK55	汎用条件 General	ap=0.5DC ae=1DC	回転数 min ⁻¹	850	650	500	450	320	250	200	160
			送り速度 mm/min	60	60	60	60	60	60	60	50
耐熱鋼・チタン合金 Heat-resistant steels, Titanium alloys Inconel Ti-6Al-4V	汎用条件 General	ap=0.5DC ae=1DC	回転数 min ⁻¹	550	400	300	250	200	150	120	100
			送り速度 mm/min	40	40	40	40	40	35	35	30

- [注意]** ①被削材、加工形状に合わせて、適切なクーラントを使用してください。
②この標準切削条件表は切削条件の目安を示すものです。実際の加工では加工形状、目的、使用機械等により条件を調整してください。
- [Note]** ① Use the appropriate coolant for the work material and machining shape.
② These Recommended Cutting Conditions indicate only the rule of a thumb for the cutting conditions. In actual machining, the condition should be adjusted according to the machining shape, purpose and the machine type.

AT Coating Roughing End Mill

ATラフィング

ショート刃長 Short



外径公差 Dia. tolerance	φ6~φ12 : 0~-0.1	h6
	φ14~φ16 : 0~-0.15	
	φ18~φ50 : 0~-0.2	



RQS-AT



商品コード Item code	在庫 Stock	寸法 Size (mm)				刃数 No. of Flutes	希望小売価格(円) Suggested retail price(¥)
		外径 Tool dia.	刃長 Flute length	全長 Overall length	シャンク径 Shank dia.		
RQS6-AT	●	6	15	80	6	4	9,340
RQS8-AT	●	8	20	90	8	4	10,320
RQS10-AT	●	10	25	100	10	4	11,500
RQS12-AT	●	12	30	110	12	4	14,720
RQS14-AT	●	14	30	110	12	4	16,090
RQS16-AT	●	16	35	125	16	4	17,880
RQS18-AT	●	18	35	125	16	4	19,670
RQS20-AT	●	20	40	140	20	4	21,180
RQS22-AT	●	22	40	140	20	5	23,930
RQS25-AT	●	25	45	160	25	5	28,470
RQS28-AT	●	28	45	160	25	5	35,340
RQS30-AT	●	30	45	160	25	6	44,690
RQS35-AT	●	35	55	180	32	6	77,280
RQS40-AT	●	40	65	200	32	6	93,370
RQS50-AT	●	50	75	225	42	6	132,970

レギュラー Regular



外径公差 Dia. tolerance	φ6~φ12 : 0~-0.1	h6
	φ16 : 0~-0.15	
	φ18~φ50 : 0~-0.2	



RQR-AT



商品コード Item code	在庫 Stock	寸法 Size (mm)				刃数 No. of Flutes	希望小売価格(円) Suggested retail price(¥)
		外径 Tool dia.	刃長 Flute length	全長 Overall length	シャンク径 Shank dia.		
RQR6-AT	●	6	20	80	6	4	10,930
RQR8-AT	●	8	25	90	8	4	11,930
RQR10-AT	●	10	35	100	10	4	13,480
RQR12-AT	●	12	40	110	12	4	19,530
RQR16-AT	●	16	50	125	16	4	24,340
RQR18-AT	●	18	50	125	16	4	25,850
RQR20-AT	●	20	55	140	20	4	29,020
RQR25-AT	●	25	70	160	25	5	40,150
RQR30-AT	●	30	80	160	25	6	54,590
RQR35-AT	●	35	90	180	32	6	77,280
RQR40-AT	●	40	100	200	32	6	105,470
RQR50-AT	●	50	120	225	42	6	171,880

ロング刃長 Long



外径公差 Dia. tolerance	φ10~φ12 : 0~-0.1	h6
	φ16 : 0~-0.15	
	φ18~50 : 0~-0.2	



RQL-AT



商品コード Item code	在庫 Stock	寸法 Size (mm)				刃数 No. of Flutes	希望小売価格(円) Suggested retail price(¥)
		外径 Tool dia.	刃長 Flute length	全長 Overall length	シャンク径 Shank dia.		
RQL10-AT	●	10	45	100	10	4	15,400
RQL12-AT	●	12	55	110	12	4	19,800
RQL16-AT	●	16	65	125	16	4	24,750
RQL18-AT	●	18	65	125	16	4	26,130
RQL20-AT	●	20	75	140	20	4	29,150
RQL25-AT	●	25	90	165	25	5	40,430
RQL30-AT	●	30	90	165	25	6	55,000
RQL35-AT	●	35	110	190	32	6	78,380
RQL40-AT	●	40	125	205	32	6	106,840
RQL50-AT	●	50	150	255	42	6	174,630

ハイスエンドミル
スクエアエンドミル

○ RQ-ATの対応被削材 Applicable work material of RQ-AT

炭素鋼 合金鋼 Carbon steel Alloy steel	炭素鋼 合金鋼 Pre-hardened steel ≤ 45HRC	高硬度 Hardened steel			ステン レス鋼 Stainless steel	チタン合金 耐熱合金 Titanium alloy Heat-resistant alloy	銅合金 Copper alloy	アルミ 合金 Aluminum alloy
		> 45HRC ≤ 55HRC	> 55HRC ≤ 65HRC	> 65HRC				
○	○			○			○	

●印：標準在庫品です。●：Stoked items.

○ 再研磨対応外径範囲 Re-grinding compatibility range

商品コード Item code	外周 Outer dia. (mm)	エンド End (mm)
RQS-AT	6 ~ 50	6 ~ 50
RQR-AT	6 ~ 50	6 ~ 50
RQL-AT	10 ~ 50	10 ~ 50

標準切削条件表 Recommended cutting conditions

ドライ切削 Dry Cutting

下記の被削材においては **ドライ切削** によって湿式切削よりも高能率で長寿命化が図れます。

For the work materials listed below, dry cutting can be expected to provide higher efficiency and longer life than wet cutting.

寸法表 Size list: H52 寸法表 Size list: H52 寸法表 Size list: H52

RQS-AT ショート刃長 Short	RQR-AT (注①) レギュラー刃長 Regular	RQL-AT (注①) ロング刃長 Long
----------------------------------	--	-------------------------------------

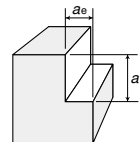

〈側面切削〉 Side milling

被削材(硬さ) Work material (Hardness)	条件域 Condition Range	切込み Depth of cut mm	切削条件 Cutting Conditions	外径DC Tool dia.(mm)									
				φ6	φ8	φ10	φ12	φ16	φ20	φ25	φ30	φ40	φ50
鋳鉄・炭素鋼 Cast irons, Carbon steels (200HB以下) FC200, SS400, S45C	汎用条件 General	$a_p=1.5DC$	回転数 min ⁻¹	3,600	2,700	2,100	1,800	1,200	900	800	600	500	360
		$a_e=0.5DC$ 以下	送り速度 mm/min	400	400	450	450	450	480	400	370	370	300
合金鋼 Alloy steels (200~250HB) SCM, SNCM	汎用条件 General	$a_p=1.5DC$	回転数 min ⁻¹	2,700	2,000	1,600	1,300	1,100	800	600	500	450	350
		$a_e=0.5DC$ 以下	送り速度 mm/min	360	320	320	300	300	300	320	300	320	300
工具鋼 Tool steels (25~35HRC) SKD, SKT	汎用条件 General	$a_p=1.5DC$	回転数 min ⁻¹	2,200	1,800	1,400	1,200	900	650	520	450	350	250
		$a_e=0.4DC$ 以下	送り速度 mm/min	180	220	220	240	240	250	210	210	220	190
焼入れ鋼・プリハードン鋼 Hardened steels, Pre-hardened steels (35~45HRC) HPM1, NAK	汎用条件 General	$a_p=1.5DC$	回転数 min ⁻¹	1,600	1,100	890	750	560	430	320	280	200	180
		$a_e=0.3DC$ 以下	送り速度 mm/min	120	150	150	170	170	170	170	160	170	140

[注意] ①本工具のATコーティングはその性質上、通電性が微小です。従って、通電方式の工具長測定装置をご使用の際にはご注意ください。
②この標準切削条件表は切削条件の目安を示すものです。実際の加工では加工形状、目的、使用機械等により条件を調整してください。
③上記条件はショート刃長の場合を示します。レギュラー刃長の場合は上記条件の回転数・送りを70%、ロング刃長の場合は50%を目安にしてください。

[Note] ① This product obtains less electric conductivity. Therefore, Please caution of using electric transmitted measuring systems.
② These Recommended Cutting Conditions indicate only the rule of a thumb for the cutting conditions.
In actual machining, the condition should be adjusted according to the machining shape, purpose and the machine type.
③ The cutting condition shown in the above table are based on short series. In case of a regular series, reduce the revolution and feed rate to about 70% in the above table. In case of long series, reduce the revolution and feed rate to about 50% in the above table.

寸法表 Size list: H52 寸法表 Size list: H52

RQS-AT ショート刃長 Short	RQR-AT (注①) レギュラー刃長 Regular
----------------------------------	--

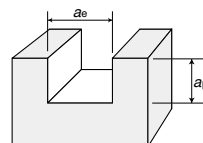

〈溝切削〉 Slotting

被削材(硬さ) Work material (Hardness)	条件域 Condition Range	切込み Depth of cut mm	切削条件 Cutting Conditions	外径DC Tool dia.(mm)									
				φ6	φ8	φ10	φ12	φ16	φ20	φ25	φ30	φ40	φ50
鋳鉄・炭素鋼 Cast irons, Carbon steels (200HB以下) FC200, SS400, S45C	汎用条件 General	$a_p=1DC$ 以下	回転数 min ⁻¹	3,000	2,400	2,000	1,600	1,200	900	700	600	450	360
		$a_e=1DC$	送り速度 mm/min	250	300	300	320	330	360	280	250	250	220
合金鋼 Alloy steels (200~250HB) SCM, SNCM	汎用条件 General	$a_p=1DC$ 以下	回転数 min ⁻¹	2,400	1,800	1,400	1,300	1,000	800	600	500	400	350
		$a_e=1DC$	送り速度 mm/min	240	250	270	270	270	270	260	250	270	240
工具鋼 Tool steels (25~35HRC) SKD, SKT	汎用条件 General	$a_p=1DC$ 以下	回転数 min ⁻¹	1,800	1,400	1,100	1,000	700	560	450	320	260	200
		$a_e=1DC$	送り速度 mm/min	180	180	180	200	200	210	190	190	190	160
焼入れ鋼・プリハードン鋼 Hardened steels, Pre-hardened steels (35~45HRC) HPM1, NAK	汎用条件 General	$a_p=1DC$ 以下	回転数 min ⁻¹	1,600	1,100	890	750	560	430	320	280	200	180
		$a_e=1DC$	送り速度 mm/min	100	110	110	110	120	120	100	100	100	90

[注意] ①本工具のATコーティングはその性質上、通電性が微小です。従って、通電方式の工具長測定装置をご使用の際にはご注意ください。
②この標準切削条件表は切削条件の目安を示すものです。実際の加工では加工形状、目的、使用機械等により条件を調整してください。
③上記条件はショート刃長の場合を示します。レギュラー刃長の場合は上記条件の回転数・送りを70%を目安にしてください。
④5枚刃以上でご使用になられる場合は、切り込み(a_p)を調整してください。
⑤ロング刃は溝切削には適しません。

[Note] ① This product obtains less electric conductivity. Therefore, Please caution of using electric transmitted measuring systems.
② These Recommended Cutting Conditions indicate only the rule of a thumb for the cutting conditions.
In actual machining, the condition should be adjusted according to the machining shape, purpose and the machine type.
③ The cutting condition shown in the above table are based on short series. In case of a regular series, reduce the revolution and feed rate to about 70% in the above table.
④ If you use the condition for 5 flutes or more series, adjust the depth of cut (a_p) accordingly.
⑤ The long series are not suitable for slotting.

ATラフィング

湿式切削

Wet Cutting

※湿式での切削においても従来の粉末ハイスラフィング以上の性能が得られます。
Provides performance which exceeds conventional powdered HSS roughing end mills for wet cutting also.

RQS-AT

ショート刃長
Short

RQR-AT (注①)

レギュラー刃長
Regular

RQL-AT (注①)

ロング刃長
Long

寸法表 Size list : H52

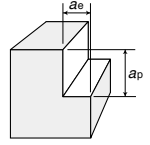

〈側面切削〉 Side Milling

被削材 (硬さ) Work material (Hardness)	条件域 Condition Range	切込み Depth of cut mm	切削条件 Cutting Conditions	外径DC Tool dia.(mm)									
				φ6	φ8	φ10	φ12	φ16	φ20	φ25	φ30	φ40	φ50
鋳鉄・炭素鋼 Cast irons, Carbon steels (200HB以下) FC200, SS400, S45C	汎用条件 General	ap=1.5DC	回転数 min ⁻¹	3,000	2,300	1,800	1,500	1,100	870	700	590	450	350
		ae=0.5DC以下	送り速度 mm/min	250	280	360	360	400	430	380	320	350	280
合金鋼 Alloy steels (200~250HB) SCM, SNCM	汎用条件 General	ap=1.5DC	回転数 min ⁻¹	2,500	1,800	1,400	1,100	900	710	570	470	400	300
		ae=0.5DC以下	送り速度 mm/min	220	240	280	280	330	350	290	260	280	230
工具鋼・ステンレス鋼 Tool steels, Stainless steels (25~35HRC) SKD, SKT, SUS304	汎用条件 General	ap=1.5DC	回転数 min ⁻¹	2,000	1,500	1,200	1,000	700	560	450	320	260	200
		ae=0.4DC以下	送り速度 mm/min	140	180	180	200	220	230	180	180	190	150
焼入れ鋼・プリハードン鋼 Hardened steels, Pre-hardened steels (35~45HRC) SKD, HPM1, NAK	汎用条件 General	ap=1.5DC	回転数 min ⁻¹	1,300	950	750	630	470	380	300	260	200	160
		ae=0.3DC以下	送り速度 mm/min	90	120	120	140	140	140	140	130	150	120
耐熱鋼・チタン合金 Heat-resistant steels, Titanium alloys Inconel Ti-6Al-4V	汎用条件 General	ap=1.5DC	回転数 min ⁻¹	1,100	850	670	550	430	340	270	230	180	140
		ae=0.3DC以下	送り速度 mm/min	90	95	90	90	85	85	95	85	60	40

- 【注意】** ①本工具のATコーティングはその性質上、通電性が微小です。従って、通電方式の工具長測定装置をご使用の際にはご注意ください。
②被削材、加工形状に合わせて、適切なクーラントを使用してください。
③この標準切削条件表は切削条件の目安を示すものです。実際の加工では加工形状、目的、使用機械等により条件を調整してください。
④上記条件はショート刃長の場合を示します。レギュラー刃長の場合は上記条件の回転数・送りを70%を目安にしてください。

- 【Note】** ①This product obtains less electric conductivity. Therefore, Please caution of using electric transmitted measuring systems.
②Use the appropriate coolant for the work material and machining shape.
③These Recommended Cutting Conditions indicate only the rule of a thumb for the cutting conditions. In actual machining, the condition should be adjusted according to the machining shape, purpose and the machine type.
④The cutting condition shown in the above table are based on short series. In case of a regular series, reduce the revolution and feed rate to about 70% in the above table. In case of long series, reduce the revolution and feed rate to about 50% in the above table.

RQS-AT

ショート刃長
Short

RQR-AT (注①)

レギュラー刃長
Regular

寸法表 Size list : H52

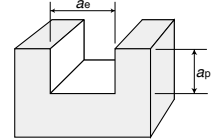

〈溝切削〉 Slotting

被削材 (硬さ) Work material (Hardness)	条件域 Condition Range	切込み Depth of cut mm	切削条件 Cutting Conditions	外径DC Tool dia.(mm)									
				φ6	φ8	φ10	φ12	φ16	φ20	φ25	φ30	φ40	φ50
鋳鉄・炭素鋼 Cast irons, Carbon steels (200HB以下) FC200, SS400, S45C	汎用条件 General	ap=1DC以下	回転数 min ⁻¹	2,900	2,200	1,750	1,400	1,100	800	640	530	420	350
		ae=1DC	送り速度 mm/min	210	250	280	280	310	340	240	210	240	200
合金鋼 Alloy steels (200~250HB) SCM, SNCM	汎用条件 General	ap=1DC以下	回転数 min ⁻¹	2,300	1,700	1,200	1,000	800	630	500	420	350	290
		ae=1DC	送り速度 mm/min	180	220	220	240	240	250	210	210	220	190
工具鋼・ステンレス鋼 Tool steels, Stainless steels (25~35HRC) SKD, SKT, SUS304	汎用条件 General	ap=1DC以下	回転数 min ⁻¹	1,500	1,200	950	800	600	470	380	300	240	180
		ae=1DC	送り速度 mm/min	120	150	150	170	170	170	170	160	170	140
焼入れ鋼・プリハードン鋼 Hardened steels, Pre-hardened steels (35~45HRC) SKD, HPM1, NAK	汎用条件 General	ap=1DC以下	回転数 min ⁻¹	1,300	950	750	630	470	380	300	260	200	160
		ae=1DC	送り速度 mm/min	70	80	90	90	100	110	90	90	100	80
耐熱鋼・チタン合金 Heat-resistant steels, Titanium alloy Inconel Ti-6Al-4V	汎用条件 General	ap=1DC以下	回転数 min ⁻¹	760	600	450	380	280	220	180	150	120	100
		ae=1DC	送り速度 mm/min	75	90	90	60	60	45	45	45	35	30

- 【注意】** ①本工具のATコーティングはその性質上、通電性が微小です。従って、通電方式の工具長測定装置をご使用の際にはご注意ください。
②この標準切削条件表は切削条件の目安を示すものです。実際の加工では加工形状、目的、使用機械等により条件を調整してください。
③上記条件はショート刃長の場合を示します。レギュラー刃長の場合は上記条件の回転数・送りを70%を目安にしてください。
④5枚刃以上でご使用になられる場合は、切り込み(ap)を調整してください。
⑤ロング刃は溝切削には適しません。

- 【Note】** ①This product obtains less electric conductivity. Therefore, Please caution of using electric transmitted measuring systems.
②These Recommended Cutting Conditions indicate only the rule of a thumb for the cutting conditions. In actual machining, the condition should be adjusted according to the machining shape, purpose and the machine type.
③The cutting condition shown in the above table are based on short series. In case of a regular series, reduce the revolution and feed rate to about 70% in the above table.
④If you use the condition for 5 flutes or more series, adjust the depth of cut (ap) accordingly.
⑤The long series are not suitable for slotting.

C Coating ESM Roughing End Mills

ESM-Cコートラフニングエンドミル

ショート刃長 Short



外径公差 Dia. tolerance
 $\phi 6 \sim \phi 12 : 0 \sim -0.05$
 $\phi 14 \sim \phi 50 : 0 \sim -0.1$



(mm)

レギュラー刃長 Regular

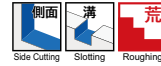

外径公差 Dia. tolerance
 $\phi 6 \sim \phi 12 : 0 \sim -0.05$
 $\phi 16 \sim \phi 30 : 0 \sim -0.1$



(mm)



ESMQS



商品コード Item code	在庫 Stock	寸法 Size (mm)				刃数 No. of Flutes	希望小売 価格(円) Suggested retail price(¥)
		外径 Tool dia.	刃長 Flute length	全長 Overall length	シャンク径 Shank dia.		
ESMQS6	●	6	15	80	6	4	12,200
ESMQS8	●	8	20	90	8	4	13,420
ESMQS10	●	10	25	100	10	4	14,990
ESMQS12	●	12	30	110	12	4	18,980
ESMQS14	●	14	30	110	12	4	22,280
ESMQS15	●	15	30	110	12	4	23,100
ESMQS16	●	16	35	125	16	4	24,480
ESMQS18	●	18	35	125	16	4	26,540
ESMQS20	●	20	40	140	20	4	30,250
ESMQS22	●	22	40	140	20	4	36,720
5ESMQS22	□	22	40	140	20	5	—
ESMQS25	●	25	45	160	25	4	43,730
5ESMQS25	□	25	45	160	25	5	—
ESMQS28	●	28	45	160	25	4	51,840
5ESMQS28	□	28	45	160	25	5	—
ESMQS30	●	30	45	160	25	4	65,180
6ESMQS30	□	30	45	160	25	6	—
ESMQS32	●	32	55	180	32	6	78,650
ESMQS35	●	35	55	180	32	6	93,370
ESMQS40	●	40	65	200	32	6	128,290
ESMQS45	●	45	65	200	42	6	151,250
ESMQS50	●	50	75	225	42	6	209,000

ESMQR



商品コード Item code	在庫 Stock	寸法 Size (mm)				刃数 No. of Flutes	希望小売 価格(円) Suggested retail price(¥)
		外径 Tool dia.	刃長 Flute length	全長 Overall length	シャンク径 Shank dia.		
ESMQR6	●	6	20	80	6	4	14,030
ESMQR8	●	8	25	90	8	4	15,400
ESMQR10	●	10	35	100	10	4	17,190
ESMQR12	●	12	40	110	12	4	21,590
ESMQR16	●	16	50	125	16	4	28,190
ESMQR20	●	20	55	140	20	4	33,830
ESMQR25	●	25	70	160	25	4	49,230
ESMQR30	●	30	80	160	25	4	68,340

ESMQS、ESMQRの対応被削材

Applicable work material of ESMQS, ESMQR

炭素鋼 合金鋼 Carbon steel Alloy steel	炭素鋼 合金鋼 Pre-hardened steel ≤ 45HRC	高硬度 Hardened steel			ステン レス鋼 Stainless steel	チタン合金 耐熱合金 Titanium alloy Heat-resistant alloy	銅合金 Copper alloy	アルミ 合金 Aluminum alloy
		> 45HRC ≤ 55HRC	> 55HRC ≤ 65HRC	> 65HRC				
○	○				○	○	○	

●印：標準在庫品です。 □印：特定代理店在庫です。弊社営業へお問合せください。
 ● : Stocked items. □ : Stocked by specified distributor. Contact with our sales department.

再研磨対応外径範囲

Re-grinding compatibility range

商品コード Item code	外周 Outer dia. (mm)	エンド End (mm)
ESMQS	6 ~ 50	6 ~ 50
ESMQR	6 ~ 30	6 ~ 30

C Coating ESM Roughing End Mills

ESM-Cコートラフニングエンドミル

ロング刃長 Long



外径公差 Dia. tolerance
 $\phi 10 \sim \phi 12 : 0 \sim -0.05$
 $\phi 14 \sim \phi 50 : 0 \sim -0.1$



(mm)



$\phi 30$ 以下 $\phi 40$ 以上

ロングシャンク Long Shank



外径公差 Dia. tolerance
 $\phi 12 : 0 \sim -0.05$
 $\phi 14 \sim \phi 50 : 0 \sim -0.1$



(mm)



$\phi 30$ 以下 (セントカット) Center cut
 $\phi 40$ 以上 (セント穴付き) Center eyed

ESMQL



商品コード Item code	在庫 Stock	寸法 Size (mm)				刃数 No. of Flutes	希望小売 価格(円) Suggested retail price(¥)
		外径 Tool dia.	刃長 Flute length	全長 Overall length	シャンク径 Shank dia.		
ESMQL10	●	10	45	100	10	4	19,390
ESMQL12	●	12	55	110	12	4	24,480
ESMQL14	●	14	55	110	12	4	29,840
ESMQL15	●	15	55	110	16	4	30,250
ESMQL16	●	16	65	125	16	4	30,670
ESMQL18	●	18	65	125	16	4	35,890
ESMQL20	●	20	75	140	20	4	37,820
ESMQL22	●	22	75	140	20	4	49,640
ESMQL25	●	25	90	165	25	4	54,730
ESMQL28	●	28	90	165	25	4	69,990
ESMQL30	●	30	90	165	25	4	81,540
ESMQL40	●	40	125	205	32	6	166,380
ESMQL50	●	50	150	255	42	6	270,880

ESMQLS



商品コード Item code	在庫 Stock	寸法 Size (mm)				刃数 No. of Flutes	希望小売 価格(円) Suggested retail price(¥)
		外径 Tool dia.	刃長 Flute length	全長 Overall length	シャンク径 Shank dia.		
ESMQLS12	●	12	30	150	10	4	18,980
ESMQLS14	●	14	35	150	12	4	22,280
ESMQLS16	●	16	40	150	12	4	24,480
ESMQLS18	●	18	40	180	16	4	26,540
ESMQLS20	●	20	45	200	16	4	30,250
ESMQLS22	●	22	45	225	20	4	36,720
ESMQLS25	●	25	50	225	20	4	43,730
ESMQLS28	●	28	50	250	25	4	51,840
ESMQLS30	●	30	55	250	25	4	65,180
ESMQLS40	●	40	65	300	32	6	128,290
ESMQLS50	●	50	70	320	42	6	209,000

ハイスエンドミル
スクエアエンドミル

ESMQL、ESMQLSの対応被削材

Applicable work material of ESMQL, ESMQLS

炭素鋼 合金鋼 Carbon steel Alloy steel	炭素鋼 合金鋼 Pre-hardened steel ≤ 45HRC	高硬度 Hardened steel			ステン レス鋼 Stainless steel	チタン合金 耐熱合金 Titanium alloy Heat-resistant alloy	銅合金 Copper alloy	アルミ 合金 Aluminum alloy
		> 45HRC ≤ 55HRC	> 55HRC ≤ 65HRC	> 65HRC				
○	○				○	○	○	

再研磨対応外径範囲

Re-grinding compatibility range

商品コード Item code	外周 Outer dia. (mm)	エンド End (mm)
ESMQL	10 ~ 50	10 ~ 50
ESMQLS	12 ~ 50	12 ~ 50

標準切削条件表 Recommended cutting conditions

ESMQS ショート刃長 Short	ESMQR (注①) レギュラー刃長 Regular	寸法表 Size list : H55	ESMQL (注①) ロング刃長 Long	ESMQLS (注①) ロングシャンク Long Shank	寸法表 Size list : H56
---------------------------------	---	---------------------	------------------------------------	---	---------------------

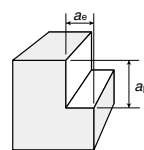

<側面切削> Side milling

被削材 (硬さ) Work material (Hardness)	条件域 Condition Range	切込み Depth of cut mm	切削条件 Cutting Conditions	外径 DC Tool dia. (mm)									
				φ6	φ8	φ10	φ12	φ16	φ20	φ25	φ30	φ40	φ50
鋳鉄・炭素鋼 Cast irons, Carbon steels (200HB以下) FC200 SS400, S45C	汎用条件 General	$a_p=1.5DC$ $a_e=0.5DC$ 以下	回転数 min ⁻¹	3,000	2,300	1,800	1,500	1,100	870	700	590	440	350
			送り速度 mm/min	250	280	360	360	400	430	380	320	350	280
合金鋼 Alloy steels (200~250HB) SCM, SNCM	汎用条件 General	$a_p=1.5DC$ $a_e=0.5DC$ 以下	回転数 min ⁻¹	2,300	1,700	1,400	1,100	900	710	570	470	350	290
			送り速度 mm/min	220	240	280	280	330	350	290	260	280	230
工具鋼・ステンレス鋼 Tool steels, Stainless steels (25~35HRC) SKD, SKT, SUS304	汎用条件 General	$a_p=1.5DC$ $a_e=0.5DC$ 以下	回転数 min ⁻¹	1,500	1,200	950	800	600	470	380	320	240	190
			送り速度 mm/min	140	180	180	200	220	230	180	180	190	150
焼入れ鋼・プリハードン鋼 Hardened steels, Pre-hardened steels (35~45HRC) SKD, SKT HPM1, NAK55	汎用条件 General	$a_p=1.5DC$ $a_e=0.5DC$ 以下	回転数 min ⁻¹	1,300	950	750	630	470	380	330	260	200	160
			送り速度 mm/min	90	120	120	140	140	140	140	130	150	120
耐熱鋼・チタン合金 Heat-resistant steels, Titanium alloys Inconel Ti-6Al-4V	汎用条件 General	$a_p=1.5DC$ $a_e=0.5DC$ 以下	回転数 min ⁻¹	760	600	450	380	280	220	180	150	120	110
			送り速度 mm/min	30	35	40	40	45	50	45	40	50	40

- [注意]** ①被削材、加工形状に合わせて、適切なクーラントを使用してください。
 ②この標準切削条件表は切削条件の目安を示すものです。実際の加工では加工形状、目的、使用機械等により条件を調整してください。
[Note] ③上記条件はショート刃長の場合を示します。レギュラー刃長の場合は上表条件の回転数・送りを70%、ロング刃長、ロングシャンクの場合は、50%を目安にしてください。
 ① Use the appropriate coolant for the work material and machining shape.
 ② These Recommended Cutting Conditions indicate only the rule of a thumb for the cutting conditions. In actual machining, the condition should be adjusted according to the machining shape, purpose and the machine type.
 ③ The cutting condition shown in the above table based on short series. In case of a regular series, reduce the rpm and feed rate to about 70% in the above table. In case of long and long shank series, reduce the revolution and feed rate to about 50% in the above table.

ESMQS ショート刃長 Short	ESMQR (注①) レギュラー刃長 Regular	寸法表 Size list : H55
---------------------------------	---	---------------------

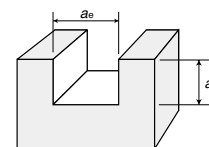

<溝切削> Slotting

被削材 (硬さ) Work material (Hardness)	条件域 Condition Range	切込み Depth of cut mm	切削条件 Cutting Conditions	外径 DC Tool dia. (mm)									
				φ6	φ8	φ10	φ12	φ16	φ20	φ25	φ30	φ40	φ50
鋳鉄・炭素鋼 Cast irons, Carbon steels (200HB以下) FC200 SS400, S45C	汎用条件 General	$a_p=1DC$ 以下 (MAX30mm) $a_e=1DC$	回転数 min ⁻¹	2,600	2,000	1,500	1,200	950	750	630	500	400	320
			送り速度 mm/min	210	250	280	280	310	340	240	210	240	200
合金鋼 Alloy steels (200~250HB) SCM, SNCM	汎用条件 General	$a_p=1DC$ 以下 (MAX30mm) $a_e=1DC$	回転数 min ⁻¹	2,100	1,500	1,200	1,100	780	620	480	410	320	250
			送り速度 mm/min	170	200	200	220	240	260	190	180	200	150
工具鋼・ステンレス鋼 Tool steels, Stainless steels (25~35HRC) SKD, SKT, SUS304	汎用条件 General	$a_p=1DC$ 以下 (MAX30mm) $a_e=1DC$	回転数 min ⁻¹	1,500	1,100	900	750	550	450	350	300	230	180
			送り速度 mm/min	100	140	140	140	160	170	140	140	140	110
焼入れ鋼・プリハードン鋼 Hardened steels, Pre-hardened steels (35~45HRC) SKD, SKT HPM1, NAK55	汎用条件 General	$a_p=1DC$ 以下 (MAX30mm) $a_e=1DC$	回転数 min ⁻¹	1,300	950	750	630	470	380	300	260	200	160
			送り速度 mm/min	70	80	90	90	100	110	90	90	100	80
耐熱鋼・チタン合金 Heat-resistant steels, Titanium alloys Inconel Ti-6Al-4V	汎用条件 General	$a_p=1DC$ 以下 (MAX30mm) $a_e=1DC$	回転数 min ⁻¹	760	600	450	380	280	220	180	150	120	100
			送り速度 mm/min	20	25	30	30	40	40	40	30	40	30

- [注意]** ①被削材、加工形状に合わせて、適切なクーラントを使用してください。
 ②この標準切削条件表は切削条件の目安を示すものです。実際の加工では加工形状、目的、使用機械等により条件を調整してください。
 ③上記条件はショート刃長の場合を示します。レギュラー刃長の場合は上表条件の回転数・送りの70%を目安にしてください。
 ④5枚刃以上でご利用になる場合は、切込み (ap) を調整してください。
 ⑤ロング刃長、ロングシャンクは溝切削には適しません。
[Note] ① Use the appropriate coolant for the work material and machining shape.
 ② These Recommended Cutting Conditions indicate only the rule of a thumb for the cutting conditions. In actual machining, the condition should be adjusted according to the machining shape, purpose and the machine type.
 ③ The cutting condition shown in the above table are based on short series. In case of a regular series, reduce the revolution and feed rate to about 70% in the above table.
 ④ If you use the condition for 5 flute or more series, adjust the depth of cut (ap) accordingly.
 ⑤ The long series and long shank are not suitable for slotting.

ATファインミル

ショート刃長 Short



外径公差 Dia. tolerance	φ6~φ12 : 0~-0.1	h6
	φ13~φ16 : 0~-0.15	
	φ17~φ35 : 0~-0.2	

(mm)



FQS[○]-AT



商品コード Item code	在庫 Stock	寸法 Size (mm)				刃数 No. of Flutes	希望小売 価格(円) Suggested retail price(¥)
		外径 Tool dia.	刃長 Flute length	全長 Overall length	シャンク径 Shank dia.		
FQS6-AT	●	6	15	80	6	3	10,990
FQS7-AT	●	7	20	90	8	3	11,970
FQS8-AT	●	8	20	90	8	3	11,970
FQS9-AT	●	9	25	100	10	3	13,170
FQS10-AT	●	10	25	100	10	3	13,170
FQS11-AT	●	11	30	110	12	3	16,230
FQS12-AT	●	12	30	110	12	3	16,230
FQS13-AT	●	13	30	110	12	3	18,570
FQS14-AT	●	14	30	110	12	3	18,570
FQS15-AT	●	15	30	110	16	3	19,940
FQS16-AT	●	16	35	125	16	3	20,900
FQS17-AT	●	17	35	125	16	3	22,690
FQS18-AT	●	18	35	125	16	3	22,690
FQS19-AT	●	19	40	140	16	3	25,030
FQS20-AT	●	20	40	140	20	3	25,030
FQS21-AT	●	21	40	140	20	3	30,800
FQS22-AT	●	22	40	140	20	3	30,800
FQS23-AT	●	23	45	160	20	3	34,520
FQS24-AT	●	24	45	160	20	3	34,520
FQS25-AT	●	25	45	160	25	4	34,790
FQS26-AT	●	26	45	160	25	4	38,090
FQS28-AT	●	28	45	160	25	4	43,450
FQS30-AT	●	30	45	160	25	4	50,470
FQS32-AT	●	32	55	180	32	4	64,080
FQS35-AT	●	35	55	180	32	4	69,850

レギュラー刃長 Regular

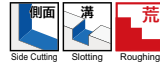

外径公差 Dia. tolerance	φ6~φ12 : 0~-0.1	h6
	φ13~φ16 : 0~-0.15	
	φ18~φ35 : 0~-0.2	

(mm)



FQR[○]-AT



商品コード Item code	在庫 Stock	寸法 Size (mm)				刃数 No. of Flutes	希望小売 価格(円) Suggested retail price(¥)
		外径 Tool dia.	刃長 Flute length	全長 Overall length	シャンク径 Shank dia.		
FQR6-AT	●	6	20	80	6	3	11,090
FQR7-AT	●	7	25	90	8	3	12,020
FQR8-AT	●	8	25	90	8	3	12,020
FQR9-AT	●	9	35	100	10	3	13,550
FQR10-AT	●	10	35	100	10	3	13,550
FQR11-AT	●	11	40	110	12	3	17,600
FQR12-AT	●	12	40	110	12	3	17,600
FQR13-AT	●	13	40	110	12	3	18,700
FQR14-AT	●	14	40	110	12	3	18,700
FQR15-AT	●	15	40	110	12	3	21,320
FQR16-AT	●	16	50	125	16	3	22,280
FQR18-AT	●	18	50	125	16	3	23,520
FQR20-AT	●	20	55	140	20	3	26,130
FQR22-AT	●	22	60	140	20	3	31,220
FQR24-AT	●	24	70	160	20	3	36,170
FQR25-AT	●	25	70	160	25	4	36,170
FQR26-AT	●	26	70	160	25	4	39,600
FQR30-AT	●	30	80	160	25	4	49,230
FQR35-AT	●	35	90	180	32	4	68,340

ハイスエンドミル
スクエアエンドミル

○ FQS-AT、FQR-ATの対応被削材

Applicable work material of ESMQL, ESMQLS

炭素鋼 合金鋼 Carbon steel Alloy steel	炭素鋼 合金鋼 Pre-hardened steel ≤ 45HRC	高硬度 Hardened steel			ステン レス鋼 Stainless steel	チタン合金 耐熱合金 Titanium alloy Heat-resistant alloy	銅合金 Copper alloy	アルミ 合金 Aluminum alloy
		> 45HRC ≤ 55HRC	> 55HRC ≤ 65HRC	> 65HRC				
○	○				○		○	

●印：標準在庫品です。●：Stoked items.

○ 再研磨対応外径範囲

Re-grinding compatibility range

商品コード Item code	外周 Outer dia. (mm)	エンド End (mm)
FQS-AT	6 ~ 35	6 ~ 35
FQR-AT	6 ~ 35	6 ~ 35

標準切削条件表 Recommended cutting conditions

寸法表 Size list : H58 FQS-AT ショート刃長 Short	寸法表 Size list : H58 FQR-AT (注③) レギュラー刃長 Regular	寸法表 Size list : H72 FQL-AT (注③) ロング刃長 Long
---	---	--

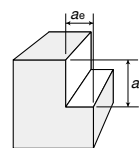

<側面切削> Side Milling

被削材(硬さ) Work material (Hardness)	切込み Depth of cut mm	切削条件 Cutting conditions	外径DC Tool dia.							
			φ6	φ8	φ10	φ12	φ16	φ20	φ25	φ30
鋳鉄・炭素鋼 Cast iron Carbon steels (~200HB) FC200,SS400,S45C	$a_p \leq 1.5DC$	回転数 Revolution	1800 (1600)	1500 (1300)	1400 (1300)	1100 (1000)	900 (700)	700 (600)	500 (400)	400 (350)
	$a_e=0.5DC$	送り速度 Feed rate	170 (150)	170 (150)	170 (150)	200 (180)	200 (180)	180 (160)	180 (160)	160 (140)
合金鋼 Alloy steels (200~250HB) SCM,SNM	$a_p \leq 1.5DC$	回転数 Revolution	1600 (1400)	1400 (1200)	1200 (1000)	900 (800)	700 (600)	600 (500)	400 (300)	300 (270)
	$a_e=0.5DC$	送り速度 Feed rate	160 (140)	160 (150)	150 (130)	140 (130)	140 (130)	130 (120)	120 (110)	120 (110)
工具鋼・ステンレス鋼 Tool steels Stainless steels (25~35HRC) SKD,SKT,SUS	$a_p \leq 1.5DC$	回転数 Revolution	1400 (1200)	1200 (1000)	1000 (850)	850 (750)	600 (550)	450 (370)	320 (280)	240 (210)
	$a_e=0.5DC$	送り速度 Feed rate	150 (140)	130 (110)	120 (100)	110 (100)	110 (100)	100 (90)	100 (90)	90 (80)
耐熱鋼・チタン合金 インコネル Heat resistant steels Ti-alloy, Inconel Ti-6Al-4V	$a_p \leq 1.5DC$	回転数 Revolution	(500)	(450)	(400)	(400)	(370)	(300)	(200)	(110)
	$a_e=0.5DC$	送り速度 Feed rate	(50)	(45)	(40)	(45)	(45)	(40)	(35)	(30)

- [注意]**
- ① 本工具のATコーティングはその性質上、通電性が微小です。従って、通電方式の工具長測定装置をご使用の際にはご注意ください。
 - ② 機械剛性によって、切込み量を調整してください。また、実際の加工では形状加工、目的、使用機械等により条件を調節してください。
 - ③ 枠内数値はエアブロー時の推奨条件です。かつこ内の数値は水溶性切削液使用時の推奨条件です。
 - ④ 上記表は、ショート刃長の時の条件です。レギュラー刃長及びロング刃長を使用の場合、回転数・送り速度共にそれぞれ80%、70%で加工されることを推奨致します。

- [Note]**
- ① This product obtains less electric conductivity. Therefore, Please caution of using electric transmitted measuring systems.
 - ② Please adjust cutting amount according to machine rigidity. In addition, conditions should be adjusted according to the shape machining, purpose, machine used, etc. of the actual process.
 - ③ The values outside of parentheses in the table above are the recommended conditions when an air blower is used. The values in parentheses are the recommended conditions when a water-soluble cutting agent is used.
 - ④ The above table lists the conditions for short flute lengths. For regular flute lengths or long flute lengths, it is recommended that cutting be performed with both revolutions and feed rates set to 80% and 70% respectively of the above values.

寸法表 Size list : H58 FQS-AT ショート刃長 Short	寸法表 Size list : H58 FQR-AT (注③) レギュラー刃長 Regular
---	---

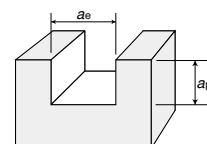

<溝切削> Slotting

被削材(硬さ) Work material (Hardness)	切込み Depth of cut mm	切削条件 Cutting conditions	外径DC Tool dia.							
			φ6	φ8	φ10	φ12	φ16	φ20	φ25	φ30
鋳鉄・炭素鋼 Cast iron Carbon steels (~200HB) FC200,SS400,S45C	$a_p \leq 1DC$	回転数 Revolution	1500 (1200)	1100 (1000)	1000 (900)	800 (720)	750 (620)	570 (500)	450 (370)	320 (270)
	$a_e=1DC$	送り速度 Feed rate	140 (120)	150 (130)	170 (150)	170 (150)	150 (130)	150 (130)	140 (120)	120 (100)
合金鋼 Alloy steels (200~250HB) SCM,SNM	$a_p \leq 1DC$	回転数 Revolution	1400 (1100)	900 (820)	820 (770)	780 (700)	600 (550)	520 (470)	400 (320)	280 (240)
	$a_e=1DC$	送り速度 Feed rate	120 (100)	120 (100)	110 (100)	110 (100)	120 (110)	120 (110)	120 (110)	110 (90)
工具鋼・ステンレス鋼 Tool steels Stainless steels (25~35HRC) SKD,SKT,SUS	$a_p \leq 1DC$	回転数 Revolution	1200 (1000)	820 (700)	560 (500)	500 (410)	470 (380)	440 (360)	300 (270)	260 (220)
	$a_e=1DC$	送り速度 Feed rate	90 (70)	85 (65)	75 (60)	75 (60)	75 (60)	75 (55)	75 (55)	60 (50)

- [注意]**
- ① 本工具のATコーティングはその性質上、通電性が微小です。従って、通電方式の工具長測定装置をご使用の際にはご注意ください。
 - ② 機械剛性によって、切込み量を調整してください。また、実際の加工では形状加工、目的、使用機械等により条件を調節してください。
 - ③ 枠内数値はエアブロー時の推奨条件です。かつこ内の数値は水溶性切削液使用時の推奨条件です。
 - ④ 上記表は、ショート刃長の時の条件です。レギュラー刃長を使用の場合、回転数・送り速度共に 60%で加工されることを推奨致します。
 - ⑤ ロング刃長は溝切削には適しません。

- [Note]**
- ① This product obtains less electric conductivity. Therefore, Please caution of using electric transmitted measuring systems.
 - ② Please adjust cutting amount according to machine rigidity. In addition, conditions should be adjusted according to the shape machining, purpose, machine used, etc. of the actual process.
 - ③ The values outside of parentheses in the table above are the recommended conditions when an air blower is used. The values in parentheses are the recommended conditions when a water-soluble cutting agent is used.
 - ④ The above table lists the conditions for short flute lengths. For regular flute lengths, it is recommended that cutting be performed with both revolutions and feed rates set to 60% of the above values.
 - ⑤ The long series are not suitable for slotting.

Super-Cut End Mill

スーパーカットエンドミル

ATコーティング・レギュラー刃長 AT Coating, Regular

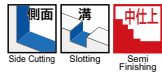

+0.04~0



(mm)



(センタカット)
Center cut



RFR[○]-AT



商品コード Item code	在庫 Stock	寸法 Size (mm)				刃数 No. of Flutes	希望小売 価格(円) Suggested retail price(¥)
		外径 Tool dia.	刃長 Flute length	全長 Overall length	シャンク径 Shank dia.		
RFR6-AT	●	6	15	60	6	4	7,380
RFR7-AT	●	7	20	70	8	4	7,690
RFR8-AT	●	8	20	70	8	4	7,950
RFR9-AT	●	9	25	80	10	4	9,030
RFR10-AT	●	10	25	80	10	4	9,040
RFR11-AT	●	11	30	95	12	4	10,440
RFR12-AT	●	12	30	95	12	4	11,400
RFR13-AT	●	13	35	105	16	4	13,000
RFR14-AT	●	14	35	105	16	4	14,300
RFR15-AT	●	15	40	110	16	4	15,680
RFR16-AT	●	16	40	110	16	4	16,780
RFR18-AT	●	18	40	120	20	4	18,700
RFR20-AT	●	20	45	125	20	4	20,220
RFR22-AT	●	22	45	135	25	4	23,650
RFR25-AT	●	25	50	140	25	4	28,600
RFR30-AT	●	30	55	145	25	4	41,800

ハイスエンドミル
スクエアエンドミル

○ 対応被削材 Applicable work material

炭素鋼 合金鋼 Carbon steel Alloy steel	炭素鋼 合金鋼 Pre-hardened steel ≤ 45HRC	高硬度 Hardened steel			ステン レス鋼 Stainless steel	チタン合金 耐熱合金 Titanium alloy Heat-resistant alloy	銅合金 Copper alloy	アルミ 合金 Aluminum alloy
		> 45HRC ≤ 55HRC	> 55HRC ≤ 65HRC	> 65HRC				
○	○				○		○	

●印：標準在庫品です。 ●：Stoked items.

○ 再研磨対応外径範囲 Re-grinding compatibility range

商品コード Item code	外周 Outer dia. (mm)	エンド End (mm)
RFR-AT	6 ~ 30	6 ~ 30

H60

標準切削条件表 Recommended cutting conditions

寸法表 Size list : H60

RFR-AT

レギュラー刃長

Regular

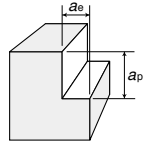

<側面切削> Side Milling

被削材 (硬さ) Work material (Hardness)	切込み Depth of cut mm	切削条件 Cutting conditions	外径DC Tool dia.							
			φ6	φ8	φ10	φ12	φ16	φ20	φ25	φ30
鋳鉄・炭素鋼 Cast iron Carbon steels (~200HB) FC200,SS400,S45C	$a_p \leq 1.5DC$	回転数 Revolution	1700 (1500)	1500 (1300)	1350 (1200)	1150 (1080)	880 (670)	650 (600)	480 (380)	400 (350)
	$a_e = 0.5DC$	送り速度 Feed rate	160 (140)	150 (145)	165 (150)	185 (170)	170 (165)	170 (160)	175 (155)	160 (140)
合金鋼 Alloy steels (200~250HB) SCM,SNCM	$a_p \leq 1.5DC$	回転数 Revolution	1550 (1450)	1350 (1100)	1150 (980)	900 (800)	700 (600)	580 (490)	400 (300)	280 (260)
	$a_e = 0.5DC$	送り速度 Feed rate	150 (135)	145 (135)	150 (130)	150 (130)	140 (130)	130 (120)	125 (105)	120 (100)
工具鋼・ステンレス鋼 Tool steels Stainless steels (25~35HRC) SKD,SKT,SUS	$a_p \leq 1.5DC$	回転数 Revolution	1200 (1100)	1150 (1050)	1000 (850)	850 (750)	580 (520)	420 (350)	320 (280)	240 (210)
	$a_e = 0.5DC$	送り速度 Feed rate	100 (85)	115 (100)	120 (100)	110 (100)	105 (95)	100 (90)	100 (90)	90 (80)
耐熱鋼・チタン合金 インコネル Heat resistant steels Ti-alloy, Inconel Ti-6Al-4V	$a_p \leq 1.5DC$	回転数 Revolution	(480)	(420)	(380)	(350)	(300)	(250)	(220)	(160)
	$a_e = 0.4DC$	送り速度 Feed rate	(40)	(42)	(37)	(37)	(40)	(40)	(35)	(30)

- [注意]** ①本工具のATコーティングはその性質上、通電性が微小です。従って、通電方式の工具長測定装置をご使用の際にはご注意ください。
 ②機械剛性によって、切込み量を調整してください。また、実際の加工では形状加工、目的、使用機械等により条件を調節してください。
 ③枠内数値はエアブロー時の推奨条件です。かつこ内の数値は水溶性切削液使用時の推奨条件です。

- [Note]** ①This product obtains less electric conductivity. Therefore, Please caution of using electric transmitted measuring systems.
 ②Please adjust cutting amount according to machine rigidity. In addition, conditions should be adjusted according to the shape machining, purpose, machine used, etc. of the actual process.
 ③The values outside of parentheses in the table above are the recommended conditions when an air blower is used. The values in parentheses are the recommended conditions when a water-soluble cutting agent is used.

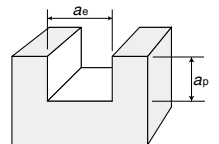

<溝切削> Slotting

被削材 (硬さ) Work material (Hardness)	切込み Depth of cut mm	切削条件 Cutting conditions	外径DC Tool dia.							
			φ6	φ8	φ10	φ12	φ16	φ20	φ25	φ30
鋳鉄・炭素鋼 Cast iron Carbon steels (~200HB) FC200,SS400,S45C	$a_p \leq 1DC$	回転数 Revolution	1400 (1150)	1050 (950)	1000 (900)	780 (700)	700 (600)	550 (460)	420 (340)	270 (220)
	$a_e = 1DC$	送り速度 Feed rate	135 (110)	140 (125)	160 (145)	160 (145)	145 (125)	140 (125)	135 (110)	110 (90)
合金鋼 Alloy steels (200~250HB) SCM,SNCM	$a_p \leq 1DC$	回転数 Revolution	1200 (1000)	850 (780)	780 (700)	760 (680)	550 (510)	470 (420)	400 (320)	250 (220)
	$a_e = 1DC$	送り速度 Feed rate	100 (90)	110 (95)	105 (90)	105 (90)	100 (85)	100 (85)	100 (85)	90 (80)
工具鋼・ステンレス鋼 Tool steels Stainless steels (25~35HRC) SKD,SKT,SUS	$a_p \leq 1DC$	回転数 Revolution	1000 (950)	800 (680)	560 (500)	500 (410)	470 (380)	440 (360)	300 (270)	260 (220)
	$a_e = 1DC$	送り速度 Feed rate	90 (70)	85 (65)	75 (60)	75 (60)	75 (60)	75 (55)	75 (55)	60 (50)

- [注意]** ①本工具のATコーティングはその性質上、通電性が微小です。従って、通電方式の工具長測定装置をご使用の際にはご注意ください。
 ②機械剛性によって、切込み量を調整してください。また、実際の加工では形状加工、目的、使用機械等により条件を調節してください。
 ③枠内数値はエアブロー時の推奨条件です。かつこ内の数値は水溶性切削液使用時の推奨条件です。

- [Note]** ①This product obtains less electric conductivity. Therefore, Please caution of using electric transmitted measuring systems.
 ②Please adjust cutting amount according to machine rigidity. In addition, conditions should be adjusted according to the shape machining, purpose, machine used, etc. of the actual process.
 ③The values outside of parentheses in the table above are the recommended conditions when an air blower is used. The values in parentheses are the recommended conditions when a water-soluble cutting agent is used.

Super-Cut End Mill

スーパーカットエンドミル

レギュラー刃長 Regular

Regular



外径公差 $+0.04 \sim 0$



(mm)

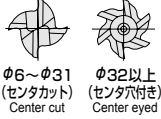

ロング刃長 Long

Long

外径公差 $+0.04 \sim 0$



(mm)

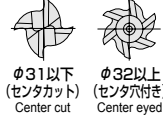

RFR



商品コード Item code	在庫 Stock	寸法 Size (mm)				刃数 No. of Flutes	希望小売 価格(円) Suggested retail price(¥)
		外径 Tool dia.	刃長 Flute length	全長 Overall length	シャンク径 Shank dia.		
RFR6	●	6	15	60	6	4	4,940
RFR7	●	7	20	70	8	4	5,090
RFR8	●	8	20	70	8	4	5,300
RFR9	●	9	25	80	10	4	5,600
RFR10	●	10	25	80	10	4	6,040
RFR11	●	11	30	95	12	4	6,930
RFR12	●	12	30	95	12	4	7,590
RFR13	●	13	35	105	16	4	8,650
RFR14	●	14	35	105	16	4	9,580
RFR15	●	15	40	110	16	4	10,530
RFR16	●	16	40	110	16	4	11,220
RFR17	□	17	40	120	20	4	—
RFR18	●	18	40	120	20	4	12,580
RFR19	□	19	45	125	20	4	—
RFR20	●	20	45	125	20	4	13,590
RFR21	□	21	45	135	25	4	—
RFR22	●	22	45	135	25	4	16,500
RFR23	□	23	50	140	25	4	—
RFR24	□	24	50	140	25	4	—
RFR25	●	25	50	140	25	4	19,800
RFR26	□	26	50	140	25	4	—
RFR27	□	27	55	145	25	4	—
RFR28	□	28	55	145	25	4	—
RFR29	□	29	55	145	25	4	—
RFR30	●	30	55	145	25	4	29,150
RFR31	□	31	60	160	32	4	—
RFR32	□	32	60	160	32	6	—
RFR33	□	33	60	160	32	6	—
RFR34	□	34	60	160	32	6	—
RFR35	□	35	60	160	32	6	—
RFR36	□	36	60	160	32	6	—
RFR37	□	37	60	160	32	6	—
RFR38	□	38	65	165	32	6	—
RFR39	□	39	65	165	32	6	—
RFR40	□	40	65	165	32	6	—
RFR42	□	42	65	175	42	6	—
RFR44	□	44	70	180	42	6	—
RFR45	□	45	70	180	42	6	—
RFR46	□	46	70	180	42	6	—
RFR48	□	48	70	180	42	6	—
RFR50	□	50	70	180	42	6	—

RFL



商品コード Item code	在庫 Stock	寸法 Size (mm)				刃数 No. of Flutes	希望小売 価格(円) Suggested retail price(¥)
		外径 Tool dia.	刃長 Flute length	全長 Overall length	シャンク径 Shank dia.		
RFL6	●	6	25	70	6	4	5,780
RFL7	□	7	35	85	8	4	—
RFL8	●	8	35	85	8	4	6,140
RFL9	□	9	45	100	10	4	—
RFL10	●	10	45	100	10	4	7,020
RFL11	□	11	55	120	12	4	—
RFL12	●	12	55	120	12	4	8,930
RFL13	□	13	55	125	16	4	—
RFL14	●	14	55	125	16	4	11,300
RFL15	□	15	65	135	16	4	—
RFL16	●	16	65	135	16	4	13,320
RFL17	□	17	65	145	20	4	—
RFL18	●	18	65	145	20	4	16,230
RFL19	□	19	75	155	20	4	—
RFL20	●	20	75	155	20	4	18,700
RFL21	□	21	75	165	25	4	—
RFL22	□	22	75	165	25	4	—
RFL23	□	23	90	180	25	4	—
RFL24	□	24	90	180	25	4	—
RFL25	●	25	90	180	25	4	27,230
RFL26	□	26	90	180	25	4	—
RFL27	□	27	90	180	25	4	—
RFL28	□	28	90	180	25	4	—
RFL29	□	29	90	180	25	4	—
RFL30	●	30	90	180	25	4	36,170
RFL31	□	31	95	195	32	4	—
RFL32	□	32	95	195	32	6	—
RFL33	□	33	95	195	32	6	—
RFL34	□	34	95	195	32	6	—
RFL35	□	35	100	200	32	6	—
RFL36	□	36	100	200	32	6	—
RFL37	□	37	100	200	32	6	—
RFL38	□	38	105	205	32	6	—
RFL39	□	39	110	210	32	6	—
RFL40	□	40	110	210	32	6	—
RFL42	□	42	110	220	42	6	—
RFL44	□	44	115	225	42	6	—
RFL45	□	45	115	225	42	6	—
RFL46	□	46	115	225	42	6	—
RFL48	□	48	120	230	42	6	—
RFL50	□	50	120	230	42	6	—

ハイエンドミル
スクエアエンドミル

RFR, RFLの対応被削材 Applicable work material of RFR, RFL

炭素鋼 合金鋼 Carbon steel Alloy steel	炭素鋼 合金鋼 Pre-hardened steel ≤ 45HRC	高硬度 Hardened steel			ステン レス鋼 Stainless steel	チタン合金 耐熱合金 Titanium alloy Heat-resistant alloy	銅合金 Copper alloy	アルミ 合金 Aluminum alloy
		> 45HRC ≤ 55HRC	> 55HRC ≤ 65HRC	> 65HRC				
○	○	○	○	○	○	○	○	

●印：標準在庫品です。●：Stoked items。□印：特定代理店在庫です。弊社営業へお問い合わせください。□：Stocked by specified distributor. Contact with our sales department.

再研磨対応外径範囲 Re-grinding compatibility range

商品コード Item code	外周 Outer dia. (mm)	エンド End (mm)
RFR	6 ~ 50	6 ~ 50
RFL	6 ~ 50	6 ~ 50

Roughing End Mills

ラフィングエンドミル

ショート刃長

Short



外径公差 Dia. tolerance
 $\phi 6 \sim \phi 12 : 0 \sim -0.1$
 $\phi 13 \sim \phi 16 : 0 \sim -0.15$
 $\phi 17 \sim \phi 50 : 0 \sim -0.2$



(mm)



レギュラー刃長

Regular



外径公差 Dia. tolerance
 $\phi 6 \sim \phi 12 : 0 \sim -0.1$
 $\phi 13 \sim \phi 16 : 0 \sim -0.15$
 $\phi 17 \sim \phi 50 : 0 \sim -0.2$



(mm)



HQS

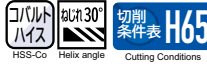

商品コード Item code	在庫 Stock	寸法 Size (mm)				刃数 No. of Flutes	希望小売 価格(円) Suggested retail price(¥)
		外径 Tool dia.	刃長 Flute length	全長 Overall length	シャンク径 Shank dia.		
HQS6	●	6	15	80	6	4	5,840
HQS7	●	7	20	90	8	4	6,370
HQS8	●	8	20	90	8	4	6,370
HQS9	●	9	25	100	10	4	7,150
HQS10	●	10	25	100	10	4	7,150
HQS11	●	11	30	110	12	4	8,940
HQS12	●	12	30	110	12	4	8,940
HQS13	●	13	30	110	12	4	9,940
HQS14	●	14	30	110	12	4	9,940
HQS15	●	15	30	110	12	4	10,440
HQS16	●	16	35	125	16	4	11,030
HQS17	●	17	35	125	16	4	12,280
HQS18	●	18	35	125	16	4	12,280
HQS19	●	19	40	140	16	4	13,100
HQS20	●	20	40	140	20	4	13,100
HQS21	●	21	40	140	20	4	16,090
HQS22	●	22	40	140	20	5	16,090
HQS23	●	23	45	160	20	5	17,600
HQS24	●	24	45	160	25	5	19,530
HQS25	●	25	45	160	25	5	19,530
HQS26	●	26	45	160	25	5	21,180
HQS28	●	28	45	160	25	5	22,970
HQS30	●	30	45	160	25	6	29,150
HQS32	●	32	55	180	32	6	33,420
HQS35	●	35	55	180	32	6	39,880
HQS40	●	40	65	200	32	6	54,590
HQS50	●	50	75	225	42	6	86,490

HQR

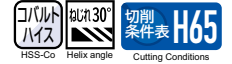

商品コード Item code	在庫 Stock	寸法 Size (mm)				刃数 No. of Flutes	希望小売 価格(円) Suggested retail price(¥)
		外径 Tool dia.	刃長 Flute length	全長 Overall length	シャンク径 Shank dia.		
HQR6	●	6	20	80	6	4	6,790
HQR7	●	7	25	90	8	4	7,400
HQR8	●	8	25	90	8	4	7,400
HQR9	●	9	35	100	10	4	8,320
HQR10	●	10	35	100	10	4	8,320
HQR11	●	11	40	110	12	4	10,770
HQR12	●	12	40	110	12	4	10,770
HQR13	●	13	40	110	12	4	11,520
HQR14	●	14	40	110	12	4	11,520
HQR15	●	15	40	110	12	4	12,890
HQR16	●	16	50	125	16	4	13,570
HQR17	●	17	50	125	16	4	14,300
HQR18	●	18	50	125	16	4	14,300
HQR19	●	19	55	140	16	4	16,090
HQR20	●	20	55	140	20	4	16,090
HQR21	●	21	55	140	20	4	19,800
HQR22	●	22	55	140	20	5	19,800
HQR23	●	23	70	160	20	5	21,320
HQR24	●	24	70	160	25	5	23,240
HQR25	●	25	70	160	25	5	23,240
HQR26	●	26	70	160	25	5	25,300
HQR28	●	28	75	160	25	5	27,230
HQR30	●	30	80	160	25	6	31,490
HQR32	●	32	80	180	32	6	39,190
HQR35	●	35	90	180	32	6	43,870
HQR40	●	40	100	200	32	6	61,600
HQR45	●	45	110	200	42	6	82,780
HQR50	●	50	120	225	42	6	100,240

○ HQS、HQRの対応被削材

Applicable work material of HQS, HQR

炭素鋼 合金鋼 Carbon steel Alloy steel	炭素鋼 合金鋼 Pre-hardened steel ≤ 45HRC	高硬度 Hardened steel			ステン レス鋼 Stainless steel	チタン合金 耐熱合金 Titanium alloy Heat-resistant alloy	銅合金 Copper alloy	アルミ 合金 Aluminum alloy
		> 45HRC ≤ 55HRC	> 55HRC ≤ 65HRC	> 65HRC				
○					○		○	

○ 再研磨対応外径範囲

Re-grinding compatibility range

商品コード Item code	外周 Outer dia. (mm)	エンド End (mm)
HQS	6 ~ 50	6 ~ 50
HQR	6 ~ 50	6 ~ 50

HSS End Mills

Square End Mills

Roughing End Mills

ラフィングエンドミル

ロング刃長

Long



外径公差 Dia. tolerance
 $\phi 10 \sim \phi 12$: 0 ~ -0.1
 $\phi 14 \sim \phi 16$: 0 ~ -0.15
 $\phi 18 \sim \phi 50$: 0 ~ -0.2



(mm)

エキストラロング刃長

Extra Long



外径公差 Dia. tolerance
 0 ~ -0.2



(mm)



$\phi 20$ 以下 $\phi 22 \sim 28$ $\phi 30$ 以上
 (センタ穴付き Center eyes)



$\phi 20$ $\phi 25$ $\phi 30$ 以上
 (センタ穴付き Center eyes)

HQL

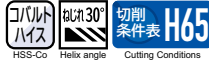

HQXL (×○○○)

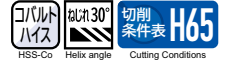

商品コード Item code	在庫 Stock	寸法 Size (mm)				刃数 No. of Flutes	希望小売 価格(円) Suggested retail price(¥)
		外径 Tool dia.	刃長 Flute length	全長 Overall length	シャンク径 Shank dia.		
HQL10	●	10	45	100	10	4	9,190
HQL12	●	12	55	110	12	4	11,990
HQL14	●	14	55	110	12	4	12,790
HQL15	●	15	55	110	12	4	14,300
HQL16	●	16	65	125	16	4	15,130
HQL18	●	18	65	125	16	4	15,950
HQL20	●	20	75	140	20	4	17,880
HQL22	●	22	75	140	20	5	22,140
HQL25	●	25	90	165	25	5	25,990
HQL28	●	28	90	165	25	5	30,250
HQL30	●	30	90	165	25	6	35,200
HQL32	●	32	110	190	32	6	43,180
HQL35	●	35	110	190	32	6	52,250
HQL40	●	40	125	205	32	6	72,880
HQL45	●	45	125	230	42	6	98,040
HQL50	●	50	150	255	42	6	119,220

商品コード Item code	在庫 Stock	寸法 Size (mm)				刃数 No. of Flutes	希望小売 価格(円) Suggested retail price(¥)
		外径 Tool dia.	刃長 Flute length	全長 Overall length	シャンク径 Shank dia.		
HQXL20	●	20	100	180	20	4	32,590
HQXL25X125	●	25	125	215	25	5	40,290
HQXL25X150	●	25	150	240	25	5	47,030
HQXL30X125	●	30	125	215	25	6	45,930
HQXL30X150	●	30	150	240	25	6	55,280
HQXL35X125	●	35	125	225	32	6	66,280
HQXL35X150	●	35	150	250	32	6	81,130
HQXL40	●	40	180	280	32	6	113,030
HQXL45	●	45	180	290	42	6	143,000
HQXL50	●	50	205	315	42	6	180,130

ロングシャンク

Long Shank



外径公差 Dia. tolerance
 $\phi 12$: 0 ~ -0.1
 $\phi 14 \sim \phi 16$: 0 ~ -0.15
 $\phi 18 \sim \phi 50$: 0 ~ -0.2



(mm)



$\phi 20$ 以下 $\phi 22 \sim 28$ $\phi 30$ 以上
 (センタカット Center cut)

HQLS

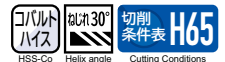

商品コード Item code	在庫 Stock	寸法 Size (mm)				刃数 No. of Flutes	希望小売 価格(円) Suggested retail price(¥)
		外径 Tool dia.	刃長 Flute length	全長 Overall length	シャンク径 Shank dia.		
HQLS12	●	12	30	150	10	4	11,800
HQLS14	●	14	30	150	12	4	13,100
HQLS16	●	16	30	150	12	4	15,540
HQLS18	●	18	35	180	16	4	16,920
HQLS20	●	20	40	200	16	4	22,140
HQLS22	●	22	40	225	20	5	23,520
HQLS25	●	25	45	225	20	5	29,150
HQLS28	●	28	45	250	25	5	33,830
HQLS30	●	30	45	250	25	6	37,680
HQLS40	●	40	65	300	32	6	76,450
HQLS50	●	50	75	320	42	6	114,820

ハイスエンドミル
スクエアエンドミル

○ HQL、HQXL、HQLSの対応被削材

Applicable work material of HQL, HQXL, HQLS

炭素鋼 合金鋼 Carbon steel Alloy steel	炭素鋼 合金鋼 Pre-hardened steel ≤ 45HRC	高硬度 Hardened steel			ステン レス鋼 Stainless steel	チタン合金 耐熱合金 Titanium alloy Heat-resistant alloy	銅合金 Copper alloy	アルミ 合金 Aluminum alloy
		> 45HRC ≤ 55HRC	> 55HRC ≤ 65HRC	> 65HRC				
○					○		○	

●印：標準在庫品です。●：Stoked items.

○ 再研磨対応外径範囲

Re-grinding compatibility range

商品コード Item code	外周 Outer dia. (mm)	エンド End (mm)
HQL	10 ~ 50	10 ~ 50
HQXL	20 ~ 50	20 ~ 50
HQLS	12 ~ 50	12 ~ 50

標準切削条件表 Recommended cutting conditions

寸法表 Size list : H63 寸法表 Size list : H63 寸法表 Size list : H64 寸法表 Size list : H64 寸法表 Size list : H64

HQS ショート刃長 Short	HQR (注②) レギュラー刃長 Regular	HQL (注②) ロング刃長 Long	HQXL (注②) エキストラロング刃長 Extra Long	HQLS (注③) ロングシャンク Long Shank
-------------------------------	---------------------------------------	----------------------------------	--	---

DC ≤ φ 40 : $a_p=1.6DC$
DC > φ 40 : $a_p=1.4DC$
 $a_e = 0.5DC$

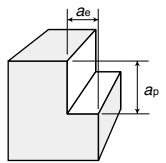

<側面切削> Side milling

被削材 (硬さ) Work material (Hardness)	条件域 Condition Range	切込み Depth of cut mm	切削条件 Cutting Conditions	外径 DC Tool dia. (mm)										
				φ 6	φ 8	φ 10	φ 12	φ 15	φ 20	φ 25	φ 30	φ 40	φ 50	
鑄鉄・炭素鋼 Cast irons, Carbon steels (~200HB) FC200, S50C, SS41	汎用条件 General	右上表 参照	回転数 min ⁻¹	1,200	880	700	500	460	350	280	230	170	140	
			送り速度 mm/min	100	100	100	100	110	100	80	90	80	80	
合金鋼 Alloy steels (200~250HB) SCM, SNCM, SNC	汎用条件 General	右上表 参照	回転数 min ⁻¹	950	710	570	480	380	280	230	190	140	110	
			送り速度 mm/min	80	70	70	70	70	60	55	55	50	50	
工具鋼・ステンレス鋼 Tool steels, Stainless steels (25~35HRC) SKD, SKT, SUS304	汎用条件 General	右上表 参照	回転数 min ⁻¹	850	640	510	420	340	250	200	170	130	100	
			送り速度 mm/min	50	55	60	60	60	50	45	50	45	45	
焼入れ鋼・プリハードン鋼 Hardened steels, Pre-hardened steels (35~45HRC) SKD, SKT, HPM1, NAK80	汎用条件 General	右上表 参照	回転数 min ⁻¹	530	400	320	260	210	160	130	110	80	65	
			送り速度 mm/min	30	35	30	30	35	30	30	30	25	30	
超耐熱合金・チタン合金 Super heat-resistant alloys Titanium alloys Ti-6Al-4V	汎用条件 General	右上表 参照	回転数 min ⁻¹	-	200	160	130	110	80	65	55	40	30	
			送り速度 mm/min	-	18	20	20	20	14	14	30	14	10	
アルミニウム・アルミ合金 Aluminium Aluminum alloys	汎用条件 General	右上表 参照	回転数 min ⁻¹	4,200	3,100	2,500	2,100	1,600	1,200	1,000	850	640	500	
			送り速度 mm/min	120	150	150	160	140	140	150	160	170	140	

- [注意]**
- ① 被削材、加工形状に合わせて、適切なクーラントを使用してください。
 - ② この標準切削条件表は切削条件の目安を示すものです。実際の加工では加工形状、目的、使用機械等により条件を調整してください。
 - ③ 上記の切削条件はショート刃の場合を示します。
 - ④ レギュラー刃の場合は回転数と送り速度を約70%に、ロング刃の場合は約50%以下に、エキストラロング刃の場合は約30%以下にしてください。
 - ⑤ ロングシャンクの場合は突出し量によりますが、回転数と送り速度を50%以下を目安に設定してください。

- [Note]**
- ① Use the appropriate coolant for the work material and machining shape.
 - ② These Recommended Cutting Conditions indicate only the rule of a thumb for the cutting conditions. In actual machining, the condition should be adjusted according to the machining shape, purpose and the machine type.
 - ③ The table shows starting cutting conditions based on short length.
 - ④ Please reduce the revolution speed and the feed speed to 70% in Regular length, 50% in long length and 30% in extra long length.
 - ⑤ For long-shank, although it depends on the length of shank sticking out, in general the revolution speed and feed speed should be reduced to 50% or less of the above values.

HQS ショート刃長 Short	HQR (注②) レギュラー刃長 Regular	寸法表 Size list : H63
-------------------------------	---------------------------------------	---------------------

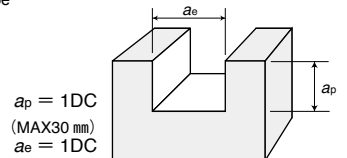

<溝切削> Slotting

被削材 (硬さ) Work material (Hardness)	条件域 Condition Range	切込み Depth of cut mm	切削条件 Cutting Conditions	外径 DC Tool dia. (mm)										
				φ 6	φ 8	φ 10	φ 12	φ 15	φ 20	φ 25	φ 30	φ 40	φ 50	
鑄鉄・炭素鋼 Cast irons, Carbon steels (~200HB) FC200, S50C, SS41	汎用条件 General	右上表 参照	回転数 min ⁻¹	1,000	800	630	530	420	320	250	210	160	120	
			送り速度 mm/min	70	70	70	70	70	70	60	60	60	50	
合金鋼 Alloy steels (200~250HB) SCM, SNCM, SNC	汎用条件 General	右上表 参照	回転数 min ⁻¹	850	640	510	420	340	250	200	170	130	100	
			送り速度 mm/min	60	50	50	50	50	45	40	40	40	35	
工具鋼・ステンレス鋼 Tool steels, Stainless steels (25~35HRC) SKD, SKT, SUS304	汎用条件 General	右上表 参照	回転数 min ⁻¹	640	480	380	320	250	190	150	130	95	76	
			送り速度 mm/min	30	35	35	35	35	30	25	30	25	25	
焼入れ鋼・プリハードン鋼 Hardened steels, Pre-hardened steels (35~45HRC) SKD, SKT, HPM1, NAK80	汎用条件 General	右上表 参照	回転数 min ⁻¹	420	320	250	210	170	130	100	85	65	50	
			送り速度 mm/min	20	20	20	25	25	20	20	20	18	18	
超耐熱合金・チタン合金 インコネル Super heat-resistant alloys Titanium alloys, Inconel Ti-6Al-4V	汎用条件 General	右上表 参照	回転数 min ⁻¹	-	160	130	110	85	65	50	40	30	25	
			送り速度 mm/min	-	12	12	12	12	10	8	10	8	6	
アルミニウム・アルミ合金 Aluminium Aluminum alloys	汎用条件 General	右上表 参照	回転数 min ⁻¹	3,200	2,400	1,900	1,600	1,300	960	760	640	480	380	
			送り速度 mm/min	100	110	110	120	110	110	110	120	120	100	

- [注意]**
- ① 被削材、加工形状に合わせて、適切なクーラントを使用してください。
 - ② この標準切削条件表は切削条件の目安を示すものです。実際の加工では加工形状、目的、使用機械等により条件を調整してください。
 - ③ 上記の切削条件はショート刃の場合を示します。
 - ④ レギュラー刃の場合は回転数と送り速度を約70%にしてください。
 - ⑤ ロング刃、エキストラロング刃は溝切削に適しません。
- [Note]**
- ① Use the appropriate coolant for the work material and machining shape.
 - ② These Recommended Cutting Conditions indicate only the rule of a thumb for the cutting conditions. In actual machining, the condition should be adjusted according to the machining shape, purpose and the machine type.
 - ③ The table shows starting cutting conditions based on short length.
 - ④ Please reduce the revolution speed and the feed speed to 70% in Regular length.
 - ⑤ Long length and Extra Long length are not recommended for slotting.

Chamfering Mills

面取り用 エンドミル

センタ面取りミル

Center Chamfering Mill



0 ~ -0.03



(mm)



CM



商品コード Item code	在庫 Stock	寸法 Size (mm)					希望小売 価格(円) Suggested retail price(¥)
		外径 Tool dia.	フラット幅 Flat Width	刃長 Flute length	全長 Overall length	シャンク径 Shank dia.	
CM4	●	4	0.44	11	75	8	6,530
CM6	●	6	0.55	13	85	10	7,590
CM8	●	8	0.66	19	105	12	9,040
CM10	●	10	0.77	22	120	16	9,790
CM12	●	12	0.88	26	125	16	15,400
CM16	●	16	1.1	32	145	20	22,970
CM20	●	20	1.32	38	165	25	26,820
CM25	●	25	1.43	45	170	32	32,180
CM30	□	30	1.65	50	180	32	—
CM35	□	35	1.98	55	180	32	—
CM40	□	40	1.98	60	200	42	—
CM45	□	45	2.2	65	200	42	—
CM50	□	50	2.2	65	200	42	—

面取りカッタ

Chamfering Cutter



φ30以下
Under φ30

(mm)



CE



商品コード Item code	在庫 Stock	寸法 Size (mm)				希望小売 価格(円) Suggested retail price(¥)
		外径 Tool dia.	加工径 Under dia.	全長 Overall length	シャンク径 Shank dia.	
CE4	●	4	2.5 ~ 3	50	4	2,420
CE6	●	6	3 ~ 5	50	6	2,420
CE10	●	10	5 ~ 9	55	8	3,030
CE15	●	15	7 ~ 14	70	10	4,130
CE20	●	20	10 ~ 19	100	12	6,240
CE30	●	30	15 ~ 28	120	12	13,200
CE40	●	40	20 ~ 38	170	MT3	30,250
CE50	●	50	25 ~ 48	180	MT3	45,380
CE60	●	60	30 ~ 58	195	MT3	65,320

先端部拡大 Enlargement of tip section

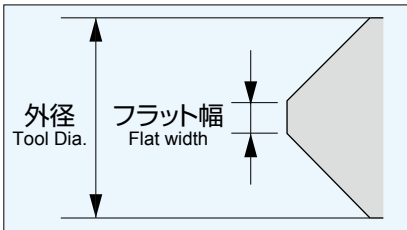

*上記寸法は参考値でありフラット幅を保証するものではありません。

The above dimensions are reference values and are not a guarantee of the flat width.

ハイスエンドミル
その他のエンドミル

CM、CEの対応被削材

Applicable work material of CM, CE

炭素鋼 合金鋼 Carbon steel Alloy steel	炭素鋼 合金鋼 Pre-hardened steel ≤ 45HRC	高硬度 Hardened steel			ステン レス鋼 Stainless steel	チタン合金 耐熱合金 Titanium alloy Heat-resistant alloy	銅合金 Copper alloy	アルミ 合金 Aluminum alloy
		> 45HRC ≤ 55HRC	> 55HRC ≤ 65HRC	> 65HRC				
○					○	○	○	

●印：標準在庫品です。□印：特定代理店在庫です。弊社営業へお問い合わせください。

●：Stoked items. □：Stocked by specified distributor. Contact with our sales department.

再研磨対応外径範囲

Re-grinding compatibility range

商品コード Item code	外周 Outer dia. (mm)	エンド End (mm)
CM	× (N/A)	4 ~ 50
CE	× (N/A)	4 ~ 60

標準切削条件表 Recommended cutting conditions

寸法表 Size list : H66

CM

被削材 (硬さ) Work material (Hardness)	加工種類	切削条件 Cutting Conditions	外径 DC Tool dia. (mm)						
			φ4	φ6	φ10	φ12	φ16	φ20	φ25
鋳鉄・軟鋼 Cast irons, Mild steels (170~200HB) FC200,S50C, SS400	回転数 min ⁻¹		2,300	1,500	900	750	550	450	360
	センタ位置決め Positioning	送り速度 mm/min	115	90	70	55	50	45	35
	内面取り Internal chamfering	送り速度 mm/min	90	75	60	45	36	26	23
	穴あけ Drilling	送り速度 mm/min	70	60	45	35	30	22	18
	V溝加工 V-slotting	送り速度 mm/min	46	40	35	30	25	20	15
合金鋼 Alloy steels (200~300HB) SNC, SNCM, SCM	回転数 min ⁻¹		1,800	1,200	720	600	450	360	290
	センタ位置決め Positioning	送り速度 mm/min	90	70	60	50	40	30	26
	内面取り Internal chamfering	送り速度 mm/min	70	60	50	40	30	25	20
	穴あけ Drilling	送り速度 mm/min	55	50	40	35	30	20	15
	V溝加工 V-slotting	送り速度 mm/min	40	35	30	25	20	15	10

- 【注意】** ①被削材、加工形状に合わせて、適切なクーラントを使用してください。
 ②この標準切削条件表は切削条件の目安を示すものです。実際の加工では加工形状、目的、使用機械等により条件を調整してください。
- 【Note】** ① Use the appropriate coolant for the work material and machining shape.
 ② These Recommended Cutting Conditions indicate only the rule of a thumb for the cutting conditions. In actual machining, the condition should be adjusted according to the machining shape, purpose and the machine type.

ESMボールエンドミル

ロングリーチ

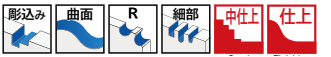

深彫り用



4枚刃



アルミ用ボールエンドミル

アルミ用



ESMLB

商品コード	在庫	寸法 (mm)			
		ボール径	刃長	全長	シャンク径
ESMLB0.5R	<input type="checkbox"/>	0.5	1	60	6
ESMLB1R	<input type="checkbox"/>	1	2	70	6
ESMLB1.5R	<input type="checkbox"/>	1.5	3	80	6
ESMLB2R	<input type="checkbox"/>	2	4	90	6
ESMLB2.5R	<input type="checkbox"/>	2.5	5	100	6
ESMLB3R	<input type="checkbox"/>	3	6	110	6
ESMLB3.5R	<input type="checkbox"/>	3.5	7	110	6
ESMLB4R	<input type="checkbox"/>	4	8	120	8
ESMLB4.5R	<input type="checkbox"/>	4.5	9	120	8
ESMLB5R	<input type="checkbox"/>	5	10	140	10

ESMDB

商品コード	在庫	寸法 (mm)				
		ボール径	刃長	首下長	全長	シャンク径
ESMDB1.5R	<input type="checkbox"/>	1.5	6	23	100	8
ESMDB2R	<input type="checkbox"/>	2	8	30	120	10
ESMDB2.5R	<input type="checkbox"/>	2.5	10	32	120	10
ESMDB3R	<input type="checkbox"/>	3	12	39	130	12
ESMDB3.5R	<input type="checkbox"/>	3.5	14	41	150	12
ESMDB4R	<input type="checkbox"/>	4	16	43	150	12
ESMDB5R	<input type="checkbox"/>	5	20	52	160	16
ESMDB6R	<input type="checkbox"/>	6	24	56	180	16
ESMDB8R	<input type="checkbox"/>	8	30	85	220	20
ESMDB10R	<input type="checkbox"/>	10	30	115	250	25
ESMDB12.5R	<input type="checkbox"/>	12.5	35	140	300	32
ESMDB15R	<input type="checkbox"/>	15	40	145	300	32
ESMDB16R	<input type="checkbox"/>	16	40	155	350	32
ESMDB20R	<input type="checkbox"/>	20	45	200	400	42

4ESMB

商品コード	在庫	寸法 (mm)			
		ボール径	刃長	全長	シャンク径
4ESMB3R	<input type="checkbox"/>	3	15	100	6
4ESMB3.5R	<input type="checkbox"/>	3.5	20	100	6
4ESMB4R	<input type="checkbox"/>	4	20	110	8
4ESMB4.5R	<input type="checkbox"/>	4.5	25	120	8
4ESMB5R	<input type="checkbox"/>	5	25	125	10
4ESMB5.5R	<input type="checkbox"/>	5.5	30	125	10
4ESMB6R	<input type="checkbox"/>	6	30	140	12
4ESMB6.5R	<input type="checkbox"/>	6.5	35	140	12
4ESMB7R	<input type="checkbox"/>	7	35	140	12
4ESMB7.5R	<input type="checkbox"/>	7.5	40	140	12
4ESMB8R	<input type="checkbox"/>	8	40	160	16
4ESMB9R	<input type="checkbox"/>	9	40	160	16
4ESMB10R	<input type="checkbox"/>	10	45	180	20
4ESMB11R	<input type="checkbox"/>	11	45	180	20
4ESMB12R	<input type="checkbox"/>	12	50	180	20
4ESMB12.5R	<input type="checkbox"/>	12.5	50	200	25
4ESMB13R	<input type="checkbox"/>	13	50	200	25
4ESMB14R	<input type="checkbox"/>	14	55	200	25
4ESMB15R	<input type="checkbox"/>	15	55	200	25
4ESMB16R	<input type="checkbox"/>	16	60	200	32
4ESMB18R	<input type="checkbox"/>	18	60	220	32
4ESMB19R	<input type="checkbox"/>	19	65	220	32
4ESMB20R	<input type="checkbox"/>	20	65	220	32
4ESMB22.5R	<input type="checkbox"/>	22.5	70	220	42
4ESMB25R	<input type="checkbox"/>	25	70	240	42

ALB

商品コード	在庫	寸法 (mm)			
		ボール径	刃長	全長	シャンク径
ALB2R	<input type="checkbox"/>	2	8	70	6
ALB2.5R	<input type="checkbox"/>	2.5	10	80	6
ALB3R	<input type="checkbox"/>	3	12	85	6
ALB3.5R	<input type="checkbox"/>	3.5	14	85	6
ALB4R	<input type="checkbox"/>	4	14	95	8
ALB4.5R	<input type="checkbox"/>	4.5	18	100	8
ALB5R	<input type="checkbox"/>	5	18	110	10
ALB5.5R	<input type="checkbox"/>	5.5	18	110	10
ALB6R	<input type="checkbox"/>	6	22	120	12
ALB6.5R	<input type="checkbox"/>	6.5	22	120	12
ALB7R	<input type="checkbox"/>	7	26	120	12
ALB7.5R	<input type="checkbox"/>	7.5	26	120	12
ALB8R	<input type="checkbox"/>	8	30	150	16
ALB9R	<input type="checkbox"/>	9	34	150	16
ALB10R	<input type="checkbox"/>	10	38	160	20
ALB12.5R	<input type="checkbox"/>	12.5	50	180	25
ALB15R	<input type="checkbox"/>	15	55	180	25

NKボールエンドミル

NK ボール



GC・NK ボール



NB

商品コード	在庫	寸法 (mm)				希望小売価格 (円)
		ボール径	刃長	全長	シャンク径	
NB1R	<input checked="" type="checkbox"/>	1	5	73	6	5,840
NB1.5R	<input checked="" type="checkbox"/>	1.5	8	75	6	5,840
NB2R	<input checked="" type="checkbox"/>	2	11	80	6	5,840
NB2.5R	<input checked="" type="checkbox"/>	2.5	13	80	6	5,840
NB3R	<input checked="" type="checkbox"/>	3	13	80	6	5,840
NB3.5R	<input checked="" type="checkbox"/>	3.5	16	95	8	6,790
NB4R	<input checked="" type="checkbox"/>	4	19	95	8	6,790
NB4.5R	<input checked="" type="checkbox"/>	4.5	19	105	10	8,150
NB5R	<input checked="" type="checkbox"/>	5	22	110	10	8,150
NB5.5R	<input type="checkbox"/>	5.5	22	120	12	-
NB6R	<input checked="" type="checkbox"/>	6	26	120	12	9,740
NB6.5R	<input checked="" type="checkbox"/>	6.5	26	135	16	12,080
NB7R	<input checked="" type="checkbox"/>	7	26	135	16	12,080
NB7.5R	<input checked="" type="checkbox"/>	7.5	26	135	16	14,990
NB8R	<input checked="" type="checkbox"/>	8	32	140	16	14,990
NB9R	<input type="checkbox"/>	9	32	150	20	-
NB10R	<input checked="" type="checkbox"/>	10	38	160	20	20,900
NB12.5R	<input checked="" type="checkbox"/>	12.5	45	180	25	27,500
NB15R	<input checked="" type="checkbox"/>	15	45	180	25	39,190

GNB

商品コード	在庫	寸法 (mm)			
		ボール径	刃長	全長	シャンク径
GNB1R	<input type="checkbox"/>	1	5	73	6
GNB1.5R	<input type="checkbox"/>	1.5	8	75	6
GNB2R	<input type="checkbox"/>	2	11	80	6
GNB2.5R	<input type="checkbox"/>	2.5	13	80	6
GNB3R	<input type="checkbox"/>	3	13	80	6
GNB3.5R	<input type="checkbox"/>	3.5	16	95	8
GNB4R	<input type="checkbox"/>	4	19	95	8
GNB4.5R	<input type="checkbox"/>	4.5	19	105	10
GNB5R	<input type="checkbox"/>	5	22	110	10
GNB5.5R	<input type="checkbox"/>	5.5	22	120	12
GNB6R	<input type="checkbox"/>	6	26	120	12
GNB6.5R	<input type="checkbox"/>	6.5	26	135	16
GNB7R	<input type="checkbox"/>	7	26	135	16
GNB7.5R	<input type="checkbox"/>	7.5	26	135	16
GNB8R	<input type="checkbox"/>	8	32	140	16
GNB9R	<input type="checkbox"/>	9	32	150	20
GNB10R	<input type="checkbox"/>	10	38	160	20
GNB12.5R	<input type="checkbox"/>	12.5	45	180	25
GNB15R	<input type="checkbox"/>	15	45	180	25

ESMLB, ESMDB, 4ESMB, NB, GNBの対応被削材

炭素鋼 合金鋼 Carbon steel Alloy steel	炭素鋼 合金鋼 Pre-hardened steel ≤ 45HRC	高硬度 Hardened steel			ステン レス鋼 Stainless steel	チタン合金 耐熱合金 Titanium alloy Heat-resistant alloy	銅合金 Copper alloy	アルミ 合金 Aluminum alloy
		> 45HRC ≤ 55HRC	> 55HRC ≤ 65HRC	> 65HRC				
<input type="checkbox"/>	<input type="checkbox"/>	<input type="checkbox"/>	<input type="checkbox"/>	<input type="checkbox"/>	<input type="checkbox"/>	<input type="checkbox"/>	<input type="checkbox"/>	

ALBの対応被削材

炭素鋼 合金鋼 Carbon steel Alloy steel	炭素鋼 合金鋼 Pre-hardened steel ≤ 45HRC	高硬度 Hardened steel			ステン レス鋼 Stainless steel	チタン合金 耐熱合金 Titanium alloy Heat-resistant alloy	銅合金 Copper alloy	アルミ 合金 Aluminum alloy
		> 45HRC ≤ 55HRC	> 55HRC ≤ 65HRC	> 65HRC				
<input type="checkbox"/>	<input type="checkbox"/>	<input type="checkbox"/>	<input type="checkbox"/>	<input type="checkbox"/>	<input type="checkbox"/>	<input type="checkbox"/>	<input checked="" type="checkbox"/>	

●印：標準在庫品です。●：Stoked items。□印：特定代理店在庫です。弊社営業へお問い合わせください。□：Stocked by specified distributor. Contact with our sales department.

ハイスエンドミル 特定代理店在庫品

GC-NKエンドミルシリーズ

NKエンドミル

ショート刃長

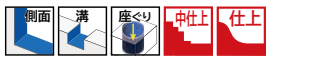

外径公差 0~-0.03 h7 (mm)

コバレット
ハイス G 傾斜30° 切削
条件表 H82



レギュラー刃長



外径公差 0~-0.03 h7 (mm)

コバレット
ハイス G 傾斜30° 切削
条件表 H82



エキストラロング刃長



外径公差 0~-0.03 h7 (mm)

コバレット
ハイス 傾斜30°



2GNKS

商品コード	在庫	寸法 (mm)			
		外径	刃長	全長	シャンク径
2GNKS1	□	1	2.5	55	6
2GNKS1.5	□	1.5	3.5	55	6
2GNKS2	□	2	4	55	6
2GNKS2.5	□	2.5	5	55	6
2GNKS3	□	3	7	55	6
2GNKS3.5	□	3.5	8	65	8
2GNKS4	□	4	8	65	8
2GNKS4.5	□	4.5	10	65	8
2GNKS5	□	5	10	65	8
2GNKS5.5	□	5.5	12	65	8
2GNKS6	□	6	12	65	8
2GNKS6.5	□	6.5	14	70	10
2GNKS7	□	7	14	70	10
2GNKS7.5	□	7.5	14	70	10
2GNKS8	□	8	14	70	10
2GNKS8.5	□	8.5	18	75	10
2GNKS9	□	9	18	75	10
2GNKS9.5	□	9.5	18	75	10
2GNKS10	□	10	18	75	10
2GNKS11	□	11	22	85	12
2GNKS12	□	12	22	85	12
2GNKS13	□	13	25	90	12
2GNKS14	□	14	25	95	16
2GNKS15	□	15	30	100	16
2GNKS16	□	16	30	100	16
2GNKS17	□	17	35	105	16
2GNKS18	□	18	35	105	16
2GNKS19	□	19	40	120	20
2GNKS20	□	20	40	120	20

2GNKR

商品コード	在庫	寸法 (mm)			
		外径	刃長	全長	シャンク径
2GNKR2	□	2	5	55	6
2GNKR2.5	□	2.5	7	55	6
2GNKR3	□	3	10	55	6
2GNKR3.5	□	3.5	12	60	6
2GNKR4	□	4	12	60	6
2GNKR4.5	□	4.5	15	60	6
2GNKR5	□	5	15	60	6
2GNKR5.5	□	5.5	15	60	6
2GNKR6	□	6	15	60	6
2GNKR6.5	□	6.5	20	70	8
2GNKR7	□	7	20	70	8
2GNKR7.5	□	7.5	20	70	8
2GNKR8	□	8	20	70	8
2GNKR8.5	□	8.5	25	80	10
2GNKR9	□	9	25	80	10
2GNKR9.5	□	9.5	25	80	10
2GNKR10	□	10	25	80	10
2GNKR11	□	11	30	95	12
2GNKR12	□	12	30	95	12
2GNKR13	□	13	35	100	12
2GNKR14	□	14	35	105	16
2GNKR15	□	15	40	110	16
2GNKR16	□	16	40	110	16
2GNKR17	□	17	40	110	16
2GNKR18	□	18	40	110	16
2GNKR19	□	19	45	125	20
2GNKR20	□	20	45	125	20
2GNKR21	□	21	45	125	20
2GNKR22	□	22	45	125	20
2GNKR23	□	23	50	140	25
2GNKR24	□	24	50	140	25
2GNKR25	□	25	50	140	25
2GNKR26	□	26	50	140	25
2GNKR27	□	27	55	145	25
2GNKR28	□	28	55	145	25
2GNKR29	□	29	55	145	25
2GNKR30	□	30	55	145	25
2GNKR31	□	31	60	160	32
2GNKR32	□	32	60	160	32
2GNKR33	□	33	60	160	32
2GNKR34	□	34	60	160	32
2GNKR35	□	35	60	160	32
2GNKR36	□	36	60	160	32
2GNKR37	□	37	60	160	32
2GNKR38	□	38	65	165	32
2GNKR39	□	39	65	165	32
2GNKR40	□	40	65	165	32
2GNKR42	□	42	65	165	32
2GNKR44	□	44	70	170	32
2GNKR45	□	45	70	170	32
2GNKR46	□	46	70	170	32
2GNKR48	□	48	70	170	32
2GNKR50	□	50	70	170	32

2NKX

商品コード	在庫	寸法 (mm)			
		外径	刃長	全長	シャンク径
2NKX3X30	□	3	30	65	6
2NKX3X40	□	3	40	70	6
2NKX4X30	□	4	30	65	6
2NKX4X40	□	4	40	85	6
2NKX5X40	□	5	40	75	6
2NKX5X50	□	5	50	85	6
2NKX6X40	□	6	40	75	6
2NKX6X50	□	6	50	95	6
2NKX6X60	□	6	60	95	6
2NKX7X50	□	7	50	90	8
2NKX7X60	□	7	60	100	8
2NKX8X50	□	8	50	90	8
2NKX8X60	□	8	60	100	8
2NKX9X60	□	9	60	100	10
2NKX10X60	□	10	60	105	10
2NKX10X80	□	10	80	125	10
2NKX10X100	□	10	100	155	10
2NKX10X120	□	10	120	175	10
2NKX10X150	□	10	150	205	10
2NKX11X80	□	11	80	125	12
2NKX12X80	□	12	80	130	12
2NKX12X100	□	12	100	150	12
2NKX12X120	□	12	120	185	12
2NKX12X150	□	12	150	215	12
2NKX13X80	□	13	80	150	16
2NKX13X100	□	13	100	150	16
2NKX13X120	□	13	120	190	16
2NKX14X80	□	14	80	130	16
2NKX14X100	□	14	100	150	16
2NKX14X120	□	14	120	190	16
2NKX14X150	□	14	150	220	16
2NKX15X80	□	15	80	135	16
2NKX15X100	□	15	100	155	16
2NKX15X120	□	15	120	190	16
2NKX15X150	□	15	150	220	16
2NKX16X80	□	16	80	135	16
2NKX16X100	□	16	100	155	16
2NKX16X120	□	16	120	190	16
2NKX16X150	□	16	150	220	16
2NKX17X100	□	17	100	180	20
2NKX18X80	□	18	80	135	20
2NKX18X100	□	18	100	155	20
2NKX18X120	□	18	120	200	20
2NKX19X100	□	19	100	180	20
2NKX20X100	□	20	100	165	20
2NKX20X120	□	20	120	185	20
2NKX20X150	□	20	150	230	20
2NKX21X100	□	21	100	190	25
2NKX21X120	□	21	120	210	25
2NKX21X150	□	21	150	240	25
2NKX22X100	□	22	100	190	25
2NKX22X120	□	22	120	185	25
2NKX22X150	□	22	150	240	25

商品コード	在庫	寸法 (mm)			
		外径	刃長	全長	シャンク径
2NKX23X100	□	23	100	190	25
2NKX23X120	□	23	120	210	25
2NKX23X150	□	23	150	240	25
2NKX24X100	□	24	100	190	25
2NKX24X120	□	24	120	190	25
2NKX24X150	□	24	150	240	25
2NKX25X100	□	25	100	190	25
2NKX25X120	□	25	120	210	25
2NKX25X150	□	25	150	220	25
2NKX26X120	□	26	120	190	25
2NKX26X150	□	26	150	240	25
2NKX28X120	□	28	120	210	25
2NKX28X150	□	28	150	220	25
2NKX30X120	□	30	120	210	25
2NKX30X150	□	30	150	220	25
2NKX30X200	□	30	200	290	25
2NKX32X150	□	32	150	235	32
2NKX32X200	□	32	200	300	32
2NKX35X150	□	35	150	235	32
2NKX35X200	□	35	200	300	32
2NKX35X250	□	35	250	350	32
2NKX36X120	□	36	120	205	32
2NKX38X150	□	38	150	235	32
2NKX38X200	□	38	200	300	32
2NKX38X250	□	38	250	350	32
2NKX40X150	□	40	150	260	42
2NKX40X150X32	□	40	150	235	32
2NKX40X200	□	40	200	310	42
2NKX40X200X32	□	40	200	300	32
2NKX40X250	□	40	250	360	42
2NKX40X250X32	□	40	250	350	32
2NKX45X150	□	45	150	260	42
2NKX45X200	□	45	200	310	42
2NKX45X250	□	45	250	360	42
2NKX50X150	□	50	150	260	42
2NKX50X200	□	50	200	310	42
2NKX50X250	□	50	250	360	42
2NKX60X150	□	60	150	260	42
2NKX60X200	□	60	200	310	42
2NKX60X250	□	60	250	360	42

2GNKS、2GNKR、2NKXの対応被削材

炭素鋼 合金鋼 Carbon steel Alloy steel	炭素鋼 合金鋼 Pre-hardened steel ≤ 45HRC	高硬度 Hardened steel			ステン レス鋼 Stainless steel	チタン合金 耐熱合金 Titanium alloy Heat-resistant alloy	銅合金 Copper alloy	アルミ 合金 Aluminum alloy
		> 45HRC ≤ 55HRC	> 55HRC ≤ 65HRC	> 65HRC				
○					○		○	

HSS End Mills

Stocked by Specified distributor

GC-NKエンドミル NKエンドミル

レギュラー刃長



外径公差 +0.03~0 h7 (mm)



φ30以下 φ31以上 (センタカット) (センタ穴付き)



レギュラー刃長



外径公差 0~-0.03 h7 (mm)



レギュラー刃長・センタ穴付き



外径公差 +0.03~0 h7 (mm)



ロング刃長・センタ穴付き



外径公差 +0.03~0 h7 (mm)



4GNKR○○○

商品コード	在庫	寸法 (mm)			
		外径	刃長	全長	シャンク径
4GNKR2.5	<input type="checkbox"/>	2.5	7	55	6
4GNKR3	<input type="checkbox"/>	3	10	55	6
4GNKR3.5	<input type="checkbox"/>	3.5	12	60	6
4GNKR4	<input type="checkbox"/>	4	12	60	6
4GNKR4.5	<input type="checkbox"/>	4.5	15	60	6
4GNKR5	<input type="checkbox"/>	5	15	60	6
4GNKR5.5	<input type="checkbox"/>	5.5	15	60	6
4GNKR6	<input type="checkbox"/>	6	15	60	6
4GNKR6.5	<input type="checkbox"/>	6.5	20	70	8
4GNKR7	<input type="checkbox"/>	7	20	70	8
4GNKR7.5	<input type="checkbox"/>	7.5	20	70	8
4GNKR8	<input type="checkbox"/>	8	20	70	8
4GNKR8.5	<input type="checkbox"/>	8.5	25	80	10
4GNKR9	<input type="checkbox"/>	9	25	80	10
4GNKR9.5	<input type="checkbox"/>	9.5	25	80	10
4GNKR10	<input type="checkbox"/>	10	25	80	10
4GNKR11	<input type="checkbox"/>	11	30	95	12
4GNKR12	<input type="checkbox"/>	12	30	95	12
4GNKR13	<input type="checkbox"/>	13	35	100	12
4GNKR14	<input type="checkbox"/>	14	35	105	16
4GNKR15	<input type="checkbox"/>	15	40	110	16
4GNKR16	<input type="checkbox"/>	16	40	110	16
4GNKR17	<input type="checkbox"/>	17	40	110	16
4GNKR18	<input type="checkbox"/>	18	40	110	16
4GNKR19	<input type="checkbox"/>	19	45	125	20
4GNKR20	<input type="checkbox"/>	20	45	125	20
4GNKR21	<input type="checkbox"/>	21	45	125	20
4GNKR22	<input type="checkbox"/>	22	45	125	20
4GNKR23	<input type="checkbox"/>	23	50	140	25
4GNKR24	<input type="checkbox"/>	24	50	140	25
4GNKR25	<input type="checkbox"/>	25	50	140	25
4GNKR26	<input type="checkbox"/>	26	50	140	25
4GNKR27	<input type="checkbox"/>	27	55	145	25
4GNKR28	<input type="checkbox"/>	28	55	145	25
4GNKR29	<input type="checkbox"/>	29	55	145	25
4GNKR30	<input type="checkbox"/>	30	55	145	25
4GNKR31	<input type="checkbox"/>	31	60	160	32
4GNKR32	<input type="checkbox"/>	32	60	160	32
4GNKR33	<input type="checkbox"/>	33	60	160	32
4GNKR34	<input type="checkbox"/>	34	60	160	32
4GNKR35	<input type="checkbox"/>	35	60	160	32
4GNKR36	<input type="checkbox"/>	36	60	160	32
4GNKR37	<input type="checkbox"/>	37	60	160	32
4GNKR38	<input type="checkbox"/>	38	65	165	32
4GNKR39	<input type="checkbox"/>	39	65	165	32
4GNKR40	<input type="checkbox"/>	40	65	165	32
4GNKR42	<input type="checkbox"/>	42	65	165	32
4GNKR44	<input type="checkbox"/>	44	70	170	32
4GNKR45	<input type="checkbox"/>	45	70	170	32
4GNKR46	<input type="checkbox"/>	46	70	170	32
4GNKR48	<input type="checkbox"/>	48	70	170	32
4GNKR50	<input type="checkbox"/>	50	70	170	32

3NKR○○

商品コード	在庫	寸法 (mm)			
		外径	刃長	全長	シャンク径
3NKR3	<input type="checkbox"/>	3	10	55	6
3NKR4	<input type="checkbox"/>	4	12	60	6
3NKR5	<input type="checkbox"/>	5	15	60	6
3NKR6	<input type="checkbox"/>	6	15	60	6
3NKR7	<input type="checkbox"/>	7	20	70	8
3NKR8	<input type="checkbox"/>	8	20	70	8
3NKR9	<input type="checkbox"/>	9	25	80	10
3NKR10	<input type="checkbox"/>	10	25	80	10
3NKR11	<input type="checkbox"/>	11	30	95	12
3NKR12	<input type="checkbox"/>	12	30	95	12
3NKR13	<input type="checkbox"/>	13	35	105	16
3NKR14	<input type="checkbox"/>	14	35	105	16
3NKR15	<input type="checkbox"/>	15	40	110	16
3NKR16	<input type="checkbox"/>	16	40	110	16
3NKR17	<input type="checkbox"/>	17	40	120	20
3NKR18	<input type="checkbox"/>	18	40	120	20
3NKR19	<input type="checkbox"/>	19	45	125	20
3NKR20	<input type="checkbox"/>	20	45	125	20
3NKR21	<input type="checkbox"/>	21	45	135	25
3NKR22	<input type="checkbox"/>	22	45	135	25
3NKR23	<input type="checkbox"/>	23	50	140	25
3NKR24	<input type="checkbox"/>	24	50	140	25
3NKR25	<input type="checkbox"/>	25	50	140	25
3NKR26	<input type="checkbox"/>	26	50	140	25
3NKR27	<input type="checkbox"/>	27	55	145	25
3NKR28	<input type="checkbox"/>	28	55	145	25
3NKR29	<input type="checkbox"/>	29	55	145	25
3NKR30	<input type="checkbox"/>	30	55	145	25

4NKRE○○(×○○)

商品コード	在庫	寸法 (mm)			
		外径	刃長	全長	シャンク径
4NKRE31	<input type="checkbox"/>	31	60	160	32
4NKRE32	<input type="checkbox"/>	32	60	160	32
4NKRE33	<input type="checkbox"/>	33	60	160	32
4NKRE34	<input type="checkbox"/>	34	60	160	32
4NKRE35	<input type="checkbox"/>	35	60	160	32
4NKRE36	<input type="checkbox"/>	36	60	160	32
4NKRE37	<input type="checkbox"/>	37	60	160	32
4NKRE38	<input type="checkbox"/>	38	65	165	32
4NKRE39	<input type="checkbox"/>	39	65	165	32
4NKRE40	<input type="checkbox"/>	40	65	165	32
4NKRE41×32	<input type="checkbox"/>	41	65	165	32
4NKRE42×32	<input type="checkbox"/>	42	65	165	32
4NKRE42	<input type="checkbox"/>	42	65	175	42
4NKRE43×32	<input type="checkbox"/>	43	70	170	32
4NKRE44×32	<input type="checkbox"/>	44	70	170	32
4NKRE44	<input type="checkbox"/>	44	70	180	42
4NKRE45×32	<input type="checkbox"/>	45	70	170	32
4NKRE45	<input type="checkbox"/>	45	70	180	42
4NKRE46×32	<input type="checkbox"/>	46	70	170	32
4NKRE46	<input type="checkbox"/>	46	70	180	42
4NKRE47×32	<input type="checkbox"/>	47	70	170	32
4NKRE48×32	<input type="checkbox"/>	48	70	170	32
4NKRE48	<input type="checkbox"/>	48	70	180	42
4NKRE49×32	<input type="checkbox"/>	49	70	170	32
4NKRE50×32	<input type="checkbox"/>	50	70	170	32
4NKRE50	<input type="checkbox"/>	50	70	180	42

4NKLE○○(×○○)

商品コード	在庫	寸法 (mm)			
		外径	刃長	全長	シャンク径
4NKLE3	<input type="checkbox"/>	3	15	60	6
4NKLE4	<input type="checkbox"/>	4	20	65	6
4NKLE5	<input type="checkbox"/>	5	25	70	6
4NKLE6	<input type="checkbox"/>	6	25	70	6
4NKLE7	<input type="checkbox"/>	7	35	85	8
4NKLE8	<input type="checkbox"/>	8	35	85	8
4NKLE9	<input type="checkbox"/>	9	45	100	10
4NKLE10	<input type="checkbox"/>	10	45	100	10
4NKLE11	<input type="checkbox"/>	11	55	120	12
4NKLE12	<input type="checkbox"/>	12	55	120	12
4NKLE13	<input type="checkbox"/>	13	55	120	12
4NKLE14	<input type="checkbox"/>	14	55	125	16
4NKLE15	<input type="checkbox"/>	15	65	135	16
4NKLE16	<input type="checkbox"/>	16	65	135	16
4NKLE17	<input type="checkbox"/>	17	65	135	16
4NKLE18	<input type="checkbox"/>	18	65	135	16
4NKLE19	<input type="checkbox"/>	19	75	155	20
4NKLE20	<input type="checkbox"/>	20	75	155	20
4NKLE21	<input type="checkbox"/>	21	75	155	20
4NKLE22	<input type="checkbox"/>	22	75	155	20
4NKLE23	<input type="checkbox"/>	23	90	180	25
4NKLE24	<input type="checkbox"/>	24	90	180	25
4NKLE25	<input type="checkbox"/>	25	90	180	25
4NKLE26	<input type="checkbox"/>	26	90	180	25
4NKLE27	<input type="checkbox"/>	27	90	180	25
4NKLE28	<input type="checkbox"/>	28	90	180	25
4NKLE29	<input type="checkbox"/>	29	90	180	25
4NKLE30	<input type="checkbox"/>	30	90	180	25
4NKLE31	<input type="checkbox"/>	31	95	195	32
4NKLE32	<input type="checkbox"/>	32	95	195	32
4NKLE33	<input type="checkbox"/>	33	95	195	32
4NKLE34	<input type="checkbox"/>	34	95	195	32
4NKLE35	<input type="checkbox"/>	35	100	200	32
4NKLE36	<input type="checkbox"/>	36	100	200	32
4NKLE37	<input type="checkbox"/>	37	100	200	32
4NKLE38	<input type="checkbox"/>	38	105	205	32
4NKLE39	<input type="checkbox"/>	39	110	210	32
4NKLE40×32	<input type="checkbox"/>	40	110	210	32
4NKLE41×32	<input type="checkbox"/>	41	110	210	32
4NKLE42×32	<input type="checkbox"/>	42	110	210	32
4NKLE43×32	<input type="checkbox"/>	43	110	210	32
4NKLE44×32	<input type="checkbox"/>	44	115	215	32
4NKLE45×32	<input type="checkbox"/>	45	115	215	32
4NKLE46×32	<input type="checkbox"/>	46	115	215	32
4NKLE47×32	<input type="checkbox"/>	47	115	215	32
4NKLE48×32	<input type="checkbox"/>	48	120	220	32
4NKLE49×32	<input type="checkbox"/>	49	120	220	32
4NKLE50×32	<input type="checkbox"/>	50	120	220	32
4NKLE50×42	<input type="checkbox"/>	50	120	230	42

ハイスエンドミル 特定代理店在庫品

4GNKR、3NKR、4NKRE、4NKLEの対応被削材

炭素鋼 合金鋼 Carbon steel Alloy steel	炭素鋼 合金鋼 Pre-hardened steel ≤45HRC	高硬度 Hardened steel			ステン レス鋼 Stainless steel	チタン合金 耐熱合金 Titanium alloy Heat-resistant alloy	銅合金 Copper alloy	アルミ 合金 Aluminum alloy
		>45HRC ≤55HRC	>55HRC ≤65HRC	>65HRC				
<input type="checkbox"/>	<input type="checkbox"/>	<input type="checkbox"/>	<input type="checkbox"/>	<input type="checkbox"/>	<input type="checkbox"/>	<input type="checkbox"/>	<input type="checkbox"/>	

□印：特定代理店在庫です。弊社営業へお問合せください。 □：Stocked by specified distributor. Contact with our sales department.

GC-ファインミル

エキストラロング刃長



外径公差 +0.03~0



(mm)



4NKX

商品コード	在庫	寸法 (mm)			シャンク径
		外径	刃長	全長	
4NKX3X30	□	3	30	65	6
4NKX3X40	□	3	40	85	6
4NKX4X30	□	4	30	65	6
4NKX4X40	□	4	40	85	6
4NKX5X40	□	5	40	75	6
4NKX5X50	□	5	50	95	6
4NKX6X40	□	6	40	75	6
4NKX6X50	□	6	50	95	6
4NKX6X60	□	6	60	95	6
4NKX7X50	□	7	50	90	8
4NKX7X60	□	7	60	100	8
4NKX8X50	□	8	50	90	8
4NKX8X60	□	8	60	100	8
4NKX9X60	□	9	60	100	10
4NKX10X60	□	10	60	105	10
4NKX10X80	□	10	80	125	10
4NKX11X80	□	11	80	125	12
4NKX12X80	□	12	80	130	12
4NKX12X100	□	12	100	150	12
4NKX13X80	□	13	80	150	16
4NKX13X100	□	13	100	150	16
4NKX14X80	□	14	80	130	16
4NKX14X100	□	14	100	150	16
4NKX14X120	□	14	120	150	16
4NKX14X150	□	14	150	220	16
4NKX15X80	□	15	80	135	16
4NKX15X100	□	15	100	155	16
4NKX16X80	□	16	80	135	16
4NKX16X100	□	16	100	155	16
4NKX17X100	□	17	100	180	20
4NKX18X80	□	18	80	135	20
4NKX18X100	□	18	100	155	20
4NKX19X100	□	19	100	180	20
4NKX20X100	□	20	100	165	20
4NKX20X120	□	20	120	185	20
4NKX20X150	□	20	150	230	20
4NKX21X100	□	21	100	190	25
4NKX21X120	□	21	120	210	25
4NKX21X150	□	21	150	240	25
4NKX22X100	□	22	100	190	25
4NKX22X120	□	22	120	185	25
4NKX22X150	□	22	150	240	25
4NKX23X100	□	23	100	190	25
4NKX23X120	□	23	120	210	25
4NKX23X150	□	23	150	240	25
4NKX24X100	□	24	100	190	25
4NKX24X120	□	24	120	190	25
4NKX24X150	□	24	150	240	25
4NKX25X100	□	25	100	190	25
4NKX25X120	□	25	120	210	25
4NKX25X150	□	25	150	220	25
4NKX26X100	□	26	100	190	25

ロングシャンク

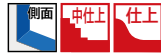

外径公差 +0.03~0



(mm)



LS

商品コード	在庫	寸法 (mm)			シャンク径
		外径	刃長	全長	
LS6	□	6	15	95	6
LS8	□	8	20	100	8
LS10	□	10	25	125	10
LS12	□	12	30	150	10
LS14	□	14	35	150	12
LS15	□	15	40	155	12
LS16	□	16	40	155	12
LS18	□	18	40	155	16
LS20	□	20	45	185	16
LS22	□	22	45	185	20
LS24	□	24	50	190	20
LS25	□	25	50	220	20
LS28	□	28	55	220	25
LS30	□	30	55	220	25
LS32	□	32	60	235	25
LS34	□	34	60	235	32
LS35	□	35	60	235	32
LS38	□	38	65	285	32
LS40	□	40	65	285	32
LS45	□	45	70	310	42
LS50	□	50	70	310	42

ショート刃長



外径公差 φ6~φ12 : 0~-0.1
φ13~φ16 : 0~-0.15
φ17~φ50 : 0~-0.2

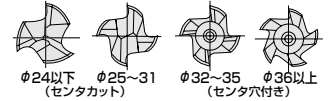

GFQS

商品コード	在庫	寸法 (mm)			シャンク径	刃数
		外径	刃長	全長		
GFQS6	□	6	15	80	6	3
GFQS7	□	7	20	90	8	3
GFQS8	□	8	20	90	8	3
GFQS9	□	9	25	100	10	3
GFQS10	□	10	25	100	10	3
GFQS11	□	11	30	110	12	3
GFQS12	□	12	30	110	12	3
GFQS13	□	13	30	110	12	3
GFQS14	□	14	30	110	12	3
GFQS15	□	15	30	110	16	3
GFQS16	□	16	35	125	16	3
GFQS17	□	17	35	125	16	3
GFQS18	□	18	35	125	16	3
GFQS19	□	19	40	140	16	3
GFQS20	□	20	40	140	20	3
GFQS21	□	21	40	140	20	3
GFQS22	□	22	40	140	20	3
GFQS23	□	23	45	160	20	3
GFQS24	□	24	45	160	20	3
GFQS25	□	25	45	160	25	4
GFQS26	□	26	45	160	25	4
GFQS27	□	27	45	160	25	4
GFQS28	□	28	45	160	25	4
GFQS29	□	29	45	160	25	4
GFQS30	□	30	45	160	25	4
GFQS31	□	31	55	180	25	4
GFQS32	□	32	55	180	32	4
GFQS33	□	33	55	180	32	4
GFQS34	□	34	55	180	32	4
GFQS35	□	35	55	180	32	4
GFQS36	□	36	55	180	32	5
GFQS37	□	37	55	180	32	5
GFQS38	□	38	65	200	32	5
GFQS39	□	39	65	200	32	5
GFQS40	□	40	65	200	32	5
GFQS42	□	42	65	200	42	5
GFQS44	□	44	65	200	42	5
GFQS45	□	45	65	200	42	5
GFQS46	□	46	65	200	42	5
GFQS48	□	48	75	225	42	5
GFQS50	□	50	75	225	42	5

4NKX、LS、GFQSの対応被削材

炭素鋼 合金鋼	炭素鋼 合金鋼	高硬度 Hardened steel			ステン レス鋼	チタン合金 耐熱合金	銅合金	アルミ 合金
		> 45HRC ≤ 55HRC	> 55HRC ≤ 65HRC	> 65HRC				
○	○	○	○	○	○	○	○	

HSS End Mills

Stocked by Specified distributor

GC-ファインミル

レギュラー刃長



外径公差	φ6~φ12 : 0~-0.1
	φ13~φ16 : 0~-0.15
	φ17~φ50 : 0~-0.2
	(mm)

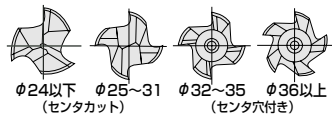

ロング刃長

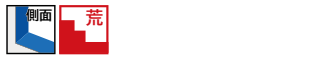

外径公差	φ10~φ12 : 0~-0.1
	φ14~φ16 : 0~-0.15
	φ18~φ50 : 0~-0.2
	(mm)

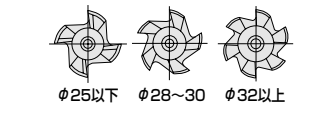

スーパーカットエンドミル

Gコーティング・レギュラー刃長



外径公差	+0.04~0
	(mm)

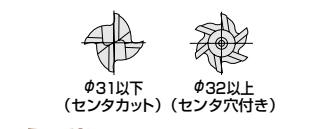
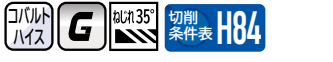

GCコートラフィングエンドミル

Gコーティング・ショート刃長



外径公差	φ6~φ12 : 0~-0.1
	φ13~φ16 : 0~-0.15
	φ17~φ50 : 0~-0.2
	(mm)

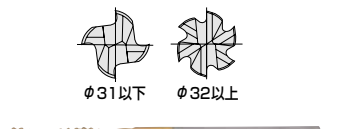
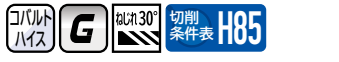

GFQR

商品コード	在庫	寸法 (mm)				刃数
		外径	刃長	全長	シャンク径	
GFQR6	<input type="checkbox"/>	6	20	80	6	3
GFQR7	<input type="checkbox"/>	7	25	90	8	3
GFQR8	<input type="checkbox"/>	8	25	90	8	3
GFQR9	<input type="checkbox"/>	9	35	100	10	3
GFQR10	<input type="checkbox"/>	10	35	100	10	3
GFQR11	<input type="checkbox"/>	11	40	110	12	3
GFQR12	<input type="checkbox"/>	12	40	110	12	3
GFQR13	<input type="checkbox"/>	13	40	110	12	3
GFQR14	<input type="checkbox"/>	14	40	110	12	3
GFQR15	<input type="checkbox"/>	15	40	110	12	3
GFQR16	<input type="checkbox"/>	16	50	125	16	3
GFQR17	<input type="checkbox"/>	17	50	125	16	3
GFQR18	<input type="checkbox"/>	18	50	125	16	3
GFQR19	<input type="checkbox"/>	19	55	140	16	3
GFQR20	<input type="checkbox"/>	20	55	140	20	3
GFQR21	<input type="checkbox"/>	21	55	140	20	3
GFQR22	<input type="checkbox"/>	22	60	140	20	3
GFQR23	<input type="checkbox"/>	23	70	160	20	3
GFQR24	<input type="checkbox"/>	24	70	160	20	3
GFQR25	<input type="checkbox"/>	25	70	160	25	4
GFQR26	<input type="checkbox"/>	26	70	160	25	4
GFQR27	<input type="checkbox"/>	27	75	160	25	4
GFQR28	<input type="checkbox"/>	28	75	160	25	4
GFQR29	<input type="checkbox"/>	29	80	160	25	4
GFQR30	<input type="checkbox"/>	30	80	160	25	4
GFQR31	<input type="checkbox"/>	31	80	180	25	4
GFQR32	<input type="checkbox"/>	32	80	180	32	4
GFQR33	<input type="checkbox"/>	33	90	180	32	4
GFQR34	<input type="checkbox"/>	34	90	180	32	4
GFQR35	<input type="checkbox"/>	35	90	180	32	4
GFQR36	<input type="checkbox"/>	36	90	180	32	5
GFQR37	<input type="checkbox"/>	37	90	180	32	5
GFQR38	<input type="checkbox"/>	38	100	200	32	5
GFQR39	<input type="checkbox"/>	39	100	200	32	5
GFQR40	<input type="checkbox"/>	40	100	200	32	5
GFQR42	<input type="checkbox"/>	42	100	200	42	5
GFQR44	<input type="checkbox"/>	44	110	200	42	5
GFQR45	<input type="checkbox"/>	45	110	200	42	5
GFQR46	<input type="checkbox"/>	46	110	200	42	5
GFQR48	<input type="checkbox"/>	48	120	225	42	5
GFQR50	<input type="checkbox"/>	50	120	225	42	5

GFQL

商品コード	在庫	寸法 (mm)				刃数
		外径	刃長	全長	シャンク径	
GFQL10	<input type="checkbox"/>	10	45	100	10	4
GFQL12	<input type="checkbox"/>	12	55	110	12	4
GFQL14	<input type="checkbox"/>	14	55	110	12	4
GFQL15	<input type="checkbox"/>	15	55	110	16	4
GFQL16	<input type="checkbox"/>	16	65	125	16	4
GFQL18	<input type="checkbox"/>	18	65	125	16	4
GFQL20	<input type="checkbox"/>	20	75	140	20	4
GFQL22	<input type="checkbox"/>	22	75	140	20	4
GFQL25	<input type="checkbox"/>	25	90	165	25	4
GFQL28	<input type="checkbox"/>	28	90	165	25	5
GFQL30	<input type="checkbox"/>	30	90	165	25	5
GFQL32	<input type="checkbox"/>	32	110	190	32	6
GFQL35	<input type="checkbox"/>	35	110	190	32	6
GFQL40	<input type="checkbox"/>	40	125	205	32	6
GFQL45	<input type="checkbox"/>	45	125	230	42	6
GFQL50	<input type="checkbox"/>	50	150	255	42	6

GRFR

商品コード	在庫	寸法 (mm)				刃数
		外径	刃長	全長	シャンク径	
GRFR6	<input type="checkbox"/>	6	15	60	6	4
GRFR7	<input type="checkbox"/>	7	20	70	8	4
GRFR8	<input type="checkbox"/>	8	20	70	8	4
GRFR9	<input type="checkbox"/>	9	25	80	10	4
GRFR10	<input type="checkbox"/>	10	25	80	10	4
GRFR11	<input type="checkbox"/>	11	30	95	12	4
GRFR12	<input type="checkbox"/>	12	30	95	12	4
GRFR13	<input type="checkbox"/>	13	35	105	16	4
GRFR14	<input type="checkbox"/>	14	35	105	16	4
GRFR15	<input type="checkbox"/>	15	40	110	16	4
GRFR16	<input type="checkbox"/>	16	40	110	16	4
GRFR17	<input type="checkbox"/>	17	40	120	20	4
GRFR18	<input type="checkbox"/>	18	40	120	20	4
GRFR19	<input type="checkbox"/>	19	45	125	20	4
GRFR20	<input type="checkbox"/>	20	45	125	20	4
GRFR21	<input type="checkbox"/>	21	45	135	25	4
GRFR22	<input type="checkbox"/>	22	45	135	25	4
GRFR23	<input type="checkbox"/>	23	50	140	25	4
GRFR24	<input type="checkbox"/>	24	50	140	25	4
GRFR25	<input type="checkbox"/>	25	50	140	25	4
GRFR26	<input type="checkbox"/>	26	50	140	25	4
GRFR27	<input type="checkbox"/>	27	55	145	25	4
GRFR28	<input type="checkbox"/>	28	55	145	25	4
GRFR29	<input type="checkbox"/>	29	55	145	25	4
GRFR30	<input type="checkbox"/>	30	55	145	25	4
GRFR31	<input type="checkbox"/>	31	60	160	32	4
GRFR32	<input type="checkbox"/>	32	60	160	32	6
GRFR33	<input type="checkbox"/>	33	60	160	32	6
GRFR34	<input type="checkbox"/>	34	60	160	32	6
GRFR35	<input type="checkbox"/>	35	60	160	32	6
GRFR36	<input type="checkbox"/>	36	60	160	32	6
GRFR37	<input type="checkbox"/>	37	60	160	32	6
GRFR38	<input type="checkbox"/>	38	65	165	32	6
GRFR39	<input type="checkbox"/>	39	65	165	32	6
GRFR40	<input type="checkbox"/>	40	65	165	32	6
GRFR42	<input type="checkbox"/>	42	65	175	42	6
GRFR44	<input type="checkbox"/>	44	70	180	42	6
GRFR45	<input type="checkbox"/>	45	70	180	42	6
GRFR46	<input type="checkbox"/>	46	70	180	42	6
GRFR48	<input type="checkbox"/>	48	70	180	42	6
GRFR50	<input type="checkbox"/>	50	70	180	42	6

GCQS

セクタカット

商品コード	在庫	寸法 (mm)				刃数
		外径	刃長	全長	シャンク径	
GCQS6	<input type="checkbox"/>	6	13	60	6	4
GCQS7	<input type="checkbox"/>	7	16	65	8	4
GCQS8	<input type="checkbox"/>	8	19	70	8	4
GCQS9	<input type="checkbox"/>	9	19	75	10	4
GCQS10	<input type="checkbox"/>	10	22	80	10	4
GCQS11	<input type="checkbox"/>	11	22	85	12	4
GCQS12	<input type="checkbox"/>	12	26	90	12	4
GCQS13	<input type="checkbox"/>	13	26	90	12	4
GCQS14	<input type="checkbox"/>	14	26	90	12	4
GCQS15	<input type="checkbox"/>	15	26	90	12	4
GCQS16	<input type="checkbox"/>	16	32	100	16	4
GCQS17	<input type="checkbox"/>	17	32	100	16	4
GCQS18	<input type="checkbox"/>	18	32	100	16	4
GCQS19	<input type="checkbox"/>	19	32	100	16	4
GCQS20	<input type="checkbox"/>	20	40	120	20	4
GCQS21	<input type="checkbox"/>	21	40	120	20	4
GCQS22	<input type="checkbox"/>	22	40	120	20	4
GCQS23	<input type="checkbox"/>	23	45	125	20	4
GCQS24	<input type="checkbox"/>	24	45	125	20	4
GCQS25	<input type="checkbox"/>	25	50	140	25	4
GCQS26	<input type="checkbox"/>	26	50	140	25	4
GCQS27	<input type="checkbox"/>	27	55	145	25	4
GCQS28	<input type="checkbox"/>	28	55	145	25	4
GCQS29	<input type="checkbox"/>	29	55	145	25	4
GCQS30	<input type="checkbox"/>	30	55	145	25	4
GCQS31	<input type="checkbox"/>	31	60	150	25	4
GCQS32	<input type="checkbox"/>	32	60	160	32	6
GCQS33	<input type="checkbox"/>	33	60	160	32	6
GCQS34	<input type="checkbox"/>	34	60	160	32	6
GCQS35	<input type="checkbox"/>	35	60	160	32	6
GCQS36	<input type="checkbox"/>	36	60	160	32	6
GCQS37	<input type="checkbox"/>	37	60	160	32	6
GCQS38	<input type="checkbox"/>	38	65	165	32	6
GCQS39	<input type="checkbox"/>	39	65	165	32	6
GCQS40	<input type="checkbox"/>	40	65	165	32	6
GCQS42	<input type="checkbox"/>	42	65	165	32	6
GCQS44	<input type="checkbox"/>	44	70	170	32	6
GCQS45	<input type="checkbox"/>	45	70	170	32	6
GCQS46	<input type="checkbox"/>	46	70	170	32	6
GCQS48	<input type="checkbox"/>	48	75	175	32	6
GCQS50	<input type="checkbox"/>	50	75	175	32	6

ATファインミル

ロング刃長



外径公差	φ10~φ12 : 0~-0.1
	φ14~φ16 : 0~-0.15
	φ18~φ35 : 0~-0.2
	(mm)

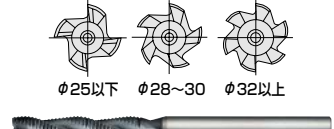
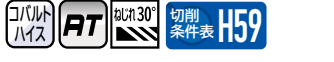

FQL-AT

商品コード	在庫	寸法 (mm)				刃数
		外径	刃長	全長	シャンク径	
FQL10-AT	<input type="checkbox"/>	10	45	100	10	4
FQL12-AT	<input type="checkbox"/>	12	55	110	12	4
FQL14-AT	<input type="checkbox"/>	14	55	110	12	4
FQL15-AT	<input type="checkbox"/>	15	55	110	16	4
FQL16-AT	<input type="checkbox"/>	16	65	125	16	4
FQL18-AT	<input type="checkbox"/>	18	65	125	16	4
FQL20-AT	<input type="checkbox"/>	20	75	140	20	4
FQL22-AT	<input type="checkbox"/>	22	75	140	20	4
FQL25-AT	<input type="checkbox"/>	25	90	165	25	4
FQL28-AT	<input type="checkbox"/>	28	90	165	25	5
FQL30-AT	<input type="checkbox"/>	30	90	165	25	5
FQL32-AT	<input type="checkbox"/>	32	110	190	32	6
FQL35-AT	<input type="checkbox"/>	35	110	190	32	6

GFQR、GFQL、GRFR、GCQSの対応被削材

炭素鋼 合金鋼	炭素鋼 合金鋼	高硬度 Hardened steel	ステン レス鋼	チタン合金 耐熱合金	銅合金	アルミ 合金
Carbon						

GCコートラフィングエンドミル

ラフィングエンドミル

Gコーティング・レギュラー刃長

Gコーティング・レギュラー刃長

ショート刃長

レギュラー刃長



外径公差
 $\phi 6 \sim \phi 12$: 0 ~ -0.1
 $\phi 13 \sim \phi 16$: 0 ~ -0.15
 $\phi 17 \sim \phi 50$: 0 ~ -0.2 (mm)

h7



外径公差
 $\phi 6 \sim \phi 12$: 0 ~ -0.1
 $\phi 14 \sim \phi 16$: 0 ~ -0.15
 $\phi 18 \sim \phi 50$: 0 ~ -0.2 (mm)

h7



外径公差
 0 ~ -0.2 (mm)

h7



外径公差
 $\phi 6 \sim \phi 12$: 0 ~ -0.1
 $\phi 14 \sim \phi 16$: 0 ~ -0.15
 $\phi 18 \sim \phi 60$: 0 ~ -0.2 (mm)

h7

コバルトハイス **G** ねじれ30° 切削条件表 **H85**

コバルトハイス **G** ねじれ30° 切削条件表 **H85**

コバルトハイス ねじれ30°

コバルトハイス HSS-Co Helix angle

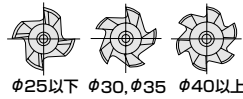
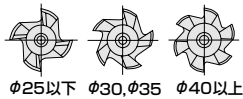
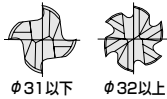

GRQR センタカット

GQR センタ穴付き

QS センタ穴付き

QR (X) センタ穴付き

商品コード	在庫	寸法 (mm)				刃数
		外径	刃長	全長	シャンク径	
GRQR6	<input type="checkbox"/>	6	16	65	6	4
GRQR7	<input type="checkbox"/>	7	20	75	8	4
GRQR8	<input type="checkbox"/>	8	25	80	8	4
GRQR9	<input type="checkbox"/>	9	25	85	10	4
GRQR10	<input type="checkbox"/>	10	30	90	10	4
GRQR11	<input type="checkbox"/>	11	30	95	12	4
GRQR12	<input type="checkbox"/>	12	40	105	12	4
GRQR13	<input type="checkbox"/>	13	40	105	12	4
GRQR14	<input type="checkbox"/>	14	40	105	12	4
GRQR15	<input type="checkbox"/>	15	40	105	12	4
GRQR16	<input type="checkbox"/>	16	50	120	16	4
GRQR17	<input type="checkbox"/>	17	50	120	16	4
GRQR18	<input type="checkbox"/>	18	50	120	16	4
GRQR19	<input type="checkbox"/>	19	50	120	16	4
GRQR20	<input type="checkbox"/>	20	55	135	20	4
GRQR21	<input type="checkbox"/>	21	55	135	20	4
GRQR22	<input type="checkbox"/>	22	55	135	20	4
GRQR23	<input type="checkbox"/>	23	60	140	20	4
GRQR24	<input type="checkbox"/>	24	60	140	20	4
GRQR25	<input type="checkbox"/>	25	70	160	25	4
GRQR26	<input type="checkbox"/>	26	70	160	25	4
GRQR27	<input type="checkbox"/>	27	70	160	25	4
GRQR28	<input type="checkbox"/>	28	80	170	25	4
GRQR29	<input type="checkbox"/>	29	80	170	25	4
GRQR30	<input type="checkbox"/>	30	80	170	25	4
GRQR31	<input type="checkbox"/>	31	90	180	25	4
GRQR32	<input type="checkbox"/>	32	90	190	32	6
GRQR33	<input type="checkbox"/>	33	90	190	32	6
GRQR34	<input type="checkbox"/>	34	90	190	32	6
GRQR35	<input type="checkbox"/>	35	90	190	32	6
GRQR36	<input type="checkbox"/>	36	90	190	32	6
GRQR37	<input type="checkbox"/>	37	90	190	32	6
GRQR38	<input type="checkbox"/>	38	100	200	32	6
GRQR39	<input type="checkbox"/>	39	100	200	32	6
GRQR40	<input type="checkbox"/>	40	100	200	32	6
GRQR42	<input type="checkbox"/>	42	100	200	32	6
GRQR44	<input type="checkbox"/>	44	110	210	32	6
GRQR45	<input type="checkbox"/>	45	110	210	32	6
GRQR46	<input type="checkbox"/>	46	110	210	32	6
GRQR48	<input type="checkbox"/>	48	120	220	32	6
GRQR50	<input type="checkbox"/>	50	120	220	32	6

商品コード	在庫	寸法 (mm)				刃数
		外径	刃長	全長	シャンク径	
GQR6	<input type="checkbox"/>	6	13	60	6	4
GQR8	<input type="checkbox"/>	8	19	70	8	4
GQR10	<input type="checkbox"/>	10	22	80	10	4
GQR12	<input type="checkbox"/>	12	26	90	12	4
GQR14	<input type="checkbox"/>	14	26	95	16	4
GQR15	<input type="checkbox"/>	15	26	95	16	4
GQR16	<input type="checkbox"/>	16	32	100	16	4
GQR18	<input type="checkbox"/>	18	32	110	20	4
GQR20	<input type="checkbox"/>	20	55	135	20	4
GQR25	<input type="checkbox"/>	25	70	160	25	4
GQR30	<input type="checkbox"/>	30	80	180	32	5
GQR35	<input type="checkbox"/>	35	90	190	32	5
GQR40	<input type="checkbox"/>	40	100	200	32	6
GQR45	<input type="checkbox"/>	45	110	220	42	6
GQR50	<input type="checkbox"/>	50	120	230	42	6

商品コード	在庫	寸法 (mm)				刃数
		外径	刃長	全長	シャンク径	
QS20	<input type="checkbox"/>	20	40	120	20	4
QS25	<input type="checkbox"/>	25	50	140	25	4
QS30	<input type="checkbox"/>	30	55	155	32	5
QS35	<input type="checkbox"/>	35	60	160	32	5
QS40	<input type="checkbox"/>	40	65	165	32	6
QS45	<input type="checkbox"/>	45	70	180	42	6
QS50	<input type="checkbox"/>	50	75	185	42	6

商品コード	在庫	寸法 (mm)				刃数
		外径	刃長	全長	シャンク径	
QR6	<input type="checkbox"/>	6	13	60	6	4
QR8	<input type="checkbox"/>	8	19	70	8	4
QR10	<input type="checkbox"/>	10	22	80	10	4
QR12	<input type="checkbox"/>	12	26	90	12	4
QR14	<input type="checkbox"/>	14	26	95	16	4
QR15	<input type="checkbox"/>	15	26	95	16	4
QR16	<input type="checkbox"/>	16	32	100	16	4
QR18	<input type="checkbox"/>	18	32	110	20	4
QR20	<input type="checkbox"/>	20	55	135	20	4
QR21	<input type="checkbox"/>	21	55	145	25	4
QR22	<input type="checkbox"/>	22	55	145	25	4
QR23	<input type="checkbox"/>	23	55	145	25	4
QR24	<input type="checkbox"/>	24	70	160	25	4
QR25	<input type="checkbox"/>	25	70	160	25	4
QR26	<input type="checkbox"/>	26	70	170	32	4
QR27	<input type="checkbox"/>	27	70	170	32	5
QR28	<input type="checkbox"/>	28	70	170	32	5
QR29	<input type="checkbox"/>	29	80	180	32	5
QR30	<input type="checkbox"/>	30	80	180	32	5
QR31	<input type="checkbox"/>	31	80	180	32	5
QR32	<input type="checkbox"/>	32	80	180	32	5
QR33X80	<input type="checkbox"/>	33	80	180	32	5
QR33X90	<input type="checkbox"/>	33	90	190	32	5
QR34	<input type="checkbox"/>	34	90	190	32	5
QR35X32	<input type="checkbox"/>	35	90	190	32	5
QR35X42	<input type="checkbox"/>	35	90	200	42	5
QR36	<input type="checkbox"/>	36	100	200	32	5
QR37	<input type="checkbox"/>	37	100	200	32	5
QR38	<input type="checkbox"/>	38	100	200	32	6
QR39	<input type="checkbox"/>	39	100	200	32	6
QR40X32	<input type="checkbox"/>	40	100	200	32	6
QR40X42	<input type="checkbox"/>	40	100	210	42	6
QR42X32	<input type="checkbox"/>	42	100	210	32	6
QR42X42	<input type="checkbox"/>	42	100	210	42	6
QR45X32	<input type="checkbox"/>	45	110	210	32	6
QR45X42	<input type="checkbox"/>	45	110	220	42	6
QR50X32	<input type="checkbox"/>	50	120	220	32	6
QR50X42	<input type="checkbox"/>	50	120	230	42	6
QR55	<input type="checkbox"/>	55	120	230	42	6
QR60	<input type="checkbox"/>	60	120	230	42	6

深彫り用



外径公差
 $\phi 6 \sim \phi 12$: 0 ~ -0.1
 $\phi 14 \sim \phi 16$: 0 ~ -0.15
 $\phi 18 \sim \phi 50$: 0 ~ -0.2 (mm)

h7

コバルトハイス ねじれ30°

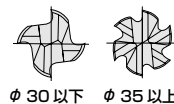

LQ センタカット

商品コード	在庫	寸法 (mm)				刃数
		外径	刃長	全長	シャンク径	
LQ6	<input type="checkbox"/>	6	15	95	6	4
LQ8	<input type="checkbox"/>	8	20	100	8	4
LQ10	<input type="checkbox"/>	10	25	125	10	4
LQ12	<input type="checkbox"/>	12	30	150	10	4
LQ14	<input type="checkbox"/>	14	35	150	12	4
LQ15	<input type="checkbox"/>	15	40	155	12	4
LQ16	<input type="checkbox"/>	16	40	155	12	4
LQ18	<input type="checkbox"/>	18	40	155	16	4
LQ20	<input type="checkbox"/>	20	45	185	16	4
LQ25	<input type="checkbox"/>	25	50	220	20	4
LQ30	<input type="checkbox"/>	30	55	220	25	4
LQ35	<input type="checkbox"/>	35	60	235	32	6
LQ40	<input type="checkbox"/>	40	65	285	32	6
LQ45	<input type="checkbox"/>	45	70	310	42	6
LQ50	<input type="checkbox"/>	50	70	310	42	6

GRQR、GQR、QS、QR、LQの対応被削材

炭素鋼 合金鋼 Carbon steel Alloy steel	炭素鋼 合金鋼 Pre-hardened steel ≤ 45HRC	高硬度 Hardened steel			ステン レス鋼 Stainless steel	チタン合金 耐熱合金 Titanium alloy Heat-resistant alloy	銅合金 Copper alloy	アルミ 合金 Aluminum alloy
		> 45HRC ≤ 55HRC	> 55HRC ≤ 65HRC	> 65HRC				
○					○	○	○	

HSS End Mills Stocked by Specified distributor

ラフィングエンドミル

ロング刃長



外径公差
 $\phi 6 \sim \phi 12$: 0 ~ -0.1
 $\phi 13 \sim \phi 16$: 0 ~ -0.15
 $\phi 17 \sim \phi 60$: 0 ~ -0.2



(mm)



$\phi 26$ 以下 $\phi 27 \sim \phi 36$ $\phi 38$ 以上

QL ○ ○ ○ × ○ ○ ○ ○ センタ穴付き



商品コード	在庫	寸法 (mm)				刃数	商品コード	在庫	寸法 (mm)				刃数
		外径	刃長	全長	シャンク径				外径	刃長	全長	シャンク径	
QL6X30	<input type="checkbox"/>	6	30	75	6	4	QL25X120	<input type="checkbox"/>	25	120	210	25	4
QL7X40	<input type="checkbox"/>	7	40	90	8	4	QL25X150	<input type="checkbox"/>	25	150	240	25	4
QL8X60	<input type="checkbox"/>	8	60	110	8	4	QL26X80	<input type="checkbox"/>	26	80	170	25	4
QL8X80	<input type="checkbox"/>	8	80	130	8	4	QL26X100	<input type="checkbox"/>	26	100	190	25	4
QL9X60	<input type="checkbox"/>	9	60	120	10	4	QL26X120	<input type="checkbox"/>	26	120	210	25	4
QL10X60	<input type="checkbox"/>	10	60	120	10	4	QL26X150	<input type="checkbox"/>	26	150	240	25	4
QL10X80	<input type="checkbox"/>	10	80	140	10	4	QL27X80	<input type="checkbox"/>	27	80	170	25	5
QL10X100	<input type="checkbox"/>	10	100	160	10	4	QL27X100	<input type="checkbox"/>	27	100	190	25	5
QL11X60	<input type="checkbox"/>	11	60	125	12	4	QL27X120	<input type="checkbox"/>	27	120	210	25	5
QL11X80	<input type="checkbox"/>	11	80	145	12	4	QL27X150	<input type="checkbox"/>	27	150	240	25	5
QL11X100	<input type="checkbox"/>	11	100	165	12	4	QL28X80	<input type="checkbox"/>	28	80	180	32	5
QL12X60	<input type="checkbox"/>	12	60	125	12	4	QL28X100	<input type="checkbox"/>	28	100	200	32	5
QL12X80	<input type="checkbox"/>	12	80	145	12	4	QL28X120	<input type="checkbox"/>	28	120	220	32	5
QL12X100	<input type="checkbox"/>	12	100	165	12	4	QL28X150	<input type="checkbox"/>	28	150	250	32	5
QL12X120	<input type="checkbox"/>	12	120	185	12	4	QL29X100	<input type="checkbox"/>	29	100	200	32	5
QL13X60	<input type="checkbox"/>	13	60	130	16	4	QL29X120	<input type="checkbox"/>	29	120	220	32	5
QL13X80	<input type="checkbox"/>	13	80	150	16	4	QL29X150	<input type="checkbox"/>	29	150	250	32	5
QL13X100	<input type="checkbox"/>	13	100	170	16	4	QL30X100	<input type="checkbox"/>	30	100	200	32	5
QL14X60	<input type="checkbox"/>	14	60	130	16	4	QL30X120	<input type="checkbox"/>	30	120	220	32	5
QL14X80	<input type="checkbox"/>	14	80	150	16	4	QL30X150	<input type="checkbox"/>	30	150	250	32	5
QL14X100	<input type="checkbox"/>	14	100	170	16	4	QL30X200	<input type="checkbox"/>	30	200	300	32	5
QL14X120	<input type="checkbox"/>	14	120	190	16	4	QL31X100	<input type="checkbox"/>	31	100	200	32	5
QL15X60	<input type="checkbox"/>	15	60	130	16	4	QL31X120	<input type="checkbox"/>	31	120	220	32	5
QL15X80	<input type="checkbox"/>	15	80	150	16	4	QL31X150	<input type="checkbox"/>	31	150	250	32	5
QL15X100	<input type="checkbox"/>	15	100	170	16	4	QL32X100	<input type="checkbox"/>	32	100	200	32	5
QL15X120	<input type="checkbox"/>	15	120	190	16	4	QL32X120	<input type="checkbox"/>	32	120	220	32	5
QL15X150	<input type="checkbox"/>	15	150	220	16	4	QL32X150	<input type="checkbox"/>	32	150	250	32	5
QL16X60	<input type="checkbox"/>	16	60	130	16	4	QL32X200	<input type="checkbox"/>	32	200	300	32	5
QL16X80	<input type="checkbox"/>	16	80	150	16	4	QL33X100	<input type="checkbox"/>	33	100	200	32	5
QL16X100	<input type="checkbox"/>	16	100	170	16	4	QL33X120	<input type="checkbox"/>	33	120	220	32	5
QL16X120	<input type="checkbox"/>	16	120	190	16	4	QL33X150	<input type="checkbox"/>	33	150	250	32	5
QL16X150	<input type="checkbox"/>	16	150	220	16	4	QL34X100	<input type="checkbox"/>	34	100	200	32	5
QL17X60	<input type="checkbox"/>	17	60	140	20	4	QL34X120	<input type="checkbox"/>	34	120	220	32	5
QL17X80	<input type="checkbox"/>	17	80	150	20	4	QL34X150	<input type="checkbox"/>	34	150	250	32	5
QL17X100	<input type="checkbox"/>	17	100	170	20	4	QL35X100	<input type="checkbox"/>	35	100	200	42	5
QL17X120	<input type="checkbox"/>	17	120	190	20	4	QL35X120	<input type="checkbox"/>	35	120	230	42	5
QL18X60	<input type="checkbox"/>	18	60	140	20	4	QL35X150	<input type="checkbox"/>	35	150	260	42	5
QL18X80	<input type="checkbox"/>	18	80	160	20	4	QL35X200	<input type="checkbox"/>	35	200	310	42	5
QL18X100	<input type="checkbox"/>	18	100	180	20	4	QL36X120	<input type="checkbox"/>	36	120	230	42	5
QL18X120	<input type="checkbox"/>	18	120	200	20	4	QL36X150	<input type="checkbox"/>	36	150	260	42	5
QL18X150	<input type="checkbox"/>	18	150	230	20	4	QL36X200	<input type="checkbox"/>	36	200	310	42	5
QL19X60	<input type="checkbox"/>	19	60	140	20	4	QL38X120	<input type="checkbox"/>	38	120	230	42	6
QL19X80	<input type="checkbox"/>	19	80	160	20	4	QL38X150	<input type="checkbox"/>	38	150	260	42	6
QL19X100	<input type="checkbox"/>	19	100	180	20	4	QL38X200	<input type="checkbox"/>	38	200	310	42	6
QL19X120	<input type="checkbox"/>	19	120	200	20	4	QL40X120	<input type="checkbox"/>	40	120	230	42	6
QL20X60	<input type="checkbox"/>	20	60	140	20	4	QL40X150	<input type="checkbox"/>	40	150	260	42	6
QL20X80	<input type="checkbox"/>	20	80	160	20	4	QL40X200	<input type="checkbox"/>	40	200	310	42	6
QL20X100	<input type="checkbox"/>	20	100	180	20	4	QL40X250	<input type="checkbox"/>	40	250	360	42	6
QL20X120	<input type="checkbox"/>	20	120	200	20	4	QL40X300	<input type="checkbox"/>	40	300	410	42	6
QL20X150	<input type="checkbox"/>	20	150	230	20	4	QL42X150	<input type="checkbox"/>	42	150	260	42	6
QL21X80	<input type="checkbox"/>	21	80	170	25	4	QL42X200	<input type="checkbox"/>	42	200	310	42	6
QL21X100	<input type="checkbox"/>	21	100	190	25	4	QL42X250	<input type="checkbox"/>	42	250	360	42	6
QL21X120	<input type="checkbox"/>	21	120	210	25	4	QL45X150	<input type="checkbox"/>	45	150	260	42	6
QL22X80	<input type="checkbox"/>	22	80	170	25	4	QL45X200	<input type="checkbox"/>	45	200	310	42	6
QL22X100	<input type="checkbox"/>	22	100	190	25	4	QL45X205	<input type="checkbox"/>	45	205	320	42	6
QL22X120	<input type="checkbox"/>	22	120	210	25	4	QL45X250	<input type="checkbox"/>	45	250	360	42	6
QL22X150	<input type="checkbox"/>	22	150	240	25	4	QL45X300	<input type="checkbox"/>	45	300	410	42	6
QL23X80	<input type="checkbox"/>	23	80	170	25	4	QL50X150	<input type="checkbox"/>	50	150	260	42	6
QL23X100	<input type="checkbox"/>	23	100	190	25	4	QL50X155	<input type="checkbox"/>	50	155	280	42	6
QL23X120	<input type="checkbox"/>	23	120	210	25	4	QL50X200	<input type="checkbox"/>	50	200	310	42	6
QL23X150	<input type="checkbox"/>	23	150	240	25	4	QL50X205	<input type="checkbox"/>	50	205	320	42	6
QL24X80	<input type="checkbox"/>	24	80	170	25	4	QL50X250	<input type="checkbox"/>	50	250	360	42	6
QL24X100	<input type="checkbox"/>	24	100	190	25	4	QL50X300	<input type="checkbox"/>	50	300	410	42	6
QL24X120	<input type="checkbox"/>	24	120	210	25	4	QL60X150	<input type="checkbox"/>	60	150	270	42	6
QL24X150	<input type="checkbox"/>	24	150	240	25	4	QL60X200	<input type="checkbox"/>	60	200	320	42	6
QL25X80	<input type="checkbox"/>	25	80	170	25	4	QL60X250	<input type="checkbox"/>	60	250	370	42	6
QL25X100	<input type="checkbox"/>	25	100	190	25	4	QL60X300	<input type="checkbox"/>	60	300	420	42	6

ラフィング刃形ダイナミル



外径公差
 0 ~ -0.2



(mm)



$\phi 35$ 以下 $\phi 40$ 以上



ボール

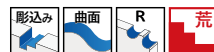

(mm)



R17.5以下 R20以上



DSQ ○ ○ ○ × ○ ○ ○ ○

商品コード	在庫	寸法 (mm)				刃数
		外径	刃長	全長	シャンク径	
DSQ30×55	<input type="checkbox"/>	30	55	135	32	5
DSQ30×90	<input type="checkbox"/>	30	90	170	32	5
DSQ30×120	<input type="checkbox"/>	30	120	200	32	5
DSQ35×75	<input type="checkbox"/>	35	75	155	32	5
DSQ35×100	<input type="checkbox"/>	35	100	180	32	5
DSQ35×125	<input type="checkbox"/>	35	125	205	32	5
DSQ40×75	<input type="checkbox"/>	40	75	155	32	6
DSQ40×100	<input type="checkbox"/>	40	100	180	32	6
DSQ40×125	<input type="checkbox"/>	40	125	205	32	6
DSQ45×100	<input type="checkbox"/>	45	100	195	50.8	6
DSQ45×125	<input type="checkbox"/>	45	125	220	50.8	6
DSQ45×150	<input type="checkbox"/>	45	155	245	50.8	6
DSQ50×75	<input type="checkbox"/>	50	75	170	50.8	6
DSQ50×100	<input type="checkbox"/>	50	100	195	50.8	6
DSQ50×125	<input type="checkbox"/>	50	125	220	50.8	6
DSQ50×150	<input type="checkbox"/>	50	150	245	50.8	6
DSQ50×200	<input type="checkbox"/>	50	200	295	50.8	6
DSQ50×255	<input type="checkbox"/>	50	255	350	50.8	6
DSQ50×305	<input type="checkbox"/>	50	305	400	50.8	6
DSQ60×100	<input type="checkbox"/>	60	100	195	50.8	6
DSQ60×125	<input type="checkbox"/>	60	125	220	50.8	6
DSQ60×150	<input type="checkbox"/>	60	150	245	50.8	6
DSQ60×200	<input type="checkbox"/>	60	200	295	50.8	6
DSQ60×255	<input type="checkbox"/>	60	255	350	50.8	6
DSQ60×305	<input type="checkbox"/>	60	305	400	50.8	6
DSQ70×100	<input type="checkbox"/>	70	100	195	50.8	6
DSQ70×125	<input type="checkbox"/>	70	125	220	50.8	6
DSQ70×150	<input type="checkbox"/>	70	150	245	50.8	6
DSQ75×50	<input type="checkbox"/>	75	50	145	50.8	8
DSQ75×100	<input type="checkbox"/>	75	100	195	50.8	8
DSQ100×50	<input type="checkbox"/>	100	50	145	50.8	10
DSQ100×100	<input type="checkbox"/>	100	100	195	50.8	10

QB ○ ○ ○ . ○ R

商品コード	在庫	寸法 (mm)				刃数
		ボール径	刃長	全長	シャンク径	
QB3R	<input type="checkbox"/>	3	15	100	6	4
QB4R	<input type="checkbox"/>	4	20	110	8	4
QB5R	<input type="checkbox"/>	5	25	125	10	4
QB6R	<input type="checkbox"/>	6	30	140	12	4
QB7R	<input type="checkbox"/>	7	35	140	12	4
QB7.5R	<input type="checkbox"/>	7.5	40	140	16	4
QB8R	<input type="checkbox"/>	8	40	160	16	4
QB9R	<input type="checkbox"/>	9	40	160	16	4
QB10R	<input type="checkbox"/>	10	45	180		

ラフィングエンドミル ESMキー溝用エンドミル

ラフィング刃形サイドロックミル



外径公差 0~-0.2 h6 (mm)

コバルトハイス 傾斜30° HSS-Co Helix angle



SRQ○○×○○○

商品コード	在庫	寸法 (mm)				刃数
		外径	刃長	全長	シャンク径	
SRQ20×45	<input type="checkbox"/>	20	45	110	25	4
SRQ20×75	<input type="checkbox"/>	20	75	140	25	4
SRQ20×100	<input type="checkbox"/>	20	100	165	25	4
SRQ22×45	<input type="checkbox"/>	22	45	110	25	4
SRQ22×75	<input type="checkbox"/>	22	75	140	25	4
SRQ22×100	<input type="checkbox"/>	22	100	165	25	4
SRQ25×50	<input type="checkbox"/>	25	50	115	25	4
SRQ25×90	<input type="checkbox"/>	25	90	155	25	4
SRQ25×120	<input type="checkbox"/>	25	120	185	25	4
SRQ28×55	<input type="checkbox"/>	28	55	120	25	5
SRQ28×90	<input type="checkbox"/>	28	90	155	25	5
SRQ28×120	<input type="checkbox"/>	28	120	185	25	5
SRQ30×55	<input type="checkbox"/>	30	55	120	25	5
SRQ30×90	<input type="checkbox"/>	30	90	155	25	5
SRQ30×120	<input type="checkbox"/>	30	120	185	25	5

プラス公差



外径公差 +0.02~0 h7 (mm)

粉末ハイス 傾斜15° Powdered HSS Helix angle



ESMKH○○○

商品コード	在庫	寸法 (mm)			
		外径	刃長	全長	シャンク径
ESMKH3	<input type="checkbox"/>	3	5	55	10
ESMKH4	<input type="checkbox"/>	4	6	55	10
ESMKH5	<input type="checkbox"/>	5	8	55	10
ESMKH6	<input type="checkbox"/>	6	10	55	10
ESMKH7	<input type="checkbox"/>	7	10	55	10
ESMKH8	<input type="checkbox"/>	8	12	55	10
ESMKH9	<input type="checkbox"/>	9	12	65	12
ESMKH10	<input type="checkbox"/>	10	15	65	12
ESMKH12	<input type="checkbox"/>	12	15	70	12
ESMKH14	<input type="checkbox"/>	14	15	75	16
ESMKH15	<input type="checkbox"/>	15	15	75	16
ESMKH16	<input type="checkbox"/>	16	18	80	16
ESMKH18	<input type="checkbox"/>	18	18	80	20
ESMKH20	<input type="checkbox"/>	20	20	85	20

マイナス公差



外径公差 -0.02~-0.04 h7 (mm)

粉末ハイス 傾斜15° Powdered HSS Helix angle



ESMKNN○○○

商品コード	在庫	寸法 (mm)			
		外径	刃長	全長	シャンク径
ESMKNN3	<input type="checkbox"/>	3	5	55	10
ESMKNN4	<input type="checkbox"/>	4	6	55	10
ESMKNN5	<input type="checkbox"/>	5	8	55	10
ESMKNN6	<input type="checkbox"/>	6	10	55	10
ESMKNN7	<input type="checkbox"/>	7	10	55	10
ESMKNN8	<input type="checkbox"/>	8	12	55	10
ESMKNN9	<input type="checkbox"/>	9	12	65	12
ESMKNN10	<input type="checkbox"/>	10	15	65	12
ESMKNN12	<input type="checkbox"/>	12	15	70	12
ESMKNN14	<input type="checkbox"/>	14	15	75	16
ESMKNN15	<input type="checkbox"/>	15	15	75	16
ESMKNN16	<input type="checkbox"/>	16	18	80	16
ESMKNN18	<input type="checkbox"/>	18	18	80	20
ESMKNN20	<input type="checkbox"/>	20	20	85	20

マイナス公差



外径公差 0~-0.02 h7 (mm)

粉末ハイス 傾斜15° Powdered HSS Helix angle



ESMKN○○○

商品コード	在庫	寸法 (mm)			
		外径	刃長	全長	シャンク径
ESMKN3	<input type="checkbox"/>	3	5	55	10
ESMKN4	<input type="checkbox"/>	4	6	55	10
ESMKN5	<input type="checkbox"/>	5	8	55	10
ESMKN6	<input type="checkbox"/>	6	10	55	10
ESMKN7	<input type="checkbox"/>	7	10	55	10
ESMKN8	<input type="checkbox"/>	8	12	55	10
ESMKN9	<input type="checkbox"/>	9	12	65	12
ESMKN10	<input type="checkbox"/>	10	15	65	12
ESMKN12	<input type="checkbox"/>	12	15	70	12
ESMKN14	<input type="checkbox"/>	14	15	75	16
ESMKN15	<input type="checkbox"/>	15	15	75	16
ESMKN16	<input type="checkbox"/>	16	18	80	16
ESMKN18	<input type="checkbox"/>	18	18	80	20
ESMKN20	<input type="checkbox"/>	20	20	85	20

強ねじれエンドミル

高リード刃形ダイナミル



外径公差 ±0.05 h5 (mm)

コバルトハイス 傾斜45°



DSH○○○×○○○

商品コード	在庫	寸法 (mm)				刃数
		外径	刃長	全長	シャンク径	
DSH30×55	<input type="checkbox"/>	30	55	135	32	4
DSH30×90	<input type="checkbox"/>	30	90	170	32	4
DSH35×75	<input type="checkbox"/>	35	75	155	32	4
DSH35×100	<input type="checkbox"/>	35	100	180	32	4
DSH40×75	<input type="checkbox"/>	40	75	155	32	4
DSH40×100	<input type="checkbox"/>	40	100	180	32	4
DSH45×100	<input type="checkbox"/>	45	100	195	50.8	4
DSH45×125	<input type="checkbox"/>	45	125	220	50.8	4
DSH50×75	<input type="checkbox"/>	50	75	170	50.8	4
DSH50×100	<input type="checkbox"/>	50	100	195	50.8	4
DSH50×125	<input type="checkbox"/>	50	125	220	50.8	4
DSH50×150	<input type="checkbox"/>	50	150	245	50.8	4
DSH50×200	<input type="checkbox"/>	50	200	295	50.8	4
DSH60×100	<input type="checkbox"/>	60	100	195	50.8	4
DSH60×125	<input type="checkbox"/>	60	125	220	50.8	4
DSH60×150	<input type="checkbox"/>	60	150	245	50.8	4
DSH70×100	<input type="checkbox"/>	70	100	195	50.8	4
DSH70×125	<input type="checkbox"/>	70	125	220	50.8	4
DSH70×150	<input type="checkbox"/>	70	150	245	50.8	4
DSH75×50	<input type="checkbox"/>	75	50	145	50.8	6
DSH75×100	<input type="checkbox"/>	75	100	195	50.8	6
DSH100×50	<input type="checkbox"/>	100	50	145	50.8	6
DSH100×100	<input type="checkbox"/>	100	100	195	50.8	6

ヘリカル60



外径公差 ±0.05 h7 (mm)

コバルトハイス 傾斜55°

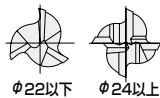

HN○○○

商品コード	在庫	寸法 (mm)				
		外径	刃長	全長	シャンク径	
HN6	<input type="checkbox"/>	6	15	70	8	3
HN8	<input type="checkbox"/>	8	20	75	10	3
HN10	<input type="checkbox"/>	10	25	90	12	3
HN12	<input type="checkbox"/>	12	30	95	12	3
HN14	<input type="checkbox"/>	14	35	105	16	3
HN15	<input type="checkbox"/>	15	40	115	16	3
HN16	<input type="checkbox"/>	16	40	115	16	3
HN18	<input type="checkbox"/>	18	40	120	20	3
HN20	<input type="checkbox"/>	20	45	130	20	3
HN22	<input type="checkbox"/>	22	45	130	25	3
HN24	<input type="checkbox"/>	24	50	140	25	4
HN25	<input type="checkbox"/>	25	50	140	25	4
HN28	<input type="checkbox"/>	28	55	150	32	4
HN30	<input type="checkbox"/>	30	55	150	32	4

SRQ、ESMK、ESMKN、ESMKNN、DSH、HNの対応被削材

炭素鋼 合金鋼 Carbon steel Alloy steel	炭素鋼 合金鋼 Pre-hardened steel ≤ 45HRC	高硬度 Hardened steel			ステン レス鋼 Stainless steel	チタン合金 耐熱合金 Titanium alloy Heat-resistant alloy	銅合金 Copper alloy	アルミ 合金 Aluminum alloy
		> 45HRC ≤ 55HRC	> 55HRC ≤ 65HRC	> 65HRC				
○					○	○	○	

HSS End Mills Stocked by Specified distributor

ESM テーパーエンドミル

スタブ刃長



外径公差 0~-0.03

h7

(mm)



2枚刃・ショート刃長



外径公差 0~-0.03

h7

(mm)



片角公差: ±5'

2ESMTT

粉末ハイス 傾斜25°

商品コード	在庫	寸法 (mm)				
		外径	刃径	刃長	全長	シャンク径
2ESMTT1×0.5	<input type="checkbox"/>	1	30'	2.5	47	6
2ESMTT1×0.75	<input type="checkbox"/>	1	45'	2.5	47	6
2ESMTT1×1	<input type="checkbox"/>	1	1°	3.5	48	6
2ESMTT1×1.25	<input type="checkbox"/>	1	1° 15'	3.5	48	6
2ESMTT1×1.5	<input type="checkbox"/>	1	1° 30'	3.5	48	6
2ESMTT1×1.75	<input type="checkbox"/>	1	1° 45'	3.5	48	6
2ESMTT1×2	<input type="checkbox"/>	1	2°	4	48	6
2ESMTT1×2.25	<input type="checkbox"/>	1	2° 15'	4	48	6
2ESMTT1×2.5	<input type="checkbox"/>	1	2° 30'	4	48	6
2ESMTT1×2.75	<input type="checkbox"/>	1	2° 45'	4	48	6
2ESMTT1×3	<input type="checkbox"/>	1	3°	4	48	6
2ESMTT1.5×0.5	<input type="checkbox"/>	1.5	30'	3	47	6
2ESMTT1.5×0.75	<input type="checkbox"/>	1.5	45'	3	47	6
2ESMTT1.5×1	<input type="checkbox"/>	1.5	1°	4	48	6
2ESMTT1.5×1.25	<input type="checkbox"/>	1.5	1° 15'	4	48	6
2ESMTT1.5×1.5	<input type="checkbox"/>	1.5	1° 30'	4	48	6
2ESMTT1.5×1.75	<input type="checkbox"/>	1.5	1° 45'	4	48	6
2ESMTT1.5×2	<input type="checkbox"/>	1.5	2°	5	49	6
2ESMTT1.5×2.25	<input type="checkbox"/>	1.5	2° 15'	5	49	6
2ESMTT1.5×2.5	<input type="checkbox"/>	1.5	2° 30'	5	49	6
2ESMTT1.5×2.75	<input type="checkbox"/>	1.5	2° 45'	5	49	6
2ESMTT1.5×3	<input type="checkbox"/>	1.5	3°	5	49	6
2ESMTT2×0.5	<input type="checkbox"/>	2	30'	5	49	6
2ESMTT2×0.75	<input type="checkbox"/>	2	45'	5	49	6
2ESMTT2×1	<input type="checkbox"/>	2	1°	7	51	6
2ESMTT2×1.25	<input type="checkbox"/>	2	1° 15'	7	51	6
2ESMTT2×1.5	<input type="checkbox"/>	2	1° 30'	7	51	6
2ESMTT2×1.75	<input type="checkbox"/>	2	1° 45'	7	51	6
2ESMTT2×2	<input type="checkbox"/>	2	2°	9	53	6
2ESMTT2×2.25	<input type="checkbox"/>	2	2° 15'	9	53	6
2ESMTT2×2.5	<input type="checkbox"/>	2	2° 30'	9	53	6
2ESMTT2×2.75	<input type="checkbox"/>	2	2° 45'	9	53	6
2ESMTT2×3	<input type="checkbox"/>	2	3°	9	53	6
2ESMTT2.5×0.5	<input type="checkbox"/>	2.5	30'	5	49	6
2ESMTT2.5×0.75	<input type="checkbox"/>	2.5	45'	5	49	6
2ESMTT2.5×1	<input type="checkbox"/>	2.5	1°	7	51	6
2ESMTT2.5×1.25	<input type="checkbox"/>	2.5	1° 15'	7	51	6
2ESMTT2.5×1.5	<input type="checkbox"/>	2.5	1° 30'	7	51	6
2ESMTT2.5×1.75	<input type="checkbox"/>	2.5	1° 45'	7	51	6
2ESMTT2.5×2	<input type="checkbox"/>	2.5	2°	9	53	6
2ESMTT2.5×2.25	<input type="checkbox"/>	2.5	2° 15'	9	53	6
2ESMTT2.5×2.5	<input type="checkbox"/>	2.5	2° 30'	9	53	6
2ESMTT2.5×2.75	<input type="checkbox"/>	2.5	2° 45'	9	53	6
2ESMTT2.5×3	<input type="checkbox"/>	2.5	3°	9	53	6
2ESMTT3×0.5	<input type="checkbox"/>	3	30'	6	50	6
2ESMTT3×0.75	<input type="checkbox"/>	3	45'	6	50	6
2ESMTT3×1	<input type="checkbox"/>	3	1°	8	52	6
2ESMTT3×1.25	<input type="checkbox"/>	3	1° 15'	8	52	6
2ESMTT3×1.5	<input type="checkbox"/>	3	1° 30'	8	52	6
2ESMTT3×1.75	<input type="checkbox"/>	3	1° 45'	8	52	6
2ESMTT3×2	<input type="checkbox"/>	3	2°	11	55	6
2ESMTT3×2.25	<input type="checkbox"/>	3	2° 15'	11	55	6
2ESMTT3×2.5	<input type="checkbox"/>	3	2° 30'	11	55	6
2ESMTT3×2.75	<input type="checkbox"/>	3	2° 45'	11	55	6
2ESMTT3×3	<input type="checkbox"/>	3	3°	11	55	6
2ESMTT4×0.5	<input type="checkbox"/>	4	30'	8	52	6
2ESMTT4×0.75	<input type="checkbox"/>	4	45'	8	52	6

商品コード	在庫	寸法 (mm)				
		外径	刃径	刃長	全長	シャンク径
2ESMTT4×1	<input type="checkbox"/>	4	1°	11	55	6
2ESMTT4×1.25	<input type="checkbox"/>	4	1° 15'	11	55	6
2ESMTT4×1.5	<input type="checkbox"/>	4	1° 30'	11	55	6
2ESMTT4×1.75	<input type="checkbox"/>	4	1° 45'	11	55	6
2ESMTT4×2	<input type="checkbox"/>	4	2°	15	59	6
2ESMTT4×2.25	<input type="checkbox"/>	4	2° 15'	15	59	6
2ESMTT4×2.5	<input type="checkbox"/>	4	2° 30'	15	59	6
2ESMTT4×2.75	<input type="checkbox"/>	4	2° 45'	15	59	6
2ESMTT4×3	<input type="checkbox"/>	4	3°	15	59	6

2ESMTS

商品コード	在庫	寸法 (mm)					
		外径	刃径	刃長	大端径	全長	シャンク径
2ESMTS2×0.5	<input type="checkbox"/>	2	30'	10	2.17	54	6
2ESMTS2×0.75	<input type="checkbox"/>	2	45'	10	2.26	54	6
2ESMTS2×1	<input type="checkbox"/>	2	1°	13	2.45	57	6
2ESMTS2×1.25	<input type="checkbox"/>	2	1° 15'	13	2.57	57	6
2ESMTS2×1.5	<input type="checkbox"/>	2	1° 30'	13	2.68	57	6
2ESMTS2×1.75	<input type="checkbox"/>	2	1° 45'	13	2.79	57	6
2ESMTS2×2	<input type="checkbox"/>	2	2°	18	3.26	62	6
2ESMTS2×2.25	<input type="checkbox"/>	2	2° 15'	18	3.41	62	6
2ESMTS2×2.5	<input type="checkbox"/>	2	2° 30'	18	3.57	62	6
2ESMTS2×2.75	<input type="checkbox"/>	2	2° 45'	18	3.73	62	6
2ESMTS2×3	<input type="checkbox"/>	2	3°	18	3.89	62	6
2ESMTS2.5×0.5	<input type="checkbox"/>	2.5	30'	10	2.67	54	6
2ESMTS2.5×0.75	<input type="checkbox"/>	2.5	45'	10	2.76	54	6
2ESMTS2.5×1	<input type="checkbox"/>	2.5	1°	13	2.95	57	6
2ESMTS2.5×1.25	<input type="checkbox"/>	2.5	1° 15'	13	3.07	57	6
2ESMTS2.5×1.5	<input type="checkbox"/>	2.5	1° 30'	13	3.18	57	6
2ESMTS2.5×1.75	<input type="checkbox"/>	2.5	1° 45'	13	3.29	57	6
2ESMTS2.5×2	<input type="checkbox"/>	2.5	2°	18	3.76	62	6
2ESMTS2.5×2.25	<input type="checkbox"/>	2.5	2° 15'	18	3.91	62	6
2ESMTS2.5×2.5	<input type="checkbox"/>	2.5	2° 30'	18	4.07	62	6
2ESMTS2.5×2.75	<input type="checkbox"/>	2.5	2° 45'	18	4.23	62	6
2ESMTS2.5×3	<input type="checkbox"/>	2.5	3°	18	4.39	62	6
2ESMTS2.5×4	<input type="checkbox"/>	2.5	4°	18	5.02	62	6
2ESMTS2.5×5	<input type="checkbox"/>	2.5	5°	18	5.65	62	6
2ESMTS2.5×7	<input type="checkbox"/>	2.5	7°	24	8.39	74	10
2ESMTS2.5×10	<input type="checkbox"/>	2.5	10°	24	10.96	81	12
2ESMTS3×0.5	<input type="checkbox"/>	3	30'	10	3.17	54	6
2ESMTS3×0.75	<input type="checkbox"/>	3	45'	10	3.26	54	6
2ESMTS3×1	<input type="checkbox"/>	3	1°	13	3.45	57	6
2ESMTS3×1.25	<input type="checkbox"/>	3	1° 15'	13	3.57	57	6
2ESMTS3×1.5	<input type="checkbox"/>	3	1° 30'	13	3.68	57	6
2ESMTS3×1.75	<input type="checkbox"/>	3	1° 45'	13	3.79	57	6
2ESMTS3×2	<input type="checkbox"/>	3	2°	18	4.26	62	6
2ESMTS3×2.25	<input type="checkbox"/>	3	2° 15'	18	4.41	62	6
2ESMTS3×2.5	<input type="checkbox"/>	3	2° 30'	18	4.57	62	6
2ESMTS3×2.75	<input type="checkbox"/>	3	2° 45'	18	4.73	62	6
2ESMTS3×3	<input type="checkbox"/>	3	3°	18	4.89	62	6
2ESMTS3×4	<input type="checkbox"/>	3	4°	18	5.52	62	6
2ESMTS3×5	<input type="checkbox"/>	3	5°	18	6.15	62	8
2ESMTS3×7	<input type="checkbox"/>	3	7°	24	8.89	74	10
2ESMTS3×10	<input type="checkbox"/>	3	10°	24	11.46	81	12
2ESMTS4×0.5	<input type="checkbox"/>	4	30'	12	4.21	56	6
2ESMTS4×0.75	<input type="checkbox"/>	4	45'	12	4.31	56	6
2ESMTS4×1	<input type="checkbox"/>	4	1°	16	4.56	60	6
2ESMTS4×1.25	<input type="checkbox"/>	4	1° 15'	16	4.70	60	6
2ESMTS4×1.5	<input type="checkbox"/>	4	1° 30'	16	4.84	60	6
2ESMTS4×1.75	<input type="checkbox"/>	4	1° 45'	16	4.98	60	6
2ESMTS4×2	<input type="checkbox"/>	4	2°	21	5.47	65	6
2ESMTS4×2.25	<input type="checkbox"/>	4	2° 15'	21	5.65	65	6
2ESMTS4×2.5	<input type="checkbox"/>	4	2° 30'	21	5.83	65	6
2ESMTS4×2.75	<input type="checkbox"/>	4	2° 45'	21	6.02	65	8
2ESMTS4×3	<input type="checkbox"/>	4	3°	21	6.20	65	8
2ESMTS4×4	<input type="checkbox"/>	4	4°	21	6.94	65	8
2ESMTS4×5	<input type="checkbox"/>	4	5°	21	7.67	65	8
2ESMTS4×7	<input type="checkbox"/>	4	7°	28	10.88	85	12
2ESMTS4×10	<input type="checkbox"/>	4	10°	28	13.87	85	12
2ESMTS5×0.5	<input type="checkbox"/>	5	30'	14	5.74	58	6

□印：特定代理店在庫です。弊社営業へお問合せください。 □：Stocked by specified distributor. Contact with our sales department.

4枚刃・ショート刃長



外径公差
0~-0.03



(mm)

片角公差: ±5°



粉末
ハイス



切削
条件表

H86

4ESMTS

粉末
ハイス



切削
条件表

H86

商品コード	在庫	寸法 (mm)					
		外径	逃げ-径	刃長	大端径	全長	
2ESMTS5×0.75	□	5	45'	14	5.37	58	6
2ESMTS5×1	□	5	1°	19	5.66	63	6
2ESMTS5×1.25	□	5	1° 15'	19	5.83	63	6
2ESMTS5×1.5	□	5	1° 30'	19	6.00	63	6
2ESMTS5×1.75	□	5	1° 45'	19	6.16	63	6
2ESMTS5×2	□	5	2°	25	6.75	69	8
2ESMTS5×2.25	□	5	2° 15'	25	6.96	69	8
2ESMTS5×2.5	□	5	2° 30'	25	7.18	69	8
2ESMTS5×2.75	□	5	2° 45'	25	7.40	69	8
2ESMTS5×3	□	5	3°	25	7.62	69	8
2ESMTS5×4	□	5	4°	25	8.50	75	10
2ESMTS5×5	□	5	5°	25	9.37	75	10
2ESMTS5×7	□	5	7°	34	13.35	91	12
2ESMTS5×10	□	5	10°	34	16.99	94	16
2ESMTS6×0.5	□	6	30'	14	6.24	58	8
2ESMTS6×0.75	□	6	45'	14	6.37	58	8
2ESMTS6×1	□	6	1°	19	6.66	63	8
2ESMTS6×1.25	□	6	1° 15'	19	6.83	63	8
2ESMTS6×1.5	□	6	1° 30'	19	7.00	63	8
2ESMTS6×1.75	□	6	1° 45'	19	7.16	63	8
2ESMTS6×2	□	6	2°	25	7.45	69	8
2ESMTS6×2.25	□	6	2° 15'	25	7.97	75	10
2ESMTS6×2.5	□	6	2° 30'	25	8.18	75	10
2ESMTS6×2.75	□	6	2° 45'	25	8.40	75	10
2ESMTS6×3	□	6	3°	25	8.62	75	10
2ESMTS6×4	□	6	4°	25	9.50	75	10
2ESMTS6×5	□	6	5°	25	10.37	82	12
2ESMTS6×7	□	6	7°	34	14.35	91	12
2ESMTS6×10	□	6	10°	34	17.99	94	16
2ESMTS8×0.5	□	8	30'	17	8.30	67	10
2ESMTS8×1	□	8	1°	22	8.77	72	10
2ESMTS8×1.5	□	8	1° 30'	22	9.15	72	10
2ESMTS8×1.75	□	8	1° 45'	22	9.34	72	10
2ESMTS8×2	□	8	2°	30	10.10	87	12
2ESMTS8×2.25	□	8	2° 15'	30	10.36	87	12
2ESMTS8×2.5	□	8	2° 30'	30	10.62	87	12
2ESMTS8×2.75	□	8	2° 45'	30	10.88	87	12
2ESMTS8×3	□	8	3°	30	11.14	87	12
2ESMTS8×4	□	8	4°	30	12.20	87	12
2ESMTS8×5	□	8	5°	30	13.25	87	12
2ESMTS10×0.5	□	10	30'	17	10.30	74	12
2ESMTS10×1	□	10	1°	22	10.77	79	12
2ESMTS10×1.5	□	10	1° 30'	22	11.15	79	12
2ESMTS10×1.75	□	10	1° 45'	22	11.34	79	12
2ESMTS10×2	□	10	2°	30	12.10	87	12
2ESMTS10×2.25	□	10	2° 15'	30	12.36	87	12
2ESMTS10×2.5	□	10	2° 30'	30	12.62	87	12
2ESMTS10×2.75	□	10	2° 45'	30	12.88	87	12
2ESMTS10×3	□	10	3°	30	13.14	87	12
2ESMTS10×4	□	10	4°	30	14.20	87	12
2ESMTS10×5	□	10	5°	30	15.25	90	16

商品コード	在庫	寸法 (mm)					
		外径	逃げ-径	刃長	大端径	全長	
4ESMTS2×0.5	□	2	30'	10	2.17	54	6
4ESMTS2×0.75	□	2	45'	10	2.26	54	6
4ESMTS2×1	□	2	1°	13	2.45	57	6
4ESMTS2×1.25	□	2	1° 15'	13	2.57	57	6
4ESMTS2×1.5	□	2	1° 30'	13	2.68	57	6
4ESMTS2×1.75	□	2	1° 45'	13	2.79	57	6
4ESMTS2×2	□	2	2°	18	3.26	62	6
4ESMTS2×2.25	□	2	2° 15'	18	3.41	62	6
4ESMTS2×2.5	□	2	2° 30'	18	3.57	62	6
4ESMTS2×2.75	□	2	2° 45'	18	3.73	62	6
4ESMTS2×3	□	2	3°	18	3.89	62	6
4ESMTS2.5×0.5	□	2.5	30'	10	2.67	54	6
4ESMTS2.5×0.75	□	2.5	45'	10	2.76	54	6
4ESMTS2.5×1	□	2.5	1°	13	2.95	57	6
4ESMTS2.5×1.25	□	2.5	1° 15'	13	3.07	57	6
4ESMTS2.5×1.5	□	2.5	1° 30'	13	3.18	57	6
4ESMTS2.5×1.75	□	2.5	1° 45'	13	3.29	57	6
4ESMTS2.5×2	□	2.5	2°	18	3.76	62	6
4ESMTS2.5×2.25	□	2.5	2° 15'	18	3.91	62	6
4ESMTS2.5×2.5	□	2.5	2° 30'	18	4.07	62	6
4ESMTS2.5×2.75	□	2.5	2° 45'	18	4.23	62	6
4ESMTS2.5×3	□	2.5	3°	18	4.39	62	6
4ESMTS2.5×4	□	2.5	4°	18	5.02	62	6
4ESMTS2.5×5	□	2.5	5°	18	5.65	62	6
4ESMTS2.5×7	□	2.5	7°	24	8.39	74	10
4ESMTS2.5×10	□	2.5	10°	24	10.96	81	12
4ESMTS3×0.5	□	3	30'	10	3.17	54	6
4ESMTS3×0.75	□	3	45'	10	3.26	54	6
4ESMTS3×1	□	3	1°	13	3.45	57	6
4ESMTS3×1.25	□	3	1° 15'	13	3.57	57	6
4ESMTS3×1.5	□	3	1° 30'	13	3.68	57	6
4ESMTS3×1.75	□	3	1° 45'	13	3.79	57	6
4ESMTS3×2	□	3	2°	18	4.26	62	6
4ESMTS3×2.25	□	3	2° 15'	18	4.41	62	6
4ESMTS3×2.5	□	3	2° 30'	18	4.57	62	6
4ESMTS3×2.75	□	3	2° 45'	18	4.73	62	6
4ESMTS3×3	□	3	3°	18	4.89	62	6
4ESMTS3×4	□	3	4°	18	5.52	62	6
4ESMTS3×5	□	3	5°	18	6.15	62	8
4ESMTS3×7	□	3	7°	24	8.89	74	10
4ESMTS3×10	□	3	10°	24	11.46	81	12
4ESMTS4×0.5	□	4	30'	12	4.21	56	6
4ESMTS4×0.75	□	4	45'	12	4.31	56	6
4ESMTS4×1	□	4	1°	16	4.56	60	6
4ESMTS4×1.25	□	4	1° 15'	16	4.70	60	6
4ESMTS4×1.5	□	4	1° 30'	16	4.84	60	6
4ESMTS4×1.75	□	4	1° 45'	16	4.98	60	6
4ESMTS4×2	□	4	2°	21	5.47	65	6
4ESMTS4×2.25	□	4	2° 15'	21	5.65	65	6
4ESMTS4×2.5	□	4	2° 30'	21	5.83	65	6
4ESMTS4×2.75	□	4	2° 45'	21	6.02	65	8
4ESMTS4×3	□	4	3°	21	6.20	65	8
4ESMTS4×4	□	4	4°	21	6.94	65	8
4ESMTS4×5	□	4	5°	21	7.67	65	8
4ESMTS4×7	□	4	7°	28	10.88	85	12
4ESMTS4×10	□	4	10°	28	13.87	85	12
4ESMTS5×0.5	□	5	30'	14	5.24	58	6

商品コード	在庫	寸法 (mm)					
		外径	逃げ-径	刃長	大端径	全長	
4ESMTS5×0.75	□	5	45'	14	5.37	58	6
4ESMTS5×1	□	5	1°	19	5.66	63	6
4ESMTS5×1.25	□	5	1° 15'	19	5.83	63	6
4ESMTS5×1.5	□	5	1° 30'	19	6.00	63	6
4ESMTS5×1.75	□	5	1° 45'	19	6.16	63	6
4ESMTS5×2	□	5	2°	25	6.75	69	8
4ESMTS5×2.25	□	5	2° 15'	25	6.96	69	8
4ESMTS5×2.5	□	5	2° 30'	25	7.18	69	8
4ESMTS5×2.75	□	5	2° 45'	25	7.40	69	8
4ESMTS5×3	□	5	3°	25	7.62	69	8
4ESMTS5×4	□	5	4°	25	8.50	75	10
4ESMTS5×5	□	5	5°	25	9.37	75	10
4ESMTS5×7	□	5	7°	34	13.35	91	12
4ESMTS5×10	□	5	10°	34	16.99	94	16
4ESMTS6×0.5	□	6	30'	14	6.24	58	8
4ESMTS6×0.75	□	6	45'	14	6.37	58	8
4ESMTS6×1	□	6	1°	19	6.66	63	8
4ESMTS6×1.25	□	6	1° 15'	19	6.83	63	8
4ESMTS6×1.5	□	6	1° 30'	19	7.00	63	8
4ESMTS6×1.75	□	6	1° 45'	19	7.16	63	8
4ESMTS6×2	□	6	2°	25	7.75	69	8
4ESMTS6×2.25	□	6	2° 15'	25	7.96	75	10
4ESMTS6×2.5	□	6	2° 30'	25	8.18	75	10
4ESMTS6×2.75	□	6	2° 45'	25	8.40	75	10
4ESMTS6×3	□	6	3°	25	8.62	75	10
4ESMTS6×4	□	6	4°	25	9.50	75	10
4ESMTS6×5	□	6	5°	25	10.37	82	12
4ESMTS6×7	□	6	7°	34	14.35	91	12
4ESMTS6×10	□	6	10°	34	17.99	94	16
4ESMTS8×0.5	□	8	30'	17	8.30	67	10
4ESMTS8×1	□	8	1°	22	8.77	72	10
4ESMTS8×1.5	□	8	1° 30'	22	9.15	72	10
4ESMTS8×1.75	□	8	1° 45'	22	9.34	72	10
4ESMTS8×2	□	8	2°	30	10.10	87	12
4ESMTS8×2.25	□	8	2° 15'	30	10.36	87	12
4ESMTS8×2.5	□	8	2° 30'	30	10.62	87	12
4ESMTS8×2.75	□	8	2° 45'	30	10.88	87	12
4ESMTS8×3	□	8	3°	30	11.14	87	12
4ESMTS8×4	□	8	4°	30	12.20	87	12
4ESMTS8×5	□	8	5°	30	13.25	87	12
4ESMTS10×0.5	□	10	30'	17	10.30	74	12
4ESMTS10×1	□	10	1°	22	10.77	79	12
4ESMTS10×1.5	□	10	1° 30'	22	11.15	79	12
4ESMTS10×1.75	□	10	1° 45'	22	11.34	79	12
4ESMTS10×2	□	10	2°	30	12.10	87	12
4ESMTS10×2.25	□	10	2° 15'	30	12.36	87	12
4ESMTS10×2.5	□	10	2° 30'	30	12.62	87	12
4ESMTS10×2.75	□	10	2° 45'	30	12.88	87	12
4ESMTS10×3	□	10	3°	30	13.14	87	12
4ESMTS10×4	□	10	4°	30	14.20	87	12
4ESMTS10×5	□	10	5°	30	15.25	90	16

2ESMTT、2ESMTS、4ESMTSの対応被削材

炭素鋼 合金鋼 Carbon steel Alloy steel	炭素鋼 合金鋼 Pre-hardened steel ≤ 45HRC	高硬度 Hardened steel			ステン レス
---	--	-----------------------	--	--	-----------

ESM テーパーエンドミル

2枚刃・レギュラー刃長



(mm)

片角公差: ± 5'



2ESMTR

粉末 粗研 25° 切削 条件表 H86

商品コード	在庫	寸法 (mm)					
		外径	刃径	刃長	大端径	全長	
2ESMTR2×1	<input type="checkbox"/>	2	1°	22	2.77	66	6
2ESMTR2×1.25	<input type="checkbox"/>	2	1° 15'	22	2.96	66	6
2ESMTR2×1.5	<input type="checkbox"/>	2	1° 30'	22	3.15	66	6
2ESMTR2×1.75	<input type="checkbox"/>	2	1° 45'	22	3.34	66	6
2ESMTR2.5×0.5	<input type="checkbox"/>	2.5	30°	17	2.80	61	6
2ESMTR2.5×0.75	<input type="checkbox"/>	2.5	45°	17	2.95	61	6
2ESMTR2.5×1	<input type="checkbox"/>	2.5	1°	22	3.27	66	6
2ESMTR2.5×1.25	<input type="checkbox"/>	2.5	1° 15'	22	3.46	66	6
2ESMTR2.5×1.5	<input type="checkbox"/>	2.5	1° 30'	22	3.65	66	6
2ESMTR2.5×1.75	<input type="checkbox"/>	2.5	1° 45'	22	3.84	66	6
2ESMTR2.5×2	<input type="checkbox"/>	2.5	2°	30	4.60	74	6
2ESMTR2.5×2.25	<input type="checkbox"/>	2.5	2° 15'	30	4.86	74	6
2ESMTR2.5×2.5	<input type="checkbox"/>	2.5	2° 30'	30	5.12	74	6
2ESMTR2.5×2.75	<input type="checkbox"/>	2.5	2° 45'	30	5.38	74	6
2ESMTR2.5×3	<input type="checkbox"/>	2.5	3°	30	5.64	74	6
2ESMTR3×0.5	<input type="checkbox"/>	3	30°	17	3.30	61	6
2ESMTR3×0.75	<input type="checkbox"/>	3	45°	17	3.45	61	6
2ESMTR3×1	<input type="checkbox"/>	3	1°	22	3.77	66	6
2ESMTR3×1.25	<input type="checkbox"/>	3	1° 15'	22	3.96	66	6
2ESMTR3×1.5	<input type="checkbox"/>	3	1° 30'	22	4.15	66	6
2ESMTR3×1.75	<input type="checkbox"/>	3	1° 45'	22	4.34	66	6
2ESMTR3×2	<input type="checkbox"/>	3	2°	30	5.10	74	6
2ESMTR3×2.25	<input type="checkbox"/>	3	2° 15'	30	5.36	74	6
2ESMTR3×2.5	<input type="checkbox"/>	3	2° 30'	30	5.62	74	6
2ESMTR3×2.75	<input type="checkbox"/>	3	2° 45'	30	5.88	74	6
2ESMTR3×3	<input type="checkbox"/>	3	3°	30	6.14	74	6
2ESMTR4×0.5	<input type="checkbox"/>	4	30°	20	4.35	64	6
2ESMTR4×0.75	<input type="checkbox"/>	4	45°	20	4.52	64	6
2ESMTR4×1	<input type="checkbox"/>	4	1°	26	4.91	70	6
2ESMTR4×1.25	<input type="checkbox"/>	4	1° 15'	26	5.13	70	6
2ESMTR4×1.5	<input type="checkbox"/>	4	1° 30'	26	5.36	70	6
2ESMTR4×1.75	<input type="checkbox"/>	4	1° 45'	26	5.59	70	6
2ESMTR4×2	<input type="checkbox"/>	4	2°	36	6.51	80	8
2ESMTR4×2.25	<input type="checkbox"/>	4	2° 15'	36	6.83	80	8
2ESMTR4×2.5	<input type="checkbox"/>	4	2° 30'	36	7.14	80	8
2ESMTR4×2.75	<input type="checkbox"/>	4	2° 45'	36	7.46	80	8
2ESMTR4×3	<input type="checkbox"/>	4	3°	36	7.77	80	8
2ESMTR5×0.5	<input type="checkbox"/>	5	30°	20	5.35	68	6
2ESMTR5×0.75	<input type="checkbox"/>	5	45°	20	5.52	68	6
2ESMTR5×1	<input type="checkbox"/>	5	1°	32	6.12	76	8
2ESMTR5×1.25	<input type="checkbox"/>	5	1° 15'	32	6.40	76	8
2ESMTR5×1.5	<input type="checkbox"/>	5	1° 30'	32	6.68	76	8
2ESMTR5×1.75	<input type="checkbox"/>	5	1° 45'	32	6.96	76	8
2ESMTR5×2	<input type="checkbox"/>	5	2°	42	7.93	86	8
2ESMTR5×2.25	<input type="checkbox"/>	5	2° 15'	42	8.30	86	8
2ESMTR5×2.5	<input type="checkbox"/>	5	2° 30'	42	8.67	92	10
2ESMTR5×2.75	<input type="checkbox"/>	5	2° 45'	42	9.03	92	10
2ESMTR5×3	<input type="checkbox"/>	5	3°	42	9.40	92	10
2ESMTR6×0.5	<input type="checkbox"/>	6	30°	24	6.42	68	8
2ESMTR6×0.75	<input type="checkbox"/>	6	45°	24	6.63	68	8
2ESMTR6×1	<input type="checkbox"/>	6	1°	32	7.12	76	8
2ESMTR6×1.25	<input type="checkbox"/>	6	1° 15'	32	7.40	76	8
2ESMTR6×1.5	<input type="checkbox"/>	6	1° 30'	32	7.68	76	8
2ESMTR6×1.75	<input type="checkbox"/>	6	1° 45'	32	7.96	76	8
2ESMTR6×2	<input type="checkbox"/>	6	2°	42	8.93	92	10
2ESMTR6×2.25	<input type="checkbox"/>	6	2° 15'	42	9.30	92	10
2ESMTR6×2.5	<input type="checkbox"/>	6	2° 30'	42	9.67	92	10

4枚刃・レギュラー刃長

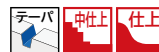

(mm)

片角公差: ± 5'



4ESMTR

商品コード	在庫	寸法 (mm)					
		外径	刃径	刃長	大端径	全長	
4ESMTR2×1	<input type="checkbox"/>	2	1°	22	2.77	66	6
4ESMTR2×1.25	<input type="checkbox"/>	2	1° 15'	22	2.96	66	6
4ESMTR2×1.5	<input type="checkbox"/>	2	1° 30'	22	3.15	66	6
4ESMTR2×1.75	<input type="checkbox"/>	2	1° 45'	22	3.34	66	6
4ESMTR2.5×0.5	<input type="checkbox"/>	2.5	30°	17	2.80	61	6
4ESMTR2.5×0.75	<input type="checkbox"/>	2.5	45°	17	2.95	61	6
4ESMTR2.5×1	<input type="checkbox"/>	2.5	1°	22	3.27	66	6
4ESMTR2.5×1.25	<input type="checkbox"/>	2.5	1° 15'	22	3.46	66	6
4ESMTR2.5×1.5	<input type="checkbox"/>	2.5	1° 30'	22	3.65	66	6
4ESMTR2.5×1.75	<input type="checkbox"/>	2.5	1° 45'	22	3.84	66	6
4ESMTR2.5×2	<input type="checkbox"/>	2.5	2°	30	4.60	74	6
4ESMTR2.5×2.25	<input type="checkbox"/>	2.5	2° 15'	30	4.86	74	6
4ESMTR2.5×2.5	<input type="checkbox"/>	2.5	2° 30'	30	5.12	74	6
4ESMTR2.5×2.75	<input type="checkbox"/>	2.5	2° 45'	30	5.38	74	6
4ESMTR2.5×3	<input type="checkbox"/>	2.5	3°	30	5.64	74	6
4ESMTR3×0.5	<input type="checkbox"/>	3	30°	17	3.30	61	6
4ESMTR3×0.75	<input type="checkbox"/>	3	45°	17	3.45	61	6
4ESMTR3×1	<input type="checkbox"/>	3	1°	22	3.77	66	6
4ESMTR3×1.25	<input type="checkbox"/>	3	1° 15'	22	3.96	66	6
4ESMTR3×1.5	<input type="checkbox"/>	3	1° 30'	22	4.15	66	6
4ESMTR3×1.75	<input type="checkbox"/>	3	1° 45'	22	4.34	66	6
4ESMTR3×2	<input type="checkbox"/>	3	2°	30	5.10	74	6
4ESMTR3×2.25	<input type="checkbox"/>	3	2° 15'	30	5.36	74	6
4ESMTR3×2.5	<input type="checkbox"/>	3	2° 30'	30	5.62	74	6
4ESMTR3×2.75	<input type="checkbox"/>	3	2° 45'	30	5.88	74	6
4ESMTR3×3	<input type="checkbox"/>	3	3°	30	6.14	74	8
4ESMTR4×0.5	<input type="checkbox"/>	4	30°	20	4.35	64	6
4ESMTR4×0.75	<input type="checkbox"/>	4	45°	20	4.52	64	6
4ESMTR4×1	<input type="checkbox"/>	4	1°	26	4.91	70	6
4ESMTR4×1.25	<input type="checkbox"/>	4	1° 15'	26	5.13	70	6
4ESMTR4×1.5	<input type="checkbox"/>	4	1° 30'	26	5.36	70	6
4ESMTR4×1.75	<input type="checkbox"/>	4	1° 45'	26	5.59	70	6
4ESMTR4×2	<input type="checkbox"/>	4	2°	36	6.51	80	8
4ESMTR4×2.25	<input type="checkbox"/>	4	2° 15'	36	6.83	80	8
4ESMTR4×2.5	<input type="checkbox"/>	4	2° 30'	36	7.14	80	8
4ESMTR4×2.75	<input type="checkbox"/>	4	2° 45'	36	7.46	80	8
4ESMTR4×3	<input type="checkbox"/>	4	3°	36	7.77	80	8
4ESMTR5×0.5	<input type="checkbox"/>	5	30°	20	5.35	68	6
4ESMTR5×0.75	<input type="checkbox"/>	5	45°	20	5.52	68	6
4ESMTR5×1	<input type="checkbox"/>	5	1°	32	6.12	76	8
4ESMTR5×1.25	<input type="checkbox"/>	5	1° 15'	32	6.40	76	8
4ESMTR5×1.5	<input type="checkbox"/>	5	1° 30'	32	6.68	76	8
4ESMTR5×1.75	<input type="checkbox"/>	5	1° 45'	32	6.96	76	8
4ESMTR5×2	<input type="checkbox"/>	5	2°	42	7.93	86	8
4ESMTR5×2.25	<input type="checkbox"/>	5	2° 15'	42	8.30	86	8
4ESMTR5×2.5	<input type="checkbox"/>	5	2° 30'	42	8.67	92	10
4ESMTR5×2.75	<input type="checkbox"/>	5	2° 45'	42	9.03	92	10
4ESMTR5×3	<input type="checkbox"/>	5	3°	42	9.40	92	10
4ESMTR6×0.5	<input type="checkbox"/>	6	30°	24	6.42	68	8
4ESMTR6×0.75	<input type="checkbox"/>	6	45°	24	6.63	68	8
4ESMTR6×1	<input type="checkbox"/>	6	1°	32	7.12	76	8
4ESMTR6×1.25	<input type="checkbox"/>	6	1° 15'	32	7.40	76	8
4ESMTR6×1.5	<input type="checkbox"/>	6	1° 30'	32	7.68	76	8
4ESMTR6×1.75	<input type="checkbox"/>	6	1° 45'	32	7.96	76	8
4ESMTR6×2	<input type="checkbox"/>	6	2°	42	8.93	92	10
4ESMTR6×2.25	<input type="checkbox"/>	6	2° 15'	42	9.30	92	10
4ESMTR6×2.5	<input type="checkbox"/>	6	2° 30'	42	9.67	92	10

□印: 特定代理店在庫です。弊社営業へお問合せください。 □: Stocked by specified distributor. Contact with our sales department.

ESMテーパボールエンドミル

ショート刃長



(mm)



粉末ハイス 粗研25° 切削条件表 H86

粉末ハイス 粗研25°

2ESMTBS ○.○○○R × ○.○○○

商品コード	在庫	寸法 (mm)					
		外径	ボール半径	刃長	大端径	全長	
4ESMTR6 × 2.75	<input type="checkbox"/>	6	2° 45'	42	10.03	92	10
4ESMTR6 × 3	<input type="checkbox"/>	6	3°	42	10.40	99	12
4ESMTR8 × 0.5	<input type="checkbox"/>	8	30'	28	8.49	78	10
4ESMTR8 × 0.75	<input type="checkbox"/>	8	45'	28	8.73	78	10
4ESMTR8 × 1	<input type="checkbox"/>	8	1°	38	9.33	88	10
4ESMTR8 × 1.25	<input type="checkbox"/>	8	1° 15'	38	9.66	88	10
4ESMTR8 × 1.5	<input type="checkbox"/>	8	1° 30'	38	9.99	88	10
4ESMTR8 × 1.75	<input type="checkbox"/>	8	1° 45'	38	10.32	88	10
4ESMTR8 × 2	<input type="checkbox"/>	8	2°	50	11.49	107	12
4ESMTR8 × 2.5	<input type="checkbox"/>	8	2° 30'	50	12.37	107	12
4ESMTR8 × 3	<input type="checkbox"/>	8	3°	50	13.24	107	12
4ESMTR8 × 5	<input type="checkbox"/>	8	5°	50	16.75	110	16
4ESMTR8 × 7	<input type="checkbox"/>	8	7°	67	24.45	143	25
4ESMTR8 × 10	<input type="checkbox"/>	8	10°	67	31.63	147	32
4ESMTR10 × 0.5	<input type="checkbox"/>	10	30'	28	10.49	85	12
4ESMTR10 × 0.75	<input type="checkbox"/>	10	45'	28	10.73	85	12
4ESMTR10 × 1	<input type="checkbox"/>	10	1°	38	11.33	95	12
4ESMTR10 × 1.25	<input type="checkbox"/>	10	1° 15'	38	11.66	95	12
4ESMTR10 × 1.5	<input type="checkbox"/>	10	1° 30'	38	11.99	95	12
4ESMTR10 × 1.75	<input type="checkbox"/>	10	1° 45'	38	12.32	95	12
4ESMTR10 × 2	<input type="checkbox"/>	10	2°	50	13.49	107	12
4ESMTR10 × 2.25	<input type="checkbox"/>	10	2° 15'	50	13.93	107	12
4ESMTR10 × 2.5	<input type="checkbox"/>	10	2° 30'	50	14.47	107	12
4ESMTR10 × 2.75	<input type="checkbox"/>	10	2° 45'	50	14.80	107	12
4ESMTR10 × 3	<input type="checkbox"/>	10	3°	50	15.24	110	16
4ESMTR10 × 5	<input type="checkbox"/>	10	5°	50	18.75	110	16
4ESMTR10 × 7	<input type="checkbox"/>	10	7°	67	26.45	143	25
4ESMTR10 × 10	<input type="checkbox"/>	10	10°	67	33.63	147	32
4ESMTR12 × 0.5	<input type="checkbox"/>	12	30'	34	12.59	91	12
4ESMTR12 × 0.75	<input type="checkbox"/>	12	45'	34	12.89	91	12
4ESMTR12 × 1	<input type="checkbox"/>	12	1°	45	13.57	102	12
4ESMTR12 × 1.25	<input type="checkbox"/>	12	1° 15'	45	13.96	102	12
4ESMTR12 × 1.5	<input type="checkbox"/>	12	1° 30'	45	14.36	102	12
4ESMTR12 × 1.75	<input type="checkbox"/>	12	1° 45'	45	14.75	102	12
4ESMTR12 × 2	<input type="checkbox"/>	12	2°	60	16.19	120	16
4ESMTR12 × 2.25	<input type="checkbox"/>	12	2° 15'	60	16.71	120	16
4ESMTR12 × 2.5	<input type="checkbox"/>	12	2° 30'	60	17.24	120	16
4ESMTR12 × 2.75	<input type="checkbox"/>	12	2° 45'	60	17.76	120	16
4ESMTR12 × 3	<input type="checkbox"/>	12	3°	60	18.29	126	20
4ESMTR12 × 5	<input type="checkbox"/>	12	5°	60	22.50	126	20
4ESMTR12 × 7	<input type="checkbox"/>	12	7°	80	31.65	160	32
4ESMTR12 × 10	<input type="checkbox"/>	12	10°	80	40.21	172	42
4ESMTR16 × 1.5	<input type="checkbox"/>	16	1° 30'	45	18.36	105	16
4ESMTR16 × 1.75	<input type="checkbox"/>	16	1° 45'	45	18.75	105	16
4ESMTR16 × 2	<input type="checkbox"/>	16	2°	60	20.19	126	20
4ESMTR16 × 2.25	<input type="checkbox"/>	16	2° 15'	60	20.71	126	20
4ESMTR16 × 2.5	<input type="checkbox"/>	16	2° 30'	60	21.24	126	20
4ESMTR16 × 2.75	<input type="checkbox"/>	16	2° 45'	60	21.76	126	20
4ESMTR16 × 3	<input type="checkbox"/>	16	3°	60	22.29	126	20
4ESMTR16 × 4	<input type="checkbox"/>	16	4°	60	24.39	136	25
4ESMTR16 × 5	<input type="checkbox"/>	16	5°	60	26.50	136	25
4ESMTR20 × 2	<input type="checkbox"/>	20	2°	71	24.96	147	25
4ESMTR20 × 2.25	<input type="checkbox"/>	20	2° 15'	71	25.58	147	25
4ESMTR20 × 2.5	<input type="checkbox"/>	20	2° 30'	71	26.20	147	25
4ESMTR20 × 2.75	<input type="checkbox"/>	20	2° 45'	71	26.82	147	25
4ESMTR20 × 3	<input type="checkbox"/>	20	3°	71	27.44	147	25
4ESMTR20 × 4	<input type="checkbox"/>	20	4°	71	29.93	147	25

商品コード	在庫	寸法 (mm)					
		ボール半径	刃長	大端径	全長	シャンク径	
2ESMTBS1RX0.5	<input type="checkbox"/>	1	30'	10	2.16	75	6
2ESMTBS1RX1	<input type="checkbox"/>	1	1°	13	2.42	80	6
2ESMTBS1RX1.5	<input type="checkbox"/>	1	1° 30'	13	2.63	80	6
2ESMTBS1RX2	<input type="checkbox"/>	1	2°	18	3.19	85	6
2ESMTBS1RX2.5	<input type="checkbox"/>	1	2° 30'	18	3.49	85	6
2ESMTBS1RX3	<input type="checkbox"/>	1	3°	18	3.78	85	6
2ESMTBS1.25RX0.5	<input type="checkbox"/>	1.25	30'	10	2.65	75	6
2ESMTBS1.25RX1	<input type="checkbox"/>	1.25	1°	13	2.91	80	6
2ESMTBS1.25RX1.5	<input type="checkbox"/>	1.25	1° 30'	13	3.12	80	6
2ESMTBS1.25RX2	<input type="checkbox"/>	1.25	2°	18	3.67	85	6
2ESMTBS1.25RX2.5	<input type="checkbox"/>	1.25	2° 30'	18	3.97	85	6
2ESMTBS1.25RX3	<input type="checkbox"/>	1.25	3°	18	4.26	85	6
2ESMTBS1.25RX4	<input type="checkbox"/>	1.25	4°	18	4.85	85	6
2ESMTBS1.25RX5	<input type="checkbox"/>	1.25	5°	18	5.44	85	6
2ESMTBS1.25RX7	<input type="checkbox"/>	1.25	7°	24	8.11	100	10
2ESMTBS1.25RX10	<input type="checkbox"/>	1.25	10°	24	10.56	105	12
2ESMTBS1.5RX0.5	<input type="checkbox"/>	1.5	30'	10	3.15	75	6
2ESMTBS1.5RX1	<input type="checkbox"/>	1.5	1°	13	3.4	80	6
2ESMTBS1.5RX1.5	<input type="checkbox"/>	1.5	1° 30'	13	3.6	80	6
2ESMTBS1.5RX2	<input type="checkbox"/>	1.5	2°	18	4.15	85	6
2ESMTBS1.5RX2.5	<input type="checkbox"/>	1.5	2° 30'	18	4.44	85	6
2ESMTBS1.5RX3	<input type="checkbox"/>	1.5	3°	18	4.73	85	6
2ESMTBS1.5RX4	<input type="checkbox"/>	1.5	4°	18	5.31	85	6
2ESMTBS1.5RX5	<input type="checkbox"/>	1.5	5°	18	5.9	90	8
2ESMTBS1.5RX7	<input type="checkbox"/>	1.5	7°	24	8.55	100	10
2ESMTBS1.5RX10	<input type="checkbox"/>	1.5	10°	24	10.98	105	12
2ESMTBS2RX0.5	<input type="checkbox"/>	2	30'	12	4.17	75	6
2ESMTBS2RX1	<input type="checkbox"/>	2	1°	16	4.49	80	6
2ESMTBS2RX1.5	<input type="checkbox"/>	2	1° 30'	16	4.73	80	6
2ESMTBS2RX2	<input type="checkbox"/>	2	2°	21	5.33	85	6
2ESMTBS2RX2.5	<input type="checkbox"/>	2	2° 30'	21	5.66	85	6
2ESMTBS2RX3	<input type="checkbox"/>	2	3°	21	6	90	8
2ESMTBS2RX4	<input type="checkbox"/>	2	4°	21	6.67	90	8
2ESMTBS2RX5	<input type="checkbox"/>	2	5°	21	7.34	90	8
2ESMTBS2RX7	<input type="checkbox"/>	2	7°	28	10.41	110	12
2ESMTBS2RX10	<input type="checkbox"/>	2	10°	28	13.23	110	12
2ESMTBS2.5RX0.5	<input type="checkbox"/>	2.5	30'	14	5.2	80	6
2ESMTBS2.5RX1	<input type="checkbox"/>	2.5	1°	19	5.58	85	6
2ESMTBS2.5RX1.5	<input type="checkbox"/>	2.5	1° 30'	19	5.87	85	6
2ESMTBS2.5RX2	<input type="checkbox"/>	2.5	2°	25	6.57	95	8
2ESMTBS2.5RX2.5	<input type="checkbox"/>	2.5	2° 30'	25	6.97	95	8
2ESMTBS2.5RX3	<input type="checkbox"/>	2.5	3°	25	7.37	95	8
2ESMTBS2.5RX4	<input type="checkbox"/>	2.5	4°	25	8.16	100	10
2ESMTBS2.5RX5	<input type="checkbox"/>	2.5	5°	25	8.96	100	10
2ESMTBS2.5RX7	<input type="checkbox"/>	2.5	7°	34	12.77	115	12
2ESMTBS2.5RX10	<input type="checkbox"/>	2.5	10°	34	16.19	125	16
2ESMTBS3RX0.5	<input type="checkbox"/>	3	30'	14	6.19	85	8
2ESMTBS3RX1	<input type="checkbox"/>	3	1°	19	6.56	90	8
2ESMTBS3RX1.5	<input type="checkbox"/>	3	1° 30'	19	6.84	90	8
2ESMTBS3RX2	<input type="checkbox"/>	3	2°	25	7.54	95	8
2ESMTBS3RX2.5	<input type="checkbox"/>	3	2° 30'	25	7.93	100	10
2ESMTBS3RX3	<input type="checkbox"/>	3	3°	25	8.31	100	10
2ESMTBS3RX4	<input type="checkbox"/>	3	4°	25	9.09	100	10
2ESMTBS3RX5	<input type="checkbox"/>	3	5°	25	9.87	105	12
2ESMTBS3RX7	<input type="checkbox"/>	3	7°	34	13.66	115	12
2ESMTBS3RX10	<input type="checkbox"/>	3	10°	34	17.02	125	16
2ESMTBS4RX1.5	<input type="checkbox"/>	4	1° 30'	22	8.95	95	10

商品コード	在庫	寸法 (mm)					
		ボール半径	刃長	大端径	全長	シャンク径	
2ESMTBS4RX2	<input type="checkbox"/>	4	2°	30	9.82	110	12
2ESMTBS4RX2.5	<input type="checkbox"/>	4	2° 30'	30	10.28	110	12
2ESMTBS4RX3	<input type="checkbox"/>	4	3°	30	10.74	110	12
2ESMTBS4RX4	<input type="checkbox"/>	4	4°	30	11.66	110	12
2ESMTBS4RX5	<input type="checkbox"/>	4	5°	30	12.58	110	12
2ESMTBS5RX1.5	<input type="checkbox"/>	5	1° 30'	22	10.89	100	12
2ESMTBS5RX2	<input type="checkbox"/>	5	2°	30	11.75	110	12
2ESMTBS5RX2.5	<input type="checkbox"/>	5	2° 30'	30	12.19	110	12
2ESMTBS5RX3	<input type="checkbox"/>	5	3°	30	12.63	110	12
2ESMTBS5RX4	<input type="checkbox"/>	5	4°	30	13.52	110	12
2ESMTBS5RX5	<input type="checkbox"/>	5	5°	30	14.41	120	16

2ESMTR、4ESMTR、2ESMTBS の対応被削材

炭素鋼 合金鋼 Carbon steel Alloy steel	炭素鋼 合金鋼 Pre-hardened steel ≤ 45HRC	高硬度 Hardened steel			ステン レス鋼 Stainless steel	チタン合金 耐熱合金 Titanium alloy Heat-resistant alloy	銅合金 Copper alloy	アルミ 合金 Aluminum alloy
		> 45HRC ≤ 55HRC	> 55HRC ≤ 65HRC	> 65HRC				
○					○	○	○	

HSS End Mills

Stocked by Specified distributor

ESMテーパールエンドミル

その他のエンドミル

レギュラー刃長

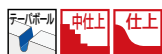

(mm)



一般刃形ダイナミル



(mm)

4,6,8,10枚刃



一般刃形サイドロックミル



(mm)



2ESMTBR ϕ R \times ϕ \times ϕ \times ϕ

商品コード	在庫	寸法 (mm)					
		ボール半径	刃角	刃長	大端径	全長	シャンク径
2ESMTBR3RX0.5	<input type="checkbox"/>	3	30°	24	6.37	95	8
2ESMTBR3RX1	<input type="checkbox"/>	3	1°	32	7.01	100	8
2ESMTBR4RX0.5	<input type="checkbox"/>	4	30°	28	8.42	100	10
2ESMTBR4RX1	<input type="checkbox"/>	4	1°	38	9.19	115	10
2ESMTBR4RX1.5	<input type="checkbox"/>	4	1°30'	38	9.78	115	10
2ESMTBR4RX5	<input type="checkbox"/>	4	5°	50	16.08	140	16
2ESMTBR4RX7	<input type="checkbox"/>	4	7°	67	23.53	180	25
2ESMTBR4RX10	<input type="checkbox"/>	4	10°	67	30.34	190	32
2ESMTBR5RX0.5	<input type="checkbox"/>	5	30°	28	10.4	110	12
2ESMTBR5RX1	<input type="checkbox"/>	5	1°	38	11.15	120	12
2ESMTBR5RX1.5	<input type="checkbox"/>	5	1°30'	38	11.73	120	12
2ESMTBR5RX2	<input type="checkbox"/>	5	2°	50	13.15	130	12
2ESMTBR5RX2.5	<input type="checkbox"/>	5	2°30'	50	13.94	130	12
2ESMTBR5RX3	<input type="checkbox"/>	5	3°	50	14.73	140	16
2ESMTBR5RX5	<input type="checkbox"/>	5	5°	50	17.91	140	16
2ESMTBR5RX7	<input type="checkbox"/>	5	7°	67	25.3	180	25
2ESMTBR5RX10	<input type="checkbox"/>	5	10°	67	32.02	190	32
2ESMTBR6RX0.5	<input type="checkbox"/>	6	30°	34	12.49	115	12
2ESMTBR6RX1	<input type="checkbox"/>	6	1°	45	13.36	125	12
2ESMTBR6RX1.5	<input type="checkbox"/>	6	1°30'	45	14.05	125	12
2ESMTBR6RX2	<input type="checkbox"/>	6	2°	60	15.78	150	16
2ESMTBR6RX2.5	<input type="checkbox"/>	6	2°30'	60	16.73	150	16
2ESMTBR6RX3	<input type="checkbox"/>	6	3°	60	17.68	160	16
2ESMTBR6RX4	<input type="checkbox"/>	6	4°	60	19.58	160	20
2ESMTBR6RX5	<input type="checkbox"/>	6	5°	60	21.49	160	20
2ESMTBR6RX7	<input type="checkbox"/>	6	7°	80	30.26	205	32
2ESMTBR6RX10	<input type="checkbox"/>	6	10°	80	38.28	215	42
2ESMTBR8RX1.5	<input type="checkbox"/>	8	1°30'	45	17.94	135	16
2ESMTBR8RX2	<input type="checkbox"/>	8	2°	60	19.64	160	20
2ESMTBR8RX2.5	<input type="checkbox"/>	8	2°30'	60	20.56	160	20
2ESMTBR8RX3	<input type="checkbox"/>	8	3°	60	21.47	160	20
2ESMTBR8RX4	<input type="checkbox"/>	8	4°	60	23.31	175	25
2ESMTBR8RX5	<input type="checkbox"/>	8	5°	60	25.16	175	25
2ESMTBR10RX2	<input type="checkbox"/>	10	2°	71	24.27	185	25
2ESMTBR10RX2.5	<input type="checkbox"/>	10	2°30'	71	25.35	185	25
2ESMTBR10RX3	<input type="checkbox"/>	10	3°	71	26.42	185	25
2ESMTBR10RX4	<input type="checkbox"/>	10	4°	71	28.58	185	25

DSP ϕ \times ϕ \times ϕ \times ϕ

商品コード	在庫	寸法 (mm)				刃数
		外径	刃長	全長	シャンク径	
DSP30×55	<input type="checkbox"/>	30	55	135	32	4
DSP30×90	<input type="checkbox"/>	30	90	170	32	4
DSP30×120	<input type="checkbox"/>	30	120	200	32	4
DSP35×75	<input type="checkbox"/>	35	75	155	32	4
DSP35×100	<input type="checkbox"/>	35	100	180	32	4
DSP35×125	<input type="checkbox"/>	35	125	205	32	4
DSP40×75	<input type="checkbox"/>	40	75	155	32	4
DSP40×100	<input type="checkbox"/>	40	100	180	32	4
DSP40×125	<input type="checkbox"/>	40	125	205	32	4
DSP45×100	<input type="checkbox"/>	45	100	195	50.8	6
DSP45×125	<input type="checkbox"/>	45	125	220	50.8	6
DSP45×150	<input type="checkbox"/>	45	150	245	50.8	6
DSP50×75	<input type="checkbox"/>	50	75	170	50.8	6
DSP50×100	<input type="checkbox"/>	50	100	195	50.8	6
DSP50×125	<input type="checkbox"/>	50	125	220	50.8	6
DSP50×150	<input type="checkbox"/>	50	150	245	50.8	6
DSP50×200	<input type="checkbox"/>	50	200	295	50.8	6
DSP60×100	<input type="checkbox"/>	60	100	195	50.8	6
DSP60×125	<input type="checkbox"/>	60	125	220	50.8	6
DSP60×150	<input type="checkbox"/>	60	150	245	50.8	6
DSP60×200	<input type="checkbox"/>	60	200	295	50.8	6
DSP70×100	<input type="checkbox"/>	70	100	195	50.8	6
DSP70×125	<input type="checkbox"/>	70	125	220	50.8	6
DSP70×150	<input type="checkbox"/>	70	150	245	50.8	6
DSP75×50	<input type="checkbox"/>	75	50	145	50.8	8
DSP75×100	<input type="checkbox"/>	75	100	195	50.8	8
DSP100×50	<input type="checkbox"/>	100	50	145	50.8	10
DSP100×100	<input type="checkbox"/>	100	100	195	50.8	10

SRP ϕ \times ϕ \times ϕ \times ϕ

商品コード	在庫	寸法 (mm)			
		外径	刃長	全長	シャンク径
SRP20×45	<input type="checkbox"/>	20	45	110	25
SRP20×75	<input type="checkbox"/>	20	75	140	25
SRP20×100	<input type="checkbox"/>	20	100	165	25
SRP22×45	<input type="checkbox"/>	22	45	110	25
SRP22×75	<input type="checkbox"/>	22	75	140	25
SRP22×100	<input type="checkbox"/>	22	100	165	25
SRP25×50	<input type="checkbox"/>	25	50	115	25
SRP25×90	<input type="checkbox"/>	25	90	155	25
SRP25×120	<input type="checkbox"/>	25	120	185	25
SRP28×55	<input type="checkbox"/>	28	55	120	25
SRP28×90	<input type="checkbox"/>	28	90	155	25
SRP28×120	<input type="checkbox"/>	28	120	185	25
SRP30×55	<input type="checkbox"/>	30	55	120	25
SRP30×90	<input type="checkbox"/>	30	90	155	25
SRP30×120	<input type="checkbox"/>	30	120	185	25

高リードエンドミル



(mm)



高リード刃形サイドロックミル



(mm)



HE ϕ \times ϕ \times ϕ

商品コード	在庫	寸法 (mm)				刃数
		外径	刃長	全長	シャンク径	
HE20	<input type="checkbox"/>	20	55	135	MT2	4
HE25	<input type="checkbox"/>	25	70	170	MT3	4
HE30	<input type="checkbox"/>	30	80	205	MT4	4
HE35	<input type="checkbox"/>	35	90	215	MT4	4
HE40	<input type="checkbox"/>	40	100	225	MT4	4
HE45	<input type="checkbox"/>	45	110	265	MT5	4
HE50	<input type="checkbox"/>	50	120	280	MT5	4

SRH ϕ \times ϕ \times ϕ \times ϕ

商品コード	在庫	寸法 (mm)			
		外径	刃長	全長	シャンク径
SRH20×45	<input type="checkbox"/>	20	45	110	25
SRH20×75	<input type="checkbox"/>	20	75	140	25
SRH20×100	<input type="checkbox"/>	20	100	165	25
SRH22×45	<input type="checkbox"/>	22	45	110	25
SRH22×75	<input type="checkbox"/>	22	75	140	25
SRH22×100	<input type="checkbox"/>	22	100	165	25
SRH25×50	<input type="checkbox"/>	25	50	115	25
SRH25×90	<input type="checkbox"/>	25	90	155	25
SRH25×120	<input type="checkbox"/>	25	120	185	25
SRH28×55	<input type="checkbox"/>	28	55	120	25
SRH28×90	<input type="checkbox"/>	28	90	155	25
SRH28×120	<input type="checkbox"/>	28	120	185	25
SRH30×55	<input type="checkbox"/>	30	55	120	25
SRH30×90	<input type="checkbox"/>	30	90	155	25
SRH30×120	<input type="checkbox"/>	30	120	185	25

2ESMTBR、DSP、SRP、HE、SRHの対応被削材

炭素鋼 合金鋼 Carbon steel Alloy steel	炭素鋼 合金鋼 Pre-hardened steel ≤ 45HRC	高硬度 Hardened steel			ステン レス鋼 Stainless steel	チタン合金 耐熱合金 Titanium alloy Heat-resistant alloy	銅合金 Copper alloy	アルミ 合金 Aluminum alloy
		> 45HRC ≤ 55HRC	> 55HRC ≤ 65HRC	> 65HRC				
<input type="checkbox"/>	<input type="checkbox"/>	<input type="checkbox"/>	<input type="checkbox"/>	<input type="checkbox"/>	<input type="checkbox"/>	<input type="checkbox"/>	<input type="checkbox"/>	

印：特定代理店在庫です。弊社営業へお問合せください。 ：Stocked by specified distributor. Contact with our sales department.

標準切削条件表

○ アルミ用ボールエンドミル

寸法表 Size list : H68

ALB

<側面切削> Side milling

被削材 (硬さ) Work material (Hardness)	条件域 Condition Range	切込み Depth of cut mm	切削条件 Cutting Conditions	ボール半径 RE × 外径 DC Tool dia. (mm)					
				RE5 × 10	RE6 × 12	RE8 × 16	RE10 × 20	RE12.5 × 25	RE15 × 30
アルミ合金 Aluminum alloys Cu-Mg 系 2014	汎用条件 General	$a_p=0.5DC$ $a_e=0.1DC$	回転数 min^{-1}	5,600	4,600	3,500	2,800	2,200	1,900
			送り速度 mm/min	1,000	800	800	600	500	500
アルミ合金 Aluminum alloys Mg 系 5052	汎用条件 General	$a_p=0.5DC$ $a_e=0.1DC$	回転数 min^{-1}	3,500	2,900	2,200	1,800	1,400	1,200
			送り速度 mm/min	500	500	400	400	350	300
アルミ合金 Aluminum alloys Mg-Si 系 6061	汎用条件 General	$a_p=0.5DC$ $a_e=0.1DC$	回転数 min^{-1}	1,900	1,600	1,200	960	760	640
			送り速度 mm/min	300	250	200	200	150	150
アルミ合金 Aluminum alloys Zn-Mg 系 7075	汎用条件 General	$a_p=0.5DC$ $a_e=0.1DC$	回転数 min^{-1}	3,900	3,300	2,500	2,000	1,600	1,300
			送り速度 mm/min	400	500	500	500	400	400
鋳造アルミ Cast iron Aluminum AC8C	汎用条件 General	$a_p=0.5DC$ $a_e=0.1DC$	回転数 min^{-1}	4,300	3,600	2,700	2,150	1,700	1,400
			送り速度 mm/min	450	550	550	550	500	450

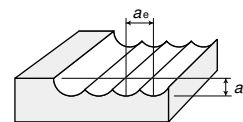

- 【注意】** ①被削材、加工形状に合わせて、適切なクーラントを使用してください。
 ②この標準切削条件表は切削条件の目安を示すものです。実際の加工では加工形状、目的、使用機械等により条件を調整してください。
- [Note]** ① Use the appropriate coolant for the work material and machining shape.
 ② These Recommended Cutting Conditions indicate only the rule of a thumb for the cutting conditions. In actual machining, the condition should be adjusted according to the machining shape, purpose and the machine type.

標準切削条件表

GC-NKエンドミルシリーズ

寸法表 Size list : H69 寸法表 Size list : H69

2GNKS ショート刃長 Short	2GNKR レギュラー刃長 Regular
---------------------------------	------------------------------------

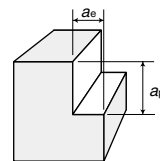

<側面切削> Side milling

被削材 (硬さ) Work material (Hardness)	条件域 Condition Range	切込み Depth of cut mm	切削条件 Cutting Conditions	外径 DC Tool dia. (mm)													
				φ3	φ4	φ6	φ8	φ10	φ12	φ16	φ20	φ25	φ30	φ35	φ40	φ45	φ50
鋳鉄・炭素鋼 Cast irons, Carbon steels (200HB以下) FC200 SS400, S45C	汎用条件 General	ap=1.5DC ae=0.1DC	回転数 min ⁻¹	3,700	2,800	1,800	1,400	1,100	930	700	560	440	370	320	275	245	220
			送り速度 mm /min	110	110	125	140	130	120	120	110	105	93	75	65	60	55
合金鋼 Alloy steels (200~250HB) SCM, SNCM	汎用条件 General	ap=1.5DC ae=0.1DC	回転数 min ⁻¹	2,900	2,190	1,460	1,090	870	720	550	440	350	290	250	220	190	170
			送り速度 mm /min	90	90	90	90	90	90	85	65	65	55	50	45	40	32
工具鋼・ステンレス鋼 Tool steels, Stainless steels (25~35HRC) SKD, SKT, SUS304	汎用条件 General	ap=1.5DC ae=0.1DC	回転数 min ⁻¹	2,300	1,750	1,160	875	700	580	440	350	280	230	200	175	150	140
			送り速度 mm /min	55	65	70	65	65	65	70	55	45	45	40	30	25	25
焼入れ鋼・プリハードン鋼 Hardened steels, Pre-Harden steels (35~45HRC) SKD, SKT, HPM1, NAK55	汎用条件 General	ap=1.5DC ae=0.1DC	回転数 min ⁻¹	1,600	1,220	820	610	490	410	310	240	200	160	140	120	110	100
			送り速度 mm /min	38	38	50	50	50	50	50	38	38	32	30	27	20	20
耐熱鋼 Heat-resistant steels Inconel	汎用条件 General	ap=1.5DC ae=0.1DC	回転数 min ⁻¹	930	700	470	350	280	230	175	140	110	90	80	70	60	55
			送り速度 mm /min	22	22	22	22	22	22	22	22	18	15	14	13	12	10
アルミ合金・非鉄金属 Aluminum alloys Non Ferrous	汎用条件 General	ap=1.5DC ae=0.1DC	回転数 min ⁻¹	8,700	6,500	4,400	3,300	2,600	2,200	1,600	1,300	1,050	880	750	650	580	520
			送り速度 mm /min	320	320	320	380	380	380	380	320	320	270	220	200	170	150

寸法表 Size list : H69 寸法表 Size list : H69

2GNKS ショート刃長 Short	2GNKR レギュラー刃長 Regular
---------------------------------	------------------------------------

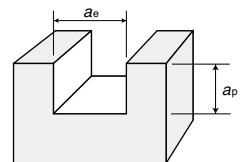

<溝切削> Slotting

被削材 (硬さ) Work material (Hardness)	条件域 Condition Range	切込み Depth of cut mm	切削条件 Cutting Conditions	外径 DC Tool dia. (mm)													
				φ3	φ4	φ6	φ8	φ10	φ12	φ16	φ20	φ25	φ30	φ35	φ40	φ45	φ50
鋳鉄・炭素鋼 Cast irons, Carbon steels (200HB以下) FC200 SS400, S45C	汎用条件 General	ap=0.5DC ae=1DC	回転数 min ⁻¹	2,600	2,000	1,300	1,000	800	660	500	400	320	260	230	200	175	160
			送り速度 mm /min	80	90	100	110	110	110	85	85	65	55	50	45	45	45
合金鋼 Alloy steels (200~250HB) SCM, SNCM	汎用条件 General	ap=0.5DC ae=1DC	回転数 min ⁻¹	2,100	1,600	1,000	800	640	530	400	320	260	210	180	160	140	130
			送り速度 mm /min	45	55	65	55	55	55	55	55	45	40	35	28	28	28
工具鋼・ステンレス鋼 Tool steels, Stainless steels (25~35HRC) SKD, SKT, SUS304	汎用条件 General	ap=0.5DC ae=1DC	回転数 min ⁻¹	1,700	1,200	850	640	510	420	320	260	200	160	145	120	110	100
			送り速度 mm /min	40	45	45	45	45	45	45	45	35	30	25	25	25	25
焼入れ鋼・プリハードン鋼 Hardened steels, Pre-Harden steels (35~45HRC) SKD, SKT, HPM1, NAK55	汎用条件 General	ap=0.5DC ae=1DC	回転数 min ⁻¹	1,300	960	640	480	380	320	240	190	150	130	110	95	85	75
			送り速度 mm /min	23	28	28	33	33	33	33	33	28	22	20	17	17	17
耐熱鋼 Heat-resistant steels Inconel	汎用条件 General	ap=0.5DC ae=1DC	回転数 min ⁻¹				200	160	130	100	80	60	50	45	40	35	30
			送り速度 mm /min				13	13	13	13	13	12	10	8	8	8	8
アルミ合金・非鉄金属 Aluminum alloys Non Ferrous	汎用条件 General	ap=0.5DC ae=1DC	回転数 min ⁻¹	5,300	4,000	2,600	2,000	1,600	1,320	1,000	800	640	530	450	400	350	320
			送り速度 mm /min	165	185	200	220	220	265	220	180	130	110	95	90	90	90

- [注意]** ①被削材、加工形状に合わせて、適切なクーラントを使用してください。
 ②この標準切削条件表は切削条件の目安を示すものです。実際の加工では加工形状、目的、使用機械等により条件を調整してください。
- [Note]** ① Use the appropriate coolant for the work material and machining shape.
 ② These Recommended Cutting Conditions indicate only the rule of a thumb for the cutting conditions. In actual machining, the condition should be adjusted according to the machining shape, purpose and the machine type.

ハイスエンドミル 特定代理店在庫品

GC-ファインミル

寸法表 Size list : H71

GFQS

ショート刃長
Short

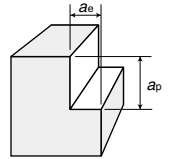

a_p : $\phi 40$ 以下 = 1.4DC
 $\phi 45$ 以上 = 1.6DC
 $a_e = 0.5DC$

<側面切削> Side milling

被削材 (硬さ) Work material (Hardness)	条件域 Condition Range	切込み Depth of cut mm	切削条件 Cutting Conditions	外径 DC Tool dia. (mm)											
				$\phi 6$	$\phi 8$	$\phi 10$	$\phi 12$	$\phi 16$	$\phi 20$	$\phi 25$	$\phi 30$	$\phi 35$	$\phi 40$	$\phi 45$	$\phi 50$
鋳鉄・炭素鋼 Cast irons, Carbon steels (200HB以下) FC200 SS400, S45C	汎用条件 General	右上図 参照	回転数 min ⁻¹	1,500	1,100	950	790	590	470	380	310	270	230	210	170
			送り速度 mm/min	120	130	150	160	140	130	120	110	110	100	90	85
合金鋼 Alloy steels (200~250HB) SCM, SNCM	汎用条件 General	右上図 参照	回転数 min ⁻¹	1,100	890	710	590	440	350	280	230	200	170	150	140
			送り速度 mm/min	90	110	110	120	110	100	90	85	80	75	65	60
工具鋼・ステンレス鋼 Tool steels, Stainless steels (25~35HRC) SKD, SKT, SUS304	汎用条件 General	右上図 参照	回転数 min ⁻¹	950	710	570	470	350	280	220	190	160	140	120	110
			送り速度 mm/min	75	85	90	95	85	80	70	70	65	60	55	50
焼入れ鋼・プリハードン鋼 Hardened steels, Pre-Harden steels (35~45HRC) SKD, SKT HPM1, NAK55	汎用条件 General	右上図 参照	回転数 min ⁻¹	740	550	440	370	270	220	170	140	120	110	95	85
			送り速度 mm/min	30	45	55	60	55	55	50	45	45	45	40	35
耐熱鋼・チタン合金 Heat-resistant steels, Titanium alloys Inconel Ti-6Al-4V	汎用条件 General	右上図 参照	回転数 min ⁻¹	370	270	220	180	130	110	85	70	60	55	45	40
			送り速度 mm/min	15	20	25	30	25	25	25	20	20	20	18	16
アルミ合金・非鉄金属 Aluminum alloys Non Ferrous	汎用条件 General	右上図 参照	回転数 min ⁻¹	4,500	3,300	2,700	2,200	1,600	1,300	1,000	900	770	670	600	540
			送り速度 mm/min	180	260	320	350	320	310	280	280	280	270	240	220

- [注意]** ①被削材、加工形状に合わせて、適切なクーラントを使用してください。
 ②この標準切削条件表は切削条件の目安を示すものです。実際の加工では加工形状、目的、使用機械等により条件を調整してください。
- [Note]** ① Use the appropriate coolant for the work material and machining shape.
 ② These Recommended Cutting Conditions indicate only the rule of a thumb for the cutting conditions. In actual machining, the condition should be adjusted according to the machining shape, purpose and the machine type.

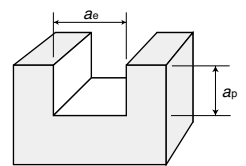

<溝切削> Slotting

被削材 (硬さ) Work material (Hardness)	条件域 Condition Range	切込み Depth of cut mm	切削条件 Cutting Conditions	外径 DC Tool dia. (mm)											
				$\phi 6$	$\phi 8$	$\phi 10$	$\phi 12$	$\phi 16$	$\phi 20$	$\phi 25$	$\phi 30$	$\phi 35$	$\phi 40$	$\phi 45$	$\phi 50$
鋳鉄・炭素鋼 Cast irons, Carbon steels (200HB以下) FC200 SS400, S45C	汎用条件 General	$a_p=1DC$ (MAX30mm) $a_e=1DC$	回転数 min ⁻¹	1,100	890	710	590	440	350	280	230	200	170	150	140
			送り速度 mm/min	90	110	110	120	110	100	90	85	80	75	65	60
合金鋼 Alloy steels (200~250HB) SCM, SNCM	汎用条件 General	$a_p=1DC$ (MAX30mm) $a_e=1DC$	回転数 min ⁻¹	900	670	540	450	330	270	210	180	150	130	120	100
			送り速度 mm/min	70	80	85	90	80	75	65	65	60	55	55	45
工具鋼・ステンレス鋼 Tool steels, Stainless steels (25~35HRC) SKD, SKT, SUS304	汎用条件 General	$a_p=1DC$ (MAX30mm) $a_e=1DC$	回転数 min ⁻¹	740	550	440	370	270	220	170	140	120	110	95	85
			送り速度 mm/min	30	45	55	60	55	55	50	45	45	45	40	35
アルミ合金・非鉄金属 Aluminum alloys Non Ferrous	汎用条件 General	$a_p=1DC$ (MAX30mm) $a_e=1DC$	回転数 min ⁻¹	3,400	2,500	2,000	1,700	1,200	1,000	820	680	590	510	450	410
			送り速度 mm/min	140	200	240	270	240	240	230	220	210	200	180	160

- [注意]** ①被削材、加工形状に合わせて、適切なクーラントを使用してください。
 ②この標準切削条件表は切削条件の目安を示すものです。実際の加工では加工形状、目的、使用機械等により条件を調整してください。
- [Note]** ① Use the appropriate coolant for the work material and machining shape.
 ② These Recommended Cutting Conditions indicate only the rule of a thumb for the cutting conditions. In actual machining, the condition should be adjusted according to the machining shape, purpose and the machine type.

標準切削条件表

○ スーパーカットエンドミル

寸法表 Size list : H72

GRFR
レギュラー刃長
Regular

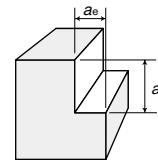

a_p : $\phi 40$ 以下 = 1.4DC
 $\phi 45$ 以上 = 1.6DC
 $a_e = 0.5DC$

<側面切削> Side milling

被削材 (硬さ) Work material (Hardness)	条件域 Condition Range	切込み Depth of cut mm	切削条件 Cutting Conditions	外径 DC Tool dia. (mm)											
				$\phi 6$	$\phi 8$	$\phi 10$	$\phi 12$	$\phi 16$	$\phi 20$	$\phi 25$	$\phi 30$	$\phi 35$	$\phi 40$	$\phi 45$	$\phi 50$
鋳鉄・炭素鋼 Cast irons, Carbon steels (200HB 以下) FC200 SS400, S45C	汎用条件 General	右上図 参照	回転数 min ⁻¹	1,400	1,000	870	720	540	430	350	290	250	210	190	170
			送り速度 mm/min	110	120	140	140	130	120	110	100	100	90	85	75
合金鋼 Alloy steels (200~250HB) SCM, SNCM	汎用条件 General	右上図 参照	回転数 min ⁻¹	1,000	790	630	530	390	310	250	210	180	150	140	120
			送り速度 mm/min	80	95	100	110	95	85	80	75	70	65	60	55
工具鋼・ステンレス鋼 Tool steels, Stainless steels (25~35HRC) SKD, SKT, SUS304	汎用条件 General	右上図 参照	回転数 min ⁻¹	840	630	500	420	310	250	200	160	140	120	110	100
			送り速度 mm/min	65	75	80	85	75	70	65	60	55	55	50	45
焼入れ鋼・プリハードン鋼 Hardened steels, Pre-hardened steels (35~45HRC) SKD, SKT HPM1, NAK55	汎用条件 General	右上図 参照	回転数 min ⁻¹	630	470	380	310	230	190	150	120	100	95	80	75
			送り速度 mm/min	25	40	45	50	45	45	40	40	35	35	30	30
耐熱鋼・チタン合金 Heat-resistant steels, Titanium alloys Inconel Ti-6Al-4V	汎用条件 General	右上図 参照	回転数 min ⁻¹	310	230	190	150	110	95	75	60	50	45	40	35
			送り速度 mm/min	12	18	25	25	20	20	20	20	18	18	16	14
アルミ合金・非鉄金属 Aluminum alloys Non Ferrous	汎用条件 General	右上図 参照	回転数 min ⁻¹	4,200	3,100	2,500	2,100	1,500	1,200	1,000	840	720	630	560	500
			送り速度 mm/min	170	250	300	340	300	290	280	270	260	250	220	200

- [注意]** ①被削材、加工形状に合わせて、適切なクーラントを使用してください。
 ②この標準切削条件表は切削条件の目安を示すものです。実際の加工では加工形状、目的、使用機械等により条件を調整してください。
- [Note]** ① Use the appropriate coolant for the work material and machining shape.
 ② These Recommended Cutting Conditions indicate only the rule of a thumb for the cutting conditions. In actual machining, the condition should be adjusted according to the machining shape, purpose and the machine type.

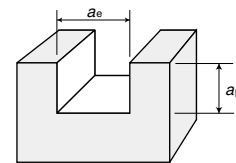

<溝切削> Slotting

被削材 (硬さ) Work material (Hardness)	条件域 Condition Range	切込み Depth of cut mm	切削条件 Cutting Conditions	外径 DC Tool dia. (mm)											
				$\phi 6$	$\phi 8$	$\phi 10$	$\phi 12$	$\phi 16$	$\phi 20$	$\phi 25$	$\phi 30$	$\phi 35$	$\phi 40$	$\phi 45$	$\phi 50$
鋳鉄・炭素鋼 Cast irons, Carbon steels (200HB 以下) FC200 SS400, S45C	汎用条件 General	$a_p=1DC$ (MAX30mm) $a_e=1DC$	回転数 min ⁻¹	1,000	790	630	530	390	310	250	210	180	150	140	120
			送り速度 mm/min	80	95	100	110	95	85	80	75	70	65	60	55
合金鋼 Alloy steels (200~250HB) SCM, SNCM	汎用条件 General	$a_p=1DC$ (MAX30mm) $a_e=1DC$	回転数 min ⁻¹	790	590	470	390	290	230	190	150	130	110	100	95
			送り速度 mm/min	65	70	75	80	70	65	60	55	50	50	45	40
工具鋼・ステンレス鋼 Tool steels, Stainless steels (25~35HRC) SKD, SKT, SUS304	汎用条件 General	$a_p=1DC$ (MAX30mm) $a_e=1DC$	回転数 min ⁻¹	630	470	380	310	230	190	150	120	100	95	80	75
			送り速度 mm/min	50	55	60	60	55	55	50	45	40	40	35	35

- [注意]** ①被削材、加工形状に合わせて、適切なクーラントを使用してください。
 ②この標準切削条件表は切削条件の目安を示すものです。実際の加工では加工形状、目的、使用機械等により条件を調整してください。
- [Note]** ① Use the appropriate coolant for the work material and machining shape.
 ② These Recommended Cutting Conditions indicate only the rule of a thumb for the cutting conditions. In actual machining, the condition should be adjusted according to the machining shape, purpose and the machine type.

GCコートラフィングエンドミル

寸法表 Size list : H72 寸法表 Size list : H73 寸法表 Size list : H73

GCQS	GRQR	GQR
ショート刃長 Short	レギュラー刃長 Regular	レギュラー刃長 Regular

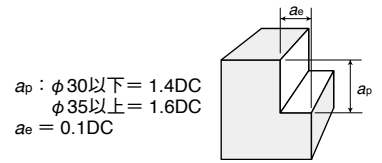

<側面切削> Side milling

被削材 (硬さ) Work material (Hardness)	条件域 Condition Range	切込み Depth of cut mm	切削条件 Cutting Conditions	外径 DC Tool dia. (mm)											
				φ6	φ8	φ10	φ12	φ16	φ20	φ25	φ30	φ35	φ40	φ45	φ50
铸铁・炭素鋼 Cast irons, Carbon steels (200HB 以下) FC200 SS400, S45C	汎用条件 General	右上図 参照	回転数 min ⁻¹	1,430	1,070	860	710	530	430	300	250	220	200	160	160
			送り速度 mm/min	110	120	125	145	145	140	120	100	95	90	90	90
合金鋼 Alloy steels (200~250HB) SCM, SNCM	汎用条件 General	右上図 参照	回転数 min ⁻¹	1,160	870	700	580	430	350	250	200	170	150	130	120
			送り速度 mm/min	85	85	95	95	95	95	85	70	65	55	55	55
工具鋼・ステンレス鋼 Tool steels, Stainless steels (25~35HRC) SKD, SKT, SUS304	汎用条件 General	右上図 参照	回転数 min ⁻¹	950	720	550	470	350	280	200	170	140	130	110	100
			送り速度 mm/min	55	60	65	65	65	60	50	50	50	45	45	45
焼入れ鋼・プリハードン鋼 Hardened steels, Pre-Harden steels (35~45HRC) SKD, SKT HPM1, NAK55	汎用条件 General	右上図 参照	回転数 min ⁻¹	640	450	380	320	230	190	150	120	100	90	80	75
			送り速度 mm/min	35	35	35	35	35	35	35	35	32	30	30	30
耐熱鋼・チタン合金 Heat-resistant steels Titanium alloys Inconel Ti-6Al-4V	汎用条件 General	右上図 参照	回転数 min ⁻¹	350	270	220	180	140	110	90	70	60	50	45	40
			送り速度 mm/min	25	25	25	25	25	20	20	17	16	15	15	15
アルミ合金 非鉄金属 Aluminum alloys Non Ferrous	汎用条件 General	右上図 参照	回転数 min ⁻¹	4,200	3,100	2,500	2,100	1,600	1,200	1,000	850	730	640	560	500
			送り速度 mm/min	120	150	150	150	150	150	150	150	140	140	140	140

- 【注意】** ①被削材、加工形状に合わせて、適切なクーラントを使用してください。
 ②この標準切削条件表は切削条件の目安を示すものです。実際の加工では加工形状、目的、使用機械等により条件を調整してください。
- 【Note】** ① Use the appropriate coolant for the work material and machining shape.
 ② These Recommended Cutting Conditions indicate only the rule of a thumb for the cutting conditions. In actual machining, the condition should be adjusted according to the machining shape, purpose and the machine type.

ESMテーパエンドミル

寸法表 Size list : H76

寸法表 Size list : H78

寸法表 Size list : H77

寸法表 Size list : H78

2ESMTS

2ESMTR

4ESMTS (注①)

4ESMTR (注①②)

2枚刃・ショート刃長
2ft, Short

2枚刃・レギュラー刃長
2ft, Regular

4枚刃・ショート刃長
4ft, Short

4枚刃・レギュラー刃長
4ft, Regular

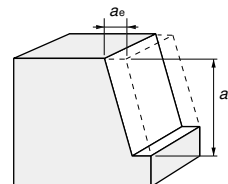

<側面切削> Side milling

被削材 (硬さ) Work material (Hardness)	条件域 Condition Range	切込み Depth of cut mm	切削条件 Cutting Conditions	外径 DC Tool dia.(mm)						
				φ2	φ3	φ4	φ5	φ6	φ8	φ10
炭素鋼・合金鋼 Carbon steels, Alloy steels (~20HRC)	汎用条件 General	$a_p=2.5DC$ 以下 $a_e=0.05DC$ 以下	回転数 min^{-1}	3,500	2,500	1,800	1,500	1,200	900	700
			送り速度 mm/min	45	45	45	50	50	50	50
合金鋼・工具鋼 ステンレス鋼 Alloy steels, Tool steels Stainless steels (20~30HRC)	汎用条件 General	$a_p=2.5DC$ 以下 $a_e=0.05DC$ 以下	回転数 min^{-1}	3,200	2,200	1,600	1,300	1,050	800	640
			送り速度 mm/min	35	35	35	38	42	42	42
プリハードン鋼 Pre-Harden steels (30~40HRC)	汎用条件 General	$a_p=2.5DC$ 以下 $a_e=0.05DC$ 以下	回転数 min^{-1}	2,500	1,700	1,250	1,000	850	640	510
			送り速度 mm/min	20	20	20	25	25	25	25

【注意】

- ①被削材、加工形状に合わせて、適切なクーラントを使用してください。
- ②この標準切削条件表は切削条件の目安を示すものです。実際の加工では加工形状、目的、使用機械等により条件を調整してください。
- ③上表は2枚刃、側面仕上げ切削時の条件表です。4枚刃の場合は、送り速度を2倍に上げてください。
- ④レギュラー刃の場合は、回転数と送り速度を約70%にしてください。
- ⑤機械剛性等によりびびり等が発生する場合は、回転数と送り速度を同じ比率で下げてください。

【Note】

- ① Use the appropriate coolant for the work material and machining shape.
- ② These Recommended Cutting Conditions indicate only the rule of a thumb for the cutting conditions. In actual machining, the condition should be adjusted according to the machining shape, purpose and the machine type.
- ③ The above table shows the cutting conditions for side finish milling using 2 flutes. For 4 flutes, the feed rate should be doubled.
- ④ For regular flutes, the rotation speed and feed rate should be set to approximately 70%.
- ⑤ Depending on the machine rigidity, etc., if chattering occurs, reduce both the rotation speed and feed rate by the same ratio.

技術資料

Technical Data

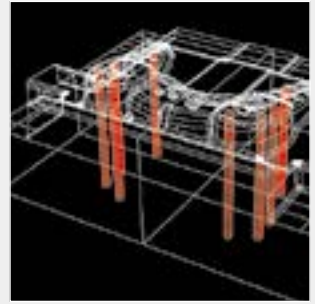

エンドミル End Mills	エンドミル各部の名称とエンド外径について…………… I2 Name of parts for end mills and shapes of end cutting edges
	エンドミルの刃形と切削性…………… I4 Flute shape and cutting ability of end mills
	エンドミルの切削条件の求め方…………… I5 How to determine cutting conditions of end mills
	エンドミル使用上のご注意…………… I6 Precautions in handling an end mill
刃先交換式工具 Indexable Tools	エンドミル加工のトラブルと原因対策…………… I7 Trouble shooting for end milling
	フライス工具の各部の名称と刃先角度の役割…………… I9 Names of parts and roles for milling tools
	フライス用インサート各部の名称と役割…………… I12 Names of parts and roles for milling inserts
	フライス加工切削条件の選び方…………… I14 How to select cutting conditions for milling
	フライス加工におけるトラブルと原因対策…………… I15 Cutting condition formula (milling) and trouble shooting
旋削工具 Turning Tools	フライス用SD,SE,TE形標準インサートの各社形番対照表 …… I16 Comparison of inserts for milling SD,SE,TE type
	フライス加工の各社材種対応表…………… I17 Table of corresponding materials from various companies for milling
	旋削工具各部の名称と刃先角度の役割…………… I19 Nomenclature of turning tools parts and role of nose angle
	旋削用インサート形状と使用用途…………… I20 Shapes of inserts and application of turning
	旋削の切りくず処理…………… I21 Chips removal of turning
	旋削に関する計算式…………… I22 Cutting condition formula for turning
ドリル Drills	旋削における工具損傷対策…………… I23 Counter-measures against brackage of tools
	旋削における各要因の切削性能への影響…………… I24 Relationship between cutting elements and cutting performance in turning
	旋削の各社インサートブレーカ対照表…………… I25 Comparison against competitor's insert breakers of turning
	旋削の各社材種対応表…………… I26 Table of corresponding materials from various companies for turning
参考資料 Reference data	ドリル各部の名称と働き…………… I27 Name and function of each part of a drill
	タップ下穴に相当するドリル径…………… I28 Drill dia. equivalent to a hole size before tapping
	ドリル加工計算式…………… I28 Drilling work equations
	ドリル加工のトラブルと原因対策…………… I29 Trouble shooting of drilling work
	穴の公差等級並びに寸法許容差…………… I31 Standard tolerance grades and limit deviations for holes
	ねじの寸法規格…………… I32 Dimension standard for screw threads
	工具鋼のブランド対照表…………… I37 Table of corresponding Tool Steels brands
	表面粗さ…………… I41 Surface roughness
	被削性指数…………… I42 Machinability indices
	硬さ換算表…………… I43 Hardness conversion table

○ (3) エンドミル刃部の形状 Shape of end mills flute

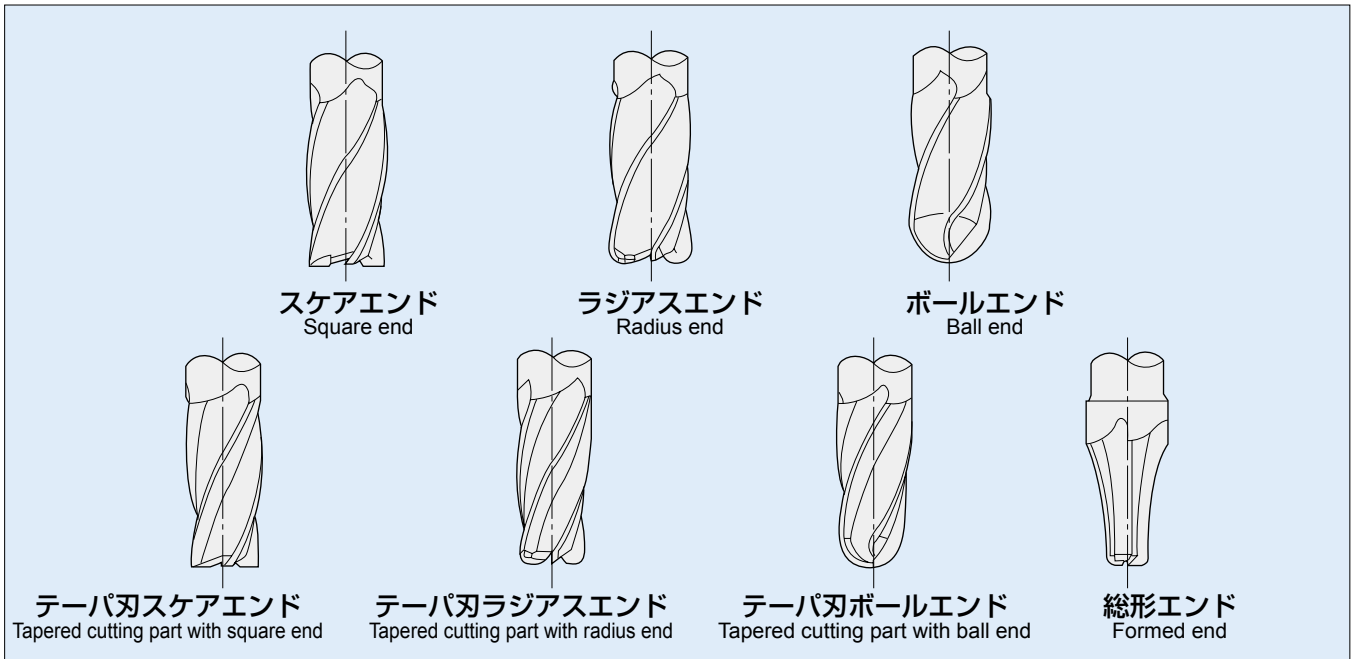

○ (4) シャンクの種類 Kind of end mill shank

シャンクの種類	名称・特徴
	ストレートシャンク (プレーンシャンク) Straight shank (Plain shank) ・ 通常φ6～φ42で使用される。 ・ Shanks of φ6 to φ42 are usually used.
	フラット付きストレートシャンク (サイドロックシャンク) (ウエルドンシャンク) Straight shank with flat (side lock shank) (Weldon shank) ・ 米国普及品。 ・ φ20以上はダブルフラット付き ・ Popular in U.S.A. ・ Products of φ20 or larger have double flats.
	傾斜フラット付き ストレートシャンク Straight shank with sloped flat Straight shank ・ 軸方向調整機能付き ・ With axial adjusting function
	ねじ付きストレートシャンク Straight shank with screw ・ 欧州普及品 ・ Popular in Europe

シャンクの種類	名称・特徴
	コンビネーションシャンク (ダイナシャンク) Combination shank (Dyna shank) ・ 大径シャンク用。 ・ 国内ではφ50.8が普及。 ・ For shanks with a large diameter ・ A shank of φ50.8 is popular in Japan.
	引きねじ付きテーパシャンク Taper shank with drawing screw ・ モールステーパB&Sテーパがある ・ Available with Morse taper and B&S taper
	BT シャンク BT shank ・ マシニングセンタ用 ・ ATC 用 ・ For a machining center ・ For ATC
	7/24 テーパーシャンク (ナショナルテーパシャンク) 7/24 taper shank (National taper shank) ・ 機械直付け用 ・ Directly attached to a machine.

・フラット、外ねじの寸法はご指定のない場合は、当社規定によります。引きねじはミリ、インチをご指定ください。
 Dimension of flat and outside screw, if not specified, should be in accordance with the stipulations. Please specify dimension of drawing screw in mm or inch.

Flute shape and cutting ability of end mills

エンドミルの刃形と切削性

① 外径 DC と刃長 ℓ

Mill diameter (DC) and flute length (ℓ)

切削工具の切削性は、シャープな切れ刃と刃部の剛性とから得られますが、エンドミルではとくに剛性が重要な因子となります。剛性が低いと切削中にエンドミルがたわんで振動が生じます。その結果加工精度を悪くし、エンドミルの摩耗を早めますので、切削条件を最大限に生かせません。

エンドミルの剛性は、外径 DC と刃長 APMX で決まると考えてよく、たわみについては概略

Cutting ability of cutting tools depends on sharpness of cutting edges and stiffness of cutting part. Particularly, stiffness is a significant factor in using an end mill. Low stiffness may cause vibration during cutting work due to a deflected end mill, resulting in poor machining precision and early wear of end mills. Therefore, low stiffness will not allow cutting conditions to be exploited to the full stiffness of an end mill is determined by the mill diameter, DC, and the flute length, ℓ. Deflection is practically given by the following formula :

$$\delta = C \frac{APMX^3}{DC^4}$$

ただし、 δ : たわみ

C : 定数

where T is deflection and C is constant.

の関係があります。つまり計算上は刃長が 25%長くなるとたわみは2倍に大きくなり、外径が20%太くなると半分に減少します。また、工具寿命への影響も下図より明らかで、加工部位の形状によりますが、能率切削のためには、できるだけ剛性の大きい工具が推奨されます。ロングシャンクエンドミルは、ロング刃長のエンドミルよりも刃長をおさえ、剛性の大きいシャンク部を長くしてあり、深彫加工に適します。

In brief, deflection increases twice if the flute length increases by 25%, or it decreases one-half if the mill diameter increases by 20%. The following shows the effect of flute length on cutting life of tools, indicating that it is recommended to use a tool with as high stiffness as possible to obtain high efficiency cutting. The long shank type end mill has short flute length and long shank with high stiffness compared with the long flute length type, and is suited to deep contouring.

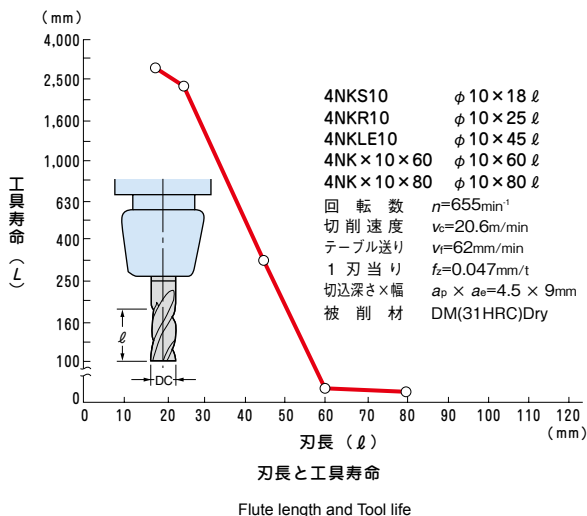

② ねじれ角について

Helix angle

通常、エンドミルのねじれ角は、右ねじれ 30° 前後で作られています。ねじれ角は次のような機能があります。

- ① 切削抵抗の断続的な変動を緩和し、振動をやわらげ工具寿命を延ばします。
- ② 被削材へのくい付きがよくなり、切削力が減少します。
- ③ 切りくずを軸方向に排出し、切削面への切りくずのかみ込みをなくします。

しかし、ねじれ角が大きい場合は、軸方向に切削力がかかるので工具の保持を強固にしなければなりません。また、工具剛性や主軸クリアランスの関係で切削面がわずかに傾くことに注意が必要です。

当社では、工具剛性を大きくできる場合に 45°~60°ねじれを製品化しています。また、加工精度の厳しいキー溝用エンドミルは、12° ねじれを採用しております。

End mills usually adopt right-hand helix angle of approximately 30°. Helix angle has the following effects :

- ① Helix angle relieves intermittent fluctuation of cutting resistance, lightens vibration, and prolongs cutting life of tools.
- ② Helix angle enables smooth bite into work material, and reduces necessary cutting force.
- ③ Helix angle allows chips to be discharged in axial direction, and becomes free from jamming of chips.

In the case of high helix angle, however, a tool must be held securely since cutting force is applied in the axial direction. Besides, care must be taken on the surface to be cut which is slightly inclined due to the relation between tool stiffness and clearance of main spindle. Manufactures end mills with high helix angle of 45° to 60° at which high stiffness of tool is secured. As for key-way end mills for which strict machining precision is required, 12° of helix angle is adopted.

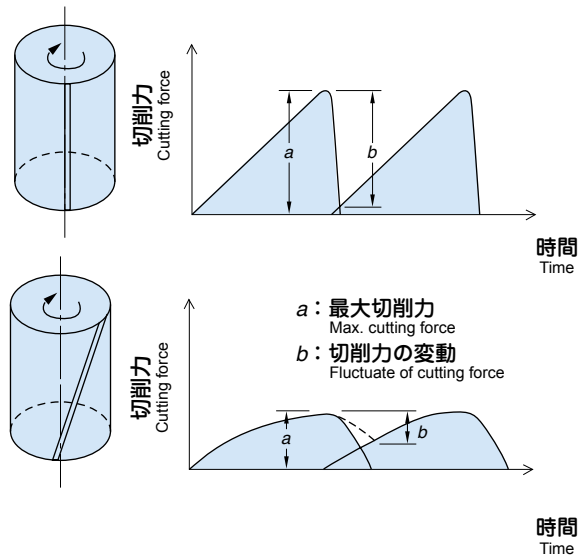

How to determine cutting conditions of end mills

エンドミルの切削条件の求め方

○ (1) 切削速度 (vc) と回転数 (n)

Cutting speed (vc) and revolution number (n)

回転数 (n) は、切削速度と使用する工具の外径から次式により計算します。ただし、ボールエンドミルでボール刃部分のみで切削する場合は、実質的な工具外径は切削部分の最大径となります。計算の際は DC を切削状況に合わせ、小さく設定してください。

The revolution number (n) is calculated by the following formula using cutting speed and flute length of the tool to be used. When cutting work is performed by using only a ball end cutting part of a ball end mill, however, select a tool with the substantial flute length equal to the maximum diameter of the portion to be cut. In calculation, set DC to a smaller value according to the cutting condition.

$$n = \frac{1000 \times v_c}{\pi \times DC} \quad (\text{min}^{-1})$$

n : 回転数 min⁻¹
 Revolution, min⁻¹
 DC : 外径 mm
 Tool diameter, mm
 vc : 切削速度 m/min
 Cutting speed, m/min.
 π : 円周率 (3.14)
 Ratio of circumference of a circle to its diameter (3.14)

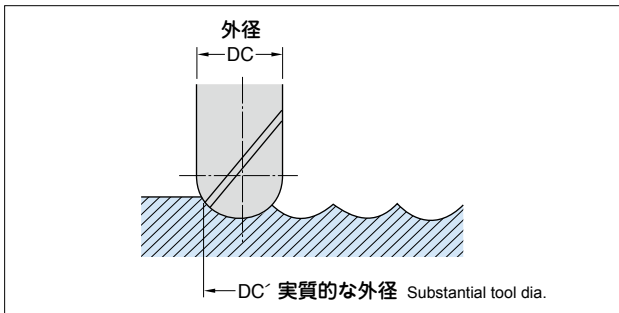

○ (2) 送り速度 (vf) と1刃当たり送り (fz)

Feed speed (vf) and feed per tooth (fz)

作業能率は、テーブルの送り速度 (vf) で決まりますが、切削条件は1刃当たり送り (fz) をさきに定めます。ほかの条件は工具の大きさ(外径と刃長)、刃数、被削材の被削性、加工精度、機械容量などを考慮して決定します。

Working efficiency is determined by the table speed (vf), but the feed per tooth should be fixed first of all in setting cutting conditions. Other conditions should be determined considering dimension of a tool (mill diameter and flute length), number of flutes, work ability of work material to be used, machining precision, and capacity of a machine to be used.

送り速度は、1刃当たり送りから次式で計算します。

$$v_f = f_z \times z \times n \quad (\text{mm/min})$$

vf : 送り速度 mm/min
 Feed speed, mm/min.
 fz : 1刃当たり送り mm/t
 Feed/tooth, mm/tooth
 z : 刃数
 Number of flutes
 n : 回転数 min⁻¹
 Revolution, min⁻¹

○ (3) 切込み (ap × ae) Depth of cut (ap × ae)

切り込み量は、取り代の大きさに決まります。加工目的に合わせて、推奨条件の切り込み量を参考にしてください。

Depth of cut (ap × ae) is basically determined by the size of machining allowance. Please refer each item recommend cutting condition to match cutting purpose.

○ (4) 切りくず排出量 (Q) Chip removal volume (Q)

$$Q = \frac{a_p \times a_e \times v_f}{1000} \quad (\text{cm}^3/\text{min})$$

Q : 切りくず排出量 cm³/min
 Chip removal volume
 ap : 切込み深さ mm
 Cutting depth
 ae : 切削幅 mm
 Cutting width
 vf : 1分間当りのテーブル送り速度 mm/min
 Feed rate per minute of table

○ (5) ボールエンドミルのピックフィードと理論カスプハイト表 (μm) Ball end mill pick feed and theoretical cusp height table (μm)

		ピックフィード量 : ae (mm) Pick Feed							
		0.05	0.075	0.1	0.15	0.2	0.3	0.4	0.5
ボール半径 RE Ball Radius (mm)	0.5	0.63	1.41	2.51	5.66	10.10	23.03	41.74	66.99
	1.0	0.31	0.70	1.25	2.82	5.01	11.31	20.20	31.75
	2.0	0.16	0.35	0.63	1.41	2.50	5.63	10.03	15.69
	3.0	0.10	0.23	0.42	0.94	1.67	3.75	6.67	10.43
	4.0	0.08	0.18	0.31	0.70	1.25	2.81	5.00	7.82
	5.0	0.06	0.14	0.25	0.56	1.00	2.25	4.00	6.25
	6.0	0.05	0.12	0.21	0.47	0.83	1.88	3.33	5.21
	8.0	0.04	0.09	0.16	0.35	0.63	1.41	2.50	3.91
	10.0	0.03	0.07	0.13	0.28	0.50	1.13	2.00	3.13

ピックフィードとカスプハイト
 Pick Feed and Cusp Height
 $H = RE - \sqrt{RE^2 - a_e^2/4} \approx a_e^2/8RE$

Technical Data
 End Mills

Precautions in handling an end mill

エンドミル使用上のご注意

○ (1) 機械 Machine

- ・加工物の大きさに見合った機械を選んでください。加工精度と加工能率を得るのに必要な動力と機械剛性を有していることが重要です。
- ・使用するエンドミルに適する回転数や送り速度が選べることを確認してください。
- ・Select a machine consistent with the size of work piece to be used. It is important that the machine has enough power and mechanical stiffness to achieve necessary machining precision and machining efficiency.
- ・Check whether you can set the machine to the revolution number and feed speed suitable for the end mill to be used.

○ (2) ツーリング Tooling

- ・エンドミルホルダは、精度と把握力が十分なものを使用してください。とくに小径エンドミルでは振れが、大径やラフィング刃では把握力が大切です。
- ・加工物の固定を確実にしてください。強ねじれ刃を使用の場合や重切削の場合は、ワークのがたつきや工具の抜け出しにご注意ください。
- ・Use an end mill holder with sufficient precision and grasping force. In using an end mill with a small mill diameter, select an end mill holder mainly considering deflection. When using an end mill with a large mill diameter or a roughing type end mill, it is important for an end mill holder to have sufficient grasping force.
- ・Fix the work piece securely. When using an end mill with high helix angle or when performing heavy duty cutting, be careful about shaking of the work piece and slipping of the tool.

○ (3) エンドミルの選択 Selection of an end mill

- ・作業目的に合ったエンドミルをご使用ください。疑問のある場合は、当社へご相談ください。
- ・切削性本位には大径でショート刃形状とし、工具剛性の大きなものが推奨されますが、テーブルの送り速度は1刃当りの送りとの関係で外径15～25mm付近が最も大きくできます。取り代と併せてご検討ください。
- ・Be sure to use an end mill matching the working purpose. If you have any question, please make contact with us.
- ・It is recommended to use a short flute length type end mill with a large mill diameter and tool stiffness, when you consider cutting ability first. To obtain the maximum feed speed of the table, use an end mill with approximately 15 to 25 mm of mill diameter, because the feed speed is dependent on the feed per tooth. Carry out a detailed study in selecting an end mill in addition to allowance.

○ (4) 作業 Work

- ・切削条件は加工物や作業条件で激しく変化しますが、標準条件表を参考にして、適宜増減してください。
- ・ホルダやエンドミルのオーバハングは可能な限り短かくしてご使用ください。ドゥエリング（静止位置回転）は逃げ面摩耗を早めますのでなるべくお避けください。
- ・できるだけ切削油をご使用ください。切削箇所へ十分な量を供給してください。また、切込みの大きい場合は切りくず排除の目的で高圧で切削油、ミストまたはエアを供給することをお勧めします。
- ・エンドミルの再研削は下表を参考にして、早や目に行ってください。摩耗幅が限度を超えると急速に摩耗が進行し、再生できないことがあります。
- ・超硬エンドミルの場合は、ハイスエンドミルの50%～60%を目安にしてください。一般に未使用品に比べ再研削に時間を要します。過大摩耗はチップングの原因にもなりますのでご注意ください。
- ・Cutting conditions vary with the kind of work piece and change of working conditions. Refer to the table of standard conditions to select proper conditions.
- ・The overhang of the holder or the end mill should be as short as possible.
- ・Avoid dwelling because it may hasten wear of flanks.
- ・It is better to use cutting fluid, if possible.
- ・Apply a sufficient amount of cutting fluid to the place to be cut. In the case of large depth of cut, it is recommended to supply cutting fluid, mist, or air to the place at high pressure during cutting in order to discharge chips.
- ・Perform re-grinding of a worn-out end mill as early as possible after referring to the following table. There may be cases where, if depth of wear exceeds the limit, wear may proceed so rapidly that re-grinding may become impossible for re-utilization.
- ・As for carbide end mills, re-grind them when the depth of wear reaches 50% to 60% of the limit value of high speed steel end mills. Generally, it takes more time to re-grind the worn end mill than an unused one. Be careful of excessive abrasion because it may cause chipping.

表3 逃げ面摩耗幅による再研削時期の判定 Judgment of re-grinding time based on depth of wear on a flank 単位mm

		仕上げ用 Finishing	荒加工用 Roughing	ラフィング刃 Roughing flute
ハイス High speed steel	外径10以下 Tool Dia. under 10	0.1 ~ 0.15	0.15 ~ 0.2	—
	外径10~30 Tool Dia. 10~30	0.15 ~ 0.2	0.2 ~ 0.3	0.3 ~ 0.5
	外径30以上 Tool Dia. over 30	0.2 ~ 0.3	0.3 ~ 0.5	0.5 ~ 0.7

○ 標準切削条件の選定 Selection of standard cutting conditions

新しい作業の立上げの目安としてご利用ください。最適切削条件は上述のご注意のほか、種々の要因があります。Use them as a guide in starting a new work. To select the optimum cutting conditions, take various factors into consideration in addition to the cautions described above :

- ・被削材が硬目の場合や切込みが大きい場合やロング刃長を使用の場合は、回転数を低めに設定してください。
- ・寸法精度や仕上げ面粗さが重要な場合や機械出力の小さい場合は、送り速度を低くしてください。
- ・精度重視の作業には、一般に多刃エンドミルが適当です。
- ・When using hard work material, in the case of large depth of cut, or when using an end mill with long flute length, set the revolution number to the lower value.
- ・If high dimensional precision or excellent roughness of finished surface is significantly required, or when output of a machine to be used is low, set the feed speed to the lower value.
- ・Multi-flute end mills are generally suitable for cutting works requiring high precision.

エンドミル加工のトラブルと原因対策

トラブル現象	原因	対策
切削中のびびり	<ul style="list-style-type: none"> ・外周逃げ角、すくい角が大きく、切れ刃角が小さい。 ・ワークの取付けがよくない。 ・機械、チャックの剛性不足。 ・切削速度、送り速度が速い。 	<ul style="list-style-type: none"> ・逃げ角、すくい角を適正にする。 ・ワークを強固にとりつける。 ・機械、チャックの交換。 ・切削条件を変更する。
切削中の折損	<ul style="list-style-type: none"> ・エンドミルの腰が弱い。 ・送り速度が速い。 ・切込みが大きい。 ・突き出し長が長い。 ・切れ刃が摩耗している。 ・必要以上に刃長が長い。 	<ul style="list-style-type: none"> ・剛性設計の工具を使用する。 ・送り速度を遅くする。 ・切込みを少なくする。 ・突き出し長さを短くする。 ・早期に再研削する。 ・短い刃長のものにとりかえる。
切削中の刃かけ	<ul style="list-style-type: none"> ・ワークの固定が弱い。 ・送り速度が速い。 ・刃先角が小さい。 ・チャックの締付け不足。 ・切込みが大きい。 ・機械の剛性不足。 	<ul style="list-style-type: none"> ・ワークを強固に固定する。 ・送り速度を下げる。 ・角度を適正に研削する。 ・工具のチャッキングを確実にする。 ・切込みを少なくする。 ・機械を変更にする。
摩耗、焼けが著しい	<ul style="list-style-type: none"> ・切削速度が速い。 ・外周逃げ角が小さい。 ・被削材硬さが高い。 	<ul style="list-style-type: none"> ・切削速度を遅くする。 ・適正逃げ角に修正する。 ・工具に表面処理を行う。
切れ味が悪い	<ul style="list-style-type: none"> ・切れ刃の摩耗が大きい。 ・被削材と工具の不適合。 ・すくい角が小さい。 	<ul style="list-style-type: none"> ・再研削を行う。 ・専用工具を使用する。 ・適正すくい角に修正する。
切れくずづまり	<ul style="list-style-type: none"> ・切削量が大きすぎる。 ・チップポケットが小さい。 ・切削油が少ない。 ・チップポケットの形状が悪い。 	<ul style="list-style-type: none"> ・送り速度、切込み量を調整する。 ・刃数の少ないエンドミルを使う。 ・切削油を多量にかける。 ・適正形状に修正する。
仕上面のかえり	<ul style="list-style-type: none"> ・外周逃げ面摩耗が大きい。 ・切削条件の選定ミス。 ・外周逃げ角、すくい角が不適合。 	<ul style="list-style-type: none"> ・早期に再研削する。 ・切削条件を見直す。 ・適正な角度に修正する。
仕上面粗さが悪い	<ul style="list-style-type: none"> ・送り速度が速い。 ・切削速度が遅い。 ・切れ刃の摩耗が大きい。 ・切りくずのかみ込み。 ・エンド刃の中低勾配が小さい。 	<ul style="list-style-type: none"> ・送り速度を下げる。 ・回転を上げる。 ・再研削する。 ・切込みを小さくする。 ・中低勾配を大きくする。
切削溝のたおれ	<ul style="list-style-type: none"> ・送り速度が速い。 ・ねじれ角が大きい。 ・オーバハングが長い。 ・切込みが大きい。 	<ul style="list-style-type: none"> ・送り速度を下げる。 ・ねじれ角の弱いものを使用する。 ・突き出し長さを短くする。 ・切込みを小さくする。
寸法精度が悪い	<ul style="list-style-type: none"> ・機械、チャックの精度不良。 ・刃長が長い。 ・機械、チャックの剛性不足。 	<ul style="list-style-type: none"> ・機械、チャックを修理する。 ・適正刃長のものを使用する。 ・機械、チャック変更する。

エンドミル加工のトラブルと原因対策

Symptoms of troubles	Probable causes	Remedies
Chatter during cutting	<ul style="list-style-type: none"> · Low-angled cutting edge due to too high peripheral flank angle and rake angle · The work piece is not attached securely. · Insufficient stiffness of machine and chuck. · Too high cutting speed and feed speed. 	<ul style="list-style-type: none"> · Mend the flank angle and rake angle properly. · Fix the work piece firmly. · Replace the machine and chuck with proper ones. · Change cutting conditions.
Breakage during cutting	<ul style="list-style-type: none"> · The end mill lacks firmness. · Too high feed speed. · Too large depth of cut. · Excessively long protrusion. · Worn-out cutting edge. · The flute is longer than it need to be. 	<ul style="list-style-type: none"> · Use a tool designed to have high stiffness. · Decrease the feed rate. · Make small depth of cut. · Shorten the protrusion length. · Perform re-grinding in early stage of wear. · Replace the end mill with a new one having shorter flute length.
Broken cutting edge during cutting	<ul style="list-style-type: none"> · The work piece is not fixed firmly. · Too high feed speed. · Low-angled cutting edge. · Lack in tightening of chuck. · Too large depth of cut. · Insufficient stiffness of machine. 	<ul style="list-style-type: none"> · Fix a work piece firmly. · Decrease the feed rate. · Grind the angle properly. · Perform chucking of a tool reliably. · Make small depth of cut. · Replace the machine with a proper one.
Serious wear and burning	<ul style="list-style-type: none"> · Too high cutting speed. · Excessively small peripheral flank angle. · Hardness of the work material is too high. 	<ul style="list-style-type: none"> · Slow down the revolution number. · Modify the flank angle properly. · Apply surface treatment to a tool to be used.
Poor cutting quality	<ul style="list-style-type: none"> · Excessively worn-out cutting edge. · A tool to be used is not suited to the work material. · Too small rake angle. 	<ul style="list-style-type: none"> · Perform re-grinding. · Use a tool specially designed for the work. · Modify the rake angle properly.
Chip clogging	<ul style="list-style-type: none"> · Too large amount of chips are produced. · Small chip pocket. · Insufficient application of cutting fluid. · Improper shape of chip pocket. 	<ul style="list-style-type: none"> · Adjust the feed speed and depth of cut. · Use an end mill having less number of flutes. · Apply a large amount of cutting fluid to work material. · Modify the chip pocket to have a proper shape.
Burr on the finished surface	<ul style="list-style-type: none"> · Seriously worn-out peripheral flank. · Mistake in selection of cutting conditions. · Improper peripheral flank angle and rake angle. 	<ul style="list-style-type: none"> · Perform re-grinding in early stage of wear. · Re-examine cutting conditions. · Modify the angle properly.
Insufficient roughness of finished surface	<ul style="list-style-type: none"> · Too high feed speed. · Too slow cutting speed. · Excessively worn-out cutting edge. · Chips bite the work material. · Too small medium to low gradient of end cutting edges. 	<ul style="list-style-type: none"> · Decrease the feed rate. · Increase the revolution number. · Perform re-grinding. · Make small depth of cut. · Make the medium to low gradient greater.
Inclination of slot	<ul style="list-style-type: none"> · Too high feed speed. · Too large helix angle. · Too long overhang. · Too large depth of cut. 	<ul style="list-style-type: none"> · Decrease the feed rate. · Use an end mill with smaller helix angle. · Shorten the protrusion length. · Make small depth of cut.
Poor dimensional precision	<ul style="list-style-type: none"> · Insufficient precision of machine and chuck. · Too long flute length. · Insufficient stiffness of machine and chuck. 	<ul style="list-style-type: none"> · Repair the machine and chuck. · Use an end mill with proper flute length. · Change the machine and chuck.

フライス工具の各部の名称と刃先角度の役割

○ フライス工具各部の名称 Name of parts of milling tool body

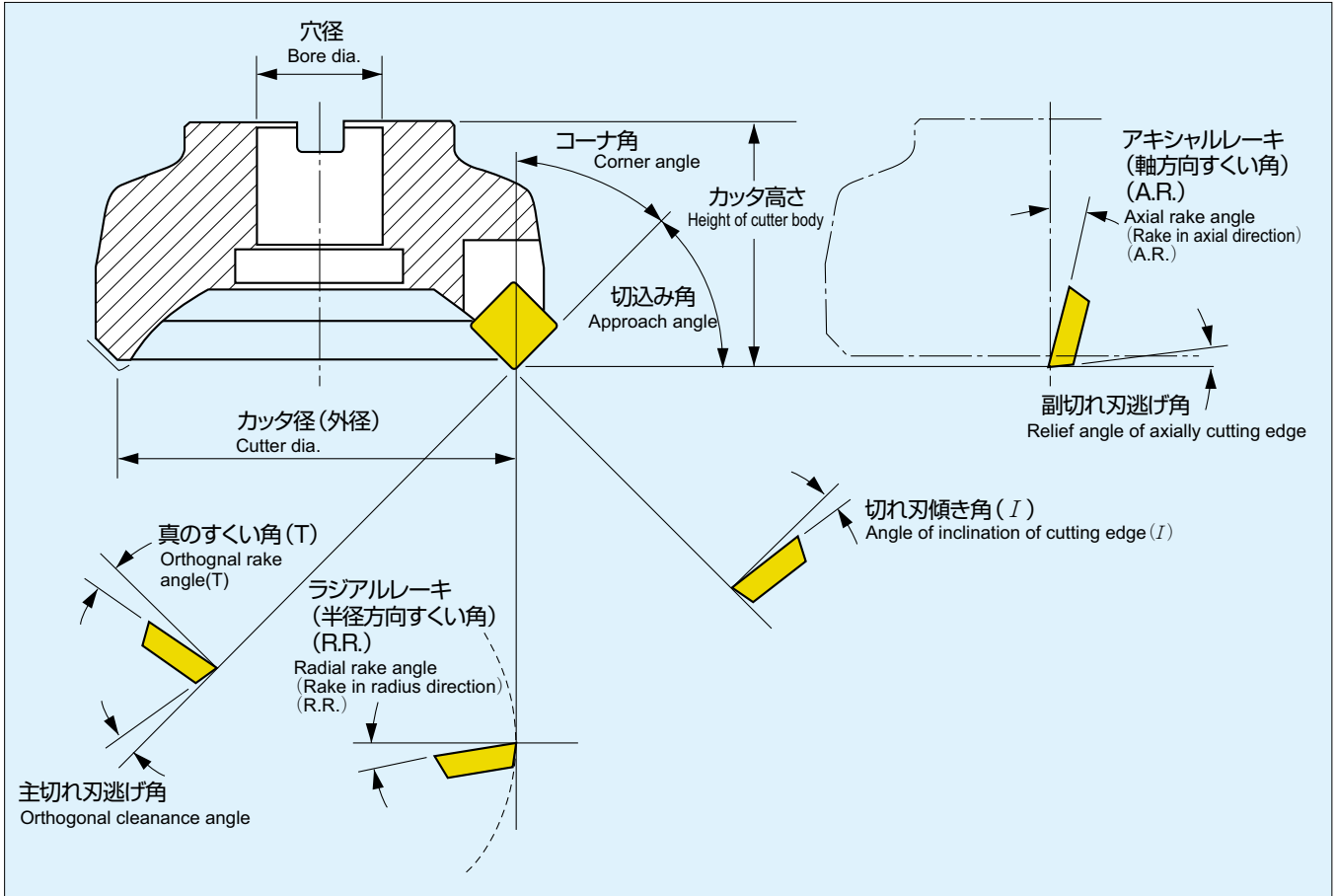

○ 真のすくい角と切削性能 Relation between Orthogonal Rake and Performance

真のすくい角 True rake	切れ味 Sharpness	切削動力 Cutting power	刃先強度 Toughness of cutting edge	発熱 Heating	切りくず排出性 Chips ejectability	耐溶着性 Welding resistance
正 (大) Positive (large) ↑	良い Good	小さい Small	弱い Weark	少ない Low	悪い。カッタ内にまき込む傾向ある Bad. May be caught by cutter.	良い Good
↓ 負 (小) Negative (small)	悪い Bad	大きい Large	強い Strong	多い High	良い。カッタの外側に出る Good. Ejected outside the cutter.	悪い Bad

真のすくい角はカッタにセットするインサートの逃げ角によってほぼ決まり、インサートの逃げ角が強い程、真のすくい角も強くなるように設定されています。

Effective rake angle is generally designed according to clearance of inserts used. The larger the clearance of an inserts is, the larger effective rake angle may be designed.

フライス工具の各部の名称と刃先角度の役割

◎ カッタ径とエンゲージ角 Cutter dia. and engage angle

エンゲージ角が大きいと被削材食付時にインサートの刃先より当たるため寿命が短くなります。
Lower engage angle shows short tool life, because engagement starts from cutting edge of inserts in milling operation.

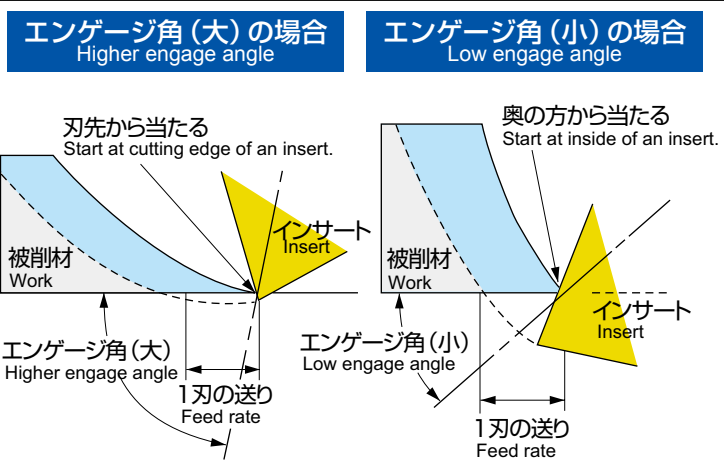
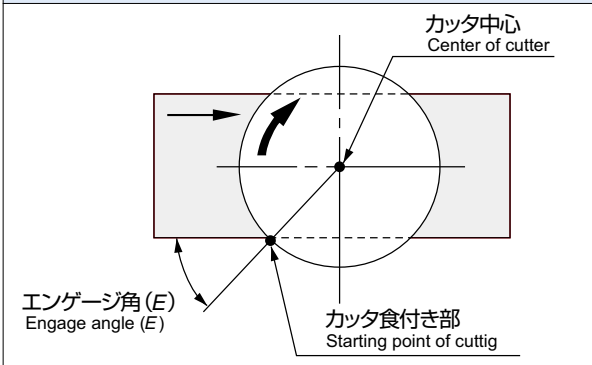

*カッタ径は被削材の幅より 30 ~ 50%位大きめの径を使用した方がよい結果が得られます。
Cutter bodies are recommend with diameter 30-50% bigger than width of work pieces.

	(小) Small	エンゲージ角 (E) Engage angle (E)	(大)* Large
	良 Long	寿命 Tool life	悪 Short
カッタ径とエンゲージ角 Cutter diameter and engage angle.	カッタ径大 Large cutter dia. 		カッタ径小 Small cutter dia.
カッタ位置とエンゲージ角 Cutter position and engage angle.			

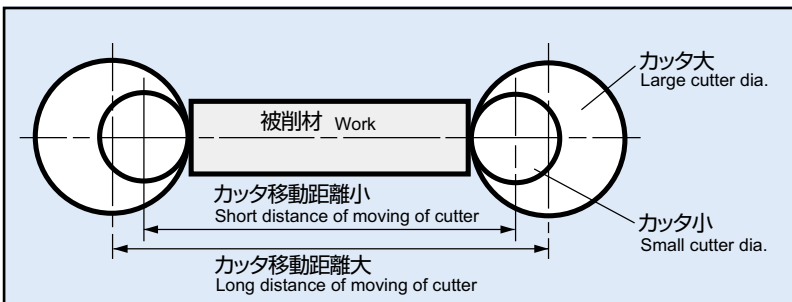

カッタ径が大きすぎるとカッタが被削材に食付いて抜けるまでの距離が長くなり能率が低下します。

Cutter with too large diameter shows lower machining efficiency, because talking cutter path longer.

○ 切込み角と切削性能 Relation ship between cutting edge angle and Performance.

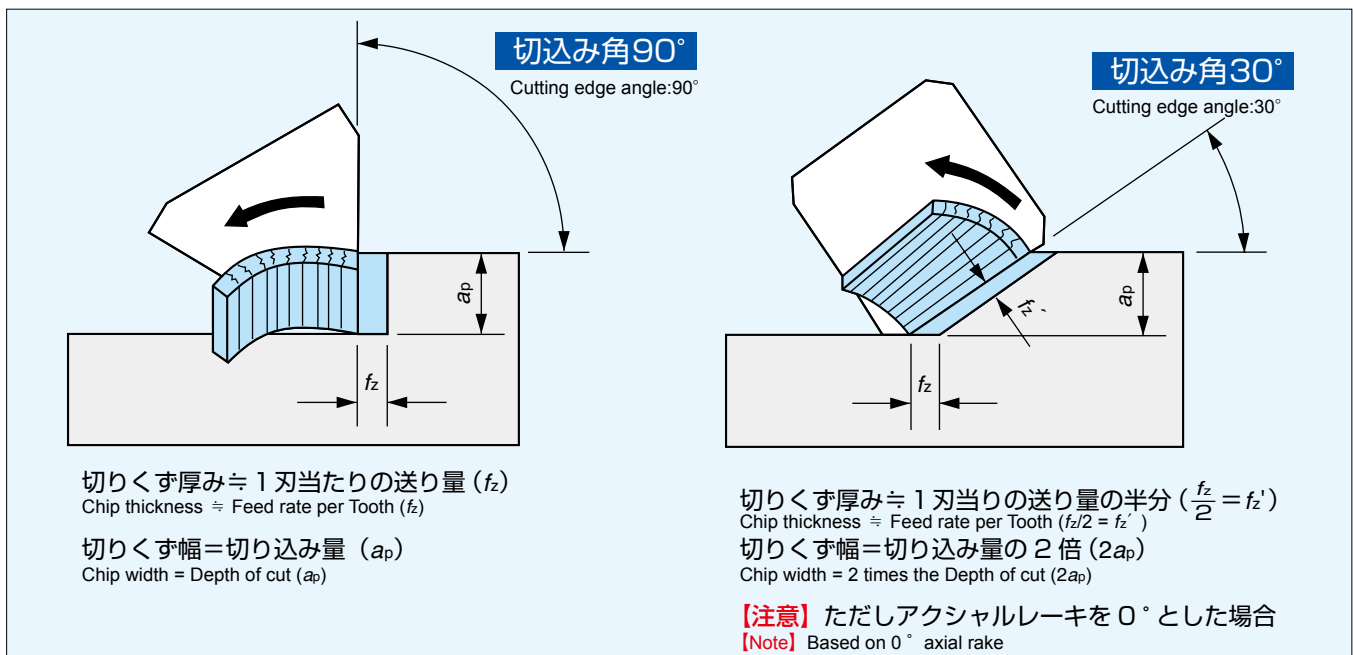

○ 切込み角と切削性能の変化 Relation ship between cutting edge angle and performance.

切削性能要素 Cutting performance factor	切り込み角 Cutting edge angle						
	大 Large	90°	75°	65°	45°	30°	小 Small
切りくず形状 Chips shape	厚くて幅が狭い Thick and narrow		←————→			薄くて幅が広い Thin and broad	
* 切りくず厚み比較 Comparison of chips thickness	1	0.97	0.91	0.71	0.5		
切削動力 Cutting power	少ない Small	←———— (ワークに接触する切れ刃長さによる) ———→			大きい Large		
インサート摩擦度 Inserts abrasion	多い High	←———— (切れ刃単位長さにかかる切りくず厚さによる) ———→			少ない Low		
びびり Vibration	出にくい Not likely	←———— (切れ刃長さによる食い付きの差) ———→			出やすい Likely		
有効切り込み深さ Effective depth of cut	大きい Large	←———— (インサートの倒れの差) ———→			小さい Small		
振動 Vibration	出やすい Likely	←———— (スピンドルに対して横からかかる負荷の差) ———→			出にくい Not likely		
ワークを下に押し付ける力 Work pressurizing force	小さい Small	←———— (薄板では切込み角小さいとワークがピピル) ———→			大きい Large		
切りくずの流れ Chips flow	良くない No good	←———— (横に巻込む) ———→		(上に出る)		良い good	

* 切込み角90°の時の切りくず厚みを 1 とした場合、同じ送りでの切りくず厚み比較。
* Comparison of chip thickness in various angles at a fixed feed rate (if 90° = 1 thick)

Technical Data
Indexable Tools

フライス用インサート各部の名称と役割

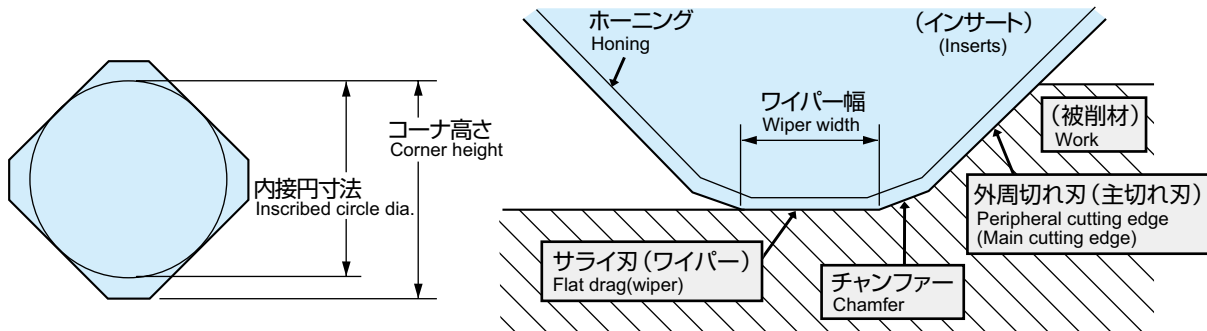

○ サライ刃の役割 Role of flat drag

サライ刃は仕上専用刃です。The flat drag is a dedicated finishing cutter.

	<p>コーナ R のインサートでは、送りマークがノココ状に付きませんが、ワイパー付きインサートでは平らな面が生成できます。 If cut with a corner R insert, cut surface is marked in wave form. But with a insert with a wiper, finish surface is flat.</p>
	<p>サライ刃の幅 (w) はカッタ 1 回転当たりの送り量以上の幅にします。例えば、 刃数6枚、一刃当たりの送りを f_z とすると $w \geq f_z \times 6$ となります。 これはインサートやカッタの精度によりセットされたインサートに多少高さのバラツキが生じて最も突き出したインサートのサライ刃のみで、回転当たりの平面を出せるようにするためです。 通常サライ刃の幅は 1.2 ~ 2.0 mm にします。 Set the width of flat drag (w) to the same or more size of feeding amount per rotation of the cutter. e.g. If a feed per cutter of 6 flutes is f_z, the proper width can be calculated as : $w \geq f_z \times 6$ Even if the height of several inserts, each of which was reset according to the insert or cutter accuracy, differ from each other, a flat drag of the highest insert can produce a flat finish surface. Generally set the width of a flat drag to 1.2 to 2.0 mm.</p>

○ チャンファァの役割 Role of chamfer

チャンファァは、インサートの欠け防止と仕上げ面面向上の効果があります。
Chamfering is made to protect the surface from chipping and also to finish the surface well.

	<p>外周切れ刃とサライ刃の間にチャンファァと呼ばれる副切れ刃を付けます。 ストレートタイプで幅 0.5 ~ 1.0mm 付けます。 Rタイプは R0.8 ~ R1.2 にします。 Set an auxiliary cutting edge called chamfer between peripheral cutting edge and flat drag. Set 0.5 to 1.0mm width for straight type. Set R 0.8 to R 1.2 for R type.</p>	
<p>チャンファァ無し (ピンカド) Without chamfer (Pin corner)</p>	<p>ストレートチャンファァ Straight chamfer</p>	<p>R チャンファァ R Chamfer</p>
<p>弱 Low</p>	<p>← 刃先強度 Nose strength →</p>	<p>強 High</p>
<p>悪 NG</p>	<p>← 仕上げ面 Finish surface →</p>	<p>良 OK</p>

技術資料
刃先交換式工具

○ ホーニングの役割 Role of honing

ホーニングは刃先の強度をアップさせます。
By honing, strenght of cutting edge is increased.

	<p>刃先ホーニングにはチャンファーホーニングと丸ホーニングがありますが、フライス用インサートではチャンファーホーニングが主流です。 ホーニング角は15~25°、ホーニング幅は1刃送りの約半分です。0.1mm~0.2mmですが、仕上げ刃となるサライ刃は0.03~0.01mmにします。 なお、アルミニウムや鋳鉄等溶着しやすい被削材向けには通常ホーニングは付けません。 Nose honing can be divided into chamfer honing and round honing. For milling insert, chamfer honing is mainly used. A proper honing angle is 15 to 25° honing width is 0.1 to 0.2mm that is almost one half of feed per 1 cutting. In case of flat drag, which is for finish cutting, set its honing angle to 0.03 to 0.1mm. No honing angle is required for cutter that is used for cutting any material that is easily welding, like aluminium or cast iron.</p>
<p>チャンファーホーニング Chamfer honing</p> <p>丸ホーニング Round honing</p>	

○ コーナ高さ と 仕上げ面 The corner height

内接円よりコーナ高さ (B) はインサートをカッタボディにセットした時の刃先高さとなります。
(B) from the inscribed circle is the height of nose when the insert is set to the cutter body.

		<p>インサートをカッタボディにセットした時の刃先高さの高低差(正面のフレ)は通常0.02mm~0.03mmとなります。 The difference of nose height (front run-out) likely to occur when setting the insert to the cutter body is 0.02 to 0.03mm.</p>
<p>正常な場合のサライ刃の摩耗 Abrasion in flat drag in normal cutting.</p>	<p>インサートセット不備の場合のサライ刃異常摩耗 Abnormal abrasion in flat drag when insert setting is not proper.</p>	<p>◎ 被削材仕上面に接しているインサートが、傾いていると仕上げ面は悪くなります。インサートセット時、エア等でごみ等入らないようにセットする必要があります。 If the insert contacting the finish surface of a work is inclined, the finishing is not done well. Carefully set the insert allowing no dust to enter by the air blow or other.</p>

フライス加工切削条件の選び方

● 切削速度 (vc) Cutting Speed

$$v_c = \frac{\pi \times DC \times n}{1000} \text{ (m/min)}$$

回転数 (n) Revolution

$$n = \frac{1000 \times v_c}{\pi \times DC} \text{ (min}^{-1}\text{)}$$

vc : 切削速度 m/min Cutting speed

DC: 外径 mm Cutter diameter

n : 回転数 min⁻¹ Revolution

π : 円周率 3.14 Circle ratio

● 送り速度 (vf) Feed rate

$$v_f = f_z \times z \times n \text{ (mm/min)}$$

1 刃当りの送り (fz) Feed rate per tooth

$$f_z = \frac{v_f}{z \times n} \text{ (mm/t)}$$

vf : 送り速度 mm/min Feed rate

z : 刃数 Number of flutes

n : 回転数 min⁻¹ Revolution

fz : 1 刃当りの送り mm/t Feed per tooth

● 加工時間 (Tc)

$$T_c = \frac{L}{v_f} \text{ (min)}$$

Tc : 加工時間 min Cutting time

vf : 1 分間当りのテーブル送り速度 mm/min
Feed rate per minute of table

L : テーブル総送り長さ (被削材長さ + フライス直径) mm
Overall table feed length (workpiece length + grinder dia.)

● 切りくず排出量 (Q)

$$Q = \frac{a_p \times a_e \times v_f}{1000} \text{ (cm}^3\text{/min)}$$

Q : 切りくず排出量 cm³/min
Chip removal volume

ap : 切込み深さ mm
Cutting depth

ae : 切削幅 mm
Cutting width

vf : 1 分間当りのテーブル送り速度 mm/min
Feed rate per minute of table

● 切削動力 (Pc) Cutting power

$$P_c = \frac{a_p \times a_e \times v_f \times k_c}{60 \times 10^6 \times \eta} \text{ (kW)}$$

Pc : 切削動力 kW

Cutting power (horsepower)

ap : 切込み深さ mm

Cutting depth

ae : 切削幅 mm

Cutting width

vf : 送り速度 mm/min

Feed rate

η : 機械効率 (0.6 ~ 0.8)
Mechanical efficiency

kc : 比切削抵抗 N/mm² (下の表参照)
Relative cutting resistance (Refer to the table below)

● kc (比切削抵抗) Specific cutting resistance

被削材材質 Work Materials	引張り強さ (N/mm ²) および硬さ Tensile strength (N/mm ²) or hardness	1 刃当りの送りに対する比切削抵抗 (N/mm ²) kc				
		0.1mm/t	0.2mm/t	0.3mm/t	0.4mm/t	0.6mm/t
軟鋼 Mild Steels	520	2200	1950	1820	1700	1580
中鋼 Medium Steels	620	1980	1800	1730	1600	1570
硬鋼 Hard Steels	720	2520	2200	2040	1850	1740
工具鋼 Tool Steels	670	1980	1800	1730	1700	1600
	770	2030	1800	1750	1700	1580
クロムマンガン鋼 Chrome manganese Steels	770	2300	2000	1880	1750	1660
	630	2750	2300	2060	1800	1780
クロムモリブデン鋼 Chrome molybdenum Steels	730	2540	2250	2140	2000	1800
	600	2180	2000	1860	1800	1670
ニッケルクロムモリブデン鋼 Nickel chrome molybdenum Steels	940	2000	1800	1680	1600	1500
	352HB	2100	1900	1760	1700	1530
鋳鋼 Cast Steels	520	2800	2500	2320	2200	2040
硬質鋳鉄 Hard Cast Steels	46HRC	3000	2700	2500	2400	2200
ミーハナイト鋳鉄 Meehanite Cast Steels	360	2180	2000	1750	1600	1470
ネズミ鋳鉄 Gray Cast Steels	200HB	1750	1400	1240	1050	970
黄銅 Brass	500	1150	950	800	700	630
軽合金 (Al-Mg) Light Alloy (Al-Mg)	160	580	480	400	350	320
軽合金 (Al-Si) Light Alloy (Al-Si)	200	700	600	490	450	390

技術資料
刃先交換式工具

フライス加工におけるトラブルと原因対策

(対策) (Countermeasure) ○: 効果大 Very Effective ●: 効果あり Effective ▼: 逆効果 Not Effective ↑: 増やす、大きくする Increase, Make it Large ↓: 減らす、小さくする Reduce, Make it Small	インサート材種 Insert Grade				工具形状 Tool Shape						切削条件 Cutting Condition						
	靱性の高い材種 Use Tough Grade	耐摩耗性の高い材種 Use Abrasion Resistant Grade	サメツトに適合 Use Cermet Material	コーティングにする Use coated Grade	ホーニング量を変える Change The Honing Amount	すくい角を変える Change Rake	逃げ角を変える Change Relief Angle	インサートを厚くする Make Insert Thicker	コーナ角を大きくする Increase Corner R	インサートを精密級にする Use Precision Class Inserts	刃数を変える Use Inserts of Different Flute Number	サライ刃を付ける Attach Flat Drag	切削速度を変える Change Cutting Speed	送り量を変える Change The Feed Rate	切込み量を変える Change Cut-In Amount	切削油をかける Splash Cutting Fluid	エンゲージ角を小さくする Reduce The Engage Angle
逃げ面摩耗 (フランク) Abraded Relief Surface (Flank)	○			○	●	●						●					
すくい面摩耗 (クレータ) Abraded Rake Surface (Crater)		●	●	●								●	●				
衝撃性 チッピング Shock Chipping	○				○	●	●	●	●				●				●
溶着性 チッピング Welding Chipping	●		●	○	●	●						○					○
熱亀裂 Thermal Crack	●											●					▼
仕上面 Finish Surface			○		●	●	●			○		○	●	●	●	○	
びびり Chattering Vibration					●	●	●				●	●	●	●	●		
コバ欠け・バリ Edge Chipping, Burr					●	●	●	●			●		●	●			●

フライス用SD,SE,TE形標準インサートの各社形番対照表

当社標準在庫形番変更にもない各社相当形番の対照を示します。

The table indicates various model numbers of other comparison to the model numbers of standard stock items.

当社形番 (商品コード) Item code	精度 Tolerance class	用途 Application	各社相当形番				
			三菱マテリアル Mitsubishi Material	タンガロイ Tungaloy	住友電工ハードメタル Sumitomo Electric Hard metal	京セラ Kyocera	セコツール Seco Tool
SDE42TN-C9	E	鋼用 Steel	SDEN1203AEN	SDEN42ZTN			
SDE42TN-C9A6				SDEN42ZTN20	SDEX42MT		
SDE42TN-G9Y							
SDE42TN-G9C3				(SDEN42ZTNCR)			
SDK42TN-C9	K	鋼用 Steel	SDKN1203AEN	SDKN42ZTN	SDKN42MT	SDKN1203AUTN	
SDK42TN-C9A2							
SDK42TN-B9							
SDK42FN-C9		鑄鉄 Cast iron		SDKN42ZFN	SDKN42M	SDKN1203AUFN	
SDC53TN-C9	C						
SDC53TN-B9							
SDE53TN-C9	E	鋼用 Steel		SDEN53ZTN	SDEX53MT		
SDK53TN-C9	K	鋼用 Steel	SDKN1504AEN	SDKN53ZTN	SDKN53MT	SDKN1504AUTN	
SDK53TN-B9							
SDK53FN-C9			鑄鉄 Cast iron		SDKN53ZFN	SDKN53M	
SEE42TN-C9	E	鋼用 Steel	SEEN42AFTN1				
SEE42TN-C9Y							
SEE42TN-G9							
SEE42TN-G9Y							
SEE42TN-G9A2				(SEEN42AFTN24)			
SEE42TN-G9C3							
SEE42FN-C9		鑄鉄 Cast iron	SEE42AFEN1				
SEK42TN-C9	K	鋼用 Steel	SEKN42FTN1	SEKN42FTN	SEKN42MT	SEKN1203AFTN	SEKN1203AFTN
SEK42FN-C9		鑄鉄 Cast iron	SEKN42AFEN1	SEKN42AFFN	SEKN42M	SEKN1203AFFN	SEKN1203AFN
SEE53TN-C9	E	鋼用 Steel	SEEN53AFTN1				
SEE53TN-C9Y							
SEE53TN-G9Y							
SEE53FN-C9			鑄鉄 Cast iron	SEEN53AFEN1			
SEK53TN-C9	K	鋼用 Steel	SEKN53AFTN1		SEKN53MT		SEKN1504AFTN
SEK53FN-C9		鑄鉄 Cast iron	SEKN53AFEN1		SEKN53M		SEKN1504AFN
SEE42TR-G3	E	鋼用 Steel	SEEN42EFTR1	SEEN42EFTRCR			
SEE42FR-G3		鑄鉄 Cast iron	SEEN42EFER1				
SEK42TR-G3	K	鋼用 Steel	SEKN42EFTR1	(SEKN42EFTR)		(SEK42EF3R)	
TEE32TR-G0	E	鋼用 Steel	TEEN32PETR1	TEEN32ZTR			
TEK32TR-G0	K	鋼用 Steel				TEK32PT3R	
TEK32FR-G0		鑄鉄 Cast iron					(TEK32PT3R)
TEE43TR-G0E	E	鋼用 Steel	TEEN43PETR1	TEEN43ZTR	TEEN43TR	TEE43PT4R	
TEE43TR-G0EY							
TEE43FR-G0E			鑄鉄 Cast iron	TEEN43PEER1	(TEEN43ZFR)	(TEEN43R)	
TEK43TR-G0E	K	鋼用 Steel	TEKN43PETR1		TEKN43TR	TEK43PT4R	
TEK43FR-G0E		鑄鉄 Cast iron	TEKN43PEER1		(TEKN43R)	(TEK43PT4R)	

・上表中、()で示した形番は同一品ではありませんが、類似形状品のため参考としました。
 ・本表は、各社の承認を得たものではありません。
 ・The numbers in bracket () are not exactly the same model, but similar to the respective model and shown as reference.
 ・This table is not an official comparison table approved by each maker.

フライス加工の各社材種対応表

○ フライス コーティング材種 Coated materials for milling

用途 Application	使用分類 Use classification	グレード Grade	当 社	三菱 マテリアル Mitsubishi Materials	タンガロイ Tungaloy	住友電工 ハードメタル Sumitomo Electric Hard metal	サンドビック Sandvik	京セラ Kyocera	ダイジェット Dijet	ケナメタル Kennametal	セコツール Seco Tools		
フ ラ イ ス Milling	P	P01	ATH80D ATH08M TH308 PN208 JP4105	MP8010 MP6120 VP15TF	AH710 AH725 AH730	ACP100 ACP200 ACP300	GC1010 GC1130 GC1030	PR1525 PR1225 PR1230 PR830	JC8003 JC730U JC8015 JC5015	KC715M KC725M KC792M KC994M	MP1500 MP2500 MP3000 T250M		
		P10	PCA12M PN15M PN215 JP4115	MP6130 UP20M VP20RT	AH3035 AH3135 AH110		GC2030 GC2040 GC3040		JC5118 JC6235 JC5040 JC8050		T15M T20M T25M F20M F25M F40M		
		P20	CY150 CY9020 JP4120	VP30RT F7010 FH7020	AH120 AH130 AH140		GC4220 GC4230 GC4240						
		P30	HC844 CY25 CY250 CY250V JS4045	F7030	AH9030 GH130 AH330 GH330								
		P40	PTH30E PTH40H JS4060 GX2140		T3130 T313W								
	M	M01	PN08M PN208	VP15TF	AH120	ACM100	GC1130	PR1525	JC730U	KC730M	MP2500		
		M10	PN15M PN215	MP9130	AH130	ACM200	GC1030	PR1535	JC835S	KC725M	T250M		
		M20	JP4120	MP9030	AH140	ACM300	GC2030	PR1225	JC8015	KC994M	T20M		
		M30	HC844 CY250 JS4045	UP20M VP20RT MP7140	AH725 AH730 GH110	T250A T4500A A30N	GC2040 GC1040 GC4230 GC4240	PR830 CA6535	JC5015 JC5118 JC8050		T25M F30M F40M		
		M40	PTH30E PTH40H JM4160 GX2160 AX2040	F7010 F7030	AH330 GH330 GH340								
	K	K01	ATH80D ATH08M TH308	MP8010 VP15TF	GH110 AH110	ACK200 ACK300	GC1010 GC1020 GC3330	PR1510 PR1210 CA420M	JC8003 JC605W JC600	KC915M KC920M KC925M	MK1500 MK2000 MK3000		
		K10	ATH10E TH315 CY100H	VP20RT MC5020	AH725 AH120 GH130		GC3040 GC3220 GC4220 GC4230 GC4240		JC608X JC6610 JC8015 JC5015 JC6235 JC5080	KC992M KC930M	T150M T250M F15M MP1500		
		K20	CY9020 CY150 PTH13S JP4120 GX2120		AH330 T1115								
		K30	CY250 JS4045 GX2040										
	N	N01	PN08M PN208	LC15TF	DS1100 DS1200	DL1000 DA1000	GC1130 GC1030 CD10	PDL025 KPD001 KPD010 KPD230 KPD250	JDA30 JDA735 JDA10 JDA715				
		N10	CY100H PTH13S SD5010 HD7010										
		N20											
		N30											
	S	S01	PN08M PN208	MP9120		ACM100	GC1130	PR1535	JC8003				
		S10	JP4120 JS1025	VP15TF MP9130		ACM200 ACM300	GC1030 GC2030 GC2040	PR1210 CA6535 KPD001 KPD010	JC8015 JC5015 JC5118 JC835S JC8050				
S20		PTH30H	MP9030										
S30		JM4160											
H	H01		MP8010 VP15TF			GC1010 GC1130 GC1030 GC3040 GC4220		DH102 DH103 JC6102 JC8003 JC8008 JC8015 JC5118					
	H10	ATH80D ATH08M PTH08M TH308 JP4105 BH200 BH250											
	H20	TH315 JP4115											
	H30	JP4120											

注) 本表は、各社の承認を得たものではありません。 Note: This table has not been approved by the individual companies.

フライス加工の各社材種対応表

超硬合金材種 Carbide alloy materials

使用分類 Application	グレード Grade	当 社	三菱 マテリアル Mitsubishi Materials	タンガロイ Tungaloy	住友電工 ハードメタル Sumitomo Electric Hard metal	サンドビック Sandvik	京セラ Kyocera	ダイジェット Dijet	ケナメタル Kennametal	セコツール Seco Tools
P	P10	WS10	STi10T	TX10S	ST10P	S1P		SR10 SRT	K5H K45	S10M
	P20	EX35	STi10	TX20 TX25 UX25	ST20E	SMA		SRT SR20 DX30	K29 K45 K2885	S25M
	P30	EX35		TX30 UX30	A30 A30N	SM30	PW30	SR30 DX30 DX25	K420 KM K21	S25M
	P40	EX35		TX40	ST40E	S6		SR30 DX35	K420 KM GX	S60M
M	M10	WA10B		TU10	U10E	H10A		UMN UM10		S10M
	M20	EX35	UTi20T	TU20	U2	H13A		UM20 DX25 DTU	K313 K40 PVA	HX
	M30	EX35	UTi20T	UX30	A30 A30N	H10F	PW30	DTU UMS	K2885 K2S	HX
K	K01	WH01 WH05	HTi05T	TH03	H2 H1	H1P		KG03		
	K10	WH10	HTi10	TH10	EH10 EH510	H10 HM	KW10	KG10 KT9 CR1	K6 K313 K68 KM1	HX
	K20	WH20	HTi20T	G2 KS20	G10E EH20 EH520	H13A		KG20 KT9 CR1	K1 K8735	883
超微粒 超硬合金 Ultra-molecular carbide alloy	Z01	NM08		F	FO AFO F1			FB10		
	Z10	NM15	MF10	M EM10	A1 AF1			FB10 FB15		
	Z20	EF20N	TF15 UF20	EM20 UM				FB15 FB20		
	Z30		UF30	UM				FB20		

サーメット材種 Cermet materials

使用分類 Application	グレード Grade	当 社	三菱 マテリアル Mitsubishi Material	タンガロイ Tungaloy	住友電工 ハードメタル Sumitomo Electric Hard Metal	サンドビック Sandvik	京セラ Kyocera	ダイジェット Dijet	ケナメタル Kennametal	セコツール Seco Tools
旋削用 for Turning	P10	CH350	AP25N NX2525	NS520 AT520 AT530	T110A T2000Z T1200A		TN30 PV30	LN10 CX50 NIT CX75	KT125 HTX	
	P20	CH550	AP25N NX2525 UP35N NX335	NS530 AT530 GT530	T2000Z T1200A T130A T3000Z	CT515 CT520 CT5015 CT525	TN60 TN6020 PV60 PV7020	CX50 NAT CX75	KT315 KT175 HT2	CM
	P30	CH570	VP45N	NS530 NS540	T3000Z	GC1525 CT525	PV90	CX90 CX99		CR
フライス用 for Milling	P10	CH550 MZ1000	NX2525	NS530	T12A		TN60	NIT CX75	KT530M KT195M	CM15
	P20	CH7030	NX2525	NS530	T250A	CT520	TN60 TN100M	NAT CX75 CX90 SUZ	KT530 HT7 KT605	CM15
	P30	CH7035	NX4545	NS540	T250A	CT530		CX90 CX99		CM15

注) 本表は、各社の承認を得たものではありません。 Note: This table has not been approved by the individual companies.

技術資料
刃先交換式工具

Nomenclature of turning tools parts and role of nose angle

旋削工具各部の名称と刃先角度の役割

各部の名称 Name of parts of Turning Tools

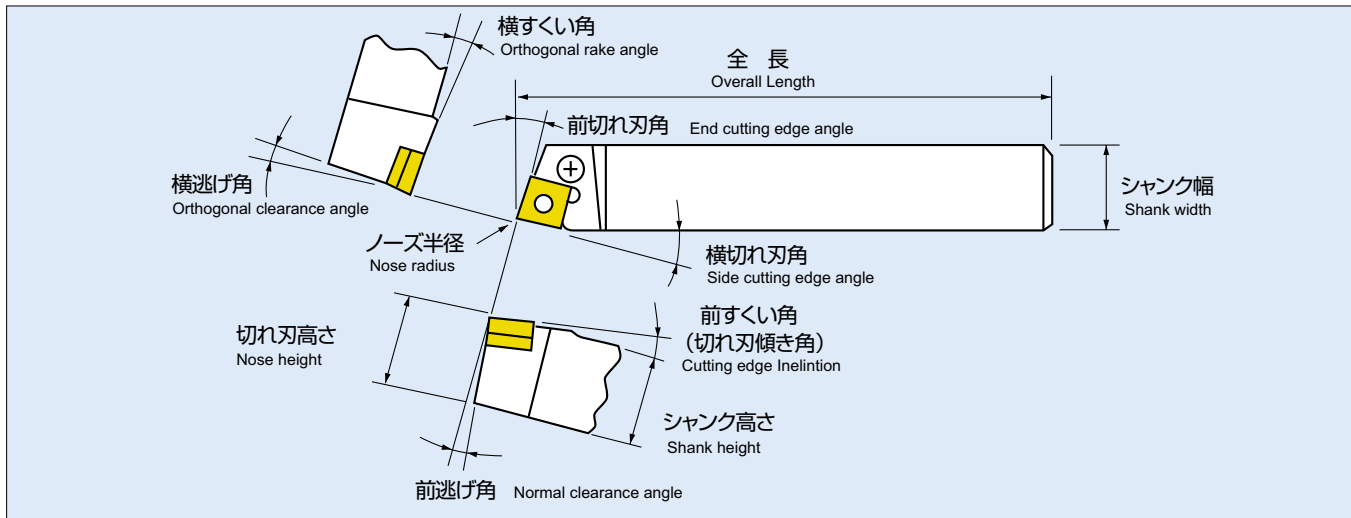

バイトホルダ横切れ刃角の影響 Effect of side Edge cutting Angle

横切れ刃角 : 0° Side cutting edge angle : 0°

被削材と接触長さが短くなるため厚くて幅の狭い切りくずが出ます。
Thick and narrow chips are produced, because the contact length of an Insert and work material is short.

横切れ刃角 : 30° Side cutting edge angle : 30°

被削材との接触長さが長くなるため薄くて幅の広い切りくずが出て、被削材を押し分力 P_y が発生します。
Thin and wide chips are produced, because the contact length of an Insert and work material, Force P_y , which pushes work piece, are produced.

切削性能に及ぼす影響 Effect on cutting performance

項目 Elements	小 Small	横切れ刃角 Side cutting edge angle	大 Large
刃先の摩耗率 Wear	大 Large	←	小 Small
被削材 Work material	削りやすい材料 Large Easy-to-machine materials	←	削りにくい材料 Difficult-to-machine materials
切削動力 Cutting force	小 Small	←	大 Large
びびり Vibration	出にくい Not likely Difficult to be produced	←	出やすい Likely Easy to be produced
切削方法 Application	仕上 Finishing	←	荒 Roughing
被削材剛性 Rigidity of work piece	細くて長い物 Small/Long	←	太い物 Big
機械剛性 Mechanical rigidity	剛性低い場合 Low rigidity	←	剛性高い場合 High rigidity
切りくず処理性 Chips rejectability	良い Good	←	悪い Bad

Technical Data
Turning Tools

Shapes of inserts and application of turning

旋削用インサート形状と使用用途

インサート形状 shape	R形	S形	C形	W形	T形	D形	V形
ノーズ角 Nose angle	360°	90°	80°	80°	60°	55°	35°
刃先強度 Rigidity of cutting edge							
使用コーナ数 (片面) Number of using corner (one face)	3~4	4	2	3	3	2	2

加工例 Applications

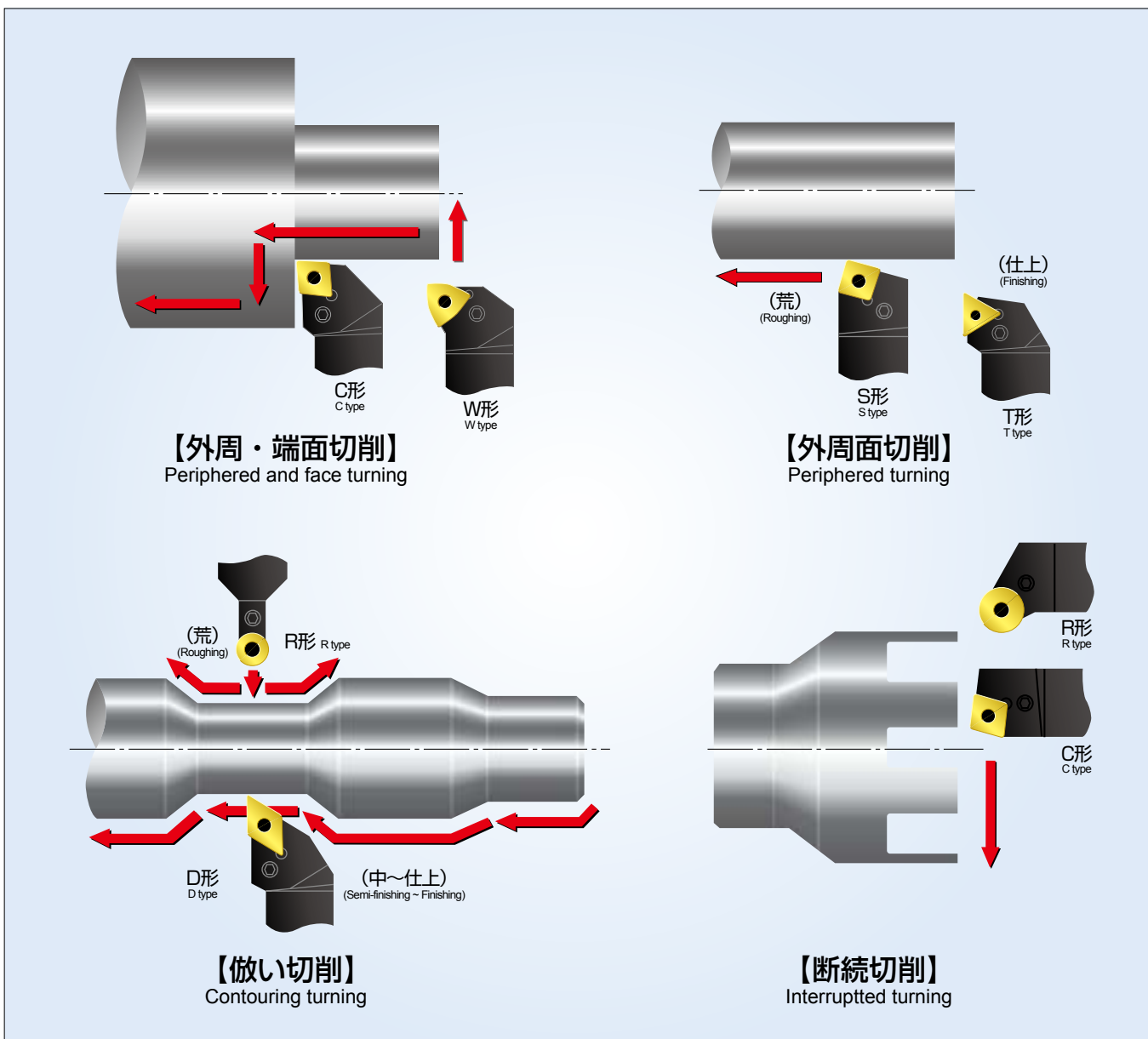

技術資料
旋削用工具

Chips removal of turning 旋削の切りくず処理

使用する工具の切りくず処理性をめきにして、無人化、自動化はありえません。
製品品質の安定、工具寿命および機械稼働率向上のためにも良好な切りくずを出す必要があります。
No unmanned operation or automation is available unless chips disposal matter is settled.
Cutting chips ought to be regularly and smoothly ejected and disposed of in order to stabilize product quality, improve tool's life and machine operating efficiency.

○ (1) 切りくず形状の分類 Classification of chips

区分 Style	切りくず形状 Shape	切りくず長さ Chips Length	良否 Evaluation	備考 Notes
①		不規則な形の連続 Consecutive irregular shape	不良 NG	・ 工具やワークにからみつき危険 ・ Dangerous because it entangles the work or tool.
②		規則的な形の連続 Consecutive regular shape	(不良) (NG) $l \leq 100 \text{ mm}$	・ かさばるので搬送時間問題 ・ 使用外切れ刃のチッピングの原因となることあり ・ 人が付いている場合は、好まれることあり ・ Becomes bulky. Ejecting time is long. ・ Can cause chipping of edges other than cutting edge. ・ This type may be favorable if an operator attends the job.
③		2~10巻程度 ($l \leq 50 \text{ mm}$) About 2-10 rolls ($l \leq 50 \text{ mm}$)	良 ○ 好	・ 刃先にさほど負荷かからず、理想的な切りくず ・ An ideal chips, causing less load to the nose.
④		1巻程度 About a roll		
⑤		1/2巻以下。 波状に連がることもあり。 Smaller than a half roll Sometimes in a long waved link		
			(不良) (NG)	・ 特に波状につながった切りくずばかりが出る場合は「ききすぎ」の状態 ①びびり、仕上面不良の原因 ②抵抗や発熱の増加より工具寿命低下の原因 ・ A long chain of irregular shape can cause ① chattering or bad finish surface and ② increased resistance or heating can shorten the tool's life.

○ (2) 当社における切りくず処理有効範囲 Chip-Removal Range

区分③, ④そして区分②では、長さ 100 mm以下の範囲を「適当」と判断し、プレーカの有効領域をきめている。
Chip-removal range is decided according to the standards of effective range, that is area under chip length of 100 mm in area ③, ④ and ②.

切りくず処理領域
Chip-removal range

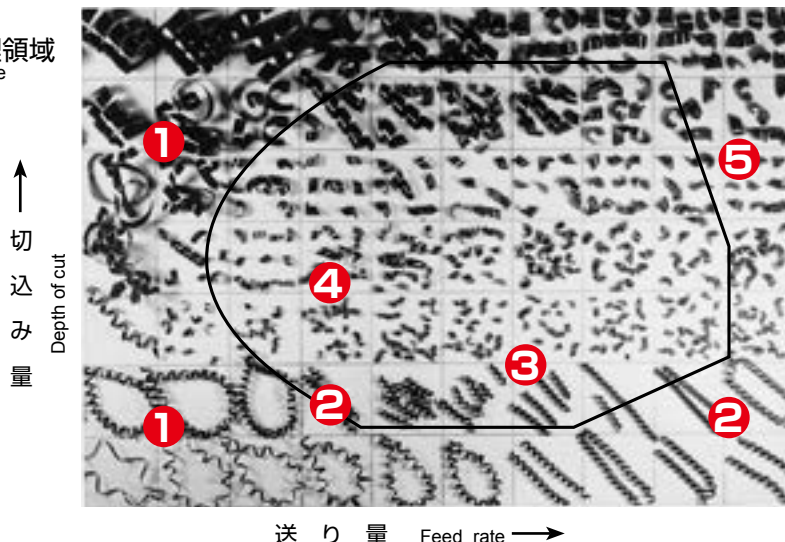

Cutting condition formula for turning 旋削に関する計算式

● 切削速度： v_c (m/min) Cutting Speed $v_c = \frac{\pi \times D_m \times n}{1000} = \frac{3.14 \times \text{ワーク径} \times \text{回転数}}{1000}$

● 回転数： n (min⁻¹) Revolution $n = \frac{1000 \times v_c}{\pi \times D_m}$

● 送り速度： f (mm/rev) (1回転あたりの送り量) Feed rate $f = \frac{\ell}{n}$

● 切削時間： T_c (min) Cutting Time $T_c = \frac{L}{f \times n}$

● 切りくず排出量： Q (cm³/min) Chip removal volume $Q = \frac{\pi \times a_p \times (D_m - a_p) \times n \times f}{1000}$

● 理論仕上面粗さ： h (μm) Theoretical finished surface roughness $h = \frac{f^2}{8 \times r_\epsilon} \times 1000$

● 切削抵抗： F (N) Cutting force $F = a_p \times f \times k_c \times 9.8$

● 切削動力： P_c (kW) Surface roughness $P_c = \frac{v_c \times a_p \times f \times k_c}{60,000 \times \eta}$

● バイトたわみ量： δ 角 (mm) (角シャンク) Deflection (Tool holder in square) $\delta_{\text{角}} = \frac{4 \times f \times a_p \times k_c \times L^3}{E \times b \times h^3}$

● バイトたわみ量： δ 丸 (mm) (丸シャンク) Deflection (Tool holder in round) $\delta_{\text{丸}} = \frac{64 \times f \times a_p \times k_c \times L^3}{3 \times \pi \times E \times D_s^4}$

(参考) Reference

被削材 Work material	比切削抵抗 k_c Feed rate & specific cutting resistant. (N/mm ²) $f = 0.1 \sim 0.4$	機械効率係数 η Coefficient machine tool efficiency 高剛性 ~ 低剛性 (新機械) (古機械) High Rigidity Low Rigidity New Machine Old Machine	縦弾性係数 E Modulus of longitudinal elasticity (N/mm ²)	
			鋼材 Steels	超硬 Carbide
炭素鋼 Carbon Steels	3000 ~ 2500	0.8 ~ 0.7	210000	560000
合金鋼 Alloy Steels	4500 ~ 3000		210000	?
鋳鉄 Cast Iron	2000 ~ 1500		210000	620000

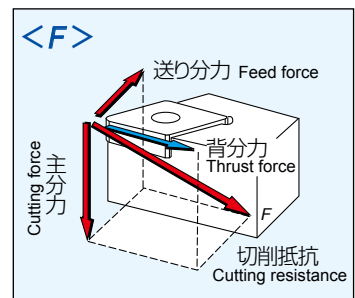
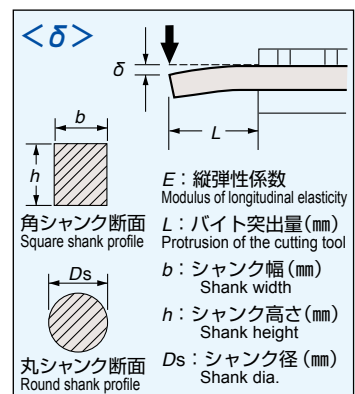
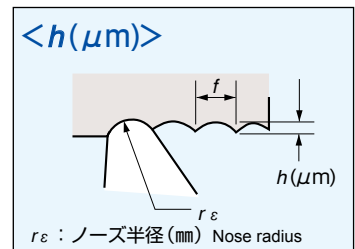
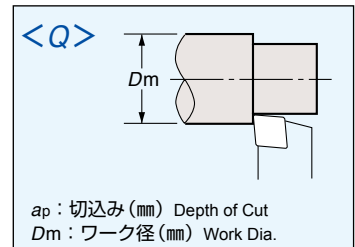
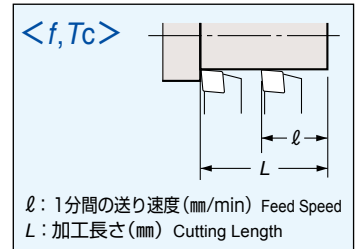
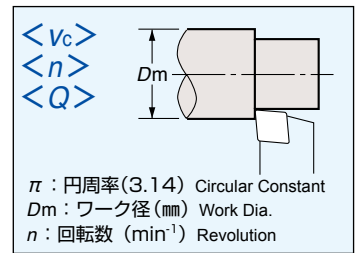

Counter-measures against brakage of tools

旋削における工具損傷対策

損傷の状態 Failure Conditions	原因 Cause	対策 Trouble Shooting		
		工具材種 Grade	工具形状 Tool geometry	切削条件 Cutting Condition
極端な逃げ面摩耗 Seriously worn relief surface 	<ul style="list-style-type: none"> ● 切削速度が速すぎる ● 工具の耐摩耗性不足 ・Cutting Speed too high. ・Abrasion resistance of tool not sufficient.	<ul style="list-style-type: none"> ● 耐摩耗性の高い材種にする。 Use Material of higher abrasion resistance GM8035,IP3000 ↓ HG8025,IP2000 ↓ HG8010 <ul style="list-style-type: none"> ● 正常摩耗の場合は、サーメットを使用する。 For normal abrasion, use a cermet 	<ul style="list-style-type: none"> ● コーナRを大きくする ● インサートブレーカの見直し (ブレイキング効果の弱いブレーカを使用する) ・Use material of higher crater abrasion	<ul style="list-style-type: none"> ● 切削速度を下げる ● 湿式切削とする ・Reduce cutting speed. ・Adopt wet cutting method.
極端なすくい面摩耗 Seriously worn rake 	<ul style="list-style-type: none"> ● 切削速度が速すぎる ● 送りが高すぎる ・Cutting Speed too high. ・Abrasion resistance of tool not sufficient.	<ul style="list-style-type: none"> ● 耐クレータ性の高い材種にする Use Material of higher abrasion resistance GM8035,IP3000 ↓ HG8025,IP2000 ↓ HG8010	<ul style="list-style-type: none"> ● インサートブレーカの見直し (ブレイキング効果の弱いブレーカを使用する) ・Review chip breaker quality. (Use a breaker of less breaking effect.)	<ul style="list-style-type: none"> ● 切削速度を下げる ● 送りを下げる ● 湿式切削とする ・Reduce cutting speed. ・Reduce feed rate. ・Adopt wet cutting method.
塑性変形(へたり) Deformation 	<ul style="list-style-type: none"> ● 高速、高送りによる切れ刃の軟化 ・Cutting edge was softened by high speed cutting at high feed rate.	<ul style="list-style-type: none"> ● より耐熱性の高い材種にする Use material of higher heat resistance GM8035,IP3000 ↓ HG8025,IP2000 ↓ HG8010	<ul style="list-style-type: none"> ● コーナRを大きくする ● インサートブレーカの見直し (ブレイキング効果の弱いブレーカを使用する) ・Change the shape to a larger coner radius. ・Review chip breaker quality. (Use a breaker of less breaking effect.)	<ul style="list-style-type: none"> ● 切削速度を下げる ● 送りを下げる ● 湿式切削とする ・Reduce cutting speed. ・Reduce feed rate. ・Adopt wet cutting method.
サーマルクラック Thermal crack 	<ul style="list-style-type: none"> ● 熱応力、熱疲労 ・Thermal stress, thermal fatigue.	<ul style="list-style-type: none"> ● 耐熱衝撃性の高い材種にする Use material of higher heat resistance IP3000 GM8035・GX30	<ul style="list-style-type: none"> ● インサートブレーカの見直し (ブレイキング効果の弱いブレーカを使用する) ・Review chip breaker quality. (Use a breaker of less breaking effect.)	<ul style="list-style-type: none"> ● 切削速度を下げる ● 送りを下げる ● 乾式切削とする ・Reduce cutting speed. ・Reduce feed rate. ・Adopt dry cutting method.
チッピング Chipping 	<ul style="list-style-type: none"> ● 振動、衝撃 ・Vibration, shock	<ul style="list-style-type: none"> ● より靱性の高い材種にする Use tougher material HG8010 ↓ HG8025,IP2000 ↓ IP3000	<ul style="list-style-type: none"> ● インサートブレーカの見直し(より切れ刃強度の高いブレーカを使用する) ● ホルダの剛性をUPする ● ホルダの突き出し量をできるだけ小さくする ・Review chip breaker quality. (Use a breaker of higher cutting edge strength) ・Use tougher holder. ・Reduce holder protrusion.	<ul style="list-style-type: none"> ● 送りを下げる ● 切込みを小さくする ・Reduce feed rate. ・Cut at smaller cutting amount.
初期欠損 Initial chipping 	<ul style="list-style-type: none"> ● 工具の機械的強度不足 ● 切削条件の不適性 ・Mechanical strength of tool not sufficient. ・Unsuitable cutting condition	<ul style="list-style-type: none"> ● より靱性の高い材種にする Use tougher material HG8010 ↓ HG8025,IP2000 ↓ IP3000	<ul style="list-style-type: none"> ● インサートブレーカの見直し(より切れ刃強度の高いブレーカを使用する) ● ホルダの剛性をUPする ● ホルダの突き出し量をできるだけ小さくする ・Review chip breaker quality. (Use a breaker of higher cutting edge strength) ・Use tougher holder. ・Reduce holder protrusion.	<ul style="list-style-type: none"> ● 送りを下げる ● 切込みを小さくする ・Reduce feed rate. ・Cut at smaller cutting amount.

旋削における各要因の切削性能への影響

要因 Factor		切削性能の受ける影響 Effect on cutting performance								
		工具寿命 Tool life		品位 Quality			切りくず 処理 Chips-removal	切削抵抗 Cutting resistance		
要素 Element	状況 Condition	耐摩耗性 Wear resistance	強度 Strength	寸法精度 Dimensional tolerance	溶着 Welding	びびり Vibration	仕上面 Finish surface			
工 具 形 状 Tool Shape	横切れ刃角 Side cutting edge angle	大きい Large	↗	↗				↘	↘	
		小さい Small	↘	↘	↗		↗	↗	↗	
	ノーズ半径 Nose radius	大きい Large	↗	↗	↘			↘	↘	
		小さい Small	↘	↘	↗			↗	↗	
	すくい角 Rake angle	大 (正) Large(Plus)	↗	↘	↗	↗	↗	↗	↗	
		小 (負) Small(Minus)	↘	↗	↘	↘	↘		↘	
	刃先処理量 (ホーニング等) Nose treatment (Honing,etc.)	大きい Large	↘	↗	↘	↘	↘	↘	↘	
		小さい Small	↗	↘	↗				↗	
	ブレーカ効果 Breaker effect	強い Strong		↘		↗			↗	↘
		弱い Weak		↗					↘	↗
切 削 条 件 Cutting Condition	切削速度 Cutting speed	高い High	↘			↗		↗	↘	↗
		低い Low	↗			↘		↘	↗	↘
	送り速度 Feed rate	高い High	↘	↘	↘		↘	↘	↗	↘
		低い Low	↗	↗	↗		↗	↗	↘	↗
	切込み Depth of cut	大きい Large		↘	↘		↘	↘	↗	↘
		小さい Small		↗	↗		↗	↗	↘	↗
切削油 Cutting oil	有 Yes	↗			↗		↗	↗	↗	
	無 No	↘					↘		↘	

【注意】 () : 条件により逆転する場合あり。

【Note】 () : Maybe reversed by condition.

旋削の各社インサートブレーカ対応表

	P 鋼 Steels						
	FF	F	MF	M 中切削 Medium Cutting		R 荒切削 Roughing	
	精密仕上げ High Precision Finishing	仕上げ Finishing	軽切削 Semi-Finishing	連続 Continuous	断続 Interrupted	両面 Double Sided	片面 One Sided
当社	FE	BH	AB,CT	AH	AY(A,Y,AE)	RE	TE,UE
三菱 マテリアル Mitsubishi Materials	FH FY PK*1	FS FJ*1	SA SH SW*2 SY	MV MA	MH MW*2	GH MAT MT	HZ HX HV
タンガロイ Tungaloy	O1*1 TF	TSF TS ZF 17 NS AFW*2	ZM 27 NM AS ASW*2 CB	TM 37 38	DM 33	TH 51	TU 57 65
住友電工 ハードメタル Sumitomo Electric Hard Metal	FA FL	SU LU LUW*2 SP	SX	GU GUW*2	UX UG	MU MX	HG MP HP
サンドビック Sandvik	QF	PF 23 WF*2 WL*2 LC	MF	PM QM	WM*2 SM	PR WR*2	QR PR HR 71 MR
京セラ Kyocera	DP*1 XP XP-T CF	GP WP*2	HQ CQ XQ WQ*2 CJ	PS HS	PT GS CS XS	GT HT 全周	HX

	M ステンレス鋼 Stainless steels		K 鋳鉄 Cast iron		内径用 Internal inserts		大型インサート Large inserts	円形インサート Round inserts	
	F	M/R	F	M/R	仕上げ Finishing	軽切削 Semi-finishing	重切削 Heavy cutting	全周 Conventional	ブレーカ付 With breaker
	仕上~軽切削 Finishing to Semi-finishing	中~荒切削 Medium cutting to Roughing	仕上~軽切削 Finishing to Semi-finishing	中~荒切削 Medium cutting to Roughing					
当社	MP,AB	PV,DE	VA	VA,V	JQ	JE	H,HX,HE	全周,RG	AN,WE
三菱 マテリアル Mitsubishi Materials	FH FS	MA SH MS	SW*2 MA MW*2	全周 MH GH	FV SV SQ	SW*2 MV 全周 MW*2 MQ	HZ HX HV HBS HCS	全周	PR RBS
タンガロイ Tungaloy	SS 11	SA SM S	全周 CF	CM CH 33	O1 PF PS	PM 23 24	TU 57 65	61 RS	RS
住友電工 ハードメタル Sumitomo Electric Hard Metal	SU UP	EX	UZ	UX	LU FC LUW*2	SU MU SF SC	MP HG HP	RP	RX
サンドビック Sandvik	MF	MM MR	KF	KM KR	PF UF WF*2	PM UM WM*2	HR QR MR PR	SM	無記号
京セラ Kyocera	GU MS MU	SU ST HU	全周	C ZS GC	GP XP DP CF	HQ XQ GK 全周 G	HX	全周 BB	

※1：外周研磨品 Perimeter ground product ※2：ワイパーインサート Wiper insert

注) 本表は、各社の承認を得たものではありません。 Note: This table has not been approved by the individual companies.

旋削の各社材種対応表

○ 旋削 コーティング材種 Coating materials for turning

	P 鋼 Steels				M ステンレス鋼 Stainless Steels		K 鋳鉄 Cast Iron		
	P10	P20		P30					
	F/MF 仕上げ切削 軽切削 Finishing/Semi-finishing	M 中切削 Medium Cutting		R 荒切削 Roughing	F 仕上げ切削 Finishing	M/R 中/荒切削 Medium/Roughing	F 仕上げ切削 Finishing	M 中切削 Medium Cutting	R 荒切削 Roughing
当社	<p>耐欠損性アップ ↑ Increased chipping resistance</p> <p>HG8010 HG8025, IP2000 (GM25) IP3000 (GM8035)</p> <p>← 耐摩耗性アップ Increased wear resistance</p>				<p>耐欠損性アップ ↑ Increased chipping resistance</p> <p>IP050S IP100S GX30</p> <p>← 耐摩耗性アップ Increased wear resistance</p>		<p>耐欠損性アップ ↑ Increased chipping resistance</p> <p>HX3505 HX3515 HG8010</p> <p>← 耐摩耗性アップ Increased wear resistance</p>		
三菱 マテリアル Mitsubishi Materials	UE6105 UE6010 UE6110	UC6010 UC610 UE6110	UE6020 U625 UC6025 MC6025	UE6035 US735	UC6010 US7020 UE6020 MC6025 MC7015	UE6020 UE6035 US735 MC6025 MC7025 MC7035	UC5005 UC5105	UC5015 UC5115	UE6005 UC6010 UP20M
タンガロイ Tungaloy	T9105 T9115 T7005 T715X	T9115 T9125 T822 T7020	T9125 T725X	T9135	T715X	T6020 T6030 GH330 AH120 T6120 T6130	T5105	T5010 T5115 AH110	T5020 T5125 AH120 GH110
住友電工 ハード メタル Sumitomo Electric Hard Metal	AC700G AC1000 AC810P	AC2000 AC720 AC820P	AC25 A820P	AC3000 AC304 AC830P	AC610M EH10Z EH510Z AC2000 AC510U	AC630M EH520Z AC304 AC3000 AC520U	EH10Z AC410K AC410K AC300G AC405K	AC410K AC700G AC110G AC415K	AC700G AC2000 EH20Z AC420K
サンド ビック Sandvik	GC4005 GC4015 GC3005 GC5015 GC4115 GC4215	GC4020 GC4125	GC4225 GC4025 LC25 GC425	GC4030 GC4035 GC4040 GC235 GC435 GC4235	GC2015 GC1025 GC215	GC2025 GC2030 GC1020 GC1120 GC2035 GC2040 GC235	GC3005 GC3205 GC3210	GC3015 GC3215	GC1020 GC1120 GC3020 GC3040 GC4015
京セラ Kyocera	CA110 CA5505 CA5515 CA510	CR7015 CA5025 CA515	CA225 CA5525 CR7025 CR9025 CA525	CA5535 CA530	CA6515 CA6015	CA6525 CR7015 CR9025 PR630 PR660 CA6535	CA4010 CA4505	CA4115 CR300 CA4515	CA4120 CR7015 PR610

注1) 本表は、各社の承認を得たものではありません。 Note 1: This table has not been approved by the individual companies.

注2) 赤字はPVDコーティングを示します。 Note 2: The red characters show the PVD coating.

Name and function of each part of a drill

ドリル各部の名称と働き

ドリル各部の名称 Name of each part of a drill.

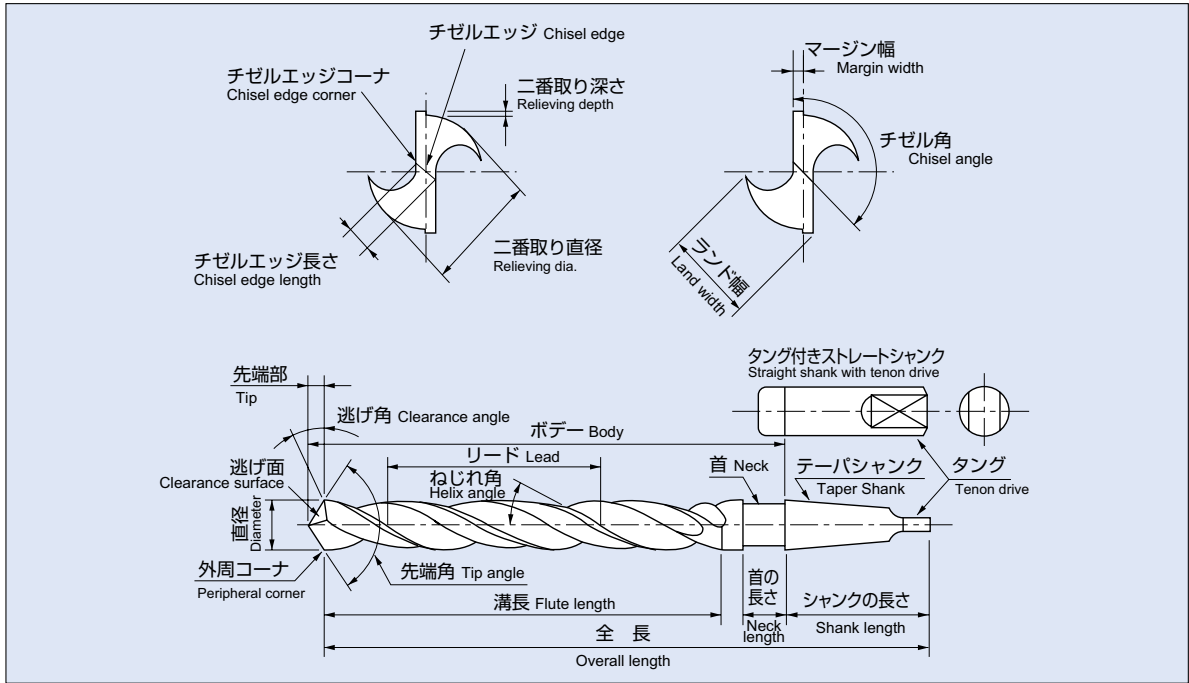

ドリル各部の働き Performance of each part of a drill

① 直径 Diameter

直径を JIS では 0.2mm~100mm まで規定していますがそれ以外は日本工具工業会規格 (TAS) や各社の規格によって製作されています。それぞれの直径の許容差は JIS B 0401 (寸法公差およびはめあい) の h8 によっています。

ただし、1mm 未満は $0_{-0.01}$ mm です。

ドリル許容差は先端部の数値であり現実にはドリルの直径はシャンクに向うに従って、長さ 100mm について 0.04~0.1mm 細くなっています。これをバックテーパと称します。

The diameter of a tool is stipulated in the size range, from 0.2 up to 100mm in the JIS standard. Other than that, most tools are fabricated to meet various standard such as TAS (Tool Association Standard) and others. The tolerance values of diameter in each of these standards are based on h8 of JIS B 0401 (Dimensional tolerance and fitting). The drill tolerance is a figure measured at its tip. Actually, the drill diameter becomes narrower by 0.04 to 0.1mm per 100mm length. This is called back taper.

② ねじれ溝の働き Function of spiral grooves

ねじれ溝は先端部で切削したときに発生する切りくずをスムーズに穴の外に排出する役目を持っており、溝の断面積が大きいほど切りくずの排出はよく、深い穴をあけるときに能率が增加します。

Spiral grooves have the function of smoothly removing chips produced by cutting to the outside. Larger groove cross sections provide better chip removal, increases efficiency during cutting of deep holes.

③ 心厚 Web

心厚とは、ドリルの心部にあたる場所で、この厚さはドリルの強さに大きな影響を与えます。

The spiral grooves enable chips to be discharged smoothly outside the hole when the tip cuts the work. Larger the cross-sectional area of a groove, the more chips are discharged, enhancing the drilling efficiency in case of producing a deep hole.

④ 二番取り面 Relieving surface

ドリルでいう二番取り面とは、ランド部にマージン幅を残して隙間をつけた部分です。マージン幅や二番取り深さは、ドリルの直径によって、あるいは使用目的によって決められます。二番取り面は、ドリルで穴をあけていくとき、被削材の穴面とドリルの外周との摩擦を減らす目的のものです。

The relieving surface means a clearance on a land secured by leaving a required margin width. The margin width or the relieving surface is determined by the drill diameter or the purpose of use. The relieving surface is provided to reduce abrasion between the drill peripheral and the hole surface of a work.

寸法の区分 Size class	1以上 3以下 (1~3)	3をこえ 6以下 (3~6)	6をこえ 10以下 (6~10)	10をこえ 18以下 (10~18)
許容差 Tolerance	0 -0.014	0 -0.018	0 -0.022	0 -0.027
寸法の区分 Size class	18をこえ 30以下 (18~30)	30をこえ 50以下 (30~50)	50をこえ 80以下 (50~80)	80をこえ るもの (80~)
許容差 Tolerance	0 -0.033	0 -0.039	0 -0.046	0 -0.054

タップ下穴に相当するドリル径

メートル並目ねじ Meter coarse thread		直径 (mm) Diameter	ひっかかり率 Thread ratio %
呼び Designation	ピッチ (mm) Pitch		
M1	0.25	0.75	92
M2	0.4	1.6	92
M3	0.5	2.5	92
M4	0.7	3.3	92
M5	0.8	4.2	92
M6	1.0	5.0	92
M8	1.25	6.8	89
M10	1.5	8.5	92
M12	1.75	10.3	90
M14	2	12.0	92
M16	2	14.0	92
M18	2.5	15.5	92
M20	2.5	17.5	92
M30	3.5	26.5	92
M42	4.5	37.5	92
M56	5.5	50.5	92

Drilling work equations

ドリル加工計算式

■ 切削速度 (V_c) Cutting Speed

$$v_c = \frac{\pi \times DC \times n}{1000} \text{ (m/min)}$$

v_c (m/min) : 切削速度 Cutting speed
π (3.14) : 円周率 Circle ratio

DC (mm) : ドリル直径 Drill dia.
n (min⁻¹) : 回転数 Revolution

■ 主軸送り (v_f) Main axis feed

$$v_f = f \times n \text{ (mm/min)}$$

v_f (mm/min) : 主軸(Z軸)送り速度 Main axis (Z axis) feed rate
f (mm/rev) : 1回転当たりの送り量 Feed amount per rotation
n (min⁻¹) : 回転数 Revolution

■ 穴あけ時間 (T_c) Drilling time

$$T_c = \frac{H \times i}{n \times f} \text{ (min)}$$

T_c (min) : 加工時間 Machining time
H (mm) : 穴あけ深さ Drilling depth
i : 穴数 No. of hole

n (min⁻¹) : 回転数 Revolution
f (mm/rev) : 1回転当たりの送り
Feed amount per rotation

■ 切りくず排出量 (Q) Chip removal volume

$$Q = \frac{\pi \times DC^2}{4} \times n \times f \div 1000 \text{ (cm}^3\text{/min)}$$

Q (cm³/min) : 切りくず排出量 Chip removal volume
π (3.14) : 円周率 Circle ratio
DC (mm) : ドリル直径 Drill dia.

n (min⁻¹) : 回転数 Revolution
f (mm/rev) : 1回転当たりの送り
Feed amount per rotation

ドリル加工のトラブルと原因対策

◎ドリルの破損

要 因 (対 策)	対 策
<ul style="list-style-type: none"> ・切削条件の不適合 (a.b.c) ・再研削の不具合 (d.) ・機械剛性の不足 (e.f) ・切りくずづまり (a.b.c) ・ワークの取り付け不具合 (g) ・工具のセット不具合 (h.i.j) 	<ul style="list-style-type: none"> a. 送りを小さくする。 b. 切削速度を小さくする。 c. ステップフィードを行う。 d. シンニングやリップハイトを適正に再研削する。 e. 高剛性のスピンドルを使用する。 f. 機械のガタを調整する。 g. ワークのクランプをしっかりと行う。 h. 機械にドリルをセットしたときの外周の振れを調整する。 i. ドリルの保持具のセットを完全にする。 j. ガイドブッシュを使用する。

◎切れ刃のチッピング、チゼル部の欠け

<ul style="list-style-type: none"> ・切削条件の不適合 (a.b) ・再研削の不具合 (c) ・機械のガタ (d) ・ワークの取付不具合 (e) ・工具のセット不具合 (f.g.h) ・ドリルの使用不適合 (i) 	<ul style="list-style-type: none"> a. 送りを小さくする。 b. 食付き時の送りを小さくする。 c. シンニングの片寄りやリップハイトを適正に再研削する。 d. 主軸の振れや機械のガタを調整する。 e. ワークのクランプをしっかりと行う。 f. 機械にドリルをセットしたときの外周の振れを調整する。 g. ドリルの保持具のセットを完全にする。 h. ガイドブッシュを使用する。 i. ドリルの溝長を短くし剛性を高める。
---	--

◎ドリルの摩耗

<ul style="list-style-type: none"> ・切削条件の不適合 (a.b) ・切削油剤の供給量不足 (c) ・切削油剤の不適合 (d.e) ・切りくずの排出不具合 (a.b.f) ・被削材の硬さ不均一 (g) ・ドリルの不適合 (h) 	<ul style="list-style-type: none"> a. 切削速度を遅くする。 b. ステップフィードを行う。 c. 切削油剤の吐出量を多くする。 d. 極圧添加油を使用する。 e. 給油方向を適正にする。 f. 再研削にて適正なシンニング、逃げ角にする。 g. 被削材の硬さを均一にする。 h. ドリル材質を変える。(さらに耐摩耗性、耐熱性のあるもの)
--	--

◎穴精度 (穴の拡大、曲がり、倒れ等)

<ul style="list-style-type: none"> ・機械のガタおよびスピンドルの振れ (a) ・送りの過大 (b) ・食付き時の不具合 (f.g) ・ドリルの振れ (d.e) ・刃先精度の不具合 (f.g) ・ドリルの剛性不足 (h) 	<ul style="list-style-type: none"> a. 機械の調整、剛性補強をする。 b. 送りを適正にする。 c. 前加工にスターティングドリルを使用する。 d. ガイドブッシュを使用する。 e. ドリル取付けを修正する。 f. リップハイト、チゼル偏心を適正に再研削する。 g. シンニングの適正化。 h. 短く剛性のあるドリルを使用する。
---	--

◎シャンク部の破損

<ul style="list-style-type: none"> ・テーパシャンクのテーパ部の傷 (a) ・スリーブの摩滅、傷 (b) 	<ul style="list-style-type: none"> a. テーパ部の傷を取る。 b. スリーブを再研削または新品と交換する。
---	---

◎加工穴の面粗さが悪い

<ul style="list-style-type: none"> ・送りが過大 (a) ・切削油剤の不足、不良 (b) ・ワークの取付け不具合 (c) 	<ul style="list-style-type: none"> a. 送りを適正にする。 b. 給油方向、方法または切削油剤を変える。 c. ワークのクランプをしっかりとる。
--	---

ドリル加工のトラブルと原因対策

Broken drill

Cause (Remedy)	Remedy
<ul style="list-style-type: none"> • Cutting condition not suitable (a,b,c) • Regrinding failure (d) • Machine rigidity short (e,f) • Chips clogging (a,b,c) • Work setting failure (g) • Tool setting failure (h,i,j) 	<ul style="list-style-type: none"> a. Reduce feed rate. b. Reduce cutting speed. c. Perform step feed. d. Perform thinning or regrind the lip height properly. e. Use a highly rigid spindle. f. Adjust backlash in the machine. g. Firmly clamp the work. h. Adjust the peripheral run-out of a drill after setting it to the machine. i. Steady the drill retainer. j. Use a guide bush.

Cracked cutting edge or chisel

<ul style="list-style-type: none"> • Cutting condition not suitable (a,b) • Regrinding failure (c) • Backlashing in the machine (d) • Work setting failure (e) • Tool setting failure (f,g,h) • Use of a drill not suitable. (i) 	<ul style="list-style-type: none"> a. Reduce feed rate. b. Reduce feed at the time of biting. c. Properly regrind biased thinning or lip height. d. Adjust run-out of spindle or backlash in the machine. e. Firmly clamp the work. f. Adjust the peripheral run-out of a drill after setting it to the machine. g. Steady the drill retainer. h. Use a guide bush. i. Reduce a groove length of the drill to increase rigidity.
--	---

Drill abrasion

<ul style="list-style-type: none"> • Cutting condition not suitable (a,b) • Cutting fluid level low (c) • Cutting fluid not suitable (d,e) • Chips discharge failure (a,b,f) • Work material hardness uneven (g) • Drill not suitable (h) 	<ul style="list-style-type: none"> a. Lower the cutting speed. b. Perform step feed. c. Increase cutting fluid discharge rate. d. Use extreme-pressure additives. e. Correct the oiling direction. f. Regrind and obtain a proper thinning and relieving angle. g. Select work material of even hardness. h. Change the drill material (to the one with higher abrasion resistance and heat resistance.)
---	--

Hole accuracy (hole enlargement, bend or falling)

<ul style="list-style-type: none"> • Backlash in the machine or spindle run-out (a) • Excessive feed (b) • Biting failure (f,g) • Drill run-out (d,e) • Tooth edge accuracy failure (f,g) • Insufficient drill rigidity (h) 	<ul style="list-style-type: none"> a. Adjust the machine and increase rigidity of the machine. b. Adjust the feed. c. Preprocess with a starting drill. d. Use a guide bush. e. Correct drill setting. f. Regrind to get proper lip height and chisel centering. g. Perform thinning properly. h. Use a short and rigid drill.
---	--

Breakage in the shank

<ul style="list-style-type: none"> • A flaw on the taper of a taper shank (a) • Abrasion or flaw in the sleeve (b) 	<ul style="list-style-type: none"> a. Eliminate the flaw on the taper. b. Regrind the sleeve or replace it.
--	---

Insufficient surface roughness of drilled hole

<ul style="list-style-type: none"> • Excessive feed (a) • Cutting fluid level low or improper (b) • Work loading failure (c) 	<ul style="list-style-type: none"> a. Adjust the feed. b. Change oil feeding direction, method or type of cutting fluid. c. Retighten the work clamp.
---	--

穴の公差等級並びに寸法許容差

JIS B 0401-2:1998 による

○ 穴FG及びHに対する寸法許容差 Limit deviations for FG holes and H holes

上の寸法許容差 = ES 下の寸法許容差 = EI

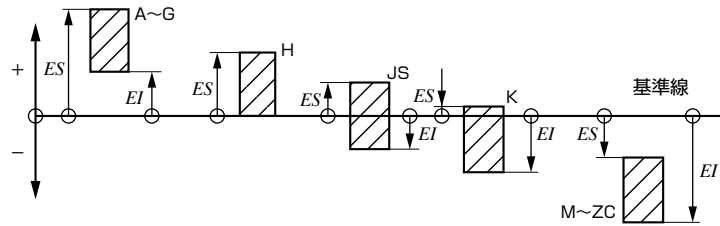

穴 (内側形体)

図1 上及び下の寸法許容差

基準寸法 (mm)		H												
		1	2	3	4	5	6	7	8	9	10	11	12	13
を 超え	以下	寸法許容差												
		μm											mm	
-	3	+0.8 0	+1.2 0	+2 0	+3 0	+4 0	+6 0	+10 0	+14 0	+25 0	+40 0	+60 0	+0.1 0	+0.14 0
3	6	+1 0	+1.5 0	+2.5 0	+4 0	+5 0	+8 0	+12 0	+18 0	+30 0	+48 0	+75 0	+0.12 0	+0.18 0
6	10	+1 0	+1.5 0	+2.5 0	+4 0	+6 0	+9 0	+15 0	+22 0	+36 0	+58 0	+90 0	+0.15 0	+0.22 0
10	18	+1.2 0	+2 0	+3 0	+5 0	+8 0	+11 0	+18 0	+27 0	+43 0	+70 0	+110 0	+0.18 0	+0.27 0
18	30	+1.5 0	+2.5 0	+4 0	+6 0	+9 0	+13 0	+21 0	+33 0	+52 0	+84 0	+130 0	+0.21 0	+0.33 0
30	50	+1.5 0	+2.5 0	+4 0	+7 0	+11 0	+16 0	+25 0	+39 0	+62 0	+100 0	+160 0	+0.25 0	+0.39 0
50	80	+2 0	+3 0	+5 0	+8 0	+13 0	+19 0	+30 0	+46 0	+74 0	+120 0	+190 0	+0.3 0	+0.46 0
80	120	+2.5 0	+4 0	+6 0	+10 0	+15 0	+22 0	+35 0	+54 0	+87 0	+140 0	+220 0	+0.35 0	+0.54 0

○ 穴JSに対する寸法許容差※1 Limit deviations for JS holes

上の寸法許容差 = ES 下の寸法許容差 = EI

基準寸法 (mm)		JS												
		1	2	3	4	5	6	7	8	9	10	11	12	13
を 超え	まで	寸法許容差												
		μm											mm	
-	3	± 0.4	± 0.6	± 1	± 1.5	± 2	± 3	± 5	± 7	± 12.5	± 20	± 30	± 0.05	± 0.07
3	6	± 0.5	± 0.75	± 1.25	± 2	± 2.5	± 4	± 6	± 9	± 15	± 24	± 37.5	± 0.06	± 0.09
6	10	± 0.5	± 0.75	± 1.25	± 2	± 3	± 4.5	± 7.5	± 11	± 18	± 29	± 45	± 0.075	± 0.11
10	18	± 0.6	± 1	± 1.5	± 2.5	± 4	± 5.5	± 9	± 13.5	± 21.5	± 35	± 55	± 0.09	± 0.135
18	30	± 0.75	± 1.25	± 2	± 3	± 4.5	± 6.5	± 10.5	± 16.5	± 26	± 42	± 65	± 0.105	± 0.165
30	50	± 0.75	± 1.25	± 2	± 3.5	± 5.5	± 8	± 12.5	± 19.5	± 31	± 50	± 80	± 0.125	± 0.195
50	80	± 1	± 1.5	± 2.5	± 4	± 6.5	± 9.5	± 15	± 23	± 37	± 60	± 95	± 0.15	± 0.23
80	120	± 1.25	± 2	± 3	± 5	± 7.5	± 11	± 17.5	± 27	± 43.5	± 70	± 110	± 0.175	± 0.27

注 ※1 同じ寸法許容差の数値の繰返しを避けるために、表は“ $\pm x$ ”のように数値を記入してある。

これは、 $ES = +x$ 及び $EI = -x$ 、例えば、 $\pm 0.23 \mu\text{m}$ のように解釈する。

ねじの寸法規格

JIS B 0123:1999 による

● ねじの表し方 Designation system for screw threads

● ねじの種類を表す記号及びねじの呼びの表し方の例

区分	ねじの種類		ねじの種類を表す記号	ねじの呼びの表し方の例
ピッチをmmで 表すねじ	メートル並目ねじ		M	M8
	メートル細目ねじ			M8×1
	ミニチュアねじ		S	S0.5
	メートル台形ねじ		Tr	Tr10×2
ピッチを山数で 表すねじ	管用テーパねじ	テーパおねじ	R	R $\frac{3}{4}$
		テーパめねじ	Rc	Rc $\frac{3}{4}$
		平行めねじ	Rp	Rp $\frac{3}{4}$
	管用平行ねじ		G	G $\frac{1}{2}$
	ユニファイ並目ねじ		UNC	$\frac{3}{8}$ -16UNC
	ユニファイ細目ねじ		UNF	No.8-36UNF

ねじの寸法規格

ユニファイ並目ねじの基準寸法 Basic dimensions for unified coarse screw threads

ユニファイねじの基準山形

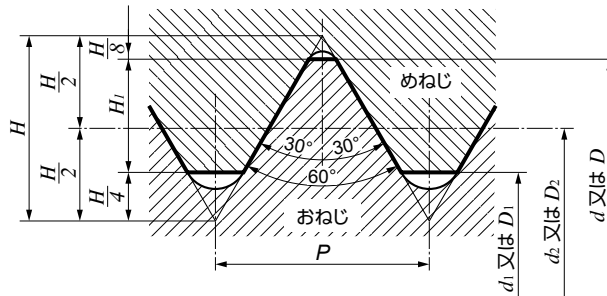

単位：mm

ねじの呼び	ねじ山数 (25.4mm につき) <i>n</i>	ピッチ <i>P</i> (参考)	ひっかかりの 高さ <i>H</i> ₁	めねじ		
				谷の径 <i>D</i>	有効径 <i>D</i> ₂	内径 <i>D</i> ₁
				おねじ		
				外径 <i>d</i>	有効径 <i>d</i> ₂	谷の径 <i>d</i> ₁
No. 1-64 UNC	64	0.3969	0.215	1.854	1.598	1.425
No. 2-56 UNC	56	0.4536	0.246	2.184	1.890	1.694
No. 3-48 UNC	48	0.5292	0.286	2.515	2.172	1.941
No. 4-40 UNC	40	0.6350	0.344	2.845	2.433	2.156
No. 5-40 UNC	40	0.6350	0.344	3.175	2.764	2.487
No. 6-32 UNC	32	0.7938	0.430	3.505	2.990	2.647
No. 8-32 UNC	32	0.7938	0.430	4.166	3.650	3.307
No. 10-24 UNC	24	1.0583	0.573	4.826	4.138	3.680
No. 12-24 UNC	24	1.0583	0.573	5.486	4.798	4.341
¼-20 UNC	20	1.2700	0.687	6.350	5.524	4.976
⅕-18 UNC	18	1.4111	0.764	7.938	7.021	6.411
⅜-16 UNC	16	1.5875	0.859	9.525	8.494	7.805
⅞-14 UNC	14	1.8143	0.982	11.112	9.934	9.149
½-13 UNC	13	1.9538	1.058	12.700	11.430	10.584
⅙-12 UNC	12	2.1167	1.146	14.288	12.913	11.996
⅝-11 UNC	11	2.3091	1.250	15.875	14.376	13.376
¾-10 UNC	10	2.5400	1.375	19.050	17.399	16.229
⅞- 9 UNC	9	2.8222	1.528	22.225	20.391	19.169
1 - 8 UNC	8	3.1750	1.719	25.400	23.338	21.963
1⅛- 7 UNC	7	3.6286	1.964	28.575	26.218	24.648
1¼- 7 UNC	7	3.6286	1.964	31.750	29.393	27.823
1⅝- 6 UNC	6	4.2333	2.291	34.925	32.174	30.343
1½- 6 UNC	6	4.2333	2.291	38.100	35.349	33.518
1¾- 5 UNC	5	5.0800	2.750	44.450	41.151	38.951
2 -4½ UNC	4½	5.6444	3.055	50.800	47.135	44.689
2¼-4½ UNC	4½	5.6444	3.055	57.150	53.485	51.039
2½- 4 UNC	4	6.3500	3.437	63.500	59.375	56.627
2¾- 4 UNC	4	6.3500	3.437	69.850	65.725	62.977
3 - 4 UNC	4	6.3500	3.437	76.200	72.075	69.327
3¼- 4 UNC	4	6.3500	3.437	82.550	78.425	75.677
3½- 4 UNC	4	6.3500	3.437	88.900	84.775	82.027
3¾- 4 UNC	4	6.3500	3.437	95.250	91.125	88.377
4 - 4 UNC	4	6.3500	3.437	101.600	97.475	94.727

ねじの寸法規格

JIS B 0206:1973 による

ユニファイ細目ねじの基準寸法 Basic dimensions for unified fine screw threads

ユニファイねじの基準山形

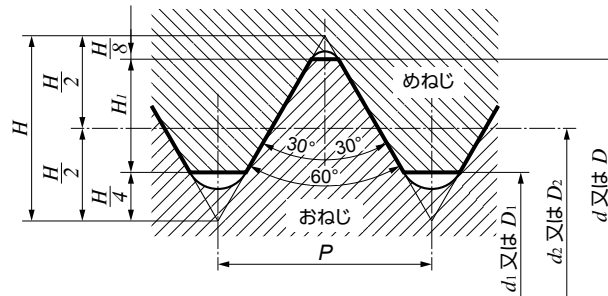

単位：mm

ねじの呼び	ねじ山数 (25.4mm につき) <i>n</i>	ピッチ <i>P</i> (参考)	ひっかかりの 高さ <i>H₁</i>	めねじ		
				谷の径 <i>D</i>	有効径 <i>D₂</i>	内径 <i>D₁</i>
				おねじ		
				外径 <i>d</i>	有効径 <i>d₂</i>	谷の径 <i>d₁</i>
No. 0-80 UNF	80	0.3175	0.172	1.524	1.318	1.181
No. 1-72 UNF	72	0.3528	0.191	1.854	1.626	1.473
No. 2-64 UNF	64	0.3969	0.215	2.184	1.928	1.755
No. 3-56 UNF	56	0.4536	0.246	2.515	2.220	2.024
No. 4-48 UNF	48	0.5292	0.286	2.845	2.502	2.271
No. 5-44 UNF	44	0.5773	0.312	3.175	2.799	2.550
No. 6-40 UNF	40	0.6350	0.344	3.505	3.094	2.817
No. 8-36 UNF	36	0.7056	0.382	4.166	3.708	3.401
No. 10-32 UNF	32	0.7938	0.430	4.826	4.310	3.967
No. 12-18 UNF	28	0.9071	0.491	5.486	4.897	4.503
¼-28 UNF	28	0.9071	0.491	6.350	5.761	5.367
⅕-24 UNF	24	1.0583	0.573	7.938	7.249	6.792
⅜-24 UNF	24	1.0583	0.573	9.525	8.837	8.379
⅜-20 UNF	20	1.2700	0.687	11.112	10.287	9.738
½-20 UNF	20	1.2700	0.687	12.700	11.874	11.326
⅝-18 UNF	18	1.4111	0.764	14.288	13.371	12.761
⅝-18 UNF	18	1.4111	0.764	15.875	14.958	14.348
¾-16 UNF	16	1.5875	0.859	19.050	18.019	17.330
⅞-14 UNF	14	1.8143	0.982	22.225	21.046	20.262
1-12 UNF	12	2.1167	1.146	25.400	24.026	23.109
1 ⅛-12 UNF	12	2.1167	1.146	28.575	27.201	26.284
1 ¼-12 UNF	12	2.1167	1.146	31.750	30.376	29.459
1 ⅜-12 UNF	12	2.1167	1.146	34.925	33.551	32.634
1 ½-12 UNF	12	2.1167	1.146	38.100	36.726	35.809

● 管用テーパねじ Taper Pipe Threads

● 基準山形及び基準寸法

テーパおねじ及びテーパめねじに対して適用する基準山形

テーパおねじとテーパめねじとのはめあい

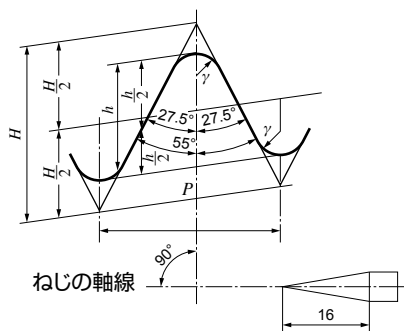

$$P = \frac{25.4}{n}$$

$$H = 0.960237P$$

$$h = 0.640327P$$

$$\gamma = 0.137278P$$

太い実線は基準山形を示す。

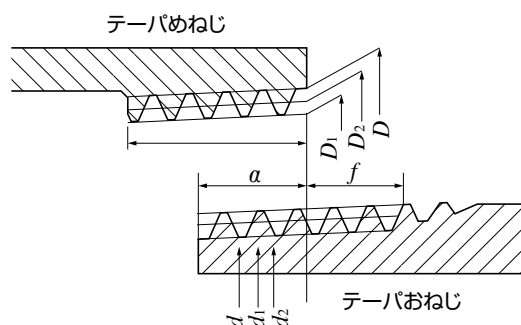

単位 Unit : mm

ねじの呼び ^{※1}	ねじ山				基準径			基準径の位置		有効ねじ部の長さ(最小)	
	ねじ山数 (25.4mm につき n)	ピッチ P (参考)	山の高さ h	丸み γ または γ'	おねじ			おねじ 管端から 基準の 長さ a	めねじ 管端部 軸線方 向の 許容差 ±c	めねじ	
					外径 d	有効径 d ₂	谷の径 d ₁			不完全 ねじ部が ある場合	不完全 ねじ部が ない場合
					めねじ			基準径の 位置から 小径側に 向かって	基準径又は 管・管継手 端から		
					谷の径 D	有効径 D ₂	内径 D ₁				
R 1/16	28	0.9071	0.581	0.12	7.723	7.142	6.561	3.97	1.13	6.2	4.4
R 1/8	28	0.9071	0.581	0.12	9.728	9.147	8.566	3.97	1.13	6.2	4.4
R 1/4	19	1.3368	0.856	0.18	13.157	12.301	11.445	6.01	1.67	9.4	6.7
R 3/8	19	1.3368	0.856	0.18	16.662	15.806	14.950	6.35	1.67	9.7	7.0
R 1/2	14	1.8143	1.162	0.25	20.955	19.793	18.631	8.16	2.27	12.7	9.1
R 3/4	14	1.8143	1.162	0.25	26.441	25.279	24.117	9.53	2.27	14.1	10.2
R 1	11	2.3091	1.479	0.32	33.249	31.770	30.291	10.39	2.89	16.2	11.6
R 1 1/4	11	2.3091	1.479	0.32	41.910	40.431	38.952	12.70	2.89	18.5	13.4
R 1 1/2	11	2.3091	1.479	0.32	47.803	46.324	44.845	12.70	2.89	18.5	13.4
R 2	11	2.3091	1.479	0.32	59.614	58.135	56.656	15.88	2.89	22.8	16.9
R 2 1/2	11	2.3091	1.479	0.32	75.184	73.705	72.226	17.46	3.46	26.7	18.6
R 3	11	2.3091	1.479	0.32	87.884	86.405	84.926	20.64	3.46	29.8	21.1
R 4	11	2.3091	1.479	0.32	113.030	111.551	110.072	25.40	3.46	35.8	25.9
R 5	11	2.3091	1.479	0.32	138.430	136.951	135.472	28.58	3.46	40.1	29.3
R 6	11	2.3091	1.479	0.32	163.830	162.351	160.872	28.58	3.46	40.1	29.3

注※1 この呼びは、テーパおねじに対するもので、テーパめねじ及び平行めねじの場合は、Rの記号をRc又はRpとする。

備考 1. ねじ山は中心軸線に直角とし、ピッチは中心軸線にそって測る。

2. 有効ねじ部の長さとは、完全なねじ山が切られたねじ部の長さで、最後の数山だけは、その項に管又は管継手に面が残っていてもよい。また、管又は管継手の末端に面取りがしてあっても、この部分を有効ねじ部の長さを含める。

参考値

Technical Data

Reference Data

ねじの寸法規格

ANSI/ASME B1・20・1-1983による

○ 一般用アメリカ管用ねじ American Pipe Threads, general purpose(Inch)

アメリカ管用ねじの表し方の例

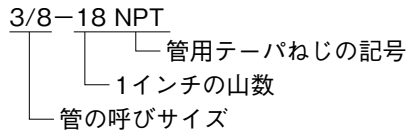

アメリカ管用ねじNPTの基準寸法

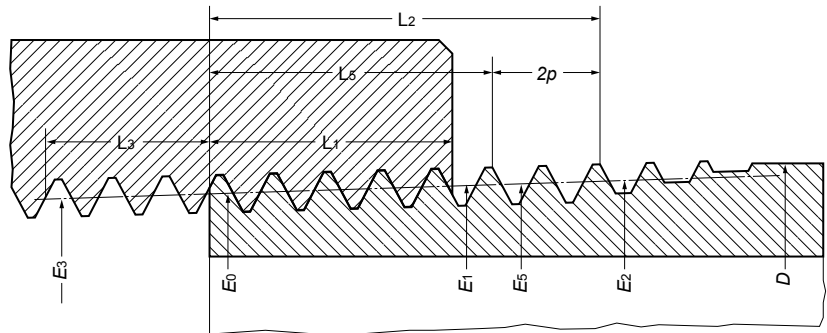

- ねじのテーパ=1/16 (1フートにつき0.75インチ)
- ねじ山の角度=60°(軸直角)
- とがり山の高さ $H=0.866025p$
- ねじ山の高さ $h=0.800000p$

単位 Unit : mm

呼びサイズ*1	管の外径 D		山数 (25.4mmにつき)	ねじのピッチ P	手回し締めによるはめ込み長さ			おねじの有効長さ		レンチによる増し締め長さ		管端のおねじの谷径 Ke
					L1		有効径 E1	L2		L3		
					長さ	ねじ山数		長さ	ねじ山数	長さ	ねじ山数	
1	2(インチ)	2	3	4	6	7	8	9	10	14	15	24
1/16	0.3125	7.938	27	0.94082	4.064	4.32	7.142	6.632	7.05	2.822	3	6.137
1/8	0.405	10.287	27	0.94082	4.102	4.36	9.489	6.703	7.12	2.822	3	8.481
1/4	0.540	13.716	18	1.41122	5.786	4.10	12.487	10.206	7.23	4.234	3	10.996
3/8	0.675	17.145	18	1.41122	6.096	4.32	15.926	10.358	7.34	4.234	3	14.417
1/2	0.840	21.336	14	1.81432	8.128	4.48	19.772	13.556	7.47	5.443	3	17.813
3/4	1.050	26.670	14	1.81432	8.611	4.75	25.117	13.861	7.64	5.443	3	23.127
1	1.315	33.401	11.5	2.20878	10.160	4.60	31.461	17.343	7.85	6.627	3	29.060
1 1/4	1.660	42.164	11.5	2.20878	10.668	4.83	40.218	17.953	8.13	6.627	3	37.785
1 1/2	1.900	48.260	11.5	2.20878	10.668	4.83	46.278	18.377	8.32	6.627	3	43.853
2	2.375	60.325	11.5	2.20878	11.074	5.01	58.325	19.215	8.70	6.627	3	55.867
2 1/2	2.875	73.025	8	3.17500	17.323	5.46	70.159	28.893	9.10	6.350	2	66.535
3	3.500	88.900	8	3.17500	19.456	6.13	86.068	30.480	9.60	6.350	2	82.311
3 1/2	4.000	101.600	8	3.17500	20.853	6.57	98.776	31.750	10.00	6.350	2	94.933
4	4.500	114.300	8	3.17500	21.438	6.75	111.433	33.020	10.40	6.350	2	107.554
5	5.563	141.300	8	3.17500	23.800	7.50	138.412	35.720	11.25	6.350	2	134.384
6	6.625	168.275	8	3.17500	24.333	7.66	165.252	38.418	12.10	6.530	2	161.191
8	8.625	219.075	8	3.17500	27.000	8.50	215.901	43.498	13.70	6.530	2	211.673
10	10.750	273.050	8	3.17500	30.734	9.68	269.772	48.895	15.40	6.350	2	265.311
12	12.750	323.850	8	3.17500	34.544	10.88	320.492	53.975	17.00	6.350	2	315.793
14 OD	14.000	355.600	8	3.17500	39.675	12.50	352.365	57.150	18.00	6.350	2	347.345
16 OD	16.000	406.400	8	3.17500	46.025	14.50	403.244	62.230	19.60	6.350	2	397.828
18 OD	18.000	457.200	8	3.17500	50.800	16.00	454.025	67.310	21.20	6.350	2	448.310
20 OD	20.000	508.000	8	3.17500	53.975	17.00	504.706	72.390	22.80	6.350	2	498.793
24 OD	24.000	609.600	8	3.17500	60.325	19.00	606.068	82.550	26.00	6.350	2	599.758

*1 呼び方は次による。

3/8NPTあるいは0.675NPT

— 外径のデシマル寸法

(注)原文からのメートル換算は、ピッチPは小数5位、その他は小数3位以下四捨五入。

原文には欄の番号が1~24あり、上表のほか各部有効径、L2-L1、L4、L5、ねじ山高さh、山あたりの直径増加が示されている。

Table of corresponding Tool Steels brands 工具鋼のブランド対照表

「一般社団法人 特殊鋼倶楽部 WEB サイト 2017年改訂版」より

冷間金型用鋼 Steels for cold molding

分類 Group	JIS相当 Corresponding JIS class	AISI相当 Corresponding AISI class	愛知製鋼(株) Aichi Steel	山陽特殊製鋼(株) Sanyo Special Steel	大同特殊鋼(株) Daido Steel	日本高周波鋼業(株) Nippon Koshuha Steel	日立金属(株) Hitachi Metals	(株)不二越 Nachi Fujikoshi	ウッデホルム(株) Udde Holm	ボーラー Bohler	
炭素工具鋼 Carbon Tool Steels	SK105	W1-10		QK3	YK3					K990	
合金工具鋼 Alloy Tool Steels	SKS93		SK301	QK3M	YK30	K3M	YCS3				
	SKS3		SKS3	QKS3	GOA	KS3	SGT		ARNE	K460	
	SKD1	D3			DC1	KD1	CRD		SVERKER3	K100, K107	
	SKD11	D2	SKD11	QC11	DC11	KD11	SLD SLD-i	CDS11	SVERKER21	K105 K110	
	SKD11(改)					KD11MAX KD11S					
	8% Cr 系		AUD15 AUD11	QCM7 QCM8	DC53	KD21	SLD8 SLD10	MDS9	SLEIPNER	K340	
	マトリックス系 ダイス鋼 Matrix type die steel		SXACE		DCMX	NOGA	ARK1		CALDIE UNIMAX	W360	
	SKD12	A2			DC12	KD12			RIGOR	K305	
	プリハードン 40HRC Pre-hardened steel				GO40F	KAP65	HPM-MAGIC		IMPAX HH		
	火炎焼入鋼 Flame-tempered steels		SX105V	QF3	GO5	KRCX	HMD5		FERMO		
	低温空冷鋼 Low-temperature air-cooled steels				GO4	KSM	ACD37				
	耐衝撃鋼 Impact-resistant steels			QF1	GS5	KTV5	YSM				
	その他 Others							SLD-MAGIC	ICS22	CALMAX ELMAX VANCRON40 VANADIS4E VANADIS10	K390 K490 K890
	高速度工具鋼 High-speed Tool Steels	SKH51	M2		QH51	MH51	H51	YXM1	SKH9		S600
SKH51系								SKH9D			
SKH55系						HM35	YXM4	HM35 HS53M		S705	
SKH57系						MV10	XVC5	HS93R DURO-SP		S700	
マトリックス系 Matrix type				QHZ	DRM1 DRM2 DRM3 MH85	KMX1 KMX2 KMX3	YXR3 YXR7 YXR33	DURO-FZ DURO-F1 DURO-F3 DURO-F7 DURO-V2 DURO-V5			
粉末高速度工具鋼 Sintered High-speed Tool Steels	SKH40			SPM30	DEX40		HAP40	FAX38	VANADIS30	S590	
	マトリックス系 Matrix type				DEX-M1 DEX-M3		HAP5R				
	その他 Others			SPM23 SPM60 SPMR8 SPMV6 SPMX4N	DEX20 DEX60		HAP10 HAP50 HAP72	FAX31 FAX40 FAX55 FAXG2	VANADIS23 VANADIS60	S290 S390 S690 S790	

Technical Data
Reference Data

Table of corresponding Tool Steels brands 工具鋼のブランド対照表

「一般社団法人 特殊鋼倶楽部 WEB サイト 2017年改訂版」より

熱間金型用鋼 Steels for hot molding () は鋼種統合

分類 Group	JIS相当 Corresponding JIS class	AISI相当 Corresponding AISI class	愛知製鋼(株) Aichi Steel	山陽特殊製鋼(株) Sanyo Special Steel	大同特殊鋼(株) Daido Steel	日本高周波鋼業(株) Nippon Koshuha Steel	日立金属(株) Hitachi Metals	(株)不二越 Nachi Fujikoshi	三菱製鋼(株) Mitsubishi Steel	ウッデホルム(株) Udde Holm	ボーラー Bohler	
合金工具鋼 Alloy Tool Steels	SKD4				DH4	KD4						
	SKD5	H21			DH5	KD5						
	SKD6	H11			DH6	KD6				VIDAR	W300 W400	
	SKD61	H13	SKD61	QD61	DHA DHA1	KDA	DAC			ORVAR-2M	W302	
	SKD61 (改)		AUD61 AUD60A	QDA61 QDN QDX- HARMOTEX QDN1-R	DHA2 DH21 DHA- WORLD DH31-S DH31-EX	KDA1 KDA1S KDAMAX	DAC-S DAC3 DAC10 DAC55 DAC-MAGIC			ORVAR-S DIEVAR FORMVAR	W303 W403	
	SKD61 (快削)				DH2F	KAP90F	FDAC					
	SKD62	H12		QD62	DH62	KDB						
	SKD7	H10			DH72	KDH1					W320	
	SKD7 (改)		AUD72	QDH	DH32 DH71 DH73		DAC40 YEM-K	DURO-N1				
	SKD8	H19			DH41	KDF						
	SKD8 (改)				DH42	KDF4	MDC-K					
	SKT4	L6	SKT4A	QT41- HARMOTEX	GFA	KTV	DM				ALVAR14	W500
	SKT4 (改)			QDT	GF78	TD3						
	析出硬化鋼		AUD91 MPH-K		DH76				HD22B			
	その他 Others			QF5	DHA- Thermo						BURE BALDER	
高速度 工具鋼 High-speed Tool Steels	マトリックス 系			QHZ	DRM1 DRM2	KMX1	YXR33	DURO-FZ DURO-F1			W360	

プラスチック金型用鋼 Steels for plastic molds () は鋼種統合

分類 Group	硬さ (HRC) Group	JIS相当 Corresponding JIS class	AISI相当 Corresponding AISI class	愛知 製鋼(株) Aichi Steel	JFE スチール JFE Steel	山陽特殊 製鋼(株) Sanyo Special Steel	大同 特殊鋼(株) Daido Steel	日本高周波 鋼業(株) Nippon Koshuha Steel	日立 金属(株) Hitachi Metals	(株)不二越 Nachi Fujikoshi	ウッデ ホルム(株) Udde Holm	ボーラー Bohler	
プリハードン鋼 Pre-hardened Steels	13	SC系	1055		JFE-MD1	PC55		KPM1 KPMAX					
	28	SCM系	4140		JFE-MD3 JFE-MD5		PDS3						
	33	SCM (改)	P20			PCM30	PX5 PXA30	KPM30	HPM7			M200 M201 M238	
		SUS系	S420系				S-STAR D-STAR	GHX	HPM38	PROVA-400 PROVA-450	STAVAX	M303 M310	
		SUS系 (快削)					G-STAR		HPM77		RoyAlloy	M315	
	35	SUS系	S17400			QSH6	NAK101	U630	PSL		CORRAX	N700	
	36	SCM (改)	P20					JHX			IMPAXHH		
	40	SUS系										EDRO400	M303HH
		SKD61 (改)	H13					DH2F	KAP90F	FDAC			
			P21			PCM40S	NAK80	KAP88	HPM-PRO				M461
			P21(快削)			PCM40	NAK55	KAP65	HPM1				M261
		P21(耐錆)							CENA1 CENA-V				
								HPM-MAGIC		NIMAX			
焼入れ焼戻し鋼 Quench-Tempered Steels	60	SKD11 (改)	D2	AUD11		QCM8 SPMR8 (粉末)	PD613	NOGA	HPM31 ZCD-M		RIGOR SLEIPNER CALDIE CALMAX	K105 K110 K340	
	57	SUS系 440C	S44004			QPD5 SPC5 (粉末)	SUS440C	SUS440C	SUS440C	440C PROVA-500 (粉末)	ELMAX	M340 M390 N685 N690 N695	
	52	SUS系 420	S420系				S-STAR D-STAR G-STAR	GHX	HPM38 HPM38S HPM77	PROVA-400 PROVA-450	STAVAX POLMAX MIRRAX	M310 M333	
時効処理鋼 Age-Hardened Steels	50 以上 or more	マルエー ジング鋼				QM300	MAS1C	KMS	YAG	EXEO-M21		V720 V721	
		その他 Others									CORRAX		
	40	非磁性鋼						NMS1	HPM75				

Table of corresponding Tool Steels brands 工具鋼のブランド対照表

「一般社団法人 特殊鋼倶楽部 WEB サイト 2017年改訂版」より

○ 高速度工具鋼 High-speed Tool Steels

分類	JIS相当 Corresponding JIS class	AISI相当 Corresponding AISI class	山陽特殊 製鋼(株) Sanyo Special Steel	大同 特殊鋼(株) Daido Steel	日本高周波 鋼業(株) Nippon Koshuha Steel	日立 金属(株) Hitachi Metals	(株)不二越 Nachi Fujikoshi	ウッデ ホルム(株) Udde Holm	ボーラー Bohler
タン グス テ ン 系 Tungsten type	SKH2	T1			H2	YHX2	SKH2		S200
	SKH3	T4			H3		SKH3		S305
	SKH4	T5			H4		SKH4		
	SKH10	T15			HV5				
モ リ ブ デ ン 系 Molybdenum type	SKH51	M2	QH51	MH51	H51	YXM1	SKH9		S600 S614 S401
	SKH52	M3-1			H52		HM31		
	SKH53	M3-2			HV1				S607
	SKH54	M4			HV2		HM4		
	SKH55				HM35	YXM4	HM35		S705
	SKH56	M36			HM36		HM36		
	SKH57				HV10	XVC5	HS93R		S700
	SKH58	M7			HM3		HM7NN		S400
	SKH59	M42			HM42	YXM42	HM42		S500
	その他 Others				S70	YXM27 YXM60	HS53M HS97R HM1 HMT12 HM33 SKH9D DURO-SP		
マト リ ク ス 系 Matrix type	マトリックス系 Matrix type		QHZ	DRM1 DRM2 DRM3 MH85	KMX1 KMX2 KMX3	YXR3 YXR33 YXR7	DURO-FZ DURO-F1 DURO-F3 DURO-F7 DURO-V2 DURO-V5		W360
粉 末 系 Powdered type	SKH40		SPM30	DEX40		HAP40	FAX38	VANADIS30	S590
	その他 Others		SPM23 SPM60 SPMR8 SPMV6 SPMX4N	DEX20 DEX60 DEX-M1 DEX-M3		HAP10 HAP50 HAP72 HAP5R	FAX31 FAX40 FAX55 FAXG2	VANADIS23 VANADIS60	S290 S390 S690 S790

表面粗さ Surface roughness

種類 Type	記号 Symbol	求め方 Method of determination	求め方の例(図) Example (diagram) of method of determination
算術平均粗さ Calculated average roughness	Ra	粗さ曲線からその平均線の方向に基準長さだけを抜き取り、この抜き取り部分の平均線の方向にX軸を、縦倍率の方向にY軸を取り、粗さ曲線を $y=f(x)$ で表したときに、次の式によって求められる値をマイクロメートル(μm)で表したものをいう。 From the direction of the average line of the roughness curve of a sampled standard length, plot the direction of the average line of the sampled section on the X axis and the direction of the vertical magnification on the Y axis, and express the roughness curve using the equation $y=f(x)$. The roughness value is then expressed in micrometers (μm) as the value determined from the following expression. $Ra = \frac{1}{\ell} \int_0^{\ell} f(x) dx$	
最大高さ Maximum height	Rz	粗さ曲線からその平均線の方向に基準長さだけを抜き取り、この抜き取り部分の山頂線と谷底線との間隔を粗さ曲線の縦倍率の方向に測定し、この値をマイクロメートル(μm)で表したものをいう。 備考: Rzを求める場合には、きずとみなされるような並はずれて高い山および低い谷がない部分から、基準長さだけ抜き取る From the direction of the average line of the roughness curve of a sampled standard length, measure the interval between the peak and valley lines of the sampled section in the direction of the vertical magnification of the roughness curve, and express the roughness as this value in micrometers (μm). Note: When determining Rz, sample only the standard length where there are no parallel peaks or valleys which could be considered scratches. $Rz = Rp + Rv$	
十点平均粗さ 10-point average roughness	RzJIS	粗さ曲線からその平均線の方向に基準長さだけを抜き取り、この抜き取り部分の平均線から縦倍率の方向に測定した、最も高い山頂から5番目までの山頂の標高(Yp)の絶対値の平均値と、最も低い谷底から5番目までの谷底の標高(Yv)の絶対値の平均値との和を求め、この値をマイクロメートル(μm)で表したものをいう。 From the direction of the average line of the roughness curve of a sampled standard length, determine the sum of the average of the absolute values of the 5 highest peak points (Yp) and the average of the absolute values of the 5 lowest valley points (Yv) in the sampled section, and express this value in micrometers (μm). $Rz_{JIS} = \frac{(Yp1 + Yp2 + Yp3 + Yp4 + Yp5) + (Yv1 + Yv2 + Yv3 + Yv4 + Yv5)}{5}$	 <p>$Yp1, Yp2, Yp3, Yp4, Yp5$: 基準長さ ℓ に対する抜き取り部分の、最も高い山頂から5番目までの山頂の標高 The peak points from the highest to the 5th highest in the sampled section of the standard length (ℓ)</p> <p>$Yv1, Yv2, Yv3, Yv4, Yv5$: 基準長さ ℓ に対する抜き取り部分の、最も低い谷底から5番目までの谷底の標高 The valley points from the lowest to the 5th lowest in the sampled section of the standard length (ℓ)</p>

算術平均粗さ (Ra) と従来の表記の関係 (参考データ)

Relationship between calculated average roughness (Ra) and conventional labels (Reference data)

算術平均粗さ Ra Calculated average roughness		最大高さ Rz Maximum height	十点平均粗さ RzJIS 10-point average roughness	Rz・RzJISの基準長さ Standard length for Rz and RzJIS ℓ (mm)	従来の仕上げ記号 Conventional finish label
標準数値 Examples of standard values	カットオフ値 λc (mm) Cutoff value	標準数値 Examples of standard values			
0.012a	0.08	0.05s	0.05z	0.08	
0.025a		0.10s	0.10z		
0.050a	0.25	0.20s	0.20z	0.25	▽▽▽▽
0.100a		0.40s	0.40z		
0.200a	0.8	0.80s	0.80z	0.8	▽▽▽
0.400a		1.60s	1.60z		
0.800a	2.5	3.20s	3.20z	2.5	▽▽
1.600a		6.30s	6.30z		
3.200a	8	12.50s	12.50z	8	▽
6.300a		25.00s	25.00z		
12.500a	-	50.00s	50.00z	-	-
25.000a		100.00s	100.00z		
50.000a		200.00s	200.00z		
100.000a		400.00s	400.00z		

※3種類の相互関係は、便宜上の関係を表したもので厳密性はありません。Since the correlation between the 3 types are expressed as relations to the symbols, they are not precise.

※Ra・Rz・RzJISの評価長さはカットオフ値、基準長さをそれぞれ5倍した値です。
The evaluation lengths for Ra・Rz・RzJIS are 5 times the cutoff values and the standard lengths for each method.

被削性指数

鋼種 Type of steel	JIS 番号 JIS grade	被削性指数 Machinability indices	鋼種 Type of steel	JIS 番号 JIS grade	被削性指数 Machinability indices
硫黄快削鋼 Free-cutting sulfur Steels	SUM21	100	マルテンサイト系 ステンレス鋼 Martensite Stainless Steels	SUS403	45
	SUM1B	113		SUS410	45
	SUM32	82		SUS416	81
	SUM5	73		SUS420J1	45
ニッケルクロム モリブデン鋼 Nickel-chrome-molybdenum Steels	SNCM431	58		SUS420F	70
	SNCM625	55	SUS431	55	
	SNCM630	50	フェライト系 ステンレス鋼 Ferrite Stainless Steels	SUS405	55
	SNCM439	65		SUS430	48
	SNCM220	67		SUS430F	90
機械構造用炭素鋼 Carbon Steels for machine structures	SNCM815	55	オーステナイト系 ステンレス鋼 Austenite Stainless Steels	SUS302	35
	S10C	73		SUS303	60
	S15C	73		SUS304	45
	S20C	73		SUS316	45
	S30C	70		SUS317	45
	S35C	70		SUS321	45
	S45C	73		SUS347	45
クロム鋼 Chrome Steels	S50C	70	ねずみ鋳鉄 Gray Cast Iron	FC100	55
	SCr1	73		FC150	85
	SCr430	58		FC200	85
機械構造マンガン鋼 Manganese Steels for machine structures	SCr435	73		FC250	65
	SMn433	61		FC300	65
	SMn438	61		FC350	65
クロムモリブデン鋼 Chrome-molybdenum Steels	SMn443	58	チタン合金 (Ti-6Al-4V) Titanium Alloy		20
	SCM432	73	インコネル X (70Ni-7Fe-15Cr) Inconel		15
	SCM430	70	ステライト 21 Stellite 21 (Co-3Ni-27Cr-5.5Mo)		6
	SCM440	67	ステライト 31 Stellite 31 (Co-10Ni-25Cr-5.5Mo)		6
炭素工具鋼 Carbon Tool Steels	SCM421	49			
	SK1	42			
	SK5	42			
	SK6	49			
合金工具鋼 Alloy Tool Steels	SK7	51			
	SKD11	30			
	SKD61	48			

【注意】 被削性指数は被削性の目安となるもので、種々条件により変化します。

【Note】 The machinability indices are general criteria for machinability, and will vary according to various conditions.

硬さ換算表

○ ビッカース硬さに対する近似的換算値 Approximate conversion value for Vickers hardness

ビッカース硬さ HV	プリネリ硬さ 10mm球・ 荷重3000kgf		ロックウェル硬さ				シヨア硬さ HS	引張強さ (近似値) MPa (kgf/mm ²)
	標準球	タングステンカーバイド球 HB	Aスケール 荷重60kgf ダイヤモンド円盤 圧子 HRA	Bスケール 荷重100kgf 径1.6mm (1/16in)球 HRB	Cスケール 荷重150kgf ダイヤモンド円盤 圧子 HRC	Dスケール 荷重100kgf ダイヤモンド円盤 圧子 HRD		
1900	-	-	93.1	-	80.5	-	-	-
1800	-	-	92.6	-	79.2	-	-	-
1700	-	-	91.9	-	77.9	-	-	-
1600	-	-	91.3	-	76.6	-	-	-
1500	-	-	90.5	-	75.3	-	-	-
1450	-	-	90.1	-	74.6	-	-	-
1400	-	-	89.6	-	74.0	-	-	-
1350	-	-	89.1	-	73.4	-	-	-
1300	-	-	88.7	-	72.7	-	-	-
1250	-	-	88.3	-	72.1	-	-	-
1200	-	-	87.9	-	71.5	-	-	-
1150	-	-	87.5	-	70.9	-	-	-
1100	-	-	87.1	-	70.3	-	-	-
1050	-	-	86.6	-	69.6	-	-	-
1000	-	-	86.2	-	68.9	-	-	-
940	-	-	85.6	-	68.0	76.9	97	-
920	-	-	85.3	-	67.5	76.5	96	-
900	-	-	85.0	-	67.0	76.1	95	-
880	-	(767)	84.7	-	66.4	75.7	93	-
860	-	(757)	84.4	-	65.9	75.3	92	-
840	-	(745)	84.1	-	65.3	74.8	91	-
820	-	(733)	83.8	-	64.7	74.3	90	-
800	-	(722)	83.4	-	64.0	73.8	88	-
780	-	(710)	83.0	-	63.3	73.3	87	-
760	-	(698)	82.6	-	62.5	72.6	86	-
740	-	(684)	82.2	-	61.8	72.1	84	-
720	-	(670)	81.8	-	61.0	71.5	83	-
700	-	(656)	81.3	-	60.1	70.8	81	-
690	-	(647)	81.1	-	59.7	70.5	-	-
680	-	(638)	80.8	-	59.2	70.1	80	-
670	-	630	80.6	-	58.8	69.8	-	-
660	-	620	80.3	-	58.3	69.4	79	-
650	-	611	80.0	-	57.8	69.0	-	-
640	-	601	79.8	-	57.3	68.7	77	-
630	-	591	79.5	-	56.8	68.3	-	-
620	-	582	79.2	-	56.3	67.9	75	-
610	-	573	78.6	-	55.7	67.5	-	-
600	-	564	78.9	-	55.2	67.0	74	-
590	-	554	78.4	-	54.7	66.7	-	2055 (210)
580	-	545	78.0	-	54.1	66.2	72	2020 (206)
570	-	535	77.8	-	53.6	65.8	-	1985 (202)
560	-	525	77.4	-	53.0	65.4	71	1950 (199)
550	(505)	517	77.0	-	52.3	64.8	-	1905 (194)
540	(496)	507	76.7	-	51.7	64.4	69	1860 (190)
530	(488)	497	76.4	-	51.1	63.9	-	1825 (186)
520	(480)	498	76.1	-	50.5	63.5	67	1795 (183)
510	(473)	479	75.7	-	49.8	62.9	-	1750 (179)
500	(465)	471	75.3	-	49.1	62.2	66	1750 (174)
490	(456)	460	74.9	-	48.4	61.6	-	1660 (169)
480	448	452	74.5	-	47.7	61.3	64	1620 (165)
470	441	442	74.1	-	46.9	60.7	-	1570 (160)
460	433	433	73.6	-	46.1	60.1	62	1530 (156)
450	425	425	73.3	-	45.3	59.4	-	1495 (153)
440	415	415	72.8	-	44.5	58.8	59	1460 (149)
430	405	405	72.3	-	43.6	58.2	-	1410 (144)

ビッカース硬さ HV	プリネリ硬さ 10mm球・ 荷重3000kgf		ロックウェル硬さ				シヨア硬さ HS	引張強さ (近似値) MPa (kgf/mm ²)
	標準球	タングステンカーバイド球 HB	Aスケール 荷重60kgf ダイヤモンド円盤 圧子 HRA	Bスケール 荷重100kgf 径1.6mm (1/16in)球 HRB	Cスケール 荷重150kgf ダイヤモンド円盤 圧子 HRC	Dスケール 荷重100kgf ダイヤモンド円盤 圧子 HRD		
420	397	397	71.8	-	42.7	57.5	57	1370 (140)
410	388	388	71.4	-	41.8	56.6	-	1330 (136)
400	379	379	70.8	-	40.8	56.0	55	1290 (131)
390	369	369	70.3	-	39.8	55.2	-	1240 (127)
380	360	360	69.8	(110.0)	38.8	54.4	52	1205 (123)
370	350	350	69.2	-	37.7	53.6	-	1170 (120)
360	341	341	68.7	(119.0)	36.6	52.8	50	1130 (115)
350	331	331	68.1	-	35.5	51.9	-	1095 (112)
340	322	322	67.6	(108.0)	34.4	51.1	47	1070 (109)
330	313	313	67.0	-	33.3	50.2	-	1035 (105)
320	303	303	66.4	(107.0)	32.2	49.4	45	1005 (103)
310	294	294	65.8	-	31.0	48.4	-	980 (100)
300	284	284	65.2	(105.5)	29.8	47.5	42	950 (97)
295	280	280	64.8	-	29.2	47.1	-	935 (96)
290	275	275	64.5	(104.5)	28.5	46.5	41	915 (94)
285	270	270	64.2	-	27.8	46.0	-	905 (92)
280	265	265	63.8	(103.5)	27.1	45.3	40	890 (91)
275	261	261	63.5	-	26.4	44.9	-	875 (89)
270	256	256	63.1	(102.0)	25.6	44.3	38	855 (87)
265	252	252	62.7	-	24.8	43.7	-	840 (86)
260	247	247	62.4	(101.0)	24.0	43.1	37	825 (84)
255	243	243	62.0	-	23.1	42.2	-	805 (82)
250	238	238	61.6	99.5	22.2	41.7	36	795 (81)
245	233	233	61.2	-	21.3	41.1	-	780 (79)
240	228	228	60.7	98.1	20.3	40.3	34	765 (78)
230	219	219	-	96.7	(18.0)	-	33	730 (75)
220	209	209	-	95.0	(15.7)	-	32	695 (71)
210	200	200	-	93.4	(13.4)	-	30	670 (68)
200	190	190	-	91.5	(11.0)	-	29	635 (65)
190	181	181	-	89.5	(8.5)	-	28	605 (62)
180	171	171	-	87.1	(6.0)	-	26	580 (59)
170	162	162	-	85.0	(3.0)	-	25	545 (56)
160	152	152	-	81.7	(0.0)	-	24	515 (53)
150	143	143	-	78.7	-	-	22	490 (50)
140	133	133	-	75.0	-	-	21	455 (46)
130	124	124	-	71.2	-	-	20	425 (44)
120	114	114	-	66.7	-	-	-	390 (40)
110	105	105	-	62.3	-	-	-	-
100	95	95	-	56.2	-	-	-	-
95	90	90	-	52.0	-	-	-	-
90	86	86	-	48.0	-	-	-	-
85	81	81	-	41.0	-	-	-	-

ここに示す硬さ換算表は、鋼のビッカース硬さに対する近似換算値を示したものである。
The hardness conversion table shown here shows approximate conversion values for the Vickers hardness of steel.

商品コード索引

Item Code Index



商品コード索引

[A - B]

商品コード Item code	掲載頁 Page	商品名称 Product
A		
A45D-4000R/L	C224	アルファ45フェースミル A45D
A45E-0000R/L	C222	アルファ45フェースミル A45E
ABP4FOOS00L000	C136	アルファボールプレジジョンマルチフルートABP4F 鋼シャンク
ABP4FOOS00WL000	C136	アルファボールプレジジョンマルチフルートABP4F 超硬シャンク
ABPF00MT0	C126	アルファボールプレジジョンF ABPF 鋼-MTシャンク
ABPF00S00(L/L000)	C126	アルファボールプレジジョンF ABPF 鋼シャンク
ABPF00S00W(□□000)	C127	アルファボールプレジジョンF ABPF 超硬シャンク
ABPFM00(-M00H)	C128	アルファモジュラーミル ABPFM
ABPFN00S00-000-000	C134	アルファボールプレジジョンF ABPFN
ABPFU00W000	C128	アルファボールプレジジョンF ABPF 超硬シャンク/アンダーネック
ACMT	C169	ASJ用インサート
	C248	フライス切削用インサート
ADET	C159,C247	UEX用インサート
ADEW	C159,C248	UEX用インサート
ADLX	C252	フライス切削用インサート
ADMT	C169	ASJ用インサート
	C248	フライス切削用インサート
ADNT	C159,C248	UEX用インサート
AES2000	A386	超硬アルミ用エンドミル
AFE45-4000R-00	C220	アルファ正面フライス AFE45
AHJ(L)00R	C160	アルファ快削じゅうおうAHJ 標準刃長形
AHJ(L)00RS	C161	アルファ快削じゅうおうAHJ 短刃長形
AHJM00RS	C162	アルファモジュラーミル AHJM
AHR□000042R/MT5-M00	C66	アルファヘビーラジiasmil AHR シャンクタイプ
AHR5000R(M)-0	C67	アルファヘビーラジiasmil AHR ポアタイプ
AHU(L)1000R-0	C146	アルファ超快削エンドミルAHU シャンクタイプ
AHUB15000R(M)-0	C147	アルファ超快削エンドミルAHU ポアタイプ
AHUM1000R-0(-M00)	C147	アルファモジュラーミル AHUM
AJU(L)00X00	C232	アルファエンドミルじゅうおう AJU
1AL00	H37	アルミ用エンドミル 1枚刃
2AL00	H37	アルミ用エンドミル 2枚刃
ALB00.0R	H68	アルミ用ボールエンドミル
AME0000S000-000-0NT	C180	アルファラフィングエンドミルAME シャンクタイプ
AMEB0000R(M)-00-0NT	C180	アルファラフィングエンドミルAME ポアタイプ
APET	C159	UEX用インサート
	C247	フライス切削用インサート
APEW	C159,C247	UEX用インサート
APHW	C175,C248	ASV用インサート
APLT	C252	フライス切削用インサート
APLX	C252	フライス切削用インサート
APMT	C169	ASJ用インサート
	C175	ASV用インサート
	C181	AME用インサート
	C248	フライス切削用インサート
APNT	C159,C247	UEX用インサート
AR□0000R(00)	C73	快削形アルファラジiasmil(シャンク)AR
AR5000R	C74	快削形アルファラジiasmil(ポア)AR 先端径タイプ
ARB0000R-0(M)	C74	快削形アルファラジiasmil(ポア)ARB 最外径タイプ
ARM0000R-0	C72	アルファモジュラーミル ARM
ARPF00S00(□000/□□00)	C93	アルファラジiasmilプレジジョン ARPF
ARPFM00(-H)	C92	アルファモジュラーミル ARPFM
AS00-00.0-000-00	D7	アルファモジュラーミル用鋼シャンク

商品コード Item code	掲載頁 Page	商品名称 Product
AS02-00.00-20	C226	アルファ90フェースミル用ストレートアーバ
ASB0000□000□(-LH)	C120	アルファスーパーボールエンドミルシャンクタイプ(重切削用ASB)
ASB0000□T00□(-M00)	C121	アルファスーパーボールエンドミルMT-BTタイプ(重切削用ASB)
ASC00-00.0-000-000□	D6	アルファモジュラーミル用超硬シャンク
ASDF5000R(M)-0(U)	C210	アルファデュアルフェイスミルASDF 高送りタイプ
ASDH5000R(M)-00	C212	アルファデュアルフェイスミルASDH 高切込みタイプ
ASF5000R(-0)	C216	アルファ高送り正面フライスASF 内径インチサイズ
ASF5000RM(-0)	C216	アルファ高送り正面フライスASF 内径ミリサイズ
ASJ(L/E)00R	C168	アルファスーパーじゅうおうASJ
ASM□0700S00R-0	C140	アルファスーパーエクセレントミニ ASM
ASMM0700R-0	C141	アルファモジュラーミル ASMM
ASPV1000R-0	C184	アルファポリッシュミルタイプASPVmini スチールシャンクタイプ
ASPB2000R(M)-0	C193	アルファポリッシュミルVタイプ ポアタイプ
ASPV1000R-0-M	C185	アルファモジュラーミルASPVmini
ASPV2000R-0	C192	アルファモジュラーミル ASPVM
ASPV2000R-0-Z	C206	ザグリ加工用ASPV-Z
ASPV2000R-0	C192	アルファポリッシュミルVタイプASPV ストレートシャンク
ASR□0000(-42)	C32	アルファ高送りラジiasmilASR シャンクタイプ
ASR□2000(□00)R-0	C54	アルファ高送りラジiasmilASR多刃タイプ シャンクタイプ
ASR0000(M)-0	C33	アルファ高送りラジiasmilASR ポアタイプ
ASR0000R(M)-0	C55	アルファ高送りラジiasmilASR多刃タイプ ポアタイプ
ASRF□3000R-0	C50	アルファ高送りラジiasmil4コーナASRFmini シャンクタイプ
ASRF□4000R	C44	アルファ高送りラジiasmil4コーナASRF シャンクタイプ
ASRF4000R(M)-0	C45	アルファ高送りラジiasmil4コーナASRF ポアタイプ
ASRFB00R(M)-0-(00)	C50	アルファ高送りラジiasmil4コーナASRFmini ポアタイプ
ASRFM3000R-0-M10	C51	アルファモジュラーミルASRFmini
ASRM0000-0	C34	アルファモジュラーミルASRM
ASRM2000R-0	C55	アルファモジュラーミルASRM 多刃タイプ
ASRT□0000R-0	C38	アルファ高送りラジiasmil3コーナASRT シャンクタイプ
ASRT0000R(M)-0	C38	アルファ高送りラジiasmil3コーナASRT ポアタイプ
ASRTM3000R-0	C39	アルファモジュラーミル ASRTM
ASV(L/E)00R	C174	アルファスーパーバーチカルミルASV シャンクタイプ
ASV0000R	C174	アルファスーパーバーチカルミルASV ポアタイプ
B		
BCF0000S00E	C111	アルファボールエンドミルBCF ロングシャンク形
BCF0000S00L	C110	アルファボールエンドミルBCF ロング刃形
BCF0000S00S	C110	アルファボールエンドミルBCF レギュラー形
BCF0000S00ST000	C112	アルファボールエンドミルBCF ストレートネックロングシャンク形
BCF0000S00TE	C111	アルファボールエンドミルBCF テーパーネックロングシャンク形
BCF00MT0	C112	アルファボールエンドミルBCF モールステーパー(シャンク形)
BCFM00	C113	アルファモジュラーミルBCFM
BCU5063□000□	C124	アルファボールエンドミル(重切削用BCU)
BCU5063□T00□	C124	アルファボールエンドミル(重切削用BCU)
BEK2000	A161	超硬強力形ボールエンドミル ショート刃長
BEK2000-C	A415	超硬Cコート強力形ボールエンドミル ショート刃長

[B - D]

商品コード Item code	掲載頁 Page	商品名称 Product
BEKLS2000-C	A415	超硬Cコート強力形ボールエンドミル ロングシャンク
BES2000	A421	超硬ボールエンドミル
BES2000-C	A415	超硬Cコートボールエンドミル
BES2000M	A421	超硬プラ型用ボールエンドミル
BESL2000-C	A418	超硬Cコート深彫り用ボールエンドミル テーパーネック
BESL2000-S-C	A418	超硬Cコート深彫り用ボールエンドミル ストレートネック
BESS2000	A421	超硬ミニチュアボールエンドミル
BHB2000	A456	CBN小径エンドミル ボール刃
BHS2000	A456	CBN小径エンドミル スクエア刃
BHSR2000-0.0	A456	CBN小径エンドミル コーナR付き
BR2P0000000-000-000-000	C100	アルファボールエンドミルBR2P シャンクタイプ
BR2P0000MT5-000-M00	C101	アルファボールエンドミルBR2P MTシャンクタイプ
BR2PM00-M00	C100	アルファモジュラーミルBR2PM
BT30-00.0-00-00.0	D8	アルファモジュラーミル用BT30アーバ
BT40-00.0-000-00.0	D9	アルファモジュラーミル用BT40アーバ
BT50-00.000-000-000	D11	ボアタイプ用アーバ
BT50-000-00	D13	BT50アーバ
BT50-MTB003-000-00	C116	アーバ
BT50-MTB503-70-65	C68,C122 C125	MTシャンク専用アーバ

C

CB6-143	D20	クランプ駒セット
CB6-145	D20	クランプ駒セット
CB6-147	D20	クランプ駒セット
CB8-161	D20	クランプ駒セット
CBN-EHB2000-00.00	A147	エポックCBNハイプレジションボールエンドミル
CBN-EPSB2000-00.0-000-F	A151	エポックCBNスーパーボールエンドミル F刃型
CBN-EPSB2000-00.0-000-S	A151	エポックCBNスーパーボールエンドミル S刃型
CBN-EPSR2000-00.0-000	A281	エポックCBNスーパーラジアスエンドミル
CCMT	C233,251 C252	フライス切削用インサート
CCMT	G12	旋削用インサート
CE00	H66	面取りカッタ
CEPB2000	A411	エポックボールエンドミル 2枚刃・レギュラー刃長
CEPB4000	A411	エポックボールエンドミル 4枚刃・レギュラー刃長
CEPBL2000	A411	エポックボールエンドミル 2枚刃・ロングシャンク
CEPH0000	A356	エポックハード
CEPL0000	A355	エポック21 ロング刃長
CEPL0000-TH	A352	エポックTHハード ロング刃長
CEPLS0000(-00)	A356	エポック21 ロングシャンク
CEPR0000	A355	エポック21 レギュラー刃長
CEPR0000-00	A267	エポック21 コーナR付き
CEPR0000-TH	A352	エポックTHハード レギュラー刃長
CEPR6000-00-TH	A265	エポックTHハード コーナR付き
CEPS0000-TH	A352	エポックTHハード ショート刃長

商品コード Item code	掲載頁 Page	商品名称 Product
CEPU4000	A356	エポックユニバーサル
CM00	H66	センタ面取りミル
CM3.5-141	D20	クランプ駒セット
CM4-141	D20	クランプ駒セット
CM5-141	D20	クランプ駒セット
CM5-147	D20	クランプ駒セット
CM5-148	D20	クランプ駒セット
CM6-147	D20	クランプ駒セット
CNMA	G12	旋削用インサート
CNMG	G10	旋削用インサート
CNMM	G11	旋削用インサート
CPC(L)00-00	C228	アルファ面取りカッタ CPC形
CPMT	C102	BR2P用インサート
	C114	BCF用インサート
	C122	ASB用インサート
	C125	BCU用インサート
	C233	AJU用インサート
	C243,C244 C251,C253	フライス切削用インサート
CPMT	G12	旋削用インサート

D

D00-00.000-000-AV	D12	AVユニット
DCMT	G14	旋削用インサート
DEB2000-00-C	A448	超硬Cコート"リブカットボール"
DES2000-00.0-C	A452	超硬Cコート"リブカット"
DN2HC0000-ATH	F15	高硬度鋼加工用面取り工具
DNMA	G14	旋削用インサート
DNMG	G12	旋削用インサート
DSH00x000	H75	高リード刃形ダイナミル
DSP000x000	H80	一般刃形ダイナミル
DSQ00x000	H74	ラフィング刃形ダイナミル

E

EAP4000-00-TH	A269	エポックエアロパワーミル 4枚刃 コーナR付き
EAP4000-TH	A371	エポックエアロパワーミル 4枚刃 スクエア
EAP6000-00-TH	A269	エポックエアロパワーミル 6枚刃 コーナR付き
EAP6000-TH	A371	エポックエアロパワーミル 6枚刃 スクエア
EB4HR0000TN-00-00-ATH	A132	エポックリブ溝加工用テーパボールエンドミル
ECKA	C253	フライス切削用インサート
ECH0000-SD	A381	エポックCFRPエンドミル タイプH
ECN00000-HD	A382	エポックCFRPトリムカッタ タイプN

商品コード索引

[E]

商品コード Item code	掲載頁 Page	商品名称 Product
ECRB0000-00-PN	A137	エポックコンビネーションリブボール
ECW00000-HD	A382	エポックCFRPトリムカッター タイプW
ECX0000-SD	A381	エポックCFRPエンドミル タイプX
EDEW	C35, C238	ASR用インサート
EDMT	C35	ASR用インサート
	C56	ASR多刃タイプ用インサート
	C141	ASM用インサート
	C238 C239	フライス切削用インサート
	C246	
EDNW	C35	ASR用インサート
	C56	ASR多刃タイプ用インサート
	C238, C239	フライス切削用インサート
EDT-(N)PT00-00-ATH	F10	エポックDスレッドミル PT・NPTねじ用
EDT-(U)00.00-00.0-TH	F6	エポックDスレッドミル
EFB2000	A153	エポックファインボール 磨きレス
EGB2000-HD	A145	エポックHDコーティングボールエンドミル
EGDB2000-00-HD	A143	エポックHDコーティングディープボールエンドミル
EGDR2000-00-00-HD	A277	エポックHDコーティングディープラジアスエンドミル
EGR2000-05-HD	A279	エポックHDコーティングラジアスエンドミル
EHHB4000(SO)-ATH	A127	エポックハイハードボール
EHHBE4000(SO)-TH3	A124	エポックハイハードボール-TH3
EHHRE0000(SO)-TH3	A263	エポックハイハードラジアス
EHSE00.0-TH	E80	エポックTHハードドリル
EHT0-M00-0.00-TH	F3	エポックハードタップ
EHX00H-ETM4000-00-TH	A398	EHXエンドミル (ETMタイプ) オイルホール付き
EHX00-00-000-00-ASC	A400	EHXエンドミル用超硬ホルダ
EHX00-CEPR6000-TH	A398	EHXエンドミル (CEPRタイプ)
EHX00-EPP4000-00-TH	A399	EHXエンドミル (EPPタイプ)
EHX00-ETM4000-00-TH	A398	EHXエンドミル (ETMタイプ)
EHX00-SN	A400	EHXエンドミル用スパナ
EMB3000-TH	A168	エポックメガフィードボール 首下ストレート
EMBE3000(SO)-ATH	A110	エポックメガフィードボールエポリユーション ストレートタイプ
EMBP3000-00-10-TH	A170	エポックメガフィードボール ベンシルネックタイプ
EMBE3000-000-00-ATH	A111	エポックメガフィードボールエポリユーション ベンシルネック
EMM20000	A384	エポックマイクロエンドミル
EMM2000-TH	A384	エポックマイクロエンドミルTH
EMSBH0000-00-ATH	E74	エポックマイクロステップポラーH
EMSBS0000-00-□□	E70	エポックマイクロステップポラーS 受注生産品
EMSBS0000-00.0-(TH/SD)	E68	エポックマイクロステップポラーS 標準在庫品
EMST0000-TH	E72	エポックマイクロスターター
EMXA2000-000-0-□□	A273	エポックミルス タイプA(アルミ用)2枚刃ラジアス 受注生産
EMXA2000-000-□□	A375	エポックミルス タイプA(アルミ用)2枚刃スクエア 受注生産
EMXA3000-00-□□	A375	エポックミルス タイプA(アルミ用)3枚刃スクエア 受注生産
EMXA3000-00-00-□□	A273	エポックミルス タイプA(アルミ用)3枚刃ラジアス 受注生産
EMXA2000-000-00	A272	エポックミルス タイプA(アルミ用)2枚刃ラジアス メーカー在庫
EMXA3000-00	A374	エポックミルス タイプA(アルミ用)3枚刃スクエア メーカー在庫
EMXA3000-00-00	A272	エポックミルス タイプA(アルミ用)3枚刃ラジアス メーカー在庫
EMXN4000-00-00-TH	A260	エポックミルス タイプN ラジアスストレート・3DC
EMXN4000-00-00-TH	A260	エポックミルス タイプN ラジアスストレート・5DC
EMXN4000-SR-TH	A347	エポックミルス タイプN スクエア・セミロングシャンク
EMXN4000-TH	A347	エポックミルス タイプN スクエアストレート
EMXR4000-00-00-TH	A259	エポックミルス タイプR ラジアスストレート・3DC
EMXR4000-00-00-TH	A259	エポックミルス タイプR ラジアスストレート・5DC
EMXR4000-SR-TH	A346	エポックミルス タイプR スクエア・セミロングシャンク

商品コード Item code	掲載頁 Page	商品名称 Product
EMXR4000-TH	A346	エポックミルス タイプR スクエアストレート
ENGU	C29, C238	TD4N用インサート
ENMU	C29, C238	TD4N用インサート
EP(L)0000	C230	先交換式エンドミル EP
EPAB2000-SD	A142	エポックSD(S-DLC)ボール
EPAS2000-SD	A380	エポックSD(S-DLC)スクエア
EPBC2000(-0)	A409	エポックCSパワーボール
EPBP2000-00	A158	エポックベンシルネックボール レギュラーネック
EPBPX2000-00	A160	エポックベンシルロングネックボール
EPBT2000(-0)	A102	エポックTHハードボール
EPBS2000-TH	A100	エポックTHハードボール スترونク
EPCDS0000	A383	エポックシャイニングスクエア
EPDB2000-00	A405	エポックディープボール CSコート
EPDB2000-00-SD	A140	エポックSD(S-DLC)ディープボール
EPDB2000-00-TH	A405	エポックディープボール THコート
EPDBE2000-00.00-ATH	A72	エポックディープボールエポリユーション ATHコート
EPDBE2000-00.00-PN	A75	エポックディープボールエポリユーション PNコート
EPDBEH2000-0.00-ATH	E78	エポックディープボールエポリユーションハード
EPDBEH2000-00.00-(S6)-TH3	A58	エポックディープボールエポリユーションハード-TH3
EPDBEH2000F-00.00-TH3	A56	エポックディープボールエポリユーションハード-TH3 ショートシャンク
EPDBP2000-00-00-TH	A162	エポックベンシルディープボール
EPDBPE2000-000.0-00-ATH	A84	エポックベンシルディープボールエポリユーション
EPDR2000-00.0-000-TH	A283	エポックディープラジアス
EPDRE2000-00.0-000-ATH	A194	エポックディープラジアスエポリユーション
EPDREH2000-0.0-000-TH3	A172	エポックディープラジアスエポリユーションハード-TH3 2枚刃
EPDRH4000-0.0-000-TH3	A174	エポックディープラジアスエポリユーションハード-TH3 4枚刃
EPDRF4000-00-000-TH	A216	エポックディープラジアスF
EPDRP2000-00-00000-TH	A210	エポックベンシルディープラジアス
EPDS2000-00	A430	エポックディープスクエア CSコート
EPDS2000-00-SD	A378	エポックSD(S-DLC)ディープスクエア
EPDS2000-00-TH	A430	エポックディープスクエア THコート
EPDSE2000-00.0-ATH	A292	エポックディープスクエアエポリユーション ATHコート
EPDSE2000-00.0-PN	A295	エポックディープスクエアエポリユーション PNコート
EPHB6000-PN	A130	高効率仕上げ用6枚刃ボールエンドミル
EPHW	C65, C239	RH2P用インサート
EPJS2000-00-J	A427	エポックじゅうおう-J レギュラー刃長・コーナー付き
EPJLS2000-00-J	A427	エポックじゅうおう-J ロングシャンク・コーナー付き
EPMT	C56, C239	ASR多刃タイプ用インサート
EPNW	C35	ASR用インサート
	C56	ASR用多刃タイプ用インサート
	C238, C239	フライス切削用インサート
EPP3000-CS	A308	エポックCSパワーミル 3枚刃 レギュラー刃長
EPP4000	A337	エポックパワーミル レギュラー刃長
EPP4000-00	A249	エポックパワーミル レギュラー刃長・コーナー付き
EPP4000-00-TH	A247	エポックTHパワーミル コーナR付き
EPP4000-CS	A332	エポックCSパワーミル レギュラー刃長
EPP4000-P-CS	A332	エポックCSパワーミル ピンカド・レギュラー刃長
EPP4000-TH	A328	エポックTHパワーミル レギュラー刃長
EPPL4000	A338	エポックパワーミル ロング刃長
EPPL4000-00	A249	エポックパワーミル ロング刃長・コーナー付き
EPPL4000-TH	A328	エポックTHパワーミル ロング刃長
EPPLS4000	A338	エポックパワーミル ロングシャンク
EPPLS4000-00	A250	エポックパワーミル ロングシャンク・コーナー付き
EPPM4000	A338	エポックパワーミル ミディアム刃長

[E - G]

商品コード Item code	掲載頁 Page	商品名称 Product
EPPM4000-TH	A328	エポックTHパワーミル ミディアム刃長
EPPS4000	A336	エポックパワーミル ショート刃長
EPPS4000-P-CS	A332	エポックCSパワーミル ピンカド・ショート刃長
EPPS4000-TH	A328	エポックTHパワーミル ショート刃長
EPQL4000-CS	A369	エポックラフィング ロング刃長
EPQLS4000-CS	A455	エポックラフィング ロングシャンク
EPQM4000-CS	A455	エポックラフィング ミディアム刃長
EPQR4000-CS	A369	エポックラフィング レギュラー刃長
EPQS4000-CS	A455	エポックラフィング ショート刃長
EPR3000-00	A429	エポックハイフィードラジラス ストレートネック
EPRB0000-00-C	A446	エポックリブボール
EPRI0000-00-C	A450	エポックリブ
EPRPN3000-00-00	A429	エポックハイフィードラジラス ベンシルネック
EPSB2000-0.0-N-TH	A155	エポックスーパーハードボール (標準規格品) 首下3DC
EPSB2000-H-TH	A154	エポックスーパーハードボール (高精度規格品)
EPSB2000-N-TH	A154	エポックスーパーハードボール (標準規格品)
EPSBE2000-0.00-H-TH	A98	エポックスーパーハードボールエボリューション (高精度規格品)
EPSBE2000-00.00-TH	A97	エポックスーパーハードボールエボリューション (標準規格品)
EPSF0000-PN	A310	エポックSUSフィニッシュ レギュラー刃長
EPSFL0000-PN	A310	エポックSUSフィニッシュ ロング刃長
EPSFM0000-PN	A310	エポックSUSフィニッシュ ミディアム刃長
EPSM4000-00.0-PN	A317	エポックSUSマルチ 首下3Dc
EPSM4000-000-R0.0-PN	A238	エポックSUSマルチ 首下5Dc・ラジラストाइプ
EPSM4000-000.0-PN	A318	エポックSUSマルチ 首下5Dc
EPSM4000-R0.0-PN	A235	エポックSUSマルチ レギュラー刃長・ラジラストाइプ
EPSM40000-PN	A313	エポックSUSマルチ レギュラー刃長
EPSML4000-PN	A315	エポックSUSマルチ ロング刃長
EPSML4000-R0.0-PN	A237	エポックSUSマルチ ロング刃長・ラジラストाइプ
EPSMLS4000-PN	A316	エポックSUSマルチ ロングシャンク
EPSMM4000-PN	A315	エポックSUSマルチ ミディアム刃
EPSMS4000-PN	A311	エポックSUSマルチ ショート刃長
EPSW0000-00-PN	A363	エポックSUSウェーブ 首下3DC
EPSW0000-000-PN	A363	エポックSUSウェーブ 首下5DC
EPSW0000-PN	A361	エポックSUSウェーブ レギュラー刃長
EPSWL4000-PN	A362	エポックSUSウェーブ ロング刃長
ER5HS00(-00)-PN	A257	高能率側面切削用エンドミル
ER8WB0000LN(LS)-00-R0.0-ATH	A254	立壁/底面仕上げ用8枚刃エンドミル ラジラス
ESHB2000-H-TH	A108	エポックシュリンクマスターボール (高精度規格品)
ESHB2000-N-TH	A108	エポックシュリンクマスターボール (標準規格品)
ESHTC-M00-0.00-TH	F2	エポックスーパーハードタツブ
2ESMB00.0R	H18	ESMボールエンドミル 2枚刃
4ESMB00.0R	H68	ESMボールエンドミル 4枚刃
2ESMBC00.0R	H18	ESM-Cコートボールエンドミル
ESMDB00.0R	H68	ESM深彫り用ボールエンドミル
ESMHKL00(x32)	H48	ESM-Cコートパワーヘリカル ロング刃長
ESMHKM00(x32)	H48	ESM-Cコートパワーヘリカル ミディアム刃長
ESMHKR00(x32)	H48	ESM-Cコートパワーヘリカル レギュラー刃長
ESMHN00	H50	ESMハイヘリカルエンドミル
ESMKH00	H75	ESMキー溝用エンドミル プラス公差
ESMKN00	H75	ESMキー溝用エンドミル マイナス公差
ESMKNN00	H75	ESMキー溝用エンドミル マイナス公差
2ESML00	H28	ESMエンドミル 2枚刃 ロング刃長
4ESML00	H42	ESMエンドミル 4枚刃 ロング刃長
ESMLB0.0R	H68	ESMロングリーチボールエンドミル

商品コード Item code	掲載頁 Page	商品名称 Product
2ESMLC00	H23	ESM-Cコートエンドミル 2枚刃 ロング刃長
4ESMLC00	H41	ESM-Cコートエンドミル 4枚刃 ロング刃長
ESMQL00	H56	ESM-Cコートラフィングエンドミル ロング刃長
ESMQLS00	H56	ESM-Cコートラフィングエンドミル ロングシャンク
ESMQR00	H55	ESM-Cコートラフィングエンドミル レギュラー刃長
ESMQS00	H55	ESM-Cコートラフィングエンドミル ショート刃長
2ESMR00.0	H27	ESMエンドミル 2枚刃 レギュラー刃長
4ESMR00.0	H42	ESMエンドミル 4枚刃 レギュラー刃長
2ESMRC00.0	H23	ESM-Cコートエンドミル 2枚刃 レギュラー刃長
4ESMRC00.0	H41	ESM-Cコートエンドミル 4枚刃 レギュラー刃長
2ESMS00.0	H26	ESMエンドミル ショート刃長
2ESMSC00.0	H23	ESM-Cコートエンドミル ショート刃長
2ESMSUS00.0	H28	ESMステンレス用エンドミル
2ESMSUSC00	H25	ESM-Cコートステンレス用エンドミル
2ESMTBROORx00.0	H80	ESMテーパボールエンドミル レギュラー刃長
2ESMTBS0.0ORx00.0	H79	ESMテーパボールエンドミル ショート刃長
2ESMTR00.0x0.0	H78	ESMテーパエンドミル 2枚刃・レギュラー刃長
4ESMTR00x0.0	H78	ESMテーパエンドミル 4枚刃・レギュラー刃長
2ESMTS00.0x0.0	H76	ESMテーパエンドミル 2枚刃・ショート刃長
4ESMTS00.0x0.0	H77	ESMテーパエンドミル 4枚刃・ショート刃長
2ESMTT0.0x0.0	H76	ESMテーパエンドミル スタブ刃長
ET-(U)00.00-00.0-PN	F4	エポックスレッドミル
ETM4000-00-TH	A226	エポックターボミル 首下ストレート・コーナR付き
ETMLN4000-000-00-TH	A226	エポックターボミル ロングネック・コーナR付き
ETMP4000-000-00-TH	A227	エポックターボミル ベンシルネック・コーナR付き
ETR40000-00-00-TH	A222	エポックターボリブ ストレートネック
ETRP40000-00-0000-TH	A223	エポックターボリブ ベンシルネック
EWSR00.0	E91	エポックワンダードリル レギュラー形
EWSS00.0	E90	エポックワンダードリル スタブ形
ES8WB0000LN(LS)-00-ATH	A344	立壁/底面仕上げ用8枚刃エンドミル スクエア
F		
FE400-0(0°)	A445	超硬型彫用エンドミル テーパーボール刃
FE600	A425	超硬型彫用ボールエンドミル
FE700	A440	超硬型彫用エンドミル スクエア刃
FQL00-AT	H72	ATファインミル ロング刃長
FQR00-AT	H58	ATファインミル レギュラー刃長
FQS00-AT	H58	ATファインミル ショート刃長
03FWHNSB0000-TH	E38	鋳鉄用超硬OHノンステップボーラー(3D)
05FWHNSB0000-TH	E39	鋳鉄用超硬OHノンステップボーラー(5D)
10FWHNSB0000-TH	E40	鋳鉄用超硬OHノンステップボーラー(10D)
15FWHNSB0000-TH	E41	鋳鉄用超硬OHノンステップボーラー(15D)
20FWHNSB0000-TH	E42	鋳鉄用超硬OHノンステップボーラー(20D)
30FWHNSB0000-TH	E43	鋳鉄用超硬OHノンステップボーラー(30D)



切削工具製品ご使用上の安全について

1. 切削工具製品のご使用にあたって

平成7年7月1日に施行されました製造物責任法(PL法)により、弊社では対象製品に関し商品の包装材に警告ラベル、又は注意ラベルの貼付を実施致しております。

但し、工具本体には、具体的な注意事項等の表示はなされておりません。すべての切削工具製品及び切削工具材料の取扱い並びにご使用の前に、必ず本カタログの「切削工具製品ご使用上の安全について」及び「切削工具の使用上の注意事項」をご一読下さい。又御社の安全教育の一環として、記載内容を作業員全員に周知徹底下さる様お願い申し上げます。

2. 切削工具材料の基本的性質

●本カタログで用いる用語の意味

切削工具材料:超硬合金、サーメット、セラミック、CBN焼結体、ダイヤモンド焼結体、ハイス、合金鋼などの工具材料の総称。

●物理的特性

外 観: 材質及び材種により異なる。(例) 灰色、黒色、金色等

臭 気: 無臭

硬 度: 超硬合金、サーメット5~30GPaHV、セラミック10~40GPaHV、CBN焼結体20~50GPaHV、
ダイヤモンド焼結体80~120GPaHV、ハイス2~12GPaHV、合金鋼2~12GPaHV

比 重: 超硬合金9~16、サーメット5~9、セラミック2~7、CBN焼結体3~5、ダイヤモンド焼結体3~5
ハイス7~9、合金鋼7~9

●成分

W、Ti、Al、Si、Ta、Nb、B、V等の炭化物、窒化物、炭窒化物、酸化物およびこれらに加えて、Fe、Co、Ni、Cr、Moなどの金属成分を含むものがあります。

3. 切削工具材料の取扱い注意事項

◇切削工具材料は、非常に硬い反面脆い材料としての特性を持ちます。したがって、衝撃や無理な締め付けなどで破損することがあります。

◇超硬工具材料は、比重が大きいため大型製品や、数量が多い場合は重量物として取扱いに注意して下さい。

◇超硬工具材料は、金属材料に比べて熱膨張率が異なります。このため、焼きばめ/冷やしばめされた製品は、使用温度が設計値と異なり著しく高い(低い)場合、割れが発生することがあります。

◇切削工具材料は、研削液や潤滑液、その他の水分等で腐食すると強度低下を招きますので保管状態に注意して下さい。

4. 切削工具製品(材料)を加工する際の注意事項

◇超硬工具材料は、表面状態により強度が著しく低下することがあります。仕上げには、必ずダイヤモンド砥石を使用して下さい。

◇切削工具製品は、研削加工や加熱すると、粉じんやミスト(煙霧)が発生します。多量に吸引したり、飲み込んだり、目や皮膚と接触したりすると人体に有害な場合があります。研削加工する場合は、粉じんやミストが人体に暴露しないように注意し、局所排気装置や保護マスク、保護めがね、保護手袋などの使用を推奨します。また、粉じんなどが手に付着した場合は、水と洗剤で良く洗って下さい。

作業場所での飲食はしないようにし、飲食の前には手を洗って下さい。

着衣に付着した粉じんは、振り払わずに、掃除機などで除去するかまたは洗濯して下さい。

切削工具材料に含まれるコバルトは、反復又は長期の接触により、皮膚、呼吸器官、心臓などに影響を与える可能性があることが報告されています。

詳細な情報は、弊社が発行するSDSを参照して下さい。

SDS = Safety Data Sheet(安全データシート)

Homepage: www.moldino.com/products/sds/

◇超硬工具材料またはろう付け品を湿式研削した場合、研削液中に重金属が含まれますので廃液処理は確実に行って下さい。

◇切削工具製品を再研削した場合には、再研削後に亀裂のない事を確認して下さい。

◇超硬工具材料あるいは製品にレーザー、電気ペン等でマーキングすると亀裂が入ることがあります。応力の加わる部分へのマーキングは行わないようにして下さい。



About safety when using cutting tool products

1. When using cutting tool products

In accordance with the Product Liability Law (PL law) enforced on July 1, 1995, our company has attached warning labels and caution labels to the packaging of our applicable products.

However, there are no specific caution notes, etc. displayed on the tools themselves. Before handling or using any cutting tool or cutting tool material, please read the sections "About safety when using cutting tool products" and "Cautions regarding the use of cutting tools" in this catalog. In addition, please teach the information stated in these sections to all workers as part of the safety education at your company.

2. Basic characteristics of cutting tool materials

Meanings of words used in this catalog

Cutting tool materials: General terms such as carbide alloy, cermet, ceramics, sintered CBN, sintered diamond, HSS, alloy steel, etc.

Physical characteristics

Appearance: Varies depending on material properties and material type. Example: Gray, black, gold, etc.

Odor : Odorless

Hardness : Carbide alloy, cermet: 5 to 30GPaHV; Ceramic: 10 to 40GPaHV; Sintered CBN: 20 to 50GPaHV; Sintered diamond: 80 to 120GPaHV; HSS: 2 to 12GPaHV; Alloy steel: 2 to 12GPaHV

Specific gravity: Carbide alloy: 9 to 16; Cermet: 5 to 9; Ceramic: 2 to 7; Sintered CBN: 3 to 5; Sintered diamond: 3 to 5; HSS: 7 to 9; Alloy steel: 7 to 9

Composition

Including carbides, nitrides, and sulfides of W, Ti, Al, Si, Ta, Nb, B, V, etc. as well as metal components of Fe, Co, Ni, Cr, Mo, etc.

3. Cautions regarding the handling of cutting tool materials

- ◇ Cutting tool materials have the characteristics of being extremely hard yet brittle. Therefore, they may be broken by impact or by overtightening.
- ◇ Since carbide tool materials have high specific gravities, be careful to handle large products or large quantities as heavy materials.
- ◇ The thermal expansion of carbide tool materials is different from that of metal materials. Because of this, for shrink-fit or cooling-fit products, if the usage temperature is slightly higher (lower) than the specified temperature, cracking may occur.
- ◇ If cutting tool materials become corroded due to cutting fluid, lubricating agents, or other moisture, their strength will be reduced. Care should be taken regarding storage conditions.

4. Cautions regarding machining of cutting tool products (materials)

- ◇ For carbide tool materials, the strength may be slightly reduced due to the surface conditions. For finishing, always use a diamond grinder.
- ◇ When cutting tool materials are ground or heated, dust or mist (smoke) occurs. If a lot of it is inhaled, swallowed, or comes in contact with the eyes or skin, it could result in injury to the body. When machining, be careful to avoid exposing your body to the dust or mist; it is recommended that localized ventilation equipment be used and that a protective mask, protective goggles, and protective gloves be worn. In addition, if the dust, etc. comes in contact with your hands, wash them thoroughly with soap and water.
Do not drink or eat in the work area, and wash your hands before drinking or eating.
Dust on clothes should not be shaken out; use a vacuum, etc. to remove the dust or wash the clothes in a washing machine.
If the cobalt contained in the cutting tool material is touched repeatedly or over a long period of time, it has been reported that it may affect the skin, respiratory organs, or heart, etc.
- ◇ When performing wet machining of carbide tool materials or brazed tool, the cutting fluid may contain heavy metals and must be disposed of properly.
- ◇ When a cutting tool product has been reground, check that there are no cracks after regrinding.
- ◇ If a laser or electric pen, etc. is used to mark carbide tool material or products, cracks may form.
Do not mark sections which may be subject to stress.



切削工具の使用上の注意事項

対象製品	危険性	対策
切削工具全般	◎鋭い切れ刃を持っているため直接手を触れるとけがをする危険があります。	※特にケースからの取り出し時や機械への装着時には保護手袋等の保護具を使用してください。
	◎使用方法を誤ったり使用条件が不適切な場合、工具の破損や飛散を招き、けがをする危険があります。	※安全カバーや保護めがね等の保護具を使用してください。 ※推奨条件の範囲でご使用ください。取扱い説明書、カタログなどをご参照ください。
	◎衝撃的負荷や過度の摩耗による切削抵抗の急激な増加により工具が破損、飛散し、けがをする危険があります。	※安全カバーや保護めがね等の保護具を使用してください。 ※工具交換を早めに行ってください。
	◎高温の切りくずが飛散したり長く伸びた切りくずが排出され、けがや火傷の危険があります。	※安全カバーや保護めがね等の保護具を使用してください。 ※切りくず除去の際には、機械を停止させ保護手袋を着用しニップ、クリップ等の工具を使用してください。
	◎工具や被削材は切削時高温になります。加工直後に直接手を触れると火傷の危険があります。	※保護手袋等の保護具を使用してください。
	◎切削中に発生する火花や破損による発熱、切りくずで引火、火災の危険があります。	※引火や爆発の危険のあるところでは使用しないでください。 ※不水溶性切削油を使用する場合は、防火対策を必ず行ってください。
	◎高速回転で使用する際には、工作機械保持具を含めたバランスが悪いと振れ、振動により工具が破損しけがをする危険があります。	※安全カバーや保護めがね等の保護具を使用してください。 ※試運転を必ず実施し振れ、振動、異常音がないことを確認してください。
	◎加工物に生じたバリに直接手を触れるとけがをする危険があります。	※素手で触らないでください。
◎このカタログに記載の標準切削条件表は切削条件の目安を示すものです。実際の加工では加工形状、目的、使用機械により条件を調整してください。		
刃先交換式工具全般	◎インサートや部品が確実にクランプされていないと切削中に脱落、飛散しけがをする危険があります。	※取付座面や固定用部品には異物などの付着物がないように清掃してからインサートを取付けてください。 ※取付けは付属のスパナを用いてインサートや部品が確実にクランプされていることを確認してください。 また、所定のインサート、部品以外は、絶対に使用しないでください。
	◎パイプなどの補助具を用いて締めすぎるとインサートや工具が破損し脱落、飛散の危険があります。	※パイプ等の補助具は、使用しないでください。 付属のスパナをご使用ください。
	◎工具を高速回転で使用する場合、遠心力で部品、インサートが飛び出すことがあり非常に危険です。取扱いに際しては、安全面に充分ご注意ください。	※推奨切削条件の範囲内でご使用ください。 取扱い説明書、カタログなどをご参照ください。
各種カッタ その他 回転して 使用する工具	◎カッタ類は鋭い切れ刃を持っている為直接手で触れるとけがをすることがあります。	※保護手袋などの保護具を使用してください。
	◎工具は、偏心回転やバランスが悪いと振れ、振動が生じ、破損、飛散によりけがをすることがあります。	※回転速度は、推奨条件の範囲内で使用してください。 ※軸受けなどの摩耗により偏心回転や振れなどが生じないよう定期的に回転部の精度及びバランスの調整を行ってください。
ドリル	◎加工物回転で貫通穴を加工する場合、貫通時に切り残し部が高速で飛び出すことがあります。この円盤は、鋭利なため非常に危険です。	※安全カバーや保護めがね等の保護具を使用してください。 また、チャック部にカバーを取付けるなどの装置を施してください。
	◎極小径ドリルでは、先端が尖っており非常に鋭利になっているものがあります。指先等で直接触れると刺さったり折れて取れなくなることがあります。また、折れると飛散する場合があります。	※取扱いに際しては、安全面に充分ご注意ください。 保護手袋、保護めがね等をご使用ください。
ろう付け工具	◎インサートの脱落、破損等によりけがをする危険があります。	※ご使用前に確実にろう付けされていることを確認してください。 ※高温になるような条件では、使用しないでください。
その他	◎何度もろう付けを繰り返すと使用中にインサートが破損しやすくなり危険です。	※何度もろう付けし直したインサートは、強度が低下していますので使用しないでください。
	◎所定の用途以外の目的で使用することは、機械や工具の破損を招き非常に危険です。	※定められた使用方法を遵守してください。



Precaution for using cutting tools

ITEM	Caution	Counter plan
General Cutting Tools	Direct touch to the sharp cutting edge may cause injury.	When you set up them to the machine or take them out of the case, please wear protective gloves.
	Misuse or mismatch of working conditions may cause tool breakage or dispersion of broken pieces.	1. Please equip safety items, such as safety glasses and protective gloves. 2. Please use them in the area of our recommended cutting condition. (See our catalog or instruction.)
	Excess impact or heavy wear will increase cutting resistance and may cause tool breakage and dispersion of broken pieces.	1. Please equip safety items, such as safety glasses and protective gloves. 2. Please change tools a bit early for its tool life.
	Dispersion of hearted or prolonged chips may cause injury or burn.	1. Please equip safety items, such as safety glasses and protective gloves. 2. When you get rid of chips, please stop machining at first, and equip protective items before doing it.
	During cutting operation, cutting tools get very hot. Direct touch to tools immediately after operation may cause burn.	Please equip safety items, such as safety glasses and protective gloves.
	Sparks, generation of heat or chips in high temperature during operation may cause fire.	1. Please don't operate around "Danger Zone", in which area there is some fear of fire or explosion. 2. When oil-coolant is used, please be sure to be enough system for fire-prevention around there.
	Lack of dynamic balance in high-speed revolution cause vibration and tool-broken.	1. Please equip safety items, such as safety glasses and protective gloves. 2. Please operate test-run before cutting, and confirm that there is no vibration or unusual sound.
	Direct contact to the rough surface on the work may cause injury.	Please don't touch work materials with bear hand.
	The cutting conditions in this catalog shown in the table above are reference cutting conditions, and should be adjusted according to the actual shape to be machined, the machine used, and purpose for machining.	
Indexable Cutting Tools	When inserts or parts are not clamped well, falling off or dispersion may occur and cause injury.	1. Please clean up the insert pocket or fastening parts before setting insert. 2. Please set up the inserts with supplied wrench only, and confirm that the inserts or parts are clamped completely.
	When clamped too tight by supplementary tools like pipe etc, inserts or body may be broken.	Please set up them with supplied wrench only.
	When indexable tools are used in high-speed revolution or parts may burst out of the body due to centrifugal force.	Please use them in the area of our recommended cutting condition. (See our catalog or instruction.)
Milling Cutters and Other Milling Tools	Since milling cutters have sharp edges, direct contact with bare hands may cause injury.	Please equip safety items, such as safety glasses and protective gloves.
	If cutter lacks dynamic balance, tool breakage or dispersion of broken pieces may occur by vibration.	1. Please use them in the area of our recommended cutting condition. (See our catalog or instruction.) 2. Rotating portion and dynamic balancing should be periodically checked to prevent from eccentric rotation or run out due to wear of bearing portion.
Drills	When drilling through hole with turning work, a kind of disk(reminder parts) sometimes flies out from the end of frilling very fast. It's very dangerous since the disc has sharp edge.	Please equip safety items, such as safety glasses, protective gloves and covers at the chucking.
	Some micro drills have sharp edge with the top. Direct touch to tools may cause injury.	Please equip safety items, such as safety glasses and protective gloves.
Brazed Tools	Dispersion of broken inserts by tools breakage or falling off body may cause injury.	1. Please confirm if they are firmly brazed. 2. Please don't use brazed tools in the condition that requires high cutting temperature.
Others	When brazing is carried out again and again, the strength of carbide insert is deteriorated and becomes easy to be broken during cutting.	Carbide tools which is brazed several times should not be used because its strength has deteriorated.
	It is dangerous to use tools except for the fixed application. It may cause damage of tool and machine.	Please use them in the area of our recommended cutting condition. (See our catalog or instruction.)

Plant & Office



Global Network

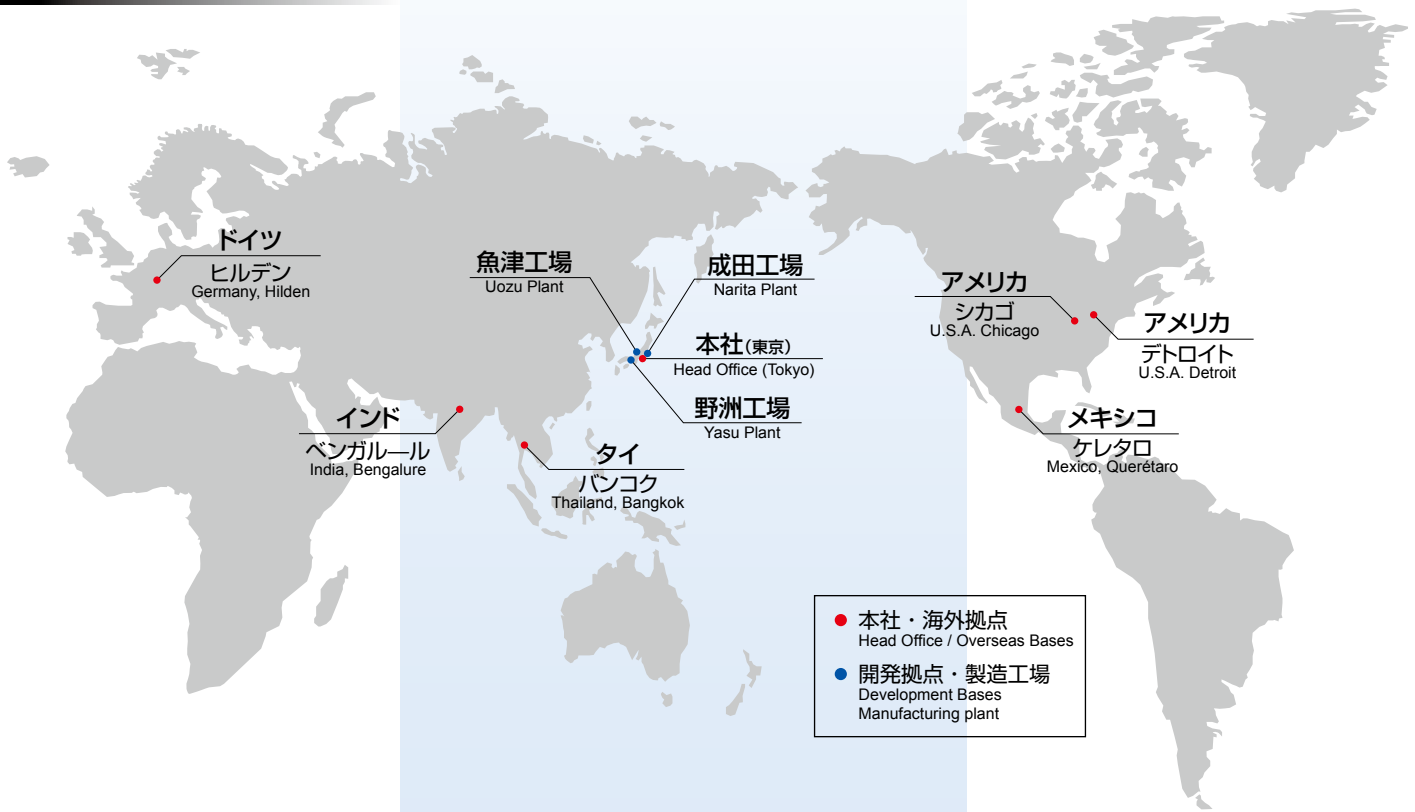

株式会社 MOLDINO

本社	東京都墨田区両国4-31-11 (ヒューリック両国ビル8F) 〒130-0026 ☎03-6890-5101 FAX 03-6890-5134
営業企画部	東京都墨田区両国4-31-11 (ヒューリック両国ビル8F) 〒130-0026 ☎03-6890-5102 FAX 03-6890-5134
海外営業部	東京都墨田区両国4-31-11 (ヒューリック両国ビル8F) 〒130-0026 ☎03-6890-5103 FAX 03-6890-5128
東京営業所	東京都墨田区両国4-31-11 (ヒューリック両国ビル6F) 〒130-0026 ☎03-6890-5110 FAX 03-6890-5133
東北営業所	宮城県仙台市青葉区中央2-10-12 (仙台マルセンビル6F) 〒980-0021 ☎022-208-5100 FAX 022-208-5102
新潟営業所	新潟県長岡市今朝白1-8-18 (長岡DNビル8階) 〒940-0033 ☎0258-87-1224 FAX 0258-87-1158
東関東営業所	茨城県日立市幸町1-22-1 (朝日生命日立ビル7階) 〒317-0073 ☎0294-88-9430 FAX 0294-88-9432
長野営業所	長野県上田市中央西 2-1-20 (花園トーワビル4階 4-A室) 〒386-0023 ☎0268-21-3700 FAX 0268-21-3711
北関東営業所	群馬県太田市飯田町1303-1 (アル・モ・ニービル 4階北) 〒373-0851 ☎0276-59-6001 FAX 0276-59-6005
神奈川営業所	神奈川県厚木市中町4-9-17 (原田センタービル5階) 〒243-0018 ☎046-400-9429 FAX 046-400-9435
静岡営業所	静岡県静岡市葵区御幸町11-10 (第一生命静岡鉄道ビルディング5階) 〒420-0857 ☎054-273-0360 FAX 054-273-0361
名古屋営業所	愛知県名古屋市中区錦3-5-27 (錦中央ビル9F) 〒460-0003 ☎052-687-9150 FAX 052-687-9144
大阪営業所	大阪市淀川区西中島6-1-1 (新大阪プライムタワー16階) 〒532-0011 ☎06-7668-0190 FAX 06-7668-0194
中四営業所	広島県広島市南区京橋町1-23 (大樹生命広島駅前ビル10階) 〒732-0828 ☎082-536-2001 FAX 082-536-2003
九州営業所	福岡市博多区博多駅東2-6-23 (博多駅前第2ビル4F) 〒812-0013 ☎092-289-7010 FAX 092-289-7012
北九州事務所	福岡県京都郡苅田町磯浜町1-9-7 〒800-0313 ☎093-434-2640 FAX 093-434-6846
成田工場	千葉県成田市新泉13-2 (野毛平工業団地) 〒286-0825 ☎0476-36-2111 FAX 0476-36-1440
野洲工場	滋賀県野洲市三上35-2 (三上地区工業団地) 〒520-2323 ☎077-586-5551 FAX 077-586-5521
魚津工場	富山県魚津市川縁258 〒937-0856 ☎0765-22-6010 FAX 0765-22-6011

ヨーロッパ **MOLDINO Tool Engineering Europe GmbH**
Itterpark 12, 40724 Hilden, Germany.
TEL : +49-(0)2103-24820, FAX : +49-(0)2103-248230

アメリカ **MITSUBISHI MATERIALS U.S.A. CORPORATION**
41700 Gardenbrook Road, Suite 120, Novi, MI 48375-1320 U.S.A.
TEL : +1(248) 308-2620, FAX : +1(248) 308-2627

メキシコ **MMC METAL DE MEXICO, S.A. DE C.V.**
Av. La Cañada No.16, Parque Industrial Bernardo Quintana,
El Marques, Querétaro, CP 76246, México
TEL : +52-442-1926800

タイ **MMC Hardmetal(Thailand) Co.,Ltd. MOLDINO Division**
622 Emporium Tower, Floor 22/1-4, Sukhumvit Road, Klong Tan,
Klong Toei, Bangkok 10110, Thailand
TEL : +66-(0)2-661-8175, FAX : +66-(0)2-661-8176

インド **MMC Hardmetal India Pvt Ltd.**
PraPrasad Enclave, #118/119, 1st Floor, 2nd Stage, 5th main,
BBMP Ward #11, (New #38), Industrial Suburb, Yeshwanthpura,
Bengaluru, 560 022, Karnataka, India.
TEL : +91-80-2204-3600

ホームページ

www.moldino.com

フリーダイヤル技術相談

☎0120-134159

工具選定データベース【TOOL SEARCH】

TOOLSEARCH

検索

図、表等のデータは試験結果の一例であり、保証値ではありません。

「MOLDINO」は株式会社MOLDINOの登録商標です。

The diagrams and table data are examples of test results, and are not guaranteed values.

“MOLDINO” is a registered trademark of MOLDINO Tool Engineering, Ltd.

本カタログに掲載の商品は予告なく、改善・改良のために仕様変更することがあります。

Specifications for the products listed in this catalog are subject to change without notice due to replacement or modification.

MOLDINO Tool Engineering, Ltd.

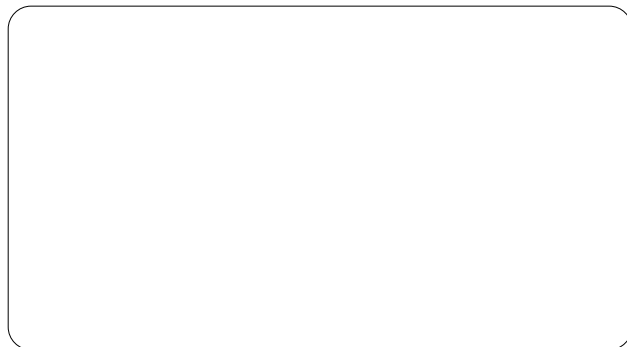

技術相談フリーダイヤル

 **0120-134159**



本カタログはベジタブルインクで印刷しています。
This catalog is printed using vegetable oil ink.

Printed in JAPAN
2023.3(K)MT4